



# Red Hat OpenStack Platform 11

## Networking Guide

An Advanced Guide to OpenStack Networking



# Red Hat OpenStack Platform 11 Networking Guide

---

An Advanced Guide to OpenStack Networking

OpenStack Team  
rhos-docs@redhat.com

## Legal Notice

Copyright © 2018 Red Hat, Inc.

The text of and illustrations in this document are licensed by Red Hat under a Creative Commons Attribution-Share Alike 3.0 Unported license ("CC-BY-SA"). An explanation of CC-BY-SA is available at

<http://creativecommons.org/licenses/by-sa/3.0/>

. In accordance with CC-BY-SA, if you distribute this document or an adaptation of it, you must provide the URL for the original version.

Red Hat, as the licensor of this document, waives the right to enforce, and agrees not to assert, Section 4d of CC-BY-SA to the fullest extent permitted by applicable law.

Red Hat, Red Hat Enterprise Linux, the Shadowman logo, JBoss, OpenShift, Fedora, the Infinity logo, and RHCE are trademarks of Red Hat, Inc., registered in the United States and other countries.

Linux ® is the registered trademark of Linus Torvalds in the United States and other countries.

Java ® is a registered trademark of Oracle and/or its affiliates.

XFS ® is a trademark of Silicon Graphics International Corp. or its subsidiaries in the United States and/or other countries.

MySQL ® is a registered trademark of MySQL AB in the United States, the European Union and other countries.

Node.js ® is an official trademark of Joyent. Red Hat Software Collections is not formally related to or endorsed by the official Joyent Node.js open source or commercial project.

The OpenStack ® Word Mark and OpenStack logo are either registered trademarks/service marks or trademarks/service marks of the OpenStack Foundation, in the United States and other countries and are used with the OpenStack Foundation's permission. We are not affiliated with, endorsed or sponsored by the OpenStack Foundation, or the OpenStack community.

All other trademarks are the property of their respective owners.

## Abstract

A Cookbook for Common OpenStack Networking Tasks.

## Table of Contents

<b>PREFACE</b> .....	<b>7</b>
1. OPENSTACK NETWORKING AND SDN	7
1.1. Topics covered in this book	7
2. THE POLITICS OF VIRTUAL NETWORKS	7
<b>CHAPTER 1. NETWORKING OVERVIEW</b> .....	<b>9</b>
1.1. How Networking Works	9
1.1.1. VLANs	9
1.2. Connecting two LANs together	9
1.2.1. Firewalls	10
1.3. OpenStack Networking (neutron)	10
1.4. Using CIDR format	10
<b>CHAPTER 2. OPENSTACK NETWORKING CONCEPTS</b> .....	<b>12</b>
2.1. Installing OpenStack Networking (neutron)	12
2.1.1. Supported installation	12
2.2. OpenStack Networking diagram	12
2.3. Security Groups	13
2.4. Open vSwitch	13
2.5. Modular Layer 2 (ML2)	14
2.5.1. The reasoning behind ML2	14
2.5.2. ML2 network types	14
2.5.3. ML2 Mechanism Drivers	14
2.6. L2 Population	15
2.7. OpenStack Networking Services	16
2.7.1. L3 Agent	16
2.7.2. DHCP Agent	16
2.7.3. Open vSwitch Agent	16
2.8. Tenant and Provider networks	16
2.8.1. Tenant networks	17
2.8.2. Provider networks	17
2.8.2.1. Flat provider networks	17
2.8.2.2. Configure controller nodes	18
2.8.2.3. Configure the Network and Compute nodes	18
2.8.2.4. Configure the network node	19
2.9. Layer 2 and layer 3 networking	19
2.9.1. Use switching where possible	20
<b>PART I. COMMON TASKS</b> .....	<b>22</b>
<b>CHAPTER 3. COMMON ADMINISTRATIVE TASKS</b> .....	<b>23</b>
3.1. Create a network	23
3.2. Create an advanced network	25
3.3. Add network routing	25
3.4. Delete a network	26
3.5. Purge a tenant's networking	26
3.6. Create a subnet	27
3.6.1. Create a new subnet	27
3.7. Delete a subnet	29
3.8. Add a router	29
3.9. Delete a router	29
3.10. Add an interface	29

3.11. Delete an interface	30
3.12. Configure IP addressing	30
3.12.1. Create floating IP pools	30
3.12.2. Assign a specific floating IP	31
3.12.3. Assign a random floating IP	31
3.13. Create multiple floating IP pools	32
3.14. Bridge the physical network	32
<b>CHAPTER 4. PLANNING IP ADDRESS USAGE</b>	<b>33</b>
4.1. Using multiple VLANs	33
4.2. Isolating VLAN traffic	33
4.3. IP address consumption	35
4.4. Virtual Networking	35
4.5. Example network plan	35
<b>CHAPTER 5. REVIEW OPENSTACK NETWORKING ROUTER PORTS</b>	<b>37</b>
5.1. View current port status	37
<b>CHAPTER 6. TROUBLESHOOT PROVIDER NETWORKS</b>	<b>39</b>
6.1. Topics covered	39
6.2. Basic ping testing	39
6.3. Troubleshooting VLAN networks	41
6.3.1. Review the VLAN configuration and log files	41
6.4. Troubleshooting from within tenant networks	42
6.4.1. Perform advanced ICMP testing within the namespace	43
<b>CHAPTER 7. CONNECT AN INSTANCE TO THE PHYSICAL NETWORK</b>	<b>45</b>
7.1. Using Flat Provider Networks	45
7.1.1. The flow of outgoing traffic	48
7.1.2. The flow of incoming traffic	50
7.1.3. Troubleshooting	51
7.2. Using VLAN provider networks	53
7.2.1. The flow of outgoing traffic	55
7.2.2. The flow of incoming traffic	58
7.2.3. Troubleshooting	59
7.3. Enable Compute metadata access	60
7.4. Floating IP addresses	60
<b>CHAPTER 8. CONFIGURE PHYSICAL SWITCHES FOR OPENSTACK NETWORKING</b>	<b>61</b>
8.1. Planning your physical network environment	61
8.2. Configure a Cisco Catalyst switch	62
8.2.1. Configure trunk ports	62
8.2.1.1. Configure trunk ports for a Cisco Catalyst switch	62
8.2.2. Configure access ports	63
8.2.2.1. Configure access ports for a Cisco Catalyst switch	63
8.2.3. Configure LACP port aggregation	64
8.2.3.1. Configure LACP on the physical NIC	64
8.2.3.2. Configure LACP on a Cisco Catalyst switch	65
8.2.4. Configure MTU settings	66
8.2.4.1. Configure MTU settings on a Cisco Catalyst switch	66
8.2.5. Configure LLDP discovery	67
8.2.5.1. Configure LLDP on a Cisco Catalyst switch	67
8.3. Configure a Cisco Nexus switch	67
8.3.1. Configure trunk ports	67

8.3.1.1. Configure trunk ports for a Cisco Nexus switch	68
8.3.2. Configure access ports	68
8.3.2.1. Configure access ports for a Cisco Nexus switch	68
8.3.3. Configure LACP port aggregation	68
8.3.3.1. Configure LACP on the physical NIC	69
8.3.3.2. Configure LACP on a Cisco Nexus switch	69
8.3.4. Configure MTU settings	70
8.3.4.1. Configure MTU settings on a Cisco Nexus 7000 switch	70
8.3.5. Configure LLDP discovery	70
8.3.5.1. Configure LLDP on a Cisco Nexus 7000 switch	70
8.4. Configure a Cumulus Linux switch	70
8.4.1. Configure trunk ports	70
8.4.1.1. Configure trunk ports for a Cumulus Linux switch	71
8.4.2. Configure access ports	71
8.4.2.1. Configuring access ports for a Cumulus Linux switch	71
8.4.3. Configure LACP port aggregation	72
8.4.3.1. Configure LACP on the physical NIC	72
8.4.3.2. Configure LACP on a Cumulus Linux switch	72
8.4.4. Configure MTU settings	72
8.4.4.1. Configure MTU settings on a Cumulus Linux switch	72
8.4.5. Configure LLDP discovery	73
8.5. Configure an Extreme Networks EXOS switch	73
8.5.1. Configure trunk ports	73
8.5.1.1. Configure trunk ports on an Extreme Networks EXOS switch	73
8.5.2. Configure access ports	73
8.5.2.1. Configure access ports for an Extreme Networks EXOS switch	73
8.5.3. Configure LACP port aggregation	74
8.5.3.1. Configure LACP on the physical NIC	74
8.5.3.2. Configure LACP on an Extreme Networks EXOS switch	75
8.5.4. Configure MTU settings	75
8.5.4.1. Configure MTU settings on an Extreme Networks EXOS switch	75
8.5.5. Configure LLDP discovery	75
8.5.5.1. Configure LLDP settings on an Extreme Networks EXOS switch	75
8.6. Configure a Juniper EX Series switch	76
8.6.1. Configure trunk ports	76
8.6.1.1. Configure trunk ports on the Juniper EX Series switch	76
8.6.2. Configure access ports	76
8.6.2.1. Configure access ports for a Juniper EX Series switch	76
8.6.3. Configure LACP port aggregation	77
8.6.3.1. Configure LACP on the physical NIC	77
8.6.3.2. Configure LACP on a Juniper EX Series switch	78
8.6.4. Configure MTU settings	79
8.6.4.1. Configure MTU settings on a Juniper EX Series switch	79
8.6.5. Configure LLDP discovery	80
8.6.5.1. Configure LLDP on a Juniper EX Series switch	80
<b>PART II. ADVANCED CONFIGURATION</b>	<b>81</b>
<b>CHAPTER 9. CONFIGURE MTU SETTINGS</b>	<b>82</b>
9.1. MTU overview	82
9.1.1. Configure MTU advertisement	83
9.1.2. Configure tenant networks	83
9.1.3. Configure MTU Settings in Director	83

9.1.4. Review the resulting MTU calculation	84
<b>CHAPTER 10. CONFIGURE QUALITY-OF-SERVICE (QOS)</b>	<b>85</b>
10.1. QoS Policy Scope	85
10.2. QoS Policy Management	85
10.3. DSCP Marking for Egress Traffic	86
10.4. RBAC for QoS Policies	87
<b>CHAPTER 11. CONFIGURE BRIDGE MAPPINGS</b>	<b>88</b>
11.1. What are bridge mappings used for?	88
11.1.1. Configure bridge mappings	88
11.1.2. Configure the controller node	88
11.1.3. Traffic flow	88
11.2. Maintaining Bridge Mappings	89
11.2.1. Manual port cleanup	89
11.2.2. Automated port cleanup using 'neutron-ovs-cleanup'	89
11.2.2.1. Example usage of neutron-ovs-cleanup:	90
<b>CHAPTER 12. VLAN-AWARE INSTANCES</b>	<b>91</b>
12.1. Overview	91
12.2. Review the Trunk Plugin	91
12.3. Create a Trunk Connection	91
12.4. Add Subports to the Trunk	93
12.5. Configure an Instance to use a Trunk	95
12.6. Trunk States	98
<b>CHAPTER 13. CONFIGURE RBAC</b>	<b>99</b>
13.1. Create a new RBAC policy	99
13.2. Review your configured RBAC policies	100
13.3. Delete a RBAC policy	100
13.4. RBAC for external networks	101
<b>CHAPTER 14. CONFIGURE DISTRIBUTED VIRTUAL ROUTING (DVR)</b>	<b>102</b>
14.1. Overview of Layer 3 Routing	102
14.1.1. Routing Flows	102
14.1.2. Centralized Routing	102
14.2. DVR Overview	103
14.3. Known Issues and Caveats	103
14.4. Supported Routing Architectures	104
14.5. Deploying DVR	104
14.6. Migrate Centralized Routers to Distributed Routing	105
<b>CHAPTER 15. CONFIGURE LOAD BALANCING-AS-A-SERVICE (LBaaS)</b>	<b>107</b>
15.1. OpenStack Networking and LBaaS Topology	108
15.1.1. Support Status of LBaaS	108
15.1.2. Service Placement	108
15.2. Configure LBaaS	109
15.3. Automatically Reschedule Load Balancers	110
15.3.1. Enable Automatic Failover	111
15.3.2. Sample Failover Configuration	111
<b>CHAPTER 16. TENANT NETWORKING WITH IPV6</b>	<b>116</b>
16.1. IPv6 subnet options	116
16.1.1. Create an IPv6 subnet using Stateful DHCPv6	117



---

<b>CHAPTER 17. MANAGE TENANT QUOTAS</b> .....	<b>120</b>
17.1. L3 quota options	120
17.2. Firewall quota options	120
17.3. Security group quota options	120
17.4. Management quota options	120
<b>CHAPTER 18. CONFIGURE FIREWALL-AS-A-SERVICE (FWaaS)</b> .....	<b>121</b>
18.1. Enable FWaaS	121
18.2. Configure FWaaS	122
18.3. Create a firewall	122
<b>CHAPTER 19. CONFIGURE ALLOWED-ADDRESS-PAIRS</b> .....	<b>123</b>
19.1. Basic allowed-address-pairs operations	123
19.2. Adding allowed-address-pairs	123
<b>CHAPTER 20. CONFIGURE LAYER 3 HIGH AVAILABILITY</b> .....	<b>124</b>
20.1. OpenStack Networking without HA	124
20.2. Overview of Layer 3 High Availability	124
20.2.1. Failover conditions	124
20.3. Tenant considerations	125
20.4. Background changes	125
20.4.1. Changes to neutron-server	125
20.4.2. Changes to L3 agent	125
20.5. Configuration Steps	125
20.5.1. Configure the OpenStack Networking node	125
20.5.2. Review your configuration	126
<b>CHAPTER 21. USE TAGGING FOR VIRTUAL DEVICE IDENTIFICATION</b> .....	<b>127</b>
<b>CHAPTER 22. SR-IOV SUPPORT FOR VIRTUAL NETWORKING</b> .....	<b>128</b>
22.1. Configure SR-IOV in your Red Hat OpenStack Platform deployment	128
22.2. Create Virtual Functions on the Compute node	128
22.3. Configure SR-IOV on the Network Node	132
22.4. Configure SR-IOV on the Controller Node	133
22.5. Configure SR-IOV in Compute	133
22.6. Enable the OpenStack Networking SR-IOV agent	134
22.7. Configure an instance to use the SR-IOV port	134
22.8. Review the allow_unsafe_interrupts setting	137
22.9. Add a Physical Function to an Instance	137
22.9.1. Configure Compute for Physical Functions	137
22.9.2. Configure Physical Functions	137
22.9.3. Expose SR-IOV physical functions VLAN Tags to Guests	138
22.10. Additional considerations	138



# PREFACE

OpenStack Networking (codename *neutron*) is the software-defined networking component of Red Hat OpenStack Platform 11.

## 1. OPENSTACK NETWORKING AND SDN

Software-defined networking (SDN) is an approach to computer networking that allows network administrators to manage network services through abstraction of lower-level functionality. While server workloads have been migrated into virtual environments, they're still just servers looking for a network connection to let them send and receive data. SDN meets this need by moving networking equipment (such as routers and switches) into the same virtualized space. If you're already familiar with basic networking concepts, then it's not much of a leap to consider that they've now been virtualized just like the servers they're connecting.

This book intends to give administrators an understanding of basic administration and troubleshooting tasks in Part 1, and explores the advanced capabilities of OpenStack Networking in a cookbook style in Part 2. If you're already comfortable with general networking concepts, then the content of this book should be accessible to you (someone less familiar with networking might benefit from the general networking overview in Part 1).

### 1.1. Topics covered in this book

- **Preface** - Describes the political landscape of SDN in large organizations, and offers a short introduction to general networking concepts.
- **Part 1** - Covers common administrative tasks and basic troubleshooting steps:
  - Adding and removing network resources
  - Basic network troubleshooting
  - Tenant network troubleshooting
- **Part 2** - Contains cookbook-style scenarios for advanced OpenStack Networking features, including:
  - Configure Layer 3 High Availability for virtual routers
  - Configure SR-IOV, and DVR, and other Neutron features

## 2. THE POLITICS OF VIRTUAL NETWORKS

Software-defined networking (SDN) allows engineers to deploy virtual routers and switches in their virtualization environment, be it OpenStack or RHEV-based. SDN also shifts the business of moving data packets between computers into an unfamiliar space. These routers and switches were previously physical devices with all kinds of cabling running through them, but with SDN they can be deployed and operational just by clicking a few buttons.

In many large virtualization environments, the adoption of software-defined networking (SDN) can result in political tensions within the organisation. Virtualization engineers who may not be familiar with advanced networking concepts are expected to suddenly manage the virtual routers and switches of their cloud deployment, and need to think sensibly about IP address allocation, VLAN isolation, and subnetting. And while this is going on, the network engineers are watching this other team discuss technologies that used to be their exclusive domain, resulting in agitation and perhaps job security

concerns. This demarcation can also greatly complicate troubleshooting: When systems are down and can't connect to each other, are the virtualization engineers expected to handover the troubleshooting efforts to the network engineers the moment they see the packets reaching the physical switch?

This tension can be more easily mitigated if you think of your virtual network as an extension of your physical network. All of the same concepts of default gateways, routers, and subnets still apply, and it all still runs using TCP/IP.

However you choose to manage this politically, there are also technical measures available to address this. For example, Cisco's Nexus product enables OpenStack operators to deploy a virtual router that runs the familiar Cisco NX-OS. This allows network engineers to login and manage network ports the way they already do with their existing physical Cisco networking equipment. Alternatively, if the network engineers are not going to manage the virtual network, it would still be sensible to involve them from the very beginning. Physical networking infrastructure will still be required for the OpenStack nodes, IP addresses will still need to be allocated, VLANs will need to be trunked, and switch ports will need to be configured to trunk the VLANs. Aside from troubleshooting, there are times when extensive co-operation will be expected from both teams. For example, when adjusting the MTU size for a VM, this will need to be done from end-to-end, including all virtual and physical switches and routers, requiring a carefully choreographed change between both teams.

Network engineers remain a critical part of your virtualization deployment, even more so after the introduction of SDN. The additional complexity will certainly need to draw on their skills, especially when things go wrong and their sage wisdom is needed.

# CHAPTER 1. NETWORKING OVERVIEW

## 1.1. How Networking Works

The term *Networking* refers to the act of moving information from one computer to another. At the most basic level, this is performed by running a cable between two machines, each with network interface cards (NICs) installed.

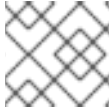

### NOTE

If you've ever studied the OSI networking model, this would be layer 1.

Now, if you want more than two computers to get involved in the conversation, you would need to scale out this configuration by adding a device called a switch. Enterprise switches resemble pizza boxes with multiple Ethernet ports for you to plug in additional machines. By the time you've done all this, you have on your hands something that's called a Local Area Network (LAN).

Switches move us up the OSI model to layer two, and apply a bit more intelligence than the lower layer 1: Each NIC has a unique MAC address number assigned to the hardware, and it's this number that lets machines plugged into the same switch find each other. The switch maintains a list of which MAC addresses are plugged into which ports, so that when one computer attempts to send data to another, the switch will know where they're both situated, and will adjust entries in the CAM (Content Addressable Memory), which keeps track of MAC-address-to-port mappings.

### 1.1.1. VLANs

VLANs allow you to segment network traffic for computers running on the same switch. In other words, you can logically carve up your switch by configuring the ports to be members of different networks – they are basically mini-LANs that allow you to separate traffic for security reasons. For example, if your switch has 24 ports in total, you can say that ports 1-6 belong to **VLAN200**, and ports 7-18 belong to **VLAN201**. As a result, computers plugged into **VLAN200** are completely separate from those on **VLAN201**; they can no longer communicate directly, and if they wanted to, the traffic would have to pass through a router as if they were two separate physical switches (which would be a useful way to think of them). This is where firewalls can also be useful for governing which VLANs can communicate with each other.

## 1.2. Connecting two LANs together

Imagine that you have two LANs running on two separate switches, and now you'd like them to share information with each other. You have two options for configuring this:

- **First option:** Use 802.1Q VLAN tagging to configure a single VLAN that spans across both physical switches. For this to work, you take a network cable and plug one end into a port on each switch, then you configure these ports as 802.1Q tagged ports (sometimes known as *trunk* ports). Basically you've now configured these two switches to act as one big logical switch, and the connected computers can now successfully find each other. The downside to this option is scalability, you can only daisy-chain so many switches until overhead becomes an issue.
- **Second option:** Buy a device called a router and plug in cables from each switch. As a result, the router will be aware of the networks configured on both switches. Each end plugged into the switch will be assigned an IP address, known as the default gateway for that network. The "default" in default gateway defines the destination where traffic will be sent if it is clear that the destined machine is not on the same LAN as you. By setting this default gateway on each of

your computers, they don't need to be aware of all the other computers on the other networks in order to send traffic to them. Now they just send it on to the default gateway and let the router handle it from there. And since the router is aware of which networks reside on which interface, it should have no trouble sending the packets on to their intended destinations. Routing works at layer 3 of the OSI model, and is where the familiar concepts like IP addresses and subnets do their work.



## NOTE

This concept is how the internet itself works. Lots of separate networks run by different organizations are all interconnected using switches and routers. Keep following the right default gateways and your traffic will eventually get to where it needs to be.

### 1.2.1. Firewalls

Firewalls can filter traffic across multiple OSI layers, including layer 7 (for inspecting actual content). They are often situated in the same network segments as routers, where they govern the traffic moving between all the networks. Firewalls refer to a pre-defined set of rules that prescribe which traffic may or may not enter a network. These rules can become very granular, for example:

"Servers on **VLAN200** may only communicate with computers on **VLAN201**, and only on a Thursday afternoon, and only if they are sending encrypted web traffic (HTTPS) in one direction".

To help enforce these rules, some firewalls also perform Deep Packet Inspection (DPI) at layers 5-7, whereby they examine the contents of packets to ensure they actually are whatever they claim to be. Hackers are known to exfiltrate data by having the traffic masquerade as something it's not, so DPI is one of the means that can help mitigate that threat.

### 1.3. OpenStack Networking (neutron)

These same networking concepts apply in OpenStack, where they are known as Software-Defined Networking (SDN). The OpenStack Networking (neutron) component provides the API for virtual networking capabilities, and includes switches, routers, and firewalls. The virtual network infrastructure allows your instances to communicate with each other and also externally using the physical network. The Open vSwitch bridge allocates virtual ports to instances, and can span across to the physical network for incoming and outgoing traffic.

### 1.4. Using CIDR format

IP addresses are generally first allocated in blocks of subnets. For example, the IP address range **192.168.100.0 - 192.168.100.255** with a subnet mask of **255.255.255.0** allows for **254** IP addresses (the first and last addresses are reserved).

These subnets can be represented in a number of ways:

- Common usage: Subnet addresses are traditionally displayed using the network address accompanied by the subnet mask. For example:
  - Network Address: *192.168.100.0*
  - Subnet mask: *255.255.255.0*
- Using CIDR format: This format shortens the subnet mask into its total number of active bits. For example, in **192.168.100.0/24** the **/24** is a shortened representation of **255.255.255.0**, and is a total of the number of flipped bits when converted to binary. For

example, CIDR format can be used in `ifcfg-xxx` scripts instead of the **NETMASK** value:

```
#NETMASK=255.255.255.0  
PREFIX=24
```

## CHAPTER 2. OPENSTACK NETWORKING CONCEPTS

OpenStack Networking has system services to manage core services such as routing, DHCP, and metadata. Together, these services are included in the concept of the controller node, which is a conceptual role assigned to a physical server. A physical server is typically assigned the role of *Network node*, keeping it dedicated to the task of managing Layer 3 routing for network traffic to and from instances. In OpenStack Networking, you can have multiple physical hosts performing this role, allowing for redundant service in the event of hardware failure. For more information, see the chapter on *Layer 3 High Availability*.



### NOTE

Red Hat OpenStack Platform 11 added support for composable roles, allowing you to separate network services into a custom role. However, for simplicity, this guide assumes that a deployment uses the default controller role.

## 2.1. Installing OpenStack Networking (neutron)

### 2.1.1. Supported installation

The OpenStack Networking component is installed as part of a Red Hat OpenStack Platform director deployment. Refer to the [Director Installation and Usage](#) guide for more information.

## 2.2. OpenStack Networking diagram

This diagram depicts a sample OpenStack Networking deployment, with a dedicated OpenStack Networking node performing L3 routing and DHCP, and running the advanced services *FWaaS* and *LBaaS*. Two Compute nodes run the Open vSwitch ( *openvswitch-agent* ) and have two physical network cards each, one for tenant traffic, and another for management connectivity. The OpenStack Networking node has a third network card specifically for provider traffic:



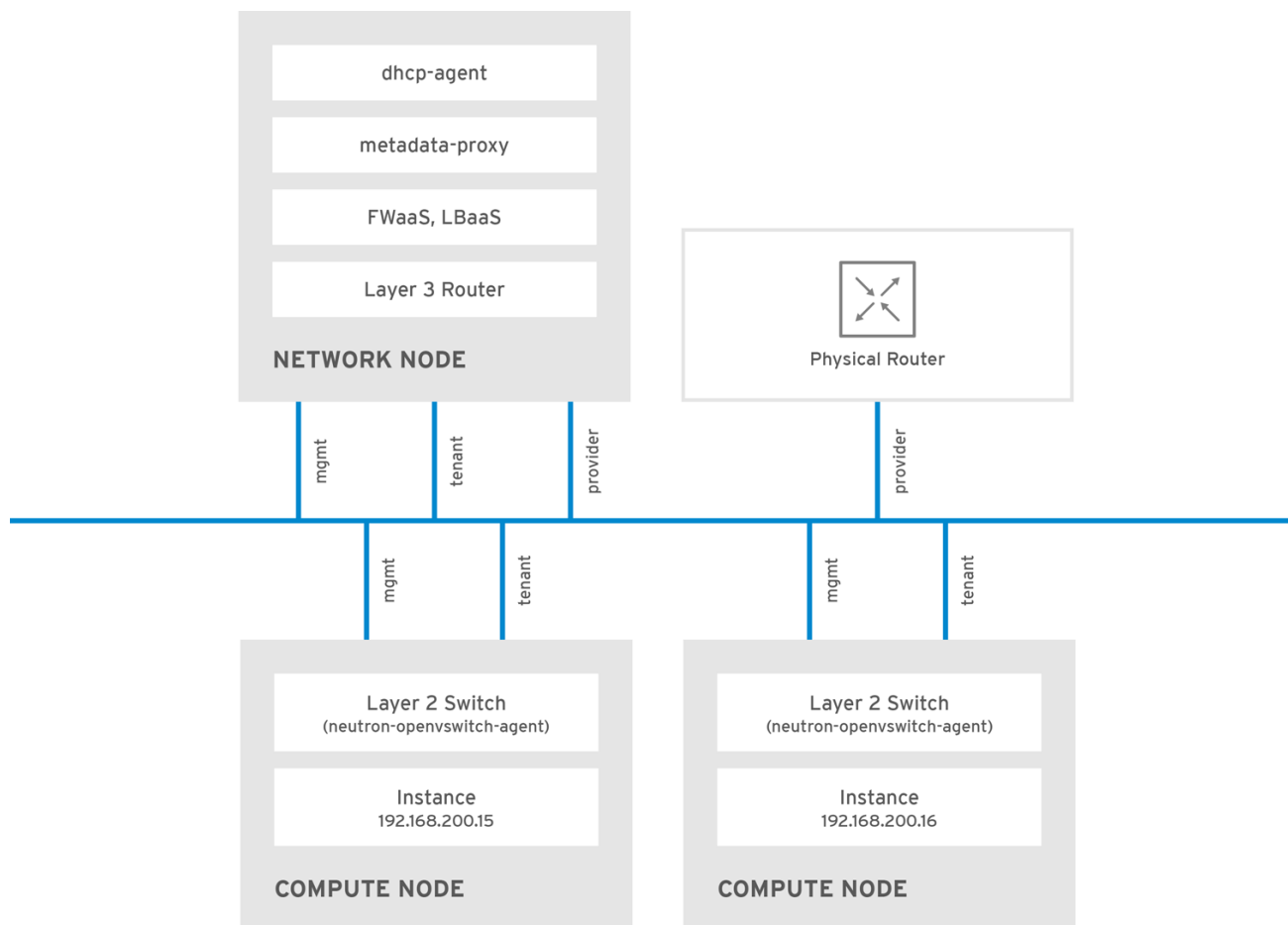

OPENSTACK\_450456\_0617

## 2.3. Security Groups

Security groups and rules filter the type and direction of network traffic sent to (and received from) a given neutron port. This provides an additional layer of security to complement any firewall rules present on the Compute instance. The security group is a container object with one or more security rules. A single security group can manage traffic to multiple compute instances. Ports created for floating IP addresses, OpenStack Networking LBaaS VIPs, and instances are associated with a security group. If none is specified, then the port is associated with the default security group. By default, this group will drop all inbound traffic and allow all outbound traffic. Additional security rules can be added to the default security group to modify its behavior or new security groups can be created as necessary.

## 2.4. Open vSwitch

Open vSwitch (OVS) is a software-defined networking (SDN) virtual switch similar to the Linux software bridge. OVS provides switching services to virtualized networks with support for industry standard *NetFlow*, *OpenFlow*, and *sFlow*. Open vSwitch is also able to integrate with physical switches using layer 2 features, such as *STP*, *LACP*, and *802.1Q VLAN tagging*. Tunneling with VXLAN and GRE is supported with Open vSwitch version *1.11.0-1.el6* or later.



### NOTE

Do not use LACP with OVS-based bonds, as this configuration is problematic and unsupported. Instead, consider using `bond_mode=balance-slb` as a replacement for this functionality. In addition, you can still use LACP with Linux bonding. For the technical details behind this requirement, see [BZ#1267291](#).

**NOTE**

To mitigate the risk of network loops in Open vSwitch, only a single interface or a single bond may be a member of a given bridge. If you require multiple bonds or interfaces, you can configure multiple bridges.

## 2.5. Modular Layer 2 (ML2)

ML2 is the OpenStack Networking core plug-in introduced in OpenStack's Havana release. Superseding the previous model of monolithic plug-ins, ML2's modular design enables the concurrent operation of mixed network technologies. The monolithic Open vSwitch and Linux Bridge plug-ins have been deprecated and removed; their functionality has instead been reimplemented as ML2 mechanism drivers.

**NOTE**

ML2 is the default OpenStack Networking plug-in, with Open vSwitch configured as the default mechanism driver.

### 2.5.1. The reasoning behind ML2

Previously, OpenStack Networking deployments were only able to use the plug-in that had been selected at implementation time. For example, a deployment running the Open vSwitch plug-in was only able to use Open vSwitch exclusively; it wasn't possible to simultaneously run another plug-in such as linuxbridge. This was found to be a limitation in environments with heterogeneous requirements.

### 2.5.2. ML2 network types

Multiple network segment types can be operated concurrently. In addition, these network segments can interconnect using ML2's support for multi-segmented networks. Ports are automatically bound to the segment with connectivity; it is not necessary to bind them to a specific segment. Depending on the mechanism driver, ML2 supports the following network segment types:

- flat
- GRE
- local
- VLAN
- VXLAN

The various *Type* drivers are enabled in the ML2 section of the `ml2_conf.ini` file:

```
[ml2]
type_drivers = local,flat,vlan,gre,vxlan
```

### 2.5.3. ML2 Mechanism Drivers

Plug-ins have been reimplemented as mechanisms with a common code base. This approach enables code reuse and eliminates much of the complexity around code maintenance and testing.

**NOTE**

Refer to the [Release Notes](#) for the list of supported mechanism drivers.

The various mechanism drivers are enabled in the ML2 section of the `ml2_conf.ini` file. For example:

```
[ml2]
mechanism_drivers = openvswitch,linuxbridge,l2population
```

**NOTE**

If your deployment uses Red Hat OpenStack Platform director, then these settings are managed by director and should not be changed manually.

**NOTE**

Neutron's Linux Bridge ML2 driver and agent are being deprecated with Red Hat OpenStack Platform 11. The Open vSwitch (OVS) plugin is the one deployed by default by the OpenStack Platform director, and is recommended by Red Hat for general usage.

## 2.6. L2 Population

The L2 Population driver enables broadcast, multicast, and unicast traffic to scale out on large overlay networks. By default, Open vSwitch GRE and VXLAN replicate broadcasts to every agent, including those that do not host the destination network. This design requires the acceptance of significant network and processing overhead. The alternative design introduced by the L2 Population driver implements a partial mesh for ARP resolution and MAC learning traffic; it also creates tunnels for a particular network only between the nodes that host the network. This traffic is sent only to the necessary agent by encapsulating it as a targeted unicast.

1. Enable the L2 population driver by adding it to the list of mechanism drivers. You also need to have at least one tunneling driver enabled; either GRE, VXLAN, or both. Add the appropriate configuration options to the `ml2_conf.ini` file:

```
[ml2]
type_drivers = local,flat,vlan,gre,vxlan
mechanism_drivers = openvswitch,linuxbridge,l2population
```

**NOTE**

Neutron's Linux Bridge ML2 driver and agent are being deprecated with Red Hat OpenStack Platform 11. The Open vSwitch (OVS) plugin is the one deployed by default by the OpenStack Platform director, and is recommended by Red Hat for general usage.

2. Enable L2 population in the `openvswitch_agent.ini` file. This must be enabled on each node running the L2 agent:

```
[agent]
l2_population = True
```

**NOTE**

To install ARP reply flows, you will need to configure the `arp_responder` flag. For example:

```
[agent]
l2_population = True
arp_responder = True
```

## 2.7. OpenStack Networking Services

By default, Red Hat OpenStack Platform includes components that integrate with the ML2 and Open vSwitch plugin to provide networking functionality in your deployment:

### 2.7.1. L3 Agent

The L3 agent is part of the *openstack-neutron* package. Network namespaces are used to provide each project with its own isolated layer 3 routers, which direct traffic and provide gateway services for the layer 2 networks; the L3 agent assists with managing these routers. The nodes on which the L3 agent is to be hosted must not have a manually-configured IP address on a network interface that is connected to an external network. Instead there must be a range of IP addresses from the external network that are available for use by OpenStack Networking. These IP addresses will be assigned to the routers that provide the link between the internal and external networks. The range selected must be large enough to provide a unique IP address for each router in the deployment as well as each desired floating IP.

### 2.7.2. DHCP Agent

The OpenStack Networking DHCP agent manages the network namespaces that are spawned for each project subnet to act as DHCP server. Each namespace is running a `dnsmasq` process that is capable of allocating IP addresses to virtual machines running on the network. If the agent is enabled and running when a subnet is created then by default that subnet has DHCP enabled.

### 2.7.3. Open vSwitch Agent

The Open vSwitch (OVS) neutron plug-in uses its own agent, which runs on each node and manages the OVS bridges. The ML2 plugin integrates with a dedicated agent to manage L2 networks. By default, Red Hat OpenStack Platform uses *ovs-agent*, which builds overlay networks using OVS bridges.

## 2.8. Tenant and Provider networks

The following diagram presents an overview of the tenant and provider network types, and illustrates how they interact within the overall OpenStack Networking topology:

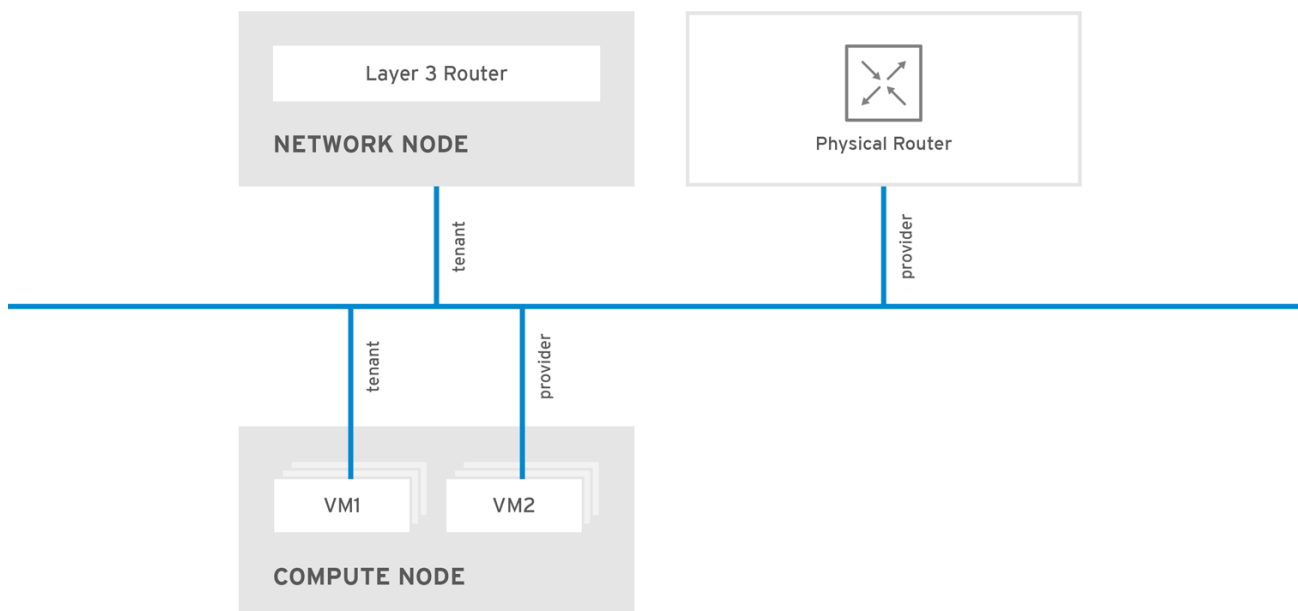

OPENSTACK\_450456\_0617

## 2.8.1. Tenant networks

Tenant networks are created by users for connectivity within projects. They are fully isolated by default and are not shared with other projects. OpenStack Networking supports a range of tenant network types:

- **Flat** - All instances reside on the same network, which can also be shared with the hosts. No VLAN tagging or other network segregation takes place.
- **VLAN** - OpenStack Networking allows users to create multiple provider or tenant networks using VLAN IDs (802.1Q tagged) that correspond to VLANs present in the physical network. This allows instances to communicate with each other across the environment. They can also communicate with dedicated servers, firewalls, load balancers and other network infrastructure on the same layer 2 VLAN.
- **VXLAN and GRE tunnels** - VXLAN and GRE use network overlays to support private communication between instances. An OpenStack Networking router is required to enable traffic to traverse outside of the GRE or VXLAN tenant network. A router is also required to connect directly-connected tenant networks with external networks, including the Internet; the router provides the ability to connect to instances directly from an external network using floating IP addresses.



### NOTE

You can configure QoS policies for tenant networks. For more information, see [Chapter 10, Configure Quality-of-Service \(QoS\)](#).

## 2.8.2. Provider networks

Provider networks are created by the OpenStack administrator and map directly to an existing physical network in the data center. Useful network types in this category are flat (untagged) and VLAN (802.1Q tagged). It is possible to allow provider networks to be shared among tenants as part of the network creation process.

### 2.8.2.1. Flat provider networks

You can use flat provider networks to connect instances directly to the external network. This is useful if you have multiple physical networks (for example, *physnet1* and *physnet2*) and separate physical interfaces (*eth0* → *physnet1* and *eth1* → *physnet2*), and intend to connect each Compute and Network node to those external networks. If you would like to use multiple vlan-tagged interfaces on a single interface to connect to multiple provider networks, please refer to [Section 7.2, “Using VLAN provider networks”](#).

### 2.8.2.2. Configure controller nodes

1. Edit `/etc/neutron/plugin.ini` (symbolic link to `/etc/neutron/plugins/ml2/ml2_conf.ini`) and add `flat` to the existing list of values, and set `flat_networks` to `*`. For example:

```
type_drivers = vxlan, flat
flat_networks =*
```

2. Create an external network as a flat network and associate it with the configured `physical_network`. Configuring it as a shared network (using `--shared`) will let other users create instances directly connected to it.

```
neutron net-create public01 --provider:network_type flat --
provider:physical_network physnet1 --router:external=True --shared
```

3. Create a subnet using `neutron subnet-create`, or the dashboard. For example:

```
# neutron subnet-create --name public_subnet --enable_dhcp=False --
allocation_pool start=192.168.100.20,end=192.168.100.100 --
gateway=192.168.100.1 public01 192.168.100.0/24
```

4. Restart the `neutron-server` service to apply the change:

```
systemctl restart neutron-server
```

### 2.8.2.3. Configure the Network and Compute nodes

Perform these steps on the network node and compute nodes. This will connect the nodes to the external network, and allow instances to communicate directly with the external network.

1. Create an external network bridge (`br-ex`) and add an associated port (`eth1`) to it:

Create the external bridge in `/etc/sysconfig/network-scripts/ifcfg-br-ex`:

```
DEVICE=br-ex
TYPE=OVSBridge
DEVICETYPE=ovs
ONBOOT=yes
NM_CONTROLLED=no
BOOTPROTO=none
```

In `/etc/sysconfig/network-scripts/ifcfg-eth1`, configure `eth1` to connect to `br-ex`:

```
DEVICE=eth1
TYPE=OVSPort
DEVICETYPE=ovs
```

```
OVS_BRIDGE=br-ex
ONBOOT=yes
NM_CONTROLLED=no
BOOTPROTO=none
```

Reboot the node or restart the network service for the changes to take effect.

2. Configure physical networks in `/etc/neutron/plugins/ml2/openvswitch_agent.ini` and map bridges to the physical network:

```
bridge_mappings = physnet1:br-ex
```



#### NOTE

For more information on bridge mappings, see [Chapter 11, Configure Bridge Mappings](#).

3. Restart the `neutron-openvswitch-agent` service on both the network and compute nodes for the changes to take effect:

```
systemctl restart neutron-openvswitch-agent
```

#### 2.8.2.4. Configure the network node

1. Set `external_network_bridge` = to an empty value in `/etc/neutron/l3_agent.ini`:

Previously, OpenStack Networking used `external_network_bridge` when only a single bridge was used for connecting to an external network. This value may now be set to a blank string, which allows multiple external network bridges. OpenStack Networking will then create a patch from each bridge to `br-int`.

```
# Name of bridge used for external network traffic. This should be set to
# empty value for the linux bridge
external_network_bridge =
```

2. Restart `neutron-l3-agent` for the changes to take effect.

```
systemctl restart neutron-l3-agent
```



#### NOTE

If there are multiple flat provider networks, then each of them should have a separate physical interface and bridge to connect them to the external network. You will need to configure the `ifcfg-*` scripts appropriately and use a comma-separated list for each network when specifying the mappings in the `bridge_mappings` option. For more information on bridge mappings, see [Chapter 11, Configure Bridge Mappings](#).

## 2.9. Layer 2 and layer 3 networking

When designing your virtual network, you will need to anticipate where the majority of traffic is going to be sent. Network traffic moves faster within the same logical network, rather than between networks. This is because traffic between logical networks (using different subnets) needs to pass through a router, resulting in additional latency.

Consider the diagram below which has network traffic flowing between instances on separate VLANs:

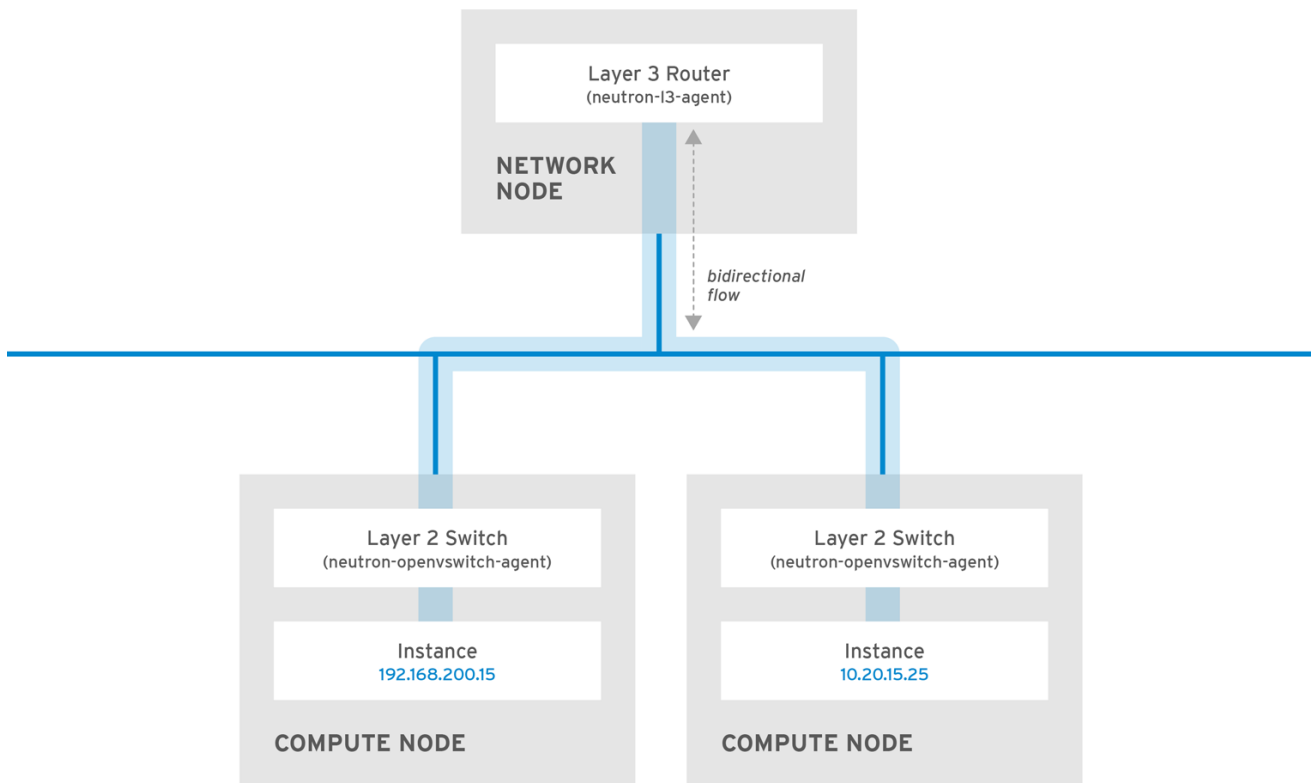

OPENSTACK\_450456\_0617

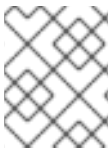

## NOTE

Even a high performance hardware router is still going to add some latency to this configuration.

### 2.9.1. Use switching where possible

Switching occurs at a lower level of the network (layer 2), so can function much quicker than the routing that occurs at layer 3. The preference should be to have as few hops as possible between systems that frequently communicate. For example, this diagram depicts a switched network that spans two physical nodes, allowing the two instances to directly communicate without using a router for navigation first. You'll notice that the instances now share the same subnet, to indicate that they're on the same logical network:



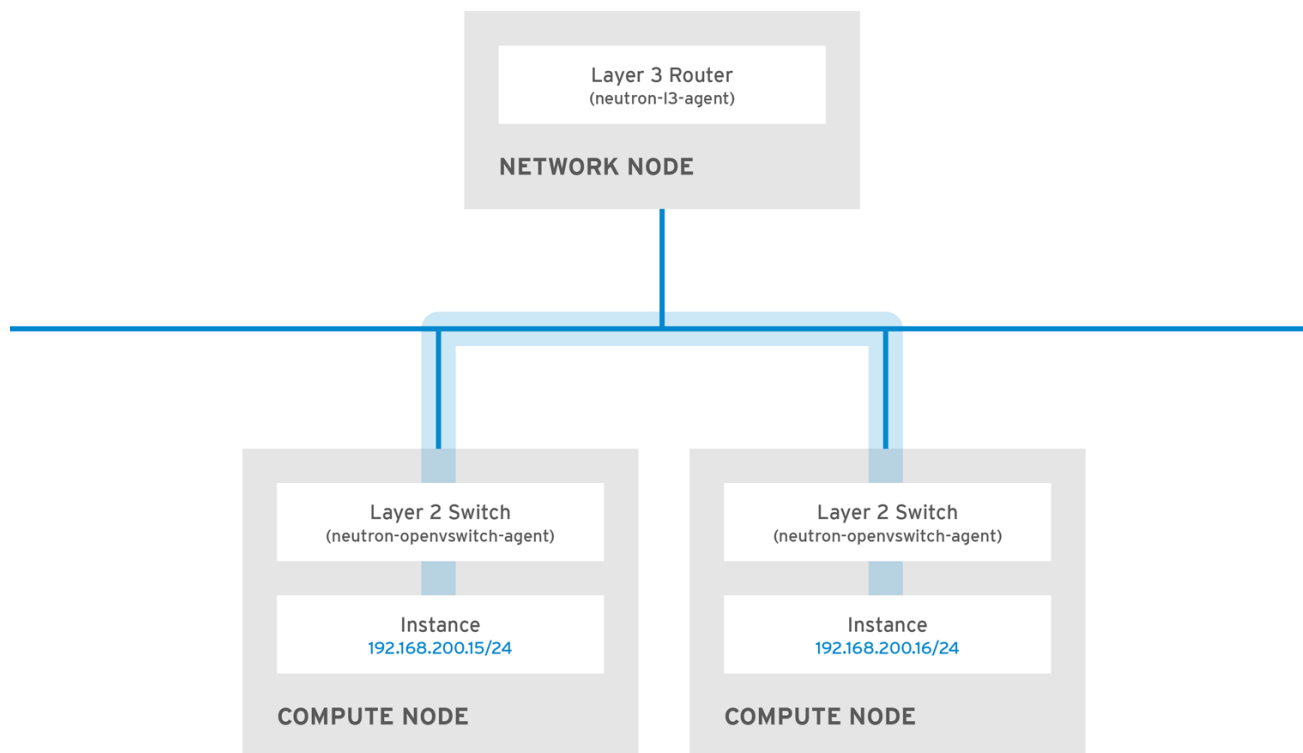

OPENSTACK\_450456\_0617

In order to allow instances on separate nodes to communicate as if they're on the same logical network, you'll need to use an encapsulation tunnel such as VXLAN or GRE. It is recommended you consider adjusting the MTU size from end-to-end in order to accommodate the additional bits required for the tunnel header, otherwise network performance can be negatively impacted as a result of fragmentation. For more information, see *Configure MTU Settings*.

You can further improve the performance of VXLAN tunneling by using supported hardware that features VXLAN offload capabilities. The full list is available here: <https://access.redhat.com/articles/1390483>

## **PART I. COMMON TASKS**

Covers common administrative tasks and basic troubleshooting steps.

## CHAPTER 3. COMMON ADMINISTRATIVE TASKS

OpenStack Networking (neutron) is the software-defined networking component of Red Hat OpenStack Platform. The virtual network infrastructure enables connectivity between instances and the physical external network.

This section describes common administration tasks, such as adding and removing subnets and routers to suit your Red Hat OpenStack Platform deployment.

### 3.1. Create a network

Create a network to give your instances a place to communicate with each other and receive IP addresses using DHCP. A network can also be integrated with external networks in your Red Hat OpenStack Platform deployment or elsewhere, such as the physical network. This integration allows your instances to communicate with outside systems. For more information, see *Bridge the physical network*.

When creating networks, it is important to know that networks can host multiple subnets. This is useful if you intend to host distinctly different systems in the same network, and would prefer a measure of isolation between them. For example, you can designate that only webserver traffic is present on one subnet, while database traffic traverse another. Subnets are isolated from each other, and any instance that wishes to communicate with another subnet must have their traffic directed by a router. Consider placing systems that will require a high volume of traffic amongst themselves in the same subnet, so that they don't require routing, and avoid the subsequent latency and load.

1. In the dashboard, select **Project > Network > Networks**.

2. Click **+Create Network** and specify the following:

Field	Description
Network Name	Descriptive name, based on the role that the network will perform. If you are integrating the network with an external VLAN, consider appending the VLAN ID number to the name. For example, <b>webserver_122</b> , if you are hosting HTTP web servers in this subnet, and your VLAN tag is <b>122</b> . Or you might use <b>internal-only</b> if you intend to keep the network traffic private, and not integrate it with an external network.
Admin State	Controls whether the network is immediately available. This field allows you to create the network but still keep it in a Down state, where it is logically present but still inactive. This is useful if you do not intend to enter the network into production right away.

3. Click the **Next** button, and specify the following in the **Subnet** tab:

Field	Description
Create Subnet	Determines whether a subnet is created. For example, you might not want to create a subnet if you intend to keep this network as a placeholder without network connectivity.
Subnet Name	Enter a descriptive name for the subnet.
Network Address	Enter the address in CIDR format, which contains the IP address range and subnet mask in one value. To determine the address, calculate the number of bits masked in the subnet mask and append that value to the IP address range. For example, the subnet mask 255.255.255.0 has 24 masked bits. To use this mask with the IPv4 address range 192.168.122.0, specify the address 192.168.122.0/24.
IP Version	Specifies the internet protocol version, where valid types are IPv4 or IPv6. The IP address range in the <i>Network Address</i> field must match whichever version you select.
Gateway IP	IP address of the router interface for your default gateway. This address is the next hop for routing any traffic destined for an external location, and must be within the range specified in the <i>Network Address</i> field. For example, if your CIDR network address is 192.168.122.0/24, then your default gateway is likely to be 192.168.122.1.
Disable Gateway	Disables forwarding and keeps the subnet isolated.

#### 4. Click **Next** to specify **DHCP** options:

- **Enable DHCP** - Enables DHCP services for this subnet. DHCP allows you to automate the distribution of IP settings to your instances.
- **IPv6 Address** - Configuration Modes If creating an IPv6 network, specifies how IPv6 addresses and additional information are allocated:
  - **No Options Specified** - Select this option if IP addresses are set manually, or a non OpenStack-aware method is used for address allocation.
  - **SLAAC (Stateless Address Autoconfiguration)** - Instances generate IPv6 addresses based on Router Advertisement (RA) messages sent from the OpenStack Networking router. This configuration results in an OpenStack Networking subnet created with `ra_mode` set to `slaac` and `address_mode` set to `slaac`.
  - **DHCPv6 stateful** - Instances receive IPv6 addresses as well as additional options (for example, DNS) from OpenStack Networking DHCPv6 service. This configuration results in

a subnet created with `ra_mode` set to `dhcpv6-stateful` and `address_mode` set to `dhcpv6-stateful`.

- **DHCPv6 stateless** - Instances generate IPv6 addresses based on Router Advertisement (RA) messages sent from the OpenStack Networking router. Additional options (for example, DNS) are allocated from the OpenStack Networking DHCPv6 service. This configuration results in a subnet created with `ra_mode` set to `dhcpv6-stateless` and `address_mode` set to `dhcpv6-stateless`.
- **Allocation Pools** - Range of IP addresses you would like DHCP to assign. For example, the value `192.168.22.100,192.168.22.100` considers all *up* addresses in that range as available for allocation.
- **DNS Name Servers** - IP addresses of the DNS servers available on the network. DHCP distributes these addresses to the instances for name resolution.
- **Host Routes** - Static host routes. First specify the destination network in CIDR format, followed by the next hop that should be used for routing. For example: `192.168.23.0/24, 10.1.31.1` Provide this value if you need to distribute static routes to instances.

### 5. Click **Create**.

The completed network is available for viewing in the **Networks** tab. You can also click **Edit** to change any options as needed. Now when you create instances, you can configure them now to use its subnet, and they will subsequently receive any specified DHCP options.

## 3.2. Create an advanced network

Advanced network options are available for administrators, when creating a network from the **Admin** view. These options define the network type to use, and allow tenants to be specified:

1. In the dashboard, select **Admin > Networks > Create Network > Project** . Select a destination project to host the new network using **Project**.

### 2. Review the options in **Provider Network Type**:

- **Local** - Traffic remains on the local Compute host and is effectively isolated from any external networks.
- **Flat** - Traffic remains on a single network and can also be shared with the host. No VLAN tagging or other network segregation takes place.
- **VLAN** - Create a network using a VLAN ID that corresponds to a VLAN present in the physical network. Allows instances to communicate with systems on the same layer 2 VLAN.
- **GRE** - Use a network overlay that spans multiple nodes for private communication between instances. Traffic egressing the overlay must be routed.
- **VXLAN** - Similar to GRE, and uses a network overlay to span multiple nodes for private communication between instances. Traffic egressing the overlay must be routed.

Click **Create Network**, and review the Project's Network Topology to validate that the network has been successfully created.

## 3.3. Add network routing

To allow traffic to be routed to and from your new network, you must add its subnet as an interface to an existing virtual router:

1. In the dashboard, select **Project > Network > Routers**.
2. Click on your virtual router's name in the **Routers** list, and click **+Add Interface**. In the Subnet list, select the name of your new subnet. You can optionally specify an IP address for the interface in this field.
3. Click **Add Interface**.

Instances on your network are now able to communicate with systems outside the subnet.

### 3.4. Delete a network

There are occasions where it becomes necessary to delete a network that was previously created, perhaps as housekeeping or as part of a decommissioning process. In order to successfully delete a network, you must first remove or detach any interfaces where it is still in use. The following procedure provides the steps for deleting a network in your project, together with any dependent interfaces.

1. In the dashboard, select **Project > Network > Networks**. Remove all router interfaces associated with the target network's subnets. To remove an interface: Find the ID number of the network you would like to delete by clicking on your target network in the **Networks** list, and looking at its **ID** field. All the network's associated subnets will share this value in their **Network ID** field.
2. Select **Project > Network > Routers**, click on your virtual router's name in the **Routers** list, and locate the interface attached to the subnet you would like to delete. You can distinguish it from the others by the IP address that would have served as the gateway IP. In addition, you can further validate the distinction by ensuring that the interface's network ID matches the ID you noted in the previous step.
3. Click the interface's **Delete Interface** button.

Select **Project > Network > Networks**, and click the name of your network. Click the target subnet's **Delete Subnet** button.



#### NOTE

If you are still unable to remove the subnet at this point, ensure it is not already being used by any instances.

4. Select **Project > Network > Networks**, and select the network you would like to delete.
5. Click **Delete Networks**.

### 3.5. Purge a tenant's networking

In a previous release, after deleting a project, you might have noticed the presence of stale resources that were once allocated to the project. This included networks, routers, and ports. Previously, these stale resources had to be manually deleted, while also being mindful of deleting them in the correct order. This has been addressed in Red Hat OpenStack Platform 11, where you can instead use the `neutron purge` command to delete all the neutron resources that once belonged to a particular project.

For example, to purge the neutron resources of `test -project` prior to deletion:

```
# openstack project list
+-----+-----+
| ID                | Name          |
+-----+-----+
| 02e501908c5b438dbc73536c10c9aac0 | test-project |
| 519e6344f82e4c079c8e2eabb690023b | services     |
| 80bf5732752a41128e612fe615c886c6 | demo         |
| 98a2f53c20ce4d50a40dac4a38016c69 | admin        |
+-----+-----+

# neutron purge 02e501908c5b438dbc73536c10c9aac0
Purging resources: 100% complete.
Deleted 1 security_group, 1 router, 1 port, 1 network.

# openstack project delete 02e501908c5b438dbc73536c10c9aac0
```

### 3.6. Create a subnet

Subnets are the means by which instances are granted network connectivity. Each instance is assigned to a subnet as part of the instance creation process, therefore it's important to consider proper placement of instances to best accommodate their connectivity requirements. Subnets are created in pre-existing networks. Remember that tenant networks in OpenStack Networking can host multiple subnets. This is useful if you intend to host distinctly different systems in the same network, and would prefer a measure of isolation between them. For example, you can designate that only webserver traffic is present on one subnet, while database traffic traverse another. Subnets are isolated from each other, and any instance that wishes to communicate with another subnet must have their traffic directed by a router. Consider placing systems that will require a high volume of traffic amongst themselves in the same subnet, so that they don't require routing, and avoid the subsequent latency and load.

#### 3.6.1. Create a new subnet

In the dashboard, select **Project > Network > Networks**, and click your network's name in the **Networks** view.

1. Click **Create Subnet**, and specify the following.

Field	Description
Subnet Name	Descriptive subnet name.
Network Address	Address in CIDR format, which contains the IP address range and subnet mask in one value. To determine the address, calculate the number of bits masked in the subnet mask and append that value to the IP address range. For example, the subnet mask 255.255.255.0 has 24 masked bits. To use this mask with the IPv4 address range 192.168.122.0, specify the address 192.168.122.0/24.

Field	Description
IP Version	Internet protocol version, where valid types are IPv4 or IPv6. The IP address range in the Network Address field must match whichever version you select.
Gateway IP	IP address of the router interface for your default gateway. This address is the next hop for routing any traffic destined for an external location, and must be within the range specified in the Network Address field. For example, if your CIDR network address is 192.168.122.0/24, then your default gateway is likely to be 192.168.122.1.
Disable Gateway	Disables forwarding and keeps the subnet isolated.

## 2. Click **Next** to specify DHCP options:

- **Enable DHCP** - Enables DHCP services for this subnet. DHCP allows you to automate the distribution of IP settings to your instances.
- **IPv6 Address** - Configuration Modes If creating an IPv6 network, specifies how IPv6 addresses and additional information are allocated:
  - **No Options Specified** - Select this option if IP addresses are set manually, or a non OpenStack-aware method is used for address allocation.
  - **SLAAC (Stateless Address Autoconfiguration)** - Instances generate IPv6 addresses based on Router Advertisement (RA) messages sent from the OpenStack Networking router. This configuration results in an OpenStack Networking subnet created with `ra_mode` set to `slaac` and `address_mode` set to `slaac`.
  - **DHCPv6 stateful** - Instances receive IPv6 addresses as well as additional options (for example, DNS) from OpenStack Networking DHCPv6 service. This configuration results in a subnet created with `ra_mode` set to `dhcpv6-stateful` and `address_mode` set to `dhcpv6-stateful`.
  - **DHCPv6 stateless** - Instances generate IPv6 addresses based on Router Advertisement (RA) messages sent from the OpenStack Networking router. Additional options (for example, DNS) are allocated from the OpenStack Networking DHCPv6 service. This configuration results in a subnet created with `ra_mode` set to `dhcpv6-stateless` and `address_mode` set to `dhcpv6-stateless`.
- **Allocation Pools** - Range of IP addresses you would like DHCP to assign. For example, the value `192.168.22.100,192.168.22.100` considers all *up* addresses in that range as available for allocation.
- **DNS Name Servers** - IP addresses of the DNS servers available on the network. DHCP distributes these addresses to the instances for name resolution.
- **Host Routes** - Static host routes. First specify the destination network in CIDR format, followed by the next hop that should be used for routing. For example: `192.168.23.0/24, 10.1.31.1` Provide this value if you need to distribute static routes to instances.



### 3. Click **Create**.

The new subnet is available for viewing in your network's Subnets list. You can also click **Edit** to change any options as needed. When you create instances, you can configure them now to use this subnet, and they will subsequently receive any specified DHCP options.

### 3.7. Delete a subnet

You can delete a subnet if it is no longer in use. However, if any instances are still configured to use the subnet, the deletion attempt fails and the dashboard displays an error message. This procedure demonstrates how to delete a specific subnet in a network:

In the dashboard, select **Project > Network > Networks**, and click the name of your network. Select the target subnet and click **Delete Subnets**.

### 3.8. Add a router

OpenStack Networking provides routing services using an SDN-based virtual router. Routers are a requirement for your instances to communicate with external subnets, including those out in the physical network. Routers and subnets connect using interfaces, with each subnet requiring its own interface to the router. A router's default gateway defines the next hop for any traffic received by the router. Its network is typically configured to route traffic to the external physical network using a virtual bridge.

1. In the dashboard, select **Project > Network > Routers**, and click **+Create Router**.
2. Enter a descriptive name for the new router, and click **Create router**.
3. Click **Set Gateway** next to the new router's entry in the **Routers** list.
4. In the **External Network** list, specify the network that will receive traffic destined for an external location.
5. Click **Set Gateway**. After adding a router, the next step is to configure any subnets you have created to send traffic using this router. You do this by creating interfaces between the subnet and the router.

### 3.9. Delete a router

You can delete a router if it has no connected interfaces. This procedure describes the steps needed to first remove a router's interfaces, and then the router itself.

1. In the dashboard, select **Project > Network > Routers**, and click on the name of the router you would like to delete.
2. Select the interfaces of type **Internal Interface**. Click **Delete Interfaces**.
3. From the **Routers** list, select the target router and click **Delete Routers**.

### 3.10. Add an interface

Interfaces allow you to interconnect routers with subnets. As a result, the router can direct any traffic that instances send to destinations outside of their intermediate subnet. This procedure adds a router interface and connects it to a subnet. The procedure uses the Network Topology feature, which displays a graphical representation of all your virtual router and networks and enables you to perform network management tasks.

1. In the dashboard, select **Project > Network > Network Topology** .
2. Locate the router you wish to manage, hover your mouse over it, and click **Add Interface** .
3. Specify the Subnet to which you would like to connect the router. You have the option of specifying an IP Address. The address is useful for testing and troubleshooting purposes, since a successful ping to this interface indicates that the traffic is routing as expected.
4. Click **Add interface** .

The **Network Topology** diagram automatically updates to reflect the new interface connection between the router and subnet.

### 3.11. Delete an interface

You can remove an interface to a subnet if you no longer require the router to direct its traffic. This procedure demonstrates the steps required for deleting an interface:

1. In the dashboard, select **Project > Network > Routers** .
2. Click on the name of the router that hosts the interface you would like to delete.
3. Select the interface (will be of type **Internal Interface**), and click **Delete Interfaces** .

### 3.12. Configure IP addressing

You can use procedures in this section to manage your IP address allocation in OpenStack Networking.

#### 3.12.1. Create floating IP pools

Floating IP addresses allow you to direct ingress network traffic to your OpenStack instances. You begin by defining a pool of validly routable external IP addresses, which can then be dynamically assigned to an instance. OpenStack Networking then knows to route all incoming traffic destined for that floating IP to the instance to which it has been assigned.



#### NOTE

OpenStack Networking allocates floating IP addresses to all projects (tenants) from the same IP ranges/CIDRs. Meaning that every subnet of floating IPs is consumable by any and all projects. You can manage this behavior using quotas for specific projects. For example, you can set the default to *10* for *ProjectA* and *ProjectB*, while setting *ProjectC*'s quota to *0*.

The Floating IP allocation pool is defined when you create an external subnet. If the subnet only hosts floating IP addresses, consider disabling DHCP allocation with the *enable\_dhcp=False* option:

```
# neutron subnet-create --name SUBNET_NAME --enable_dhcp=False --
allocation_pool start=IP_ADDRESS,end=IP_ADDRESS --gateway=IP_ADDRESS
NETWORK_NAME CIDR
```

For example:

```
# neutron subnet-create --name public_subnet --enable_dhcp=False --
allocation_pool start=192.168.100.20,end=192.168.100.100 --
gateway=192.168.100.1 public 192.168.100.0/24
```

### 3.12.2. Assign a specific floating IP

You can assign a specific floating IP address to an instance using the `nova` command.

```
# nova floating-ip-associate INSTANCE_NAME IP_ADDRESS
```

In this example, a floating IP address is allocated to an instance named `corp-vm-01`:

```
# nova floating-ip-associate corp-vm-01 192.168.100.20
```

### 3.12.3. Assign a random floating IP

Floating IP addresses can be dynamically allocated to instances. You do not select a particular IP address, but instead request that OpenStack Networking allocates one from the pool. Allocate a floating IP from the previously created pool:

```
# neutron floatingip-create public
+-----+-----+-----+-----+
| Field          | Value                               |
+-----+-----+-----+-----+
| fixed_ip_address |                                     |
| floating_ip_address | 192.168.100.20                       |
| floating_network_id | 7a03e6bc-234d-402b-9fb2-0af06c85a8a3 |
| id              | 9d7e2603482d                         |
| port_id         |                                     |
| router_id       |                                     |
| status          | ACTIVE                               |
| tenant_id       | 9e67d44eab334f07bf82fa1b17d824b6    |
+-----+-----+-----+-----+
```

With the IP address allocated, you can assign it to a particular instance. Locate the ID of the port associated with your instance (this will match the fixed IP address allocated to the instance). This port ID is used in the following step to associate the instance's port ID with the floating IP address ID. You can further distinguish the correct port ID by ensuring the MAC address in the third column matches the one on the instance.

```
# neutron port-list
+-----+-----+-----+-----+
-----+
| id      | name | mac_address | fixed_ips
|
+-----+-----+-----+-----+
-----+
| ce8320 |      | 3e:37:09:4b | {"subnet_id": "361f27", "ip_address":
"192.168.100.2"} |
| d88926 |      | 3e:1d:ea:31 | {"subnet_id": "361f27", "ip_address":
"192.168.100.5"} |
| 8190ab |      | 3e:a3:3d:2f | {"subnet_id": "b74dbb", "ip_address":
"10.10.1.25"} |
+-----+-----+-----+-----+
-----+
```

Use the **neutron** command to associate the floating IP address with the desired port ID of an instance:

```
# neutron floatingip-associate 9d7e2603482d 8190ab
```

### 3.13. Create multiple floating IP pools

OpenStack Networking supports one floating IP pool per L3 agent. Therefore, scaling out your L3 agents allows you to create additional floating IP pools.

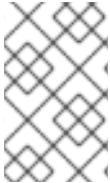

#### NOTE

Ensure that **handle\_internal\_only\_routers** in `/etc/neutron/neutron.conf` is configured to **True** for only one L3 agent in your environment. This option configures the L3 agent to manage only non-external routers.

### 3.14. Bridge the physical network

The procedure below enables you to bridge your virtual network to the physical network to enable connectivity to and from virtual instances. In this procedure, the example physical `eth0` interface is mapped to the `br-ex` bridge; the virtual bridge acts as the intermediary between the physical network and any virtual networks. As a result, all traffic traversing `eth0` uses the configured Open vSwitch to reach instances. Map a physical NIC to the virtual Open vSwitch bridge (for more information, see [Chapter 11, Configure Bridge Mappings](#)):



#### NOTE

**IPADDR**, **NETMASK** **GATEWAY**, and **DNS1** (name server) must be updated to match your network.

```
# vi /etc/sysconfig/network-scripts/ifcfg-eth0
DEVICE=eth0
TYPE=OVSPort
DEVICETYPE=ovs
OVS_BRIDGE=br-ex
ONBOOT=yes
```

Configure the virtual bridge with the IP address details that were previously allocated to `eth0`:

```
# vi /etc/sysconfig/network-scripts/ifcfg-br-ex
DEVICE=br-ex
DEVICETYPE=ovs
TYPE=OVSBridge
BOOTPROTO=static
IPADDR=192.168.120.10
NETMASK=255.255.255.0
GATEWAY=192.168.120.1
DNS1=192.168.120.1
ONBOOT=yes
```

You can now assign floating IP addresses to instances and make them available to the physical network.

## CHAPTER 4. PLANNING IP ADDRESS USAGE

An OpenStack deployment can consume a larger number of IP addresses than might be expected. This section aims to help with correctly anticipating the quantity of addresses required, and explains where they will be used.



### NOTE

VIPs (also known as Virtual IP Addresses) - VIP addresses host HA services, and are basically an IP address shared between multiple controller nodes.

### 4.1. Using multiple VLANs

When planning your OpenStack deployment, you might begin with a number of these subnets, from which you would be expected to allocate how the individual addresses will be used. Having multiple subnets allows you to segregate traffic between systems into VLANs. For example, you would not generally want management or API traffic to share the same network as systems serving web traffic. Traffic between VLANs will also need to traverse through a router, which represents an opportunity to have firewalls in place to further govern traffic flow.

### 4.2. Isolating VLAN traffic

You would typically allocate separate VLANs for the different types of network traffic you will host. For example, you could have separate VLANs for each of these types of networks. Of these, only the External network needs to be routable to the external physical network. In this release, DHCP services are provided by the *director*.



### NOTE

Not all of the isolated VLANs in this section will be required for every OpenStack deployment. For example, if your cloud users don't need to create ad hoc virtual networks on demand, then you may not require a tenant network; if you just need each VM to connect directly to the same switch as any other physical system, then you probably just need to connect your Compute nodes directly to a provider network and have your instances use that provider network directly.

- **Provisioning network** - This VLAN is dedicated to deploying new nodes using director over PXE boot. OpenStack Orchestration (heat) installs OpenStack onto the overcloud bare metal servers; these are attached to the physical network to receive the platform installation image from the undercloud infrastructure.
- **Internal API network** - The Internal API network is used for communication between the OpenStack services, and covers API communication, RPC messages, and database communication. In addition, this network is used for operational messages between controller nodes. When planning your IP address allocation, note that each API service requires its own IP address. Specifically, an IP address is required for each of these services:
  - vip-msg (ampq)
  - vip-keystone-int
  - vip-glance-int
  - vip-cinder-int

- o vip-nova-int
- o vip-neutron-int
- o vip-horizon-int
- o vip-heat-int
- o vip-ceilometer-int
- o vip-swift-int
- o vip-keystone-pub
- o vip-glance-pub
- o vip-cinder-pub
- o vip-nova-pub
- o vip-neutron-pub
- o vip-horizon-pub
- o vip-heat-pub
- o vip-ceilometer-pub
- o vip-swift-pub

**NOTE**

When using High Availability, Pacemaker expects to be able to move the VIP addresses between the physical nodes.

- **Storage** - Block Storage, NFS, iSCSI, among others. Ideally, this would be isolated to separate physical Ethernet links for performance reasons.
- **Storage Management** - OpenStack Object Storage (swift) uses this network to synchronise data objects between participating replica nodes. The proxy service acts as the intermediary interface between user requests and the underlying storage layer. The proxy receives incoming requests and locates the necessary replica to retrieve the requested data. Services that use a Ceph back-end connect over the Storage Management network, since they do not interact with Ceph directly but rather use the front-end service. Note that the RBD driver is an exception; this traffic connects directly to Ceph.
- **Tenant networks** - Neutron provides each tenant with their own networks using either VLAN segregation (where each tenant network is a network VLAN), or tunneling via VXLAN or GRE. Network traffic is isolated within each tenant network. Each tenant network has an IP subnet associated with it, and multiple tenant networks may use the same addresses.
- **External** - The External network hosts the public API endpoints and connections to the Dashboard (horizon). You can also optionally use this same network for SNAT, but this is not a requirement. In a production deployment, you will likely use a separate network for floating IP addresses and NAT.
- **Provider networks** - These networks allows instances to be attached to existing network

infrastructure. You can use provider networks to map directly to an existing physical network in the data center, using flat networking or VLAN tags. This allows an instance to share the same layer-2 network as a system external to the OpenStack Networking infrastructure.

### 4.3. IP address consumption

The following systems will consume IP addresses from your allocated range:

- **Physical nodes** - Each physical NIC will require one IP address; it is common practice to dedicate physical NICs to specific functions. For example, management and NFS traffic would each be allocated their own physical NICs (sometimes with multiple NICs connecting across to different switches for redundancy purposes).
- **Virtual IPs (VIPs) for High Availability** - You can expect to allocate around 1 to 3 for each network shared between controller nodes.

### 4.4. Virtual Networking

These virtual resources consume IP addresses in OpenStack Networking. These are considered local to the cloud infrastructure, and do not need to be reachable by systems in the external physical network:

- **Tenant networks** - Each tenant network will require a subnet from which it will allocate IP addresses to instances.
- **Virtual routers** - Each router interface plugging into a subnet will require one IP address (with an additional address required if DHCP is enabled).
- **Instances** - Each instance will require an address from the tenant subnet they are hosted in. If ingress traffic is needed, an additional floating IP address will need to be allocated from the designated external network.
- **Management traffic** - Includes OpenStack Services and API traffic. In Red Hat OpenStack Platform 11, requirements for virtual IP addresses have been reduced; all services will instead share a small number of VIPs. API, RPC and database services will communicate on the internal API VIP.

### 4.5. Example network plan

This example shows a number of networks that accommodate multiple subnets, with each subnet being assigned a range of IP addresses:

**Table 4.1. Example subnet plan**

Subnet name	Address range	Number of addresses	Subnet Mask
Provisioning network	192.168.100.1 - 192.168.100.250	250	255.255.255.0
Internal API network	172.16.1.10 - 172.16.1.250	241	255.255.255.0
Storage	172.16.2.10 - 172.16.2.250	241	255.255.255.0

Subnet name	Address range	Number of addresses	Subnet Mask
Storage Management	172.16.3.10 - 172.16.3.250	241	255.255.255.0
Tenant network (GRE/VXLAN)	172.19.4.10 - 172.16.4.250	241	255.255.255.0
External network (incl. floating IPs)	10.1.2.10 - 10.1.3.222	469	255.255.254.0
Provider network (infrastructure)	10.10.3.10 - 10.10.3.250	241	255.255.252.0



## CHAPTER 5. REVIEW OPENSTACK NETWORKING ROUTER PORTS

Virtual routers in OpenStack Networking use ports to interconnect with subnets. You can review the state of these ports to determine whether they're connecting as expected.

### 5.1. View current port status

This procedure lists all the ports attached to a particular router, then demonstrates how to retrieve a port's state (DOWN or ACTIVE).

#### 1. View all the ports attached to the router named `r1`:

```
# neutron router-port-list r1
```

Example result:

```
+-----+-----+-----+-----+
| id                | name | mac_address          |
fixed_ips
|
+-----+-----+-----+-----+
| b58d26f0-cc03-43c1-ab23-ccdb1018252a |      | fa:16:3e:94:a7:df |
{"subnet_id": "a592fdb8-babd-48e0-96e8-2dd9117614d3", "ip_address":
"192.168.200.1"} |
| c45e998d-98a1-4b23-bb41-5d24797a12a4 |      | fa:16:3e:ee:6a:f7 |
{"subnet_id": "43f8f625-c773-4f18-a691-fd4ebfb3be54", "ip_address":
"172.24.4.225"} |
+-----+-----+-----+-----+
|
```

2. View the details of each port by running this command against its ID (the value in the left column). The result includes the port's **status**, indicated in the following example as having an **ACTIVE** state:

```
# neutron port-show b58d26f0-cc03-43c1-ab23-ccdb1018252a
```

Example result:

```
+-----+-----+
| Field                | Value
|
+-----+-----+
| admin_state_up       | True
|
| allowed_address_pairs |
|
| binding:host_id      | node.example.com
```

```
|
| binding:profile           | {}
| binding:vif_details     | {"port_filter": true, "ovs_hybrid_plug": true}
| binding:vif_type        | ovs
| binding:vnic_type       | normal
| device_id               | 49c6ebdc-0e62-49ad-a9ca-58cea464472f
| device_owner            | network:router_interface
| extra_dhcp_opts         |
| fixed_ips               | {"subnet_id": "a592fdbd-babd-48e0-96e8-2dd9117614d3", "ip_address": "192.168.200.1"} |
| id                      | b58d26f0-cc03-43c1-ab23-ccdb1018252a
| mac_address             | fa:16:3e:94:a7:df
| name                    |
| network_id              | 63c24160-47ac-4140-903d-8f9a670b0ca4
| security_groups         |
| status                  | ACTIVE
| tenant_id               | d588d1112e0f496fb6cac22f9be45d49
|
+-----+-----+
-----+
```

Perform this step for each port to retrieve its status.

## CHAPTER 6. TROUBLESHOOT PROVIDER NETWORKS

A deployment of virtual routers and switches, also known as software-defined networking (SDN), may seem to introduce complexity at first glance. However, the diagnostic process of troubleshooting network connectivity in OpenStack Networking is similar to that of physical networks. If using VLANs, the virtual infrastructure can be considered a trunked extension of the physical network, rather than a wholly separate environment.

### 6.1. Topics covered

- Basic ping testing
- Troubleshooting VLAN networks
- Troubleshooting from within tenant networks

### 6.2. Basic ping testing

The `ping` command is a useful tool for analyzing network connectivity problems. The results serve as a basic indicator of network connectivity, but might not entirely exclude all connectivity issues, such as a firewall blocking the actual application traffic. The ping command works by sending traffic to specified destinations, and then reports back whether the attempts were successful.



#### NOTE

The ping command expects that ICMP traffic is allowed to traverse any intermediary firewalls.

Ping tests are most useful when run from the machine experiencing network issues, so it may be necessary to connect to the command line via the VNC management console if the machine seems to be completely offline.

For example, the ping test command below needs to validate multiple layers of network infrastructure in order to succeed; name resolution, IP routing, and network switching will all need to be functioning correctly:

```
$ ping www.redhat.com

PING e1890.b.akamaiedge.net (125.56.247.214) 56(84) bytes of data.
64 bytes from a125-56.247-214.deploy.akamaitechnologies.com
(125.56.247.214): icmp_seq=1 ttl=54 time=13.4 ms
64 bytes from a125-56.247-214.deploy.akamaitechnologies.com
(125.56.247.214): icmp_seq=2 ttl=54 time=13.5 ms
64 bytes from a125-56.247-214.deploy.akamaitechnologies.com
(125.56.247.214): icmp_seq=3 ttl=54 time=13.4 ms
^C
```

You can terminate the ping command with `Ctrl-c`, after which a summary of the results is presented. Zero packet loss indicates that the connection was timeous and stable:

```
--- e1890.b.akamaiedge.net ping statistics ---
3 packets transmitted, 3 received, 0% packet loss, time 2003ms
rtt min/avg/max/mdev = 13.461/13.498/13.541/0.100 ms
```

In addition, the results of a ping test can be very revealing, depending on which destination gets tested. For example, in the following diagram *VM1* is experiencing some form of connectivity issue. The possible destinations are numbered in blue, and the conclusions drawn from a successful or failed result are presented:

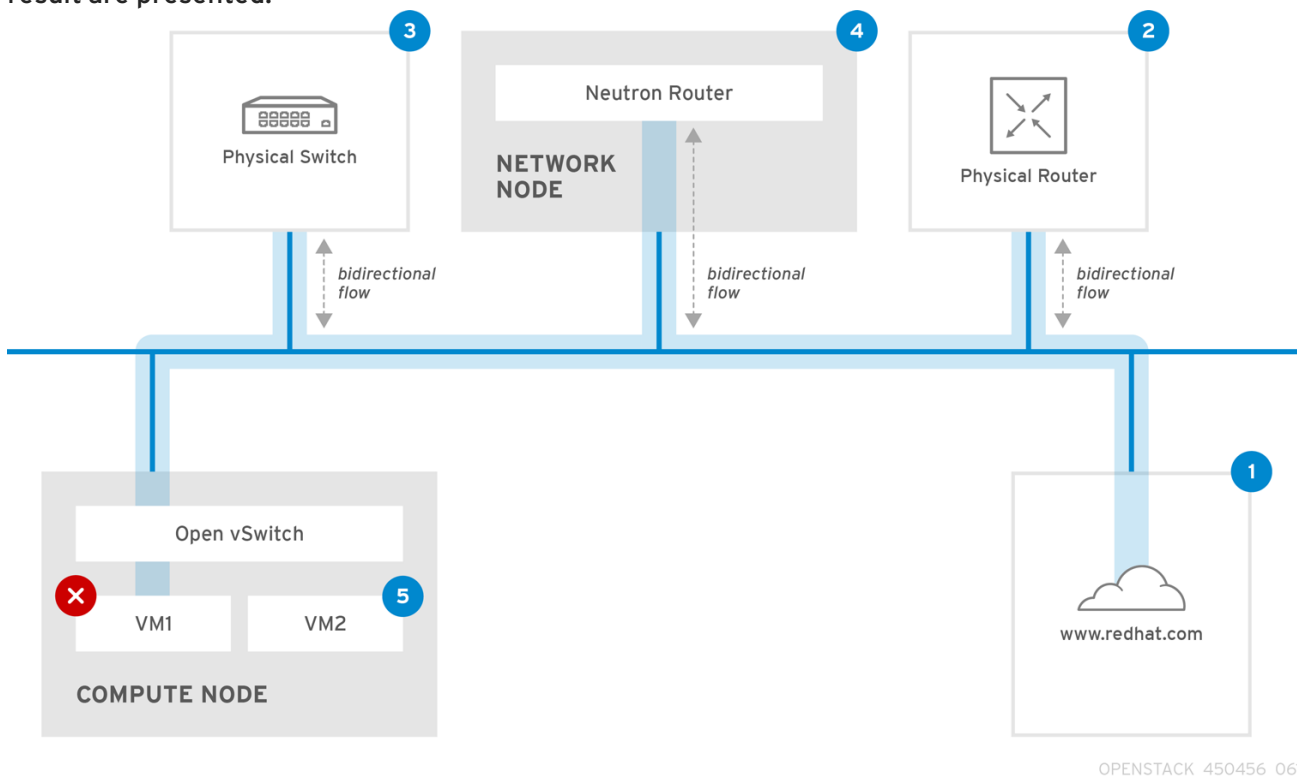

**1. The internet** - a common first step is to send a ping test to an internet location, such as [www.redhat.com](http://www.redhat.com).

- **Success:** This test indicates that all the various network points in between are working as expected. This includes the virtual and physical network infrastructure.
- **Failure:** There are various ways in which a ping test to a distant internet location can fail. If other machines on your network are able to successfully ping the internet, that proves the internet connection is working, and it's time to bring the troubleshooting closer to home.

**2. Physical router** - This is the router interface designated by the network administrator to direct traffic onward to external destinations.

- **Success:** Ping tests to the physical router can determine whether the local network and underlying switches are functioning. These packets don't traverse the router, so they do not prove whether there is a routing issue present on the default gateway.
- **Failure:** This indicates that the problem lies between VM1 and the default gateway. The router/switches might be down, or you may be using an incorrect default gateway. Compare the configuration with that on another server that is known to be working. Try pinging another server on the local network.

**3. Neutron router** - This is the virtual SDN (Software-defined Networking) router used by Red Hat OpenStack Platform to direct the traffic of virtual machines.

- **Success:** Firewall is allowing ICMP traffic, the Networking node is online.
- **Failure:** Confirm whether ICMP traffic is permitted in the instance's security group. Check that the Networking node is online, confirm that all the required services are running, and review the L3 agent log (`/var/log/neutron/l3-agent.log`).

**4. Physical switch** - The physical switch's role is to manage traffic between nodes on the same physical network.

- *Success:* Traffic sent by a VM to the physical switch will need to pass through the virtual network infrastructure, indicating that this segment is functioning as expected.
- *Failure:* Is the physical switch port configured to trunk the required VLANs?

**5. VM2** - Attempt to ping a VM on the same subnet, on the same Compute node.

- *Success:* The NIC driver and basic IP configuration on VM1 are functional.
- *Failure:* Validate the network configuration on VM1. Or, VM2's firewall might simply be blocking ping traffic. In addition, confirm that the virtual switching is set up correctly, and review the Open vSwitch (or Linux Bridge) log files.

### 6.3. Troubleshooting VLAN networks

OpenStack Networking is able to trunk VLAN networks through to the SDN switches. Support for VLAN-tagged provider networks means that virtual instances are able to integrate with server subnets in the physical network.

To troubleshoot connectivity to a VLAN Provider network, attempt to ping the gateway IP designated when the network was created. For example, if you created the network with these commands:

```
# neutron net-create provider --provider:network_type=vlan --
provider:physical_network=phy-eno1 --provider:segmentation_id=120
# neutron subnet-create "provider" --allocation-pool
start=192.168.120.1,end=192.168.120.253 --disable-dhcp --gateway
192.168.120.254 192.168.120.0/24
```

Then you'll want to attempt to ping the defined gateway IP of **192.168.120.254**

If that fails, confirm that you have network flow for the associated VLAN (as defined during network creation). In the example above, OpenStack Networking is configured to trunk VLAN 120 to the provider network. This option is set using the parameter **--provider:segmentation\_id=120**.

Confirm the VLAN flow on the bridge interface, in this case it's named **br-ex**:

```
# ovs-ofctl dump-flows br-ex

NXST_FLOW reply (xid=0x4):
  cookie=0x0, duration=987.521s, table=0, n_packets=67897,
n_bytes=14065247, idle_age=0, priority=1 actions=NORMAL
  cookie=0x0, duration=986.979s, table=0, n_packets=8, n_bytes=648,
idle_age=977, priority=2, in_port=12 actions=drop
```

#### 6.3.1. Review the VLAN configuration and log files

- **OpenStack Networking (neutron) agents** - Use the **neutron** command to verify that all agents are up and registered with the correct names:

```
# neutron agent-list
+-----+-----+-----+
-----+-----+-----+
```

```

| id | agent_type | host
| alive | admin_state_up |
+-----+-----+-----+
| a08397a8-6600-437d-9013-b2c5b3730c0c | Metadata agent |
rhelosp.example.com | :- ) | True |
| a5153cd2-5881-4fc8-b0ad-be0c97734e6a | L3 agent |
rhelosp.example.com | :- ) | True |
| b54f0be7-c555-43da-ad19-5593a075ddf0 | DHCP agent |
rhelosp.example.com | :- ) | True |
| d2be3cb0-4010-4458-b459-c5eb0d4d354b | Open vSwitch agent |
rhelosp.example.com | :- ) | True |
+-----+-----+-----+
-----+-----+-----+

```

- Review `/var/log/neutron/openvswitch-agent.log` - this log should provide confirmation that the creation process used the `ovs-ofctl` command to configure VLAN trunking.
- Validate `external_network_bridge` in the `/etc/neutron/l3_agent.ini` file. A hardcoded value here won't allow you to use a provider network via the L3-agent, and won't create the necessary flows. As a result, this value should look like this: `external_network_bridge = ""`
- Check `network_vlan_ranges` in the `/etc/neutron/plugin.ini` file. You don't need to specify the numeric VLAN ID if it's a provider network. The only time you need to specify the ID(s) here is if you're using VLAN isolated tenant networks.
- Validate the OVS agent configuration file bridge mappings, confirm that the bridge mapped to `phy-eno1` exists and is properly connected to `eno1`.

## 6.4. Troubleshooting from within tenant networks

In OpenStack Networking, all tenant traffic is contained within network namespaces. This allows tenants to configure networks without interfering with each other. For example, network namespaces allow different tenants to have the same subnet range of 192.168.1.1/24 without resulting in any interference between them.

To begin troubleshooting a tenant network, first determine which network namespace contains the network:

1. List all the tenant networks using the `neutron` command:

```

# neutron net-list
+-----+-----+-----+
-----+-----+-----+
| id | name | subnets
|
+-----+-----+-----+
| 9cb32fe0-d7fb-432c-b116-f483c6497b08 | web-servers | 453d6769-fcde-4796-
a205-66ee01680bba 192.168.212.0/24 |
| a0cc8cdd-575f-4788-a3e3-5df8c6d0dd81 | private | c1e58160-707f-44a7-
bf94-8694f29e74d3 10.0.0.0/24 |
| baadd774-87e9-4e97-a055-326bb422b29b | private | 340c58e1-7fe7-4cf2-
96a7-96a0a4ff3231 192.168.200.0/24 |
| 24ba3a36-5645-4f46-be47-f6af2a7d8af2 | public | 35f3d2cb-6e4b-4527-

```

```
a932-952a395c4bb3 172.24.4.224/28 |
+-----+-----+-----+-----+
-----+
```

In this example, we'll be examining the **web-servers** network. Make a note of the **id** value in the **web-server** row (in this case, its **9cb32fe0-d7fb-432c-b116-f483c6497b08**). This value is appended to the network namespace, which will help you identify in the next step.

2. List all the network namespaces using the **ip** command:

```
# ip netns list
qdhcp-9cb32fe0-d7fb-432c-b116-f483c6497b08
qrouter-31680a1c-9b3e-4906-bd69-cb39ed5faa01
qrouter-62ed467e-abae-4ab4-87f4-13a9937fbd6b
qdhcp-a0cc8cdd-575f-4788-a3e3-5df8c6d0dd81
qrouter-e9281608-52a6-4576-86a6-92955df46f56
```

In the result there is a namespace that matches the **web-server** network id. In this example it's presented as **qdhcp-9cb32fe0-d7fb-432c-b116-f483c6497b08**.

3. Examine the configuration of the **web-servers** network by running commands within the namespace. This is done by prefixing the troubleshooting commands with **ip netns exec (namespace)**. For example:

a) View the routing table of the **web-servers** network:

```
# ip netns exec qrouter-62ed467e-abae-4ab4-87f4-13a9937fbd6b route -n

Kernel IP routing table
Destination      Gateway          Genmask          Flags Metric Ref    Use
Iface
0.0.0.0          172.24.4.225    0.0.0.0          UG    0      0      0
qg-8d128f89-87
172.24.4.224    0.0.0.0          255.255.255.240 U    0      0      0
qg-8d128f89-87
192.168.200.0   0.0.0.0          255.255.255.0   U    0      0      0
qr-8efd6357-96
```

b) View the routing table of the **web-servers** network:

```
# ip netns exec qrouter-62ed467e-abae-4ab4-87f4-13a9937fbd6b route -n

Kernel IP routing table
Destination      Gateway          Genmask          Flags Metric Ref    Use
Iface
0.0.0.0          172.24.4.225    0.0.0.0          UG    0      0      0
qg-8d128f89-87
172.24.4.224    0.0.0.0          255.255.255.240 U    0      0      0
qg-8d128f89-87
192.168.200.0   0.0.0.0          255.255.255.0   U    0      0      0
qr-8efd6357-96
```

#### 6.4.1. Perform advanced ICMP testing within the namespace

1. Capture ICMP traffic using the **tcpdump** command.

```
# ip netns exec qrouter-62ed467e-abae-4ab4-87f4-13a9937fbd6b tcpdump -
qnntpi any icmp
```

There may not be any output until you perform the next step:

2. In a separate command line window, perform a ping test to an external network:

```
# ip netns exec qrouter-62ed467e-abae-4ab4-87f4-13a9937fbd6b ping
www.redhat.com
```

3. In the terminal running the **tcpdump** session, you will observe detailed results of the ping test.

```
tcpdump: listening on any, link-type LINUX_SLL (Linux cooked), capture
size 65535 bytes
IP (tos 0xc0, ttl 64, id 55447, offset 0, flags [none], proto ICMP (1),
length 88)
    172.24.4.228 > 172.24.4.228: ICMP host 192.168.200.20 unreachable,
length 68
    IP (tos 0x0, ttl 64, id 22976, offset 0, flags [DF], proto UDP (17),
length 60)
    172.24.4.228.40278 > 192.168.200.21: [bad udp cksum 0xfa7b -> 0xe235!]
UDP, length 32
```



#### NOTE

When performing a **tcpdump** analysis of traffic, you might observe the responding packets heading to the router interface rather than the instance. This is expected behaviour, as the **qrouter** performs DNAT on the return packets.



## CHAPTER 7. CONNECT AN INSTANCE TO THE PHYSICAL NETWORK

This chapter explains how to use provider networks to connect instances directly to an external network.

### Overview of the OpenStack Networking topology:

OpenStack Networking (neutron) has two categories of services distributed across a number of node types.

- **Neutron server** - This service runs the OpenStack Networking API server, which provides the API for end-users and services to interact with OpenStack Networking. This server also integrates with the underlying database to store and retrieve tenant network, router, and loadbalancer details, among others.
- **Neutron agents** - These are the services that perform the network functions for OpenStack Networking:
  - **neutron-dhcp-agent** - manages DHCP IP addressing for tenant private networks.
  - **neutron-l3-agent** - performs layer 3 routing between tenant private networks, the external network, and others.
  - **neutron-lbaas-agent** - provisions the LBaaS routers created by tenants.
- **Compute node** - This node hosts the hypervisor that runs the virtual machines, also known as instances. A Compute node must be wired directly to the network in order to provide external connectivity for instances. This node is typically where the I2 agents run, such as **neutron-openvswitch-agent**.

### Service placement:

The OpenStack Networking services can either run together on the same physical server, or on separate dedicated servers, which are named according to their roles:

- *Controller node* - The server that runs API service.
- *Network node* - The server that runs the OpenStack Networking agents.
- *Compute node* - The hypervisor server that hosts the instances.

The steps in this chapter assume that your environment has deployed these three node types. If your deployment has both the Controller and Network node roles on the same physical node, then the steps from both sections must be performed on that server. This also applies for a High Availability (HA) environment, where all three nodes might be running the Controller node and Network node services with HA. As a result, sections applicable to Controller and Network nodes will need to be performed on all three nodes.

### 7.1. Using Flat Provider Networks

This procedure creates flat provider networks that can connect instances directly to external networks. You would do this if you have multiple physical networks (for example, **physnet1**, **physnet2**) and separate physical interfaces (**eth0** -> **physnet1**, and **eth1** -> **physnet2**), and you need to connect each Compute node and Network node to those external networks.

**NOTE**

If you want to connect multiple VLAN-tagged interfaces (on a single NIC) to multiple provider networks, please refer to [Section 7.2, “Using VLAN provider networks”](#).

**Configure the Controller nodes:**

1. Edit `/etc/neutron/plugin.ini` (which is symlinked to `/etc/neutron/plugins/ml2/ml2_conf.ini`) and add `flat` to the existing list of values, and set `flat_networks` to `*`:

```
type_drivers = vxlan,flat
flat_networks =*
```

2. Create a flat external network and associate it with the configured `physical_network`. Creating it as a shared network will allow other users to connect their instances directly to it:

```
neutron net-create public01 --provider:network_type flat --
provider:physical_network physnet1 --router:external=True --shared
```

3. Create a subnet within this external network using `neutron subnet-create`, or the OpenStack Dashboard. For example:

```
neutron subnet-create --name public_subnet --enable_dhcp=False --
allocation_pool start=192.168.100.20,end=192.168.100.100 --
gateway=192.168.100.1 public01 192.168.100.0/24
```

4. Restart the `neutron-server` service to apply this change:

```
# systemctl restart neutron-server.service
```

**Configure the Network node and Compute nodes:**

These steps must be completed on the Network node and the Compute nodes. As a result, the nodes will connect to the external network, and will allow instances to communicate directly with the external network.

1. Create the Open vSwitch bridge and port. This step creates the external network bridge (`br-ex`) and adds a corresponding port (`eth1`):

i. Edit `/etc/sysconfig/network-scripts/ifcfg-eth1`:

```
DEVICE=eth1
TYPE=OVSPort
DEVICETYPE=ovs
OVS_BRIDGE=br-ex
ONBOOT=yes
NM_CONTROLLED=no
BOOTPROTO=none
```

ii. Edit `/etc/sysconfig/network-scripts/ifcfg-br-ex`:

```
DEVICE=br-ex
TYPE=OVSBridge
```

```
DEVICETYPE=ovs
ONBOOT=yes
NM_CONTROLLED=no
BOOTPROTO=none
```

2. Restart the **network** service for the changes to take effect:

```
# systemctl restart network.service
```

3. Configure the physical networks in `/etc/neutron/plugins/ml2/openvswitch_agent.ini` and map the bridge to the physical network:



#### NOTE

For more information on configuring `bridge_mappings`, see [Chapter 11, Configure Bridge Mappings](#).

```
bridge_mappings = physnet1:br-ex
```

4. Restart the **neutron-openvswitch-agent** service on the Network and Compute nodes for the changes to take effect:

```
systemctl restart neutron-openvswitch-agent
```

#### Configure the Network node:

1. Set `external_network_bridge` = to an empty value in `/etc/neutron/l3_agent.ini`. This enables the use of external provider networks.

```
# Name of bridge used for external network traffic. This should be set to
# empty value for the linux bridge
external_network_bridge =
```

2. Restart **neutron-l3-agent** for the changes to take effect:

```
systemctl restart neutron-l3-agent.service
```



#### NOTE

If there are multiple flat provider networks, each of them should have separate physical interface and bridge to connect them to external network. Please configure the `ifcfg-*` scripts appropriately and use comma-separated list for each network when specifying them in `bridge_mappings`. For more information on configuring `bridge_mappings`, see [Chapter 11, Configure Bridge Mappings](#).

#### Connect an instance to the external network:

With the network created, you can now connect an instance to it and test connectivity:

1. Create a new instance.

2. Use the **Networking** tab in the dashboard to add the new instance directly to the newly-created external network.

### How does the packet flow work?

With flat provider networking configured, this section describes in detail how traffic flows to and from an instance.

#### 7.1.1. The flow of outgoing traffic

The packet flow for traffic leaving an instance and arriving directly at an external network: Once you configure `br-ex`, add the physical interface, and spawn an instance to a Compute node, your resulting interfaces and bridges will be similar to those in the diagram below (if using the `iptables_hybrid` firewall driver):

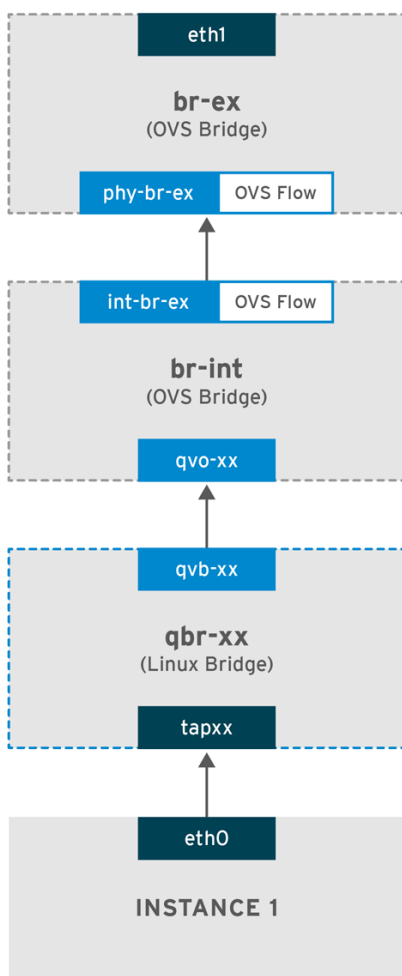

OPENSTACK\_450456\_0617

1. Packets leaving the `eth0` interface of the instance will first arrive at the linux bridge `qbr-xx`.
2. Bridge `qbr-xx` is connected to `br-int` using veth pair `qvb-xx <-> qvo-xxx`. This is because the bridge is used to apply the inbound/outbound firewall rules defined by the security group.
3. Interface `qvbxx` is connected to the `qbr-xx` linux bridge, and `qvoxx` is connected to the `br-int` Open vSwitch (OVS) bridge.

**The configuration of `qbr-xx` on the Linux bridge:**

```
qbr269d4d73-e7 8000.061943266ebb no qvb269d4d73-e7
tap269d4d73-e7
```

### The configuration of qvoxx on br-int:

```
Bridge br-int
  fail_mode: secure
  Interface "qvof63599ba-8f"
  Port "qvo269d4d73-e7"
    tag: 5
  Interface "qvo269d4d73-e7"
```



#### NOTE

Port **qvoxx** is tagged with the internal VLAN tag associated with the flat provider network. In this example, the VLAN tag is 5. Once the packet reaches **qvoxx**, the VLAN tag is appended to the packet header.

The packet is then moved to the **br-ex** OVS bridge using the patch-peer **int-br-ex <-> phy-br-ex**.

### Example configuration of the patch-peer on br-int:

```
Bridge br-int
  fail_mode: secure
  Port int-br-ex
    Interface int-br-ex
      type: patch
      options: {peer=phy-br-ex}
```

### Example configuration of the patch-peer on br-ex:

```
Bridge br-ex
  Port phy-br-ex
    Interface phy-br-ex
      type: patch
      options: {peer=int-br-ex}
  Port br-ex
    Interface br-ex
      type: internal
```

When this packet reaches **phy-br-ex** on **br-ex**, an OVS flow inside **br-ex** strips the VLAN tag (5) and forwards it to the physical interface.

In the example below, the output shows the port number of **phy-br-ex** as 2.

```
# ovs-ofctl show br-ex
OFPT_FEATURES_REPLY (xid=0x2): dpid:00003440b5c90dc6
n_tables:254, n_buffers:256
capabilities: FLOW_STATS TABLE_STATS PORT_STATS QUEUE_STATS ARP_MATCH_IP
actions: OUTPUT SET_VLAN_VID SET_VLAN_PCP STRIP_VLAN SET_DL_SRC SET_DL_DST
SET_NW_SRC SET_NW_DST SET_NW_TOS SET_TP_SRC SET_TP_DST ENQUEUE
```

```

2(phy-br-ex): addr:ba:b5:7b:ae:5c:a2
config:      0
state:       0
speed: 0 Mbps now, 0 Mbps max

```

The output below shows any packet that arrives on **phy-br-ex** (**in\_port=2**) with a VLAN tag of **5** (**d1\_vlan=5**). In addition, the VLAN tag is stripped away and the packet is forwarded (**actions=strip\_vlan,NORMAL**).

```

# ovs-ofctl dump-flows br-ex
NXST_FLOW reply (xid=0x4):
 cookie=0x0, duration=4703.491s, table=0, n_packets=3620, n_bytes=333744,
 idle_age=0, priority=1 actions=NORMAL
 cookie=0x0, duration=3890.038s, table=0, n_packets=13, n_bytes=1714,
 idle_age=3764, priority=4,in_port=2,d1_vlan=5 actions=strip_vlan,NORMAL
 cookie=0x0, duration=4702.644s, table=0, n_packets=10650, n_bytes=447632,
 idle_age=0, priority=2,in_port=2 actions=drop

```

This packet is then forwarded to the physical interface. If the physical interface is another VLAN-tagged interface, then the interface will add the tag to the packet.

### 7.1.2. The flow of incoming traffic

This section describes the flow of incoming traffic from the external network until it arrives at the instance's interface.

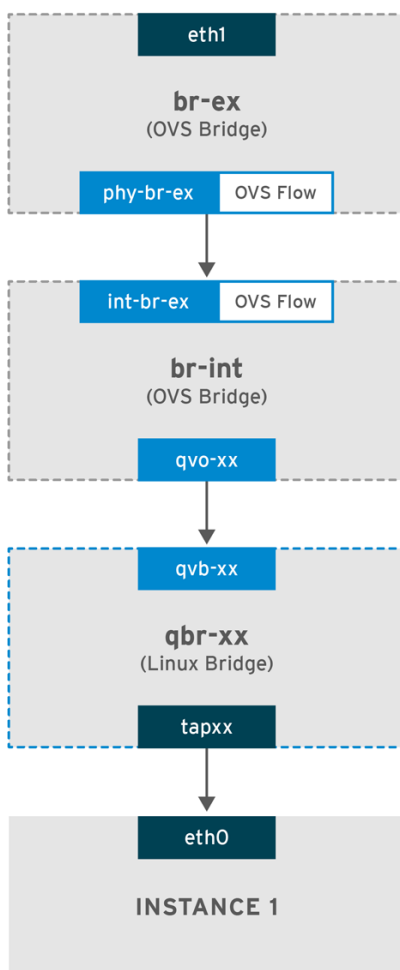

1. Incoming traffic first arrives at `eth1` on the physical node.
2. The packet is then passed to the `br-ex` bridge.
3. The packet then moves to `br-int` using the patch-peer `phy-br-ex <--> int-br-ex`.

In the example below, `int-br-ex` uses port number 15. See the entry containing `15(int-br-ex)`:

```
ovs-ofctl show br-int
OFPT_FEATURES_REPLY (xid=0x2): dpid:00004e67212f644d
n_tables:254, n_buffers:256
capabilities: FLOW_STATS TABLE_STATS PORT_STATS QUEUE_STATS ARP_MATCH_IP
actions: OUTPUT SET_VLAN_VID SET_VLAN_PCP STRIP_VLAN SET_DL_SRC SET_DL_DST
SET_NW_SRC SET_NW_DST SET_NW_TOS SET_TP_SRC SET_TP_DST ENQUEUE
  15(int-br-ex): addr:12:4e:44:a9:50:f4
    config:      0
    state:       0
    speed: 0 Mbps now, 0 Mbps max
```

### Observing the traffic flow on br-int

1. When the packet arrives at `int-br-ex`, an OVS flow rule within the `br-int` bridge amends the packet to add the internal VLAN tag 5. See the entry for `actions=mod_vlan_vid:5`:

```
# ovs-ofctl dump-flows br-int
NXST_FLOW reply (xid=0x4):
  cookie=0x0, duration=5351.536s, table=0, n_packets=12118, n_bytes=510456,
  idle_age=0, priority=1 actions=NORMAL
  cookie=0x0, duration=4537.553s, table=0, n_packets=3489, n_bytes=321696,
  idle_age=0, priority=3, in_port=15, vlan_tci=0x0000
  actions=mod_vlan_vid:5, NORMAL
  cookie=0x0, duration=5350.365s, table=0, n_packets=628, n_bytes=57892,
  idle_age=4538, priority=2, in_port=15 actions=drop
  cookie=0x0, duration=5351.432s, table=23, n_packets=0, n_bytes=0,
  idle_age=5351, priority=0 actions=drop
```

2. The second rule manages packets that arrive on `int-br-ex` (`in_port=15`) with no VLAN tag (`vlan_tci=0x0000`): It adds VLAN tag 5 to the packet (`actions=mod_vlan_vid:5, NORMAL`) and forwards it on to `qvoxxx`.
3. `qvoxxx` accepts the packet and forwards to `qvbxx`, after stripping the away the VLAN tag.
4. The packet then reaches the instance.



#### NOTE

VLAN tag 5 is an example VLAN that was used on a test Compute node with a flat provider network; this value was assigned automatically by `neutron-openvswitch-agent`. This value may be different for your own flat provider network, and it can differ for the same network on two separate Compute nodes.

### 7.1.3. Troubleshooting

The output provided in the section above - *How does the packet flow work?*- provides sufficient debugging information for troubleshooting a flat provider network, should anything go wrong. The steps below would further assist with the troubleshooting process.

### 1. Review bridge\_mappings:

Verify that physical network name used (for example, **physnet1**) is consistent with the contents of the **bridge\_mapping** configuration. For example:

```
# grep bridge_mapping /etc/neutron/plugins/ml2/openvswitch_agent.ini
bridge_mappings = physnet1:br-ex

# neutron net-show provider-flat
...
| provider:physical_network | physnet1
...
```

### 2. Review the network configuration:

Confirm that the network is created as **external**, and uses the **flat** type:

```
# neutron net-show provider-flat
...
| provider:network_type      | flat          |
| router:external           | True         |
...
```

### 3. Review the patch-peer:

Run `ovs-vsctl show`, and verify that **br-int** and **br-ex** is connected using a patch-peer `int-br-ex <-> phy-br-ex`.

This connection is created when the `neutron-openvswitch-agent` service is restarted. But only if **bridge\_mapping** is correctly configured in `/etc/neutron/plugins/ml2/openvswitch_agent.ini`. Re-check the **bridge\_mapping** setting if this is not created, even after restarting the service.



#### NOTE

For more information on configuring **bridge\_mappings**, see [Chapter 11, Configure Bridge Mappings](#).

### 4. Review the network flows:

Run `ovs-ofctl dump-flows br-ex` and `ovs-ofctl dump-flows br-int` and review whether the flows strip the internal VLAN IDs for outgoing packets, and add VLAN IDs for incoming packets. This flow is first added when you spawn an instance to this network on a specific Compute node.

- If this flow is not created after spawning the instance, verify that the network is created as **flat**, is **external**, and that the **physical\_network** name is correct. In addition, review the **bridge\_mapping** settings.



- Finally, review the `ifcfg-br-ex` and `ifcfg-ethx` configuration. Make sure that `ethX` is definitely added as a port within `br-ex`, and that both of them have `UP` flag in the output of `ip a`.

For example, the output below shows `eth1` is a port in `br-ex`:

```
Bridge br-ex
  Port phy-br-ex
    Interface phy-br-ex
      type: patch
      options: {peer=int-br-ex}
  Port "eth1"
    Interface "eth1"
```

The example below demonstrates that `eth1` is configured as an OVS port, and that the kernel knows to transfer all packets from the interface, and send them to the OVS bridge `br-ex`. This can be observed in the entry: `master ovs-system`.

```
# ip a
5: eth1: <BROADCAST,MULTICAST,UP,LOWER_UP> mtu 1500 qdisc mq master ovs-
system state UP qlen 1000
```

## 7.2. Using VLAN provider networks

This procedure creates VLAN provider networks that can connect instances directly to external networks. You would do this if you want to connect multiple VLAN-tagged interfaces (on a single NIC) to multiple provider networks. This example uses a physical network called `physnet1`, with a range of VLANs (171-172). The network nodes and compute nodes are connected to the physical network using a physical interface on them called `eth1`. The switch ports to which these interfaces are connected must be configured to trunk the required VLAN ranges.

The following procedures configure the VLAN provider networks using the example VLAN IDs and names given above.

### Configure the Controller nodes:

1. Enable the `vlan` mechanism driver by editing `/etc/neutron/plugin.ini` (symlinked to `/etc/neutron/plugins/ml2/ml2_conf.ini`), and add `vlan` to the existing list of values. For example:

```
[ml2]
type_drivers = vxlan,flat,vlan
```

2. Configure the `network_vlan_ranges` setting to reflect the physical network and VLAN ranges in use. For example:

```
[ml2_type_vlan]
network_vlan_ranges=physnet1:171:172
```

3. Restart the `neutron-server` service to apply the changes:

```
systemctl restart neutron-server
```

4. Create the external networks as a *vlan*-type, and associate them to the configured **physical\_network**. Create it as a *--shared* network to let other users directly connect instances. This example creates two networks: one for VLAN 171, and another for VLAN 172:

```
neutron net-create provider-vlan171 \
  --provider:network_type vlan \
  --router:external true \
  --provider:physical_network physnet1 \
  --provider:segmentation_id 171 --shared

neutron net-create provider-vlan172 \
  --provider:network_type vlan \
  --router:external true \
  --provider:physical_network physnet1 \
  --provider:segmentation_id 172 --shared
```

5. Create a number of subnets and configure them to use the external network. This is done using either **neutron subnet-create** or the dashboard. You will want to make certain that the external subnet details you have received from your network administrator are correctly associated with each VLAN. In this example, VLAN 171 uses subnet *10.65.217.0/24* and VLAN 172 uses *10.65.218.0/24*:

```
neutron subnet-create \
  --name subnet-provider-171 provider-171 10.65.217.0/24 \
  --enable-dhcp \
  --gateway 10.65.217.254 \

neutron subnet-create \
  --name subnet-provider-172 provider-172 10.65.218.0/24 \
  --enable-dhcp \
  --gateway 10.65.218.254 \
```

### Configure the Network nodes and Compute nodes:

These steps must be performed on the Network node and Compute nodes. As a result, this will connect the nodes to the external network, and permit instances to communicate directly with the external network.

1. Create an external network bridge ( *br-ex*), and associate a port ( *eth1*) with it:

- This example configures *eth1* to use *br-ex*:

```
/etc/sysconfig/network-scripts/ifcfg-eth1

DEVICE=eth1
TYPE=OVSPort
DEVICETYPE=ovs
OVS_BRIDGE=br-ex
ONBOOT=yes
NM_CONTROLLED=no
BOOTPROTO=none
```

- This example configures the *br-ex* bridge:

```
/etc/sysconfig/network-scripts/ifcfg-br-ex:
```

```
DEVICE=br-ex
TYPE=OVSBridge
DEVICETYPE=ovs
ONBOOT=yes
NM_CONTROLLED=no
BOOTPROTO=none
```

2. Reboot the node, or restart the `network` service for the networking changes to take effect. For example:

```
# systemctl restart network
```

3. Configure the physical networks in `/etc/neutron/plugins/ml2/openvswitch_agent.ini` and map bridges according to the physical network:

```
bridge_mappings = physnet1:br-ex
```



#### NOTE

For more information on configuring `bridge_mappings`, see [Chapter 11, Configure Bridge Mappings](#).

4. Restart the `neutron-openvswitch-agent` service on the network nodes and compute nodes for the changes to take effect:

```
systemctl restart neutron-openvswitch-agent
```

#### Configure the Network node:

1. Set `external_network_bridge` = to an empty value in `/etc/neutron/l3_agent.ini`. This is required to use provider external networks, not bridge based external network where we will add `external_network_bridge = br-ex`:

```
# Name of bridge used for external network traffic. This should be set to
# empty value for the linux bridge
external_network_bridge =
```

2. Restart `neutron-l3-agent` for the changes to take effect.

```
systemctl restart neutron-l3-agent
```

3. Create a new instance and use the **Networking** tab in the dashboard to add the new instance directly to the newly-created external network.

#### How does the packet flow work?

With VLAN provider networking configured, this section describes in detail how traffic flows to and from an instance:

##### 7.2.1. The flow of outgoing traffic

This section describes the packet flow for traffic leaving an instance and arriving directly to a VLAN provider external network. This example uses two instances attached to the two VLAN networks (171

and 172). Once you configure *br-ex*, add a physical interface to it, and spawn an instance to a Compute node, your resulting interfaces and bridges will be similar to those in the diagram below:

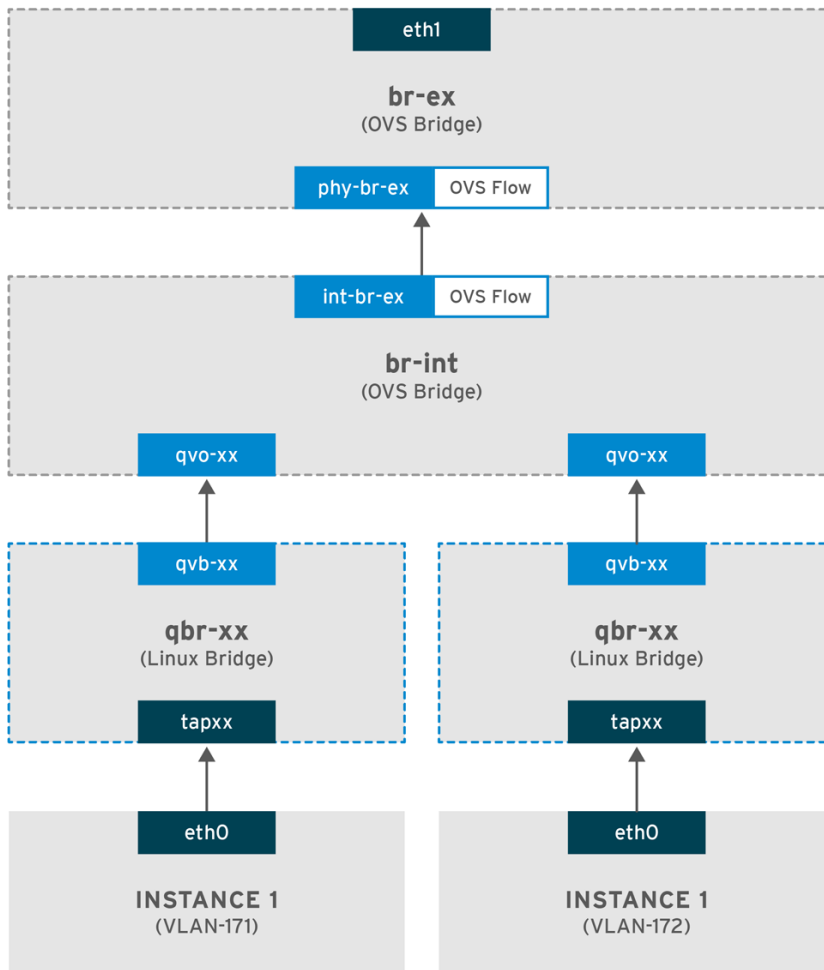

OPENSTACK\_450456\_0617

1. As illustrated above, packets leaving the instance's *eth0* first arrive at the linux bridge *qbr-xx* connected to the instance.
2. *qbr-xx* is connected to *br-int* using veth pair *qvbxx*  $\leftrightarrow$  *qvoxxx*.
3. *qvbxx* is connected to the linux bridge *qbr-xx* and *qvoxxx* is connected to the Open vSwitch bridge *br-int*.

Below is the configuration of *qbr-xx* on the Linux bridge.

Since there are two instances, there would be two linux bridges:

```
# brctl show
bridge name bridge id STP enabled interfaces
qbr84878b78-63 8000.e6b3df9451e0 no qvb84878b78-63
tap84878b78-63

qbr86257b61-5d 8000.3a3c888eeae6 no qvb86257b61-5d
tap86257b61-5d
```

The configuration of *qvoxxx* on *br-int*:

```
options: {peer=phy-br-ex}
```

```

Port "qvo86257b61-5d"
  tag: 3

  Interface "qvo86257b61-5d"
Port "qvo84878b78-63"
  tag: 2
  Interface "qvo84878b78-63"

```

- **qvoxx** is tagged with the internal VLAN tag associated with the VLAN provider network. In this example, the internal VLAN tag 2 is associated with the VLAN provider network **provider-171** and VLAN tag 3 is associated with VLAN provider network **provider-172**. Once the packet reaches *qvoxx*, the packet header will get this VLAN tag added to it.
- The packet is then moved to the *br-ex* OVS bridge using patch-peer **int-br-ex <=> phy-br-ex**. Example patch-peer on *br-int*:

```

Bridge br-int
  fail_mode: secure
  Port int-br-ex
    Interface int-br-ex
      type: patch
      options: {peer=phy-br-ex}

```

Example configuration of the patch peer on *br-ex*:

```

Bridge br-ex
  Port phy-br-ex
    Interface phy-br-ex
      type: patch
      options: {peer=int-br-ex}
  Port br-ex
    Interface br-ex
      type: internal

```

- When this packet reaches *phy-br-ex* on *br-ex*, an OVS flow inside *br-ex* replaces the internal VLAN tag with the actual VLAN tag associated with the VLAN provider network.

The output of the following command shows that the port number of *phy-br-ex* is 4:

```

# ovs-ofctl show br-ex
4(phy-br-ex): addr:32:e7:a1:6b:90:3e
  config:      0
  state:       0
  speed: 0 Mbps now, 0 Mbps max

```

The below command displays any packet that arrives on *phy-br-ex* (**in\_port=4**) which has VLAN tag 2 (**d1\_vlan=2**). Open vSwitch replaces the VLAN tag with 171 (**actions=mod\_vlan\_vid:171, NORMAL**) and forwards the packet on. It also shows any packet that arrives on *phy-br-ex* (**in\_port=4**) which has VLAN tag 3 (**d1\_vlan=3**). Open vSwitch replaces the VLAN tag with 172 (**actions=mod\_vlan\_vid:172, NORMAL**) and forwards the packet on. These rules are automatically added by *neutron-openvswitch-agent*.

```

# ovs-ofctl dump-flows br-ex
NXST_FLOW reply (xid=0x4):

```

```
NXST_FLOW reply (xid=0x4):
  cookie=0x0, duration=6527.527s, table=0, n_packets=29211,
n_bytes=2725576, idle_age=0, priority=1 actions=NORMAL
  cookie=0x0, duration=2939.172s, table=0, n_packets=117, n_bytes=8296,
idle_age=58, priority=4, in_port=4, dl_vlan=3
actions=mod_vlan_vid:172, NORMAL
  cookie=0x0, duration=6111.389s, table=0, n_packets=145, n_bytes=9368,
idle_age=98, priority=4, in_port=4, dl_vlan=2
actions=mod_vlan_vid:171, NORMAL
  cookie=0x0, duration=6526.675s, table=0, n_packets=82, n_bytes=6700,
idle_age=2462, priority=2, in_port=4 actions=drop
```

- This packet is then forwarded to physical interface *eth1*.

### 7.2.2. The flow of incoming traffic

- An incoming packet for the instance from external network first reaches *eth1*, then arrives at *br-ex*.
- From *br-ex*, the packet is moved to *br-int* via patch-peer *phy-br-ex <-> int-br-ex*.

The below command shows *int-br-ex* with port number 18:

```
# ovs-ofctl show br-int
18(int-br-ex): addr:fe:b7:cb:03:c5:c1
  config:      0
  state:      0
  speed: 0 Mbps now, 0 Mbps max
```

- When the packet arrives on *int-br-ex*, an OVS flow rule inside *br-int* adds internal VLAN tag 2 for *provider-171* and VLAN tag 3 for *provider-172* to the packet:

```
# ovs-ofctl dump-flows br-int
NXST_FLOW reply (xid=0x4):
  cookie=0x0, duration=6770.572s, table=0, n_packets=1239, n_bytes=127795,
idle_age=106, priority=1 actions=NORMAL
  cookie=0x0, duration=3181.679s, table=0, n_packets=2605, n_bytes=246456,
idle_age=0, priority=3, in_port=18, dl_vlan=172
actions=mod_vlan_vid:3, NORMAL
  cookie=0x0, duration=6353.898s, table=0, n_packets=5077, n_bytes=482582,
idle_age=0, priority=3, in_port=18, dl_vlan=171
actions=mod_vlan_vid:2, NORMAL
  cookie=0x0, duration=6769.391s, table=0, n_packets=22301,
n_bytes=2013101, idle_age=0, priority=2, in_port=18 actions=drop
  cookie=0x0, duration=6770.463s, table=23, n_packets=0, n_bytes=0,
idle_age=6770, priority=0 actions=drop
```

The second rule says a packet that arrives on *int-br-ex* (*in\_port=18*) which has VLAN tag 172 in it (*dl\_vlan=172*), replace VLAN tag with 3 (*actions=mod\_vlan\_vid:3, NORMAL*) and forward. The third rule says a packet that arrives on *int-br-ex* (*in\_port=18*) which has VLAN tag 171 in it (*dl\_vlan=171*), replace VLAN tag with 2 (*actions=mod\_vlan\_vid:2, NORMAL*) and forward.

- With the internal VLAN tag added to the packet, *qvovxx* accepts it and forwards it on to *qvbx* (after stripping the VLAN tag), after which the packet then reaches the instance.

Note that the VLAN tag 2 and 3 is an example that was used on a test Compute node for the VLAN provider networks (provider-171 and provider-172). The required configuration may be different for your VLAN provider network, and can also be different for the same network on two different Compute nodes.

### 7.2.3. Troubleshooting

Refer to the packet flow described in the section above when troubleshooting connectivity in a VLAN provider network. In addition, review the following configuration options:

1. Verify that physical network name is used consistently. In this example, `physnet1` is used consistently while creating the network, and within the `bridge_mapping` configuration:

```
# grep bridge_mapping /etc/neutron/plugins/ml2/openvswitch_agent.ini
bridge_mappings = physnet1:br-ex

# neutron net-show provider-vlan171
...
| provider:physical_network | physnet1
...
```

2. Confirm that the network was created as `external`, is type `vlan`, and uses the correct `segmentation_id` value:

```
# neutron net-show provider-vlan171
...
| provider:network_type      | vlan          |
| provider:physical_network | physnet1     |
| provider:segmentation_id  | 171          |
...
```

3. Run `ovs-vsctl show` and verify that `br-int` and `br-ex` are connected using the patch-peer `int-br-ex <-> phy-br-ex`.

This connection is created while restarting `neutron-openvswitch-agent`, provided that the `bridge_mapping` is correctly configured in `/etc/neutron/plugins/ml2/openvswitch_agent.ini`.

Recheck the `bridge_mapping` setting if this is not created even after restarting the service.

4. To review the flow of outgoing packets, run `ovs-ofctl dump-flows br-ex` and `ovs-ofctl dump-flows br-int`, and verify that the flows map the internal VLAN IDs to the external VLAN ID (`segmentation_id`). For incoming packets, map the external VLAN ID to the internal VLAN ID. This flow is added by the neutron OVS agent when you spawn an instance to this network for the first time. If this flow is not created after spawning the instance, make sure that the network is created as `vlan`, is `external`, and that the `physical_network` name is correct. In addition, re-check the `bridge_mapping` settings.

5. Finally, re-check the `ifcfg-br-ex` and `ifcfg-ethx` configuration. Make sure that `ethX` is added as a port inside `br-ex`, and that both of them have `UP` flag in the output of the `ip` a command.

For example, the output below shows that `eth1` is a port in `br-ex`.

```
Bridge br-ex
  Port phy-br-ex
    Interface phy-br-ex
      type: patch
```

```
        options: {peer=int-br-ex}  
Port "eth1"  
Interface "eth1"
```

The command below shows that *eth1* has been added as a port, and that the kernel is aware to move all packets from the interface to the OVS bridge *br-ex*. This is demonstrated by the entry: `master ovs-system`.

```
# ip a  
5: eth1: <BROADCAST,MULTICAST,UP,LOWER_UP> mtu 1500 qdisc mq master ovs-  
system state UP qlen 1000
```

### 7.3. Enable Compute metadata access

Instances connected in this way are directly attached to the provider external networks, and have external routers configured as their default gateway; no OpenStack Networking (neutron) routers are used. This means that *neutron* routers cannot be used to proxy metadata requests from instances to the *nova-metadata* server, which may result in failures while running *cloud-init*. However, this issue can be resolved by configuring the dhcp agent to proxy metadata requests. You can enable this functionality in `/etc/neutron/dhcp_agent.ini`. For example:

```
enable_isolated_metadata = True
```

### 7.4. Floating IP addresses

Note that the same network can be used to allocate floating IP addresses to instances, even if they have been added to private networks at the same time. The addresses allocated as floating IPs from this network will be bound to the *qrouter-xxx* namespace on the Network node, and will perform *DNAT-SNAT* to the associated private IP address. In contrast, the IP addresses allocated for direct external network access will be bound directly inside the instance, and allow the instance to communicate directly with external network.



## CHAPTER 8. CONFIGURE PHYSICAL SWITCHES FOR OPENSTACK NETWORKING

This chapter documents the common physical switch configuration steps required for OpenStack Networking. Vendor-specific configuration is included for the following switches:

- [Cisco Catalyst](#)
- [Cisco Nexus](#)
- [Cumulus Linux](#)
- [Extreme Networks EXOS](#)
- [Juniper EX Series](#)

### 8.1. Planning your physical network environment

The physical network adapters in your OpenStack nodes can be expected to carry different types of network traffic, such as instance traffic, storage data, or authentication requests. The type of traffic these NICs will carry affects how their ports are configured on the physical switch.

As a first step, you will need to decide which physical NICs on your Compute node will carry which types of traffic. Then, when the NIC is cabled to a physical switch port, that switch port will need to be specially configured to allow trunked or general traffic.

For example, this diagram depicts a Compute node with two NICs, eth0 and eth1. Each NIC is cabled to a Gigabit Ethernet port on a physical switch, with eth0 carrying instance traffic, and eth1 providing connectivity for OpenStack services:

#### Sample network layout

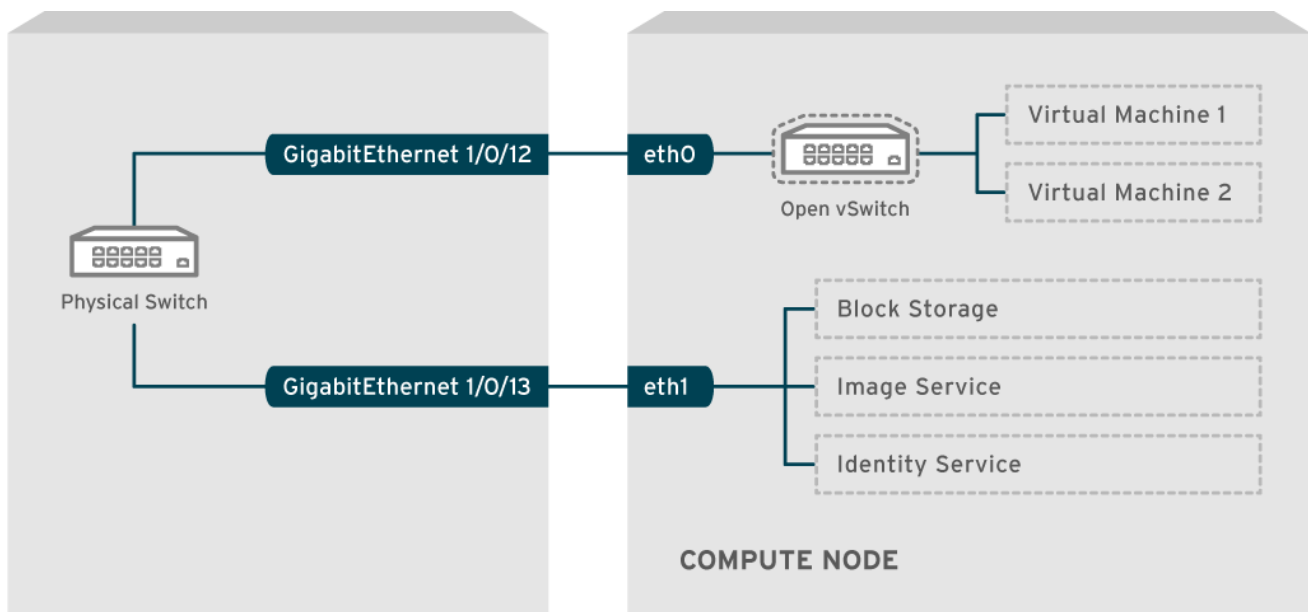

OPENSTACK\_377160\_1115

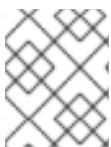

#### NOTE

This diagram does not include any additional redundant NICs required for fault tolerance.

## 8.2. Configure a Cisco Catalyst switch

### 8.2.1. Configure trunk ports

OpenStack Networking allows instances to connect to the VLANs that already exist on your physical network. The term *trunk* is used to describe a port that allows multiple VLANs to traverse through the same port. As a result, VLANs can span across multiple switches, including virtual switches. For example, traffic tagged as **VLAN110** in the physical network can arrive at the Compute node, where the 8021q module will direct the tagged traffic to the appropriate VLAN on the vSwitch.

#### 8.2.1.1. Configure trunk ports for a Cisco Catalyst switch

If using a Cisco Catalyst switch running Cisco IOS, you might use the following configuration syntax to allow traffic for VLANs 110 and 111 to pass through to your instances. This configuration assumes that your physical node has an ethernet cable connected to interface **GigabitEthernet1/0/12** on the physical switch.

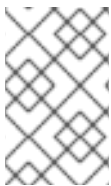

#### NOTE

These values are examples only. Simply copying and pasting into your switch configuration without adjusting the values first will likely result in an unexpected outage.

```
interface GigabitEthernet1/0/12
  description Trunk to Compute Node
  spanning-tree portfast trunk
  switchport trunk encapsulation dot1q
  switchport mode trunk
  switchport trunk native vlan 2
  switchport trunk allowed vlan 2,110,111
```

These settings are described below:

Field	Description
<b>interface GigabitEthernet1/0/12</b>	The switch port that the node's NIC is plugged into. This is just an example, so it is important to first verify that you are configuring the correct port here. You can use the <code>show interface</code> command to view a list of ports.
<b>description Trunk to Compute Node</b>	The description that appears when listing all interfaces using the <code>show interface</code> command. Should be descriptive enough to let someone understand which system is plugged into this port, and what the connection's intended function is.
<b>spanning-tree portfast trunk</b>	Assuming your environment uses STP, tells Port Fast that this port is used to trunk traffic.

Field	Description
<code>switchport trunk encapsulation dot1q</code>	Enables the 802.1q trunking standard (rather than ISL). This will vary depending on what your switch supports.
<code>switchport mode trunk</code>	Configures this port as a trunk port, rather than an access port, meaning that it will allow VLAN traffic to pass through to the virtual switches.
<code>switchport trunk native vlan 2</code>	Setting a native VLAN tells the switch where to send untagged (non-VLAN) traffic.
<code>switchport trunk allowed vlan 2,110,111</code>	Defines which VLANs are allowed through the trunk.

### 8.2.2. Configure access ports

Not all NICs on your Compute node will carry instance traffic, and so do not need to be configured to allow multiple VLANs to pass through. These ports require only one VLAN to be configured, and might fulfill other operational requirements, such as transporting management traffic or Block Storage data. These ports are commonly known as access ports and usually require a simpler configuration than trunk ports.

#### 8.2.2.1. Configure access ports for a Cisco Catalyst switch

Using the example from the [Sample network layout](#) diagram, GigabitEthernet1/0/13 (on a Cisco Catalyst switch) is configured as an access port for eth1. This configuration assumes that your physical node has an ethernet cable connected to interface `GigabitEthernet1/0/12` on the physical switch.



#### NOTE

These values are examples only. Simply copying and pasting into your switch configuration without adjusting the values first will likely result in an unexpected outage.

```
interface GigabitEthernet1/0/13
  description Access port for Compute Node
  switchport mode access
  switchport access vlan 200
  spanning-tree portfast
```

These settings are described below:

Field	Description
-------	-------------

Field	Description
<code>interface GigabitEthernet1/0/13</code>	The switch port that the node's NIC is plugged into. The interface value is just an example, so it is important to first verify that you are configuring the correct port here. You can use the <code>show interface</code> command to view a list of ports.
<code>description Access port for Compute Node</code>	The description that appears when listing all interfaces using the <code>show interface</code> command. Should be descriptive enough to let someone understand which system is plugged into this port, and what the connection's intended function is.
<code>switchport mode access</code>	Configures this port as an access port, rather than a trunk port.
<code>switchport access vlan 200</code>	Configures the port to allow traffic on VLAN 200. Your Compute node should also be configured with an IP address from this VLAN.
<code>spanning-tree portfast</code>	If using STP, this tells STP not to attempt to initialize this as a trunk, allowing for quicker port handshakes during initial connections (such as server reboot).

### 8.2.3. Configure LACP port aggregation

LACP allows you to bundle multiple physical NICs together to form a single logical channel. Also known as 802.3ad (or bonding mode 4 in Linux), LACP creates a dynamic bond for load-balancing and fault tolerance. LACP must be configured at both physical ends: on the physical NICs, and on the physical switch ports.

#### 8.2.3.1. Configure LACP on the physical NIC

1. Edit the `/home/stack/network-environment.yaml` file:

```
- type: linux_bond
  name: bond1
  mtu: 9000
  bonding_options:{get_param: BondInterface0vsOptions};
  members:
    - type: interface
      name: nic3
      mtu: 9000
      primary: true
    - type: interface
      name: nic4
      mtu: 9000
```

2. Configure the Open vSwitch bridge to use LACP:

```
BondInterface0vsOptions:
  "mode=802.3ad"
```

For information on configuring network bonds, see the [Advanced Overcloud Customization](#) guide.

### 8.2.3.2. Configure LACP on a Cisco Catalyst switch

In this example, the Compute node has two NICs using VLAN 100:

1. Physically connect the Compute node's two NICs to the switch (for example, ports 12 and 13).
2. Create the LACP port channel:

```
interface port-channel1
  switchport access vlan 100
  switchport mode access
  spanning-tree guard root
```

3. Configure switch ports 12 (Gi1/0/12) and 13 (Gi1/0/13):

```
sw01# config t
Enter configuration commands, one per line.  End with CNTL/Z.

sw01(config) interface GigabitEthernet1/0/12
  switchport access vlan 100
  switchport mode access
  speed 1000
  duplex full
  channel-group 10 mode active
  channel-protocol lacp

interface GigabitEthernet1/0/13
  switchport access vlan 100
  switchport mode access
  speed 1000
  duplex full
  channel-group 10 mode active
  channel-protocol lacp
```

4. Review your new port channel. The resulting output lists the new port-channel **Po1**, with member ports **Gi1/0/12** and **Gi1/0/13**:

```
sw01# show etherchannel summary
<snip>

Number of channel-groups in use: 1
Number of aggregators:          1

Group  Port-channel  Protocol    Ports
-----+-----+-----+-----
-----
1      Po1(SD)          LACP        Gi1/0/12(D) Gi1/0/13(D)
```

**NOTE**

Remember to apply your changes by copying the running-config to the startup-config:  
**copy running-config startup-config.**

**8.2.4. Configure MTU settings**

Certain types of network traffic might require that you adjust your MTU size. For example, jumbo frames (9000 bytes) might be suggested for certain NFS or iSCSI traffic.

**NOTE**

MTU settings must be changed from end-to-end (on all hops that the traffic is expected to pass through), including any virtual switches. For information on changing the MTU in your OpenStack environment, see [Chapter 9, Configure MTU Settings](#).

**8.2.4.1. Configure MTU settings on a Cisco Catalyst switch**

This example enables jumbo frames on your Cisco Catalyst 3750 switch.

**1. Review the current MTU settings:**

```
sw01# show system mtu

System MTU size is 1600 bytes
System Jumbo MTU size is 1600 bytes
System Alternate MTU size is 1600 bytes
Routing MTU size is 1600 bytes
```

**2. MTU settings are changed switch-wide on 3750 switches, and not for individual interfaces. This command configures the switch to use jumbo frames of 9000 bytes. If your switch supports it, you might prefer to configure the MTU settings for individual interfaces.**

```
sw01# config t
Enter configuration commands, one per line. End with CNTL/Z.

sw01(config)# system mtu jumbo 9000
Changes to the system jumbo MTU will not take effect until the next reload
is done
```

**NOTE**

Remember to save your changes by copying the running-config to the startup-config:  
**copy running-config startup-config.**

**3. When possible, reload the switch to apply the change. This will result in a network outage for any devices that are dependent on the switch.**

```
sw01# reload
Proceed with reload? [confirm]
```

4. When the switch has completed its reload operation, confirm the new jumbo MTU size. The exact output may differ depending on your switch model. For example, *System MTU* might apply to non-Gigabit interfaces, and *Jumbo MTU* might describe all Gigabit interfaces.

```
sw01# show system mtu

System MTU size is 1600 bytes
System Jumbo MTU size is 9000 bytes
System Alternate MTU size is 1600 bytes
Routing MTU size is 1600 bytes
```

### 8.2.5. Configure LLDP discovery

The `ironic-python-agent` service listens for LLDP packets from connected switches. The collected information can include the switch name, port details, and available VLANs. Similar to Cisco Discovery Protocol (CDP), LLDP assists with the discovery of physical hardware during director's `introspection` process.

#### 8.2.5.1. Configure LLDP on a Cisco Catalyst switch

1. Use `lldp run` to enable LLDP globally on your Cisco Catalyst switch:

```
sw01# config t
Enter configuration commands, one per line. End with CNTL/Z.

sw01(config)# lldp run
```

2. View any neighboring LLDP-compatible devices:

```
sw01# show lldp neighbor
Capability codes:
  (R) Router, (B) Bridge, (T) Telephone, (C) DOCSIS Cable Device
  (W) WLAN Access Point, (P) Repeater, (S) Station, (O) Other

Device ID                Local Intf      Hold-time  Capability      Port ID
DEP42037061562G3        Gi1/0/11       180        B,T
422037061562G3:P1

Total entries displayed: 1
```



#### NOTE

Remember to save your changes by copying the running-config to the startup-config: `copy running-config startup-config`.

## 8.3. Configure a Cisco Nexus switch

### 8.3.1. Configure trunk ports

OpenStack Networking allows instances to connect to the VLANs that already exist on your physical network. The term *trunk* is used to describe a port that allows multiple VLANs to traverse through the same port. As a result, VLANs can span across multiple switches, including virtual switches. For

example, traffic tagged as **VLAN110** in the physical network can arrive at the Compute node, where the 8021q module will direct the tagged traffic to the appropriate VLAN on the vSwitch.

### 8.3.1.1. Configure trunk ports for a Cisco Nexus switch

If using a Cisco Nexus you might use the following configuration syntax to allow traffic for VLANs 110 and 111 to pass through to your instances. This configuration assumes that your physical node has an ethernet cable connected to interface **Ethernet1/12** on the physical switch.



#### NOTE

These values are examples only. Simply copying and pasting into your switch configuration without adjusting the values first will likely result in an unexpected outage.

```
interface Ethernet1/12
  description Trunk to Compute Node
  switchport mode trunk
  switchport trunk allowed vlan 2,110,111
  switchport trunk native vlan 2
end
```

### 8.3.2. Configure access ports

Not all NICs on your Compute node will carry instance traffic, and so do not need to be configured to allow multiple VLANs to pass through. These ports require only one VLAN to be configured, and might fulfill other operational requirements, such as transporting management traffic or Block Storage data. These ports are commonly known as access ports and usually require a simpler configuration than trunk ports.

#### 8.3.2.1. Configure access ports for a Cisco Nexus switch

Using the example from the [Sample network layout](#) diagram, Ethernet1/13 (on a Cisco Nexus switch) is configured as an access port for eth1. This configuration assumes that your physical node has an ethernet cable connected to interface **Ethernet1/13** on the physical switch.



#### NOTE

These values are examples only. Simply copying and pasting into your switch configuration without adjusting the values first will likely result in an unexpected outage.

```
interface Ethernet1/13
  description Access port for Compute Node
  switchport mode access
  switchport access vlan 200
```

### 8.3.3. Configure LACP port aggregation

LACP allows you to bundle multiple physical NICs together to form a single logical channel. Also known as 802.3ad (or bonding mode 4 in Linux), LACP creates a dynamic bond for load-balancing and fault tolerance. LACP must be configured at both physical ends: on the physical NICs, and on the physical



switch ports.

### 8.3.3.1. Configure LACP on the physical NIC

1. Edit the `/home/stack/network-environment.yaml` file:

```
- type: linux_bond
  name: bond1
  mtu: 9000
  bonding_options:{get_param: BondInterface0vsOptions};
  members:
    - type: interface
      name: nic3
      mtu: 9000
      primary: true
    - type: interface
      name: nic4
      mtu: 9000
```

2. Configure the Open vSwitch bridge to use LACP:

```
BondInterface0vsOptions:
  "mode=802.3ad"
```

For information on configuring network bonds, see the [Advanced Openstack Customization](#) guide.

### 8.3.3.2. Configure LACP on a Cisco Nexus switch

In this example, the Compute node has two NICs using VLAN 100:

1. Physically connect the Compute node's two NICs to the switch (for example, ports 12 and 13).

2. Confirm that LACP is enabled:

```
(config)# show feature | include lacp
lacp                1                enabled
```

3. Configure ports 1/12 and 1/13 as access ports, and as members of a channel group. Depending on your deployment, you might deploy to use trunk interfaces rather than access interfaces. For example, for Cisco UCI the NICs are virtual interfaces, so you might prefer to set up all access ports. In addition, there will likely be VLAN tagging configured on the interfaces.

```
interface Ethernet1/13
  description Access port for Compute Node
  switchport mode access
  switchport access vlan 200
  channel-group 10 mode active

interface Ethernet1/13
  description Access port for Compute Node
  switchport mode access
  switchport access vlan 200
  channel-group 10 mode active
```

### 8.3.4. Configure MTU settings

Certain types of network traffic might require that you adjust your MTU size. For example, jumbo frames (9000 bytes) might be suggested for certain NFS or iSCSI traffic.



#### NOTE

MTU settings must be changed from end-to-end (on all hops that the traffic is expected to pass through), including any virtual switches. For information on changing the MTU in your OpenStack environment, see [Chapter 9, Configure MTU Settings](#).

#### 8.3.4.1. Configure MTU settings on a Cisco Nexus 7000 switch

MTU settings can be applied to a single interface on 7000-series switches. These commands configure interface 1/12 to use jumbo frames of 9000 bytes:

```
interface ethernet 1/12
  mtu 9216
  exit
```

### 8.3.5. Configure LLDP discovery

The `ironic-python-agent` service listens for LLDP packets from connected switches. The collected information can include the switch name, port details, and available VLANs. Similar to Cisco Discovery Protocol (CDP), LLDP assists with the discovery of physical hardware during director's `introspection` process.

#### 8.3.5.1. Configure LLDP on a Cisco Nexus 7000 switch

LLDP can be enabled for individual interfaces on Cisco Nexus 7000-series switches:

```
interface ethernet 1/12
  lldp transmit
  lldp receive
  no lacp suspend-individual
  no lacp graceful-convergence

interface ethernet 1/13
  lldp transmit
  lldp receive
  no lacp suspend-individual
  no lacp graceful-convergence
```



#### NOTE

Remember to save your changes by copying the running-config to the startup-config: `copy running-config startup-config`.

## 8.4. Configure a Cumulus Linux switch

### 8.4.1. Configure trunk ports

OpenStack Networking allows instances to connect to the VLANs that already exist on your physical

network. The term *trunk* is used to describe a port that allows multiple VLANs to traverse through the same port. As a result, VLANs can span across multiple switches, including virtual switches. For example, traffic tagged as **VLAN110** in the physical network can arrive at the Compute node, where the 8021q module will direct the tagged traffic to the appropriate VLAN on the vSwitch.

#### 8.4.1.1. Configure trunk ports for a Cumulus Linux switch

If using a Cumulus Linux switch, you might use the following configuration syntax to allow traffic for VLANs 100 and 200 to pass through to your instances. This configuration assumes that your physical node has transceivers connected to switch ports **swp1** and **swp2** on the physical switch.



#### NOTE

These values are examples only. Simply copying and pasting into your switch configuration without adjusting the values first will likely result in an unexpected outage.

```
auto bridge
iface bridge
    bridge-vlan-aware yes
    bridge-ports glob swp1-2
    bridge-vids 100 200
```

#### 8.4.2. Configure access ports

Not all NICs on your Compute node will carry instance traffic, and so do not need to be configured to allow multiple VLANs to pass through. These ports require only one VLAN to be configured, and might fulfill other operational requirements, such as transporting management traffic or Block Storage data. These ports are commonly known as access ports and usually require a simpler configuration than trunk ports.

##### 8.4.2.1. Configuring access ports for a Cumulus Linux switch

Using the example from the [Sample network layout](#) diagram, **swp1** (on a Cumulus Linux switch) is configured as an access port. This configuration assumes that your physical node has an ethernet cable connected to the interface on the physical switch. Cumulus Linux switches use **eth** for management interfaces and **swp** for access/trunk ports.



#### NOTE

These values are examples only. Simply copying and pasting into your switch configuration without adjusting the values first will likely result in an unexpected outage.

```
auto bridge
iface bridge
    bridge-vlan-aware yes
    bridge-ports glob swp1-2
    bridge-vids 100 200
```

```
auto swp1
iface swp1
```

```

bridge-access 100

auto swp2
iface swp2
    bridge-access 200

```

### 8.4.3. Configure LACP port aggregation

LACP allows you to bundle multiple physical NICs together to form a single logical channel. Also known as 802.3ad (or bonding mode 4 in Linux), LACP creates a dynamic bond for load-balancing and fault tolerance. LACP must be configured at both physical ends: on the physical NICs, and on the physical switch ports.

#### 8.4.3.1. Configure LACP on the physical NIC

There is no need to configure the physical NIC in Cumulus Linux.

#### 8.4.3.2. Configure LACP on a Cumulus Linux switch

To configure the bond, edit `/etc/network/interfaces` and add a stanza for `bond0`:

```

auto bond0
iface bond0
    address 10.0.0.1/30
    bond-slaves swp1 swp2 swp3 swp4

```



#### NOTE

Remember to apply your changes by reloading the updated configuration: `sudo ifreload -a`

### 8.4.4. Configure MTU settings

Certain types of network traffic might require that you adjust your MTU size. For example, jumbo frames (9000 bytes) might be suggested for certain NFS or iSCSI traffic.

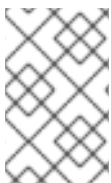

#### NOTE

MTU settings must be changed from end-to-end (on all hops that the traffic is expected to pass through), including any virtual switches. For information on changing the MTU in your OpenStack environment, see [Chapter 9, Configure MTU Settings](#).

#### 8.4.4.1. Configure MTU settings on a Cumulus Linux switch

This example enables jumbo frames on your Cumulus Linux switch.

```

auto swp1
iface swp1
    mtu 9000

```

Remember to apply your changes by reloading the updated configuration: `sudo ifreload -a`

### 8.4.5. Configure LLDP discovery

By default, the LLDP service, `lldpd`, runs as a daemon and starts when the switch boots.

To view all LLDP neighbors on all ports/interfaces:

```
cumulus@switch$ netshow lldp
Local Port  Speed  Mode           Remote Port  Remote Host Summary
-----
eth0        10G    Mgmt           ===== swp6  mgmt-sw  IP:
10.0.1.11/24
swp51       10G    Interface/L3   ===== swp1  spine01  IP:
10.0.0.11/32
swp52       10G    Interface/L    ===== swp1  spine02  IP:
10.0.0.11/32
```

## 8.5. Configure an Extreme Networks EXOS switch

### 8.5.1. Configure trunk ports

OpenStack Networking allows instances to connect to the VLANs that already exist on your physical network. The term *trunk* is used to describe a port that allows multiple VLANs to traverse through the same port. As a result, VLANs can span across multiple switches, including virtual switches. For example, traffic tagged as **VLAN110** in the physical network can arrive at the Compute node, where the 8021q module will direct the tagged traffic to the appropriate VLAN on the vSwitch.

#### 8.5.1.1. Configure trunk ports on an Extreme Networks EXOS switch

If using an X-670 series switch, you might refer to the following example to allow traffic for VLANs 110 and 111 to pass through to your instances. This configuration assumes that your physical node has an ethernet cable connected to interface **24** on the physical switch. In this example, **DATA** and **MNGT** are the VLAN names.



#### NOTE

These values are examples only. Simply copying and pasting into your switch configuration without adjusting the values first will likely result in an unexpected outage.

```
#create vlan DATA tag 110
#create vlan MNGT tag 111
#configure vlan DATA add ports 24 tagged
#configure vlan MNGT add ports 24 tagged
```

### 8.5.2. Configure access ports

Not all NICs on your Compute node will carry instance traffic, and so do not need to be configured to allow multiple VLANs to pass through. These ports require only one VLAN to be configured, and might fulfill other operational requirements, such as transporting management traffic or Block Storage data. These ports are commonly known as access ports and usually require a simpler configuration than trunk ports.

#### 8.5.2.1. Configure access ports for an Extreme Networks EXOS switch

To continue the example from the diagram above, this example configures 10 (on a Extreme Networks X-670 series switch) as an access port for eth1. you might use the following configuration to allow traffic for VLANs 110 and 111 to pass through to your instances. This configuration assumes that your physical node has an ethernet cable connected to interface 10 on the physical switch.



## NOTE

These values are examples only. Simply copying and pasting into your switch configuration without adjusting the values first will likely result in an unexpected outage.

```
create vlan VLANNAME tag NUMBER
configure vlan Default delete ports PORTSTRING
configure vlan VLANNAME add ports PORTSTRING untagged
```

For example:

```
#create vlan DATA tag 110
#configure vlan Default delete ports 10
#configure vlan DATA add ports 10 untagged
```

### 8.5.3. Configure LACP port aggregation

LACP allows you to bundle multiple physical NICs together to form a single logical channel. Also known as 802.3ad (or bonding mode 4 in Linux), LACP creates a dynamic bond for load-balancing and fault tolerance. LACP must be configured at both physical ends: on the physical NICs, and on the physical switch ports.

#### 8.5.3.1. Configure LACP on the physical NIC

1. Edit the `/home/stack/network-environment.yaml` file:

```
- type: linux_bond
  name: bond1
  mtu: 9000
  bonding_options: {get_param: BondInterface0vsOptions};
  members:
    - type: interface
      name: nic3
      mtu: 9000
      primary: true
    - type: interface
      name: nic4
      mtu: 9000
```

2. Configure the Open vSwitch bridge to use LACP:

```
BondInterface0vsOptions:
  "mode=802.3ad"
```

For information on configuring network bonds, see the [Advanced Overcloud Customization](#) guide.

### 8.5.3.2. Configure LACP on an Extreme Networks EXOS switch

In this example, the Compute node has two NICs using VLAN 100:

```
enable sharing MASTERPORT grouping ALL_LAG_PORTS lacp
configure vlan VLANNAME add ports PORTSTRING tagged
```

For example:

```
#enable sharing 11 grouping 11,12 lacp
#configure vlan DATA add port 11 untagged
```



#### NOTE

You might need to adjust the timeout period in the LACP negotiation script. For more information, see

[https://gtacknowledge.extremenetworks.com/articles/How\\_To/LACP-configured-ports-interfere-with-PXE-DHCP-on-servers](https://gtacknowledge.extremenetworks.com/articles/How_To/LACP-configured-ports-interfere-with-PXE-DHCP-on-servers)

### 8.5.4. Configure MTU settings

Certain types of network traffic might require that you adjust your MTU size. For example, jumbo frames (9000 bytes) might be suggested for certain NFS or iSCSI traffic.



#### NOTE

MTU settings must be changed from end-to-end (on all hops that the traffic is expected to pass through), including any virtual switches. For information on changing the MTU in your OpenStack environment, see [Chapter 9, Configure MTU Settings](#).

#### 8.5.4.1. Configure MTU settings on an Extreme Networks EXOS switch

The example enables jumbo frames on any Extreme Networks EXOS switch, and supports forwarding IP packets with 9000 bytes:

```
enable jumbo-frame ports PORTSTRING
configure ip-mtu 9000 vlan VLANNAME
```

For example:

```
# enable jumbo-frame ports 11
# configure ip-mtu 9000 vlan DATA
```

### 8.5.5. Configure LLDP discovery

The `ironic-python-agent` service listens for LLDP packets from connected switches. The collected information can include the switch name, port details, and available VLANs. Similar to Cisco Discovery Protocol (CDP), LLDP assists with the discovery of physical hardware during director's **introspection** process.

#### 8.5.5.1. Configure LLDP settings on an Extreme Networks EXOS switch

The example allows configuring LLDP settings on any Extreme Networks EXOS switch. In this example, **11** represents the port string:

```
enable lldp ports 11
```

## 8.6. Configure a Juniper EX Series switch

### 8.6.1. Configure trunk ports

OpenStack Networking allows instances to connect to the VLANs that already exist on your physical network. The term *trunk* is used to describe a port that allows multiple VLANs to traverse through the same port. As a result, VLANs can span across multiple switches, including virtual switches. For example, traffic tagged as **VLAN110** in the physical network can arrive at the Compute node, where the 8021q module will direct the tagged traffic to the appropriate VLAN on the vSwitch.

#### 8.6.1.1. Configure trunk ports on the Juniper EX Series switch

If using a Juniper EX series switch running Juniper JunOS, you might use the following configuration to allow traffic for VLANs **110** and **111** to pass through to your instances. This configuration assumes that your physical node has an ethernet cable connected to interface **ge-1/0/12** on the physical switch.



#### NOTE

These values are examples only. Simply copying and pasting into your switch configuration without adjusting the values first will likely result in an unexpected outage.

```
ge-1/0/12 {
    description Trunk to Compute Node;
    unit 0 {
        family ethernet-switching {
            port-mode trunk;
            vlan {
                members [110 111];
            }
            native-vlan-id 2;
        }
    }
}
```

### 8.6.2. Configure access ports

Not all NICs on your Compute node will carry instance traffic, and so do not need to be configured to allow multiple VLANs to pass through. These ports require only one VLAN to be configured, and might fulfill other operational requirements, such as transporting management traffic or Block Storage data. These ports are commonly known as access ports and usually require a simpler configuration than trunk ports.

#### 8.6.2.1. Configure access ports for a Juniper EX Series switch



To continue the example from the diagram above, this example configures ge-1/0/13 (on a Juniper EX series switch) as an access port for eth1. This configuration assumes that your physical node has an ethernet cable connected to interface ge-1/0/13 on the physical switch.



## NOTE

These values are examples only. Simply copying and pasting into your switch configuration without adjusting the values first will likely result in an unexpected outage.

```
ge-1/0/13 {
    description Access port for Compute Node
    unit 0 {
        family ethernet-switching {
            port-mode access;
            vlan {
                members 200;
            }
            native-vlan-id 2;
        }
    }
}
```

### 8.6.3. Configure LACP port aggregation

LACP allows you to bundle multiple physical NICs together to form a single logical channel. Also known as 802.3ad (or bonding mode 4 in Linux), LACP creates a dynamic bond for load-balancing and fault tolerance. LACP must be configured at both physical ends: on the physical NICs, and on the physical switch ports.

#### 8.6.3.1. Configure LACP on the physical NIC

1. Edit the `/home/stack/network-environment.yaml` file:

```
- type: linux_bond
  name: bond1
  mtu: 9000
  bonding_options: {get_param: BondInterface0vsOptions};
  members:
    - type: interface
      name: nic3
      mtu: 9000
      primary: true
    - type: interface
      name: nic4
      mtu: 9000
```

2. Configure the Open vSwitch bridge to use LACP:

```
BondInterface0vsOptions:
  "mode=802.3ad"
```

For information on configuring network bonds, see the [Advanced OpenStack Customization](#) guide.

### 8.6.3.2. Configure LACP on a Juniper EX Series switch

In this example, the Compute node has two NICs using VLAN 100:

1. Physically connect the Compute node's two NICs to the switch (for example, ports 12 and 13).
2. Create the port aggregate:

```
chassis {
  aggregated-devices {
    ethernet {
      device-count 1;
    }
  }
}
```

3. Configure switch ports 12 (ge-1/0/12) and 13 (ge-1/0/13) to join the port aggregate `ae1`:

```
interfaces {
  ge-1/0/12 {
    gigether-options {
      802.3ad ae1;
    }
  }
  ge-1/0/13 {
    gigether-options {
      802.3ad ae1;
    }
  }
}
```



#### NOTE

For Red Hat OpenStack Platform director deployments, in order to PXE boot from the bond, you need to set one of the bond members as `lacp force-up`. This will ensure that one bond member only comes up during introspection and first boot. The bond member set with `lacp force-up` should be the same bond member that has the MAC address in `instackenv.json` (the MAC address known to `ironic` must be the same MAC address configured with `force-up`).

4. Enable LACP on port aggregate `ae1`:

```
interfaces {
  ae1 {
    aggregated-ether-options {
      lacp {
        active;
      }
    }
  }
}
```

5. Add aggregate `ae1` to VLAN 100:



```

interfaces {
  ae1 {
    vlan-tagging;
    native-vlan-id 2;
    unit 100 {
      vlan-id 100;
    }
  }
}

```

6. Review your new port channel. The resulting output lists the new port aggregate `ae1` with member ports `ge-1/0/12` and `ge-1/0/13`:

```

> show lacp statistics interfaces ae1

Aggregated interface: ae1
LACP Statistics: LACP Rx LACP Tx Unknown Rx Illegal Rx
ge-1/0/12 0 0 0 0
ge-1/0/13 0 0 0 0

```

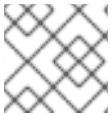

#### NOTE

Remember to apply your changes by running the `commit` command.

### 8.6.4. Configure MTU settings

Certain types of network traffic might require that you adjust your MTU size. For example, jumbo frames (9000 bytes) might be suggested for certain NFS or iSCSI traffic.

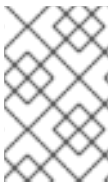

#### NOTE

MTU settings must be changed from end-to-end (on all hops that the traffic is expected to pass through), including any virtual switches. For information on changing the MTU in your OpenStack environment, see [Chapter 9, Configure MTU Settings](#).

#### 8.6.4.1. Configure MTU settings on a Juniper EX Series switch

This example enables jumbo frames on your Juniper EX4200 switch.



#### NOTE

The MTU value is calculated differently depending on whether you are using Juniper or Cisco devices. For example, **9216** on Juniper would equal to **9202** for Cisco. The extra bytes are used for L2 headers, where Cisco adds this automatically to the MTU value specified, but the usable MTU will be 14 bytes smaller than specified when using Juniper. So in order to support an MTU of **9000** on the VLANs, the MTU of **9014** would have to be configured on Juniper.

1. For Juniper EX series switches, MTU settings are set for individual interfaces. These commands configure jumbo frames on the `ge-1/0/14` and `ge-1/0/15` ports:

```

set interfaces ge-1/0/14 mtu 9216
set interfaces ge-1/0/15 mtu 9216

```

**NOTE**

Remember to save your changes by running the `commit` command.

2. If using a LACP aggregate, you will need to set the MTU size there, and not on the member NICs. For example, this setting configures the MTU size for the `ae1` aggregate:

```
set interfaces ae1 mtu 9216
```

### 8.6.5. Configure LLDP discovery

The `ironic-python-agent` service listens for LLDP packets from connected switches. The collected information can include the switch name, port details, and available VLANs. Similar to Cisco Discovery Protocol (CDP), LLDP assists with the discovery of physical hardware during director's `introspection` process.

#### 8.6.5.1. Configure LLDP on a Juniper EX Series switch

You can enable LLDP globally for all interfaces, or just for individual ones:

1. For example, to enable LLDP globally on your Juniper EX 4200 switch:

```
lldp {
  interface all{
    enable;
  }
}
```

2. Or, enable LLDP just for the single interface `ge-1/0/14`:

```
lldp {
  interface ge-1/0/14{
    enable;
  }
}
```

**NOTE**

Remember to apply your changes by running the `commit` command.

## PART II. ADVANCED CONFIGURATION

Contains cookbook-style scenarios for advanced OpenStack Networking features.

# CHAPTER 9. CONFIGURE MTU SETTINGS

## 9.1. MTU overview

OpenStack Networking has the ability to calculate the largest possible MTU size that can safely be applied to instances. The MTU value specifies the maximum amount of data a single network packet is able to transfer; this number is variable depending on the most appropriate size for the application. For example, NFS shares might require a different MTU size to that of a VoIP application.



### NOTE

OpenStack Networking is able to calculate the largest possible MTU value, which can then be viewed using the `neutron net -show` command. `net -mtu` is a neutron API extension, so it may be not present in some implementations. The required MTU value can be advertised to DHCPv4 clients for automatic configuration, if supported by the instance, as well as to IPv6 clients through Router Advertisement (RA) packets. Note that for Router Advertisements to be sent, the network should be attached to a router.

MTU settings need to be set consistently from end-to-end in order to work properly. This means that the MTU setting needs to be the same size at every point the packet passes through, including the VM itself, the virtual network infrastructure, the physical network, and the destination server itself.

For example, the circles in the following diagram indicate the various points where an MTU value would need to be adjusted for traffic between an instance and a physical server. Every interface that handles network traffic will need to have its MTU value changed to accommodate packets of a particular MTU size. This will be required if traffic is expected to travel from the instance `192.168.200.15` through to the physical server `10.20.15.25`:

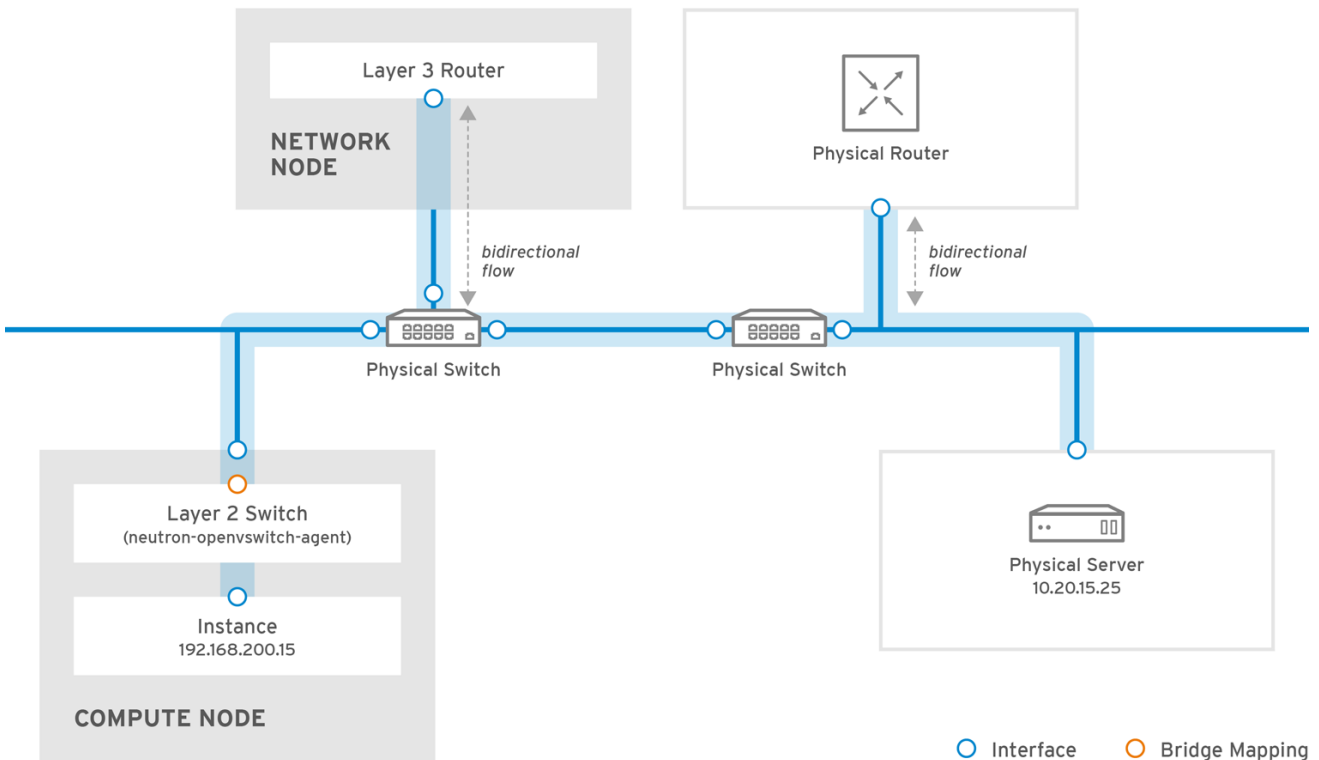

OPENSTACK\_450456\_0617

Inconsistent MTU values can result in several network issues, the most common being random packet loss that results in connection drops and slow network performance. Such issues are problematic to troubleshoot, since every possible network point needs to be identified and examined to ensure it has

the correct MTU value set.

### 9.1.1. Configure MTU advertisement

MTU advertisement eases the MTU configuration process by moving MTU settings into the realm of automated DHCP configuration and/or IPv6 RA configuration. As a result, the optimal MTU size is then advertised to instances using DHCPv4 or IPv6 RA.

MTU advertisement is enabled in `/etc/neutron/neutron.conf`:

```
advertise_mtu = True
```

Note that this option is enabled by default in Mitaka, has been deprecated in Newton, and is likely to be removed in a future release. When set, the tenant network's configured MTU option is advertised to instances using DHCPv4 and IPv6 RAs.



#### NOTE

Not all DHCPv4 clients support the automatic configuration of MTU values.

### 9.1.2. Configure tenant networks

With *Red Hat OpenStack Platform 11* director, you can use a single parameter in the network environment file to define the default MTU for all tenant networks. This will make it easier to align your configuration with the physical MTU:

- **NeutronTenantMtu** - Configures the base MTU that reflects physical network capabilities. Neutron then uses this base value to calculate MTUs for networks it manages. For example, for VLAN and flat networks, the value is used as-is, but for VLXAN and GRE networks, they get lower MTUs to make room for the tunnel header overhead. If using VXLAN/GRE tunneling, then this should be equal to the MTU operating on the physical network.

### 9.1.3. Configure MTU Settings in Director

This example demonstrates how to set the MTU using the NIC config templates. The MTU needs to be set on the bridge, bond (if applicable), interface(s), and VLAN(s):

```
-
  type: ovs_bridge
  name: br-isolated
  use_dhcp: false
  mtu: 9000    # <--- Set MTU
  members:
    -
      type: ovs_bond
      name: bond1
      mtu: 9000    # <--- Set MTU
      ovs_options: {get_param: BondInterfaceOvsOptions}
      members:
        -
          type: interface
          name: ens15f0
          mtu: 9000    # <--- Set MTU
          primary: true
    -
```

```
        type: interface
        name: enp131s0f0
        mtu: 9000    # <--- Set MTU
-
    type: vlan
    device: bond1
    vlan_id: {get_param: InternalApiNetworkVlanID}
    mtu: 9000    # <--- Set MTU
    addresses:
    -
        ip_netmask: {get_param: InternalApiIpSubnet}
-
    type: vlan
    device: bond1
    mtu: 9000    # <--- Set MTU
    vlan_id: {get_param: TenantNetworkVlanID}
    addresses:
    -
        ip_netmask: {get_param: TenantIpSubnet}
```

#### 9.1.4. Review the resulting MTU calculation

View the calculated MTU value. This result is the calculation of the largest possible MTU value that can be used by instances. You can then proceed by configuring this value on all interfaces involved in the path of network traffic.

```
# neutron net-show <network>
```



## CHAPTER 10. CONFIGURE QUALITY-OF-SERVICE (QOS)

Red Hat OpenStack Platform 11 introduces support for network quality-of-service (QoS) policies. These policies allow OpenStack administrators to offer varying service levels by applying rate limits to egress traffic for instances. As a result of implementing a QoS policy, any traffic that exceeds the specified rate is consequently dropped.

### 10.1. QoS Policy Scope

QoS policies are applied to individual ports, or to a particular tenant network, where ports with no specific policy attached will inherit the policy.

### 10.2. QoS Policy Management

QoS policies can be dynamically applied, modified, or removed. This example manually creates a bandwidth limiting rule and applies it to a port.

1. Review the list of tenants and determine the id of where you need to create QoS policy:

```
# openstack project list
+-----+-----+
| ID                | Name      |
+-----+-----+
| 4b0b98f8c6c040f38ba4f7146e8680f5 | auditors  |
| 519e6344f82e4c079c8e2eabb690023b | services  |
| 80bf5732752a41128e612fe615c886c6 | demo      |
| 98a2f53c20ce4d50a40dac4a38016c69 | admin     |
+-----+-----+
```

2. Create a QoS policy named **bw-limiter** in the **admin** tenant:

```
# neutron qos-policy-create 'bw-limiter' --tenant-id
98a2f53c20ce4d50a40dac4a38016c69
```

3. Configure the policing rules for the **bw-limiter** policy:

```
# neutron qos-bandwidth-limit-rule-create bw-limiter --max_kbps 3000
--max_burst_kbps 3000
```

4. Configure a neutron port to apply the **bw-limiter** policy:

```
# neutron port-update <port id> --qos-policy bw-limiter
```

5. Review the QoS rule. For example:

```
# neutron qos-rule-show 9be535c3-daa2-4d7b-88ea-e8de16
+-----+-----+
| Field          | Value                                           |
+-----+-----+
| id             | 9be535c3-daa2-4d7b-88ea-e8de16                |
| rule_type      | bandwidth_limit                                |
| description    |                                                 |
+-----+-----+
```

max_kbps	3000	
max_burst_kbps	300	
+-----+-----+-----+		

These values allow you to configure the policing algorithm accordingly:

- **max\_kbps** - the maximum rate (in Kbps) that the instance is allowed to send.
- **max\_burst\_kbps** - the maximum amount of data (in kbits) that the port could send in a instant if the token buffer was full. The token buffer is replenished at a "max\_kbps" rate.

### 10.3. DSCP Marking for Egress Traffic

Differentiated Services Code Point (DSCP) allows you to to implement QoS on your network by embedding relevant values in the IP headers. OpenStack Networking (neutron) QoS policies can now use DSCP marking to manage egress traffic on neutron ports and networks. At present, DSCP is only available for VLAN and flat provider networks using Open vSwitch (OVS); support for VXLAN is expected to follow.

In this implementation, a policy is first created, then DSCP rules are defined and applied to the policy. These rules use the `--dscp-mark` parameter, which specifies the decimal value of a DSCP mark. For example:

#### 1. Create a new QoS policy:

```
neutron qos-policy-create qos-web-servers --tenant-id
98a2f53c20ce4d50a40dac4a38016c69
```

#### 2. Create a DSCP rule and apply it to the `qos-web-servers` policy, using DSCP mark `18`:

```
neutron qos-dscp-marking-rule-create qos-web-servers --dscp-mark 18
Created a new dscp_marking_rule:
+-----+-----+-----+
| Field      | Value                                     |
+-----+-----+-----+
| dscp_mark  | 18                                       |
| id         | d7f976ec-7fab-4e60-af70-f59bf88198e6 |
+-----+-----+-----+
```

#### 3. View the DSCP rules for QoS policy `qos-web-servers`:

```
neutron qos-dscp-marking-rule-list qos-web-servers
+-----+-----+-----+
| dscp_mark | id                                       |
+-----+-----+-----+
|          18 | d7f976ec-7fab-4e60-af70-f59bf88198e6 |
+-----+-----+-----+
```

#### 4. View the details of the DSCP rule assigned to policy `qos-web-servers`:

```
neutron qos-dscp-marking-rule-show d7f976ec-7fab-4e60-af70-f59bf88198e6
qos-web-servers
+-----+-----+-----+
| Field      | Value                                     |
+-----+-----+-----+
```

```
+-----+-----+
| dscp_mark | 18 |
| id        | d7f976ec-7fab-4e60-af70-f59bf88198e6 |
+-----+-----+
```

#### 5. Change the DSCP value assigned to a rule:

```
neutron qos-dscp-marking-rule-update d7f976ec-7fab-4e60-af70-f59bf88198e6
qos-web-servers --dscp-mark 22
Updated dscp_marking_rule: d7f976ec-7fab-4e60-af70-f59bf88198e6
```

#### 6. Delete a DSCP rule:

```
neutron qos-dscp-marking-rule-delete d7f976ec-7fab-4e60-af70-f59bf88198e6
qos-web-servers
Deleted dscp_marking_rule(s): d7f976ec-7fab-4e60-af70-f59bf88198e6
```

### 10.4. RBAC for QoS Policies

Red Hat OpenStack Platform 11 adds Role-based Access Control (RBAC) for QoS policies. As a result, you can now make QoS policies available to certain projects.

For example, you can now create a QoS policy that allows for lower-priority network traffic, and have it only apply to certain projects. In the following command below, the *bw-limiter* policy created previously is assigned to the *demo* tenant:

```
# neutron rbac-create 'bw-limiter' --type qos-policy --target-tenant
80bf5732752a41128e612fe615c886c6 --action access_as_shared
```

## CHAPTER 11. CONFIGURE BRIDGE MAPPINGS

This chapter describes how to configure *bridge mappings* in Red Hat OpenStack Platform.

### 11.1. What are bridge mappings used for?

Bridge mappings allow provider network traffic to reach the physical network. Traffic leaves the provider network from the router's *qg-xxx* interface and arrives at **br-int**. A patch port between **br-int** and **br-ex** then allows the traffic to pass through the bridge of the provider network and out to the physical network.

#### 11.1.1. Configure bridge mappings

Below is an example of a patch-peer between **br-int** and **br-ex**:

```
int-br-ex <-> phy-br-ex
```

This connection is configured in the `bridge_mappings` setting. For example:

```
bridge_mappings = physnet1:br-ex,physnet2:br-ex2
```



#### NOTE

If the `bridge_mapping` entry is missing, no network connection exists, and communication to physical networks will not work.

This configuration's first entry creates a connection between **br-int** and **br-ex** using patch peer cable. The second entry creates a patch peer for **br-ex2**.

#### 11.1.2. Configure the controller node

The `bridge_mappings` configuration must correlate with that of the `network_vlan_ranges` option on the controller node. For the example given above, the controller node is configured as follows:

```
network_vlan_ranges = physnet1:10:20,physnet2:21:25
```

These values create the provider networks that represent the corresponding external networks; the external networks are then connected to the tenant networks via router interfaces. As a result, it is necessary to configure `bridge_mappings` on the network node on which the router is scheduled. This means that the router traffic is able to egress using the correct physical network, as represented by the provider network (for example: **physnet1**).

#### 11.1.3. Traffic flow

In addition to creating the connection, this setting also configures the OVS flow in **br-int** and **br-ex** to allow the network traffic to traverse to and from the external network. Each external network is represented by an internal VLAN id, which is tagged to the router's *qg-xxx* port. When a packet reaches **phy-br-ex**, the **br-ex** port strips the VLAN tag and moves the packet to the physical interface and then to the external network. The return packet from external network arrives on **br-ex** and is moved to **br-int** using `phy-br-ex <=> int-br-ex`. When the packet reaches **int-br-ex**, another flow in **br-int** adds internal vlan tag to the packet. This allows the packet to be accepted by *qg-xxx*.

## 11.2. Maintaining Bridge Mappings

After removing any mappings, a subsequent patch-port cleanup is required. This action ensures that the bridge configuration is cleared of erroneous entries, with two options available for performing this task:

- Manual port cleanup - requires careful removal of the superfluous ports. No outage is required to network connectivity.
- Automated port cleanup using **neutron-ovs-cleanup** - performs an automated cleanup, but requires an outage, and requires that the necessary mappings be re-added. Choose this option if you don't mind having an outage to network connectivity.

Examples are given below for each of these two options:

### 11.2.1. Manual port cleanup

The manual port cleanup process removes unneeded ports, and doesn't require a system outage. You can identify these ports by their naming convention: in **br- $\$external\_bridge$**  they are named as "phy- $\$external\_bridge$  and in **br-int** they are named "int- $\$external\_bridge$ .

This example procedure removes a bridge from **bridge\_mappings**, and cleans up the corresponding ports. 1. Edit **openvswitch\_agent.ini** and remove the entry for **physnet2:br-ex2** from **bridge\_mappings**:

```
bridge_mappings = physnet1:br-ex,physnet2:br-ex2
```

Remove the entry for **physnet2:br-ex2**. The resulting **bridge\_mappings** resembles this:

```
bridge_mappings = physnet1:br-ex
```

2. Use **ovs-vsctl** to remove the patch ports associated with the removed **physnet2:br-ex2** entry:

```
# ovs-vsctl del-port br-ex2 phy-br-ex2
# ovs-vsctl del-port br-int int-br-ex2
```



#### NOTE

If the entire **bridge\_mappings** entry is removed or commented out, cleanup commands will need to be run for each entry,

3. Restart **neutron-openvswitch-agent**

```
# service neutron-openvswitch-agent restart
```

### 11.2.2. Automated port cleanup using 'neutron-ovs-cleanup'

This action is performed using the **neutron-ovs-cleanup** command combined with the **--ovs\_all\_ports** flag. Restart the **neutron** services or the entire node to then restore the bridges back to their normal working state. This process requires a total networking outage.

The **neutron-ovs-cleanup** command unplugs all ports (instances, qdhcp/qrouter, among others) from all OVS bridges. Using the flag **--ovs\_all\_ports** results in removing all ports from **br-int**, cleaning up

tunnel ends from **br-tun**, and patch ports from bridge to bridge. In addition, the physical interfaces (such as **eth0**, **eth1**) are removed from the bridges (such as **br-ex**, **br-ex2**). This will result in lost connectivity to instances until the ports are manually re-added using **ovs-vsctl**:

```
# ovs-vsctl add-port br-ex eth1
```

### 11.2.2.1. Example usage of **neutron-ovs-cleanup**:

1. Make a backup of your **bridge\_mapping** entries as found in **openvswitch\_agent.ini**.

2. Run **neutron-ovs-cleanup** with the **--ovs\_all\_ports** flag. Note that this step will result in a total networking outage.

```
# /usr/bin/neutron-ovs-cleanup
--config-file /etc/neutron/plugins/ml2/openvswitch_agent.ini
--log-file /var/log/neutron/ovs-cleanup.log --ovs_all_ports
```

3. Restart these OpenStack Networking services:

```
# systemctl restart neutron-openvswitch-agent
# systemctl restart neutron-l3-agent.service
# systemctl restart neutron-dhcp-agent.service
```

4. Restore connectivity by re-adding the **bridge\_mapping** entries to **openvswitch\_agent.ini**.

5. Restart the **neutron-openvswitch-agent** service:

```
# systemctl restart neutron-openvswitch-agent
```



#### NOTE

When the OVS agent restarts, it doesn't touch any connections which are not present in **bridge\_mappings**. So if you have **br-int** connected to **br-ex2**, and **br-ex2** has some flows on it, removing it from the **bridge\_mappings** configuration (or commenting it out entirely) won't disconnect the two bridges, no matter what you do (whether restarting the service, or the node).

## CHAPTER 12. VLAN-AWARE INSTANCES

### 12.1. Overview

Instances can now send and receive VLAN-tagged traffic over a single vNIC. This ability is particularly useful for NFV applications (VNFs) that expect VLAN-tagged traffic, allowing multiple customers/services to be served by a single vNIC.

For example, the tenant data network can use VLANs, or tunneling (VXLAN/GRE) segmentation, while the instances will see the traffic tagged with VLAN IDs. As a result, network packets are tagged just before they are injected to the instance; they don't need to be tagged throughout the entire network.

To implement this, start by creating a parent port and attaching it to an existing neutron network. Doing so will add a trunk connection to the parent port you created. Next, create subports. These subports are the ports that connect VLANs to instances, thereby allowing connectivity to the trunk. Within the instance operating system, you need to create a sub-interface that tags traffic for the VLAN associated with the subport.

### 12.2. Review the Trunk Plugin

In a director-based deployment, the trunk plugin is turned on by default. You can review the configuration on the controller nodes:

1. On the controller node, confirm that the `trunk` plugin is enabled in `/etc/neutron/neutron.conf`. For example:

```
service_plugins=router,metering,qos,trunk
```

### 12.3. Create a Trunk Connection

1. Identify the network that requires the trunk port connection. This would be the network that will contain the instance that requires access to the trunked VLANs. In this example, this is the *public* network:

```
openstack network list
+-----+-----+-----+
| ID                | Name    | Subnets |
+-----+-----+-----+
| 82845092-4701-4004-add7-838837837621 | private | 434c7982-cd96-4c41-  
a8c9-b93adbdc197 |
| 8d8bc6d6-5b28-4e00-b99e-157516ff0050 | public  | 3fd811b4-c104-44b5-  
8ff8-7a86af5e332c |
+-----+-----+-----+
```

2. Create the parent trunk port, and attach it to the network that the instance will be connected to. In this example, a neutron port named `parent-trunk-port` is created on the *public* network. This trunk will be considered the *parent* port, as you can use it to create *subports*.

```
openstack port create --network public parent-trunk-port
```

```

-----+
| Field                | Value
|
+-----+-----+
| admin_state_up      | UP
| allowed_address_pairs |
| binding_host_id     |
| binding_profile     |
| binding_vif_details |
| binding_vif_type    | unbound
| binding_vnic_type   | normal
| created_at          | 2016-10-20T02:02:33Z
| description         |
| device_id           |
| device_owner        |
| extra_dhcp_opts     |
| fixed_ips            | ip_address='172.24.4.230', subnet_id='dc608964-
9af3-4fed-9f06-6d3844fb9b9b' |
| headers              |
| id                   | 20b6fdf8-0d43-475a-a0f1-ec8f757a4a39
| mac_address         | fa:16:3e:33:c4:75
| name                 | parent-trunk-port
| network_id          | 871a6bd8-4193-45d7-a300-dcb2420e7cc3
| project_id           | 745d33000ac74d30a77539f8920555e7
| project_id           | 745d33000ac74d30a77539f8920555e7
| revision_number     | 4
| security_groups     | 59e2af18-93c6-4201-861b-19a8a8b79b23
| status               | DOWN
| updated_at          | 2016-10-20T02:02:33Z
+-----+-----+
-----+

```



### 3. Create a trunk using the port you just created. In this example the trunk is named `parent-trunk`.

```

openstack network trunk create --parent-port parent-trunk-port parent-
trunk
+-----+-----+
| Field          | Value          |
+-----+-----+
| admin_state_up | UP             |
| created_at     | 2016-10-20T02:05:17Z |
| description    |                |
| id             | 0e4263e2-5761-4cf6-ab6d-b22884a0fa88 |
| name           | parent-trunk   |
| port_id        | 20b6fdf8-0d43-475a-a0f1-ec8f757a4a39 |
| revision_number | 1              |
| status         | DOWN           |
| sub_ports      |                |
| tenant_id      | 745d33000ac74d30a77539f8920555e7 |
| updated_at     | 2016-10-20T02:05:17Z |
+-----+-----+

```

### 4. View the trunk connection:

```

openstack network trunk list
+-----+-----+-----+
| ID          | Name          | Parent Port |
| Description |               |             |
+-----+-----+-----+
| 0e4263e2-5761-4cf6-ab6d-b22884a0fa88 | parent-trunk | 20b6fdf8-0d43-475a-a0f1-ec8f757a4a39 |
+-----+-----+-----+

```

- View the details of the trunk connection:

```

openstack network trunk show parent-trunk
+-----+-----+
| Field          | Value          |
+-----+-----+
| admin_state_up | UP             |
| created_at     | 2016-10-20T02:05:17Z |
| description    |                |
| id             | 0e4263e2-5761-4cf6-ab6d-b22884a0fa88 |
| name           | parent-trunk   |
| port_id        | 20b6fdf8-0d43-475a-a0f1-ec8f757a4a39 |
| revision_number | 1              |
| status         | DOWN           |
| sub_ports      |                |
| tenant_id      | 745d33000ac74d30a77539f8920555e7 |
| updated_at     | 2016-10-20T02:05:17Z |
+-----+-----+

```

## 12.4. Add Subports to the Trunk

1. Create a neutron port. This port will be used as a subport connection to the trunk. You must also specify the MAC address that was assigned to the parent port:

```

openstack port create --network private --mac-address fa:16:3e:33:c4:75
subport-trunk-port
+-----+-----+
| Field          | Value          |
+-----+-----+
| admin_state_up | UP             |
| allowed_address_pairs |              |
| binding_host_id |              |
| binding_profile |              |
| binding_vif_details |              |
| binding_vif_type | unbound       |
| binding_vnic_type | normal        |
| created_at      | 2016-10-20T02:08:14Z |
| description     |              |
| device_id       |              |
| device_owner    |              |
| extra_dhcp_opts |              |
| fixed_ips       | ip_address='10.0.0.11', subnet_id='1a299780-56df-4c0b-a4c0-c5a612cef2e8' |
| headers         |              |
| id              | 479d742e-dd00-4c24-8dd6-b7297fab3ee9 |
| mac_address     | fa:16:3e:33:c4:75 |
| name            | subport-trunk-port |
| network_id      | 3fe6b758-8613-4b17-901e-9ba30a7c4b51 |
| project_id      | 745d33000ac74d30a77539f8920555e7 |
| project_id      | 745d33000ac74d30a77539f8920555e7 |
| revision_number | 4             |
| security_groups | 59e2af18-93c6-4201-861b-19a8a8b79b23 |
| status          | DOWN          |

```

```
|
| updated_at          | 2016-10-20T02:08:15Z
|
+-----+-----+
-----+
```

**NOTE**

If you receive the error `HttpException: Conflict`, confirm that you are creating the subport on a different network to the one that has the parent trunk port. This example uses the `public` network for the parent trunk port, and `private` for the subport.

**2. Associate the port with the trunk ( parent - trunk), and specify the VLAN ID ( 55):**

```
openstack network trunk set --subport port=subport-trunk-
port,segmentation-type=vlan,segmentation-id=55 parent-trunk
```

**12.5. Configure an Instance to use a Trunk**

The instance operating system must be configured to use the MAC address that neutron assigned to the subport. You can also configure the subport to use a specific MAC address during the subport creation step.

**1. Review the configuration of your network trunk:**

```
$ openstack network trunk list
+-----+-----+-----+
-----+-----+
| ID                | Name          | Parent Port
| Description |
+-----+-----+-----+
-----+-----+
| 0e4263e2-5761-4cf6-ab6d-b22884a0fa88 | parent-trunk | 20b6fdf8-0d43-
475a-a0f1-ec8f757a4a39 |
+-----+-----+-----+
-----+-----+
```

```
$ openstack network trunk show parent-trunk
+-----+-----+
-----+-----+
| Field            | Value
|
+-----+-----+
-----+-----+
| admin_state_up  | UP
|
| created_at      | 2016-10-20T02:05:17Z
|
| description     |
|
| id              | 0e4263e2-5761-4cf6-ab6d-b22884a0fa88
|
| name            | parent-trunk
```

```

| port_id          | 20b6fdf8-0d43-475a-a0f1-ec8f757a4a39
| revision_number | 2
| status          | DOWN
| sub_ports       | port_id='479d742e-dd00-4c24-8dd6-b7297fab3ee9',
segmentation_id='55', segmentation_type='vlan' |
| tenant_id       | 745d33000ac74d30a77539f8920555e7
| updated_at      | 2016-10-20T02:10:06Z
+-----+-----+
-----+

```

## 2. Create an instance that uses the parent port `id` as its vNIC:

```
nova boot --image cirros --flavor m1.tiny testInstance --security-groups
default --key-name sshaccess --nic port-id=20b6fdf8-0d43-475a-a0f1-
ec8f757a4a39
```

```

+-----+-----+
-----+
| Property          | Value
+-----+-----+
| OS-DCF:diskConfig | MANUAL
| OS-EXT-AZ:availability_zone |
| OS-EXT-SRV-ATTR:host | -
| OS-EXT-SRV-ATTR:hostname | testinstance
| OS-EXT-SRV-ATTR:hypervisor_hostname | -
| OS-EXT-SRV-ATTR:instance_name |
| OS-EXT-SRV-ATTR:kernel_id |
| OS-EXT-SRV-ATTR:launch_index | 0
| OS-EXT-SRV-ATTR:ramdisk_id |
| OS-EXT-SRV-ATTR:reservation_id | r-juqco0e1
| OS-EXT-SRV-ATTR:root_device_name | -
| OS-EXT-SRV-ATTR:user_data | -
| OS-EXT-STS:power_state | 0
| OS-EXT-STS:task_state | scheduling

```

```

| OS-EXT-STS:vm_state | building
| OS-SRV-USG:launched_at | -
| OS-SRV-USG:terminated_at | -
| accessIPv4 |
| accessIPv6 |
| adminPass | uMyL8PnZRBwQ
| config_drive |
| created | 2016-10-20T03:02:51Z
| description | -
| flavor | m1.tiny (1)
| hostId |
| host_status |
| id | 88b7aede-1305-4d91-a180-
67e7eac8b70d |
| image | cirros (568372f7-15df-4e61-
a05f-10954f79a3c4) |
| key_name | sshaccess
| locked | False
| metadata | {}
| name | testInstance
| os-extended-volumes:volumes_attached | []
| progress | 0
| security_groups | default
| status | BUILD
| tags | []
| tenant_id | 745d33000ac74d30a77539f8920555e7
| updated | 2016-10-20T03:02:51Z
| user_id |
8c4aea738d774967b4ef388eb41fef5e |
+-----+
-----+

```

## 12.6. Trunk States

- **ACTIVE:** The trunk is working as expected and there are no current requests.
- **DOWN:** The virtual and physical resources for the trunk are not in sync. This can be a temporary state during negotiation.
- **BUILD:** There has been a request and the resources are being provisioned. Upon successful completion the trunk will return to **ACTIVE**.
- **DEGRADED:** The provisioning request did not complete, so the trunk has only been partially provisioned. It is recommended to remove the subports and try again.
- **ERROR:** The provisioning request was unsuccessful. Removing the resource that led to the error will return the trunk to a healthier state. Do not add more subports while in the **ERROR** state, as this can cause more issues.

## CHAPTER 13. CONFIGURE RBAC

Role-based Access Control (RBAC) policies in OpenStack Networking allows granular control over shared *neutron* networks. Previously, networks were shared either with all tenants, or not at all. OpenStack Networking now uses a RBAC table to control sharing of *neutron* networks among tenants, allowing an administrator to control which tenants are granted permission to attach instances to a network.

As a result, cloud administrators can remove the ability for some tenants to create networks and can instead allow them to attach to pre-existing networks that correspond to their project.

### 13.1. Create a new RBAC policy

This example procedure demonstrates how to use a RBAC policy to grant a tenant access to a shared network.

1. View the list of available networks:

```
# neutron net-list
+-----+-----+-----+
| id                | name                | subnets            |
+-----+-----+-----+
| fa9bb72f-b81a-4572-9c7f-7237e5fcabd3 | web-servers        | 20512ffe-ad56-4bb4-b064-2cb18fecc923 192.168.200.0/24 |
| bcc16b34-e33e-445b-9fde-dd491817a48a | private            | 7fe4a05a-4b81-4a59-8c47-82c965b0e050 10.0.0.0/24 |
| 9b2f4feb-fee8-43da-bb99-032e4aaf3f85 | public            | 2318dc3b-cff0-43fc-9489-7d4cf48aaab9 172.24.4.224/28 |
+-----+-----+-----+
```

2. View the list of tenants:

```
# openstack project list
+-----+-----+
| ID                | Name                |
+-----+-----+
| 4b0b98f8c6c040f38ba4f7146e8680f5 | auditors            |
| 519e6344f82e4c079c8e2eabb690023b | services            |
| 80bf5732752a41128e612fe615c886c6 | demo                |
| 98a2f53c20ce4d50a40dac4a38016c69 | admin               |
+-----+-----+
```

3. Create a RBAC entry for the **web-servers** network that grants access to the *auditors* tenant (**4b0b98f8c6c040f38ba4f7146e8680f5**):

```
# neutron rbac-create fa9bb72f-b81a-4572-9c7f-7237e5fcabd3 --type
network --target-tenant 4b0b98f8c6c040f38ba4f7146e8680f5 --action
access_as_shared
Created a new rbac_policy:
+-----+-----+
| Field                | Value                |
+-----+-----+
```

```

| action          | access_as_shared          |
| id              | 314004d0-2261-4d5e-bda7-0181fcf40709 |
| object_id      | fa9bb72f-b81a-4572-9c7f-7237e5fcabd3 |
| object_type    | network                   |
| target_tenant  | 4b0b98f8c6c040f38ba4f7146e8680f5   |
| tenant_id      | 98a2f53c20ce4d50a40dac4a38016c69   |
+-----+-----+

```

As a result, users in the *auditors* project are able to connect instances to the *web-servers* network.

## 13.2. Review your configured RBAC policies

1. Use `neutron rbac-list` to retrieve the ID of your existing RBAC policies:

```

# neutron rbac-list
+-----+-----+-----+
| id              | object_type | object_id |
+-----+-----+-----+
| 314004d0-2261-4d5e-bda7-0181fcf40709 | network     | fa9bb72f-
b81a-4572-9c7f-7237e5fcabd3 |
| bbab1cf9-edc5-47f9-ae3-a413bd582c0a | network     | 9b2f4feb-
fee8-43da-bb99-032e4aaf3f85 |
+-----+-----+-----+

```

2. Use `neutron rbac-show` to view the details of a specific RBAC entry:

```

# neutron rbac-show 314004d0-2261-4d5e-bda7-0181fcf40709
+-----+-----+
| Field          | Value |
+-----+-----+
| action         | access_as_shared |
| id             | 314004d0-2261-4d5e-bda7-0181fcf40709 |
| object_id      | fa9bb72f-b81a-4572-9c7f-7237e5fcabd3 |
| object_type    | network |
| target_tenant  | 4b0b98f8c6c040f38ba4f7146e8680f5 |
| tenant_id      | 98a2f53c20ce4d50a40dac4a38016c69 |
+-----+-----+

```

## 13.3. Delete a RBAC policy

1. Use `neutron rbac-list` to retrieve the ID of your existing RBACs:

```

# neutron rbac-list
+-----+-----+-----+
| id              | object_type | object_id |
+-----+-----+-----+
| 314004d0-2261-4d5e-bda7-0181fcf40709 | network     | fa9bb72f-

```



```

b81a-4572-9c7f-7237e5fcabd3 |
| bbab1cf9-edc5-47f9-ae3-a413bd582c0a | network      | 9b2f4feb-
fee8-43da-bb99-032e4aaf3f85 |
+-----+-----+-----+
-----+

```

2. Use `neutron rbac-delete` to delete the RBAC, using its ID value:

```

# neutron rbac-delete 314004d0-2261-4d5e-bda7-0181fcf40709
Deleted rbac_policy: 314004d0-2261-4d5e-bda7-0181fcf40709

```

### 13.4. RBAC for external networks

You can grant RBAC access to external networks (networks with gateway interfaces attached) using the `--action access_as_external` parameter

For example, this procedure creates a RBAC for the `web-servers` network and grants access to the engineering tenant (`c717f263785d4679b16a122516247deb`):

1. Create a new RBAC policy using `--action access_as_external`:

```

# neutron rbac-create 6e437ff0-d20f-4483-b627-c3749399bdca --type network
--target-tenant c717f263785d4679b16a122516247deb --action
access_as_external
Created a new rbac_policy:
+-----+-----+-----+
| Field          | Value                                     |
+-----+-----+-----+
| action         | access_as_external                       |
| id             | ddef112a-c092-4ac1-8914-c714a3d3ba08    |
| object_id      | 6e437ff0-d20f-4483-b627-c3749399bdca    |
| object_type    | network                                   |
| target_tenant  | c717f263785d4679b16a122516247deb        |
| tenant_id      | c717f263785d4679b16a122516247deb        |
+-----+-----+-----+

```

2. As a result, users in the Engineering tenant are able to view the network or connect instances to it:

```

$ neutron net-list
+-----+-----+-----+
-----+
| id                  | name          | subnets
|
+-----+-----+-----+
-----+
| 6e437ff0-d20f-4483-b627-c3749399bdca | web-servers  | fa273245-1eff-4830-
b40c-57eaeac9b904 192.168.10.0/24 |
+-----+-----+-----+
-----+

```

## CHAPTER 14. CONFIGURE DISTRIBUTED VIRTUAL ROUTING (DVR)

Customers deploying Red Hat OpenStack Platform 11 have the option to choose between a centralized routing model or DVR for their Red Hat OpenStack Platform deployment. While DVR is fully supported and available as a configuration option, Red Hat OpenStack Platform 11 director still defaults to centralized routing.

It is important to note that both centralized routing and DVR are valid routing models, and each has its own set of advantages and disadvantages. Customers are advised to use this document to carefully plan whether centralized routing or DVR will better suit their needs.

### 14.1. Overview of Layer 3 Routing

OpenStack Networking (neutron) provides routing services for project networks. Without a router, instances in a project network are only able to communicate with one another over a shared L2 broadcast domain. Creating a router and assigning it to a tenant network allows the instances in that network to communicate with other project networks or upstream (if an external gateway is defined for the router).

#### 14.1.1. Routing Flows

Routing services in OpenStack can be categorized into three main flows:

- **East-West routing** - routing of traffic between different networks in the same tenant. This traffic does not leave the OpenStack deployment. This definition applies to both IPv4 and IPv6 subnets.
- **North-South routing with floating IPs** - Floating IP addressing can be best described as a one-to-one NAT that can be modified and floats between instances. While floating IPs are modeled as a one-to-one association between the floating IP and a neutron port, they are implemented by association with a neutron router that performs the NAT translation. The floating IPs themselves are taken from the uplink network that is providing the router with its external connectivity. As a result, instances can communicate with external resources (such as endpoints in the internet) or the other way around. Floating IPs are an IPv4 concept and do not apply to IPv6. It is assumed that the IPv6 addressing used by projects uses Global Unicast Addresses (GUAs) with no overlap across the projects, and therefore can be routed without NAT.
- **North-South routing without floating IPs (also known as SNAT)** - Neutron offers a default port address translation (PAT) service for instances that have not been allocated floating IPs. With this service, instances can communicate with external endpoints through the router, but not the other way around. For example, an instance can browse a website in the internet, but a web browser outside could not browse a website hosted within the instance. SNAT is applied for IPv4 traffic only. In addition, neutron project networks that are assigned GUAs prefixes do not require NAT on the neutron router external gateway port to access the outside world.

#### 14.1.2. Centralized Routing

Originally, neutron was designed with a centralized routing model where a project's virtual routers, managed by the neutron L3 agent, are all deployed in a dedicated node or cluster of nodes (referred to as the Network node, or Controller node). This means that each time a routing function is required (east/west, floating IPs or SNAT), traffic would traverse through a dedicated node in the topology. This introduced multiple challenges and resulted in sub-optimal traffic flows. For example:

- Traffic between instances flows through a Controller node - when two instances need to communicate with each other using L3, traffic has to hit the Controller node. Even if the instances are scheduled on the same Compute node, traffic still has to leave the Compute node, flow through the Controller, and route back to the Compute node. This negatively impacts performance.
- Instances with floating IPs receive and send packets through the Controller node - the external network gateway interface is available only at the Controller node, so whether the traffic is originating from an instance, or destined to an instance from the external network, it has to flow through the Controller node. Consequently, in large environments the Controller node is subject to heavy traffic load. This would affect performance and scalability, and also requires careful planning to accommodate enough bandwidth in the external network gateway interface. The same requirement applies for SNAT traffic.

To better scale the L3 agent, neutron can use the L3 HA feature, which distributes the virtual routers across multiple nodes. In the event that a Controller node is lost, the HA router will failover to a standby on another node and there will be packet loss until the HA router failover completes. The feature is available starting with Red Hat Enterprise Linux OpenStack Platform 6 and is enabled by default.

## 14.2. DVR Overview

Distributed Virtual Routing (DVR) offers an alternative routing design, which is now fully supported with Red Hat OpenStack Platform 11. It intends to isolate the failure domain of the Controller node and optimize network traffic by deploying the L3 agent and schedule routers on every Compute node. When using DVR:

- East-West traffic is routed directly on the Compute nodes in a distributed fashion.
- North-South traffic with floating IP is distributed and routed on the Compute nodes. This requires the external network to be connected to each and every Compute node.
- North-South traffic without floating IP is not distributed and still requires a dedicated Controller node.
  - The L3 agent on the Controller node is configured with a new `dvr_snat` mode so that only SNAT traffic is served by the node.
- The neutron metadata agent is distributed and deployed on all Compute nodes. The metadata proxy service is hosted on all the distributed routers.

## 14.3. Known Issues and Caveats

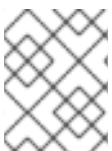

### NOTE

For Red Hat OpenStack Platform 11, do not use DVR unless your kernel version is at least `kernel-3.10.0-514.1.1.el7`

- Support for DVR is limited to the ML2 core plug-in and the Open vSwitch (OVS) mechanism driver. Other back ends are not supported.
- SNAT traffic is not distributed, even when DVR is enabled. SNAT does work, but all ingress/egress traffic must traverse through the centralized Controller node.

- IPv6 traffic is not distributed, even when DVR is enabled. IPv6 routing does work, but all ingress/egress traffic must traverse through the centralized Controller node. Customers that are extensively using IPv6 routing are advised not to use DVR at this time.
- DVR is not supported in conjunction with L3 HA. With Red Hat OpenStack Platform 11 director, if DVR is used, L3 HA is turned off. That means that routers are still going to be scheduled on the Network nodes (and load-shared between the L3 agents), but if one agent fails, all routers hosted by this agent will fail as well. This only affects SNAT traffic. The `allow_automatic_l3agent_failover` feature is recommended in such cases, so that if one network node fails, the routers will be rescheduled to a different node.
- DHCP servers, which are managed by the neutron DHCP agent, are not distributed and are still deployed on the Controller node. With Red Hat OpenStack Platform, the DHCP agent is deployed in a highly available configuration on the Controller nodes, regardless of the routing design (centralized or DVR).
- For floating IPs, each Compute node requires an interface on the *External* network. In addition, each Compute node now requires one additional IP address. This is due to the implementation of the external gateway port and the floating IP network namespace.
- VLAN, GRE, and VXLAN are all supported for project data separation. When GRE or VXLAN are used, the L2 Population feature must be turned on. With Red Hat OpenStack Platform 11 director, this is enforced during installation.

#### 14.4. Supported Routing Architectures

- Red Hat Enterprise Linux OpenStack Platform 5 through to Red Hat OpenStack Platform 11 for centralized, HA routing.
- Red Hat OpenStack Platform 11 with distributed routing.
- Upgrading from a Red Hat OpenStack Platform 10 deployment running centralized HA routing to Red Hat OpenStack Platform 11 with only distributed routing.

#### 14.5. Deploying DVR

The `neutron-ovs-dvr.yaml` environment file configures the required DVR-specific parameters. Configuring DVR for arbitrary deployment configuration requires additional consideration. The requirements are:

(a) The interface connected to the physical network for external network traffic must be configured on both the Compute and Controller nodes.

(b) A bridge must be created on Compute and Controller nodes, with an interface for external network traffic.

(c) Neutron must be configured to allow this bridge to be used.

The host networking configuration (a and b) are controlled by Heat templates that pass configuration to the Heat-managed nodes for consumption by the `os-net-config` process. This is essentially automation of provisioning host networking. Neutron must also be configured (c) to match the provisioned networking environment. The defaults are not expected to work in production environments. For example, a proof-of-concept environment using the typical defaults might be similar to the following:

1. Verify that the value for `OS::TripleO::Compute::Net::SoftwareConfig` in

`environments/neutron-ovs-dvr.yaml` is the same as the

`OS::TripleO::Controller::Net::SoftwareConfig` value in use. This can normally be found in the network environment file in use when deploying the overcloud, for example, `environments/net-multiple-nics.yaml`. This will create the appropriate external network bridge for the Compute node's L3 agent.

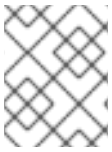

#### NOTE

If customizations have been made to the Compute node's network configuration, it may be necessary to add the appropriate configuration to those files instead.

2. Configure a neutron port for the Compute node on the external network by modifying `OS::TripleO::Compute::Ports::ExternalPort` to an appropriate value, such as `OS::TripleO::Compute::Ports::ExternalPort: ../network/ports/external.yaml`

3. Include `environments/neutron-ovs-dvr.yaml` as an environment file when deploying the overcloud. For example:

```
$ openstack overcloud deploy --templates -e /usr/share/openstack-tripleo-heat-templates/environments/neutron-ovs-dvr.yaml
```

4. Verify that L3 HA is disabled.

For production environments (or test environments that require special customization, for example, involving network isolation, dedicated NICs, among others) the example environments can be used as a guide. Particular attention should be given to the bridge mapping type parameters used by the L2 agents (for example, OVS) and any reference to external facing bridges for other agents (such as the L3 agent).

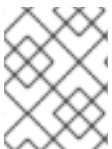

#### NOTE

The external bridge configuration for the L3 agent, while currently still provided, is deprecated and will be removed in the future.

## 14.6. Migrate Centralized Routers to Distributed Routing

This section describes the upgrade path to distributed routing for Red Hat OpenStack Platform deployments that use L3 HA centralized routing.

1. Upgrade your deployment and validate that it is working correctly.
2. Run the director stack update to configure DVR, as described in [Deploying DVR](#).
3. Confirm that routing still works through the existing routers.
4. You will not be able to directly transition a L3 HA router to *distributed*. Instead, for each router, turn off the L3 HA option, and then turn on the distributed option:

4a. Move the router out of the *admin* state:

```
$ neutron router-update --admin-state-up=False
```

4b. Convert the router to the *legacy* type:

```
$ neutron router-update --ha=False
```

**4c.** Configure the router to use DVR:

```
$ neutron router-update --distributed=True
```

**4d.** Move the router into the *admin* state:

```
$ neutron router-update --admin-state-up=True
```

**4e.** Confirm that routing still works, and is now distributed.

## CHAPTER 15. CONFIGURE LOAD BALANCING-AS-A-SERVICE (LBAAS)

Load Balancing-as-a-Service (LBaaS) enables OpenStack Networking to distribute incoming requests evenly between designated instances. This step-by-step guide configures OpenStack Networking to use LBaaS with the Open vSwitch (OVS) plug-in.

Introduced in Red Hat OpenStack Platform 5, Load Balancing-as-a-Service (LBaaS) enables OpenStack Networking to distribute incoming requests evenly between designated instances. This ensures the workload is shared predictably among instances, and allows more effective use of system resources. Incoming requests are distributed using one of these load balancing methods:

- **Round robin** - Rotates requests evenly between multiple instances.
- **Source IP** - Requests from a unique source IP address are consistently directed to the same instance.
- **Least connections** - Allocates requests to the instance with the least number of active connections.

**Table 15.1. LBaaS features**

Feature	Description
Monitors	LBaaS provides availability monitoring with the ping, TCP, HTTP and HTTPS GET methods. Monitors are implemented to determine whether pool members are available to handle requests.
Management	LBaaS is managed using a variety of tool sets. The REST API is available for programmatic administration and scripting. Users perform administrative management of load balancers through either the CLI (neutron) or the OpenStack dashboard.
Connection limits	Ingress traffic can be shaped with connection limits. This feature allows workload control and can also assist with mitigating DoS (Denial of Service) attacks.
Session persistence	LBaaS supports session persistence by ensuring incoming requests are routed to the same instance within a pool of multiple instances. LBaaS supports routing decisions based on cookies and source IP address.



### NOTE

LBaaS is currently supported only with IPv4 addressing.

**NOTE**

LBaaSv1 has been removed in Red Hat OpenStack Platform 11 (Ocata) and replaced by LBaaSv2.

## 15.1. OpenStack Networking and LBaaS Topology

OpenStack Networking (neutron) services can be broadly classified into two categories.

**1. - Neutron API server** - This service runs the OpenStack Networking API server, which has the main responsibility of providing an API for end users and services to interact with OpenStack Networking. This server also has the responsibility of interacting with the underlying database to store and retrieve tenant network, router, and loadbalancer details, among others.

**2. - Neutron Agents** - These are the services that deliver various network functionality for OpenStack Networking.

- **neutron-dhcp-agent** - manages DHCP IP addressing for tenant private networks.
- **neutron-l3-agent** - facilitates layer 3 routing between tenant private networks, the external network, and others.
- **neutron-lbaasv2-agent** - provisions the LBaaS routers created by tenants.

The following diagram describes the flow of HTTPS traffic through to a pool member:

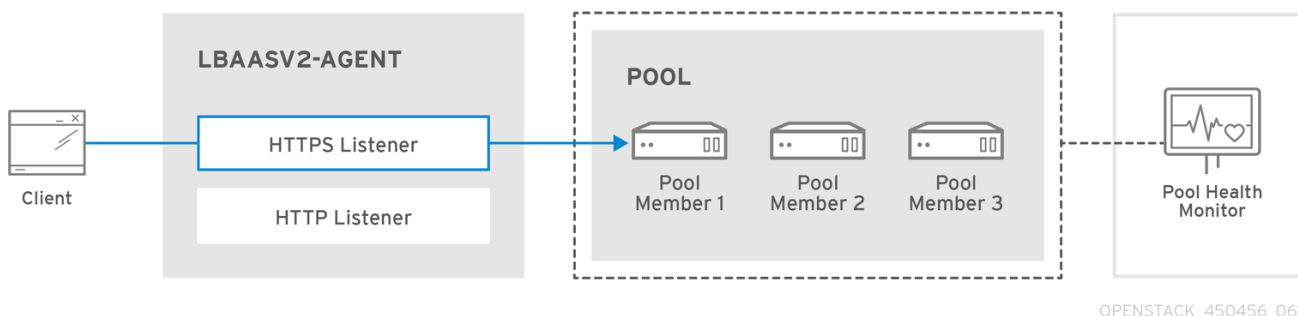

### 15.1.1. Support Status of LBaaS

- LBaaS v1 API was removed in version 10.
- LBaaS v2 API was introduced in Red Hat OpenStack Platform 7, and is the only available LBaaS API as of version 10.
- LBaaS deployment is not currently supported in Red Hat OpenStack Platform director.

### 15.1.2. Service Placement

The OpenStack Networking services can either run together on the same physical server, or on separate dedicated servers.

**NOTE**

Red Hat OpenStack Platform 11 added support for composable roles, allowing you to separate network services into a custom role. However, for simplicity, this guide assumes that a deployment uses the default controller role.



The server that runs API server is usually called the **Controller node**, whereas the server that runs the OpenStack Networking agents is called the **Network node**. An ideal production environment would separate these components to their own dedicated nodes for performance and scalability reasons, but a testing or PoC deployment might have them all running on the same node. This chapter covers both of these scenarios; the section under Controller node configuration need to be performed on the API server, whereas the section on Network node is performed on the server that runs the LBaaS agent.



#### NOTE

If both the Controller and Network roles are on the same physical node, then the steps must be performed on that server.

## 15.2. Configure LBaaS

This procedure configures OpenStack Networking (neutron) to use LBaaS with the Open vSwitch (OVS) plug-in. Perform these steps on nodes running the `neutron-server` service.



#### NOTE

These steps are not intended for deployments based on Octavia. For more information, see [https://access.redhat.com/documentation/en-us/red\\_hat\\_openstack\\_platform/11/html-single/advanced\\_overcloud\\_customization/#Composable\\_Service\\_Reference-New\\_Services](https://access.redhat.com/documentation/en-us/red_hat_openstack_platform/11/html-single/advanced_overcloud_customization/#Composable_Service_Reference-New_Services)

On the Controller node (API Server):

1. Install HAProxy:

```
# yum install haproxy
```

2. Add the LBaaS tables to the neutron database:

```
$ neutron-db-manage --subproject neutron-lbaas --config-file
/etc/neutron/neutron.conf --config-file
/etc/neutron/plugins/ml2/ml2_conf.ini upgrade head
```

3. Change the service provider in `/etc/neutron/neutron_lbaas.conf`. In the `[service providers]` section, comment out ( `#` ) all entries except for:

```
service_provider=LOADBALANCERV2:Haproxy:neutron_lbaas.drivers.haproxy.plugin_driver.HaproxyOnHostPluginDriver:default
```

4. In `/etc/neutron/neutron.conf`, confirm that you have the LBaaS v2 plugin configured in `service_plugins`:

```
service_plugins=neutron_lbaas.services.loadbalancer.plugin.LoadBalancerPluginv2
```

You can also expect to see any other plugins you have previously added.

**NOTE**

If you have `lbaasv1` configured, replace it with the above setting for `lbaasv2`.

5. In `/etc/neutron/lbaas_agent.ini`, add the following to the `[DEFAULT]` section:

```
ovs_use_veth = False
interface_driver =neutron.agent.linux.interface.OVSInterfaceDriver
```

6. In `/etc/neutron/services_lbaas.conf`, add the following to the `[haproxy]` section:

```
user_group = haproxy
```

- a. Comment out any other `device driver` entries.

**NOTE**

If the `l3-agent` is in a failed mode, see the `l3-agent` log files. You may need to edit `/etc/neutron/neutron.conf` and comment out certain values in `[DEFAULT]`, and uncomment the corresponding values in `oslo_messaging_rabbit`, as described in the log file.

7. Configure the LBaaS services, and review their status:

- a. Stop the `lbaasv1` services and start `lbaasv2`:

```
# systemctl disable neutron-lbaas-agent.service
# systemctl stop neutron-lbaas-agent.service
# systemctl mask neutron-lbaas-agent.service
# systemctl enable neutron-lbaasv2-agent.service
# systemctl start neutron-lbaasv2-agent.service
```

- b. Review the status of `lbaasv2`:

```
# systemctl status neutron-lbaasv2-agent.service
```

- c. Restart `neutron-server` and check the status:

```
# systemctl restart neutron-server.service
# systemctl status neutron-server.service
```

- d. Check the `Loadbalancerv2` agent:

```
$ neutron agent-list
```

### 15.3. Automatically Reschedule Load Balancers

You can configure neutron to automatically reschedule load balancers from failed LBaaS agents. Previously, load balancers could be scheduled across multiple LBaaS agents, however if a hypervisor died, the load balancers scheduled to that node would cease operation. Now these load balancers can be automatically rescheduled to a different agent. This feature is turned off by default and controlled using `allow_automatic_lbaas_agent_failover`.

### 15.3.1. Enable Automatic Failover

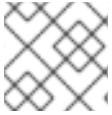

#### NOTE

You will need at least two nodes running the `Loadbalancerv2` agent.

1. On all nodes running the `Loadbalancerv2` agent, edit `/etc/neutron/neutron_lbaas.conf`:

```
allow_automatic_lbaas_agent_failover=True
```

2. Restart the LBaaS agents and `neutron-server`:

```
systemctl restart neutron-lbaasv2-agent
systemctl restart neutron-server.service
```

3. Review the state of the agents:

```
$ neutron agent-list
+-----+-----+-----+-----+
+-----+-----+-----+-----+
+-----+
| id                | agent_type          |
host                | availability_zone   | alive | admin_state_up |
binary              |
+-----+-----+-----+-----+
+-----+-----+-----+-----+
+-----+
| 2af49b85-7a55-4420-97e0-186c233cce08 | Open vSwitch agent |
node1 |                | :- ) | True           | neutron-
openvswitch-agent |
| 2d81c836-2f85-47c2-9cdc-665aa796e977 | DHCP agent          |
node1 | nova            | :- ) | True           | neutron-dhcp-
agent          |
| 58fa7369-ea35-4663-ae34-97518e847741 | Open vSwitch agent |
node2 |                | :- ) | True           | neutron-
openvswitch-agent |
| 7b665b9d-4c7e-4da1-a37a-1007af6444fc | Loadbalancerv2 agent |
node1 |                | :- ) | True           | neutron-
lbaasv2-agent   |
| 88f4c436-7152-4d30-a9e8-a793750bcbbba | Loadbalancerv2 agent |
node2 |                | :- ) | True           | neutron-
lbaasv2-agent   |
| de6640a1-17a7-4ceb-986a-3b0de3b8845e | Metadata agent      |
node1 |                | :- ) | True           | neutron-
metadata-agent  |
| e4f77843-48e9-43af-a1af-884c07714416 | L3 agent            |
node1 | nova            | :- ) | True           | neutron-l3-
agent          |
+-----+-----+-----+-----+
+-----+-----+-----+-----+
+-----+
```

### 15.3.2. Sample Failover Configuration

## 1. Create a new loadbalancer:

```
$ neutron lbaas-loadbalancer-create --name lb1 private-subnet
Created a new loadbalancer:
+-----+-----+
| Field                | Value                                |
+-----+-----+
| admin_state_up       | True                                  |
| description           |                                        |
| id                   | b130e956-b8d1-4290-ab83-febc19797683 |
| listeners             |                                        |
| name                 | lb1                                   |
| operating_status     | OFFLINE                               |
| pools                |                                        |
| provider              | haproxy                               |
| provisioning_status  | PENDING_CREATE                       |
| tenant_id            | 991b8c905d644900948b4540d9815fa9    |
| vip_address           | 10.0.0.3                              |
| vip_port_id          | 89f05da4-f820-470d-95c7-d13fe09a2b6f |
| vip_subnet_id        | 6c8f7812-7fd2-4e79-bf96-0b85f47bea49 |
+-----+-----+
```

## 2. Create a listener so that haproxy is spawned:

```
$ neutron lbaas-listener-create --loadbalancer lb1 --protocol HTTP -
--protocol-port 80 --name listener1
Created a new listener:
+-----+-----+
-----+
| Field                | Value                                |
|                       |                                       |
+-----+-----+
-----+
| admin_state_up       | True                                  |
| connection_limit     | -1                                    |
| default_pool_id      |                                        |
| default_tls_container_ref |                                        |
| description           |                                        |
| id                   | 538c13bf-6b27-441d-8ac7-d54ef6b7a503 |
| loadbalancers        | {"id": "b130e956-b8d1-4290-ab83- |
febc19797683"} |
| name                 | listener1                             |
| protocol              | HTTP                                   |
| protocol_port        | 80                                     |
| sni_container_refs   |                                        |
| tenant_id            | 991b8c905d644900948b4540d9815fa9    |
+-----+-----+
```

```
|
+-----+-----+
-----+
```

3. Check which LBaaS agent the loadbalancer was scheduled to:

```
$ neutron lbaas-agent-hosting-loadbalancer lb1
+-----+-----+-----+-----+-----+-----+-----+-----+-----+
-----+-----+
| id                | host                |
admin_state_up | alive |
+-----+-----+-----+-----+-----+-----+-----+-----+-----+
-----+-----+
| 88f4c436-7152-4d30-a9e8-a793750bcbbba | node2 | True                | :-
) |
+-----+-----+-----+-----+-----+-----+-----+-----+-----+
-----+-----+
```

4. Verify that haproxy runs on that node. In addition, verify that it is not currently running on the other node:

```
stack@node2:~/ $ ps -ef | grep "haproxy -f" | grep lbaas
nobody  14503      1  0 17:14 ?          00:00:00 haproxy -f
/opt/openstack/data/neutron/lbaas/v2/b130e956-b8d1-4290-ab83-
febc19797683/haproxy.conf -p
/opt/openstack/data/neutron/lbaas/v2/b130e956-b8d1-4290-ab83-
febc19797683/haproxy.pid

stack@node1:~/ $ ps -ef | grep "haproxy -f" | grep lbaas
stack@node1:~/ $
```

5. Kill the hosting lbaas agent process, then wait for **neutron-server** to recognize this event and consequently reschedule the loadbalancer:

```
$ neutron lbaas-agent-hosting-loadbalancer lb1
+-----+-----+-----+-----+-----+-----+-----+-----+-----+
-----+-----+
| id                | host                |
admin_state_up | alive |
+-----+-----+-----+-----+-----+-----+-----+-----+-----+
-----+-----+
| 88f4c436-7152-4d30-a9e8-a793750bcbbba | node2 | True                |
xxx |
+-----+-----+-----+-----+-----+-----+-----+-----+-----+
-----+-----+
```

- Review **q-svc log**:

```
2016-12-08 17:17:48.427 WARNING neutron.db.agents_db [req-
1518b1ee-1ce3-4813-9999-9e9323666df7 None None] Agent
healthcheck: found 1 dead agents out of 7:
                Type                Last heartbeat host
Loadbalancerv2 agent  2016-12-08 17:15:11 node2
2016-12-08 17:18:06.000 WARNING neutron.db.agentschedulers_db
[req-d0c689d4-434b-4db7-8140-27d3d3442dec None None] Rescheduling
```

```
loadbalancer b130e956-b8d1-4290-ab83-febc19797683 from agent
88f4c436-7152-4d30-a9e8-a793750bcbbba because the agent did not
report to the server in the last 150 seconds.
```

- Verify that the loadbalancer was actually rescheduled to the live lbaas agent, and that haproxy is running:

```
$ neutron lbaas-agent-hosting-loadbalancer lb1
+-----+-----+-----+-----+-----+-----+-----+-----+-----+
| id                | host                | admin_state_up | alive |
+-----+-----+-----+-----+-----+-----+-----+-----+
| 7b665b9d-4c7e-4da1-a37a-1007af6444fc | node1 | True           | :-)  |
+-----+-----+-----+-----+-----+-----+-----+-----+
| )                |
```

- Review the state of the haproxy process:

```
stack@node1:~/ $ ps -ef | grep "haproxy -f" | grep lbaas
nobody      768      1  0 17:18 ?        00:00:00 haproxy -f
/opt/openstack/data/neutron/lbaas/v2/b130e956-b8d1-4290-ab83-
febc19797683/haproxy.conf -p
/opt/openstack/data/neutron/lbaas/v2/b130e956-b8d1-4290-ab83-
febc19797683/haproxy.pid
```

- Revive the lbaas agent that you killed in step 4. Verify haproxy is no longer running on that node and that **neutron-server** recognizes the agent:

```
stack@node2:~/ $ ps -ef | grep "haproxy -f" | grep lbaas
stack@node2:~/ $
```

- Review the agent list:

```
$ neutron agent-list
+-----+-----+-----+-----+-----+-----+-----+-----+-----+
| id                | agent_type          | host                | availability_zone | alive | admin_state_up |
| binary           |                     |                     |                   |      |                 |
+-----+-----+-----+-----+-----+-----+-----+-----+-----+
| 2af49b85-7a55-4420-97e0-186c233cce08 | Open vSwitch agent | node1 | nova          | :-)  | True           | neutron-
openvswitch-agent |
| 2d81c836-2f85-47c2-9cdc-665aa796e977 | DHCP agent         | node1 | nova          | :-)  | True           | neutron-dhcp-
agent |
| 58fa7369-ea35-4663-ae34-97518e847741 | Open vSwitch agent | node2 | nova          | :-)  | True           | neutron-
openvswitch-agent |
```

```

| 7b665b9d-4c7e-4da1-a37a-1007af6444fc | Loadbalancerv2 agent |
node1 |                               | :- ) | True           | neutron-
lbaasv2-agent |
| 88f4c436-7152-4d30-a9e8-a793750bcbba | Loadbalancerv2 agent |
node2 |                               | :- ) | True           | neutron-
lbaasv2-agent |
| de6640a1-17a7-4ceb-986a-3b0de3b8845e | Metadata agent      |
node1 |                               | :- ) | True           | neutron-
metadata-agent |
| e4f77843-48e9-43af-a1af-884c07714416 | L3 agent            |
node1 | nova                               | :- ) | True           | neutron-l3-
agent |
+-----+-----+-----+-----+-----+-----+-----+-----+-----+
-----+-----+-----+-----+-----+-----+-----+-----+-----+
-----+

```

## CHAPTER 16. TENANT NETWORKING WITH IPV6

This chapter describes how to implement IPv6 subnets in a tenant network. In addition to tenant networking, as of director 7.3, IPv6-native deployments can be configured for the overcloud nodes.

Red Hat OpenStack Platform 6 added support for IPv6 in tenant networks. IPv6 subnets are created within existing tenant networks, and support a number of address assignment modes: Stateless Address Autoconfiguration (SLAAC), **Stateful DHCPv6**, and **Stateless DHCPv6**. This chapter describes the IPv6 subnet creation options, and provides an example procedure that runs through these steps.

### 16.1. IPv6 subnet options

IPv6 subnets are created using the `neutron subnet-create` command. In addition, you can optionally specify the address mode and the Router Advertisement mode. The possible combinations of these options are explained below:

RA Mode	Address Mode	Result
<code>ipv6_ra_mode=not set</code>	<code>ipv6-address-mode=slaac</code>	The instance receives an IPv6 address from the external router (not managed by OpenStack Networking) using <b>SLAAC</b> .
<code>ipv6_ra_mode=not set</code>	<code>ipv6-address-mode=dhcpv6-stateful</code>	The instance receives an IPv6 address and optional information from OpenStack Networking (dnsmasq) using <b>DHCPv6 stateful</b> .
<code>ipv6_ra_mode=not set</code>	<code>ipv6-address-mode=dhcpv6-stateless</code>	The instance receives an IPv6 address from the external router using SLAAC, and optional information from OpenStack Networking (dnsmasq) using <b>DHCPv6 stateless</b> .
<code>ipv6_ra_mode=slaac</code>	<code>ipv6-address-mode=not-set</code>	The instance uses SLAAC to receive an IPv6 address from OpenStack Networking ( <b>radvd</b> ).
<code>ipv6_ra_mode=dhcpv6-stateful</code>	<code>ipv6-address-mode=not-set</code>	The instance receives an IPv6 address and optional information from an external DHCPv6 server using <b>DHCPv6 stateful</b> .
<code>ipv6_ra_mode=dhcpv6-stateless</code>	<code>ipv6-address-mode=not-set</code>	The instance receives an IPv6 address from OpenStack Networking ( <b>radvd</b> ) using SLAAC, and optional information from an external DHCPv6 server using <b>DHCPv6 stateless</b> .



RA Mode	Address Mode	Result
ipv6_ra_mode=slaac	ipv6-address-mode=slaac	The instance receives an IPv6 address from OpenStack Networking ( <b>radvd</b> ) using <b>SLAAC</b> .
ipv6_ra_mode=dhcpv6-stateful	ipv6-address-mode=dhcpv6-stateful	The instance receives an IPv6 address from OpenStack Networking ( <b>dnsmasq</b> ) using <b>DHCPv6 stateful</b> , and optional information from OpenStack Networking ( <b>dnsmasq</b> ) using <b>DHCPv6 stateful</b> .
ipv6_ra_mode=dhcpv6-stateless	ipv6-address-mode=dhcpv6-stateless	The instance receives an IPv6 address from OpenStack Networking ( <b>radvd</b> ) using <b>SLAAC</b> , and optional information from OpenStack Networking ( <b>dnsmasq</b> ) using <b>DHCPv6 stateless</b> .

### 16.1.1. Create an IPv6 subnet using Stateful DHCPv6

This procedure makes use of the settings explained above to create an IPv6 subnet in a tenant network. The initial steps gather the necessary tenant and network information, then use this to construct a subnet creation command.



#### NOTE

OpenStack Networking only supports EUI-64 IPv6 address assignment for SLAAC. This allows for simplified IPv6 networking, as hosts will self-assign addresses based on the base 64-bits plus MAC address. Attempts to create subnets with a different netmask and *address\_assign\_type* of SLAAC will fail.

1. Retrieve the tenant id of the Project where you want to create the IPv6 subnet. These values are unique between OpenStack deployments, so your value will differ from the one supplied. In this example, the QA tenant will receive the IPv6 subnet.

```
# openstack project list
+-----+-----+
| ID                | Name    |
+-----+-----+
| 25837c567ed5458fbb441d39862e1399 | QA      |
| f59f631a77264a8eb0defc898cb836af | admin  |
| 4e2e1951e70643b5af7ed52f3ff36539 | demo   |
| 8561dff8310e4cd8be4b6fd03dc8acf5 | services |
+-----+-----+
```

2. Retrieve a list of all networks present in OpenStack Networking (neutron), and note the name of the network that will host the IPv6 subnet. In this example, *database-servers* will be used.

```
# neutron net-list
+-----+-----+-----+
| id | name | subnets |
+-----+-----+-----+
| 8357062a-0dc2-4146-8a7f-d2575165e363 | private | c17f74c4-db41-4538-af40-48670069af70 10.0.0.0/24 |
| 31d61f7d-287e-4ada-ac29-ed7017a54542 | public | 303ced03-6019-4e79-a21c-1942a460b920 172.24.4.224/28 |
| 6aff6826-4278-4a35-b74d-b0ca0cbba340 | database-servers |
+-----+-----+-----+
```

3. Use the QA tenant-id (**25837c567ed5458fbb441d39862e1399**) from the above steps to construct the network creation command. Another requirement is the name of the destination network that will host the IPv6 subnet. In this example, the *database-servers* network is used:

```
# neutron subnet-create --ip-version 6 --ipv6_address_mode=dhcpv6-stateful
--tenant-id 25837c567ed5458fbb441d39862e1399 database-servers
fdf8:f53b:82e4::53/125
```

Created a new subnet:

```
+-----+-----+-----+
| Field | Value |
+-----+-----+-----+
| allocation_pools | {"start": "fdf8:f53b:82e4::52", "end": "fdf8:f53b:82e4::56"} |
| cidr | fdf8:f53b:82e4::53/125 |
| dns_nameservers | |
| enable_dhcp | True |
| gateway_ip | fdf8:f53b:82e4::51 |
| host_routes | |
| id | cdffc3398-997b-46eb-9db1-ebbd88f7de05 |
| ip_version | 6 |
| ipv6_address_mode | dhcpv6-stateful |
| ipv6_ra_mode | |
| name | |
```

```

| network_id          | 6aff6826-4278-4a35-b74d-b0ca0cbba340
|
| tenant_id          | 25837c567ed5458fbb441d39862e1399
|
+-----+-----+
-----+

```

4. Validate this configuration by reviewing the network list. Note that the entry for *database-servers* now reflects the newly created IPv6 subnet:

```

# neutron net-list
+-----+-----+-----+-----+
-----+
| id                | name                | subnets
|
+-----+-----+-----+-----+
| 6aff6826-4278-4a35-b74d-b0ca0cbba340 | database-servers | cdfc3398-997b-46eb-9db1-ebbd88f7de05 fdf8:f53b:82e4::50/125 |
| 8357062a-0dc2-4146-8a7f-d2575165e363 | private          | c17f74c4-db41-4538-af40-48670069af70 10.0.0.0/24 |
| 31d61f7d-287e-4ada-ac29-ed7017a54542 | public          | 303ced03-6019-4e79-a21c-1942a460b920 172.24.4.224/28 |
+-----+-----+-----+-----+
-----+

```

As a result of this configuration, instances created by the QA tenant are able to receive a DHCP IPv6 address when added to the *database-servers* subnet:

```

# nova list
+-----+-----+-----+-----+-----+
---+-----+-----+-----+-----+
| ID                | Name                | Status | Task
State | Power State | Networks
+-----+-----+-----+-----+-----+
---+-----+-----+-----+-----+
| fad04b7a-75b5-4f96-aed9-b40654b56e03 | corp-vm-01 | ACTIVE | -
| Running          | database-servers=fd8:f53b:82e4::52 |
+-----+-----+-----+-----+-----+
---+-----+-----+-----+-----+

```

## CHAPTER 17. MANAGE TENANT QUOTAS

This chapter explains the management of Tenant/Project quotas for OpenStack Networking components.

OpenStack Networking (neutron) supports the use of quotas to constrain the number of resources created by tenants/projects. For example, you can limit the number of routers a tenant can create by changing the `quota_router` value in the `neutron.conf` file:

```
quota_router = 10
```

This configuration limits each tenant to a maximum of 10 routers.

Further quota settings are available for the various network components:

### 17.1. L3 quota options

Quota options available for L3 networking: `quota_floatingip` - Number of floating IPs allowed per tenant. `quota_network` - Number of networks allowed per tenant. `quota_port` - Number of ports allowed per tenant. `quota_router` - Number of routers allowed per tenant. `quota_subnet` - Number of subnets allowed per tenant. `quota_vip` - Number of vips allowed per tenant.

### 17.2. Firewall quota options

Quota options governing firewall management: `quota_firewall` - Number of firewalls allowed per tenant. `quota_firewall_policy` - Number of firewall policies allowed per tenant. `quota_firewall_rule` - Number of firewall rules allowed per tenant.

### 17.3. Security group quota options

Quota options for managing the permitted number of security groups: `quota_security_group` - Number of security groups allowed per tenant. `quota_security_group_rule` - Number of security group rules allowed per tenant.

### 17.4. Management quota options

Quota options for administrators to consider: `default_quota` - Default number of resource allowed per tenant. `quota_health_monitor` - Number of health monitors allowed per tenant. Health monitors do not consume resources, however the quota option is available due to the OpenStack Networking back end handling members as resource consumers. `quota_member` - Number of pool members allowed per tenant. Members do not consume resources, however the quota option is available due to the OpenStack Networking back end handling members as resource consumers. `quota_pool` - Number of pools allowed per tenant.

## CHAPTER 18. CONFIGURE FIREWALL-AS-A-SERVICE (FWAAS)

The Firewall-as-a-Service (FWaaS) plug-in adds perimeter firewall management to OpenStack Networking (neutron). FWaaS uses iptables to apply firewall policy to all virtual routers within a project, and supports one firewall policy and logical firewall instance per project.

FWaaS operates at the perimeter by filtering traffic at the OpenStack Networking (neutron) router. This distinguishes it from security groups, which operate at the instance level.

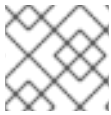

### NOTE

FWaaS is currently in Technology Preview; untested operation is not recommended.

The example diagram below illustrates the flow of ingress and egress traffic for the VM2 instance:

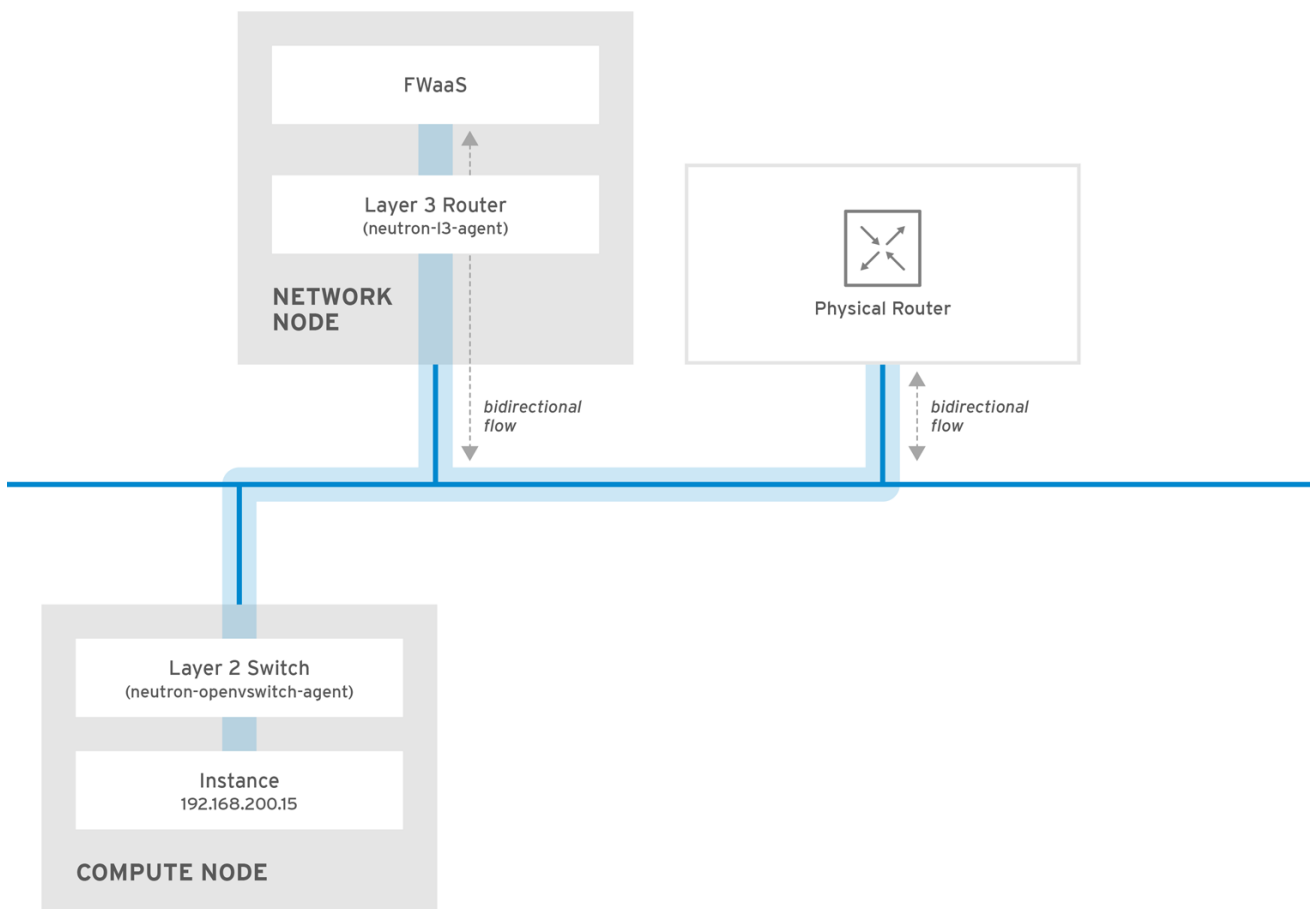

OPENSTACK\_450456\_0617

Figure 1. FWaaS architecture

### 18.1. Enable FWaaS

1. Install the FWaaS packages:

```
# yum install openstack-neutron-fwaas python-neutron-fwaas
```

2. Enable the FWaaS plugin in the `neutron.conf` file:

```
service_plugins = neutron.services.firewall.fwaas_plugin.FirewallPlugin
```

### 3. Configure FWaaS in the `fwaas_driver.ini` file:

```
[fwaas]
driver =
neutron.services.firewall.drivers.linux.iptables_fwaas.IptablesFwaasDriver
enabled = True

[service_providers]
service_provider =
LOADBALANCER:Haproxy:neutron_lbaas.services.loadbalancer.drivers.haproxy.p
ugin_driver.HaproxyOnHostPluginDriver:default
```

### 4. FWaaS management options are available in OpenStack dashboard. Enable this option in the `local_settings.py` file, usually located on the Controller node:

```
/usr/share/openstack-dashboard/openstack_dashboard/local/local_settings.py
'enable_firewall' = True
```

### 5. Restart `neutron-server` to apply the changes.

```
# systemctl restart neutron-server
```

## 18.2. Configure FWaaS

First create the firewall rules and create a policy to contain them, then create a firewall and apply the policy:

#### 1. Create a firewall rule:

```
$ neutron firewall-rule-create --protocol <tcp|udp|icmp|any> --
destination-port <port-range> --action <allow|deny>
```

The CLI requires a protocol value. If the rule is protocol agnostic, the *any* value can be used.

#### 2. Create a firewall policy:

```
$ neutron firewall-policy-create --firewall-rules "<firewall-rule IDs or
names separated by space>" myfirewallpolicy
```

The order of the rules specified above is important. You can create an empty firewall policy and add rules later, either with the update operation (when adding multiple rules) or with the insert-rule operations (when adding a single rule).

**Note:** FWaaS always adds a default deny all rule at the lowest precedence of each policy. Consequently, a firewall policy with no rules blocks all traffic by default.

## 18.3. Create a firewall

```
$ neutron firewall-create <firewall-policy-uuid>
```

The firewall remains in `PENDING_CREATE` state until an OpenStack Networking router is created, and an interface is attached.

## CHAPTER 19. CONFIGURE ALLOWED-ADDRESS-PAIRS

Allowed-address-pairs allow you to specify `mac_address/ip_address` (CIDR) pairs that pass through a port regardless of subnet. This enables the use of protocols such as VRRP, which floats an IP address between two instances to enable fast data plane failover.



### NOTE

The allowed-address-pairs extension is currently only supported by the ML2 and Open vSwitch plug-ins.

### 19.1. Basic allowed-address-pairs operations

Create a port and allow one address pair:

```
# neutron port-create net1 --allowed-address-pairs type=dict list=true
mac_address=<mac_address>,ip_address=<ip_cidr>
```

### 19.2. Adding allowed-address-pairs

```
# neutron port-update <port-uuid> --allowed-address-pairs type=dict
list=true mac_address=<mac_address>,ip_address=<ip_cidr>
```



### NOTE

OpenStack Networking prevents setting an allowed-address-pair that matches the `mac_address` and `ip_address` of a port. This is because such a setting would have no effect since traffic matching the `mac_address` and `ip_address` is already allowed to pass through the port.

# CHAPTER 20. CONFIGURE LAYER 3 HIGH AVAILABILITY

This chapter explains the role of Layer 3 High Availability in an OpenStack Networking deployment and includes implementation steps for protecting your network’s virtual routers.

## 20.1. OpenStack Networking without HA

An OpenStack Networking deployment without any high availability features is going to be vulnerable to physical node failures.

In a typical deployment, tenants create virtual routers, which are scheduled to run on physical L3 agent nodes. This becomes an issue when you lose a L3 agent node and the dependent virtual machines subsequently lose connectivity to external networks. Any floating IP addresses will also be unavailable. In addition, connectivity is also lost between any networks hosted by the router.

## 20.2. Overview of Layer 3 High Availability

This active/passive high availability configuration uses the industry standard VRRP (as defined in RFC 3768) to protect tenant routers and floating IP addresses. A virtual router is randomly scheduled across multiple OpenStack Networking nodes, with one designated as the *active*, and the remainder serving in a *standby* role.



### NOTE

A successful deployment of Layer 3 High Availability requires that the redundant OpenStack Networking nodes maintain similar configurations, including floating IP ranges and access to external networks.

In the diagram below, the active Router1 and Router2 are running on separate physical L3 agent nodes. Layer 3 High Availability has scheduled backup virtual routers on the corresponding nodes, ready to resume service in the case of a physical node failure. When the L3 agent node fails, Layer 3 High Availability reschedules the affected virtual router and floating IP addresses to a working node:

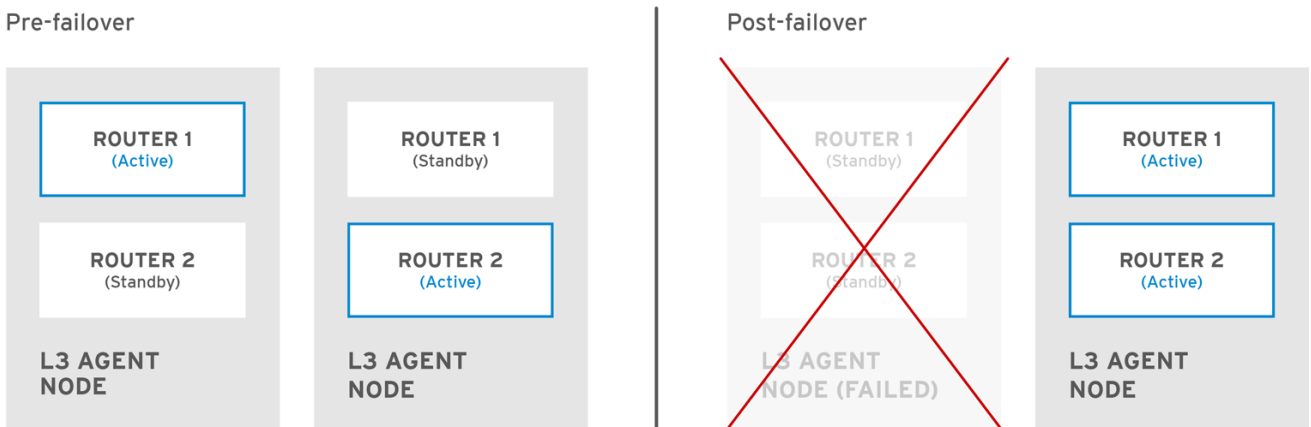

OPENSTACK\_450456\_0617

During a failover event, instance TCP sessions through floating IPs remain unaffected, and will migrate to the new L3 node without disruption. Only SNAT traffic is affected by failover events.

The L3 agent itself is further protected when in an active/active HA mode.

### 20.2.1. Failover conditions



Layer 3 High Availability will automatically reschedule protected resources in the following events:

- The L3 agent node shuts down or otherwise loses power due to hardware failure.
- L3 agent node becomes isolated from the physical network and loses connectivity.



#### NOTE

Manually stopping the L3 agent service does not induce a failover event.

### 20.3. Tenant considerations

Layer 3 High Availability configuration occurs in the back end and is invisible to the tenant. They can continue to create and manage their virtual routers as usual, however there are some limitations to be aware of when designing your Layer 3 High Availability implementation:

- Layer 3 High Availability supports up to 255 virtual routers per tenant.
- Internal VRRP messages are transported within a separate internal network, created automatically for each project. This process occurs transparently to the user.

### 20.4. Background changes

The Neutron API has been updated to allow administrators to set the `--ha=True/False` flag when creating a router, which overrides the (Default) configuration of `l3_ha` in `neutron.conf`. See the next section for the necessary configuration steps.

#### 20.4.1. Changes to neutron-server

- Layer 3 High Availability assigns the active role randomly, regardless of the scheduler used by OpenStack Networking (whether random or leastrouter).
- The database schema has been modified to handle allocation of VIPs to virtual routers.
- A transport network is created to direct Layer 3 High Availability traffic as described above.

#### 20.4.2. Changes to L3 agent

- A new keepalived manager has been added, providing load-balancing and HA capabilities.
- IP addresses are converted to VIPs.

### 20.5. Configuration Steps

This procedure enables Layer 3 High Availability on the OpenStack Networking and L3 agent nodes.

#### 20.5.1. Configure the OpenStack Networking node

1. Configure Layer 3 High Availability in the `neutron.conf` file by enabling L3 HA and defining the number of L3 agent nodes that should protect each virtual router:

```
l3_ha = True
max_l3_agents_per_router = 2
min_l3_agents_per_router = 2
```

These settings are explained below:

- **l3\_ha** - When set to True, all virtual routers created from this point onwards will default to HA (and not legacy) routers. Administrators can override the value for each router using:

```
# neutron router-create --ha=<True | False> routerName
```

- **max\_l3\_agents\_per\_router** - Set this to a value between the minimum and total number of network nodes in your deployment. For example, if you deploy four OpenStack Networking nodes but set max to 2, only two L3 agents will protect each HA virtual router: One active, and one standby. In addition, each time a new L3 agent node is deployed, additional standby versions of the virtual routers are scheduled until the `max_l3_agents_per_router` limit is reached. As a result, you can scale out the number of standby routers by adding new L3 agents.
- **min\_l3\_agents\_per\_router** - The min setting ensures that the HA rules remain enforced. This setting is validated during the virtual router creation process to ensure a sufficient number of L3 Agent nodes are available to provide HA. For example, if you have two network nodes and one becomes unavailable, no new routers can be created during that time, as you need at least min active L3 agents when creating a HA router.

2. Restart the `neutron-server` service for the change to take effect:

```
# systemctl restart neutron-server.service
```

### 20.5.2. Review your configuration

Running the `ip address` command within the virtual router namespace will now return a HA device in the result, prefixed with `ha-`.

```
# ip netns exec qrouter-b30064f9-414e-4c98-ab42-646197c74020 ip address
<snip>
2794: ha-45249562-ec: <BROADCAST,MULTICAST,UP,LOWER_UP> mtu 1500 qdisc
noqueue state DOWN group default
link/ether 12:34:56:78:2b:5d brd ff:ff:ff:ff:ff:ff
inet 169.254.0.2/24 brd 169.254.0.255 scope global ha-54b92d86-4f
```

With Layer 3 High Availability now enabled, virtual routers and floating IP addresses are protected against individual node failure.

## CHAPTER 21. USE TAGGING FOR VIRTUAL DEVICE IDENTIFICATION

If an instance is started with multiple network interfaces or block devices, you can use device tagging to communicate the intended role of each device to the instance operating system. Tags are assigned to devices at instance boot time, and are made available to the instance operating system through the metadata API and the config drive (if enabled).

The tags are set using the following parameters:

- `--block-device tag=device metadata`
- `--nic tag=device metadata`

For example, this command creates an instance using the tag parameters for `--block-device` and `--nic`:

```
$ nova boot test-vm --flavor m1.tiny --image cirros \
--nic net-id=55411ca3-83dd-4036-9158-bf4a6b8fb5ce,tag=nfv1 \
--block-device id=b8c9bef7-aa1d-4bf4-a14d-
17674b370e13,bus=virtio,tag=database-server NFVappServer
```

The resulting tags are added to the existing instance metadata and are made available through both the metadata API, and on the configuration drive. In the above example, the following `devices` section will appear in the metadata:

- Sample `meta_data.json`:

```
{
  "devices": [
    {
      "type": "nic",
      "bus": "pci",
      "address": "0030:00:02.0",
      "mac": "aa:00:00:00:01",
      "tags": ["nfv1"]
    },
    {
      "type": "disk",
      "bus": "pci",
      "address": "0030:00:07.0",
      "serial": "disk-vol-227",
      "tags": ["database-server"]
    }
  ]
}
```

The device tag metadata is available as `GET /openstack/latest/meta_data.json` from the metadata API. If the configuration drive is enabled, and mounted under `/configdrive` in the instance operating system, the metadata is also present in `/configdrive/openstack/latest/meta_data.json`.

## CHAPTER 22. SR-IOV SUPPORT FOR VIRTUAL NETWORKING

First introduced in RHEL OpenStack Platform 6, single root I/O virtualization (SR-IOV) support was extended to virtual machine networking. SR-IOV enables OpenStack to put aside the previous requirement for virtual bridges, and instead extends the physical NIC's capabilities directly through to the instance. In addition, support for IEEE 802.1br allows virtual NICs to integrate with, and be managed by, the physical switch.



### NOTE

For information on Network Function Virtualization (NFV), see [the NFV Configuration Guide](#).

### 22.1. Configure SR-IOV in your Red Hat OpenStack Platform deployment

SR-IOV adds support for the concept of a *virtual function* which, while presented as a PCI device on the hardware, is a *virtual interface* that is provided by the *physical function*.

This chapter contains procedures for configuring SR-IOV to pass a physical NIC through to a virtual instance. These steps assume a deployment using a Controller node, an OpenStack Networking (neutron) node, and multiple Compute (nova) nodes.

**Note:** Virtual machine instances using SR-IOV virtual function (VF) ports and virtual machine instances using regular ports (for example, linked to Open vSwitch bridge), can communicate with each other across the network assuming that the appropriate L2 configuration (flat, VLAN) is in place. At present, there is a limitation where instances using SR-IOV ports and instances using regular vSwitch ports which reside on the same Compute node cannot communicate with each other if they are sharing the same Physical Function (PF) on the network adapter.

### 22.2. Create Virtual Functions on the Compute node

Perform these steps on all Compute nodes with supported hardware.

**Note:** Please refer to this [article](#) for details on supported drivers.

This procedure configures a system to passthrough an *Intel 82576* network device. Virtual Functions are also created, which can then be used by instances for SR-IOV access to the device.

1. Ensure that **Intel VT-d** or **AMD IOMMU** are enabled in the system's BIOS. Refer to the machine's BIOS configuration menu, or other means available from the manufacturer.
2. Ensure that *Intel VT-d* or *AMD IOMMU* are enabled in the operating system:
  - For *Intel VT-d* systems, refer to the procedure [here](#).
  - For *AMD IOMMU* systems, refer to the procedure [here](#).

3. Run the `lspci` command to ensure the network device is recognized by the system:

```
[root@compute ~]# lspci | grep 82576
```

The network device is included in the results:

```
03:00.0 Ethernet controller: Intel Corporation 82576 Gigabit Network
Connection (rev 01)
```

```
03:00.1 Ethernet controller: Intel Corporation 82576 Gigabit Network
Connection (rev 01)
```

4. Perform these steps to activate Virtual Functions on the Compute node:

4a. Remove the kernel module. This will allow it to be configured in the next step:

```
[root@compute ~]# modprobe -r igb
```

**Note:** The module used by the SRIOV-supported NIC should be used in step 4, rather than `igb` for other NICs (for example, `ixgbe` or `m1x4_core`). Confirm the driver by running the `ethtool` command. In this example, `em1` is the PF to use:

```
[root@compute ~]# ethtool -i em1 | grep ^driver
```

4b. Start the module with `max_vfs` set to 7 (or up to the maximum supported).

```
[root@compute ~]# modprobe igb max_vfs=7
```

4c. Make the Virtual Functions persistent:

```
[root@compute ~]# echo "options igb max_vfs=7" >>/etc/modprobe.d/igb.conf
```

**Note:** For Red Hat Enterprise Linux 7, to make the aforementioned changes persistent, [rebuild the initial ramdisk image](#) after completing step 4.

**Note:** Regarding the persistence of the settings in steps 4c. and 4d.: The `modprobe` command enables Virtual Functions on all NICs that use the same kernel module, and makes the change persist through system reboots. It is possible to enable VFs for only a specific NIC, however there are some possible issues that can result. For example, this command enables VFs for the `enp4s0f1` interface:

```
# echo 7 > /sys/class/net/enp4s0f1/device/sriov_numvfs
```

However, this setting will not persist after a reboot. A possible workaround is to add this to `rc.local`, but this has its own limitation, as described in the note below:

```
# chmod +x /etc/rc.d/rc.local
# echo "echo 7 > /sys/class/net/enp4s0f1/device/sriov_numvfs" >>
/etc/rc.local
```

**Note:** Since the addition of `systemd`, Red Hat Enterprise Linux starts services in parallel, rather than in series. This means that `rc.local` no longer executes at a predictable point in the boot process. As a result, unexpected behavior can occur, and this configuration is not recommended.

4d. Activate Intel VT-d in the kernel by appending the `intel_iommu=pt` and `igb.max_vfs=7` parameters to the kernel command line. You can either change your current settings if you are going to always boot the kernel this way, or you can create a custom menu entry with these parameters, in which case your system will boot with these parameters by default, but you will also be able to boot the kernel without these parameters if need be.

- To change your current kernel command line parameters, run the following command:

```
[root@compute ~]# grubby --update-kernel=ALL --args="intel_iommu=pt
igb.max_vfs=7"
```

For more information on using *grubby*, see [Configuring GRUB 2 Using the grubby Tool](#) in the System Administrator's Guide.

**Note:** If using a *Dell Power Edge R630* node, you will need to use `intel_iommu=on` instead of `intel_iommu=pt`. You can enable this using *grubby*:

```
# grubby --update-kernel=ALL --args="intel_iommu=on"
```

- To create a custom menu entry:

- i. Find the default entry in *grub*:

```
[root@compute ~]# grub2-editenv list
saved_entry=Red Hat Enterprise Linux Server (3.10.0-123.9.2.el7.x86_64)
7.0 (Maipo)
```

- ii. a. Copy the desired *menuentry* starting with the value of `saved_entry` from `/boot/grub2/grub.cfg` to `/etc/grub.d/40_custom`. The entry begins with the line starting with "menuentry" and ends with a line containing "}" b. Change the title after *menuentry* c. Add `intel_iommu=pt igb.max_vfs=7` to the end of the line starting with `linux16`.

For example:

```
menuentry 'Red Hat Enterprise Linux Server, with Linux 3.10.0-
123.el7.x86_64 - SRIOV' --class red --class gnu-linux --class gnu --class
os --unrestricted $menuentry_id_option 'gnulinux-3.10.0-123.el7.x86_64-
advanced-4718717c-73ad-4f5f-800f-f415adfcd01' {
    load_video
    set gfxpayload=keep
    insmod gzio
    insmod part_msdos
    insmod ext2
    set root='hd0,msdos2'
    if [ x$feature_platform_search_hint = xy ]; then
        search --no-floppy --fs-uuid --set=root --hint-bios=hd0,msdos2 --
hint-efi=hd0,msdos2 --hint-baremetal=ahci0,msdos2 --hint='hd0,msdos2'
5edd1db4-1ebc-465c-8212-552a9c97456e
    else
        search --no-floppy --fs-uuid --set=root 5edd1db4-1ebc-465c-8212-
552a9c97456e
    fi
    linux16 /vmlinuz-3.10.0-123.el7.x86_64 root=UUID=4718717c-73ad-4f5f-
800f-f415adfcd01 ro vconsole.font=latarcyrheb-sun16 biosdevname=0
crashkernel=auto vconsole.keymap=us nofb console=ttyS0,115200
LANG=en_US.UTF-8 intel_iommu=pt igb.max_vfs=7
    initrd16 /initramfs-3.10.0-123.el7.x86_64.img
}
```

- iii. Update *grub.cfg* to apply the change config file:

```
[root@compute ~]# grub2-mkconfig -o /boot/grub2/grub.cfg
```

## iv. Change the default entry:

```
[root@compute ~]# grub2-set-default 'Red Hat Enterprise Linux Server, with
Linux 3.10.0-123.el7.x86_64 - SRIOV'
```

v. Create the *dist.conf* configuration file.

**Note:** Before performing this step, review the section describing the effects of `allow_unsafe_interrupts`: *Review the `allow_unsafe_interrupts` setting.*

```
[root@compute ~]# echo "options vfio_iommu_type1
allow_unsafe_interrupts=1" > /etc/modprobe.d/dist.conf
```

## 5. Reboot the server to apply the new kernel parameters:

```
[root@compute ~]# systemctl reboot
```

6. Review the SR-IOV kernel module on the Compute node. Confirm that the module has been loaded by running *lsmod*:

```
[root@compute ~]# lsmod |grep igb
```

The filtered results will include the necessary module:

```
igb      87592  0
dca      6708   1 igb
```

7. Review the PCI vendor ID Make a note of the PCI vendor ID (in `vendor_id:product_id` format) of your network adapter. Extract this from the output of the *lspci* command using the `-nn` flag. For example:

```
[root@compute ~]# lspci -nn | grep -i 82576
05:00.0 Ethernet controller [0200]: Intel Corporation 82576 Gigabit
Network Connection [8086:10c9] (rev 01)
05:00.1 Ethernet controller [0200]: Intel Corporation 82576 Gigabit
Network Connection [8086:10c9] (rev 01)
05:10.0 Ethernet controller [0200]: Intel Corporation 82576 Virtual
Function [8086:10ca] (rev 01)
```

**Note:** This parameter may differ depending on your network adapter hardware.

8. Review the new Virtual Functions Use *lspci* to list the newly-created VFs:

```
[root@compute ~]# lspci | grep 82576
```

The results will now include the device plus the Virtual Functions:

```
0b:00.0 Ethernet controller: Intel Corporation 82576 Gigabit Network
Connection (rev 01)
0b:00.1 Ethernet controller: Intel Corporation 82576 Gigabit Network
Connection(rev 01)
0b:10.0 Ethernet controller: Intel Corporation 82576 Virtual Function (rev
01)
0b:10.1 Ethernet controller: Intel Corporation 82576 Virtual Function (rev
```

```

01)
0b:10.2 Ethernet controller: Intel Corporation 82576 Virtual Function (rev
01)
0b:10.3 Ethernet controller: Intel Corporation 82576 Virtual Function (rev
01)
0b:10.4 Ethernet controller: Intel Corporation 82576 Virtual Function (rev
01)
0b:10.5 Ethernet controller: Intel Corporation 82576 Virtual Function (rev
01)
0b:10.6 Ethernet controller: Intel Corporation 82576 Virtual Function (rev
01)
0b:10.7 Ethernet controller: Intel Corporation 82576 Virtual Function (rev
01)
0b:11.0 Ethernet controller: Intel Corporation 82576 Virtual Function (rev
01)
0b:11.1 Ethernet controller: Intel Corporation 82576 Virtual Function (rev
01)
0b:11.2 Ethernet controller: Intel Corporation 82576 Virtual Function (rev
01)
0b:11.3 Ethernet controller: Intel Corporation 82576 Virtual Function (rev
01)
0b:11.4 Ethernet controller: Intel Corporation 82576 Virtual Function (rev
01)
0b:11.5 Ethernet controller: Intel Corporation 82576 Virtual Function (rev
01)

```

### 22.3. Configure SR-IOV on the Network Node

OpenStack Networking (neutron) uses a ML2 mechanism driver to support SR-IOV. Perform these steps on the Network node to configure the SR-IOV driver. In this procedure, you add the mechanism driver, ensure that `vlan` is among the enabled drivers, and then define the VLAN ranges:

1. Enable `sriovnicswitch` in the `/etc/neutron/plugins/ml2/ml2_conf.ini` file. For example, this configuration enables the SR-IOV mechanism driver alongside Open vSwitch.

**Note:** `sriovnicswitch` does not support the current interface drivers for `DHCP Agent`, so `openvswitch` (or other mechanism driver with VLAN support) is a requirement when using `sriovnicswitch`.

```

[ml2]
tenant_network_types = vlan
type_drivers = vlan
mechanism_drivers = openvswitch, sriovnicswitch
[ml2_type_vlan]
network_vlan_ranges = physnet1:15:20

```

- `network_vlan_ranges` - In this example, `physnet1` is used as the network label, followed by the specified VLAN range of `15-20`.

**Note:** The mechanism driver `sriovnicswitch` currently supports only the `flat` and `vlan` drivers. However, enabling `sriovnicswitch` does not limit you to only having `flat` or `vlan` tenant networks. VXLAN and GRE, among others, can still be used for instances that are not using SR-IOV ports.

2. Optional - The supported `vendor_id/product_id` couples are `15b3:1004`, `8086:10ca`. Specify your NIC vendor's product ID if it differs from these. In addition, you will need to modify this list if PF passthrough is being used. For example:



```
[ml2_sriov]
supported_pci_vendor_devs = 15b3:1004,8086:10ca
```

3. Restart the *neutron-server* service to apply the configuration:

```
[root@network ~]# systemctl restart neutron-server.service
```

## 22.4. Configure SR-IOV on the Controller Node

1. To allow proper scheduling of SR-IOV devices, the Compute scheduler needs to use *FilterScheduler* with the *PciPassthroughFilter* filter. Apply this configuration in the *nova.conf* file on the Controller node. For example:

```
scheduler_available_filters=nova.scheduler.filters.all_filters
scheduler_default_filters=RetryFilter,AvailabilityZoneFilter,RamFilter,Com
puteFilter,ComputeCapabilitiesFilter,ImagePropertiesFilter,CoreFilter,
PciPassthroughFilter
```

2. Restart the Compute scheduler to apply the change:

```
[root@compute ~]# systemctl restart openstack-nova-scheduler.service
```

## 22.5. Configure SR-IOV in Compute

On all Compute nodes, associate the available VFs with each physical network:

1. Define the entries in the *nova.conf* file. This example adds the VF network matching *enp5s0f1*, and tags *physical\_network* as *physnet1*, the network label previously configured in *network\_vlan\_ranges*.

```
pci_passthrough_whitelist={"devname": "enp5s0f1",
"physical_network": "physnet1"}
```

This example adds the PF network matching vendor ID *8086*, and tags *physical\_network* as *physnet1*:

```
pci_passthrough_whitelist = {"vendor_id": "8086", "product_id": "10ac",
"physical_network": "physnet1"} ~
```

PCI passthrough whitelist entries use the following syntax:

```
[ "device_id": "<id>", ] [ "product_id": "<id>", ]
[ "address": "[[[[<domain>]:]<bus>]:][<slot>][.[<function>]]" |
"devname": "Ethernet Interface Name", ]
"physical_network": "Network label string"
```

- **id** - The *id* setting accepts the *\** wildcard value, or a valid device/product id. You can use *lspci* to list the valid device names.
- **address** - The *address* value uses the same syntax as displayed by *lspci* using the *-s* switch.
- **devname** - The *devname* is a valid PCI device name. You can list the available names using *ifconfig -a*. This entry must correspond to either a PF or VF value that is associated with a vNIC. If the device defined by the *address* or *devname* corresponds to a SR-IOV PF, all the VFs under the PF will match the entry. It is possible to associate 0 or more tags with an entry.

- **physical\_network** - When using SR-IOV networking, "physical\_network" is used to define the physical network that devices are attached to.

You can configure multiple whitelist entries per host. The fields *device\_id*, *product\_id*, and *address* or *devname* will be matched against PCI devices that are returned as a result of querying libvirt.

2. Apply the changes by restarting the *nova-compute* service:

```
[root@compute ~]# systemctl restart openstack-nova-compute
```

## 22.6. Enable the OpenStack Networking SR-IOV agent

1. Install the *sriov-nic-agent* package in order to complete the following steps:

```
[root@compute ~]# yum install openstack-neutron-sriov-nic-agent
```

2. Enable *NoopFirewallDriver* in the */etc/neutron/plugins/ml2/openvswitch\_agent.ini* file:

```
[root@compute ~]# openstack-config --set
/etc/neutron/plugins/ml2/openvswitch_agent.ini securitygroup
firewall_driver neutron.agent.firewall.NoopFirewallDriver
```

3. Add mappings to the */etc/neutron/plugins/ml2/sriov\_agent.ini* file. In this example, *physnet1* is the physical network, and *enp4s0f1* is the physical function. Leave *exclude\_devices* blank to allow the agent to manage all associated VFs.

```
[sriov_nic]
physical_device_mappings = physnet1:enp4s0f1
exclude_devices =
```

4. *Optional* - Exclude VFs To exclude specific VFs from agent configuration, list them in the *sriov\_nic* section. For example:

```
exclude_devices = eth1:0000:07:00.2; 0000:07:00.3, eth2:0000:05:00.1;
0000:05:00.2
```

5. Start the OpenStack Networking SR-IOV agent:

```
[root@compute ~]# systemctl enable neutron-sriov-nic-agent.service
[root@compute ~]# systemctl start neutron-sriov-nic-agent.service
```

## 22.7. Configure an instance to use the SR-IOV port

### Overview of SR-IOV functions

Using SR-IOV, you can give an instance direct access to a NIC by using Physical Functions (PFs) and Virtual Functions (VFs). PFs use VFs to allow multiple instances to have direct access to the same PCI card. As a result, the PCI card can be thought of as being logically partitioned into VFs for use by multiple instances. SR-IOV is thereby different to PCI passthrough, which only allows one instance to have exclusive access to the PCI device.

**NOTE**

SR-IOV NICs cannot concurrently bind to instances when using both PFs and VFs. Due to memory address protection, an instance should not have control of the PF if other instances are using VFs. In other words, unless a single instance is using the card by binding directly to the PF (almost equivalent to PCI passthrough), in most cases neutron will pass VFs to instances and let the host control the PF.

**Limitations of Virtual Functions**

- Physical Function passthrough might be more appropriate for certain use cases. For example:
  - Residential vCPE
  - BNG/BRAS (IPoE or PPPoE)
  - PE for VPLS or VLL
  - VPN L3 (using multiple VLANs by port)
  - Other use cases where specific traffic handling is required, depending on level 2 encapsulation. For example, QinQ encapsulation for MAN networks.
- When using VFs, your server NIC port may end up blocking traffic. This is expected behavior that helps mitigate spoofing attacks from instances sharing VFs from the same NIC. As a result, your NIC vendor might recommend allowing promiscuous unicast, disabling antispoofing, and disabling ingress VLAN filtering.
- A NIC should be configured to use either physical functions or virtual functions; not both at the same time.

**Example configuration**

In this example, the SR-IOV port is added to the **web** network.

**1. Retrieve the list of available networks:**

```
[root@network ~]# neutron net-list
+-----+-----+-----+
| id                | name  | subnets
|
+-----+-----+-----+
| 3c97eb09-957d-4ed7-b80e-6f052082b0f9 | corp  | 78328449-796b-49cc-96a8-1daba7a910be 172.24.4.224/28 |
| 721d555e-c2e8-4988-a66f-f7cbe493afdb | web   | 140e936e-0081-4412-a5ef-d05bacf3d1d7 10.0.0.0/24   |
+-----+-----+-----+
```

The result lists the networks that have been created in OpenStack Networking, and includes subnet details.

**2. Create the port inside the **web** network:**

```
[root@network ~]# neutron port-create web --name sr-iov --binding:vnic-
type direct
Created a new port:
+-----+-----+
| Field                | Value
|
+-----+-----+
| admin_state_up      | True
|
| allowed_address_pairs |
|
| binding:host_id      |
|
| binding:profile      | {}
|
| binding:vif_details  | {}
|
| binding:vif_type     | unbound
|
| binding:vnic_type    | normal
|
| device_id            |
|
| device_owner         |
|
| fixed_ips            | {"subnet_id": "140e936e-0081-4412-a5ef-
d05bacf3d1d7", "ip_address": "10.0.0.2"}
|
| id                   | a2122b4d-c9a9-4a40-9b67-ca514ea10a1b
|
| mac_address          | fa:16:3e:b1:53:b3
|
| name                 | sr-iov
|
| network_id           | 721d555e-c2e8-4988-a66f-f7cbe493afdb
|
| security_groups      | 3f06b19d-ec28-427b-8ec7-db2699c63e3d
|
| status               | DOWN
|
| tenant_id            | 7981849293f24ed48ed19f3f30e69690
|
+-----+-----+
|-----|
```

### 3. Create an instance using the new port.

Create a new instance named *webserver01*, and configure it to use the new port, using the port ID from the previous output in the *id* field:

**Note:** You can retrieve a list of available images and their UUIDs using the *glance image-list* command.

```
[root@compute ~]# nova boot --flavor m1.tiny --image 59a66200-45d2-4b21-
982b-d06bc26ff2d0 --nic port-id=a2122b4d-c9a9-4a40-9b67-ca514ea10a1b
webserver01
```

Your new instance *webserver01* has been created and configured to use the SR-IOV port.

## 22.8. Review the `allow_unsafe_interrupts` setting

Platform support for interrupt remapping is required to fully isolate a guest with assigned devices from the host. Without such support, the host may be vulnerable to interrupt injection attacks from a malicious guest. In an environment where guests are trusted, the admin may opt-in to still allow PCI device assignment using the `allow_unsafe_interrupts` option. Review whether you need to enable `allow_unsafe_interrupts` on your host. If the IOMMU on the host supports interrupt remapping, then there is no need to enable this feature.

1. Use `dmesg` to confirm whether your host supports IOMMU interrupt remapping:

```
[root@compute ~]# dmesg |grep ecap
```

If bit 3 of the `ecap` (`0xf020ff` → ...1111) is 1, this indicates that the IOMMU supports interrupt remapping.

2. Confirm whether IRQ remapping is enabled:

```
[root@compute ~]# dmesg |grep "Enabled IRQ"
[    0.033413] Enabled IRQ remapping in x2apic mode
```

**Note:** "IRQ remapping" can be disabled manually by adding `intremap=off` to `grub.conf`.

3. If the host's IOMMU does not support interrupt remapping, you will need to enable `allow_unsafe_assigned_interrupts=1` in the `kvm` module.

## 22.9. Add a Physical Function to an Instance

You can configure Compute to expose Physical Functions (PFs) to instances. This use case helps NFV applications by granting instances full control over the physical port, allowing them to use some of the functionality not available to Virtual Functions (VF). These instances can then bypass some of the limitations certain cards impose on VFs, or can exclusively use the full bandwidth of the port.

In the event that none of the child VFs are assigned to instances, compute can allow the assignment of a free PF to instances. Once a PF is assigned, then none of its VFs will be available. The VFs will be available again once the instance is shutdown and the PF becomes free. This also works in reverse: Compute will prevent a PF from being assigned if one of its VFs is already assigned.

### 22.9.1. Configure Compute for Physical Functions

Expose the physical functions by adding `device_type: type-PF` to your `nova.conf` whitelist. For example:

```
pci_passthrough_whitelist={"product_id":"10ed", "vendor_id":"8086",
"physical_network":"physnet1", 'device_type': 'type-PF}
```

### 22.9.2. Configure Physical Functions

You can manage SR-IOV PFs as if they were neutron ports. Neutron supports the `vnic_type` of `direct-physical`, with the resulting vNIC then used by nova to select a PF on a host and perform passthrough to a guest (using the new VIF type). As a result, nova will update the neutron port with the MAC address of the selected PF on the host.

For example, to create a PF on a network called **Network1**:

```
$ neutron port-create Network1 --name pf-port --binding:vnic_type direct-physical
```

You can then attach the resulting port to an instance for PF access.

### 22.9.3. Expose SR-IOV physical functions VLAN Tags to Guests

Solutions that require access to physical functions may also need to manipulate network settings in the same way as they would with the virtual functions. Although network awareness for the passed-through physical functions has been implemented for some time, the VLAN tags, set on the associated neutron port, were ignored. The latest release of Red Hat OpenStack Platform changes this behavior and sends the VLAN tags information to the instances.

The following example shows the way in which the guest operating system will receive the VLAN related information:

```
{
  "devices": [
    {
      "type": "nic",
      "bus": "pci",
      "address": "0000:00:02.0",
      "mac": "01:22:22:42:22:21",
      "tags": ["nfvfunc1"]
      "vlan": 1000
    }..., ]
}
```

You can use the provided information to set up the network connection, for example by creating a corresponding configuration in a `ifcfg-<name>` file.

While it is possible to control the traffic going to virtual functions by using the provided VLAN tags to filter out any unwanted packets, there is no such mechanism in Compute or Networking that would be able to provide same functionality to physical functions, because the operating system user has no control over either the physical interface or the physical connection to the switch.

It is therefore important that administrators manually set up the physical network, mapped to the whitelisted PCI device, to allow only traffic that is intended for the particular user or tenant. For instance, you can make the necessary network separation to secure the setup by configuring the top-of-rack switches to map specific PCI devices to physical networks.

## 22.10. Additional considerations

- When selecting a vNIC type, note that `vnic_type=macvtap` is not currently supported.
- VM migration with SR-IOV attached instances is not supported.
- Security Groups can not currently be used with SR-IOV enabled ports.