



# OpenShift Container Platform 4.10

## Installing

Installing and configuring OpenShift Container Platform clusters





# OpenShift Container Platform 4.10 Installing

---

Installing and configuring OpenShift Container Platform clusters

## Legal Notice

Copyright © 2023 Red Hat, Inc.

The text of and illustrations in this document are licensed by Red Hat under a Creative Commons Attribution–Share Alike 3.0 Unported license ("CC-BY-SA"). An explanation of CC-BY-SA is available at

<http://creativecommons.org/licenses/by-sa/3.0/>

. In accordance with CC-BY-SA, if you distribute this document or an adaptation of it, you must provide the URL for the original version.

Red Hat, as the licensor of this document, waives the right to enforce, and agrees not to assert, Section 4d of CC-BY-SA to the fullest extent permitted by applicable law.

Red Hat, Red Hat Enterprise Linux, the Shadowman logo, the Red Hat logo, JBoss, OpenShift, Fedora, the Infinity logo, and RHCE are trademarks of Red Hat, Inc., registered in the United States and other countries.

Linux<sup>®</sup> is the registered trademark of Linus Torvalds in the United States and other countries.

Java<sup>®</sup> is a registered trademark of Oracle and/or its affiliates.

XFS<sup>®</sup> is a trademark of Silicon Graphics International Corp. or its subsidiaries in the United States and/or other countries.

MySQL<sup>®</sup> is a registered trademark of MySQL AB in the United States, the European Union and other countries.

Node.js<sup>®</sup> is an official trademark of Joyent. Red Hat is not formally related to or endorsed by the official Joyent Node.js open source or commercial project.

The OpenStack<sup>®</sup> Word Mark and OpenStack logo are either registered trademarks/service marks or trademarks/service marks of the OpenStack Foundation, in the United States and other countries and are used with the OpenStack Foundation's permission. We are not affiliated with, endorsed or sponsored by the OpenStack Foundation, or the OpenStack community.

All other trademarks are the property of their respective owners.

## Abstract

This document provides information about installing OpenShift Container Platform and details about some configuration processes.

## Table of Contents

<b>CHAPTER 1. OPENSIFT CONTAINER PLATFORM INSTALLATION OVERVIEW .....</b>	<b>70</b>
1.1. OPENSIFT CONTAINER PLATFORM INSTALLATION OVERVIEW	70
1.1.1. Installation process	71
The installation process with installer-provisioned infrastructure	72
The installation process with user-provisioned infrastructure	73
Installation process details	73
1.1.2. Verifying node state after installation	74
Installation scope	76
1.1.3. OpenShift Local overview	76
1.2. SUPPORTED PLATFORMS FOR OPENSIFT CONTAINER PLATFORM CLUSTERS	76
<b>CHAPTER 2. SELECTING A CLUSTER INSTALLATION METHOD AND PREPARING IT FOR USERS .....</b>	<b>79</b>
2.1. SELECTING A CLUSTER INSTALLATION TYPE	79
2.1.1. Do you want to install and manage an OpenShift Container Platform cluster yourself?	79
2.1.2. Have you used OpenShift Container Platform 3 and want to use OpenShift Container Platform 4?	80
2.1.3. Do you want to use existing components in your cluster?	80
2.1.4. Do you need extra security for your cluster?	81
2.2. PREPARING YOUR CLUSTER FOR USERS AFTER INSTALLATION	81
2.3. PREPARING YOUR CLUSTER FOR WORKLOADS	81
2.4. SUPPORTED INSTALLATION METHODS FOR DIFFERENT PLATFORMS	82
<b>CHAPTER 3. DISCONNECTED INSTALLATION MIRRORING .....</b>	<b>86</b>
3.1. ABOUT DISCONNECTED INSTALLATION MIRRORING	86
3.1.1. Creating a mirror registry	86
3.1.2. Mirroring images for a disconnected installation	86
3.2. CREATING A MIRROR REGISTRY WITH MIRROR REGISTRY FOR RED HAT OPENSIFT	86
3.2.1. Prerequisites	86
3.2.2. Mirror registry for Red Hat OpenShift introduction	87
3.2.3. Mirroring on a local host with mirror registry for Red Hat OpenShift	87
3.2.4. Updating mirror registry for Red Hat OpenShift from a local host	88
3.2.5. Mirroring on a remote host with mirror registry for Red Hat OpenShift	89
3.2.6. Updating mirror registry for Red Hat OpenShift from a remote host	91
3.2.7. Uninstalling the mirror registry for Red Hat OpenShift	91
3.2.8. Mirror registry for Red Hat OpenShift flags	91
3.2.9. Mirror registry for Red Hat OpenShift release notes	93
3.2.9.1. Mirror registry for Red Hat OpenShift 1.3.8	93
3.2.9.2. Mirror registry for Red Hat OpenShift 1.3.7	93
3.2.9.3. Mirror registry for Red Hat OpenShift 1.3.6	93
3.2.9.4. Mirror registry for Red Hat OpenShift 1.3.5	94
3.2.9.5. Mirror registry for Red Hat OpenShift 1.3.4	94
3.2.9.6. Mirror registry for Red Hat OpenShift 1.3.3	94
3.2.9.7. Mirror registry for Red Hat OpenShift 1.3.2	94
3.2.9.8. Mirror registry for Red Hat OpenShift 1.3.1	94
3.2.9.9. Mirror registry for Red Hat OpenShift 1.3.0	94
3.2.9.9.1. New features	95
3.2.9.9.2. Bug fixes	95
3.2.9.10. Mirror registry for Red Hat OpenShift 1.2.9	95
3.2.9.11. Mirror registry for Red Hat OpenShift 1.2.8	95
3.2.9.12. Mirror registry for Red Hat OpenShift 1.2.7	96
3.2.9.12.1. Bug fixes	96
3.2.9.13. Mirror registry for Red Hat OpenShift 1.2.6	96

3.2.9.13.1. New features	96
3.2.9.14. Mirror registry for Red Hat OpenShift 1.2.5	96
3.2.9.15. Mirror registry for Red Hat OpenShift 1.2.4	96
3.2.9.16. Mirror registry for Red Hat OpenShift 1.2.3	96
3.2.9.17. Mirror registry for Red Hat OpenShift 1.2.2	97
3.2.9.18. Mirror registry for Red Hat OpenShift 1.2.1	97
3.2.9.19. Mirror registry for Red Hat OpenShift 1.2.0	97
3.2.9.19.1. Bug fixes	97
3.2.9.20. Mirror registry for Red Hat OpenShift 1.1.0	97
3.2.9.20.1. New features	97
3.2.9.20.2. Bug fixes	97
3.2.10. Troubleshooting mirror registry for Red Hat OpenShift	98
3.3. MIRRORING IMAGES FOR A DISCONNECTED INSTALLATION	98
3.3.1. Prerequisites	99
3.3.2. About the mirror registry	99
3.3.3. Preparing your mirror host	100
3.3.3.1. Installing the OpenShift CLI by downloading the binary	100
Installing the OpenShift CLI on Linux	100
Installing the OpenShift CLI on Windows	101
Installing the OpenShift CLI on macOS	101
3.3.4. Configuring credentials that allow images to be mirrored	102
3.3.5. Mirroring the OpenShift Container Platform image repository	104
3.3.6. The Cluster Samples Operator in a disconnected environment	107
3.3.6.1. Cluster Samples Operator assistance for mirroring	107
3.3.7. Mirroring Operator catalogs for use with disconnected clusters	108
3.3.7.1. Prerequisites	109
3.3.7.2. Extracting and mirroring catalog contents	109
3.3.7.2.1. Mirroring catalog contents to registries on the same network	109
3.3.7.2.2. Mirroring catalog contents to airgapped registries	111
3.3.7.3. Generated manifests	113
3.3.7.4. Post-installation requirements	114
3.3.8. Next steps	114
3.3.9. Additional resources	115
3.4. MIRRORING IMAGES FOR A DISCONNECTED INSTALLATION USING THE OC-MIRROR PLUGIN	115
3.4.1. About the oc-mirror plugin	115
3.4.2. About the mirror registry	116
3.4.3. Prerequisites	117
3.4.4. Preparing your mirror hosts	117
3.4.4.1. Installing the oc-mirror OpenShift CLI plugin	117
3.4.4.2. Configuring credentials that allow images to be mirrored	118
3.4.5. Creating the image set configuration	120
3.4.6. Mirroring an image set to a mirror registry	121
3.4.6.1. Mirroring an image set in a partially disconnected environment	122
3.4.6.1.1. Mirroring from mirror to mirror	122
3.4.6.2. Mirroring an image set in a fully disconnected environment	123
3.4.6.2.1. Mirroring from mirror to disk	123
3.4.6.2.2. Mirroring from disk to mirror	124
3.4.7. Configuring your cluster to use the resources generated by oc-mirror	125
3.4.8. Updating your mirror registry	126
3.4.9. Image set configuration parameters	127
3.4.10. Image set configuration examples	131
Use case: Including arbitrary images and helm charts	131
Use case: Including specific Operator versions	132

3.4.11. Command reference for oc-mirror	132
<b>CHAPTER 4. INSTALLING ON ALIBABA</b>	<b>134</b>
4.1. PREPARING TO INSTALL ON ALIBABA CLOUD	134
4.1.1. Prerequisites	134
4.1.2. Requirements for installing OpenShift Container Platform on Alibaba Cloud	134
4.1.3. Registering and Configuring Alibaba Cloud Domain	134
4.1.4. Supported Alibaba regions	135
4.1.5. Next steps	135
4.2. CREATING THE REQUIRED ALIBABA CLOUD RESOURCES	135
4.2.1. Creating the required RAM user	135
4.2.2. Configuring the Cloud Credential Operator utility	140
4.2.3. Next steps	141
4.3. INSTALLING A CLUSTER QUICKLY ON ALIBABA CLOUD	141
4.3.1. Prerequisites	142
4.3.2. Internet access for OpenShift Container Platform	142
4.3.3. Generating a key pair for cluster node SSH access	142
4.3.4. Obtaining the installation program	144
4.3.5. Creating the installation configuration file	145
4.3.6. Generating the required installation manifests	147
4.3.7. Creating credentials for OpenShift Container Platform components with the ccoctl tool	147
4.3.8. Deploying the cluster	150
4.3.9. Installing the OpenShift CLI by downloading the binary	151
Installing the OpenShift CLI on Linux	151
Installing the OpenShift CLI on Windows	152
Installing the OpenShift CLI on macOS	152
4.3.10. Logging in to the cluster by using the CLI	153
4.3.11. Logging in to the cluster by using the web console	153
4.3.12. Telemetry access for OpenShift Container Platform	154
4.3.13. Next steps	154
4.4. INSTALLING A CLUSTER ON ALIBABA CLOUD WITH CUSTOMIZATIONS	154
4.4.1. Prerequisites	155
4.4.2. Internet access for OpenShift Container Platform	155
4.4.3. Generating a key pair for cluster node SSH access	156
4.4.4. Obtaining the installation program	157
4.4.4.1. Creating the installation configuration file	158
4.4.4.2. Generating the required installation manifests	160
4.4.4.3. Creating credentials for OpenShift Container Platform components with the ccoctl tool	160
4.4.4.4. Installation configuration parameters	163
4.4.4.4.1. Required configuration parameters	163
4.4.4.4.2. Network configuration parameters	165
4.4.4.4.3. Optional configuration parameters	166
4.4.4.4.4. Additional Alibaba Cloud configuration parameters	171
4.4.4.5. Sample customized install-config.yaml file for Alibaba Cloud	174
4.4.4.6. Configuring the cluster-wide proxy during installation	175
4.4.5. Deploying the cluster	177
4.4.6. Installing the OpenShift CLI by downloading the binary	178
Installing the OpenShift CLI on Linux	179
Installing the OpenShift CLI on Windows	179
Installing the OpenShift CLI on macOS	180
4.4.7. Logging in to the cluster by using the CLI	180
4.4.8. Logging in to the cluster by using the web console	181
4.4.9. Telemetry access for OpenShift Container Platform	181

4.4.10. Next steps	182
4.5. INSTALLING A CLUSTER ON ALIBABA CLOUD WITH NETWORK CUSTOMIZATIONS	182
4.5.1. Prerequisites	182
4.5.2. Internet access for OpenShift Container Platform	183
4.5.3. Generating a key pair for cluster node SSH access	183
4.5.4. Obtaining the installation program	185
4.5.5. Network configuration phases	186
4.5.5.1. Creating the installation configuration file	186
4.5.5.2. Generating the required installation manifests	187
4.5.5.3. Installation configuration parameters	188
4.5.5.3.1. Required configuration parameters	188
4.5.5.3.2. Network configuration parameters	190
4.5.5.3.3. Optional configuration parameters	192
4.5.5.4. Sample customized install-config.yaml file for Alibaba Cloud	196
4.5.5.5. Configuring the cluster-wide proxy during installation	198
4.5.6. Cluster Network Operator configuration	199
4.5.6.1. Cluster Network Operator configuration object	200
defaultNetwork object configuration	201
Configuration for the OpenShift SDN CNI cluster network provider	201
Configuration for the OVN-Kubernetes CNI cluster network provider	202
kubeProxyConfig object configuration	204
4.5.7. Specifying advanced network configuration	205
4.5.8. Configuring hybrid networking with OVN-Kubernetes	206
4.5.9. Deploying the cluster	208
4.5.10. Installing the OpenShift CLI by downloading the binary	209
Installing the OpenShift CLI on Linux	209
Installing the OpenShift CLI on Windows	210
Installing the OpenShift CLI on macOS	210
4.5.11. Logging in to the cluster by using the CLI	211
4.5.12. Logging in to the cluster by using the web console	211
4.5.13. Telemetry access for OpenShift Container Platform	212
4.5.14. Next steps	212
4.6. INSTALLING A CLUSTER ON ALIBABA CLOUD INTO AN EXISTING VPC	213
4.6.1. Prerequisites	213
4.6.2. Using a custom VPC	213
4.6.2.1. Requirements for using your VPC	214
4.6.2.2. VPC validation	214
4.6.2.3. Division of permissions	214
4.6.2.4. Isolation between clusters	214
4.6.3. Internet access for OpenShift Container Platform	215
4.6.4. Generating a key pair for cluster node SSH access	215
4.6.5. Obtaining the installation program	217
4.6.5.1. Creating the installation configuration file	218
4.6.5.2. Installation configuration parameters	219
4.6.5.2.1. Required configuration parameters	219
4.6.5.2.2. Network configuration parameters	221
4.6.5.2.3. Optional configuration parameters	223
4.6.5.2.4. Additional Alibaba Cloud configuration parameters	227
4.6.5.3. Sample customized install-config.yaml file for Alibaba Cloud	230
4.6.5.4. Generating the required installation manifests	232
4.6.5.5. Configuring the Cloud Credential Operator utility	232
4.6.5.6. Creating credentials for OpenShift Container Platform components with the ccoctl tool	233
4.6.6. Deploying the cluster	236

4.6.7. Installing the OpenShift CLI by downloading the binary	237
Installing the OpenShift CLI on Linux	238
Installing the OpenShift CLI on Windows	238
Installing the OpenShift CLI on macOS	239
4.6.8. Logging in to the cluster by using the CLI	239
4.6.9. Logging in to the cluster by using the web console	240
4.6.10. Telemetry access for OpenShift Container Platform	240
4.6.11. Next steps	241
4.7. UNINSTALLING A CLUSTER ON ALIBABA CLOUD	241
4.7.1. Removing a cluster that uses installer-provisioned infrastructure	241
<b>CHAPTER 5. INSTALLING ON AWS</b> .....	<b>243</b>
5.1. PREPARING TO INSTALL ON AWS	243
5.1.1. Prerequisites	243
5.1.2. Requirements for installing OpenShift Container Platform on AWS	243
5.1.3. Choosing a method to install OpenShift Container Platform on AWS	243
5.1.3.1. Installing a cluster on installer-provisioned infrastructure	243
5.1.3.2. Installing a cluster on user-provisioned infrastructure	244
5.1.4. Next steps	244
5.2. CONFIGURING AN AWS ACCOUNT	244
5.2.1. Configuring Route 53	244
5.2.1.1. Ingress Operator endpoint configuration for AWS Route 53	245
5.2.2. AWS account limits	246
5.2.3. Required AWS permissions for the IAM user	248
5.2.4. Creating an IAM user	256
5.2.5. IAM Policies and AWS authentication	257
5.2.5.1. Default permissions for IAM instance profiles	257
5.2.5.2. Specifying an existing IAM role	259
5.2.5.3. Using AWS IAM Analyzer to create policy templates	259
5.2.6. Supported AWS Marketplace regions	260
5.2.7. Supported AWS regions	261
5.2.7.1. AWS public regions	261
5.2.7.2. AWS GovCloud regions	261
5.2.7.3. AWS C2S Secret region	262
5.2.7.4. AWS China regions	262
5.2.8. Next steps	262
5.3. MANUALLY CREATING IAM FOR AWS	262
5.3.1. Alternatives to storing administrator-level secrets in the kube-system project	262
5.3.2. Manually create IAM	263
5.3.3. Mint mode	266
5.3.4. Mint mode with removal or rotation of the administrator-level credential	267
5.3.5. Next steps	267
5.4. INSTALLING A CLUSTER QUICKLY ON AWS	267
5.4.1. Prerequisites	267
5.4.2. Internet access for OpenShift Container Platform	268
5.4.3. Generating a key pair for cluster node SSH access	268
5.4.4. Obtaining the installation program	270
5.4.5. Deploying the cluster	271
5.4.6. Installing the OpenShift CLI by downloading the binary	273
Installing the OpenShift CLI on Linux	274
Installing the OpenShift CLI on Windows	274
Installing the OpenShift CLI on macOS	275
5.4.7. Logging in to the cluster by using the CLI	275

5.4.8. Logging in to the cluster by using the web console	276
5.4.9. Telemetry access for OpenShift Container Platform	276
5.4.10. Next steps	277
5.5. INSTALLING A CLUSTER ON AWS WITH CUSTOMIZATIONS	277
5.5.1. Prerequisites	277
5.5.2. Internet access for OpenShift Container Platform	278
5.5.3. Generating a key pair for cluster node SSH access	278
5.5.4. Obtaining an AWS Marketplace image	280
5.5.5. Obtaining the installation program	281
5.5.6. Creating the installation configuration file	281
5.5.6.1. Installation configuration parameters	283
5.5.6.1.1. Required configuration parameters	283
5.5.6.1.2. Network configuration parameters	284
5.5.6.1.3. Optional configuration parameters	286
5.5.6.1.4. Optional AWS configuration parameters	291
5.5.6.2. Minimum resource requirements for cluster installation	295
5.5.6.3. Tested instance types for AWS	296
5.5.6.4. Tested instance types for AWS on 64-bit ARM infrastructures	296
5.5.6.5. Sample customized install-config.yaml file for AWS	297
5.5.6.6. Configuring the cluster-wide proxy during installation	299
5.5.7. Deploying the cluster	301
5.5.8. Installing the OpenShift CLI by downloading the binary	302
Installing the OpenShift CLI on Linux	302
Installing the OpenShift CLI on Windows	303
Installing the OpenShift CLI on macOS	303
5.5.9. Logging in to the cluster by using the CLI	304
5.5.10. Logging in to the cluster by using the web console	304
5.5.11. Telemetry access for OpenShift Container Platform	305
5.5.12. Next steps	305
5.6. INSTALLING A CLUSTER ON AWS WITH NETWORK CUSTOMIZATIONS	306
5.6.1. Prerequisites	306
5.6.2. Internet access for OpenShift Container Platform	306
5.6.3. Generating a key pair for cluster node SSH access	307
5.6.4. Obtaining the installation program	309
5.6.5. Network configuration phases	309
5.6.6. Creating the installation configuration file	310
5.6.6.1. Installation configuration parameters	311
5.6.6.1.1. Required configuration parameters	312
5.6.6.1.2. Network configuration parameters	313
5.6.6.1.3. Optional configuration parameters	315
5.6.6.1.4. Optional AWS configuration parameters	320
5.6.6.2. Minimum resource requirements for cluster installation	324
5.6.6.3. Tested instance types for AWS	325
5.6.6.4. Tested instance types for AWS on 64-bit ARM infrastructures	325
5.6.6.5. Sample customized install-config.yaml file for AWS	326
5.6.6.6. Configuring the cluster-wide proxy during installation	328
5.6.7. Cluster Network Operator configuration	330
5.6.7.1. Cluster Network Operator configuration object	330
defaultNetwork object configuration	331
Configuration for the OpenShift SDN CNI cluster network provider	331
Configuration for the OVN-Kubernetes CNI cluster network provider	332
kubeProxyConfig object configuration	334
5.6.8. Specifying advanced network configuration	335



---

5.6.9. Configuring an Ingress Controller Network Load Balancer on a new AWS cluster	336
5.6.10. Configuring hybrid networking with OVN-Kubernetes	338
5.6.11. Deploying the cluster	339
5.6.12. Installing the OpenShift CLI by downloading the binary	341
Installing the OpenShift CLI on Linux	341
Installing the OpenShift CLI on Windows	341
Installing the OpenShift CLI on macOS	342
5.6.13. Logging in to the cluster by using the CLI	342
5.6.14. Logging in to the cluster by using the web console	343
5.6.15. Telemetry access for OpenShift Container Platform	344
5.6.16. Next steps	344
5.7. INSTALLING A CLUSTER ON AWS IN A RESTRICTED NETWORK	344
5.7.1. Prerequisites	344
5.7.2. About installations in restricted networks	345
5.7.2.1. Additional limits	346
5.7.3. About using a custom VPC	346
5.7.3.1. Requirements for using your VPC	346
5.7.3.2. VPC validation	348
5.7.3.3. Division of permissions	349
5.7.3.4. Isolation between clusters	349
5.7.4. Internet access for OpenShift Container Platform	349
5.7.5. Generating a key pair for cluster node SSH access	350
5.7.6. Creating the installation configuration file	352
5.7.6.1. Installation configuration parameters	354
5.7.6.1.1. Required configuration parameters	354
5.7.6.1.2. Network configuration parameters	355
5.7.6.1.3. Optional configuration parameters	357
5.7.6.1.4. Optional AWS configuration parameters	362
5.7.6.2. Minimum resource requirements for cluster installation	366
5.7.6.3. Sample customized install-config.yaml file for AWS	367
5.7.6.4. Configuring the cluster-wide proxy during installation	369
5.7.7. Deploying the cluster	371
5.7.8. Installing the OpenShift CLI by downloading the binary	373
Installing the OpenShift CLI on Linux	373
Installing the OpenShift CLI on Windows	373
Installing the OpenShift CLI on macOS	374
5.7.9. Logging in to the cluster by using the CLI	374
5.7.10. Disabling the default OperatorHub sources	375
5.7.11. Telemetry access for OpenShift Container Platform	375
5.7.12. Next steps	375
5.8. INSTALLING A CLUSTER ON AWS INTO AN EXISTING VPC	376
5.8.1. Prerequisites	376
5.8.2. About using a custom VPC	376
5.8.2.1. Requirements for using your VPC	377
5.8.2.2. VPC validation	379
5.8.2.3. Division of permissions	380
5.8.2.4. Isolation between clusters	380
5.8.3. Internet access for OpenShift Container Platform	380
5.8.4. Generating a key pair for cluster node SSH access	381
5.8.5. Obtaining the installation program	383
5.8.6. Creating the installation configuration file	383
5.8.6.1. Installation configuration parameters	385
5.8.6.1.1. Required configuration parameters	385

---

5.8.6.1.2. Network configuration parameters	386
5.8.6.1.3. Optional configuration parameters	388
5.8.6.1.4. Optional AWS configuration parameters	393
5.8.6.2. Minimum resource requirements for cluster installation	397
5.8.6.3. Tested instance types for AWS	398
5.8.6.4. Tested instance types for AWS on 64-bit ARM infrastructures	398
5.8.6.5. Sample customized install-config.yaml file for AWS	399
5.8.6.6. Configuring the cluster-wide proxy during installation	401
5.8.7. Deploying the cluster	403
5.8.8. Installing the OpenShift CLI by downloading the binary	405
Installing the OpenShift CLI on Linux	405
Installing the OpenShift CLI on Windows	405
Installing the OpenShift CLI on macOS	406
5.8.9. Logging in to the cluster by using the CLI	406
5.8.10. Logging in to the cluster by using the web console	407
5.8.11. Telemetry access for OpenShift Container Platform	408
5.8.12. Next steps	408
5.9. INSTALLING A PRIVATE CLUSTER ON AWS	408
5.9.1. Prerequisites	408
5.9.2. Private clusters	409
5.9.2.1. Private clusters in AWS	409
5.9.2.1.1. Limitations	410
5.9.3. About using a custom VPC	410
5.9.3.1. Requirements for using your VPC	410
5.9.3.2. VPC validation	413
5.9.3.3. Division of permissions	413
5.9.3.4. Isolation between clusters	413
5.9.4. Internet access for OpenShift Container Platform	413
5.9.5. Generating a key pair for cluster node SSH access	414
5.9.6. Obtaining the installation program	416
5.9.7. Manually creating the installation configuration file	416
5.9.7.1. Installation configuration parameters	417
5.9.7.1.1. Required configuration parameters	418
5.9.7.1.2. Network configuration parameters	419
5.9.7.1.3. Optional configuration parameters	421
5.9.7.1.4. Optional AWS configuration parameters	426
5.9.7.2. Minimum resource requirements for cluster installation	430
5.9.7.3. Tested instance types for AWS	431
5.9.7.4. Tested instance types for AWS on 64-bit ARM infrastructures	431
5.9.7.5. Sample customized install-config.yaml file for AWS	432
5.9.7.6. Configuring the cluster-wide proxy during installation	434
5.9.8. Deploying the cluster	436
5.9.9. Installing the OpenShift CLI by downloading the binary	438
Installing the OpenShift CLI on Linux	438
Installing the OpenShift CLI on Windows	438
Installing the OpenShift CLI on macOS	439
5.9.10. Logging in to the cluster by using the CLI	439
5.9.11. Logging in to the cluster by using the web console	440
5.9.12. Telemetry access for OpenShift Container Platform	441
5.9.13. Next steps	441
5.10. INSTALLING A CLUSTER ON AWS INTO A GOVERNMENT REGION	441
5.10.1. Prerequisites	441
5.10.2. AWS government regions	442

---

5.10.3. Installation requirements	442
5.10.4. Private clusters	442
5.10.4.1. Private clusters in AWS	443
5.10.4.1.1. Limitations	443
5.10.5. About using a custom VPC	443
5.10.5.1. Requirements for using your VPC	443
5.10.5.2. VPC validation	446
5.10.5.3. Division of permissions	446
5.10.5.4. Isolation between clusters	447
5.10.6. Internet access for OpenShift Container Platform	447
5.10.7. Generating a key pair for cluster node SSH access	447
5.10.8. Obtaining an AWS Marketplace image	449
5.10.9. Obtaining the installation program	450
5.10.10. Manually creating the installation configuration file	451
5.10.10.1. Installation configuration parameters	451
5.10.10.1.1. Required configuration parameters	452
5.10.10.1.2. Network configuration parameters	453
5.10.10.1.3. Optional configuration parameters	455
5.10.10.1.4. Optional AWS configuration parameters	460
5.10.10.2. Minimum resource requirements for cluster installation	464
5.10.10.3. Tested instance types for AWS	465
5.10.10.4. Tested instance types for AWS on 64-bit ARM infrastructures	465
5.10.10.5. Sample customized install-config.yaml file for AWS	466
5.10.10.6. Configuring the cluster-wide proxy during installation	468
5.10.11. Deploying the cluster	470
5.10.12. Installing the OpenShift CLI by downloading the binary	472
Installing the OpenShift CLI on Linux	472
Installing the OpenShift CLI on Windows	472
Installing the OpenShift CLI on macOS	473
5.10.13. Logging in to the cluster by using the CLI	473
5.10.14. Logging in to the cluster by using the web console	474
5.10.15. Telemetry access for OpenShift Container Platform	475
5.10.16. Next steps	475
5.11. INSTALLING A CLUSTER ON AWS INTO A TOP SECRET REGION	475
5.11.1. Prerequisites	475
5.11.2. AWS Top Secret Region	476
5.11.3. Installation requirements	476
5.11.4. Private clusters	476
5.11.4.1. Private clusters in AWS	477
5.11.4.1.1. Limitations	477
5.11.5. About using a custom VPC	478
5.11.5.1. Requirements for using your VPC	478
5.11.5.2. VPC validation	480
5.11.5.3. Division of permissions	481
5.11.5.4. Isolation between clusters	481
5.11.6. Internet access for OpenShift Container Platform	481
5.11.7. Uploading a custom RHCOS AMI in AWS	482
5.11.8. Generating a key pair for cluster node SSH access	484
5.11.9. Obtaining the installation program	486
5.11.10. Manually creating the installation configuration file	487
5.11.10.1. Installation configuration parameters	487
5.11.10.1.1. Required configuration parameters	488
5.11.10.1.2. Network configuration parameters	489

---

5.11.10.1.3. Optional configuration parameters	491
5.11.10.1.4. Optional AWS configuration parameters	496
5.11.10.2. Tested instance types for AWS	500
5.11.10.3. Sample customized install-config.yaml file for AWS	500
5.11.10.4. Configuring the cluster-wide proxy during installation	503
5.11.11. Deploying the cluster	505
5.11.12. Installing the OpenShift CLI by downloading the binary	506
Installing the OpenShift CLI on Linux	507
Installing the OpenShift CLI on Windows	507
Installing the OpenShift CLI on macOS	508
5.11.13. Logging in to the cluster by using the CLI	508
5.11.14. Logging in to the cluster by using the web console	509
5.11.15. Telemetry access for OpenShift Container Platform	509
5.11.16. Next steps	510
5.12. INSTALLING A CLUSTER ON AWS CHINA	510
5.12.1. Prerequisites	510
5.12.2. Installation requirements	511
5.12.3. Internet access for OpenShift Container Platform	511
5.12.4. Private clusters	511
5.12.4.1. Private clusters in AWS	512
5.12.4.1.1. Limitations	512
5.12.5. About using a custom VPC	513
5.12.5.1. Requirements for using your VPC	513
5.12.5.2. VPC validation	515
5.12.5.3. Division of permissions	516
5.12.5.4. Isolation between clusters	516
5.12.6. Generating a key pair for cluster node SSH access	516
5.12.7. Uploading a custom RHCOS AMI in AWS	518
5.12.8. Obtaining the installation program	520
5.12.9. Manually creating the installation configuration file	521
5.12.9.1. Installation configuration parameters	522
5.12.9.1.1. Required configuration parameters	522
5.12.9.1.2. Network configuration parameters	524
5.12.9.1.3. Optional configuration parameters	525
5.12.9.2. Sample customized install-config.yaml file for AWS	530
5.12.9.3. Minimum resource requirements for cluster installation	533
5.12.9.4. Tested instance types for AWS	533
5.12.9.5. Tested instance types for AWS on 64-bit ARM infrastructures	534
5.12.9.6. Configuring the cluster-wide proxy during installation	535
5.12.10. Deploying the cluster	536
5.12.11. Installing the OpenShift CLI by downloading the binary	538
Installing the OpenShift CLI on Linux	538
Installing the OpenShift CLI on Windows	539
Installing the OpenShift CLI on macOS	539
5.12.12. Logging in to the cluster by using the CLI	540
5.12.13. Logging in to the cluster by using the web console	540
5.12.14. Telemetry access for OpenShift Container Platform	541
5.12.15. Next steps	541
5.13. INSTALLING A CLUSTER ON USER-PROVISIONED INFRASTRUCTURE IN AWS BY USING CLOUDFORMATION TEMPLATES	541
5.13.1. Prerequisites	542
5.13.2. Internet access for OpenShift Container Platform	542
5.13.3. Requirements for a cluster with user-provisioned infrastructure	543

5.13.3.1. Required machines for cluster installation	543
5.13.3.2. Minimum resource requirements for cluster installation	544
5.13.3.3. Tested instance types for AWS	544
5.13.3.4. Tested instance types for AWS on 64-bit ARM infrastructures	545
5.13.3.5. Certificate signing requests management	545
5.13.4. Required AWS infrastructure components	546
5.13.4.1. Other infrastructure components	546
5.13.4.2. Cluster machines	554
5.13.4.3. Required AWS permissions for the IAM user	554
5.13.5. Obtaining an AWS Marketplace image	562
5.13.6. Obtaining the installation program	562
5.13.7. Generating a key pair for cluster node SSH access	563
5.13.8. Creating the installation files for AWS	565
5.13.8.1. Optional: Creating a separate /var partition	565
5.13.8.2. Creating the installation configuration file	567
5.13.8.3. Configuring the cluster-wide proxy during installation	569
5.13.8.4. Creating the Kubernetes manifest and Ignition config files	570
5.13.9. Extracting the infrastructure name	572
5.13.10. Creating a VPC in AWS	573
5.13.10.1. CloudFormation template for the VPC	575
5.13.11. Creating networking and load balancing components in AWS	580
5.13.11.1. CloudFormation template for the network and load balancers	584
5.13.12. Creating security group and roles in AWS	592
5.13.12.1. CloudFormation template for security objects	595
5.13.13. Accessing RHCOS AMIs with stream metadata	606
5.13.14. RHCOS AMIs for the AWS infrastructure	606
5.13.14.1. AWS regions without a published RHCOS AMI	608
5.13.14.2. Uploading a custom RHCOS AMI in AWS	609
5.13.15. Creating the bootstrap node in AWS	611
5.13.15.1. CloudFormation template for the bootstrap machine	616
5.13.16. Creating the control plane machines in AWS	620
5.13.16.1. CloudFormation template for control plane machines	624
5.13.17. Creating the worker nodes in AWS	631
5.13.17.1. CloudFormation template for worker machines	634
5.13.18. Initializing the bootstrap sequence on AWS with user-provisioned infrastructure	637
5.13.19. Installing the OpenShift CLI by downloading the binary	638
Installing the OpenShift CLI on Linux	638
Installing the OpenShift CLI on Windows	639
Installing the OpenShift CLI on macOS	639
5.13.20. Logging in to the cluster by using the CLI	639
5.13.21. Approving the certificate signing requests for your machines	640
5.13.22. Initial Operator configuration	643
5.13.22.1. Image registry storage configuration	644
5.13.22.1.1. Configuring registry storage for AWS with user-provisioned infrastructure	644
5.13.22.1.2. Configuring storage for the image registry in non-production clusters	645
5.13.23. Deleting the bootstrap resources	645
5.13.24. Creating the Ingress DNS Records	646
5.13.25. Completing an AWS installation on user-provisioned infrastructure	649
5.13.26. Logging in to the cluster by using the web console	650
5.13.27. Telemetry access for OpenShift Container Platform	651
5.13.28. Additional resources	651
5.13.29. Next steps	651
5.14. INSTALLING A CLUSTER ON AWS IN A RESTRICTED NETWORK WITH USER-PROVISIONED	

INFRASTRUCTURE	651
5.14.1. Prerequisites	652
5.14.2. About installations in restricted networks	652
5.14.2.1. Additional limits	653
5.14.3. Internet access for OpenShift Container Platform	653
5.14.4. Requirements for a cluster with user-provisioned infrastructure	654
5.14.4.1. Required machines for cluster installation	654
5.14.4.2. Minimum resource requirements for cluster installation	654
5.14.4.3. Tested instance types for AWS	655
5.14.4.4. Tested instance types for AWS on 64-bit ARM infrastructures	656
5.14.4.5. Certificate signing requests management	656
5.14.5. Required AWS infrastructure components	656
5.14.5.1. Other infrastructure components	657
5.14.5.2. Cluster machines	665
5.14.5.3. Required AWS permissions for the IAM user	665
5.14.6. Generating a key pair for cluster node SSH access	673
5.14.7. Creating the installation files for AWS	675
5.14.7.1. Optional: Creating a separate /var partition	675
5.14.7.2. Creating the installation configuration file	677
5.14.7.3. Configuring the cluster-wide proxy during installation	679
5.14.7.4. Creating the Kubernetes manifest and Ignition config files	681
5.14.8. Extracting the infrastructure name	683
5.14.9. Creating a VPC in AWS	684
5.14.9.1. CloudFormation template for the VPC	686
5.14.10. Creating networking and load balancing components in AWS	691
5.14.10.1. CloudFormation template for the network and load balancers	695
5.14.11. Creating security group and roles in AWS	702
5.14.11.1. CloudFormation template for security objects	705
5.14.12. Accessing RHCOS AMIs with stream metadata	716
5.14.13. RHCOS AMIs for the AWS infrastructure	716
5.14.14. Creating the bootstrap node in AWS	719
5.14.14.1. CloudFormation template for the bootstrap machine	723
5.14.15. Creating the control plane machines in AWS	728
5.14.15.1. CloudFormation template for control plane machines	732
5.14.16. Creating the worker nodes in AWS	739
5.14.16.1. CloudFormation template for worker machines	742
5.14.17. Initializing the bootstrap sequence on AWS with user-provisioned infrastructure	744
5.14.18. Logging in to the cluster by using the CLI	745
5.14.19. Approving the certificate signing requests for your machines	746
5.14.20. Initial Operator configuration	749
5.14.20.1. Disabling the default OperatorHub sources	750
5.14.20.2. Image registry storage configuration	750
5.14.20.2.1. Configuring registry storage for AWS with user-provisioned infrastructure	750
5.14.20.2.2. Configuring storage for the image registry in non-production clusters	751
5.14.21. Deleting the bootstrap resources	752
5.14.22. Creating the Ingress DNS Records	752
5.14.23. Completing an AWS installation on user-provisioned infrastructure	755
5.14.24. Logging in to the cluster by using the web console	756
5.14.25. Telemetry access for OpenShift Container Platform	757
5.14.26. Additional resources	757
5.14.27. Next steps	757
5.15. UNINSTALLING A CLUSTER ON AWS	758
5.15.1. Removing a cluster that uses installer-provisioned infrastructure	758

5.15.2. Deleting AWS resources with the Cloud Credential Operator utility	758
<b>CHAPTER 6. INSTALLING ON AZURE</b>	<b>760</b>
6.1. PREPARING TO INSTALL ON AZURE	760
6.1.1. Prerequisites	760
6.1.2. Requirements for installing OpenShift Container Platform on Azure	760
6.1.3. Choosing a method to install OpenShift Container Platform on Azure	760
6.1.3.1. Installing a cluster on installer-provisioned infrastructure	760
6.1.3.2. Installing a cluster on user-provisioned infrastructure	761
6.1.4. Next steps	761
6.2. CONFIGURING AN AZURE ACCOUNT	761
6.2.1. Azure account limits	761
6.2.2. Configuring a public DNS zone in Azure	764
6.2.3. Increasing Azure account limits	764
6.2.4. Required Azure roles	765
6.2.5. Creating a service principal	765
6.2.6. Supported Azure Marketplace regions	768
6.2.7. Supported Azure regions	768
Supported Azure public regions	768
Supported Azure Government regions	769
6.2.8. Next steps	770
6.3. MANUALLY CREATING IAM FOR AZURE	770
6.3.1. Alternatives to storing administrator-level secrets in the kube-system project	770
6.3.2. Manually create IAM	770
6.3.3. Next steps	773
6.4. INSTALLING A CLUSTER QUICKLY ON AZURE	773
6.4.1. Prerequisites	774
6.4.2. Internet access for OpenShift Container Platform	774
6.4.3. Generating a key pair for cluster node SSH access	774
6.4.4. Obtaining the installation program	776
6.4.5. Deploying the cluster	777
6.4.6. Installing the OpenShift CLI by downloading the binary	780
Installing the OpenShift CLI on Linux	780
Installing the OpenShift CLI on Windows	780
Installing the OpenShift CLI on macOS	781
6.4.7. Logging in to the cluster by using the CLI	781
6.4.8. Telemetry access for OpenShift Container Platform	782
6.4.9. Next steps	782
6.5. INSTALLING A CLUSTER ON AZURE WITH CUSTOMIZATIONS	782
6.5.1. Prerequisites	782
6.5.2. Internet access for OpenShift Container Platform	783
6.5.3. Generating a key pair for cluster node SSH access	783
6.5.4. Selecting an Azure Marketplace image	785
6.5.5. Obtaining the installation program	787
6.5.6. Creating the installation configuration file	787
6.5.6.1. Installation configuration parameters	789
6.5.6.1.1. Required configuration parameters	789
6.5.6.1.2. Network configuration parameters	791
6.5.6.1.3. Optional configuration parameters	793
6.5.6.1.4. Additional Azure configuration parameters	797
6.5.6.2. Minimum resource requirements for cluster installation	799
6.5.6.3. Tested instance types for Azure	800
6.5.6.4. Sample customized install-config.yaml file for Azure	801

6.5.6.5. Configuring the cluster-wide proxy during installation	803
6.5.7. Enabling Accelerated Networking during installation	804
6.5.8. Updating manifests for Marketplace installation	805
6.5.9. Deploying the cluster	806
6.5.10. Installing the OpenShift CLI by downloading the binary	808
Installing the OpenShift CLI on Linux	808
Installing the OpenShift CLI on Windows	809
Installing the OpenShift CLI on macOS	809
6.5.11. Logging in to the cluster by using the CLI	809
6.5.12. Telemetry access for OpenShift Container Platform	810
6.5.13. Next steps	810
6.6. INSTALLING A CLUSTER ON AZURE WITH NETWORK CUSTOMIZATIONS	811
6.6.1. Prerequisites	811
6.6.2. Internet access for OpenShift Container Platform	811
6.6.3. Generating a key pair for cluster node SSH access	811
6.6.4. Obtaining the installation program	813
6.6.5. Creating the installation configuration file	814
6.6.5.1. Installation configuration parameters	816
6.6.5.1.1. Required configuration parameters	816
6.6.5.1.2. Network configuration parameters	817
6.6.5.1.3. Optional configuration parameters	819
6.6.5.1.4. Additional Azure configuration parameters	824
6.6.5.2. Minimum resource requirements for cluster installation	826
6.6.5.3. Tested instance types for Azure	827
6.6.5.4. Sample customized install-config.yaml file for Azure	828
6.6.5.5. Configuring the cluster-wide proxy during installation	830
6.6.6. Network configuration phases	831
6.6.7. Specifying advanced network configuration	832
6.6.8. Cluster Network Operator configuration	833
6.6.8.1. Cluster Network Operator configuration object	833
defaultNetwork object configuration	834
Configuration for the OpenShift SDN CNI cluster network provider	835
Configuration for the OVN-Kubernetes CNI cluster network provider	836
kubeProxyConfig object configuration	838
6.6.9. Configuring hybrid networking with OVN-Kubernetes	839
6.6.10. Enabling Accelerated Networking during installation	841
6.6.11. Deploying the cluster	842
6.6.12. Installing the OpenShift CLI by downloading the binary	843
Installing the OpenShift CLI on Linux	843
Installing the OpenShift CLI on Windows	844
Installing the OpenShift CLI on macOS	844
6.6.13. Logging in to the cluster by using the CLI	845
6.6.14. Telemetry access for OpenShift Container Platform	845
6.6.15. Next steps	845
6.7. INSTALLING A CLUSTER ON AZURE INTO AN EXISTING VNET	846
6.7.1. Prerequisites	846
6.7.2. About reusing a VNet for your OpenShift Container Platform cluster	846
6.7.2.1. Requirements for using your VNet	846
6.7.2.1.1. Network security group requirements	847
6.7.2.2. Division of permissions	848
6.7.2.3. Isolation between clusters	849
6.7.3. Internet access for OpenShift Container Platform	849
6.7.4. Generating a key pair for cluster node SSH access	849



6.7.5. Obtaining the installation program	851
6.7.6. Creating the installation configuration file	852
6.7.6.1. Installation configuration parameters	853
6.7.6.1.1. Required configuration parameters	853
6.7.6.1.2. Network configuration parameters	855
6.7.6.1.3. Optional configuration parameters	857
6.7.6.1.4. Additional Azure configuration parameters	861
6.7.6.2. Minimum resource requirements for cluster installation	863
6.7.6.3. Tested instance types for Azure	864
6.7.6.4. Sample customized install-config.yaml file for Azure	865
6.7.6.5. Configuring the cluster-wide proxy during installation	867
6.7.7. Enabling Accelerated Networking during installation	869
6.7.8. Deploying the cluster	870
6.7.9. Installing the OpenShift CLI by downloading the binary	871
Installing the OpenShift CLI on Linux	871
Installing the OpenShift CLI on Windows	872
Installing the OpenShift CLI on macOS	872
6.7.10. Logging in to the cluster by using the CLI	873
6.7.11. Telemetry access for OpenShift Container Platform	873
6.7.12. Next steps	874
6.8. INSTALLING A PRIVATE CLUSTER ON AZURE	874
6.8.1. Prerequisites	874
6.8.2. Private clusters	874
6.8.2.1. Private clusters in Azure	875
6.8.2.1.1. Limitations	875
6.8.2.2. User-defined outbound routing	875
Private cluster with network address translation	876
Private cluster with Azure Firewall	876
Private cluster with a proxy configuration	876
Private cluster with no internet access	876
6.8.3. About reusing a VNet for your OpenShift Container Platform cluster	877
6.8.3.1. Requirements for using your VNet	877
6.8.3.1.1. Network security group requirements	878
6.8.3.2. Division of permissions	879
6.8.3.3. Isolation between clusters	879
6.8.4. Internet access for OpenShift Container Platform	879
6.8.5. Generating a key pair for cluster node SSH access	880
6.8.6. Obtaining the installation program	881
6.8.7. Manually creating the installation configuration file	882
6.8.7.1. Installation configuration parameters	883
6.8.7.1.1. Required configuration parameters	883
6.8.7.1.2. Network configuration parameters	885
6.8.7.1.3. Optional configuration parameters	887
6.8.7.1.4. Additional Azure configuration parameters	891
6.8.7.2. Minimum resource requirements for cluster installation	893
6.8.7.3. Tested instance types for Azure	894
6.8.7.4. Sample customized install-config.yaml file for Azure	895
6.8.7.5. Configuring the cluster-wide proxy during installation	897
6.8.8. Enabling Accelerated Networking during installation	899
6.8.9. Deploying the cluster	900
6.8.10. Installing the OpenShift CLI by downloading the binary	901
Installing the OpenShift CLI on Linux	901
Installing the OpenShift CLI on Windows	902

Installing the OpenShift CLI on macOS	902
6.8.11. Logging in to the cluster by using the CLI	903
6.8.12. Telemetry access for OpenShift Container Platform	903
6.8.13. Next steps	904
6.9. INSTALLING A CLUSTER ON AZURE INTO A GOVERNMENT REGION	904
6.9.1. Prerequisites	904
6.9.2. Azure government regions	904
6.9.3. Private clusters	904
6.9.3.1. Private clusters in Azure	905
6.9.3.1.1. Limitations	906
6.9.3.2. User-defined outbound routing	906
Private cluster with network address translation	906
Private cluster with Azure Firewall	906
Private cluster with a proxy configuration	906
Private cluster with no internet access	907
6.9.4. About reusing a VNet for your OpenShift Container Platform cluster	907
6.9.4.1. Requirements for using your VNet	907
6.9.4.1.1. Network security group requirements	908
6.9.4.2. Division of permissions	909
6.9.4.3. Isolation between clusters	909
6.9.5. Internet access for OpenShift Container Platform	910
6.9.6. Generating a key pair for cluster node SSH access	910
6.9.7. Obtaining the installation program	912
6.9.8. Manually creating the installation configuration file	913
6.9.8.1. Installation configuration parameters	913
6.9.8.1.1. Required configuration parameters	914
6.9.8.1.2. Network configuration parameters	915
6.9.8.1.3. Optional configuration parameters	917
6.9.8.1.4. Additional Azure configuration parameters	922
6.9.8.2. Minimum resource requirements for cluster installation	924
6.9.8.3. Tested instance types for Azure	925
6.9.8.4. Sample customized install-config.yaml file for Azure	926
6.9.8.5. Configuring the cluster-wide proxy during installation	928
6.9.9. Enabling Accelerated Networking during installation	930
6.9.10. Deploying the cluster	930
6.9.11. Installing the OpenShift CLI by downloading the binary	932
Installing the OpenShift CLI on Linux	932
Installing the OpenShift CLI on Windows	933
Installing the OpenShift CLI on macOS	933
6.9.12. Logging in to the cluster by using the CLI	933
6.9.13. Telemetry access for OpenShift Container Platform	934
6.9.14. Next steps	934
6.10. INSTALLING A CLUSTER ON AZURE USING ARM TEMPLATES	934
6.10.1. Prerequisites	935
6.10.2. Internet access for OpenShift Container Platform	935
6.10.3. Configuring your Azure project	936
6.10.3.1. Azure account limits	936
6.10.3.2. Configuring a public DNS zone in Azure	939
6.10.3.3. Increasing Azure account limits	939
6.10.3.4. Certificate signing requests management	940
6.10.3.5. Required Azure roles	940
6.10.3.6. Creating a service principal	941
6.10.3.7. Supported Azure regions	943

Supported Azure public regions	943
Supported Azure Government regions	944
6.10.4. Requirements for a cluster with user-provisioned infrastructure	945
6.10.4.1. Required machines for cluster installation	945
6.10.4.2. Minimum resource requirements for cluster installation	945
6.10.4.3. Tested instance types for Azure	946
6.10.5. Selecting an Azure Marketplace image	947
6.10.6. Obtaining the installation program	949
6.10.7. Generating a key pair for cluster node SSH access	949
6.10.8. Creating the installation files for Azure	951
6.10.8.1. Optional: Creating a separate /var partition	951
6.10.8.2. Creating the installation configuration file	954
6.10.8.3. Configuring the cluster-wide proxy during installation	955
6.10.8.4. Exporting common variables for ARM templates	957
6.10.8.5. Creating the Kubernetes manifest and Ignition config files	958
6.10.9. Creating the Azure resource group	961
6.10.10. Uploading the RHCOS cluster image and bootstrap Ignition config file	962
6.10.11. Example for creating DNS zones	963
6.10.12. Creating a VNet in Azure	964
6.10.12.1. ARM template for the VNet	964
6.10.13. Deploying the RHCOS cluster image for the Azure infrastructure	966
6.10.13.1. ARM template for image storage	967
6.10.14. Networking requirements for user-provisioned infrastructure	968
6.10.14.1. Network connectivity requirements	968
6.10.15. Creating networking and load balancing components in Azure	969
6.10.15.1. ARM template for the network and load balancers	970
6.10.16. Creating the bootstrap machine in Azure	975
6.10.16.1. ARM template for the bootstrap machine	976
6.10.17. Creating the control plane machines in Azure	980
6.10.17.1. ARM template for control plane machines	981
6.10.18. Wait for bootstrap completion and remove bootstrap resources in Azure	984
6.10.19. Creating additional worker machines in Azure	985
6.10.19.1. ARM template for worker machines	986
6.10.20. Installing the OpenShift CLI by downloading the binary	990
Installing the OpenShift CLI on Linux	990
Installing the OpenShift CLI on Windows	990
Installing the OpenShift CLI on macOS	991
6.10.21. Logging in to the cluster by using the CLI	991
6.10.22. Approving the certificate signing requests for your machines	992
6.10.23. Adding the Ingress DNS records	995
6.10.24. Completing an Azure installation on user-provisioned infrastructure	996
6.10.25. Telemetry access for OpenShift Container Platform	997
6.11. UNINSTALLING A CLUSTER ON AZURE	997
6.11.1. Removing a cluster that uses installer-provisioned infrastructure	997
<b>CHAPTER 7. INSTALLING ON AZURE STACK HUB</b>	<b>999</b>
7.1. PREPARING TO INSTALL ON AZURE STACK HUB	999
7.1.1. Prerequisites	999
7.1.2. Requirements for installing OpenShift Container Platform on Azure Stack Hub	999
7.1.3. Choosing a method to install OpenShift Container Platform on Azure Stack Hub	999
7.1.3.1. Installing a cluster on installer-provisioned infrastructure	999
7.1.3.2. Installing a cluster on user-provisioned infrastructure	999
7.1.4. Next steps	999

7.2. CONFIGURING AN AZURE STACK HUB ACCOUNT	1000
7.2.1. Azure Stack Hub account limits	1000
7.2.2. Configuring a DNS zone in Azure Stack Hub	1001
7.2.3. Required Azure Stack Hub roles	1002
7.2.4. Creating a service principal	1002
7.2.5. Next steps	1004
7.3. INSTALLING A CLUSTER ON AZURE STACK HUB WITH AN INSTALLER-PROVISIONED INFRASTRUCTURE	1005
7.3.1. Prerequisites	1005
7.3.2. Internet access for OpenShift Container Platform	1005
7.3.3. Generating a key pair for cluster node SSH access	1006
7.3.4. Uploading the RHCOS cluster image	1007
7.3.5. Obtaining the installation program	1008
7.3.6. Manually creating the installation configuration file	1009
7.3.6.1. Installation configuration parameters	1010
7.3.6.1.1. Required configuration parameters	1010
7.3.6.1.2. Network configuration parameters	1011
7.3.6.1.3. Optional configuration parameters	1013
7.3.6.1.4. Additional Azure Stack Hub configuration parameters	1018
7.3.6.2. Sample customized install-config.yaml file for Azure Stack Hub	1020
7.3.7. Manually manage cloud credentials	1022
7.3.8. Configuring the cluster to use an internal CA	1024
7.3.9. Deploying the cluster	1025
7.3.10. Installing the OpenShift CLI by downloading the binary	1026
Installing the OpenShift CLI on Linux	1026
Installing the OpenShift CLI on Windows	1027
Installing the OpenShift CLI on macOS	1027
7.3.11. Logging in to the cluster by using the CLI	1028
7.3.12. Logging in to the cluster by using the web console	1028
7.3.13. Telemetry access for OpenShift Container Platform	1029
7.3.14. Next steps	1029
7.4. INSTALLING A CLUSTER ON AZURE STACK HUB WITH NETWORK CUSTOMIZATIONS	1030
7.4.1. Prerequisites	1030
7.4.2. Internet access for OpenShift Container Platform	1030
7.4.3. Generating a key pair for cluster node SSH access	1031
7.4.4. Uploading the RHCOS cluster image	1032
7.4.5. Obtaining the installation program	1033
7.4.6. Manually creating the installation configuration file	1034
7.4.6.1. Installation configuration parameters	1035
7.4.6.1.1. Required configuration parameters	1035
7.4.6.1.2. Network configuration parameters	1036
7.4.6.1.3. Optional configuration parameters	1038
7.4.6.1.4. Additional Azure Stack Hub configuration parameters	1043
7.4.6.2. Sample customized install-config.yaml file for Azure Stack Hub	1045
7.4.7. Manually manage cloud credentials	1047
7.4.8. Configuring the cluster to use an internal CA	1049
7.4.9. Network configuration phases	1050
7.4.10. Specifying advanced network configuration	1051
7.4.11. Cluster Network Operator configuration	1052
7.4.11.1. Cluster Network Operator configuration object	1052
defaultNetwork object configuration	1053
Configuration for the OpenShift SDN CNI cluster network provider	1053
Configuration for the OVN-Kubernetes CNI cluster network provider	1054

kubeProxyConfig object configuration	1056
7.4.12. Configuring hybrid networking with OVN-Kubernetes	1057
7.4.13. Deploying the cluster	1059
7.4.14. Installing the OpenShift CLI by downloading the binary	1060
Installing the OpenShift CLI on Linux	1060
Installing the OpenShift CLI on Windows	1061
Installing the OpenShift CLI on macOS	1061
7.4.15. Logging in to the cluster by using the CLI	1062
7.4.16. Logging in to the cluster by using the web console	1062
7.4.17. Telemetry access for OpenShift Container Platform	1063
7.4.18. Next steps	1064
7.5. INSTALLING A CLUSTER ON AZURE STACK HUB USING ARM TEMPLATES	1064
7.5.1. Prerequisites	1064
7.5.2. Internet access for OpenShift Container Platform	1064
7.5.3. Configuring your Azure Stack Hub project	1065
7.5.3.1. Azure Stack Hub account limits	1065
7.5.3.2. Configuring a DNS zone in Azure Stack Hub	1067
7.5.3.3. Certificate signing requests management	1067
7.5.3.4. Required Azure Stack Hub roles	1067
7.5.3.5. Creating a service principal	1068
7.5.4. Obtaining the installation program	1070
7.5.5. Generating a key pair for cluster node SSH access	1071
7.5.6. Creating the installation files for Azure Stack Hub	1073
7.5.6.1. Manually creating the installation configuration file	1073
7.5.6.2. Sample customized install-config.yaml file for Azure Stack Hub	1075
7.5.6.3. Configuring the cluster-wide proxy during installation	1077
7.5.6.4. Exporting common variables for ARM templates	1078
7.5.6.5. Creating the Kubernetes manifest and Ignition config files	1079
7.5.6.6. Optional: Creating a separate /var partition	1084
7.5.7. Creating the Azure resource group	1086
7.5.8. Uploading the RHCOS cluster image and bootstrap Ignition config file	1086
7.5.9. Example for creating DNS zones	1088
7.5.10. Creating a VNet in Azure Stack Hub	1089
7.5.10.1. ARM template for the VNet	1089
7.5.11. Deploying the RHCOS cluster image for the Azure Stack Hub infrastructure	1089
7.5.11.1. ARM template for image storage	1090
7.5.12. Networking requirements for user-provisioned infrastructure	1090
7.5.12.1. Network connectivity requirements	1090
7.5.13. Creating networking and load balancing components in Azure Stack Hub	1092
7.5.13.1. ARM template for the network and load balancers	1093
7.5.14. Creating the bootstrap machine in Azure Stack Hub	1093
7.5.14.1. ARM template for the bootstrap machine	1095
7.5.15. Creating the control plane machines in Azure Stack Hub	1095
7.5.15.1. ARM template for control plane machines	1096
7.5.16. Wait for bootstrap completion and remove bootstrap resources in Azure Stack Hub	1096
7.5.17. Creating additional worker machines in Azure Stack Hub	1097
7.5.17.1. ARM template for worker machines	1098
7.5.18. Installing the OpenShift CLI by downloading the binary	1098
Installing the OpenShift CLI on Linux	1098
Installing the OpenShift CLI on Windows	1099
Installing the OpenShift CLI on macOS	1099
7.5.19. Logging in to the cluster by using the CLI	1100
7.5.20. Approving the certificate signing requests for your machines	1100

7.5.21. Adding the Ingress DNS records	1103
7.5.22. Completing an Azure Stack Hub installation on user-provisioned infrastructure	1104
7.6. UNINSTALLING A CLUSTER ON AZURE STACK HUB	1105
7.6.1. Removing a cluster that uses installer-provisioned infrastructure	1105
<b>CHAPTER 8. INSTALLING ON GCP</b> .....	<b>1107</b>
8.1. PREPARING TO INSTALL ON GCP	1107
8.1.1. Prerequisites	1107
8.1.2. Requirements for installing OpenShift Container Platform on GCP	1107
8.1.3. Choosing a method to install OpenShift Container Platform on GCP	1107
8.1.3.1. Installing a cluster on installer-provisioned infrastructure	1107
8.1.3.2. Installing a cluster on user-provisioned infrastructure	1108
8.1.4. Next steps	1108
8.2. CONFIGURING A GCP PROJECT	1108
8.2.1. Creating a GCP project	1108
8.2.2. Enabling API services in GCP	1109
8.2.3. Configuring DNS for GCP	1110
8.2.4. GCP account limits	1110
8.2.5. Creating a service account in GCP	1112
8.2.5.1. Required GCP roles	1112
8.2.5.2. Required GCP permissions for installer-provisioned infrastructure	1113
8.2.6. Supported GCP regions	1120
8.2.7. Next steps	1121
8.3. MANUALLY CREATING IAM FOR GCP	1121
8.3.1. Alternatives to storing administrator-level secrets in the kube-system project	1122
8.3.2. Manually create IAM	1123
8.3.3. Mint mode	1125
8.3.4. Mint mode with removal or rotation of the administrator-level credential	1126
8.3.5. Next steps	1126
8.4. INSTALLING A CLUSTER QUICKLY ON GCP	1126
8.4.1. Prerequisites	1126
8.4.2. Internet access for OpenShift Container Platform	1127
8.4.3. Generating a key pair for cluster node SSH access	1127
8.4.4. Obtaining the installation program	1129
8.4.5. Deploying the cluster	1130
8.4.6. Installing the OpenShift CLI by downloading the binary	1132
Installing the OpenShift CLI on Linux	1133
Installing the OpenShift CLI on Windows	1133
Installing the OpenShift CLI on macOS	1134
8.4.7. Logging in to the cluster by using the CLI	1134
8.4.8. Telemetry access for OpenShift Container Platform	1135
8.4.9. Next steps	1135
8.5. INSTALLING A CLUSTER ON GCP WITH CUSTOMIZATIONS	1135
8.5.1. Prerequisites	1135
8.5.2. Internet access for OpenShift Container Platform	1135
8.5.3. Generating a key pair for cluster node SSH access	1136
8.5.4. Obtaining the installation program	1138
8.5.5. Creating the installation configuration file	1139
8.5.5.1. Installation configuration parameters	1140
8.5.5.1.1. Required configuration parameters	1140
8.5.5.1.2. Network configuration parameters	1142
8.5.5.1.3. Optional configuration parameters	1144
8.5.5.1.4. Additional Google Cloud Platform (GCP) configuration parameters	1148

---

8.5.5.2. Minimum resource requirements for cluster installation	1152
8.5.5.3. Tested instance types for GCP	1152
8.5.5.4. Using custom machine types	1153
8.5.5.5. Sample customized install-config.yaml file for GCP	1154
8.5.5.6. Configuring the cluster-wide proxy during installation	1156
8.5.6. Using a GCP Marketplace image	1157
8.5.7. Deploying the cluster	1158
8.5.8. Installing the OpenShift CLI by downloading the binary	1160
Installing the OpenShift CLI on Linux	1160
Installing the OpenShift CLI on Windows	1161
Installing the OpenShift CLI on macOS	1161
8.5.9. Logging in to the cluster by using the CLI	1162
8.5.10. Telemetry access for OpenShift Container Platform	1162
8.5.11. Next steps	1163
8.6. INSTALLING A CLUSTER ON GCP WITH NETWORK CUSTOMIZATIONS	1163
8.6.1. Prerequisites	1163
8.6.2. Internet access for OpenShift Container Platform	1163
8.6.3. Generating a key pair for cluster node SSH access	1164
8.6.4. Obtaining the installation program	1166
8.6.5. Creating the installation configuration file	1167
8.6.5.1. Installation configuration parameters	1168
8.6.5.1.1. Required configuration parameters	1168
8.6.5.1.2. Network configuration parameters	1170
8.6.5.1.3. Optional configuration parameters	1172
8.6.5.1.4. Additional Google Cloud Platform (GCP) configuration parameters	1176
8.6.5.2. Minimum resource requirements for cluster installation	1180
8.6.5.3. Tested instance types for GCP	1180
8.6.5.4. Using custom machine types	1181
8.6.5.5. Sample customized install-config.yaml file for GCP	1182
8.6.6. Additional resources	1184
8.6.6.1. Configuring the cluster-wide proxy during installation	1184
8.6.7. Network configuration phases	1185
8.6.8. Specifying advanced network configuration	1186
8.6.9. Cluster Network Operator configuration	1187
8.6.9.1. Cluster Network Operator configuration object	1188
defaultNetwork object configuration	1189
Configuration for the OpenShift SDN CNI cluster network provider	1189
Configuration for the OVN-Kubernetes CNI cluster network provider	1190
kubeProxyConfig object configuration	1192
8.6.10. Deploying the cluster	1193
8.6.11. Installing the OpenShift CLI by downloading the binary	1195
Installing the OpenShift CLI on Linux	1195
Installing the OpenShift CLI on Windows	1195
Installing the OpenShift CLI on macOS	1196
8.6.12. Logging in to the cluster by using the CLI	1196
8.6.13. Telemetry access for OpenShift Container Platform	1197
8.6.14. Next steps	1197
8.7. INSTALLING A CLUSTER ON GCP IN A RESTRICTED NETWORK	1197
8.7.1. Prerequisites	1197
8.7.2. About installations in restricted networks	1198
8.7.2.1. Additional limits	1198
8.7.3. Internet access for OpenShift Container Platform	1198
8.7.4. Generating a key pair for cluster node SSH access	1199

---

8.7.5. Creating the installation configuration file	1201
8.7.5.1. Installation configuration parameters	1203
8.7.5.1.1. Required configuration parameters	1203
8.7.5.1.2. Network configuration parameters	1205
8.7.5.1.3. Optional configuration parameters	1207
8.7.5.1.4. Additional Google Cloud Platform (GCP) configuration parameters	1211
8.7.5.2. Minimum resource requirements for cluster installation	1215
8.7.5.3. Tested instance types for GCP	1215
8.7.5.4. Using custom machine types	1216
8.7.5.5. Sample customized install-config.yaml file for GCP	1217
8.7.5.6. Create an Ingress Controller with global access on GCP	1220
8.7.5.7. Configuring the cluster-wide proxy during installation	1221
8.7.6. Deploying the cluster	1222
8.7.7. Installing the OpenShift CLI by downloading the binary	1224
Installing the OpenShift CLI on Linux	1224
Installing the OpenShift CLI on Windows	1225
Installing the OpenShift CLI on macOS	1225
8.7.8. Logging in to the cluster by using the CLI	1226
8.7.9. Disabling the default OperatorHub sources	1226
8.7.10. Telemetry access for OpenShift Container Platform	1227
8.7.11. Next steps	1227
8.8. INSTALLING A CLUSTER ON GCP INTO AN EXISTING VPC	1227
8.8.1. Prerequisites	1227
8.8.2. About using a custom VPC	1227
8.8.2.1. Requirements for using your VPC	1228
8.8.2.2. VPC validation	1228
8.8.2.3. Division of permissions	1228
8.8.2.4. Isolation between clusters	1228
8.8.3. Internet access for OpenShift Container Platform	1229
8.8.4. Generating a key pair for cluster node SSH access	1229
8.8.5. Obtaining the installation program	1231
8.8.6. Creating the installation configuration file	1232
8.8.6.1. Installation configuration parameters	1233
8.8.6.1.1. Required configuration parameters	1233
8.8.6.1.2. Network configuration parameters	1235
8.8.6.1.3. Optional configuration parameters	1237
8.8.6.1.4. Additional Google Cloud Platform (GCP) configuration parameters	1241
8.8.6.2. Minimum resource requirements for cluster installation	1245
8.8.6.3. Tested instance types for GCP	1245
8.8.6.4. Using custom machine types	1246
8.8.6.5. Sample customized install-config.yaml file for GCP	1247
8.8.6.6. Create an Ingress Controller with global access on GCP	1249
8.8.7. Additional resources	1250
8.8.7.1. Configuring the cluster-wide proxy during installation	1250
8.8.8. Deploying the cluster	1252
8.8.9. Installing the OpenShift CLI by downloading the binary	1254
Installing the OpenShift CLI on Linux	1254
Installing the OpenShift CLI on Windows	1254
Installing the OpenShift CLI on macOS	1255
8.8.10. Logging in to the cluster by using the CLI	1255
8.8.11. Telemetry access for OpenShift Container Platform	1256
8.8.12. Next steps	1256
8.9. INSTALLING A PRIVATE CLUSTER ON GCP	1256



8.9.1. Prerequisites	1256
8.9.2. Private clusters	1257
8.9.2.1. Private clusters in GCP	1257
8.9.2.1.1. Limitations	1258
8.9.3. About using a custom VPC	1258
8.9.3.1. Requirements for using your VPC	1258
8.9.3.2. Division of permissions	1259
8.9.3.3. Isolation between clusters	1259
8.9.4. Internet access for OpenShift Container Platform	1259
8.9.5. Generating a key pair for cluster node SSH access	1260
8.9.6. Obtaining the installation program	1262
8.9.7. Manually creating the installation configuration file	1263
8.9.7.1. Installation configuration parameters	1263
8.9.7.1.1. Required configuration parameters	1264
8.9.7.1.2. Network configuration parameters	1265
8.9.7.1.3. Optional configuration parameters	1267
8.9.7.1.4. Additional Google Cloud Platform (GCP) configuration parameters	1272
8.9.7.2. Minimum resource requirements for cluster installation	1276
8.9.7.3. Tested instance types for GCP	1276
8.9.7.4. Using custom machine types	1277
8.9.7.5. Sample customized install-config.yaml file for GCP	1277
8.9.7.6. Create an Ingress Controller with global access on GCP	1280
8.9.8. Additional resources	1281
8.9.8.1. Configuring the cluster-wide proxy during installation	1281
8.9.9. Deploying the cluster	1283
8.9.10. Installing the OpenShift CLI by downloading the binary	1284
Installing the OpenShift CLI on Linux	1284
Installing the OpenShift CLI on Windows	1285
Installing the OpenShift CLI on macOS	1285
8.9.11. Logging in to the cluster by using the CLI	1286
8.9.12. Telemetry access for OpenShift Container Platform	1287
8.9.13. Next steps	1287
8.10. INSTALLING A CLUSTER ON USER-PROVISIONED INFRASTRUCTURE IN GCP BY USING DEPLOYMENT MANAGER TEMPLATES	1287
8.10.1. Prerequisites	1287
8.10.2. Certificate signing requests management	1288
8.10.3. Internet access for OpenShift Container Platform	1288
8.10.4. Configuring your GCP project	1288
8.10.4.1. Creating a GCP project	1288
8.10.4.2. Enabling API services in GCP	1289
8.10.4.3. Configuring DNS for GCP	1290
8.10.4.4. GCP account limits	1290
8.10.4.5. Creating a service account in GCP	1292
8.10.4.6. Required GCP roles	1292
8.10.4.7. Required GCP permissions for user-provisioned infrastructure	1293
8.10.4.8. Supported GCP regions	1301
8.10.4.9. Installing and configuring CLI tools for GCP	1302
8.10.5. Requirements for a cluster with user-provisioned infrastructure	1302
8.10.5.1. Required machines for cluster installation	1302
8.10.5.2. Minimum resource requirements for cluster installation	1303
8.10.5.3. Tested instance types for GCP	1304
8.10.5.4. Using custom machine types	1304
8.10.6. Creating the installation files for GCP	1304

8.10.6.1. Optional: Creating a separate /var partition	1305
8.10.6.2. Creating the installation configuration file	1307
8.10.6.3. Configuring the cluster-wide proxy during installation	1309
8.10.6.4. Creating the Kubernetes manifest and Ignition config files	1310
8.10.7. Exporting common variables	1312
8.10.7.1. Extracting the infrastructure name	1312
8.10.7.2. Exporting common variables for Deployment Manager templates	1313
8.10.8. Creating a VPC in GCP	1314
8.10.8.1. Deployment Manager template for the VPC	1315
8.10.9. Networking requirements for user-provisioned infrastructure	1316
8.10.9.1. Setting the cluster node hostnames through DHCP	1316
8.10.9.2. Network connectivity requirements	1316
8.10.10. Creating load balancers in GCP	1318
8.10.10.1. Deployment Manager template for the external load balancer	1319
8.10.10.2. Deployment Manager template for the internal load balancer	1320
8.10.11. Creating a private DNS zone in GCP	1322
8.10.11.1. Deployment Manager template for the private DNS	1323
8.10.12. Creating firewall rules in GCP	1324
8.10.12.1. Deployment Manager template for firewall rules	1325
8.10.13. Creating IAM roles in GCP	1327
8.10.13.1. Deployment Manager template for IAM roles	1329
8.10.14. Creating the RHCOS cluster image for the GCP infrastructure	1329
8.10.15. Creating the bootstrap machine in GCP	1330
8.10.15.1. Deployment Manager template for the bootstrap machine	1332
8.10.16. Creating the control plane machines in GCP	1334
8.10.16.1. Deployment Manager template for control plane machines	1336
8.10.17. Wait for bootstrap completion and remove bootstrap resources in GCP	1338
8.10.18. Creating additional worker machines in GCP	1339
8.10.18.1. Deployment Manager template for worker machines	1341
8.10.19. Installing the OpenShift CLI by downloading the binary	1342
Installing the OpenShift CLI on Linux	1342
Installing the OpenShift CLI on Windows	1342
Installing the OpenShift CLI on macOS	1343
8.10.20. Logging in to the cluster by using the CLI	1343
8.10.21. Approving the certificate signing requests for your machines	1344
8.10.22. Optional: Adding the ingress DNS records	1347
8.10.23. Completing a GCP installation on user-provisioned infrastructure	1348
8.10.24. Telemetry access for OpenShift Container Platform	1351
8.10.25. Next steps	1351
8.11. INSTALLING A CLUSTER INTO A SHARED VPC ON GCP USING DEPLOYMENT MANAGER TEMPLATES	1351
8.11.1. Prerequisites	1351
8.11.2. Certificate signing requests management	1352
8.11.3. Internet access for OpenShift Container Platform	1352
8.11.4. Configuring the GCP project that hosts your cluster	1352
8.11.4.1. Creating a GCP project	1352
8.11.4.2. Enabling API services in GCP	1353
8.11.4.3. GCP account limits	1354
8.11.4.4. Creating a service account in GCP	1355
8.11.4.4.1. Required GCP roles	1356
8.11.4.5. Supported GCP regions	1357
8.11.4.6. Installing and configuring CLI tools for GCP	1358
8.11.5. Requirements for a cluster with user-provisioned infrastructure	1358

---

8.11.5.1. Required machines for cluster installation	1359
8.11.5.2. Minimum resource requirements for cluster installation	1359
8.11.5.3. Tested instance types for GCP	1360
8.11.5.4. Using custom machine types	1360
8.11.6. Configuring the GCP project that hosts your shared VPC network	1361
8.11.6.1. Configuring DNS for GCP	1361
8.11.6.2. Creating a VPC in GCP	1362
8.11.6.2.1. Deployment Manager template for the VPC	1364
8.11.7. Creating the installation files for GCP	1365
8.11.7.1. Manually creating the installation configuration file	1365
8.11.7.2. Sample customized install-config.yaml file for GCP	1366
8.11.7.3. Configuring the cluster-wide proxy during installation	1368
8.11.7.4. Creating the Kubernetes manifest and Ignition config files	1370
8.11.8. Exporting common variables	1372
8.11.8.1. Extracting the infrastructure name	1372
8.11.8.2. Exporting common variables for Deployment Manager templates	1373
8.11.9. Networking requirements for user-provisioned infrastructure	1374
8.11.9.1. Setting the cluster node hostnames through DHCP	1374
8.11.9.2. Network connectivity requirements	1374
8.11.10. Creating load balancers in GCP	1375
8.11.10.1. Deployment Manager template for the external load balancer	1377
8.11.10.2. Deployment Manager template for the internal load balancer	1378
8.11.11. Creating a private DNS zone in GCP	1380
8.11.11.1. Deployment Manager template for the private DNS	1381
8.11.12. Creating firewall rules in GCP	1382
8.11.12.1. Deployment Manager template for firewall rules	1383
8.11.13. Creating IAM roles in GCP	1385
8.11.13.1. Deployment Manager template for IAM roles	1388
8.11.14. Creating the RHCOS cluster image for the GCP infrastructure	1388
8.11.15. Creating the bootstrap machine in GCP	1389
8.11.15.1. Deployment Manager template for the bootstrap machine	1391
8.11.16. Creating the control plane machines in GCP	1392
8.11.16.1. Deployment Manager template for control plane machines	1394
8.11.17. Wait for bootstrap completion and remove bootstrap resources in GCP	1396
8.11.18. Creating additional worker machines in GCP	1397
8.11.18.1. Deployment Manager template for worker machines	1400
8.11.19. Installing the OpenShift CLI by downloading the binary	1401
Installing the OpenShift CLI on Linux	1401
Installing the OpenShift CLI on Windows	1401
Installing the OpenShift CLI on macOS	1402
8.11.20. Logging in to the cluster by using the CLI	1402
8.11.21. Approving the certificate signing requests for your machines	1403
8.11.22. Adding the ingress DNS records	1405
8.11.23. Adding ingress firewall rules	1407
8.11.23.1. Creating cluster-wide firewall rules for a shared VPC in GCP	1407
8.11.24. Completing a GCP installation on user-provisioned infrastructure	1408
8.11.25. Telemetry access for OpenShift Container Platform	1411
8.11.26. Next steps	1411
8.12. INSTALLING A CLUSTER ON GCP IN A RESTRICTED NETWORK WITH USER-PROVISIONED INFRASTRUCTURE	1411
8.12.1. Prerequisites	1412
8.12.2. About installations in restricted networks	1412
8.12.2.1. Additional limits	1413

---

8.12.3. Internet access for OpenShift Container Platform	1413
8.12.4. Configuring your GCP project	1413
8.12.4.1. Creating a GCP project	1413
8.12.4.2. Enabling API services in GCP	1414
8.12.4.3. Configuring DNS for GCP	1415
8.12.4.4. GCP account limits	1415
8.12.4.5. Creating a service account in GCP	1417
8.12.4.6. Required GCP roles	1417
8.12.4.7. Required GCP permissions for user-provisioned infrastructure	1418
8.12.4.8. Supported GCP regions	1425
8.12.4.9. Installing and configuring CLI tools for GCP	1427
8.12.5. Requirements for a cluster with user-provisioned infrastructure	1427
8.12.5.1. Required machines for cluster installation	1427
8.12.5.2. Minimum resource requirements for cluster installation	1428
8.12.5.3. Tested instance types for GCP	1429
8.12.5.4. Using custom machine types	1429
8.12.6. Creating the installation files for GCP	1429
8.12.6.1. Optional: Creating a separate /var partition	1430
8.12.6.2. Creating the installation configuration file	1432
8.12.6.3. Configuring the cluster-wide proxy during installation	1434
8.12.6.4. Creating the Kubernetes manifest and Ignition config files	1436
8.12.7. Exporting common variables	1438
8.12.7.1. Extracting the infrastructure name	1438
8.12.7.2. Exporting common variables for Deployment Manager templates	1439
8.12.8. Creating a VPC in GCP	1439
8.12.8.1. Deployment Manager template for the VPC	1440
8.12.9. Networking requirements for user-provisioned infrastructure	1442
8.12.9.1. Setting the cluster node hostnames through DHCP	1442
8.12.9.2. Network connectivity requirements	1442
8.12.10. Creating load balancers in GCP	1443
8.12.10.1. Deployment Manager template for the external load balancer	1445
8.12.10.2. Deployment Manager template for the internal load balancer	1446
8.12.11. Creating a private DNS zone in GCP	1447
8.12.11.1. Deployment Manager template for the private DNS	1449
8.12.12. Creating firewall rules in GCP	1449
8.12.12.1. Deployment Manager template for firewall rules	1450
8.12.13. Creating IAM roles in GCP	1453
8.12.13.1. Deployment Manager template for IAM roles	1454
8.12.14. Creating the RHCOS cluster image for the GCP infrastructure	1455
8.12.15. Creating the bootstrap machine in GCP	1456
8.12.15.1. Deployment Manager template for the bootstrap machine	1458
8.12.16. Creating the control plane machines in GCP	1459
8.12.16.1. Deployment Manager template for control plane machines	1461
8.12.17. Wait for bootstrap completion and remove bootstrap resources in GCP	1463
8.12.18. Creating additional worker machines in GCP	1464
8.12.18.1. Deployment Manager template for worker machines	1466
8.12.19. Logging in to the cluster by using the CLI	1467
8.12.20. Disabling the default OperatorHub sources	1468
8.12.21. Approving the certificate signing requests for your machines	1468
8.12.22. Optional: Adding the ingress DNS records	1471
8.12.23. Completing a GCP installation on user-provisioned infrastructure	1472
8.12.24. Telemetry access for OpenShift Container Platform	1475
8.12.25. Next steps	1475

8.13. UNINSTALLING A CLUSTER ON GCP	1475
8.13.1. Removing a cluster that uses installer-provisioned infrastructure	1475
8.13.2. Deleting GCP resources with the Cloud Credential Operator utility	1476
<b>CHAPTER 9. INSTALLING ON IBM CLOUD VPC</b> .....	<b>1478</b>
9.1. PREPARING TO INSTALL ON IBM CLOUD VPC	1478
9.1.1. Prerequisites	1478
9.1.2. Requirements for installing OpenShift Container Platform on IBM Cloud VPC	1478
9.1.3. Choosing a method to install OpenShift Container Platform on IBM Cloud VPC	1478
9.1.3.1. Installing a cluster on installer-provisioned infrastructure	1478
9.1.4. Next steps	1479
9.2. CONFIGURING AN IBM CLOUD ACCOUNT	1479
9.2.1. Prerequisites	1479
9.2.2. Quotas and limits on IBM Cloud VPC	1479
Virtual Private Cloud (VPC)	1479
Application load balancer	1479
Floating IP address	1480
Virtual Server Instances (VSI)	1480
Block Storage Volumes	1481
9.2.3. Configuring DNS resolution using Cloud Internet Services	1481
9.2.4. IBM Cloud VPC IAM Policies and API Key	1482
9.2.4.1. Required access policies	1482
9.2.4.2. Access policy assignment	1483
9.2.4.3. Creating an API key	1483
9.2.5. Supported IBM Cloud VPC regions	1484
9.2.6. Next steps	1484
9.3. CONFIGURING IAM FOR IBM CLOUD VPC	1484
9.3.1. Alternatives to storing administrator-level secrets in the kube-system project	1485
9.3.2. Configuring the Cloud Credential Operator utility	1485
9.3.3. Next steps	1486
9.3.4. Additional resources	1486
9.4. INSTALLING A CLUSTER ON IBM CLOUD VPC WITH CUSTOMIZATIONS	1486
9.4.1. Prerequisites	1487
9.4.2. Internet access for OpenShift Container Platform	1487
9.4.3. Generating a key pair for cluster node SSH access	1487
9.4.4. Obtaining the installation program	1489
9.4.5. Exporting the IBM Cloud VPC API key	1490
9.4.6. Creating the installation configuration file	1490
9.4.6.1. Installation configuration parameters	1492
9.4.6.1.1. Required configuration parameters	1492
9.4.6.1.2. Network configuration parameters	1493
9.4.6.1.3. Optional configuration parameters	1495
9.4.6.1.4. Additional IBM Cloud VPC configuration parameters	1500
9.4.6.2. Sample customized install-config.yaml file for IBM Cloud VPC	1501
9.4.6.3. Configuring the cluster-wide proxy during installation	1503
9.4.7. Manually creating IAM for IBM Cloud VPC	1504
9.4.8. Deploying the cluster	1507
9.4.9. Installing the OpenShift CLI by downloading the binary	1508
Installing the OpenShift CLI on Linux	1508
Installing the OpenShift CLI on Windows	1509
Installing the OpenShift CLI on macOS	1509
9.4.10. Logging in to the cluster by using the CLI	1510
9.4.11. Telemetry access for OpenShift Container Platform	1510

9.4.12. Next steps	1510
9.5. INSTALLING A CLUSTER ON IBM CLOUD VPC WITH NETWORK CUSTOMIZATIONS	1511
9.5.1. Prerequisites	1511
9.5.2. Internet access for OpenShift Container Platform	1511
9.5.3. Generating a key pair for cluster node SSH access	1512
9.5.4. Obtaining the installation program	1514
9.5.5. Exporting the IBM Cloud VPC API key	1514
9.5.6. Creating the installation configuration file	1515
9.5.6.1. Installation configuration parameters	1516
9.5.6.1.1. Required configuration parameters	1516
9.5.6.1.2. Network configuration parameters	1518
9.5.6.1.3. Optional configuration parameters	1520
9.5.6.1.4. Additional IBM Cloud VPC configuration parameters	1524
9.5.6.2. Sample customized install-config.yaml file for IBM Cloud VPC	1525
9.5.6.3. Configuring the cluster-wide proxy during installation	1527
9.5.7. Manually creating IAM for IBM Cloud VPC	1529
9.5.8. Network configuration phases	1531
9.5.9. Specifying advanced network configuration	1532
9.5.10. Cluster Network Operator configuration	1533
9.5.10.1. Cluster Network Operator configuration object	1533
defaultNetwork object configuration	1534
Configuration for the OpenShift SDN CNI cluster network provider	1535
Configuration for the OVN-Kubernetes CNI cluster network provider	1536
kubeProxyConfig object configuration	1538
9.5.11. Deploying the cluster	1539
9.5.12. Installing the OpenShift CLI by downloading the binary	1541
Installing the OpenShift CLI on Linux	1541
Installing the OpenShift CLI on Windows	1541
Installing the OpenShift CLI on macOS	1542
9.5.13. Logging in to the cluster by using the CLI	1542
9.5.14. Telemetry access for OpenShift Container Platform	1543
9.5.15. Next steps	1543
9.6. UNINSTALLING A CLUSTER ON IBM CLOUD VPC	1543
9.6.1. Removing a cluster that uses installer-provisioned infrastructure	1543
<b>CHAPTER 10. INSTALLING ON BARE METAL</b>	<b>1546</b>
10.1. PREPARING FOR BARE METAL CLUSTER INSTALLATION	1546
10.1.1. Prerequisites	1546
10.1.2. Planning a bare metal cluster for OpenShift Virtualization	1546
10.1.3. Choosing a method to install OpenShift Container Platform on bare metal	1546
10.1.3.1. Installing a cluster on installer-provisioned infrastructure	1547
10.1.3.2. Installing a cluster on user-provisioned infrastructure	1547
10.2. INSTALLING A USER-PROVISIONED CLUSTER ON BARE METAL	1547
10.2.1. Prerequisites	1547
10.2.2. Internet access for OpenShift Container Platform	1548
10.2.3. Requirements for a cluster with user-provisioned infrastructure	1548
10.2.3.1. Required machines for cluster installation	1548
10.2.3.2. Minimum resource requirements for cluster installation	1549
10.2.3.3. Certificate signing requests management	1550
10.2.3.4. Networking requirements for user-provisioned infrastructure	1550
10.2.3.4.1. Setting the cluster node hostnames through DHCP	1551
10.2.3.4.2. Network connectivity requirements	1551
NTP configuration for user-provisioned infrastructure	1552

10.2.3.5. User-provisioned DNS requirements	1552
10.2.3.5.1. Example DNS configuration for user-provisioned clusters	1554
10.2.3.6. Load balancing requirements for user-provisioned infrastructure	1556
10.2.3.6.1. Example load balancer configuration for user-provisioned clusters	1558
10.2.4. Preparing the user-provisioned infrastructure	1560
10.2.5. Validating DNS resolution for user-provisioned infrastructure	1562
10.2.6. Generating a key pair for cluster node SSH access	1564
10.2.7. Obtaining the installation program	1566
10.2.8. Installing the OpenShift CLI by downloading the binary	1567
Installing the OpenShift CLI on Linux	1567
Installing the OpenShift CLI on Windows	1568
Installing the OpenShift CLI on macOS	1568
10.2.9. Manually creating the installation configuration file	1569
10.2.9.1. Installation configuration parameters	1570
10.2.9.1.1. Required configuration parameters	1570
10.2.9.1.2. Network configuration parameters	1571
10.2.9.1.3. Optional configuration parameters	1573
10.2.9.2. Sample install-config.yaml file for bare metal	1578
10.2.9.3. Configuring the cluster-wide proxy during installation	1581
10.2.9.4. Configuring a three-node cluster	1582
10.2.10. Creating the Kubernetes manifest and Ignition config files	1583
10.2.11. Installing RHCOS and starting the OpenShift Container Platform bootstrap process	1585
10.2.11.1. Installing RHCOS by using an ISO image	1586
10.2.11.2. Installing RHCOS by using PXE or iPXE booting	1589
10.2.11.3. Advanced RHCOS installation configuration	1594
10.2.11.3.1. Using advanced networking options for PXE and ISO installations	1594
10.2.11.3.2. Disk partitioning	1595
10.2.11.3.2.1. Creating a separate /var partition	1596
10.2.11.3.2.2. Retaining existing partitions	1598
10.2.11.3.3. Identifying Ignition configs	1599
10.2.11.3.3.1. Customizing a live RHCOS ISO or PXE install	1600
10.2.11.3.3.2. Customizing a live RHCOS ISO image	1600
10.2.11.3.3.2.1. Modifying a live install ISO image to use a custom certificate authority	1601
10.2.11.3.3.2.2. Modifying a live install ISO image with customized network settings	1601
10.2.11.3.3.3. Customizing a live RHCOS PXE environment	1603
10.2.11.3.3.3.1. Modifying a live install PXE environment to use a custom certificate authority	1603
10.2.11.3.3.3.2. Modifying a live install PXE environment with customized network settings	1604
10.2.11.3.4. Advanced RHCOS installation reference	1605
10.2.11.3.4.1. Networking and bonding options for ISO installations	1605
Configuring DHCP or static IP addresses	1606
Configuring an IP address without a static hostname	1606
Specifying multiple network interfaces	1606
Configuring default gateway and route	1607
Disabling DHCP on a single interface	1607
Combining DHCP and static IP configurations	1607
Configuring VLANs on individual interfaces	1607
Providing multiple DNS servers	1607
Bonding multiple network interfaces to a single interface	1608
Bonding multiple network interfaces to a single interface	1608
Using network teaming	1608
10.2.11.3.4.2. coreos-installer options for ISO and PXE installations	1609
10.2.11.3.4.3. coreos.inst boot options for ISO or PXE installations	1613
10.2.11.4. Enabling multipathing with kernel arguments on RHCOS	1614

10.2.11.5. Updating the bootloader using bootupd	1616
10.2.12. Waiting for the bootstrap process to complete	1618
10.2.13. Logging in to the cluster by using the CLI	1619
10.2.14. Approving the certificate signing requests for your machines	1619
10.2.15. Initial Operator configuration	1622
10.2.15.1. Image registry removed during installation	1623
10.2.15.2. Image registry storage configuration	1623
10.2.15.2.1. Configuring registry storage for bare metal and other manual installations	1624
10.2.15.2.2. Configuring storage for the image registry in non-production clusters	1625
10.2.15.2.3. Configuring block registry storage	1626
10.2.16. Completing installation on user-provisioned infrastructure	1626
10.2.17. Telemetry access for OpenShift Container Platform	1629
10.2.18. Next steps	1629
10.3. INSTALLING A USER-PROVISIONED BARE METAL CLUSTER WITH NETWORK CUSTOMIZATIONS	1629
10.3.1. Prerequisites	1629
10.3.2. Internet access for OpenShift Container Platform	1629
10.3.3. Requirements for a cluster with user-provisioned infrastructure	1630
10.3.3.1. Required machines for cluster installation	1630
10.3.3.2. Minimum resource requirements for cluster installation	1631
10.3.3.3. Certificate signing requests management	1632
10.3.3.4. Networking requirements for user-provisioned infrastructure	1632
10.3.3.4.1. Setting the cluster node hostnames through DHCP	1632
10.3.3.4.2. Network connectivity requirements	1633
NTP configuration for user-provisioned infrastructure	1634
10.3.3.5. User-provisioned DNS requirements	1634
10.3.3.5.1. Example DNS configuration for user-provisioned clusters	1636
10.3.3.6. Load balancing requirements for user-provisioned infrastructure	1638
10.3.3.6.1. Example load balancer configuration for user-provisioned clusters	1640
10.3.4. Preparing the user-provisioned infrastructure	1642
10.3.5. Validating DNS resolution for user-provisioned infrastructure	1644
10.3.6. Generating a key pair for cluster node SSH access	1646
10.3.7. Obtaining the installation program	1648
10.3.8. Installing the OpenShift CLI by downloading the binary	1649
Installing the OpenShift CLI on Linux	1649
Installing the OpenShift CLI on Windows	1649
Installing the OpenShift CLI on macOS	1650
10.3.9. Manually creating the installation configuration file	1650
10.3.9.1. Installation configuration parameters	1651
10.3.9.1.1. Required configuration parameters	1651
10.3.9.1.2. Network configuration parameters	1653
10.3.9.1.3. Optional configuration parameters	1655
10.3.9.2. Sample install-config.yaml file for bare metal	1659
10.3.10. Network configuration phases	1662
10.3.11. Specifying advanced network configuration	1663
10.3.12. Cluster Network Operator configuration	1664
10.3.12.1. Cluster Network Operator configuration object	1664
defaultNetwork object configuration	1665
Configuration for the OpenShift SDN CNI cluster network provider	1666
Configuration for the OVN-Kubernetes CNI cluster network provider	1667
kubeProxyConfig object configuration	1669
10.3.13. Creating the Ignition config files	1670
10.3.14. Installing RHCOS and starting the OpenShift Container Platform bootstrap process	1671
10.3.14.1. Installing RHCOS by using an ISO image	1672



---

10.3.14.2. Installing RHCOS by using PXE or iPXE booting	1675
10.3.14.3. Advanced RHCOS installation configuration	1680
10.3.14.3.1. Using advanced networking options for PXE and ISO installations	1680
10.3.14.3.2. Disk partitioning	1681
10.3.14.3.2.1. Creating a separate /var partition	1682
10.3.14.3.2.2. Retaining existing partitions	1684
10.3.14.3.3. Identifying Ignition configs	1685
10.3.14.3.3.1. Customizing a live RHCOS ISO or PXE install	1686
10.3.14.3.3.2. Customizing a live RHCOS ISO image	1686
10.3.14.3.3.2.1. Modifying a live install ISO image to use a custom certificate authority	1687
10.3.14.3.3.2.2. Modifying a live install ISO image with customized network settings	1687
10.3.14.3.3.3. Customizing a live RHCOS PXE environment	1689
10.3.14.3.3.3.1. Modifying a live install PXE environment to use a custom certificate authority	1689
10.3.14.3.3.3.2. Modifying a live install PXE environment with customized network settings	1690
10.3.14.3.4. Advanced RHCOS installation reference	1691
10.3.14.3.4.1. Networking and bonding options for ISO installations	1691
Configuring DHCP or static IP addresses	1692
Configuring an IP address without a static hostname	1692
Specifying multiple network interfaces	1692
Configuring default gateway and route	1693
Disabling DHCP on a single interface	1693
Combining DHCP and static IP configurations	1693
Configuring VLANs on individual interfaces	1693
Providing multiple DNS servers	1693
Bonding multiple network interfaces to a single interface	1694
Bonding multiple network interfaces to a single interface	1694
Using network teaming	1694
10.3.14.3.4.2. coreos-installer options for ISO and PXE installations	1695
10.3.14.3.4.3. coreos.inst boot options for ISO or PXE installations	1699
10.3.14.4. Enabling multipathing with kernel arguments on RHCOS	1700
10.3.14.5. Updating the bootloader using bootupd	1702
10.3.15. Waiting for the bootstrap process to complete	1704
10.3.16. Logging in to the cluster by using the CLI	1705
10.3.17. Approving the certificate signing requests for your machines	1705
10.3.18. Initial Operator configuration	1708
10.3.18.1. Image registry removed during installation	1709
10.3.18.2. Image registry storage configuration	1709
10.3.18.3. Configuring block registry storage	1709
10.3.19. Completing installation on user-provisioned infrastructure	1710
10.3.20. Telemetry access for OpenShift Container Platform	1712
10.3.21. Next steps	1712
10.4. INSTALLING A USER-PROVISIONED BARE METAL CLUSTER ON A RESTRICTED NETWORK	1713
10.4.1. Prerequisites	1713
10.4.2. About installations in restricted networks	1713
10.4.2.1. Additional limits	1714
10.4.3. Internet access for OpenShift Container Platform	1714
10.4.4. Requirements for a cluster with user-provisioned infrastructure	1714
10.4.4.1. Required machines for cluster installation	1715
10.4.4.2. Minimum resource requirements for cluster installation	1715
10.4.4.3. Certificate signing requests management	1716
10.4.4.4. Networking requirements for user-provisioned infrastructure	1716
10.4.4.4.1. Setting the cluster node hostnames through DHCP	1717
10.4.4.4.2. Network connectivity requirements	1717

---

NTP configuration for user-provisioned infrastructure	1718
10.4.4.5. User-provisioned DNS requirements	1719
10.4.4.5.1. Example DNS configuration for user-provisioned clusters	1721
10.4.4.6. Load balancing requirements for user-provisioned infrastructure	1723
10.4.4.6.1. Example load balancer configuration for user-provisioned clusters	1725
10.4.5. Preparing the user-provisioned infrastructure	1727
10.4.6. Validating DNS resolution for user-provisioned infrastructure	1729
10.4.7. Generating a key pair for cluster node SSH access	1731
10.4.8. Manually creating the installation configuration file	1733
10.4.8.1. Installation configuration parameters	1734
10.4.8.1.1. Required configuration parameters	1734
10.4.8.1.2. Network configuration parameters	1736
10.4.8.1.3. Optional configuration parameters	1738
10.4.8.2. Sample install-config.yaml file for bare metal	1742
10.4.8.3. Configuring the cluster-wide proxy during installation	1745
10.4.8.4. Configuring a three-node cluster	1747
10.4.9. Creating the Kubernetes manifest and Ignition config files	1748
10.4.10. Configuring chrony time service	1750
10.4.11. Installing RHCOS and starting the OpenShift Container Platform bootstrap process	1751
10.4.11.1. Installing RHCOS by using an ISO image	1752
10.4.11.2. Installing RHCOS by using PXE or iPXE booting	1755
10.4.11.3. Advanced RHCOS installation configuration	1760
10.4.11.3.1. Using advanced networking options for PXE and ISO installations	1760
10.4.11.3.2. Disk partitioning	1761
10.4.11.3.2.1. Creating a separate /var partition	1762
10.4.11.3.2.2. Retaining existing partitions	1764
10.4.11.3.3. Identifying Ignition configs	1765
10.4.11.3.3.1. Customizing a live RHCOS ISO or PXE install	1765
10.4.11.3.3.2. Customizing a live RHCOS ISO image	1766
10.4.11.3.3.2.1. Modifying a live install ISO image to use a custom certificate authority	1766
10.4.11.3.3.2.2. Modifying a live install ISO image with customized network settings	1767
10.4.11.3.3.3. Customizing a live RHCOS PXE environment	1768
10.4.11.3.3.3.1. Modifying a live install PXE environment to use a custom certificate authority	1769
10.4.11.3.3.3.2. Modifying a live install PXE environment with customized network settings	1769
10.4.11.3.4. Advanced RHCOS installation reference	1771
10.4.11.3.4.1. Networking and bonding options for ISO installations	1771
Configuring DHCP or static IP addresses	1771
Configuring an IP address without a static hostname	1772
Specifying multiple network interfaces	1772
Configuring default gateway and route	1772
Disabling DHCP on a single interface	1773
Combining DHCP and static IP configurations	1773
Configuring VLANs on individual interfaces	1773
Providing multiple DNS servers	1773
Bonding multiple network interfaces to a single interface	1773
Bonding multiple network interfaces to a single interface	1774
Using network teaming	1774
10.4.11.3.4.2. coreos-installer options for ISO and PXE installations	1774
10.4.11.3.4.3. coreos.inst boot options for ISO or PXE installations	1778
10.4.11.4. Enabling multipathing with kernel arguments on RHCOS	1780
10.4.11.5. Updating the bootloader using bootupd	1782
10.4.12. Waiting for the bootstrap process to complete	1783
10.4.13. Logging in to the cluster by using the CLI	1784

10.4.14. Approving the certificate signing requests for your machines	1785
10.4.15. Initial Operator configuration	1787
10.4.15.1. Disabling the default OperatorHub sources	1788
10.4.15.2. Image registry storage configuration	1789
10.4.15.2.1. Changing the image registry's management state	1789
10.4.15.2.2. Configuring registry storage for bare metal and other manual installations	1789
10.4.15.2.3. Configuring storage for the image registry in non-production clusters	1791
10.4.15.2.4. Configuring block registry storage	1791
10.4.16. Completing installation on user-provisioned infrastructure	1792
10.4.17. Telemetry access for OpenShift Container Platform	1794
10.4.18. Next steps	1795
<b>CHAPTER 11. INSTALLING ON-PREMISE WITH ASSISTED INSTALLER</b> .....	<b>1796</b>
11.1. INSTALLING AN ON-PREMISE CLUSTER USING THE ASSISTED INSTALLER	1796
11.1.1. Using the Assisted Installer	1796
11.1.2. API support for the Assisted Installer	1797
11.2. PREPARING TO INSTALL WITH THE ASSISTED INSTALLER	1797
11.2.1. Prerequisites	1797
11.2.2. Assisted Installer prerequisites	1797
11.2.2.1. Hardware	1797
11.2.2.2. Networking	1798
11.2.2.3. Preflight validations	1798
11.2.3. Additional resources	1799
11.3. INSTALLING WITH THE ASSISTED INSTALLER	1799
11.3.1. Pre-installation considerations	1799
11.3.2. Setting the cluster details	1799
11.3.3. Optional: Configuring host network interfaces	1800
11.3.4. Adding hosts to the cluster	1801
11.3.5. Creating an ISO image on a USB drive	1802
11.3.6. Booting with a USB drive	1802
11.3.7. Booting from an HTTP-hosted ISO image using the Redfish API	1802
11.3.8. Configuring hosts	1803
11.3.9. Configuring networking	1804
11.3.10. Installing the cluster	1805
11.3.11. Completing the installation	1805
11.3.12. Additional resources	1806
<b>CHAPTER 12. INSTALLING ON A SINGLE NODE</b> .....	<b>1807</b>
12.1. PREPARING TO INSTALL ON A SINGLE NODE	1807
12.1.1. Prerequisites	1807
12.1.2. About OpenShift on a single node	1807
12.1.3. Requirements for installing OpenShift on a single node	1807
12.2. INSTALLING OPENSIFT ON A SINGLE NODE	1808
12.2.1. Generating the discovery ISO with the Assisted Installer	1808
12.2.2. Generating the discovery ISO manually	1809
12.2.3. Installing with USB media	1811
12.2.4. Monitoring the installation with the Assisted Installer	1812
12.2.5. Monitoring the installation manually	1812
<b>CHAPTER 13. DEPLOYING INSTALLER-PROVISIONED CLUSTERS ON BARE METAL</b> .....	<b>1814</b>
13.1. OVERVIEW	1814
13.2. PREREQUISITES	1815
13.2.1. Node requirements	1816
13.2.2. Planning a bare metal cluster for OpenShift Virtualization	1817

13.2.3. Firmware requirements for installing with virtual media	1818
13.2.4. Network requirements	1818
13.2.4.1. Increase the network MTU	1819
13.2.4.2. Configuring NICs	1819
13.2.4.3. DNS requirements	1820
13.2.4.4. Dynamic Host Configuration Protocol (DHCP) requirements	1821
13.2.4.5. Reserving IP addresses for nodes with the DHCP server	1821
13.2.4.6. Network Time Protocol (NTP)	1822
13.2.4.7. Port access for the out-of-band management IP address	1822
13.2.5. Configuring nodes	1823
Configuring nodes when using the provisioning network	1823
Configuring nodes without the provisioning network	1824
Configuring nodes for Secure Boot manually	1824
Configuring the Compatibility Support Module for Fujitsu iRMC	1824
13.2.6. Out-of-band management	1825
13.2.7. Required data for installation	1825
13.2.8. Validation checklist for nodes	1826
13.3. SETTING UP THE ENVIRONMENT FOR AN OPENSIFT INSTALLATION	1827
13.3.1. Installing RHEL on the provisioner node	1827
13.3.2. Preparing the provisioner node for OpenShift Container Platform installation	1827
13.3.3. Establishing communication between subnets	1829
13.3.4. Retrieving the OpenShift Container Platform installer	1832
13.3.5. Extracting the OpenShift Container Platform installer	1832
13.3.6. (Optional) Creating an RHCOS images cache	1833
13.3.7. Configuring the install-config.yaml file	1835
13.3.7.1. Configuring the install-config.yaml file	1835
13.3.7.2. Additional install-config parameters	1837
Hosts	1841
13.3.7.3. BMC addressing	1842
IPMI	1842
Redfish network boot	1843
13.3.7.4. BMC addressing for Dell iDRAC	1843
BMC address formats for Dell iDRAC	1844
Redfish virtual media for Dell iDRAC	1844
Redfish network boot for iDRAC	1845
13.3.7.5. BMC addressing for HPE iLO	1846
Redfish virtual media for HPE iLO	1846
Redfish network boot for HPE iLO	1847
13.3.7.6. BMC addressing for Fujitsu iRMC	1848
13.3.7.7. Root device hints	1849
13.3.7.8. (Optional) Setting proxy settings	1850
13.3.7.9. (Optional) Deploying with no provisioning network	1850
13.3.7.10. (Optional) Deploying with dual-stack networking	1851
13.3.7.11. (Optional) Configuring host network interfaces	1851
13.3.7.12. Configuring host network interfaces for subnets	1853
13.3.7.13. Configuring multiple cluster nodes	1855
13.3.7.14. (Optional) Configuring managed Secure Boot	1855
13.3.8. Manifest configuration files	1856
13.3.8.1. Creating the OpenShift Container Platform manifests	1856
13.3.8.2. (Optional) Configuring NTP for disconnected clusters	1856
13.3.8.3. (Optional) Configuring network components to run on the control plane	1859
13.3.8.4. (Optional) Deploying routers on worker nodes	1861
13.3.8.5. (Optional) Configuring the BIOS for worker nodes	1862

13.3.8.6. (Optional) Configuring RAID for worker nodes	1862
13.3.9. Creating a disconnected registry	1864
Prerequisites	1864
13.3.9.1. Preparing the registry node to host the mirrored registry	1864
13.3.9.2. Mirroring the OpenShift Container Platform image repository for a disconnected registry	1864
13.3.9.3. Modify the install-config.yaml file to use the disconnected registry	1868
13.3.10. Assigning a static IP address to the bootstrap VM	1868
13.3.11. Validation checklist for installation	1869
13.3.12. Deploying the cluster via the OpenShift Container Platform installer	1870
13.3.13. Following the installation	1870
13.3.14. Verifying static IP address configuration	1870
13.3.15. Additional resources	1870
13.4. INSTALLER-PROVISIONED POST-INSTALLATION CONFIGURATION	1870
13.4.1. (Optional) Configuring NTP for disconnected clusters	1871
13.4.2. Enabling a provisioning network after installation	1873
13.4.3. Configuring an external load balancer	1875
13.4.4. Manual migration to new customDeploy install method	1877
13.4.5. Additional resources	1878
13.5. EXPANDING THE CLUSTER	1878
13.5.1. Preparing the bare metal node	1878
13.5.2. Replacing a bare-metal control plane node	1883
13.5.3. Preparing to deploy with Virtual Media on the baremetal network	1886
13.5.4. Diagnosing a duplicate MAC address when provisioning a new host in the cluster	1888
13.5.5. Provisioning the bare metal node	1889
13.6. TROUBLESHOOTING	1891
13.6.1. Troubleshooting the installer workflow	1891
13.6.2. Troubleshooting install-config.yaml	1893
13.6.3. Bootstrap VM issues	1894
13.6.3.1. Bootstrap VM cannot boot up the cluster nodes	1895
13.6.3.2. Inspecting logs	1896
13.6.4. Cluster nodes will not PXE boot	1897
13.6.5. The API is not accessible	1897
13.6.6. Troubleshooting worker nodes that cannot join the cluster	1898
13.6.7. Cleaning up previous installations	1899
13.6.8. Issues with creating the registry	1899
13.6.9. Miscellaneous issues	1900
13.6.9.1. Addressing the runtime network not ready error	1900
13.6.9.2. Cluster nodes not getting the correct IPv6 address over DHCP	1901
13.6.9.3. Cluster nodes not getting the correct hostname over DHCP	1902
13.6.9.4. Routes do not reach endpoints	1903
13.6.9.5. Failed Ignition during Firstboot	1904
13.6.9.6. NTP out of sync	1904
13.6.10. Reviewing the installation	1906
<b>CHAPTER 14. INSTALLING IBM CLOUD BARE METAL (CLASSIC) .....</b>	<b>1908</b>
14.1. PREREQUISITES	1908
14.1.1. Setting up IBM Cloud Bare Metal (Classic) infrastructure	1908
Use one data center per cluster	1908
Create public and private VLANs	1908
Ensure subnets have sufficient IP addresses	1908
Configuring NICs	1909
Configuring canonical names	1910
Creating DNS entries	1910

Network Time Protocol (NTP)	1911
Configure a DHCP server	1911
Ensure BMC access privileges	1911
Create bare metal servers	1912
14.2. SETTING UP THE ENVIRONMENT FOR AN OPENSIFT CONTAINER PLATFORM INSTALLATION	1912
14.2.1. Preparing the provisioner node on IBM Cloud Bare Metal (Classic) infrastructure	1912
14.2.2. Configuring the public subnet	1916
14.2.3. Retrieving the OpenShift Container Platform installer	1918
14.2.4. Extracting the OpenShift Container Platform installer	1918
14.2.5. Configuring the install-config.yaml file	1919
14.2.6. Additional install-config parameters	1921
Hosts	1925
14.2.7. Root device hints	1926
14.2.8. Creating the OpenShift Container Platform manifests	1927
14.2.9. Deploying the cluster via the OpenShift Container Platform installer	1927
14.2.10. Following the installation	1927
<b>CHAPTER 15. INSTALLING WITH Z/VM ON IBM Z AND LINUXONE</b>	<b>1929</b>
15.1. PREPARING TO INSTALL WITH Z/VM ON IBM Z AND LINUXONE	1929
15.1.1. Prerequisites	1929
15.1.2. Choosing a method to install OpenShift Container Platform with z/VM on IBM Z or LinuxONE	1929
15.2. INSTALLING A CLUSTER WITH Z/VM ON IBM Z AND LINUXONE	1929
15.2.1. Prerequisites	1929
15.2.2. Internet access for OpenShift Container Platform	1930
15.2.3. Requirements for a cluster with user-provisioned infrastructure	1930
15.2.3.1. Required machines for cluster installation	1930
15.2.3.2. Minimum resource requirements for cluster installation	1931
15.2.3.3. Minimum IBM Z system environment	1931
Hardware requirements	1932
Operating system requirements	1932
IBM Z network connectivity requirements	1932
Disk storage for the z/VM guest virtual machines	1932
Storage / Main Memory	1932
15.2.3.4. Preferred IBM Z system environment	1933
Hardware requirements	1933
Operating system requirements	1933
IBM Z network connectivity requirements	1933
Disk storage for the z/VM guest virtual machines	1933
Storage / Main Memory	1933
15.2.3.5. Certificate signing requests management	1934
15.2.3.6. Networking requirements for user-provisioned infrastructure	1934
15.2.3.6.1. Network connectivity requirements	1934
NTP configuration for user-provisioned infrastructure	1935
15.2.3.7. User-provisioned DNS requirements	1936
15.2.3.7.1. Example DNS configuration for user-provisioned clusters	1937
15.2.3.8. Load balancing requirements for user-provisioned infrastructure	1940
15.2.3.8.1. Example load balancer configuration for user-provisioned clusters	1941
15.2.4. Preparing the user-provisioned infrastructure	1943
15.2.5. Validating DNS resolution for user-provisioned infrastructure	1944
15.2.6. Generating a key pair for cluster node SSH access	1947
15.2.7. Obtaining the installation program	1949
15.2.8. Installing the OpenShift CLI by downloading the binary	1949
Installing the OpenShift CLI on Linux	1950

Installing the OpenShift CLI on Windows	1950
Installing the OpenShift CLI on macOS	1951
15.2.9. Manually creating the installation configuration file	1951
15.2.9.1. Installation configuration parameters	1952
15.2.9.1.1. Required configuration parameters	1952
15.2.9.1.2. Network configuration parameters	1954
15.2.9.1.3. Optional configuration parameters	1955
15.2.9.2. Sample install-config.yaml file for IBM Z	1960
15.2.9.3. Configuring the cluster-wide proxy during installation	1963
15.2.9.4. Configuring a three-node cluster	1964
15.2.10. Cluster Network Operator configuration	1965
15.2.10.1. Cluster Network Operator configuration object	1966
defaultNetwork object configuration	1966
Configuration for the OpenShift SDN CNI cluster network provider	1967
Configuration for the OVN-Kubernetes CNI cluster network provider	1968
kubeProxyConfig object configuration	1970
15.2.11. Creating the Kubernetes manifest and Ignition config files	1971
15.2.12. Installing RHCOS and starting the OpenShift Container Platform bootstrap process	1973
15.2.12.1. Advanced RHCOS installation reference	1976
15.2.12.1.1. Networking and bonding options for ISO installations	1976
Configuring DHCP or static IP addresses	1976
Configuring an IP address without a static hostname	1977
Specifying multiple network interfaces	1977
Configuring default gateway and route	1977
Disabling DHCP on a single interface	1978
Combining DHCP and static IP configurations	1978
Configuring VLANs on individual interfaces	1978
Providing multiple DNS servers	1978
Bonding multiple network interfaces to a single interface	1978
Bonding multiple network interfaces to a single interface	1979
Using network teaming	1979
15.2.13. Waiting for the bootstrap process to complete	1979
15.2.14. Logging in to the cluster by using the CLI	1980
15.2.15. Approving the certificate signing requests for your machines	1981
15.2.16. Initial Operator configuration	1983
15.2.16.1. Image registry storage configuration	1984
15.2.16.1.1. Configuring registry storage for IBM Z	1985
15.2.16.1.2. Configuring storage for the image registry in non-production clusters	1986
15.2.17. Completing installation on user-provisioned infrastructure	1987
15.2.18. Telemetry access for OpenShift Container Platform	1989
15.2.19. Next steps	1989
15.3. INSTALLING A CLUSTER WITH Z/VM ON IBM Z AND LINUXONE IN A RESTRICTED NETWORK	1990
15.3.1. Prerequisites	1990
15.3.2. About installations in restricted networks	1990
15.3.2.1. Additional limits	1991
15.3.3. Internet access for OpenShift Container Platform	1991
15.3.4. Requirements for a cluster with user-provisioned infrastructure	1991
15.3.4.1. Required machines for cluster installation	1992
15.3.4.2. Minimum resource requirements for cluster installation	1992
15.3.4.3. Minimum IBM Z system environment	1993
Hardware requirements	1993
Operating system requirements	1993
IBM Z network connectivity requirements	1993

Disk storage for the z/VM guest virtual machines	1993
Storage / Main Memory	1994
15.3.4.4. Preferred IBM Z system environment	1994
Hardware requirements	1994
Operating system requirements	1994
IBM Z network connectivity requirements	1994
Disk storage for the z/VM guest virtual machines	1994
Storage / Main Memory	1995
15.3.4.5. Certificate signing requests management	1995
15.3.4.6. Networking requirements for user-provisioned infrastructure	1995
15.3.4.6.1. Setting the cluster node hostnames through DHCP	1996
15.3.4.6.2. Network connectivity requirements	1996
NTP configuration for user-provisioned infrastructure	1997
15.3.4.7. User-provisioned DNS requirements	1997
15.3.4.7.1. Example DNS configuration for user-provisioned clusters	1999
15.3.4.8. Load balancing requirements for user-provisioned infrastructure	2001
15.3.4.8.1. Example load balancer configuration for user-provisioned clusters	2003
15.3.5. Preparing the user-provisioned infrastructure	2005
15.3.6. Validating DNS resolution for user-provisioned infrastructure	2006
15.3.7. Generating a key pair for cluster node SSH access	2009
15.3.8. Manually creating the installation configuration file	2010
15.3.8.1. Installation configuration parameters	2011
15.3.8.1.1. Required configuration parameters	2011
15.3.8.1.2. Network configuration parameters	2013
15.3.8.1.3. Optional configuration parameters	2015
15.3.8.2. Sample install-config.yaml file for IBM Z	2020
15.3.8.3. Configuring the cluster-wide proxy during installation	2023
15.3.8.4. Configuring a three-node cluster	2025
15.3.9. Cluster Network Operator configuration	2026
15.3.9.1. Cluster Network Operator configuration object	2026
defaultNetwork object configuration	2027
Configuration for the OpenShift SDN CNI cluster network provider	2027
Configuration for the OVN-Kubernetes CNI cluster network provider	2029
kubeProxyConfig object configuration	2031
15.3.10. Creating the Kubernetes manifest and Ignition config files	2031
15.3.11. Installing RHCOS and starting the OpenShift Container Platform bootstrap process	2033
15.3.11.1. Advanced RHCOS installation reference	2036
15.3.11.1.1. Networking and bonding options for ISO installations	2036
Configuring DHCP or static IP addresses	2037
Configuring an IP address without a static hostname	2037
Specifying multiple network interfaces	2038
Configuring default gateway and route	2038
Disabling DHCP on a single interface	2038
Combining DHCP and static IP configurations	2038
Configuring VLANs on individual interfaces	2038
Providing multiple DNS servers	2039
Bonding multiple network interfaces to a single interface	2039
Bonding multiple network interfaces to a single interface	2039
Using network teaming	2040
15.3.12. Waiting for the bootstrap process to complete	2040
15.3.13. Logging in to the cluster by using the CLI	2041
15.3.14. Approving the certificate signing requests for your machines	2041
15.3.15. Initial Operator configuration	2044



15.3.15.1. Disabling the default OperatorHub sources	2045
15.3.15.2. Image registry storage configuration	2045
15.3.15.2.1. Configuring registry storage for IBM Z	2046
15.3.15.2.2. Configuring storage for the image registry in non-production clusters	2047
15.3.16. Completing installation on user-provisioned infrastructure	2048
15.3.17. Next steps	2050
<b>CHAPTER 16. INSTALLING WITH RHEL KVM ON IBM Z AND LINUXONE</b>	<b>2051</b>
16.1. PREPARING TO INSTALL WITH RHEL KVM ON IBM Z AND LINUXONE	2051
16.1.1. Prerequisites	2051
16.1.2. Choosing a method to install OpenShift Container Platform with RHEL KVM on IBM Z or LinuxONE	2051
16.2. INSTALLING A CLUSTER WITH RHEL KVM ON IBM Z AND LINUXONE	2051
16.2.1. Prerequisites	2051
16.2.2. Internet access for OpenShift Container Platform	2052
16.2.3. Machine requirements for a cluster with user-provisioned infrastructure	2052
16.2.3.1. Required machines	2052
16.2.3.2. Network connectivity requirements	2053
16.2.3.3. IBM Z network connectivity requirements	2053
16.2.3.4. Host machine resource requirements	2053
16.2.3.5. Minimum IBM Z system environment	2054
Hardware requirements	2054
Operating system requirements	2054
16.2.3.6. Minimum resource requirements	2054
16.2.3.7. Preferred IBM Z system environment	2055
Hardware requirements	2055
Operating system requirements	2055
16.2.3.8. Preferred resource requirements	2055
16.2.3.9. Certificate signing requests management	2055
16.2.3.10. Networking requirements for user-provisioned infrastructure	2056
16.2.3.10.1. Setting the cluster node hostnames through DHCP	2056
16.2.3.10.2. Network connectivity requirements	2056
NTP configuration for user-provisioned infrastructure	2058
16.2.3.11. User-provisioned DNS requirements	2058
16.2.3.11.1. Example DNS configuration for user-provisioned clusters	2060
16.2.3.12. Load balancing requirements for user-provisioned infrastructure	2062
16.2.3.12.1. Example load balancer configuration for user-provisioned clusters	2064
16.2.4. Preparing the user-provisioned infrastructure	2066
16.2.5. Validating DNS resolution for user-provisioned infrastructure	2068
16.2.6. Generating a key pair for cluster node SSH access	2070
16.2.7. Obtaining the installation program	2072
16.2.8. Installing the OpenShift CLI by downloading the binary	2072
Installing the OpenShift CLI on Linux	2073
Installing the OpenShift CLI on Windows	2073
Installing the OpenShift CLI on macOS	2074
16.2.9. Manually creating the installation configuration file	2074
16.2.9.1. Installation configuration parameters	2075
16.2.9.1.1. Required configuration parameters	2075
16.2.9.1.2. Network configuration parameters	2077
16.2.9.1.3. Optional configuration parameters	2078
16.2.9.2. Sample install-config.yaml file for IBM Z	2083
16.2.9.3. Configuring the cluster-wide proxy during installation	2086
16.2.9.4. Configuring a three-node cluster	2087

16.2.10. Cluster Network Operator configuration	2088
16.2.10.1. Cluster Network Operator configuration object	2089
defaultNetwork object configuration	2089
Configuration for the OpenShift SDN CNI cluster network provider	2090
Configuration for the OVN-Kubernetes CNI cluster network provider	2091
kubeProxyConfig object configuration	2093
16.2.11. Creating the Kubernetes manifest and Ignition config files	2094
16.2.12. Installing RHCOS and starting the OpenShift Container Platform bootstrap process	2096
16.2.12.1. Fast-track installation by using a prepackaged QCOW2 disk image	2096
16.2.12.2. Full installation on a new QCOW2 disk image	2097
16.2.12.3. Advanced RHCOS installation reference	2098
16.2.12.3.1. Networking options for ISO installations	2099
Configuring DHCP or static IP addresses	2099
Configuring an IP address without a static hostname	2099
Specifying multiple network interfaces	2100
Configuring default gateway and route	2100
Disabling DHCP on a single interface	2100
Combining DHCP and static IP configurations	2100
Configuring VLANs on individual interfaces	2101
Providing multiple DNS servers	2101
16.2.13. Waiting for the bootstrap process to complete	2101
16.2.14. Logging in to the cluster by using the CLI	2102
16.2.15. Approving the certificate signing requests for your machines	2102
16.2.16. Initial Operator configuration	2105
16.2.16.1. Image registry storage configuration	2106
16.2.16.1.1. Configuring registry storage for IBM Z	2106
16.2.16.1.2. Configuring storage for the image registry in non-production clusters	2108
16.2.17. Completing installation on user-provisioned infrastructure	2108
16.2.18. Telemetry access for OpenShift Container Platform	2111
16.2.19. Next steps	2111
16.3. INSTALLING A CLUSTER WITH RHEL KVM ON IBM Z AND LINUXONE IN A RESTRICTED NETWORK	2111
16.3.1. Prerequisites	2111
16.3.2. About installations in restricted networks	2112
16.3.2.1. Additional limits	2112
16.3.3. Internet access for OpenShift Container Platform	2113
16.3.4. Machine requirements for a cluster with user-provisioned infrastructure	2113
16.3.4.1. Required machines	2113
16.3.4.2. Network connectivity requirements	2114
16.3.4.3. IBM Z network connectivity requirements	2114
16.3.4.4. Host machine resource requirements	2114
16.3.4.5. Minimum IBM Z system environment	2114
Hardware requirements	2114
Operating system requirements	2115
16.3.4.6. Minimum resource requirements	2115
16.3.4.7. Preferred IBM Z system environment	2115
Hardware requirements	2115
Operating system requirements	2116
16.3.4.8. Preferred resource requirements	2116
16.3.4.9. Certificate signing requests management	2116
16.3.4.10. Networking requirements for user-provisioned infrastructure	2116
16.3.4.10.1. Setting the cluster node hostnames through DHCP	2117
16.3.4.10.2. Network connectivity requirements	2117
NTP configuration for user-provisioned infrastructure	2118

16.3.4.11. User-provisioned DNS requirements	2119
16.3.4.11.1. Example DNS configuration for user-provisioned clusters	2120
16.3.4.12. Load balancing requirements for user-provisioned infrastructure	2123
16.3.4.12.1. Example load balancer configuration for user-provisioned clusters	2124
16.3.5. Preparing the user-provisioned infrastructure	2126
16.3.6. Validating DNS resolution for user-provisioned infrastructure	2128
16.3.7. Generating a key pair for cluster node SSH access	2130
16.3.8. Manually creating the installation configuration file	2132
16.3.8.1. Installation configuration parameters	2133
16.3.8.1.1. Required configuration parameters	2133
16.3.8.1.2. Network configuration parameters	2135
16.3.8.1.3. Optional configuration parameters	2136
16.3.8.2. Sample install-config.yaml file for IBM Z	2141
16.3.8.3. Configuring the cluster-wide proxy during installation	2144
16.3.8.4. Configuring a three-node cluster	2146
16.3.9. Cluster Network Operator configuration	2147
16.3.9.1. Cluster Network Operator configuration object	2147
defaultNetwork object configuration	2148
Configuration for the OpenShift SDN CNI cluster network provider	2148
Configuration for the OVN-Kubernetes CNI cluster network provider	2150
kubeProxyConfig object configuration	2152
16.3.10. Creating the Kubernetes manifest and Ignition config files	2152
16.3.11. Installing RHCOS and starting the OpenShift Container Platform bootstrap process	2154
16.3.11.1. Fast-track installation by using a prepackaged QCOW2 disk image	2154
16.3.11.2. Full installation on a new QCOW2 disk image	2155
16.3.11.3. Advanced RHCOS installation reference	2157
16.3.11.3.1. Networking options for ISO installations	2157
Configuring DHCP or static IP addresses	2157
Configuring an IP address without a static hostname	2158
Specifying multiple network interfaces	2158
Configuring default gateway and route	2158
Disabling DHCP on a single interface	2159
Combining DHCP and static IP configurations	2159
Configuring VLANs on individual interfaces	2159
Providing multiple DNS servers	2159
16.3.12. Waiting for the bootstrap process to complete	2159
16.3.13. Logging in to the cluster by using the CLI	2160
16.3.14. Approving the certificate signing requests for your machines	2161
16.3.15. Initial Operator configuration	2163
16.3.15.1. Disabling the default OperatorHub sources	2164
16.3.15.2. Image registry storage configuration	2165
16.3.15.2.1. Configuring registry storage for IBM Z	2165
16.3.15.2.2. Configuring storage for the image registry in non-production clusters	2167
16.3.16. Completing installation on user-provisioned infrastructure	2167
16.3.17. Next steps	2170
<b>CHAPTER 17. INSTALLING ON IBM POWER</b> .....	<b>2171</b>
17.1. PREPARING TO INSTALL ON IBM POWER	2171
17.1.1. Prerequisites	2171
17.1.2. Choosing a method to install OpenShift Container Platform on IBM Power	2171
17.2. INSTALLING A CLUSTER ON IBM POWER	2171
17.2.1. Prerequisites	2171
17.2.2. Internet access for OpenShift Container Platform	2172

17.2.3. Requirements for a cluster with user-provisioned infrastructure	2172
17.2.3.1. Required machines for cluster installation	2172
17.2.3.2. Minimum resource requirements for cluster installation	2173
17.2.3.3. Minimum IBM Power requirements	2173
Hardware requirements	2173
Operating system requirements	2174
Disk storage for the IBM Power guest virtual machines	2174
Network for the PowerVM guest virtual machines	2174
Storage / main memory	2174
17.2.3.4. Recommended IBM Power system requirements	2174
Hardware requirements	2174
Operating system requirements	2174
Disk storage for the IBM Power guest virtual machines	2174
Network for the PowerVM guest virtual machines	2174
Storage / main memory	2175
17.2.3.5. Certificate signing requests management	2175
17.2.3.6. Networking requirements for user-provisioned infrastructure	2175
17.2.3.6.1. Setting the cluster node hostnames through DHCP	2175
17.2.3.6.2. Network connectivity requirements	2176
NTP configuration for user-provisioned infrastructure	2177
17.2.3.7. User-provisioned DNS requirements	2177
17.2.3.7.1. Example DNS configuration for user-provisioned clusters	2179
17.2.3.8. Load balancing requirements for user-provisioned infrastructure	2181
17.2.3.8.1. Example load balancer configuration for user-provisioned clusters	2183
17.2.4. Preparing the user-provisioned infrastructure	2185
17.2.5. Validating DNS resolution for user-provisioned infrastructure	2187
17.2.6. Generating a key pair for cluster node SSH access	2189
17.2.7. Obtaining the installation program	2191
17.2.8. Installing the OpenShift CLI by downloading the binary	2192
Installing the OpenShift CLI on Linux	2192
Installing the OpenShift CLI on Windows	2192
Installing the OpenShift CLI on macOS	2193
17.2.9. Manually creating the installation configuration file	2193
17.2.9.1. Installation configuration parameters	2194
17.2.9.1.1. Required configuration parameters	2194
17.2.9.1.2. Network configuration parameters	2196
17.2.9.1.3. Optional configuration parameters	2198
17.2.9.2. Sample install-config.yaml file for IBM Power	2203
17.2.9.3. Configuring the cluster-wide proxy during installation	2206
17.2.9.4. Configuring a three-node cluster	2207
17.2.10. Cluster Network Operator configuration	2208
17.2.10.1. Cluster Network Operator configuration object	2209
defaultNetwork object configuration	2209
Configuration for the OpenShift SDN CNI cluster network provider	2210
Configuration for the OVN-Kubernetes CNI cluster network provider	2211
kubeProxyConfig object configuration	2213
17.2.11. Creating the Kubernetes manifest and Ignition config files	2214
17.2.12. Installing RHCOS and starting the OpenShift Container Platform bootstrap process	2216
17.2.12.1. Installing RHCOS by using an ISO image	2216
17.2.12.1.1. Advanced RHCOS installation reference	2219
17.2.12.1.1.1. Networking and bonding options for ISO installations	2219
Configuring DHCP or static IP addresses	2220
Configuring an IP address without a static hostname	2220

Specifying multiple network interfaces	2221
Configuring default gateway and route	2221
Disabling DHCP on a single interface	2221
Combining DHCP and static IP configurations	2221
Configuring VLANs on individual interfaces	2221
Providing multiple DNS servers	2222
Bonding multiple network interfaces to a single interface	2222
Bonding multiple network interfaces to a single interface	2222
Using network teaming	2223
17.2.12.2. Installing RHCOS by using PXE booting	2223
17.2.12.3. Enabling multipathing with kernel arguments on RHCOS	2226
17.2.13. Waiting for the bootstrap process to complete	2228
17.2.14. Logging in to the cluster by using the CLI	2229
17.2.15. Approving the certificate signing requests for your machines	2229
17.2.16. Initial Operator configuration	2232
17.2.16.1. Image registry storage configuration	2233
17.2.16.1.1. Configuring registry storage for IBM Power	2233
17.2.16.1.2. Configuring storage for the image registry in non-production clusters	2235
17.2.17. Completing installation on user-provisioned infrastructure	2235
17.2.18. Telemetry access for OpenShift Container Platform	2238
17.2.19. Next steps	2238
17.3. INSTALLING A CLUSTER ON IBM POWER IN A RESTRICTED NETWORK	2238
17.3.1. Prerequisites	2238
17.3.2. About installations in restricted networks	2239
17.3.2.1. Additional limits	2239
17.3.3. Internet access for OpenShift Container Platform	2239
17.3.4. Requirements for a cluster with user-provisioned infrastructure	2240
17.3.4.1. Required machines for cluster installation	2240
17.3.4.2. Minimum resource requirements for cluster installation	2241
17.3.4.3. Minimum IBM Power requirements	2241
Hardware requirements	2241
Operating system requirements	2241
Disk storage for the IBM Power guest virtual machines	2241
Network for the PowerVM guest virtual machines	2242
Storage / main memory	2242
17.3.4.4. Recommended IBM Power system requirements	2242
Hardware requirements	2242
Operating system requirements	2242
Disk storage for the IBM Power guest virtual machines	2242
Network for the PowerVM guest virtual machines	2242
Storage / main memory	2242
17.3.4.5. Certificate signing requests management	2242
17.3.4.6. Networking requirements for user-provisioned infrastructure	2243
17.3.4.6.1. Setting the cluster node hostnames through DHCP	2243
17.3.4.6.2. Network connectivity requirements	2243
NTP configuration for user-provisioned infrastructure	2244
17.3.4.7. User-provisioned DNS requirements	2245
17.3.4.7.1. Example DNS configuration for user-provisioned clusters	2247
17.3.4.8. Load balancing requirements for user-provisioned infrastructure	2249
17.3.4.8.1. Example load balancer configuration for user-provisioned clusters	2251
17.3.5. Preparing the user-provisioned infrastructure	2253
17.3.6. Validating DNS resolution for user-provisioned infrastructure	2254
17.3.7. Generating a key pair for cluster node SSH access	2257

17.3.8. Manually creating the installation configuration file	2258
17.3.8.1. Installation configuration parameters	2259
17.3.8.1.1. Required configuration parameters	2260
17.3.8.1.2. Network configuration parameters	2261
17.3.8.1.3. Optional configuration parameters	2263
17.3.8.2. Sample install-config.yaml file for IBM Power	2268
17.3.8.3. Configuring the cluster-wide proxy during installation	2271
17.3.8.4. Configuring a three-node cluster	2273
17.3.9. Cluster Network Operator configuration	2274
17.3.9.1. Cluster Network Operator configuration object	2274
defaultNetwork object configuration	2275
Configuration for the OpenShift SDN CNI cluster network provider	2275
Configuration for the OVN-Kubernetes CNI cluster network provider	2276
kubeProxyConfig object configuration	2278
17.3.10. Creating the Kubernetes manifest and Ignition config files	2279
17.3.11. Installing RHCOS and starting the OpenShift Container Platform bootstrap process	2281
17.3.11.1. Installing RHCOS by using an ISO image	2281
17.3.11.1.1. Advanced RHCOS installation reference	2284
17.3.11.1.1.1. Networking and bonding options for ISO installations	2284
Configuring DHCP or static IP addresses	2285
Configuring an IP address without a static hostname	2285
Specifying multiple network interfaces	2286
Configuring default gateway and route	2286
Disabling DHCP on a single interface	2286
Combining DHCP and static IP configurations	2286
Configuring VLANs on individual interfaces	2286
Providing multiple DNS servers	2287
Bonding multiple network interfaces to a single interface	2287
Bonding multiple network interfaces to a single interface	2287
Using network teaming	2288
17.3.11.2. Installing RHCOS by using PXE booting	2288
17.3.11.3. Enabling multipathing with kernel arguments on RHCOS	2291
17.3.12. Waiting for the bootstrap process to complete	2293
17.3.13. Logging in to the cluster by using the CLI	2294
17.3.14. Approving the certificate signing requests for your machines	2294
17.3.15. Initial Operator configuration	2297
17.3.15.1. Disabling the default OperatorHub sources	2298
17.3.15.2. Image registry storage configuration	2298
17.3.15.2.1. Changing the image registry's management state	2299
17.3.15.2.2. Configuring registry storage for IBM Power	2299
17.3.15.2.3. Configuring storage for the image registry in non-production clusters	2300
17.3.16. Completing installation on user-provisioned infrastructure	2301
17.3.17. Next steps	2304
<b>CHAPTER 18. INSTALLING ON OPENSTACK</b> .....	<b>2305</b>
18.1. PREPARING TO INSTALL ON OPENSTACK	2305
18.1.1. Prerequisites	2305
18.1.2. Choosing a method to install OpenShift Container Platform on OpenStack	2305
18.1.2.1. Installing a cluster on installer-provisioned infrastructure	2305
18.1.2.2. Installing a cluster on user-provisioned infrastructure	2305
18.1.3. Scanning RHOSP endpoints for legacy HTTPS certificates	2306
18.1.3.1. Scanning RHOSP endpoints for legacy HTTPS certificates manually	2308
18.2. INSTALLING A CLUSTER ON OPENSTACK WITH CUSTOMIZATIONS	2309

18.2.1. Prerequisites	2309
18.2.2. Resource guidelines for installing OpenShift Container Platform on RHOSP	2310
18.2.2.1. Control plane machines	2311
18.2.2.2. Compute machines	2311
18.2.2.3. Bootstrap machine	2311
18.2.3. Internet access for OpenShift Container Platform	2312
18.2.4. Enabling Swift on RHOSP	2312
18.2.5. Configuring an image registry with custom storage on clusters that run on RHOSP	2313
18.2.6. Verifying external network access	2315
18.2.7. Defining parameters for the installation program	2316
18.2.8. Setting cloud provider options	2317
18.2.8.1. External load balancers that use pre-defined floating IP addresses	2319
18.2.9. Obtaining the installation program	2319
18.2.10. Creating the installation configuration file	2320
18.2.10.1. Configuring the cluster-wide proxy during installation	2321
18.2.11. Installation configuration parameters	2323
18.2.11.1. Required configuration parameters	2323
18.2.11.2. Network configuration parameters	2325
18.2.11.3. Optional configuration parameters	2326
18.2.11.4. Additional Red Hat OpenStack Platform (RHOSP) configuration parameters	2331
18.2.11.5. Optional RHOSP configuration parameters	2332
18.2.11.6. Custom subnets in RHOSP deployments	2337
18.2.11.7. Deploying a cluster with bare metal machines	2338
18.2.11.8. Cluster deployment on RHOSP provider networks	2340
18.2.11.8.1. RHOSP provider network requirements for cluster installation	2341
18.2.11.8.2. Deploying a cluster that has a primary interface on a provider network	2342
18.2.11.9. Sample customized install-config.yaml file for RHOSP	2343
18.2.12. Generating a key pair for cluster node SSH access	2344
18.2.13. Enabling access to the environment	2346
18.2.13.1. Enabling access with floating IP addresses	2346
18.2.13.2. Completing installation without floating IP addresses	2347
18.2.14. Deploying the cluster	2348
18.2.15. Verifying cluster status	2349
18.2.16. Logging in to the cluster by using the CLI	2350
18.2.17. Telemetry access for OpenShift Container Platform	2351
18.2.18. Next steps	2351
18.3. INSTALLING A CLUSTER ON OPENSTACK WITH KURYR	2351
18.3.1. Prerequisites	2351
18.3.2. About Kuryr SDN	2352
18.3.3. Resource guidelines for installing OpenShift Container Platform on RHOSP with Kuryr	2352
18.3.3.1. Increasing quota	2354
18.3.3.2. Configuring Neutron	2354
18.3.3.3. Configuring Octavia	2355
18.3.3.3.1. The Octavia OVN Driver	2358
18.3.3.4. Known limitations of installing with Kuryr	2359
RHOSP general limitations	2359
RHOSP version limitations	2359
RHOSP environment limitations	2359
RHOSP upgrade limitations	2360
18.3.3.5. Control plane machines	2360
18.3.3.6. Compute machines	2360
18.3.3.7. Bootstrap machine	2361
18.3.4. Internet access for OpenShift Container Platform	2361

18.3.5. Enabling Swift on RHOSP	2362
18.3.6. Verifying external network access	2362
18.3.7. Defining parameters for the installation program	2363
18.3.8. Setting cloud provider options	2365
18.3.8.1. External load balancers that use pre-defined floating IP addresses	2366
18.3.9. Obtaining the installation program	2367
18.3.10. Creating the installation configuration file	2367
18.3.10.1. Configuring the cluster-wide proxy during installation	2369
18.3.11. Installation configuration parameters	2370
18.3.11.1. Required configuration parameters	2371
18.3.11.2. Network configuration parameters	2372
18.3.11.3. Optional configuration parameters	2374
18.3.11.4. Additional Red Hat OpenStack Platform (RHOSP) configuration parameters	2379
18.3.11.5. Optional RHOSP configuration parameters	2380
18.3.11.6. Custom subnets in RHOSP deployments	2385
18.3.11.7. Sample customized install-config.yaml file for RHOSP with Kuryr	2386
18.3.11.8. Cluster deployment on RHOSP provider networks	2387
18.3.11.8.1. RHOSP provider network requirements for cluster installation	2388
18.3.11.8.2. Deploying a cluster that has a primary interface on a provider network	2389
18.3.11.9. Kuryr ports pools	2391
18.3.11.10. Adjusting Kuryr ports pools during installation	2391
18.3.12. Generating a key pair for cluster node SSH access	2393
18.3.13. Enabling access to the environment	2395
18.3.13.1. Enabling access with floating IP addresses	2395
18.3.13.2. Completing installation without floating IP addresses	2396
18.3.14. Deploying the cluster	2397
18.3.15. Verifying cluster status	2398
18.3.16. Logging in to the cluster by using the CLI	2399
18.3.17. Telemetry access for OpenShift Container Platform	2400
18.3.18. Next steps	2400
18.4. INSTALLING A CLUSTER ON OPENSTACK THAT SUPPORTS SR-IOV-CONNECTED COMPUTE MACHINES	2400
18.4.1. Prerequisites	2400
18.4.2. Resource guidelines for installing OpenShift Container Platform on RHOSP	2400
18.4.2.1. Control plane machines	2402
18.4.2.2. Compute machines	2402
18.4.2.3. Bootstrap machine	2402
18.4.3. Internet access for OpenShift Container Platform	2403
18.4.4. Enabling Swift on RHOSP	2403
18.4.5. Verifying external network access	2404
18.4.6. Defining parameters for the installation program	2404
18.4.7. Obtaining the installation program	2406
18.4.8. Creating the installation configuration file	2406
18.4.8.1. Configuring the cluster-wide proxy during installation	2407
18.4.9. Installation configuration parameters	2409
18.4.9.1. Required configuration parameters	2409
18.4.9.2. Network configuration parameters	2411
18.4.9.3. Optional configuration parameters	2412
18.4.9.4. Custom subnets in RHOSP deployments	2417
18.4.9.5. Deploying a cluster with bare metal machines	2418
18.4.9.6. Sample customized install-config.yaml file for RHOSP	2420
18.4.10. Generating a key pair for cluster node SSH access	2420
18.4.11. Enabling access to the environment	2422



---

18.4.11.1. Enabling access with floating IP addresses	2422
18.4.11.2. Completing installation without floating IP addresses	2424
18.4.12. Creating SR-IOV networks for compute machines	2424
18.4.13. Deploying the cluster	2425
18.4.14. Verifying cluster status	2426
18.4.15. Logging in to the cluster by using the CLI	2427
18.4.16. Preparing a cluster that runs on RHOSP for SR-IOV	2428
18.4.16.1. Enabling the RHOSP metadata service as a mountable drive	2428
18.4.16.2. Enabling the No-IOMMU feature for the RHOSP VFIO driver	2429
18.4.17. Telemetry access for OpenShift Container Platform	2430
18.4.18. Next steps	2430
18.5. INSTALLING A CLUSTER ON OPENSTACK THAT SUPPORTS OVS-DPDK-CONNECTED COMPUTE MACHINES	2430
18.5.1. Prerequisites	2430
18.5.2. Resource guidelines for installing OpenShift Container Platform on RHOSP	2431
18.5.2.1. Control plane machines	2432
18.5.2.2. Compute machines	2432
18.5.2.3. Bootstrap machine	2433
18.5.3. Internet access for OpenShift Container Platform	2433
18.5.4. Enabling Swift on RHOSP	2433
18.5.5. Verifying external network access	2434
18.5.6. Defining parameters for the installation program	2435
18.5.7. Obtaining the installation program	2436
18.5.8. Creating the installation configuration file	2437
18.5.8.1. Configuring the cluster-wide proxy during installation	2438
18.5.9. Installation configuration parameters	2439
18.5.9.1. Required configuration parameters	2440
18.5.9.2. Network configuration parameters	2441
18.5.9.3. Optional configuration parameters	2443
18.5.9.4. Custom subnets in RHOSP deployments	2448
18.5.9.5. Deploying a cluster with bare metal machines	2449
18.5.9.6. Sample customized install-config.yaml file for RHOSP	2450
18.5.10. Generating a key pair for cluster node SSH access	2451
18.5.11. Enabling access to the environment	2453
18.5.11.1. Enabling access with floating IP addresses	2453
18.5.11.2. Completing installation without floating IP addresses	2454
18.5.12. Creating SR-IOV networks for compute machines	2455
18.5.13. Deploying the cluster	2456
18.5.14. Verifying cluster status	2457
18.5.15. Logging in to the cluster by using the CLI	2458
18.5.16. Enabling the RHOSP metadata service as a mountable drive	2458
18.5.17. Enabling the No-IOMMU feature for the RHOSP VFIO driver	2459
18.5.18. Binding the vfio-pci kernel driver to NICs	2460
18.5.19. Exposing the host-device interface to the pod	2463
18.5.20. Telemetry access for OpenShift Container Platform	2464
18.5.21. Additional resources	2464
18.5.22. Next steps	2464
18.6. INSTALLING A CLUSTER ON OPENSTACK ON YOUR OWN INFRASTRUCTURE	2465
18.6.1. Prerequisites	2465
18.6.2. Internet access for OpenShift Container Platform	2465
18.6.3. Resource guidelines for installing OpenShift Container Platform on RHOSP	2466
18.6.3.1. Control plane machines	2467
18.6.3.2. Compute machines	2467

---

18.6.3.3. Bootstrap machine	2467
18.6.4. Downloading playbook dependencies	2468
18.6.5. Downloading the installation playbooks	2468
18.6.6. Obtaining the installation program	2470
18.6.7. Generating a key pair for cluster node SSH access	2470
18.6.8. Creating the Red Hat Enterprise Linux CoreOS (RHCOS) image	2472
18.6.9. Verifying external network access	2473
18.6.10. Enabling access to the environment	2474
18.6.10.1. Enabling access with floating IP addresses	2474
18.6.10.2. Completing installation without floating IP addresses	2475
18.6.11. Defining parameters for the installation program	2476
18.6.12. Creating the installation configuration file	2477
18.6.13. Installation configuration parameters	2479
18.6.13.1. Required configuration parameters	2479
18.6.13.2. Network configuration parameters	2480
18.6.13.3. Optional configuration parameters	2482
18.6.13.4. Additional Red Hat OpenStack Platform (RHOSP) configuration parameters	2487
18.6.13.5. Optional RHOSP configuration parameters	2488
18.6.13.6. Custom subnets in RHOSP deployments	2493
18.6.13.7. Sample customized install-config.yaml file for RHOSP	2494
18.6.13.8. Setting a custom subnet for machines	2495
18.6.13.9. Emptying compute machine pools	2495
18.6.13.10. Cluster deployment on RHOSP provider networks	2496
18.6.13.10.1. RHOSP provider network requirements for cluster installation	2497
18.6.13.10.2. Deploying a cluster that has a primary interface on a provider network	2498
18.6.14. Creating the Kubernetes manifest and Ignition config files	2500
18.6.15. Preparing the bootstrap Ignition files	2501
18.6.16. Creating control plane Ignition config files on RHOSP	2504
18.6.17. Creating network resources on RHOSP	2505
18.6.17.1. Deploying a cluster with bare metal machines	2506
18.6.18. Creating the bootstrap machine on RHOSP	2508
18.6.19. Creating the control plane machines on RHOSP	2508
18.6.20. Logging in to the cluster by using the CLI	2509
18.6.21. Deleting bootstrap resources from RHOSP	2510
18.6.22. Creating compute machines on RHOSP	2510
18.6.23. Approving the certificate signing requests for your machines	2511
18.6.24. Verifying a successful installation	2514
18.6.25. Telemetry access for OpenShift Container Platform	2514
18.6.26. Next steps	2514
18.7. INSTALLING A CLUSTER ON OPENSTACK WITH KURYR ON YOUR OWN INFRASTRUCTURE	2514
18.7.1. Prerequisites	2515
18.7.2. About Kuryr SDN	2515
18.7.3. Resource guidelines for installing OpenShift Container Platform on RHOSP with Kuryr	2516
18.7.3.1. Increasing quota	2518
18.7.3.2. Configuring Neutron	2518
18.7.3.3. Configuring Octavia	2518
18.7.3.3.1. The Octavia OVN Driver	2521
18.7.3.4. Known limitations of installing with Kuryr	2522
RHOSP general limitations	2522
RHOSP version limitations	2523
RHOSP environment limitations	2523
RHOSP upgrade limitations	2523
18.7.3.5. Control plane machines	2524

18.7.3.6. Compute machines	2524
18.7.3.7. Bootstrap machine	2524
18.7.4. Internet access for OpenShift Container Platform	2525
18.7.5. Downloading playbook dependencies	2525
18.7.6. Downloading the installation playbooks	2526
18.7.7. Obtaining the installation program	2527
18.7.8. Generating a key pair for cluster node SSH access	2528
18.7.9. Creating the Red Hat Enterprise Linux CoreOS (RHCOS) image	2530
18.7.10. Verifying external network access	2531
18.7.11. Enabling access to the environment	2531
18.7.11.1. Enabling access with floating IP addresses	2532
18.7.11.2. Completing installation without floating IP addresses	2533
18.7.12. Defining parameters for the installation program	2534
18.7.13. Creating the installation configuration file	2535
18.7.14. Installation configuration parameters	2537
18.7.14.1. Required configuration parameters	2537
18.7.14.2. Network configuration parameters	2538
18.7.14.3. Optional configuration parameters	2540
18.7.14.4. Additional Red Hat OpenStack Platform (RHOSP) configuration parameters	2545
18.7.14.5. Optional RHOSP configuration parameters	2546
18.7.14.6. Custom subnets in RHOSP deployments	2551
18.7.14.7. Sample customized install-config.yaml file for RHOSP with Kuryr	2552
18.7.14.8. Cluster deployment on RHOSP provider networks	2553
18.7.14.8.1. RHOSP provider network requirements for cluster installation	2554
18.7.14.8.2. Deploying a cluster that has a primary interface on a provider network	2555
18.7.14.9. Kuryr ports pools	2557
18.7.14.10. Adjusting Kuryr ports pools during installation	2557
18.7.14.11. Setting a custom subnet for machines	2559
18.7.14.12. Emptying compute machine pools	2560
18.7.14.13. Modifying the network type	2560
18.7.15. Creating the Kubernetes manifest and Ignition config files	2561
18.7.16. Preparing the bootstrap Ignition files	2562
18.7.17. Creating control plane Ignition config files on RHOSP	2565
18.7.18. Creating network resources on RHOSP	2566
18.7.19. Creating the bootstrap machine on RHOSP	2567
18.7.20. Creating the control plane machines on RHOSP	2568
18.7.21. Logging in to the cluster by using the CLI	2569
18.7.22. Deleting bootstrap resources from RHOSP	2569
18.7.23. Creating compute machines on RHOSP	2570
18.7.24. Approving the certificate signing requests for your machines	2571
18.7.25. Verifying a successful installation	2573
18.7.26. Telemetry access for OpenShift Container Platform	2574
18.7.27. Next steps	2574
18.8. INSTALLING A CLUSTER ON OPENSTACK ON YOUR OWN SR-IOV INFRASTRUCTURE	2574
18.8.1. Prerequisites	2574
18.8.2. Internet access for OpenShift Container Platform	2575
18.8.3. Resource guidelines for installing OpenShift Container Platform on RHOSP	2575
18.8.3.1. Control plane machines	2576
18.8.3.2. Compute machines	2576
18.8.3.3. Bootstrap machine	2577
18.8.4. Downloading playbook dependencies	2577
18.8.5. Downloading the installation playbooks	2578
18.8.6. Obtaining the installation program	2579

18.8.7. Generating a key pair for cluster node SSH access	2580
18.8.8. Creating the Red Hat Enterprise Linux CoreOS (RHCOS) image	2582
18.8.9. Verifying external network access	2583
18.8.10. Enabling access to the environment	2584
18.8.10.1. Enabling access with floating IP addresses	2584
18.8.10.2. Completing installation without floating IP addresses	2585
18.8.11. Defining parameters for the installation program	2586
18.8.12. Creating the installation configuration file	2587
18.8.13. Installation configuration parameters	2589
18.8.13.1. Required configuration parameters	2589
18.8.13.2. Network configuration parameters	2590
18.8.13.3. Optional configuration parameters	2592
18.8.13.4. Additional Red Hat OpenStack Platform (RHOSP) configuration parameters	2597
18.8.13.5. Optional RHOSP configuration parameters	2598
18.8.13.6. Sample customized install-config.yaml file for RHOSP	2603
18.8.13.7. Custom subnets in RHOSP deployments	2604
18.8.13.8. Setting a custom subnet for machines	2605
18.8.13.9. Emptying compute machine pools	2605
18.8.14. Creating the Kubernetes manifest and Ignition config files	2606
18.8.15. Preparing the bootstrap Ignition files	2607
18.8.16. Creating control plane Ignition config files on RHOSP	2610
18.8.17. Creating network resources on RHOSP	2611
18.8.17.1. Deploying a cluster with bare metal machines	2612
18.8.18. Creating the bootstrap machine on RHOSP	2614
18.8.19. Creating the control plane machines on RHOSP	2614
18.8.20. Logging in to the cluster by using the CLI	2615
18.8.21. Deleting bootstrap resources from RHOSP	2616
18.8.22. Creating SR-IOV networks for compute machines	2616
18.8.23. Creating compute machines that run on SR-IOV networks	2617
18.8.24. Approving the certificate signing requests for your machines	2621
18.8.25. Verifying a successful installation	2623
18.8.26. Preparing a cluster that runs on RHOSP for SR-IOV	2624
18.8.26.1. Enabling the RHOSP metadata service as a mountable drive	2624
18.8.26.2. Enabling the No-IOMMU feature for the RHOSP VFIO driver	2625
18.8.27. Telemetry access for OpenShift Container Platform	2626
18.8.28. Additional resources	2626
18.8.29. Next steps	2626
18.9. INSTALLING A CLUSTER ON OPENSTACK IN A RESTRICTED NETWORK	2626
18.9.1. Prerequisites	2627
18.9.2. About installations in restricted networks	2627
18.9.2.1. Additional limits	2627
18.9.3. Resource guidelines for installing OpenShift Container Platform on RHOSP	2627
18.9.3.1. Control plane machines	2629
18.9.3.2. Compute machines	2629
18.9.3.3. Bootstrap machine	2629
18.9.4. Internet access for OpenShift Container Platform	2629
18.9.5. Enabling Swift on RHOSP	2630
18.9.6. Defining parameters for the installation program	2630
18.9.7. Setting cloud provider options	2632
18.9.7.1. External load balancers that use pre-defined floating IP addresses	2634
18.9.8. Creating the RHCOS image for restricted network installations	2634
18.9.9. Creating the installation configuration file	2635
18.9.9.1. Configuring the cluster-wide proxy during installation	2637

18.9.9.2. Installation configuration parameters	2639
18.9.9.2.1. Required configuration parameters	2640
18.9.9.2.2. Network configuration parameters	2641
18.9.9.2.3. Optional configuration parameters	2643
18.9.9.2.4. Additional Red Hat OpenStack Platform (RHOSP) configuration parameters	2647
18.9.9.2.5. Optional RHOSP configuration parameters	2648
18.9.9.3. Sample customized install-config.yaml file for restricted OpenStack installations	2653
18.9.10. Generating a key pair for cluster node SSH access	2654
18.9.11. Enabling access to the environment	2656
18.9.11.1. Enabling access with floating IP addresses	2656
18.9.11.2. Completing installation without floating IP addresses	2657
18.9.12. Deploying the cluster	2658
18.9.13. Verifying cluster status	2659
18.9.14. Logging in to the cluster by using the CLI	2660
18.9.15. Disabling the default OperatorHub sources	2661
18.9.16. Telemetry access for OpenShift Container Platform	2661
18.9.17. Next steps	2661
18.10. OPENSTACK CLOUD CONFIGURATION REFERENCE GUIDE	2662
18.10.1. OpenStack cloud provider options	2662
18.10.1.1. Global options	2662
18.10.1.2. Load balancer options	2663
18.10.1.3. Metadata options	2664
18.11. UNINSTALLING A CLUSTER ON OPENSTACK	2665
18.11.1. Removing a cluster that uses installer-provisioned infrastructure	2665
18.12. UNINSTALLING A CLUSTER ON RHOSP FROM YOUR OWN INFRASTRUCTURE	2666
18.12.1. Downloading playbook dependencies	2666
18.12.2. Removing a cluster from RHOSP that uses your own infrastructure	2667
<b>CHAPTER 19. INSTALLING ON RHV</b>	<b>2668</b>
19.1. PREPARING TO INSTALL ON RED HAT VIRTUALIZATION (RHV)	2668
19.1.1. Prerequisites	2668
19.1.2. Choosing a method to install OpenShift Container Platform on RHV	2668
19.1.2.1. Installing a cluster on installer-provisioned infrastructure	2668
19.1.2.2. Installing a cluster on user-provisioned infrastructure	2668
19.2. INSTALLING A CLUSTER QUICKLY ON RHV	2669
19.2.1. Prerequisites	2669
19.2.2. Internet access for OpenShift Container Platform	2670
19.2.3. Requirements for the RHV environment	2670
19.2.4. Verifying the requirements for the RHV environment	2672
19.2.5. Preparing the network environment on RHV	2674
19.2.6. Installing OpenShift Container Platform on RHV in insecure mode	2674
19.2.7. Generating a key pair for cluster node SSH access	2675
19.2.8. Obtaining the installation program	2677
19.2.9. Deploying the cluster	2678
19.2.10. Installing the OpenShift CLI by downloading the binary	2680
Installing the OpenShift CLI on Linux	2681
Installing the OpenShift CLI on Windows	2681
Installing the OpenShift CLI on macOS	2682
19.2.11. Logging in to the cluster by using the CLI	2682
19.2.12. Verifying cluster status	2683
19.2.13. Accessing the OpenShift Container Platform web console on RHV	2683
19.2.14. Telemetry access for OpenShift Container Platform	2684
19.2.15. Troubleshooting common issues with installing on Red Hat Virtualization (RHV)	2684

19.2.15.1. CPU load increases and nodes go into a Not Ready state	2684
19.2.15.2. Trouble connecting the OpenShift Container Platform cluster API	2685
19.2.16. Post-installation tasks	2685
19.3. INSTALLING A CLUSTER ON RHV WITH CUSTOMIZATIONS	2685
19.3.1. Prerequisites	2686
19.3.2. Internet access for OpenShift Container Platform	2687
19.3.3. Requirements for the RHV environment	2687
19.3.4. Verifying the requirements for the RHV environment	2689
19.3.5. Preparing the network environment on RHV	2691
19.3.6. Installing OpenShift Container Platform on RHV in insecure mode	2691
19.3.7. Generating a key pair for cluster node SSH access	2692
19.3.8. Obtaining the installation program	2694
19.3.9. Creating the installation configuration file	2695
19.3.9.1. Example install-config.yaml files for Red Hat Virtualization (RHV)	2697
Example default install-config.yaml file	2698
Example minimal install-config.yaml file	2698
Example Custom machine pools in an install-config.yaml file	2699
Example non-enforcing affinity group	2699
Example removing all affinity groups for a non-production lab setup	2700
19.3.9.2. Installation configuration parameters	2701
19.3.9.2.1. Required configuration parameters	2701
19.3.9.2.2. Network configuration parameters	2702
19.3.9.2.3. Optional configuration parameters	2704
19.3.9.2.4. Additional Red Hat Virtualization (RHV) configuration parameters	2709
19.3.9.2.5. Additional RHV parameters for machine pools	2711
19.3.10. Deploying the cluster	2715
19.3.11. Installing the OpenShift CLI by downloading the binary	2716
Installing the OpenShift CLI on Linux	2716
Installing the OpenShift CLI on Windows	2717
Installing the OpenShift CLI on macOS	2717
19.3.12. Logging in to the cluster by using the CLI	2718
19.3.13. Verifying cluster status	2718
19.3.14. Accessing the OpenShift Container Platform web console on RHV	2719
19.3.15. Telemetry access for OpenShift Container Platform	2719
19.3.16. Troubleshooting common issues with installing on Red Hat Virtualization (RHV)	2720
19.3.16.1. CPU load increases and nodes go into a Not Ready state	2720
19.3.16.2. Trouble connecting the OpenShift Container Platform cluster API	2720
19.3.17. Post-installation tasks	2721
19.3.18. Next steps	2721
19.4. INSTALLING A CLUSTER ON RHV WITH USER-PROVISIONED INFRASTRUCTURE	2721
19.4.1. Prerequisites	2722
19.4.2. Internet access for OpenShift Container Platform	2722
19.4.3. Requirements for the RHV environment	2723
19.4.4. Verifying the requirements for the RHV environment	2724
19.4.5. Networking requirements for user-provisioned infrastructure	2726
19.4.5.1. Setting the cluster node hostnames through DHCP	2727
19.4.5.2. Network connectivity requirements	2727
NTP configuration for user-provisioned infrastructure	2729
19.4.6. Setting up the installation machine	2729
19.4.7. Installing OpenShift Container Platform on RHV in insecure mode	2729
19.4.8. Generating a key pair for cluster node SSH access	2730
19.4.9. Obtaining the installation program	2732
19.4.10. Downloading the Ansible playbooks	2733

---

19.4.11. The inventory.yml file	2733
19.4.12. Specifying the RHCOS image settings	2737
19.4.13. Creating the install config file	2738
19.4.14. Customizing install-config.yaml	2739
19.4.15. Generate manifest files	2740
19.4.16. Making control-plane nodes non-schedulable	2741
19.4.17. Building the Ignition files	2742
19.4.18. Creating templates and virtual machines	2742
19.4.19. Creating the bootstrap machine	2743
19.4.20. Creating the control plane nodes	2744
19.4.21. Verifying cluster status	2744
19.4.22. Removing the bootstrap machine	2745
19.4.23. Creating the worker nodes and completing the installation	2745
19.4.24. Telemetry access for OpenShift Container Platform	2747
19.5. INSTALLING A CLUSTER ON RHV IN A RESTRICTED NETWORK	2747
19.5.1. Prerequisites	2747
19.5.2. About installations in restricted networks	2748
19.5.2.1. Additional limits	2748
19.5.3. Internet access for OpenShift Container Platform	2748
19.5.4. Requirements for the RHV environment	2749
19.5.5. Verifying the requirements for the RHV environment	2750
19.5.6. Networking requirements for user-provisioned infrastructure	2752
19.5.6.1. Setting the cluster node hostnames through DHCP	2753
19.5.6.2. Network connectivity requirements	2753
NTP configuration for user-provisioned infrastructure	2755
19.5.7. User-provisioned DNS requirements	2755
19.5.7.1. Example DNS configuration for user-provisioned clusters	2757
19.5.7.2. Load balancing requirements for user-provisioned infrastructure	2759
19.5.7.2.1. Example load balancer configuration for user-provisioned clusters	2761
19.5.8. Setting up the installation machine	2763
19.5.9. Setting up the CA certificate for RHV	2763
19.5.10. Generating a key pair for cluster node SSH access	2764
19.5.11. Downloading the Ansible playbooks	2766
19.5.12. The inventory.yml file	2766
19.5.13. Specifying the RHCOS image settings	2770
19.5.14. Creating the install config file	2771
19.5.15. Sample install-config.yaml file for RHV	2772
19.5.15.1. Configuring the cluster-wide proxy during installation	2775
19.5.16. Customizing install-config.yaml	2776
19.5.17. Generate manifest files	2777
19.5.18. Making control-plane nodes non-schedulable	2779
19.5.19. Building the Ignition files	2779
19.5.20. Creating templates and virtual machines	2780
19.5.21. Creating the bootstrap machine	2781
19.5.22. Creating the control plane nodes	2781
19.5.23. Verifying cluster status	2782
19.5.24. Removing the bootstrap machine	2782
19.5.25. Creating the worker nodes and completing the installation	2783
19.5.26. Telemetry access for OpenShift Container Platform	2784
19.5.27. Disabling the default OperatorHub sources	2785
19.6. UNINSTALLING A CLUSTER ON RHV	2785
19.6.1. Removing a cluster that uses installer-provisioned infrastructure	2785
19.6.2. Removing a cluster that uses user-provisioned infrastructure	2786

---

<b>CHAPTER 20. INSTALLING ON VSPHERE</b> .....	<b>2787</b>
20.1. PREPARING TO INSTALL ON VSPHERE	2787
20.1.1. Prerequisites	2787
20.1.2. Choosing a method to install OpenShift Container Platform on vSphere	2787
20.1.2.1. Installer-provisioned infrastructure installation of OpenShift Container Platform on vSphere	2787
20.1.2.2. User-provisioned infrastructure installation of OpenShift Container Platform on vSphere	2788
20.1.3. VMware vSphere infrastructure requirements	2788
20.1.4. VMware vSphere CSI Driver Operator requirements	2789
20.1.5. Uninstalling an installer-provisioned infrastructure installation of OpenShift Container Platform on vSphere	2790
20.2. INSTALLING A CLUSTER ON VSPHERE	2790
20.2.1. Prerequisites	2790
20.2.2. Internet access for OpenShift Container Platform	2791
20.2.3. VMware vSphere infrastructure requirements	2791
20.2.4. Network connectivity requirements	2793
20.2.5. VMware vSphere CSI Driver Operator requirements	2794
20.2.6. vCenter requirements	2794
Required vCenter account privileges	2794
Using OpenShift Container Platform with vMotion	2803
Cluster resources	2804
Cluster limits	2804
Networking requirements	2804
Required IP Addresses	2804
DNS records	2805
20.2.7. Generating a key pair for cluster node SSH access	2805
20.2.8. Obtaining the installation program	2807
20.2.9. Adding vCenter root CA certificates to your system trust	2808
20.2.10. Deploying the cluster	2809
20.2.11. Installing the OpenShift CLI by downloading the binary	2811
Installing the OpenShift CLI on Linux	2811
Installing the OpenShift CLI on Windows	2812
Installing the OpenShift CLI on macOS	2812
20.2.12. Logging in to the cluster by using the CLI	2813
20.2.13. Creating registry storage	2813
20.2.13.1. Image registry removed during installation	2813
20.2.13.2. Image registry storage configuration	2813
20.2.13.2.1. Configuring registry storage for VMware vSphere	2814
20.2.13.2.2. Configuring block registry storage for VMware vSphere	2815
20.2.14. Backing up VMware vSphere volumes	2817
20.2.15. Telemetry access for OpenShift Container Platform	2817
20.2.16. Next steps	2817
20.3. INSTALLING A CLUSTER ON VSPHERE WITH CUSTOMIZATIONS	2817
20.3.1. Prerequisites	2818
20.3.2. Internet access for OpenShift Container Platform	2818
20.3.3. VMware vSphere infrastructure requirements	2818
20.3.4. Network connectivity requirements	2820
20.3.5. VMware vSphere CSI Driver Operator requirements	2821
20.3.6. vCenter requirements	2822
Required vCenter account privileges	2822
Using OpenShift Container Platform with vMotion	2831
Cluster resources	2831
Cluster limits	2832
Networking requirements	2832



Required IP Addresses	2832
DNS records	2832
20.3.7. Generating a key pair for cluster node SSH access	2833
20.3.8. Obtaining the installation program	2835
20.3.9. Adding vCenter root CA certificates to your system trust	2835
20.3.10. Creating the installation configuration file	2836
20.3.10.1. Installation configuration parameters	2838
20.3.10.1.1. Required configuration parameters	2838
20.3.10.1.2. Network configuration parameters	2839
20.3.10.1.3. Optional configuration parameters	2841
20.3.10.1.4. Additional VMware vSphere configuration parameters	2846
20.3.10.1.5. Optional VMware vSphere machine pool configuration parameters	2847
20.3.10.2. Sample install-config.yaml file for an installer-provisioned VMware vSphere cluster	2848
20.3.10.3. Configuring the cluster-wide proxy during installation	2850
20.3.11. Deploying the cluster	2851
20.3.12. Installing the OpenShift CLI by downloading the binary	2853
Installing the OpenShift CLI on Linux	2853
Installing the OpenShift CLI on Windows	2853
Installing the OpenShift CLI on macOS	2854
20.3.13. Logging in to the cluster by using the CLI	2854
20.3.14. Creating registry storage	2855
20.3.14.1. Image registry removed during installation	2855
20.3.14.2. Image registry storage configuration	2855
20.3.14.2.1. Configuring registry storage for VMware vSphere	2855
20.3.14.2.2. Configuring block registry storage for VMware vSphere	2857
20.3.15. Backing up VMware vSphere volumes	2858
20.3.16. Telemetry access for OpenShift Container Platform	2858
20.3.17. Next steps	2859
20.4. INSTALLING A CLUSTER ON VSPHERE WITH NETWORK CUSTOMIZATIONS	2859
20.4.1. Prerequisites	2859
20.4.2. Internet access for OpenShift Container Platform	2860
20.4.3. VMware vSphere infrastructure requirements	2860
20.4.4. Network connectivity requirements	2861
20.4.5. VMware vSphere CSI Driver Operator requirements	2863
20.4.6. vCenter requirements	2863
Required vCenter account privileges	2863
Using OpenShift Container Platform with vMotion	2872
Cluster resources	2872
Cluster limits	2873
Networking requirements	2873
Required IP Addresses	2873
DNS records	2873
20.4.7. Generating a key pair for cluster node SSH access	2874
20.4.8. Obtaining the installation program	2876
20.4.9. Adding vCenter root CA certificates to your system trust	2876
20.4.10. Creating the installation configuration file	2877
20.4.10.1. Installation configuration parameters	2879
20.4.10.1.1. Required configuration parameters	2879
20.4.10.1.2. Network configuration parameters	2880
20.4.10.1.3. Optional configuration parameters	2882
20.4.10.1.4. Additional VMware vSphere configuration parameters	2887
20.4.10.1.5. Optional VMware vSphere machine pool configuration parameters	2888
20.4.10.2. Sample install-config.yaml file for an installer-provisioned VMware vSphere cluster	2889

20.4.10.3. Configuring the cluster-wide proxy during installation	2891
20.4.11. Network configuration phases	2892
20.4.12. Specifying advanced network configuration	2893
20.4.13. Cluster Network Operator configuration	2894
20.4.13.1. Cluster Network Operator configuration object	2895
defaultNetwork object configuration	2896
Configuration for the OpenShift SDN CNI cluster network provider	2896
Configuration for the OVN-Kubernetes CNI cluster network provider	2897
kubeProxyConfig object configuration	2899
20.4.14. Deploying the cluster	2900
20.4.15. Installing the OpenShift CLI by downloading the binary	2901
Installing the OpenShift CLI on Linux	2902
Installing the OpenShift CLI on Windows	2902
Installing the OpenShift CLI on macOS	2903
20.4.16. Logging in to the cluster by using the CLI	2903
20.4.17. Creating registry storage	2904
20.4.17.1. Image registry removed during installation	2904
20.4.17.2. Image registry storage configuration	2904
20.4.17.2.1. Configuring registry storage for VMware vSphere	2904
20.4.17.2.2. Configuring block registry storage for VMware vSphere	2906
20.4.18. Backing up VMware vSphere volumes	2907
20.4.19. Telemetry access for OpenShift Container Platform	2907
20.4.20. Next steps	2908
20.5. INSTALLING A CLUSTER ON VSPHERE WITH USER-PROVISIONED INFRASTRUCTURE	2908
20.5.1. Prerequisites	2908
20.5.2. Internet access for OpenShift Container Platform	2909
20.5.3. VMware vSphere infrastructure requirements	2909
20.5.4. VMware vSphere CSI Driver Operator requirements	2910
20.5.5. Requirements for a cluster with user-provisioned infrastructure	2911
20.5.5.1. Required machines for cluster installation	2911
20.5.5.2. Minimum resource requirements for cluster installation	2912
20.5.5.3. Certificate signing requests management	2913
20.5.5.4. Networking requirements for user-provisioned infrastructure	2913
20.5.5.4.1. Setting the cluster node hostnames through DHCP	2913
20.5.5.4.2. Network connectivity requirements	2913
Ethernet adaptor hardware address requirements	2915
NTP configuration for user-provisioned infrastructure	2915
20.5.5.5. User-provisioned DNS requirements	2915
20.5.5.5.1. Example DNS configuration for user-provisioned clusters	2917
20.5.5.6. Load balancing requirements for user-provisioned infrastructure	2919
20.5.5.6.1. Example load balancer configuration for user-provisioned clusters	2921
20.5.6. Preparing the user-provisioned infrastructure	2923
20.5.7. Validating DNS resolution for user-provisioned infrastructure	2925
20.5.8. Generating a key pair for cluster node SSH access	2927
20.5.9. Obtaining the installation program	2929
20.5.10. Manually creating the installation configuration file	2930
20.5.10.1. Sample install-config.yaml file for VMware vSphere	2931
20.5.10.2. Configuring the cluster-wide proxy during installation	2933
20.5.11. Creating the Kubernetes manifest and Ignition config files	2934
20.5.12. Extracting the infrastructure name	2936
20.5.13. Installing RHCOS and starting the OpenShift Container Platform bootstrap process	2936
20.5.14. Adding more compute machines to a cluster in vSphere	2941
20.5.15. Disk partitioning	2941

Creating a separate /var partition	2942
20.5.16. Updating the bootloader using bootupd	2944
20.5.17. Installing the OpenShift CLI by downloading the binary	2946
Installing the OpenShift CLI on Linux	2946
Installing the OpenShift CLI on Windows	2946
Installing the OpenShift CLI on macOS	2947
20.5.18. Waiting for the bootstrap process to complete	2947
20.5.19. Logging in to the cluster by using the CLI	2948
20.5.20. Approving the certificate signing requests for your machines	2949
20.5.21. Initial Operator configuration	2951
20.5.21.1. Image registry removed during installation	2952
20.5.21.2. Image registry storage configuration	2952
20.5.21.2.1. Configuring registry storage for VMware vSphere	2953
20.5.21.2.2. Configuring storage for the image registry in non-production clusters	2954
20.5.21.2.3. Configuring block registry storage for VMware vSphere	2955
20.5.22. Completing installation on user-provisioned infrastructure	2956
20.5.23. Configuring vSphere DRS anti-affinity rules for control plane nodes	2959
20.5.24. Backing up VMware vSphere volumes	2960
20.5.25. Telemetry access for OpenShift Container Platform	2960
20.5.26. Next steps	2960
20.6. INSTALLING A CLUSTER ON VSPHERE WITH NETWORK CUSTOMIZATIONS	2961
20.6.1. Prerequisites	2961
20.6.2. Internet access for OpenShift Container Platform	2961
20.6.3. VMware vSphere infrastructure requirements	2962
20.6.4. VMware vSphere CSI Driver Operator requirements	2963
20.6.5. Requirements for a cluster with user-provisioned infrastructure	2964
20.6.5.1. Required machines for cluster installation	2964
20.6.5.2. Minimum resource requirements for cluster installation	2965
20.6.5.3. Certificate signing requests management	2965
20.6.5.4. Networking requirements for user-provisioned infrastructure	2965
20.6.5.4.1. Setting the cluster node hostnames through DHCP	2966
20.6.5.4.2. Network connectivity requirements	2966
Ethernet adaptor hardware address requirements	2967
NTP configuration for user-provisioned infrastructure	2968
20.6.5.5. User-provisioned DNS requirements	2968
20.6.5.5.1. Example DNS configuration for user-provisioned clusters	2970
20.6.5.6. Load balancing requirements for user-provisioned infrastructure	2972
20.6.5.6.1. Example load balancer configuration for user-provisioned clusters	2974
20.6.6. Preparing the user-provisioned infrastructure	2976
20.6.7. Validating DNS resolution for user-provisioned infrastructure	2977
20.6.8. Generating a key pair for cluster node SSH access	2980
20.6.9. Obtaining the installation program	2981
20.6.10. Manually creating the installation configuration file	2982
20.6.10.1. Sample install-config.yaml file for VMware vSphere	2983
20.6.10.2. Configuring the cluster-wide proxy during installation	2985
20.6.11. Network configuration phases	2987
20.6.12. Specifying advanced network configuration	2988
20.6.13. Cluster Network Operator configuration	2989
20.6.13.1. Cluster Network Operator configuration object	2989
defaultNetwork object configuration	2990
Configuration for the OpenShift SDN CNI cluster network provider	2991
Configuration for the OVN-Kubernetes CNI cluster network provider	2992
kubeProxyConfig object configuration	2994

20.6.14. Creating the Ignition config files	2995
20.6.15. Extracting the infrastructure name	2996
20.6.16. Installing RHCOS and starting the OpenShift Container Platform bootstrap process	2997
20.6.17. Adding more compute machines to a cluster in vSphere	3001
20.6.18. Disk partitioning	3002
Creating a separate /var partition	3003
20.6.19. Updating the bootloader using bootupd	3005
20.6.20. Waiting for the bootstrap process to complete	3006
20.6.21. Logging in to the cluster by using the CLI	3007
20.6.22. Approving the certificate signing requests for your machines	3008
20.6.22.1. Initial Operator configuration	3010
20.6.22.2. Image registry removed during installation	3011
20.6.22.3. Image registry storage configuration	3011
20.6.22.3.1. Configuring block registry storage for VMware vSphere	3012
20.6.23. Completing installation on user-provisioned infrastructure	3013
20.6.24. Configuring vSphere DRS anti-affinity rules for control plane nodes	3016
20.6.25. Backing up VMware vSphere volumes	3017
20.6.26. Telemetry access for OpenShift Container Platform	3017
20.6.27. Next steps	3017
20.7. INSTALLING A CLUSTER ON VSPHERE IN A RESTRICTED NETWORK	3018
20.7.1. Prerequisites	3018
20.7.2. About installations in restricted networks	3018
20.7.2.1. Additional limits	3019
20.7.3. Internet access for OpenShift Container Platform	3019
20.7.4. VMware vSphere infrastructure requirements	3019
20.7.5. Network connectivity requirements	3021
20.7.6. VMware vSphere CSI Driver Operator requirements	3022
20.7.7. vCenter requirements	3022
Required vCenter account privileges	3022
Using OpenShift Container Platform with vMotion	3031
Cluster resources	3031
Cluster limits	3032
Networking requirements	3032
Required IP Addresses	3032
DNS records	3032
20.7.8. Generating a key pair for cluster node SSH access	3033
20.7.9. Adding vCenter root CA certificates to your system trust	3035
20.7.10. Creating the RHCOS image for restricted network installations	3036
20.7.11. Creating the installation configuration file	3036
20.7.11.1. Installation configuration parameters	3039
20.7.11.1.1. Required configuration parameters	3039
20.7.11.1.2. Network configuration parameters	3040
20.7.11.1.3. Optional configuration parameters	3042
20.7.11.1.4. Additional VMware vSphere configuration parameters	3047
20.7.11.1.5. Optional VMware vSphere machine pool configuration parameters	3048
20.7.11.2. Sample install-config.yaml file for an installer-provisioned VMware vSphere cluster	3049
20.7.11.3. Configuring the cluster-wide proxy during installation	3051
20.7.12. Deploying the cluster	3053
20.7.13. Installing the OpenShift CLI by downloading the binary	3054
Installing the OpenShift CLI on Linux	3054
Installing the OpenShift CLI on Windows	3055
Installing the OpenShift CLI on macOS	3055
20.7.14. Logging in to the cluster by using the CLI	3056

20.7.15. Disabling the default OperatorHub sources	3056
20.7.16. Creating registry storage	3057
20.7.16.1. Image registry removed during installation	3057
20.7.16.2. Image registry storage configuration	3057
20.7.16.2.1. Configuring registry storage for VMware vSphere	3057
20.7.17. Telemetry access for OpenShift Container Platform	3059
20.7.18. Next steps	3059
20.8. INSTALLING A CLUSTER ON VSPHERE IN A RESTRICTED NETWORK WITH USER-PROVISIONED INFRASTRUCTURE	3059
20.8.1. Prerequisites	3060
20.8.2. About installations in restricted networks	3060
20.8.2.1. Additional limits	3061
20.8.3. Internet access for OpenShift Container Platform	3061
20.8.4. VMware vSphere infrastructure requirements	3061
20.8.5. VMware vSphere CSI Driver Operator requirements	3063
20.8.6. Requirements for a cluster with user-provisioned infrastructure	3063
20.8.6.1. Required machines for cluster installation	3063
20.8.6.2. Minimum resource requirements for cluster installation	3064
20.8.6.3. Certificate signing requests management	3065
20.8.6.4. Networking requirements for user-provisioned infrastructure	3065
20.8.6.4.1. Setting the cluster node hostnames through DHCP	3065
20.8.6.4.2. Network connectivity requirements	3066
Ethernet adaptor hardware address requirements	3067
NTP configuration for user-provisioned infrastructure	3067
20.8.6.5. User-provisioned DNS requirements	3067
20.8.6.5.1. Example DNS configuration for user-provisioned clusters	3069
20.8.6.6. Load balancing requirements for user-provisioned infrastructure	3072
20.8.6.6.1. Example load balancer configuration for user-provisioned clusters	3073
20.8.7. Preparing the user-provisioned infrastructure	3075
20.8.8. Validating DNS resolution for user-provisioned infrastructure	3077
20.8.9. Generating a key pair for cluster node SSH access	3079
20.8.10. Manually creating the installation configuration file	3081
20.8.10.1. Sample install-config.yaml file for VMware vSphere	3082
20.8.10.2. Configuring the cluster-wide proxy during installation	3085
20.8.11. Creating the Kubernetes manifest and Ignition config files	3086
20.8.12. Configuring chrony time service	3088
20.8.13. Extracting the infrastructure name	3089
20.8.14. Installing RHCOS and starting the OpenShift Container Platform bootstrap process	3090
20.8.15. Adding more compute machines to a cluster in vSphere	3094
20.8.16. Disk partitioning	3095
Creating a separate /var partition	3095
20.8.17. Updating the bootloader using bootupd	3097
20.8.18. Waiting for the bootstrap process to complete	3099
20.8.19. Logging in to the cluster by using the CLI	3100
20.8.20. Approving the certificate signing requests for your machines	3100
20.8.21. Initial Operator configuration	3103
20.8.21.1. Disabling the default OperatorHub sources	3104
20.8.21.2. Image registry storage configuration	3104
20.8.21.2.1. Configuring registry storage for VMware vSphere	3105
20.8.21.2.2. Configuring storage for the image registry in non-production clusters	3106
20.8.21.2.3. Configuring block registry storage for VMware vSphere	3107
20.8.22. Completing installation on user-provisioned infrastructure	3108
20.8.23. Configuring vSphere DRS anti-affinity rules for control plane nodes	3111

20.8.24. Backing up VMware vSphere volumes	3112
20.8.25. Telemetry access for OpenShift Container Platform	3112
20.8.26. Next steps	3112
20.9. UNINSTALLING A CLUSTER ON VSPHERE THAT USES INSTALLER-PROVISIONED INFRASTRUCTURE	3113
20.9.1. Removing a cluster that uses installer-provisioned infrastructure	3113
20.10. USING THE VSPHERE PROBLEM DETECTOR OPERATOR	3114
20.10.1. About the vSphere Problem Detector Operator	3114
20.10.2. Running the vSphere Problem Detector Operator checks	3114
20.10.3. Viewing the events from the vSphere Problem Detector Operator	3115
20.10.4. Viewing the logs from the vSphere Problem Detector Operator	3115
20.10.5. Configuration checks run by the vSphere Problem Detector Operator	3116
20.10.6. About the storage class configuration check	3117
20.10.7. Metrics for the vSphere Problem Detector Operator	3118
20.10.8. Additional resources	3118
<b>CHAPTER 21. INSTALLING ON VMC</b>	<b>3119</b>
21.1. PREPARING TO INSTALL ON VMC	3119
21.1.1. Prerequisites	3119
21.1.2. Choosing a method to install OpenShift Container Platform on VMC	3119
21.1.2.1. Installer-provisioned infrastructure installation of OpenShift Container Platform on VMC	3119
21.1.2.2. User-provisioned infrastructure installation of OpenShift Container Platform on VMC	3120
21.1.3. VMware vSphere infrastructure requirements	3120
21.1.4. VMware vSphere CSI Driver Operator requirements	3121
21.1.5. Uninstalling an installer-provisioned infrastructure installation of OpenShift Container Platform on VMC	3122
21.2. INSTALLING A CLUSTER ON VMC	3122
21.2.1. Setting up VMC for vSphere	3122
21.2.1.1. VMC Sizer tool	3124
21.2.2. vSphere prerequisites	3125
21.2.3. Internet access for OpenShift Container Platform	3125
21.2.4. VMware vSphere infrastructure requirements	3125
21.2.5. Network connectivity requirements	3127
21.2.6. VMware vSphere CSI Driver Operator requirements	3128
21.2.7. vCenter requirements	3128
Required vCenter account privileges	3128
Using OpenShift Container Platform with vMotion	3137
Cluster resources	3138
Cluster limits	3138
Networking requirements	3138
Required IP Addresses	3138
DNS records	3139
21.2.8. Generating a key pair for cluster node SSH access	3139
21.2.9. Obtaining the installation program	3141
21.2.10. Adding vCenter root CA certificates to your system trust	3142
21.2.11. Deploying the cluster	3143
21.2.12. Installing the OpenShift CLI by downloading the binary	3145
Installing the OpenShift CLI on Linux	3145
Installing the OpenShift CLI on Windows	3146
Installing the OpenShift CLI on macOS	3146
21.2.13. Logging in to the cluster by using the CLI	3147
21.2.14. Creating registry storage	3147
21.2.14.1. Image registry removed during installation	3147

21.2.14.2. Image registry storage configuration	3148
21.2.14.2.1. Configuring registry storage for VMware vSphere	3148
21.2.14.2.2. Configuring block registry storage for VMware vSphere	3149
21.2.15. Backing up VMware vSphere volumes	3151
21.2.16. Telemetry access for OpenShift Container Platform	3151
21.2.17. Next steps	3151
21.3. INSTALLING A CLUSTER ON VMC WITH CUSTOMIZATIONS	3152
21.3.1. Setting up VMC for vSphere	3152
21.3.1.1. VMC Sizer tool	3154
21.3.2. vSphere prerequisites	3154
21.3.3. Internet access for OpenShift Container Platform	3155
21.3.4. VMware vSphere infrastructure requirements	3155
21.3.5. Network connectivity requirements	3156
21.3.6. VMware vSphere CSI Driver Operator requirements	3157
21.3.7. vCenter requirements	3158
Required vCenter account privileges	3158
Using OpenShift Container Platform with vMotion	3167
Cluster resources	3167
Cluster limits	3168
Networking requirements	3168
Required IP Addresses	3168
DNS records	3168
21.3.8. Generating a key pair for cluster node SSH access	3169
21.3.9. Obtaining the installation program	3171
21.3.10. Adding vCenter root CA certificates to your system trust	3171
21.3.11. Creating the installation configuration file	3172
21.3.11.1. Installation configuration parameters	3174
21.3.11.1.1. Required configuration parameters	3174
21.3.11.1.2. Network configuration parameters	3175
21.3.11.1.3. Optional configuration parameters	3177
21.3.11.1.4. Additional VMware vSphere configuration parameters	3182
21.3.11.1.5. Optional VMware vSphere machine pool configuration parameters	3183
21.3.11.2. Sample install-config.yaml file for an installer-provisioned VMware vSphere cluster	3184
21.3.11.3. Configuring the cluster-wide proxy during installation	3186
21.3.12. Deploying the cluster	3187
21.3.13. Installing the OpenShift CLI by downloading the binary	3189
Installing the OpenShift CLI on Linux	3189
Installing the OpenShift CLI on Windows	3190
Installing the OpenShift CLI on macOS	3190
21.3.14. Logging in to the cluster by using the CLI	3190
21.3.15. Creating registry storage	3191
21.3.15.1. Image registry removed during installation	3191
21.3.15.2. Image registry storage configuration	3191
21.3.15.2.1. Configuring registry storage for VMware vSphere	3191
21.3.15.2.2. Configuring block registry storage for VMware vSphere	3193
21.3.16. Backing up VMware vSphere volumes	3194
21.3.17. Telemetry access for OpenShift Container Platform	3195
21.3.18. Next steps	3195
21.4. INSTALLING A CLUSTER ON VMC WITH NETWORK CUSTOMIZATIONS	3195
21.4.1. Setting up VMC for vSphere	3196
21.4.1.1. VMC Sizer tool	3197
21.4.2. vSphere prerequisites	3198
21.4.3. Internet access for OpenShift Container Platform	3198

21.4.4. VMware vSphere infrastructure requirements	3199
21.4.5. Network connectivity requirements	3200
21.4.6. VMware vSphere CSI Driver Operator requirements	3201
21.4.7. vCenter requirements	3202
Required vCenter account privileges	3202
Using OpenShift Container Platform with vMotion	3211
Cluster resources	3211
Cluster limits	3212
Networking requirements	3212
Required IP Addresses	3212
DNS records	3212
21.4.8. Generating a key pair for cluster node SSH access	3213
21.4.9. Obtaining the installation program	3215
21.4.10. Adding vCenter root CA certificates to your system trust	3215
21.4.11. Creating the installation configuration file	3216
21.4.11.1. Installation configuration parameters	3218
21.4.11.1.1. Required configuration parameters	3218
21.4.11.1.2. Network configuration parameters	3219
21.4.11.1.3. Optional configuration parameters	3221
21.4.11.1.4. Additional VMware vSphere configuration parameters	3226
21.4.11.1.5. Optional VMware vSphere machine pool configuration parameters	3227
21.4.11.2. Sample install-config.yaml file for an installer-provisioned VMware vSphere cluster	3228
21.4.11.3. Configuring the cluster-wide proxy during installation	3230
21.4.12. Network configuration phases	3231
21.4.13. Specifying advanced network configuration	3232
21.4.14. Cluster Network Operator configuration	3233
21.4.14.1. Cluster Network Operator configuration object	3234
defaultNetwork object configuration	3235
Configuration for the OpenShift SDN CNI cluster network provider	3235
Configuration for the OVN-Kubernetes CNI cluster network provider	3236
kubeProxyConfig object configuration	3238
21.4.15. Deploying the cluster	3239
21.4.16. Installing the OpenShift CLI by downloading the binary	3241
Installing the OpenShift CLI on Linux	3241
Installing the OpenShift CLI on Windows	3241
Installing the OpenShift CLI on macOS	3242
21.4.17. Logging in to the cluster by using the CLI	3242
21.4.18. Creating registry storage	3243
21.4.18.1. Image registry removed during installation	3243
21.4.18.2. Image registry storage configuration	3243
21.4.18.2.1. Configuring registry storage for VMware vSphere	3243
21.4.18.2.2. Configuring block registry storage for VMware vSphere	3245
21.4.19. Backing up VMware vSphere volumes	3246
21.4.20. Telemetry access for OpenShift Container Platform	3246
21.4.21. Next steps	3247
21.5. INSTALLING A CLUSTER ON VMC IN A RESTRICTED NETWORK	3247
21.5.1. Setting up VMC for vSphere	3247
21.5.1.1. VMC Sizer tool	3249
21.5.2. vSphere prerequisites	3249
21.5.3. About installations in restricted networks	3250
21.5.3.1. Additional limits	3250
21.5.4. Internet access for OpenShift Container Platform	3250
21.5.5. VMware vSphere infrastructure requirements	3251



21.5.6. Network connectivity requirements	3252
21.5.7. VMware vSphere CSI Driver Operator requirements	3253
21.5.8. vCenter requirements	3254
Required vCenter account privileges	3254
Using OpenShift Container Platform with vMotion	3263
Cluster resources	3263
Cluster limits	3264
Networking requirements	3264
Required IP Addresses	3264
DNS records	3264
21.5.9. Generating a key pair for cluster node SSH access	3265
21.5.10. Adding vCenter root CA certificates to your system trust	3267
21.5.11. Creating the RHCOS image for restricted network installations	3267
21.5.12. Creating the installation configuration file	3268
21.5.12.1. Installation configuration parameters	3271
21.5.12.1.1. Required configuration parameters	3271
21.5.12.1.2. Network configuration parameters	3272
21.5.12.1.3. Optional configuration parameters	3274
21.5.12.1.4. Additional VMware vSphere configuration parameters	3279
21.5.12.1.5. Optional VMware vSphere machine pool configuration parameters	3280
21.5.12.2. Sample install-config.yaml file for an installer-provisioned VMware vSphere cluster	3281
21.5.12.3. Configuring the cluster-wide proxy during installation	3283
21.5.13. Deploying the cluster	3285
21.5.14. Installing the OpenShift CLI by downloading the binary	3286
Installing the OpenShift CLI on Linux	3287
Installing the OpenShift CLI on Windows	3287
Installing the OpenShift CLI on macOS	3288
21.5.15. Logging in to the cluster by using the CLI	3288
21.5.16. Disabling the default OperatorHub sources	3289
21.5.17. Creating registry storage	3289
21.5.17.1. Image registry removed during installation	3289
21.5.17.2. Image registry storage configuration	3289
21.5.17.2.1. Configuring registry storage for VMware vSphere	3289
21.5.18. Telemetry access for OpenShift Container Platform	3291
21.5.19. Next steps	3291
21.6. INSTALLING A CLUSTER ON VMC WITH USER-PROVISIONED INFRASTRUCTURE	3291
21.6.1. Setting up VMC for vSphere	3292
21.6.1.1. VMC Sizer tool	3293
21.6.2. vSphere prerequisites	3294
21.6.3. Internet access for OpenShift Container Platform	3294
21.6.4. VMware vSphere infrastructure requirements	3295
21.6.5. VMware vSphere CSI Driver Operator requirements	3296
21.6.6. Requirements for a cluster with user-provisioned infrastructure	3297
21.6.6.1. Required machines for cluster installation	3297
21.6.6.2. Minimum resource requirements for cluster installation	3297
21.6.6.3. Certificate signing requests management	3298
21.6.6.4. Networking requirements for user-provisioned infrastructure	3298
21.6.6.4.1. Setting the cluster node hostnames through DHCP	3299
21.6.6.4.2. Network connectivity requirements	3299
Ethernet adaptor hardware address requirements	3300
NTP configuration for user-provisioned infrastructure	3301
21.6.6.5. User-provisioned DNS requirements	3301
21.6.6.5.1. Example DNS configuration for user-provisioned clusters	3303

21.6.6.6. Load balancing requirements for user-provisioned infrastructure	3305
21.6.6.6.1. Example load balancer configuration for user-provisioned clusters	3307
21.6.7. Preparing the user-provisioned infrastructure	3308
21.6.8. Validating DNS resolution for user-provisioned infrastructure	3310
21.6.9. Generating a key pair for cluster node SSH access	3313
21.6.10. Obtaining the installation program	3314
21.6.11. Manually creating the installation configuration file	3315
21.6.11.1. Sample install-config.yaml file for VMware vSphere	3316
21.6.11.2. Configuring the cluster-wide proxy during installation	3318
21.6.12. Creating the Kubernetes manifest and Ignition config files	3320
21.6.13. Extracting the infrastructure name	3321
21.6.14. Installing RHCOS and starting the OpenShift Container Platform bootstrap process	3322
21.6.15. Adding more compute machines to a cluster in vSphere	3326
21.6.16. Disk partitioning	3327
Creating a separate /var partition	3328
21.6.17. Updating the bootloader using bootupd	3330
21.6.18. Installing the OpenShift CLI by downloading the binary	3331
Installing the OpenShift CLI on Linux	3331
Installing the OpenShift CLI on Windows	3332
Installing the OpenShift CLI on macOS	3332
21.6.19. Waiting for the bootstrap process to complete	3333
21.6.20. Logging in to the cluster by using the CLI	3334
21.6.21. Approving the certificate signing requests for your machines	3334
21.6.22. Initial Operator configuration	3337
21.6.22.1. Image registry removed during installation	3338
21.6.22.2. Image registry storage configuration	3338
21.6.22.2.1. Configuring registry storage for VMware vSphere	3338
21.6.22.2.2. Configuring storage for the image registry in non-production clusters	3340
21.6.22.2.3. Configuring block registry storage for VMware vSphere	3341
21.6.23. Completing installation on user-provisioned infrastructure	3342
21.6.24. Backing up VMware vSphere volumes	3344
21.6.25. Telemetry access for OpenShift Container Platform	3345
21.6.26. Next steps	3345
21.7. INSTALLING A CLUSTER ON VMC WITH USER-PROVISIONED INFRASTRUCTURE AND NETWORK CUSTOMIZATIONS	3345
21.7.1. Setting up VMC for vSphere	3345
21.7.1.1. VMC Sizer tool	3347
21.7.2. vSphere prerequisites	3348
21.7.3. Internet access for OpenShift Container Platform	3348
21.7.4. VMware vSphere infrastructure requirements	3348
21.7.5. VMware vSphere CSI Driver Operator requirements	3349
21.7.6. Requirements for a cluster with user-provisioned infrastructure	3350
21.7.6.1. Required machines for cluster installation	3350
21.7.6.2. Minimum resource requirements for cluster installation	3351
21.7.6.3. Certificate signing requests management	3352
21.7.6.4. Networking requirements for user-provisioned infrastructure	3352
21.7.6.4.1. Setting the cluster node hostnames through DHCP	3352
21.7.6.4.2. Network connectivity requirements	3352
Ethernet adaptor hardware address requirements	3354
NTP configuration for user-provisioned infrastructure	3354
21.7.6.5. User-provisioned DNS requirements	3354
21.7.6.5.1. Example DNS configuration for user-provisioned clusters	3356
21.7.6.6. Load balancing requirements for user-provisioned infrastructure	3358

21.7.6.6.1. Example load balancer configuration for user-provisioned clusters	3360
21.7.7. Preparing the user-provisioned infrastructure	3362
21.7.8. Validating DNS resolution for user-provisioned infrastructure	3363
21.7.9. Generating a key pair for cluster node SSH access	3366
21.7.10. Obtaining the installation program	3367
21.7.11. Manually creating the installation configuration file	3368
21.7.11.1. Sample install-config.yaml file for VMware vSphere	3369
21.7.11.2. Configuring the cluster-wide proxy during installation	3371
21.7.12. Specifying advanced network configuration	3373
21.7.13. Cluster Network Operator configuration	3374
21.7.13.1. Cluster Network Operator configuration object	3375
defaultNetwork object configuration	3375
Configuration for the OpenShift SDN CNI cluster network provider	3376
Configuration for the OVN-Kubernetes CNI cluster network provider	3377
kubeProxyConfig object configuration	3379
21.7.14. Creating the Ignition config files	3380
21.7.15. Extracting the infrastructure name	3381
21.7.16. Installing RHCOS and starting the OpenShift Container Platform bootstrap process	3382
21.7.17. Adding more compute machines to a cluster in vSphere	3386
21.7.18. Disk partitioning	3387
Creating a separate /var partition	3388
21.7.19. Updating the bootloader using bootupd	3390
21.7.20. Waiting for the bootstrap process to complete	3391
21.7.21. Logging in to the cluster by using the CLI	3392
21.7.22. Approving the certificate signing requests for your machines	3393
21.7.23. Initial Operator configuration	3395
21.7.23.1. Image registry removed during installation	3396
21.7.23.2. Image registry storage configuration	3396
21.7.23.2.1. Configuring block registry storage for VMware vSphere	3397
21.7.24. Completing installation on user-provisioned infrastructure	3398
21.7.25. Backing up VMware vSphere volumes	3401
21.7.26. Telemetry access for OpenShift Container Platform	3401
21.7.27. Next steps	3401
21.8. INSTALLING A CLUSTER ON VMC IN A RESTRICTED NETWORK WITH USER-PROVISIONED INFRASTRUCTURE	3401
21.8.1. Setting up VMC for vSphere	3402
21.8.1.1. VMC Sizer tool	3403
21.8.2. vSphere prerequisites	3404
21.8.3. About installations in restricted networks	3404
21.8.3.1. Additional limits	3405
21.8.4. Internet access for OpenShift Container Platform	3405
21.8.5. VMware vSphere infrastructure requirements	3405
21.8.6. VMware vSphere CSI Driver Operator requirements	3407
21.8.7. Requirements for a cluster with user-provisioned infrastructure	3407
21.8.7.1. Required machines for cluster installation	3407
21.8.7.2. Minimum resource requirements for cluster installation	3408
21.8.7.3. Certificate signing requests management	3409
21.8.7.4. Networking requirements for user-provisioned infrastructure	3409
21.8.7.4.1. Setting the cluster node hostnames through DHCP	3409
21.8.7.4.2. Network connectivity requirements	3410
Ethernet adaptor hardware address requirements	3411
NTP configuration for user-provisioned infrastructure	3411
21.8.7.5. User-provisioned DNS requirements	3411

21.8.7.5.1. Example DNS configuration for user-provisioned clusters	3413
21.8.7.6. Load balancing requirements for user-provisioned infrastructure	3415
21.8.7.6.1. Example load balancer configuration for user-provisioned clusters	3417
21.8.8. Preparing the user-provisioned infrastructure	3419
21.8.9. Validating DNS resolution for user-provisioned infrastructure	3421
21.8.10. Generating a key pair for cluster node SSH access	3423
21.8.11. Manually creating the installation configuration file	3425
21.8.11.1. Sample install-config.yaml file for VMware vSphere	3426
21.8.11.2. Configuring the cluster-wide proxy during installation	3428
21.8.12. Creating the Kubernetes manifest and Ignition config files	3430
21.8.13. Extracting the infrastructure name	3432
21.8.14. Installing RHCOS and starting the OpenShift Container Platform bootstrap process	3432
21.8.15. Adding more compute machines to a cluster in vSphere	3437
21.8.16. Disk partitioning	3437
Creating a separate /var partition	3438
21.8.17. Updating the bootloader using bootupd	3440
21.8.18. Waiting for the bootstrap process to complete	3442
21.8.19. Logging in to the cluster by using the CLI	3442
21.8.20. Approving the certificate signing requests for your machines	3443
21.8.21. Initial Operator configuration	3446
21.8.21.1. Disabling the default OperatorHub sources	3447
21.8.21.2. Image registry storage configuration	3447
21.8.21.2.1. Configuring registry storage for VMware vSphere	3447
21.8.21.2.2. Configuring storage for the image registry in non-production clusters	3449
21.8.21.2.3. Configuring block registry storage for VMware vSphere	3449
21.8.22. Completing installation on user-provisioned infrastructure	3451
21.8.23. Backing up VMware vSphere volumes	3453
21.8.24. Telemetry access for OpenShift Container Platform	3453
21.8.25. Next steps	3454
21.9. UNINSTALLING A CLUSTER ON VMC	3454
21.9.1. Removing a cluster that uses installer-provisioned infrastructure	3454
<b>CHAPTER 22. INSTALLING ON ANY PLATFORM</b> .....	<b>3456</b>
22.1. INSTALLING A CLUSTER ON ANY PLATFORM	3456
22.1.1. Prerequisites	3456
22.1.2. Internet access for OpenShift Container Platform	3456
22.1.3. Requirements for a cluster with user-provisioned infrastructure	3456
22.1.3.1. Required machines for cluster installation	3457
22.1.3.2. Minimum resource requirements for cluster installation	3457
22.1.3.3. Certificate signing requests management	3458
22.1.3.4. Networking requirements for user-provisioned infrastructure	3458
22.1.3.4.1. Setting the cluster node hostnames through DHCP	3459
22.1.3.4.2. Network connectivity requirements	3459
NTP configuration for user-provisioned infrastructure	3460
22.1.3.5. User-provisioned DNS requirements	3460
22.1.3.5.1. Example DNS configuration for user-provisioned clusters	3462
22.1.3.6. Load balancing requirements for user-provisioned infrastructure	3464
22.1.3.6.1. Example load balancer configuration for user-provisioned clusters	3466
22.1.4. Preparing the user-provisioned infrastructure	3468
22.1.5. Validating DNS resolution for user-provisioned infrastructure	3470
22.1.6. Generating a key pair for cluster node SSH access	3472
22.1.7. Obtaining the installation program	3474
22.1.8. Installing the OpenShift CLI by downloading the binary	3475

Installing the OpenShift CLI on Linux	3475
Installing the OpenShift CLI on Windows	3475
Installing the OpenShift CLI on macOS	3476
22.1.9. Manually creating the installation configuration file	3476
22.1.9.1. Sample install-config.yaml file for other platforms	3477
22.1.9.2. Configuring the cluster-wide proxy during installation	3480
22.1.9.3. Configuring a three-node cluster	3481
22.1.10. Creating the Kubernetes manifest and Ignition config files	3482
22.1.11. Installing RHCOS and starting the OpenShift Container Platform bootstrap process	3484
22.1.11.1. Installing RHCOS by using an ISO image	3485
22.1.11.2. Installing RHCOS by using PXE or iPXE booting	3488
22.1.11.3. Advanced RHCOS installation configuration	3492
22.1.11.3.1. Using advanced networking options for PXE and ISO installations	3493
22.1.11.3.2. Disk partitioning	3494
22.1.11.3.2.1. Creating a separate /var partition	3494
22.1.11.3.2.2. Retaining existing partitions	3497
22.1.11.3.3. Identifying Ignition configs	3497
22.1.11.3.4. Advanced RHCOS installation reference	3498
22.1.11.3.4.1. Networking and bonding options for ISO installations	3498
Configuring DHCP or static IP addresses	3499
Configuring an IP address without a static hostname	3499
Specifying multiple network interfaces	3499
Configuring default gateway and route	3500
Disabling DHCP on a single interface	3500
Combining DHCP and static IP configurations	3500
Configuring VLANs on individual interfaces	3500
Providing multiple DNS servers	3500
Bonding multiple network interfaces to a single interface	3501
Bonding multiple network interfaces to a single interface	3501
Using network teaming	3501
22.1.11.3.4.2. coreos-installer options for ISO and PXE installations	3502
22.1.11.3.4.3. coreos.inst boot options for ISO or PXE installations	3506
22.1.11.4. Updating the bootloader using bootupd	3507
22.1.12. Waiting for the bootstrap process to complete	3509
22.1.13. Logging in to the cluster by using the CLI	3510
22.1.14. Approving the certificate signing requests for your machines	3510
22.1.15. Initial Operator configuration	3513
22.1.15.1. Disabling the default OperatorHub sources	3514
22.1.15.2. Image registry removed during installation	3514
22.1.15.3. Image registry storage configuration	3515
22.1.15.3.1. Configuring registry storage for bare metal and other manual installations	3515
22.1.15.3.2. Configuring storage for the image registry in non-production clusters	3516
22.1.15.3.3. Configuring block registry storage	3517
22.1.16. Completing installation on user-provisioned infrastructure	3517
22.1.17. Telemetry access for OpenShift Container Platform	3520
22.1.18. Next steps	3520
<b>CHAPTER 23. INSTALLATION CONFIGURATION</b> .....	<b>3521</b>
23.1. CUSTOMIZING NODES	3521
23.1.1. Creating machine configs with Butane	3521
23.1.1.1. About Butane	3521
23.1.1.2. Installing Butane	3521
23.1.1.3. Creating a MachineConfig object by using Butane	3522

23.1.2. Adding day-1 kernel arguments	3523
23.1.3. Adding kernel modules to nodes	3524
23.1.3.1. Building and testing the kernel module container	3525
23.1.3.2. Provisioning a kernel module to OpenShift Container Platform	3528
23.1.3.2.1. Provision kernel modules via a MachineConfig object	3528
23.1.4. Encrypting and mirroring disks during installation	3530
23.1.4.1. About disk encryption	3530
23.1.4.1.1. Configuring an encryption threshold	3531
23.1.4.2. About disk mirroring	3532
23.1.4.3. Configuring disk encryption and mirroring	3533
23.1.4.4. Configuring a RAID-enabled data volume	3540
23.1.5. Configuring chrony time service	3542
23.1.6. Additional resources	3543
23.2. CONFIGURING YOUR FIREWALL	3543
23.2.1. Configuring your firewall for OpenShift Container Platform	3543
<b>CHAPTER 24. VALIDATING AN INSTALLATION</b>	<b>3549</b>
24.1. REVIEWING THE INSTALLATION LOG	3549
24.2. VIEWING THE IMAGE PULL SOURCE	3549
24.3. GETTING CLUSTER VERSION, STATUS, AND UPDATE DETAILS	3550
24.4. QUERYING THE STATUS OF THE CLUSTER NODES BY USING THE CLI	3552
24.5. REVIEWING THE CLUSTER STATUS FROM THE OPENSIFT CONTAINER PLATFORM WEB CONSOLE	3552
24.6. REVIEWING THE CLUSTER STATUS FROM RED HAT OPENSIFT CLUSTER MANAGER	3553
24.7. CHECKING CLUSTER RESOURCE AVAILABILITY AND UTILIZATION	3554
24.8. LISTING ALERTS THAT ARE FIRING	3556
24.9. NEXT STEPS	3556
<b>CHAPTER 25. TROUBLESHOOTING INSTALLATION ISSUES</b>	<b>3557</b>
25.1. PREREQUISITES	3557
25.2. GATHERING LOGS FROM A FAILED INSTALLATION	3557
25.3. MANUALLY GATHERING LOGS WITH SSH ACCESS TO YOUR HOST(S)	3558
25.4. MANUALLY GATHERING LOGS WITHOUT SSH ACCESS TO YOUR HOST(S)	3559
25.5. GETTING DEBUG INFORMATION FROM THE INSTALLATION PROGRAM	3559
25.6. REINSTALLING THE OPENSIFT CONTAINER PLATFORM CLUSTER	3560
<b>CHAPTER 26. SUPPORT FOR FIPS CRYPTOGRAPHY</b>	<b>3561</b>
26.1. FIPS VALIDATION IN OPENSIFT CONTAINER PLATFORM	3561
26.2. FIPS SUPPORT IN COMPONENTS THAT THE CLUSTER USES	3562
26.2.1. etcd	3562
26.2.2. Storage	3562
26.2.3. Runtimes	3562
26.3. INSTALLING A CLUSTER IN FIPS MODE	3562



# CHAPTER 1. OPENSIFT CONTAINER PLATFORM INSTALLATION OVERVIEW

## 1.1. OPENSIFT CONTAINER PLATFORM INSTALLATION OVERVIEW

The OpenShift Container Platform installation program offers you flexibility. You can use the installation program to deploy a cluster on infrastructure that the installation program provisions and the cluster maintains or deploy a cluster on infrastructure that you prepare and maintain.

These two basic types of OpenShift Container Platform clusters are frequently called installer-provisioned infrastructure clusters and user-provisioned infrastructure clusters.

Both types of clusters have the following characteristics:

- Highly available infrastructure with no single points of failure is available by default
- Administrators maintain control over what updates are applied and when

You use the same installation program to deploy both types of clusters. The main assets generated by the installation program are the Ignition config files for the bootstrap, master, and worker machines. With these three configurations and correctly configured infrastructure, you can start an OpenShift Container Platform cluster.

The OpenShift Container Platform installation program uses a set of targets and dependencies to manage cluster installation. The installation program has a set of targets that it must achieve, and each target has a set of dependencies. Because each target is only concerned with its own dependencies, the installation program can act to achieve multiple targets in parallel. The ultimate target is a running cluster. By meeting dependencies instead of running commands, the installation program is able to recognize and use existing components instead of running the commands to create them again.

The following diagram shows a subset of the installation targets and dependencies:



Figure 1.1. OpenShift Container Platform installation targets and dependencies

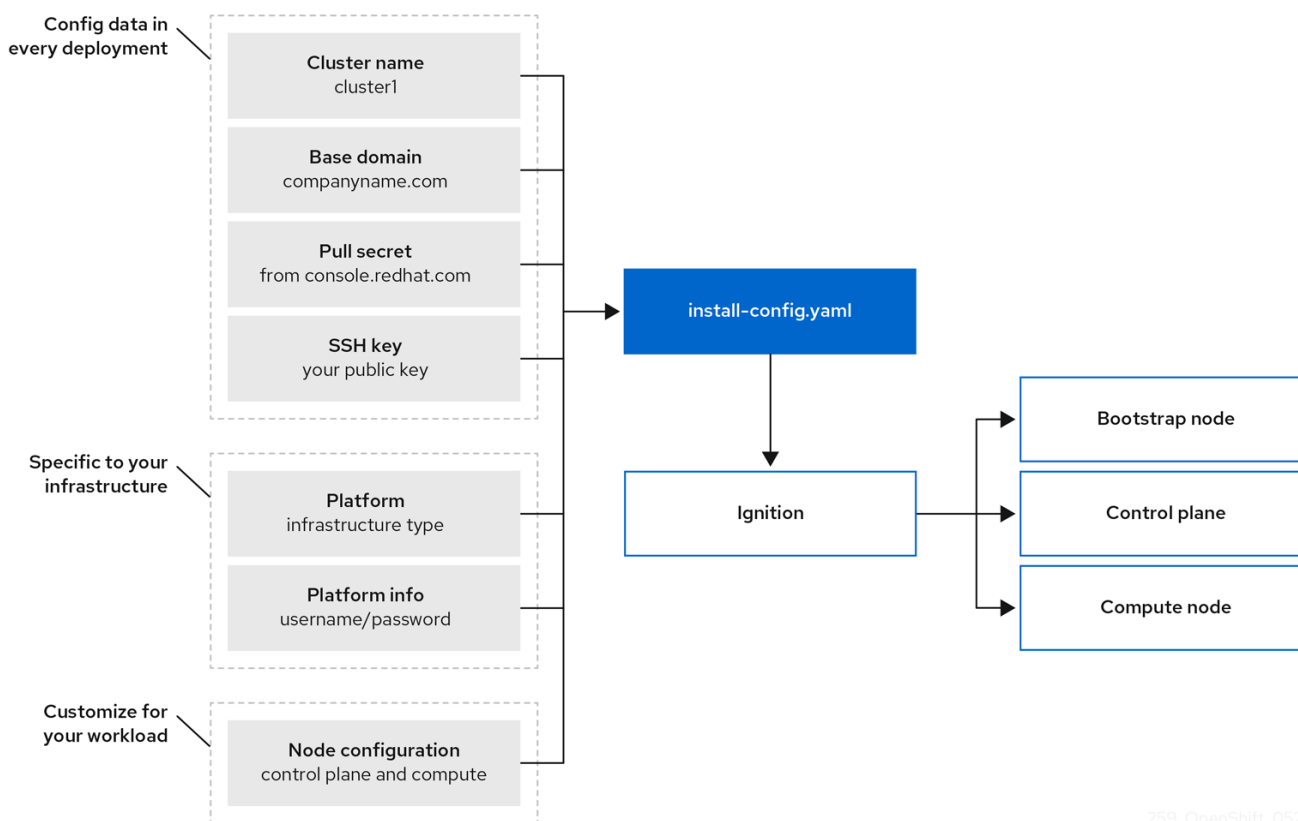

After installation, each cluster machine uses Red Hat Enterprise Linux CoreOS (RHCOS) as the operating system. RHCOS is the immutable container host version of Red Hat Enterprise Linux (RHEL) and features a RHEL kernel with SELinux enabled by default. It includes the **kubelet**, which is the Kubernetes node agent, and the CRI-O container runtime, which is optimized for Kubernetes.

Every control plane machine in an OpenShift Container Platform 4.10 cluster must use RHCOS, which includes a critical first-boot provisioning tool called Ignition. This tool enables the cluster to configure the machines. Operating system updates are delivered as an Atomic OSTree repository that is embedded in a container image that is rolled out across the cluster by an Operator. Actual operating system changes are made in-place on each machine as an atomic operation by using rpm-ostree. Together, these technologies enable OpenShift Container Platform to manage the operating system like it manages any other application on the cluster, via in-place upgrades that keep the entire platform up-to-date. These in-place updates can reduce the burden on operations teams.

If you use RHCOS as the operating system for all cluster machines, the cluster manages all aspects of its components and machines, including the operating system. Because of this, only the installation program and the Machine Config Operator can change machines. The installation program uses Ignition config files to set the exact state of each machine, and the Machine Config Operator completes more changes to the machines, such as the application of new certificates or keys, after installation.

### 1.1.1. Installation process

When you install an OpenShift Container Platform cluster, you download the installation program from the appropriate [Infrastructure Provider](#) page on the OpenShift Cluster Manager site. This site manages:

- REST API for accounts
- Registry tokens, which are the pull secrets that you use to obtain the required components

- Cluster registration, which associates the cluster identity to your Red Hat account to facilitate the gathering of usage metrics

In OpenShift Container Platform 4.10, the installation program is a Go binary file that performs a series of file transformations on a set of assets. The way you interact with the installation program differs depending on your installation type.

- For clusters with installer-provisioned infrastructure, you delegate the infrastructure bootstrapping and provisioning to the installation program instead of doing it yourself. The installation program creates all of the networking, machines, and operating systems that are required to support the cluster.
- If you provision and manage the infrastructure for your cluster, you must provide all of the cluster infrastructure and resources, including the bootstrap machine, networking, load balancing, storage, and individual cluster machines.

You use three sets of files during installation: an installation configuration file that is named **install-config.yaml**, Kubernetes manifests, and Ignition config files for your machine types.



### IMPORTANT

It is possible to modify Kubernetes and the Ignition config files that control the underlying RHCOS operating system during installation. However, no validation is available to confirm the suitability of any modifications that you make to these objects. If you modify these objects, you might render your cluster non-functional. Because of this risk, modifying Kubernetes and Ignition config files is not supported unless you are following documented procedures or are instructed to do so by Red Hat support.

The installation configuration file is transformed into Kubernetes manifests, and then the manifests are wrapped into Ignition config files. The installation program uses these Ignition config files to create the cluster.

The installation configuration files are all pruned when you run the installation program, so be sure to back up all configuration files that you want to use again.



### IMPORTANT

You cannot modify the parameters that you set during installation, but you can modify many cluster attributes after installation.

### The installation process with installer-provisioned infrastructure

The default installation type uses installer-provisioned infrastructure. By default, the installation program acts as an installation wizard, prompting you for values that it cannot determine on its own and providing reasonable default values for the remaining parameters. You can also customize the installation process to support advanced infrastructure scenarios. The installation program provisions the underlying infrastructure for the cluster.

You can install either a standard cluster or a customized cluster. With a standard cluster, you provide minimum details that are required to install the cluster. With a customized cluster, you can specify more details about the platform, such as the number of machines that the control plane uses, the type of virtual machine that the cluster deploys, or the CIDR range for the Kubernetes service network.

If possible, use this feature to avoid having to provision and maintain the cluster infrastructure. In all other environments, you use the installation program to generate the assets that you require to provision your cluster infrastructure.

With installer-provisioned infrastructure clusters, OpenShift Container Platform manages all aspects of the cluster, including the operating system itself. Each machine boots with a configuration that references resources hosted in the cluster that it joins. This configuration allows the cluster to manage itself as updates are applied.

### The installation process with user-provisioned infrastructure

You can also install OpenShift Container Platform on infrastructure that you provide. You use the installation program to generate the assets that you require to provision the cluster infrastructure, create the cluster infrastructure, and then deploy the cluster to the infrastructure that you provided.

If you do not use infrastructure that the installation program provisioned, you must manage and maintain the cluster resources yourself, including:

- The underlying infrastructure for the control plane and compute machines that make up the cluster
- Load balancers
- Cluster networking, including the DNS records and required subnets
- Storage for the cluster infrastructure and applications

If your cluster uses user-provisioned infrastructure, you have the option of adding RHEL compute machines to your cluster.

### Installation process details

Because each machine in the cluster requires information about the cluster when it is provisioned, OpenShift Container Platform uses a temporary *bootstrap* machine during initial configuration to provide the required information to the permanent control plane. It boots by using an Ignition config file that describes how to create the cluster. The bootstrap machine creates the control plane machines that make up the control plane. The control plane machines then create the compute machines, which are also known as worker machines. The following figure illustrates this process:

Figure 1.2. Creating the bootstrap, control plane, and compute machines

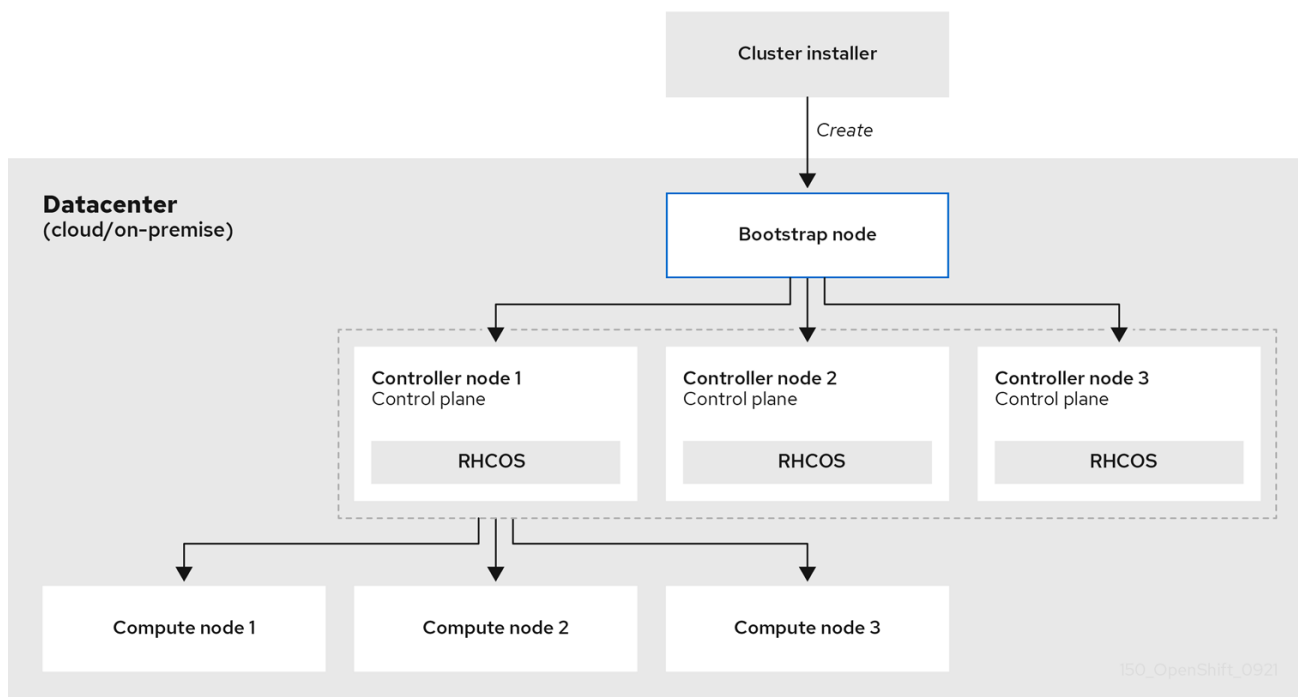

150\_OpenShift\_0921

After the cluster machines initialize, the bootstrap machine is destroyed. All clusters use the bootstrap process to initialize the cluster, but if you provision the infrastructure for your cluster, you must complete many of the steps manually.



## IMPORTANT

- The Ignition config files that the installation program generates contain certificates that expire after 24 hours, which are then renewed at that time. If the cluster is shut down before renewing the certificates and the cluster is later restarted after the 24 hours have elapsed, the cluster automatically recovers the expired certificates. The exception is that you must manually approve the pending **node-bootstrapper** certificate signing requests (CSRs) to recover kubelet certificates. See the documentation for *Recovering from expired control plane certificates* for more information.
- It is recommended that you use Ignition config files within 12 hours after they are generated because the 24-hour certificate rotates from 16 to 22 hours after the cluster is installed. By using the Ignition config files within 12 hours, you can avoid installation failure if the certificate update runs during installation.

Bootstrapping a cluster involves the following steps:

1. The bootstrap machine boots and starts hosting the remote resources required for the control plane machines to boot. (Requires manual intervention if you provision the infrastructure)
2. The bootstrap machine starts a single-node etcd cluster and a temporary Kubernetes control plane.
3. The control plane machines fetch the remote resources from the bootstrap machine and finish booting. (Requires manual intervention if you provision the infrastructure)
4. The temporary control plane schedules the production control plane to the production control plane machines.
5. The Cluster Version Operator (CVO) comes online and installs the etcd Operator. The etcd Operator scales up etcd on all control plane nodes.
6. The temporary control plane shuts down and passes control to the production control plane.
7. The bootstrap machine injects OpenShift Container Platform components into the production control plane.
8. The installation program shuts down the bootstrap machine. (Requires manual intervention if you provision the infrastructure)
9. The control plane sets up the compute nodes.
10. The control plane installs additional services in the form of a set of Operators.

The result of this bootstrapping process is a running OpenShift Container Platform cluster. The cluster then downloads and configures remaining components needed for the day-to-day operation, including the creation of compute machines in supported environments.

### 1.1.2. Verifying node state after installation

The OpenShift Container Platform installation completes when the following installation health checks are successful:

- The provisioner can access the OpenShift Container Platform web console.
- All control plane nodes are ready.
- All cluster Operators are available.



## NOTE

After the installation completes, the specific cluster Operators responsible for the worker nodes continuously attempt to provision all worker nodes. It can take some time before all worker nodes report as **READY**. For installations on bare metal, wait a minimum of 60 minutes before troubleshooting a worker node. For installations on all other platforms, wait a minimum of 40 minutes before troubleshooting a worker node. A **DEGRADED** state for the cluster Operators responsible for the worker nodes depends on the Operators' own resources and not on the state of the nodes.

After your installation completes, you can continue to monitor the condition of the nodes in your cluster by using the following steps.

## Prerequisites

- The installation program resolves successfully in the terminal.

## Procedure

1. Show the status of all worker nodes:

```
$ oc get nodes
```

### Example output

NAME	STATUS	ROLES	AGE	VERSION
example-compute1.example.com	Ready	worker	13m	v1.21.6+bb8d50a
example-compute2.example.com	Ready	worker	13m	v1.21.6+bb8d50a
example-compute4.example.com	Ready	worker	14m	v1.21.6+bb8d50a
example-control1.example.com	Ready	master	52m	v1.21.6+bb8d50a
example-control2.example.com	Ready	master	55m	v1.21.6+bb8d50a
example-control3.example.com	Ready	master	55m	v1.21.6+bb8d50a

2. Show the phase of all worker machine nodes:

```
$ oc get machines -A
```

### Example output

NAMESPACE	NAME	PHASE	TYPE	REGION	ZONE	AGE
openshift-machine-api	example-zbbt6-master-0	Running				95m
openshift-machine-api	example-zbbt6-master-1	Running				95m
openshift-machine-api	example-zbbt6-master-2	Running				95m
openshift-machine-api	example-zbbt6-worker-0-25bhp	Running				49m

openshift-machine-api	example-zbbt6-worker-0-8b4c2	Running	49m
openshift-machine-api	example-zbbt6-worker-0-jkbqt	Running	49m
openshift-machine-api	example-zbbt6-worker-0-qrl5b	Running	49m

### Additional resources

- [Getting the BareMetalHost resource](#)
- [Following the installation](#)
- [Validating an installation](#)

### Installation scope

The scope of the OpenShift Container Platform installation program is intentionally narrow. It is designed for simplicity and ensured success. You can complete many more configuration tasks after installation completes.

### Additional resources

- See [Available cluster customizations](#) for details about OpenShift Container Platform configuration resources.

## 1.1.3. OpenShift Local overview

OpenShift Local supports rapid application development to get started building OpenShift Container Platform clusters. OpenShift Local is designed to run on a local computer to simplify setup and testing, and to emulate the cloud development environment locally with all of the tools needed to develop container-based applications.

Regardless of the programming language you use, OpenShift Local hosts your application and brings a minimal, preconfigured Red Hat OpenShift Container Platform cluster to your local PC without the need for a server-based infrastructure.

On a hosted environment, OpenShift Local can create microservices, convert them into images, and run them in Kubernetes-hosted containers directly on your laptop or desktop running Linux, macOS, or Windows 10 or later.

For more information about OpenShift Local, see [Red Hat OpenShift Local Overview](#).

## 1.2. SUPPORTED PLATFORMS FOR OPENSIFT CONTAINER PLATFORM CLUSTERS

In OpenShift Container Platform 4.10, you can install a cluster that uses installer-provisioned infrastructure on the following platforms:

- Amazon Web Services (AWS)
- Google Cloud Platform (GCP)
- Microsoft Azure
- Microsoft Azure Stack Hub
- Red Hat OpenStack Platform (RHOSP) versions 16.1 and 16.2

- The latest OpenShift Container Platform release supports both the latest RHOSP long-life release and intermediate release. For complete RHOSP release compatibility, see the [OpenShift Container Platform on RHOSP support matrix](#).
- IBM Cloud VPC
- Red Hat Virtualization (RHV)
- VMware vSphere
- VMware Cloud (VMC) on AWS
- Alibaba Cloud
- Bare metal

For these clusters, all machines, including the computer that you run the installation process on, must have direct internet access to pull images for platform containers and provide telemetry data to Red Hat.

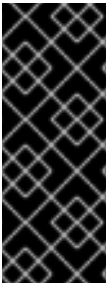

### IMPORTANT

After installation, the following changes are not supported:

- Mixing cloud provider platforms
- Mixing cloud provider components, such as using a persistent storage framework from a differing platform than what the cluster is installed on

In OpenShift Container Platform 4.10, you can install a cluster that uses user-provisioned infrastructure on the following platforms:

- AWS
- Azure
- Azure Stack Hub
- GCP
- RHOSP versions 16.1 and 16.2
- RHV
- VMware vSphere
- VMware Cloud on AWS
- Bare metal
- IBM Z or LinuxONE
- IBM Power

Depending on the supported cases for the platform, installations on user-provisioned infrastructure allow you to run machines with full internet access, place your cluster behind a proxy, or perform a *restricted network installation*. In a restricted network installation, you can download the images that are

required to install a cluster, place them in a mirror registry, and use that data to install your cluster. While you require internet access to pull images for platform containers, with a restricted network installation on vSphere or bare metal infrastructure, your cluster machines do not require direct internet access.

The [OpenShift Container Platform 4.x Tested Integrations](#) page contains details about integration testing for different platforms.

### Additional resources

- See [Supported installation methods for different platforms](#) for more information about the types of installations that are available for each supported platform.
- See [Selecting a cluster installation method and preparing it for users](#) for information about choosing an installation method and preparing the required resources.



## CHAPTER 2. SELECTING A CLUSTER INSTALLATION METHOD AND PREPARING IT FOR USERS

Before you install OpenShift Container Platform, decide what kind of installation process to follow and make sure you that you have all of the required resources to prepare the cluster for users.

### 2.1. SELECTING A CLUSTER INSTALLATION TYPE

Before you install an OpenShift Container Platform cluster, you need to select the best installation instructions to follow. Think about your answers to the following questions to select the best option.

#### 2.1.1. Do you want to install and manage an OpenShift Container Platform cluster yourself?

If you want to install and manage OpenShift Container Platform yourself, you can install it on the following platforms:

- Alibaba Cloud
- Amazon Web Services (AWS) on 64-bit x86 instances
- Amazon Web Services (AWS) on 64-bit ARM instances
- Microsoft Azure
- Microsoft Azure Stack Hub
- Google Cloud Platform (GCP)
- Red Hat OpenStack Platform (RHOSP)
- Red Hat Virtualization (RHV)
- IBM Cloud VPC
- IBM Z and LinuxONE
- IBM Z and LinuxONE for Red Hat Enterprise Linux (RHEL) KVM
- IBM Power
- VMware vSphere
- VMware Cloud (VMC) on AWS
- Bare metal or other platform agnostic infrastructure

You can deploy an OpenShift Container Platform 4 cluster to both on-premise hardware and to cloud hosting services, but all of the machines in a cluster must be in the same datacenter or cloud hosting service.

If you want to use OpenShift Container Platform but do not want to manage the cluster yourself, you have several managed service options. If you want a cluster that is fully managed by Red Hat, you can use [OpenShift Dedicated](#) or [OpenShift Online](#). You can also use OpenShift as a managed service on Azure,

AWS, IBM Cloud VPC, or Google Cloud. For more information about managed services, see the [OpenShift Products](#) page. If you install an OpenShift Container Platform cluster with a cloud virtual machine as a virtual bare metal, the corresponding cloud-based storage is not supported.

### 2.1.2. Have you used OpenShift Container Platform 3 and want to use OpenShift Container Platform 4?

If you used OpenShift Container Platform 3 and want to try OpenShift Container Platform 4, you need to understand how different OpenShift Container Platform 4 is. OpenShift Container Platform 4 weaves the Operators that package, deploy, and manage Kubernetes applications and the operating system that the platform runs on, Red Hat Enterprise Linux CoreOS (RHCOS), together seamlessly. Instead of deploying machines and configuring their operating systems so that you can install OpenShift Container Platform on them, the RHCOS operating system is an integral part of the OpenShift Container Platform cluster. Deploying the operating system for the cluster machines as part of the installation process for OpenShift Container Platform. See [Differences between OpenShift Container Platform 3 and 4](#).

Because you need to provision machines as part of the OpenShift Container Platform cluster installation process, you cannot upgrade an OpenShift Container Platform 3 cluster to OpenShift Container Platform 4. Instead, you must create a new OpenShift Container Platform 4 cluster and migrate your OpenShift Container Platform 3 workloads to them. For more information about migrating, see [Migrating from OpenShift Container Platform 3 to 4 overview](#). Because you must migrate to OpenShift Container Platform 4, you can use any type of production cluster installation process to create your new cluster.

### 2.1.3. Do you want to use existing components in your cluster?

Because the operating system is integral to OpenShift Container Platform, it is easier to let the installation program for OpenShift Container Platform stand up all of the infrastructure. These are called *installer provisioned infrastructure* installations. In this type of installation, you can provide some existing infrastructure to the cluster, but the installation program deploys all of the machines that your cluster initially needs.

You can deploy an installer-provisioned infrastructure cluster without specifying any customizations to the cluster or its underlying machines to [Alibaba Cloud](#), [AWS](#), [Azure](#), [Azure Stack Hub](#), [GCP](#), or [VMC on AWS](#). These installation methods are the fastest way to deploy a production-capable OpenShift Container Platform cluster.

If you need to perform basic configuration for your installer-provisioned infrastructure cluster, such as the instance type for the cluster machines, you can customize an installation for [Alibaba Cloud](#), [AWS](#), [Azure](#), [GCP](#), or [VMC on AWS](#).

For installer-provisioned infrastructure installations, you can use an existing [VPC in AWS](#), [vNet in Azure](#), or [VPC in GCP](#). You can also reuse part of your networking infrastructure so that your cluster in [AWS](#), [Azure](#), [GCP](#), or [VMC on AWS](#) can coexist with existing IP address allocations in your environment and integrate with existing MTU and VXLAN configurations. If you have existing accounts and credentials on these clouds, you can re-use them, but you might need to modify the accounts to have the required permissions to install OpenShift Container Platform clusters on them.

You can use the installer-provisioned infrastructure method to create appropriate machine instances on your hardware for [RHOSP](#), [RHOSP with Kuryr](#), [RHOSP on SR-IOV](#), [RHV](#), [vSphere](#), and [bare metal](#). Additionally, for [vSphere](#), [VMC on AWS](#), you can also customize additional network parameters during installation.

If you want to reuse extensive cloud infrastructure, you can complete a *user-provisioned infrastructure* installation. With these installations, you manually deploy the machines that your cluster requires during the installation process. If you perform a user-provisioned infrastructure installation on [AWS](#), [Azure](#),

[Azure Stack Hub](#), [GCP](#), or [VMC on AWS](#), you can use the provided templates to help you stand up all of the required components. You can also reuse a shared [VPC on GCP](#). Otherwise, you can use the [provider-agnostic](#) installation method to deploy a cluster into other clouds.

You can also complete a user-provisioned infrastructure installation on your existing hardware. If you use [RHOSP](#), [RHOSP on SR-IOV](#), [RHV](#), [IBM Z or LinuxONE](#), [IBM Z or LinuxONE with RHEL KVM](#), [IBM Power](#), or [vSphere](#), use the specific installation instructions to deploy your cluster. If you use other supported hardware, follow the [bare metal installation](#) procedure. For some of these platforms, such as [RHOSP](#), [vSphere](#), [VMC on AWS](#), and [bare metal](#), you can also customize additional network parameters during installation.

### 2.1.4. Do you need extra security for your cluster?

If you use a user-provisioned installation method, you can configure a proxy for your cluster. The instructions are included in each installation procedure.

If you want to prevent your cluster on a public cloud from exposing endpoints externally, you can deploy a private cluster with installer-provisioned infrastructure on [AWS](#), [Azure](#), or [GCP](#).

If you need to install your cluster that has limited access to the internet, such as a disconnected or restricted network cluster, you can [mirror the installation packages](#) and install the cluster from them. Follow detailed instructions for user provisioned infrastructure installations into restricted networks for [AWS](#), [GCP](#), [IBM Z or LinuxONE](#), [IBM Z or LinuxONE with RHEL KVM](#), [IBM Power](#), [vSphere](#), [VMC on AWS](#), or [bare metal](#). You can also install a cluster into a restricted network using installer-provisioned infrastructure by following detailed instructions for [AWS](#), [GCP](#), [VMC on AWS](#), [RHOSP](#), [RHV](#), and [vSphere](#).

If you need to deploy your cluster to an [AWS GovCloud region](#), [AWS China region](#), or [Azure government region](#), you can configure those custom regions during an installer-provisioned infrastructure installation.

You can also configure the cluster machines to use [FIPS Validated / Modules in Process cryptographic libraries](#) during installation.

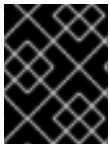

#### IMPORTANT

The use of FIPS Validated / Modules in Process cryptographic libraries is only supported on OpenShift Container Platform deployments on the **x86\_64** architecture.

## 2.2. PREPARING YOUR CLUSTER FOR USERS AFTER INSTALLATION

Some configuration is not required to install the cluster but recommended before your users access the cluster. You can customize the cluster itself by [customizing](#) the Operators that make up your cluster and integrate your cluster with other required systems, such as an identity provider.

For a production cluster, you must configure the following integrations:

- [Persistent storage](#)
- [An identity provider](#)
- [Monitoring core OpenShift Container Platform components](#)

## 2.3. PREPARING YOUR CLUSTER FOR WORKLOADS

Depending on your workload needs, you might need to take extra steps before you begin deploying applications. For example, after you prepare infrastructure to support your application [build strategy](#), you might need to make provisions for [low-latency](#) workloads or to [protect sensitive workloads](#). You can also configure [monitoring](#) for application workloads.

If you plan to run [Windows workloads](#), you must enable [hybrid networking with OVN-Kubernetes](#) during the installation process; hybrid networking cannot be enabled after your cluster is installed.

## 2.4. SUPPORTED INSTALLATION METHODS FOR DIFFERENT PLATFORMS

You can perform different types of installations on different platforms.

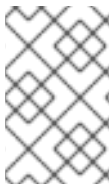

### NOTE

Not all installation options are supported for all platforms, as shown in the following tables. A checkmark indicates that the option is supported and links to the relevant section.

Table 2.1. Installer-provisioned infrastructure options

	Alibaba	AWS (64-bit x86_64)	AWS (ARM)	Azure	Azure Stack Hub	Google Cloud Platform	RHEL OS P	RHEL OS P SR - IOV	RHEL V	Baremetal	vSphere	VMC	IBM Cloud VPC	IBM Z	IBM Power
Default	✓	✓	✓	✓	✓	✓			✓	✓	✓	✓	✓		
Custom	✓	✓	✓	✓	✓	✓	✓	✓	✓		✓	✓	✓		
Network customization	✓	✓	✓	✓	✓	✓	✓				✓	✓	✓		

	Alibaba	AWS (64-bit x86)	AWS (64-bit ARM)	Azure	Azure Stack Hub	GC P	RH OS P	RH OS P on SR - IO V	RH V	Barometal	vSphere	VMC	IBM Cloud VP C	IBM Z	IBM Power
Restricted network		✓				✓	✓		✓	✓	✓	✓			
Private clusters		✓	✓	✓		✓									
Existing virtual private networks		✓	✓	✓		✓									
Government regions		✓		✓											
Secret regions		✓													

	Alibaba	AWS (64-bit x86)	AWS (64-bit ARM)	Azure	Azure Stack Hub	GC P	RH OS P	RH OS P on SR - IO V	RH V	Barometal	vSphere	VMC	IBM Cloud VPC	IBM Z	IBM Power
China regions		✓													

Table 2.2. User-provisioned infrastructure options

	Alibaba	AWS	Azure	Azure Stack Hub	GC P	RHO S P	RHO S P on SR - IO V	RHO V	Barometal (64-bit x86)	Barometal (64-bit ARM)	vSphere	VMC	IBM Cloud VPC	IBM Z	IBM Z with RHEL VM	IBM Power	Platform agnostic
Custom	✓	✓	✓	✓	✓	✓	✓	✓	✓	✓	✓	✓		✓	✓	✓	✓
Network customization						✓			✓	✓	✓	✓					

	Alibaba	AWS	Azure	Azure Stack Hub	Google Cloud Platform	RHOSSP	RHOSSPONSR-IOV	RHOV	Baremetal (64-bit x86)	Baremetal (64-bit ARM)	vSphere	VMC	IBM Cloud VPC	IBM Z	IBM Z with RHEL KVM	IBM Power	Platform agnostic
Restricted network		✓			✓			✓	✓		✓	✓		✓	✓	✓	
Shared VPC hosted outside of cluster project					✓												

## CHAPTER 3. DISCONNECTED INSTALLATION MIRRORING

### 3.1. ABOUT DISCONNECTED INSTALLATION MIRRORING

You can use a mirror registry to ensure that your clusters only use container images that satisfy your organizational controls on external content. Before you install a cluster on infrastructure that you provision in a restricted network, you must mirror the required container images into that environment. To mirror container images, you must have a registry for mirroring.

#### 3.1.1. Creating a mirror registry

If you already have a container image registry, such as Red Hat Quay, you can use it as your mirror registry. If you do not already have a registry, you can [create a mirror registry using the \*mirror registry for Red Hat OpenShift\*](#).

#### 3.1.2. Mirroring images for a disconnected installation

You can use one of the following procedures to mirror your OpenShift Container Platform image repository to your mirror registry:

- [Mirroring images for a disconnected installation](#)
- [Mirroring images for a disconnected installation using the \*oc-mirror\* plugin](#) (Technology Preview)

### 3.2. CREATING A MIRROR REGISTRY WITH MIRROR REGISTRY FOR RED HAT OPENSIFT

The *mirror registry for Red Hat OpenShift* is a small and streamlined container registry that you can use as a target for mirroring the required container images of OpenShift Container Platform for disconnected installations.

If you already have a container image registry, such as Red Hat Quay, you can skip this section and go straight to [Mirroring the OpenShift Container Platform image repository](#).

#### 3.2.1. Prerequisites

- An OpenShift Container Platform subscription.
- Red Hat Enterprise Linux (RHEL) 8 and 9 with Podman 3.3 and OpenSSL installed.
- Fully qualified domain name for the Red Hat Quay service, which must resolve through a DNS server.
- Key-based SSH connectivity on the target host. SSH keys are automatically generated for local installs. For remote hosts, you must generate your own SSH keys.
- 2 or more vCPUs.
- 8 GB of RAM.
- About 12 GB for OpenShift Container Platform 4.10 release images, or about 358 GB for OpenShift Container Platform 4.10 release images and OpenShift Container Platform 4.10 Red Hat Operator images. Up to 1 TB per stream or more is suggested.





## IMPORTANT

These requirements are based on local testing results with only release images and Operator images. Storage requirements can vary based on your organization's needs. You might require more space, for example, when you mirror multiple z-streams. You can use standard [Red Hat Quay functionality](#) or the proper [API callout](#) to remove unnecessary images and free up space.

### 3.2.2. Mirror registry for Red Hat OpenShift introduction

For disconnected deployments of OpenShift Container Platform, a container registry is required to carry out the installation of the clusters. To run a production-grade registry service on such a cluster, you must create a separate registry deployment to install the first cluster. The *mirror registry for Red Hat OpenShift* addresses this need and is included in every OpenShift subscription. It is available for download on the [OpenShift console Downloads](#) page.

The *mirror registry for Red Hat OpenShift* allows users to install a small-scale version of Red Hat Quay and its required components using the **mirror-registry** command line interface (CLI) tool. The *mirror registry for Red Hat OpenShift* is deployed automatically with pre-configured local storage and a local database. It also includes auto-generated user credentials and access permissions with a single set of inputs and no additional configuration choices to get started.

The *mirror registry for Red Hat OpenShift* provides a pre-determined network configuration and reports deployed component credentials and access URLs upon success. A limited set of optional configuration inputs like fully qualified domain name (FQDN) services, superuser name and password, and custom TLS certificates are also provided. This provides users with a container registry so that they can easily create an offline mirror of all OpenShift Container Platform release content when running OpenShift Container Platform in restricted network environments.

The *mirror registry for Red Hat OpenShift* is limited to hosting images that are required to install a disconnected OpenShift Container Platform cluster, such as Release images or Red Hat Operator images. It uses local storage on your Red Hat Enterprise Linux (RHEL) machine, and storage supported by RHEL is supported by the *mirror registry for Red Hat OpenShift*. Content built by customers should not be hosted by the *mirror registry for Red Hat OpenShift*.

Unlike Red Hat Quay, the *mirror registry for Red Hat OpenShift* is not a highly-available registry and only local file system storage is supported. Using the *mirror registry for Red Hat OpenShift* with more than one cluster is discouraged, because multiple clusters can create a single point of failure when updating your cluster fleet. It is advised to leverage the *mirror registry for Red Hat OpenShift* to install a cluster that can host a production-grade, highly-available registry such as Red Hat Quay, which can serve OpenShift Container Platform content to other clusters.

Use of the *mirror registry for Red Hat OpenShift* is optional if another container registry is already available in the install environment.

### 3.2.3. Mirroring on a local host with mirror registry for Red Hat OpenShift

This procedure explains how to install the *mirror registry for Red Hat OpenShift* on a local host using the **mirror-registry** installer tool. By doing so, users can create a local host registry running on port 443 for the purpose of storing a mirror of OpenShift Container Platform images.

**NOTE**

Installing the *mirror registry for Red Hat OpenShift* using the **mirror-registry** CLI tool makes several changes to your machine. After installation, a **\$HOME/quay-install** directory is created, which has installation files, local storage, and the configuration bundle. Trusted SSH keys are generated in case the deployment target is the local host, and systemd files on the host machine are set up to ensure that container runtimes are persistent. Additionally, an initial user named **init** is created with an automatically generated password. All access credentials are printed at the end of the install routine.

**Procedure**

1. Download the **mirror-registry.tar.gz** package for the latest version of the *mirror registry for Red Hat OpenShift* found on the [OpenShift console Downloads](#) page.
2. Install the *mirror registry for Red Hat OpenShift* on your local host with your current user account by using the **mirror-registry** tool. For a full list of available flags, see "mirror registry for Red Hat OpenShift flags".

```
$ ./mirror-registry install \
  --quayHostname <host_example_com> \
  --quayRoot <example_directory_name>
```

3. Use the user name and password generated during installation to log into the registry by running the following command:

```
$ podman login -u init \
  -p <password> \
  <host_example_com>:8443> \
  --tls-verify=false 1
```

- 1 You can avoid running **--tls-verify=false** by configuring your system to trust the generated rootCA certificates. See "Using SSL to protect connections to Red Hat Quay" and "Configuring the system to trust the certificate authority" for more information.

**NOTE**

You can also log in by accessing the UI at **https://<host.example.com>:8443** after installation.

4. You can mirror OpenShift Container Platform images after logging in. Depending on your needs, see either the "Mirroring the OpenShift Container Platform image repository" or the "Mirroring Operator catalogs for use with disconnected clusters" sections of this document.

**NOTE**

If there are issues with images stored by the *mirror registry for Red Hat OpenShift* due to storage layer problems, you can remirror the OpenShift Container Platform images, or reinstall mirror registry on more stable storage.

**3.2.4. Updating mirror registry for Red Hat OpenShift from a local host**

This procedure explains how to update the *mirror registry for Red Hat OpenShift* from a local host using the **upgrade** command. Updating to the latest version ensures new features, bug fixes, and security vulnerability fixes.



## IMPORTANT

When updating, there is intermittent downtime of your mirror registry, as it is restarted during the update process.

### Prerequisites

- You have installed the *mirror registry for Red Hat OpenShift* on a local host.

### Procedure

- If you are upgrading the *mirror registry for Red Hat OpenShift* from 1.2.z → 1.3.0, and your installation directory is the default at **/etc/quay-install**, you can enter the following command:

```
$ sudo ./mirror-registry upgrade -v
```



## NOTE

- *mirror registry for Red Hat OpenShift* migrates Podman volumes for Quay storage, Postgres data, and **/etc/quay-install** data to the new **\$HOME/quay-install** location. This allows you to use *mirror registry for Red Hat OpenShift* without the **--quayRoot** flag during future upgrades.
- Users who upgrade *mirror registry for Red Hat OpenShift* with the **./mirror-registry upgrade -v** flag must include the same credentials used when creating their mirror registry. For example, if you installed the *mirror registry for Red Hat OpenShift* with **--quayHostname <host\_example\_com>** and **--quayRoot <example\_directory\_name>**, you must include that string to properly upgrade the mirror registry.
- If you are upgrading the *mirror registry for Red Hat OpenShift* from 1.2.z → 1.3.0 and you used a specified directory in your 1.2.z deployment, you must pass in the new **--pgStorage** and **--quayStorage** flags. For example:

```
$ sudo ./mirror-registry upgrade --quayHostname <host_example_com> --quayRoot
<example_directory_name> --pgStorage <example_directory_name>/pg-data --quayStorage
<example_directory_name>/quay-storage -v
```

### 3.2.5. Mirroring on a remote host with mirror registry for Red Hat OpenShift

This procedure explains how to install the *mirror registry for Red Hat OpenShift* on a remote host using the **mirror-registry** tool. By doing so, users can create a registry to hold a mirror of OpenShift Container Platform images.

**NOTE**

Installing the *mirror registry for Red Hat OpenShift* using the **mirror-registry** CLI tool makes several changes to your machine. After installation, a **\$HOME/quay-install** directory is created, which has installation files, local storage, and the configuration bundle. Trusted SSH keys are generated in case the deployment target is the local host, and systemd files on the host machine are set up to ensure that container runtimes are persistent. Additionally, an initial user named **init** is created with an automatically generated password. All access credentials are printed at the end of the install routine.

**Procedure**

1. Download the **mirror-registry.tar.gz** package for the latest version of the *mirror registry for Red Hat OpenShift* found on the [OpenShift console Downloads](#) page.
2. Install the *mirror registry for Red Hat OpenShift* on your local host with your current user account by using the **mirror-registry** tool. For a full list of available flags, see "mirror registry for Red Hat OpenShift flags".

```
$ ./mirror-registry install -v \
  --targetHostname <host_example_com> \
  --targetUsername <example_user> \
  -k ~/.ssh/my_ssh_key \
  --quayHostname <host_example_com> \
  --quayRoot <example_directory_name>
```

3. Use the user name and password generated during installation to log into the mirror registry by running the following command:

```
$ podman login -u init \
  -p <password> \
  <host_example_com>:8443 \
  --tls-verify=false 1
```

- 1** You can avoid running **--tls-verify=false** by configuring your system to trust the generated rootCA certificates. See "Using SSL to protect connections to Red Hat Quay" and "Configuring the system to trust the certificate authority" for more information.

**NOTE**

You can also log in by accessing the UI at **https://<host.example.com>:8443** after installation.

4. You can mirror OpenShift Container Platform images after logging in. Depending on your needs, see either the "Mirroring the OpenShift Container Platform image repository" or the "Mirroring Operator catalogs for use with disconnected clusters" sections of this document.

**NOTE**

If there are issues with images stored by the *mirror registry for Red Hat OpenShift* due to storage layer problems, you can remirror the OpenShift Container Platform images, or reinstall mirror registry on more stable storage.

### 3.2.6. Updating mirror registry for Red Hat OpenShift from a remote host

This procedure explains how to update the *mirror registry for Red Hat OpenShift* from a remote host using the **upgrade** command. Updating to the latest version ensures bug fixes and security vulnerability fixes.



#### IMPORTANT

When updating, there is intermittent downtime of your mirror registry, as it is restarted during the update process.

#### Prerequisites

- You have installed the *mirror registry for Red Hat OpenShift* on a remote host.

#### Procedure

- To upgrade the *mirror registry for Red Hat OpenShift* from a remote host, enter the following command:

```
$ ./mirror-registry upgrade -v --targetHostname <remote_host_url> --targetUsername
<user_name> -k ~/.ssh/my_ssh_key
```



#### NOTE

Users who upgrade the *mirror registry for Red Hat OpenShift* with the **./mirror-registry upgrade -v** flag must include the same credentials used when creating their mirror registry. For example, if you installed the *mirror registry for Red Hat OpenShift* with **--quayHostname <host\_example\_com>** and **--quayRoot <example\_directory\_name>**, you must include that string to properly upgrade the mirror registry.

### 3.2.7. Uninstalling the mirror registry for Red Hat OpenShift

- You can uninstall the *mirror registry for Red Hat OpenShift* from your local host by running the following command:

```
$ ./mirror-registry uninstall -v \
--quayRoot <example_directory_name>
```



#### NOTE

- Deleting the *mirror registry for Red Hat OpenShift* will prompt the user before deletion. You can use **--autoApprove** to skip this prompt.
- Users who install the *mirror registry for Red Hat OpenShift* with the **--quayRoot** flag must include the **--quayRoot** flag when uninstalling. For example, if you installed the *mirror registry for Red Hat OpenShift* with **--quayRoot example\_directory\_name**, you must include that string to properly uninstall the mirror registry.

### 3.2.8. Mirror registry for Red Hat OpenShift flags

The following flags are available for the *mirror registry for Red Hat OpenShift*:

Flags	Description
<b>--autoApprove</b>	A boolean value that disables interactive prompts. If set to <b>true</b> , the <b>quayRoot</b> directory is automatically deleted when uninstalling the mirror registry. Defaults to <b>false</b> if left unspecified.
<b>--initPassword</b>	The password of the init user created during Quay installation. Must be at least eight characters and contain no whitespace.
<b>--initUser string</b>	Shows the username of the initial user. Defaults to <b>init</b> if left unspecified.
<b>--no-color, -c</b>	Allows users to disable color sequences and propagate that to Ansible when running install, uninstall, and upgrade commands.
<b>--pgStorage</b>	The folder where Postgres persistent storage data is saved. Defaults to the <b>pg-storage</b> Podman volume. Root privileges are required to uninstall.
<b>--quayHostname</b>	The fully-qualified domain name of the mirror registry that clients will use to contact the registry. Equivalent to <b>SERVER_HOSTNAME</b> in the Quay <b>config.yaml</b> . Must resolve by DNS. Defaults to <b>&lt;targetHostname&gt;:8443</b> if left unspecified. <sup>[1]</sup>
<b>--quayStorage</b>	The folder where Quay persistent storage data is saved. Defaults to the <b>quay-storage</b> Podman volume. Root privileges are required to uninstall.
<b>--quayRoot, -r</b>	The directory where container image layer and configuration data is saved, including <b>rootCA.key</b> , <b>rootCA.pem</b> , and <b>rootCA.srl</b> certificates. Defaults to <b>\$HOME/quay-install</b> if left unspecified.
<b>--ssh-key, -k</b>	The path of your SSH identity key. Defaults to <b>~/.ssh/quay_installer</b> if left unspecified.
<b>--sslCert</b>	The path to the SSL/TLS public key / certificate. Defaults to <b>{quayRoot}/quay-config</b> and is auto-generated if left unspecified.
<b>--sslCheckSkip</b>	Skips the check for the certificate hostname against the <b>SERVER_HOSTNAME</b> in the <b>config.yaml</b> file. <sup>[2]</sup>
<b>--sslKey</b>	The path to the SSL/TLS private key used for HTTPS communication. Defaults to <b>{quayRoot}/quay-config</b> and is auto-generated if left unspecified.
<b>--targetHostname, -H</b>	The hostname of the target you want to install Quay to. Defaults to <b>\$HOST</b> , for example, a local host, if left unspecified.
<b>--targetUsername, -u</b>	The user on the target host which will be used for SSH. Defaults to <b>\$USER</b> , for example, the current user if left unspecified.

Flags	Description
<b>--verbose, -v</b>	Shows debug logs and Ansible playbook outputs.
<b>--version</b>	Shows the version for the <i>mirror registry for Red Hat OpenShift</i>

1. **--quayHostname** must be modified if the public DNS name of your system is different from the local hostname. Additionally, the **--quayHostname** flag does not support installation with an IP address. Installation with a hostname is required.
2. **--sslCheckSkip** is used in cases when the mirror registry is set behind a proxy and the exposed hostname is different from the internal Quay hostname. It can also be used when users do not want the certificates to be validated against the provided Quay hostname during installation.

### 3.2.9. Mirror registry for Red Hat OpenShift release notes

The *mirror registry for Red Hat OpenShift* is a small and streamlined container registry that you can use as a target for mirroring the required container images of OpenShift Container Platform for disconnected installations.

These release notes track the development of the *mirror registry for Red Hat OpenShift* in OpenShift Container Platform.

For an overview of the *mirror registry for Red Hat OpenShift*, see [Creating a mirror registry with mirror registry for Red Hat OpenShift](#).

#### 3.2.9.1. Mirror registry for Red Hat OpenShift 1.3.8

Issued: 2023-08-16

*Mirror registry for Red Hat OpenShift* is now available with Red Hat Quay 3.8.11.

The following advisory is available for the *mirror registry for Red Hat OpenShift*:

- [RHBA-2023:4622 - mirror registry for Red Hat OpenShift 1.3.8](#)

#### 3.2.9.2. Mirror registry for Red Hat OpenShift 1.3.7

Issued: 2023-07-19

*Mirror registry for Red Hat OpenShift* is now available with Red Hat Quay 3.8.10.

The following advisory is available for the *mirror registry for Red Hat OpenShift*:

- [RHBA-2023:4087 - mirror registry for Red Hat OpenShift 1.3.7](#)

#### 3.2.9.3. Mirror registry for Red Hat OpenShift 1.3.6

Issued: 2023-05-30

*Mirror registry for Red Hat OpenShift* is now available with Red Hat Quay 3.8.8.

The following advisory is available for the *mirror registry for Red Hat OpenShift*:

- [RHBA-2023:3302 - mirror registry for Red Hat OpenShift 1.3.6](#)

#### 3.2.9.4. Mirror registry for Red Hat OpenShift 1.3.5

Issued: 2023-05-18

*Mirror registry for Red Hat OpenShift* is now available with Red Hat Quay 3.8.7.

The following advisory is available for the *mirror registry for Red Hat OpenShift*:

- [RHBA-2023:3225 - mirror registry for Red Hat OpenShift 1.3.5](#)

#### 3.2.9.5. Mirror registry for Red Hat OpenShift 1.3.4

Issued: 2023-04-25

*Mirror registry for Red Hat OpenShift* is now available with Red Hat Quay 3.8.6.

The following advisory is available for the *mirror registry for Red Hat OpenShift*:

- [RHBA-2023:1914 - mirror registry for Red Hat OpenShift 1.3.4](#)

#### 3.2.9.6. Mirror registry for Red Hat OpenShift 1.3.3

Issued: 2023-04-05

*Mirror registry for Red Hat OpenShift* is now available with Red Hat Quay 3.8.5.

The following advisory is available for the *mirror registry for Red Hat OpenShift*:

- [RHBA-2023:1528 - mirror registry for Red Hat OpenShift 1.3.3](#)

#### 3.2.9.7. Mirror registry for Red Hat OpenShift 1.3.2

Issued: 2023-03-21

*Mirror registry for Red Hat OpenShift* is now available with Red Hat Quay 3.8.4.

The following advisory is available for the *mirror registry for Red Hat OpenShift*:

- [RHBA-2023:1376 - mirror registry for Red Hat OpenShift 1.3.2](#)

#### 3.2.9.8. Mirror registry for Red Hat OpenShift 1.3.1

Issued: 2023-03-7

*Mirror registry for Red Hat OpenShift* is now available with Red Hat Quay 3.8.3.

The following advisory is available for the *mirror registry for Red Hat OpenShift*:

- [RHBA-2023:1086 - mirror registry for Red Hat OpenShift 1.3.1](#)

#### 3.2.9.9. Mirror registry for Red Hat OpenShift 1.3.0

Issued: 2023-02-20



*Mirror registry for Red Hat OpenShift* is now available with Red Hat Quay 3.8.1.

The following advisory is available for the *mirror registry for Red Hat OpenShift*:

- [RHBA-2023:0558 - mirror registry for Red Hat OpenShift 1.3.0](#)

### 3.2.9.9.1. New features

- *Mirror registry for Red Hat OpenShift* is now supported on Red Hat Enterprise Linux (RHEL) 9 installations.
- IPv6 support is now available on *mirror registry for Red Hat OpenShift* local host installations. IPv6 is currently unsupported on *mirror registry for Red Hat OpenShift* remote host installations.
- A new feature flag, **--quayStorage**, has been added. With this flag, users with root privileges can manually set the location of their Quay persistent storage.
- A new feature flag, **--pgStorage**, has been added. With this flag, users with root privileges can manually set the location of their Postgres persistent storage.
- Previously, users were required to have root privileges (**sudo**) to install *mirror registry for Red Hat OpenShift*. With this update, **sudo** is no longer required to install *mirror registry for Red Hat OpenShift*.

When *mirror registry for Red Hat OpenShift* was installed with **sudo**, an `/etc/quay-install` directory that contained installation files, local storage, and the configuration bundle was created. With the removal of the **sudo** requirement, installation files and the configuration bundle are now installed to `$HOME/quay-install`. Local storage, for example Postgres and Quay, are now stored in named volumes automatically created by Podman.

To override the default directories that these files are stored in, you can use the command line arguments for *mirror registry for Red Hat OpenShift*. For more information about *mirror registry for Red Hat OpenShift* command line arguments, see "*Mirror registry for Red Hat OpenShift flags*".

### 3.2.9.9.2. Bug fixes

- Previously, the following error could be returned when attempting to uninstall *mirror registry for Red Hat OpenShift*: `["Error: no container with name or ID \"quay-postgres\" found: no such container"], "stdout": "", "stdout_lines": []`. With this update, the order that *mirror registry for Red Hat OpenShift* services are stopped and uninstalled have been changed so that the error no longer occurs when uninstalling *mirror registry for Red Hat OpenShift*. For more information, see [PROJQUAY-4629](#).

### 3.2.9.10. Mirror registry for Red Hat OpenShift 1.2.9

*Mirror registry for Red Hat OpenShift* is now available with Red Hat Quay 3.7.10.

The following advisory is available for the *mirror registry for Red Hat OpenShift*:

- [RHBA-2022:7369 - mirror registry for Red Hat OpenShift 1.2.9](#)

### 3.2.9.11. Mirror registry for Red Hat OpenShift 1.2.8

*Mirror registry for Red Hat OpenShift* is now available with Red Hat Quay 3.7.9.

The following advisory is available for the *mirror registry for Red Hat OpenShift*:

- [RHBA-2022:7065 - mirror registry for Red Hat OpenShift 1.2.8](#)

### 3.2.9.12. Mirror registry for Red Hat OpenShift 1.2.7

*Mirror registry for Red Hat OpenShift* is now available with Red Hat Quay 3.7.8.

The following advisory is available for the *mirror registry for Red Hat OpenShift*:

- [RHBA-2022:6500 - mirror registry for Red Hat OpenShift 1.2.7](#)

#### 3.2.9.12.1. Bug fixes

- Previously, **getFQDN()** relied on the fully-qualified domain name (FQDN) library to determine its FQDN, and the FQDN library tried to read the **/etc/hosts** folder directly. Consequently, on some Red Hat Enterprise Linux CoreOS (RHCOS) installations with uncommon DNS configurations, the FQDN library would fail to install and abort the installation. With this update, *mirror registry for Red Hat OpenShift* uses **hostname** to determine the FQDN. As a result, the FQDN library does not fail to install. ([PROJQUAY-4139](#))

### 3.2.9.13. Mirror registry for Red Hat OpenShift 1.2.6

*Mirror registry for Red Hat OpenShift* is now available with Red Hat Quay 3.7.7.

The following advisory is available for the *mirror registry for Red Hat OpenShift*:

- [RHBA-2022:6278 - mirror registry for Red Hat OpenShift 1.2.6](#)

#### 3.2.9.13.1. New features

A new feature flag, **--no-color (-c)** has been added. This feature flag allows users to disable color sequences and propagate that to Ansible when running `install`, `uninstall`, and `upgrade` commands.

### 3.2.9.14. Mirror registry for Red Hat OpenShift 1.2.5

*Mirror registry for Red Hat OpenShift* is now available with Red Hat Quay 3.7.6.

The following advisory is available for the *mirror registry for Red Hat OpenShift*:

- [RHBA-2022:6071 - mirror registry for Red Hat OpenShift 1.2.5](#)

### 3.2.9.15. Mirror registry for Red Hat OpenShift 1.2.4

*Mirror registry for Red Hat OpenShift* is now available with Red Hat Quay 3.7.5.

The following advisory is available for the *mirror registry for Red Hat OpenShift*:

- [RHBA-2022:5884 - mirror registry for Red Hat OpenShift 1.2.4](#)

### 3.2.9.16. Mirror registry for Red Hat OpenShift 1.2.3

*Mirror registry for Red Hat OpenShift* is now available with Red Hat Quay 3.7.4.

The following advisory is available for the *mirror registry for Red Hat OpenShift*:

- [RHBA-2022:5649 - mirror registry for Red Hat OpenShift 1.2.3](#)

### 3.2.9.17. Mirror registry for Red Hat OpenShift 1.2.2

*Mirror registry for Red Hat OpenShift* is now available with Red Hat Quay 3.7.3.

The following advisory is available for the *mirror registry for Red Hat OpenShift*:

- [RHBA-2022:5501 - mirror registry for Red Hat OpenShift 1.2.2](#)

### 3.2.9.18. Mirror registry for Red Hat OpenShift 1.2.1

*Mirror registry for Red Hat OpenShift* is now available with Red Hat Quay 3.7.2.

The following advisory is available for the *mirror registry for Red Hat OpenShift*:

- [RHBA-2022:4986 - mirror registry for Red Hat OpenShift 1.2.1](#)

### 3.2.9.19. Mirror registry for Red Hat OpenShift 1.2.0

*Mirror registry for Red Hat OpenShift* is now available with Red Hat Quay 3.7.1.

The following advisory is available for the *mirror registry for Red Hat OpenShift*:

- [RHBA-2022:4986 - mirror registry for Red Hat OpenShift 1.2.0](#)

#### 3.2.9.19.1. Bug fixes

- Previously, all components and workers running inside of the Quay pod Operator had log levels set to **DEBUG**. As a result, large traffic logs were created that consumed unnecessary space. With this update, log levels are set to **WARN** by default, which reduces traffic information while emphasizing problem scenarios. ([PROJQUAY-3504](#))

### 3.2.9.20. Mirror registry for Red Hat OpenShift 1.1.0

The following advisory is available for the *mirror registry for Red Hat OpenShift*:

- [RHBA-2022:0956 - mirror registry for Red Hat OpenShift 1.1.0](#)

#### 3.2.9.20.1. New features

- A new command, **mirror-registry upgrade** has been added. This command upgrades all container images without interfering with configurations or data.



#### NOTE

If **quayRoot** was previously set to something other than default, it must be passed into the upgrade command.

#### 3.2.9.20.2. Bug fixes

- Previously, the absence of **quayHostname** or **targetHostname** did not default to the local hostname. With this update, **quayHostname** and **targetHostname** now default to the local hostname if they are missing. ([PROJQUAY-3079](#))

- Previously, the command `./mirror-registry --version` returned an **unknown flag** error. Now, running `./mirror-registry --version` returns the current version of the *mirror registry for Red Hat OpenShift*. ([PROJQUAY-3086](#))
- Previously, users could not set a password during installation, for example, when running `./mirror-registry install --initUser <user_name> --initPassword <password> --verbose`. With this update, users can set a password during installation. ([PROJQUAY-3149](#))
- Previously, the *mirror registry for Red Hat OpenShift* did not recreate pods if they were destroyed. Now, pods are recreated if they are destroyed. ([PROJQUAY-3261](#))

### 3.2.10. Troubleshooting mirror registry for Red Hat OpenShift

To assist in troubleshooting *mirror registry for Red Hat OpenShift*, you can gather logs of systemd services installed by the mirror registry. The following services are installed:

- `quay-app.service`
- `quay-postgres.service`
- `quay-redis.service`
- `quay-pod.service`

#### Prerequisites

- You have installed *mirror registry for Red Hat OpenShift*.

#### Procedure

- If you installed *mirror registry for Red Hat OpenShift* with root privileges, you can get the status information of its systemd services by entering the following command:

```
$ sudo systemctl status <service>
```

- If you installed *mirror registry for Red Hat OpenShift* as a standard user, you can get the status information of its systemd services by entering the following command:

```
$ systemctl --user status <service>
```

#### Additional resources

- [Using SSL to protect connections to Red Hat Quay](#)
- [Configuring the system to trust the certificate authority](#)
- [Mirroring the OpenShift Container Platform image repository](#)
- [Mirroring Operator catalogs for use with disconnected clusters](#)

## 3.3. MIRRORING IMAGES FOR A DISCONNECTED INSTALLATION

You can ensure your clusters only use container images that satisfy your organizational controls on external content. Before you install a cluster on infrastructure that you provision in a restricted network, you must mirror the required container images into that environment. To mirror container images, you

must have a registry for mirroring.



### IMPORTANT

You must have access to the internet to obtain the necessary container images. In this procedure, you place your mirror registry on a mirror host that has access to both your network and the internet. If you do not have access to a mirror host, use the [Mirroring Operator catalogs for use with disconnected clusters](#) procedure to copy images to a device you can move across network boundaries with.

#### 3.3.1. Prerequisites

- You must have a container image registry that supports [Docker v2-2](#) in the location that will host the OpenShift Container Platform cluster, such as one of the following registries:
  - [Red Hat Quay](#)
  - [JFrog Artifactory](#)
  - [Sonatype Nexus Repository](#)
  - [Harbor](#)

If you have an entitlement to Red Hat Quay, see the documentation on deploying Red Hat Quay [for proof-of-concept purposes](#) or [by using the Quay Operator](#). If you need additional assistance selecting and installing a registry, contact your sales representative or Red Hat support.

- If you do not already have an existing solution for a container image registry, subscribers of OpenShift Container Platform are provided a [mirror registry for Red Hat OpenShift](#). The *mirror registry for Red Hat OpenShift* is included with your subscription and is a small-scale container registry that can be used to mirror the required container images of OpenShift Container Platform in disconnected installations.

#### 3.3.2. About the mirror registry

You can mirror the images that are required for OpenShift Container Platform installation and subsequent product updates to a container mirror registry such as Red Hat Quay, JFrog Artifactory, Sonatype Nexus Repository, or Harbor. If you do not have access to a large-scale container registry, you can use the *mirror registry for Red Hat OpenShift*, a small-scale container registry included with OpenShift Container Platform subscriptions.

You can use any container registry that supports [Docker v2-2](#), such as Red Hat Quay, the *mirror registry for Red Hat OpenShift*, Artifactory, Sonatype Nexus Repository, or Harbor. Regardless of your chosen registry, the procedure to mirror content from Red Hat hosted sites on the internet to an isolated image registry is the same. After you mirror the content, you configure each cluster to retrieve this content from your mirror registry.



### IMPORTANT

The OpenShift image registry cannot be used as the target registry because it does not support pushing without a tag, which is required during the mirroring process.

If choosing a container registry that is not the *mirror registry for Red Hat OpenShift*, it must be reachable by every machine in the clusters that you provision. If the registry is unreachable, installation, updating, or normal operations such as workload relocation might fail. For that reason, you must run mirror

registries in a highly available way, and the mirror registries must at least match the production availability of your OpenShift Container Platform clusters.

When you populate your mirror registry with OpenShift Container Platform images, you can follow two scenarios. If you have a host that can access both the internet and your mirror registry, but not your cluster nodes, you can directly mirror the content from that machine. This process is referred to as *connected mirroring*. If you have no such host, you must mirror the images to a file system and then bring that host or removable media into your restricted environment. This process is referred to as *disconnected mirroring*.

For mirrored registries, to view the source of pulled images, you must review the **Trying to access** log entry in the CRI-O logs. Other methods to view the image pull source, such as using the **crictl images** command on a node, show the non-mirrored image name, even though the image is pulled from the mirrored location.



#### NOTE

Red Hat does not test third party registries with OpenShift Container Platform.

### Additional information

For information about viewing the CRI-O logs to view the image source, see [Viewing the image pull source](#).

### 3.3.3. Preparing your mirror host

Before you perform the mirror procedure, you must prepare the host to retrieve content and push it to the remote location.

#### 3.3.3.1. Installing the OpenShift CLI by downloading the binary

You can install the OpenShift CLI (**oc**) to interact with OpenShift Container Platform from a command-line interface. You can install **oc** on Linux, Windows, or macOS.



#### IMPORTANT

If you installed an earlier version of **oc**, you cannot use it to complete all of the commands in OpenShift Container Platform 4.10. Download and install the new version of **oc**.

#### Installing the OpenShift CLI on Linux

You can install the OpenShift CLI (**oc**) binary on Linux by using the following procedure.

#### Procedure

1. Navigate to the [OpenShift Container Platform downloads page](#) on the Red Hat Customer Portal.
2. Select the appropriate version in the **Version** drop-down menu.
3. Click **Download Now** next to the **OpenShift v4.10 Linux Client** entry and save the file.
4. Unpack the archive:

```
$ tar xvf <file>
```

5. Place the **oc** binary in a directory that is on your **PATH**.  
To check your **PATH**, execute the following command:

```
$ echo $PATH
```

After you install the OpenShift CLI, it is available using the **oc** command:

```
$ oc <command>
```

### Installing the OpenShift CLI on Windows

You can install the OpenShift CLI (**oc**) binary on Windows by using the following procedure.

#### Procedure

1. Navigate to the [OpenShift Container Platform downloads page](#) on the Red Hat Customer Portal.
2. Select the appropriate version in the **Version** drop-down menu.
3. Click **Download Now** next to the **OpenShift v4.10 Windows Client** entry and save the file.
4. Unzip the archive with a ZIP program.
5. Move the **oc** binary to a directory that is on your **PATH**.  
To check your **PATH**, open the command prompt and execute the following command:

```
C:\> path
```

After you install the OpenShift CLI, it is available using the **oc** command:

```
C:\> oc <command>
```

### Installing the OpenShift CLI on macOS

You can install the OpenShift CLI (**oc**) binary on macOS by using the following procedure.

#### Procedure

1. Navigate to the [OpenShift Container Platform downloads page](#) on the Red Hat Customer Portal.
2. Select the appropriate version in the **Version** drop-down menu.
3. Click **Download Now** next to the **OpenShift v4.10 MacOSX Client** entry and save the file.
4. Unpack and unzip the archive.
5. Move the **oc** binary to a directory on your **PATH**.  
To check your **PATH**, open a terminal and execute the following command:

```
$ echo $PATH
```

After you install the OpenShift CLI, it is available using the **oc** command:

```
$ oc <command>
```

### 3.3.4. Configuring credentials that allow images to be mirrored

Create a container image registry credentials file that allows mirroring images from Red Hat to your mirror.



#### WARNING

Do not use this image registry credentials file as the pull secret when you install a cluster. If you provide this file when you install cluster, all of the machines in the cluster will have write access to your mirror registry.



#### WARNING

This process requires that you have write access to a container image registry on the mirror registry and adds the credentials to a registry pull secret.

#### Prerequisites

- You configured a mirror registry to use in your disconnected environment.
- You identified an image repository location on your mirror registry to mirror images into.
- You provisioned a mirror registry account that allows images to be uploaded to that image repository.

#### Procedure

Complete the following steps on the installation host:

1. Download your **registry.redhat.io** [pull secret from the Red Hat OpenShift Cluster Manager](#) .
2. Make a copy of your pull secret in JSON format:

```
$ cat ./pull-secret | jq . > <path>/<pull_secret_file_in_json> 1
```

- 1 Specify the path to the folder to store the pull secret in and a name for the JSON file that you create.

The contents of the file resemble the following example:

```
{
  "auths": {
```



```

"cloud.openshift.com": {
  "auth": "b3BlbnNo...",
  "email": "you@example.com"
},
"quay.io": {
  "auth": "b3BlbnNo...",
  "email": "you@example.com"
},
"registry.connect.redhat.com": {
  "auth": "NTE3Njg5Nj...",
  "email": "you@example.com"
},
"registry.redhat.io": {
  "auth": "NTE3Njg5Nj...",
  "email": "you@example.com"
}
}
}

```

3. Generate the base64-encoded user name and password or token for your mirror registry:

```

$ echo -n '<user_name>:<password>' | base64 -w0 1
BGVtbYk3ZHAAtqXs=

```

- 1 For **<user\_name>** and **<password>**, specify the user name and password that you configured for your registry.

4. Edit the JSON file and add a section that describes your registry to it:

```

"auths": {
  "<mirror_registry>": { 1
    "auth": "<credentials>", 2
    "email": "you@example.com"
  }
},

```

- 1 For **<mirror\_registry>**, specify the registry domain name, and optionally the port, that your mirror registry uses to serve content. For example, **registry.example.com** or **registry.example.com:8443**
- 2 For **<credentials>**, specify the base64-encoded user name and password for the mirror registry.

The file resembles the following example:

```

{
  "auths": {
    "registry.example.com": {
      "auth": "BGVtbYk3ZHAAtqXs=",
      "email": "you@example.com"
    },
    "cloud.openshift.com": {
      "auth": "b3BlbnNo...",

```

```

    "email": "you@example.com"
  },
  "quay.io": {
    "auth": "b3BlbnNo...",
    "email": "you@example.com"
  },
  "registry.connect.redhat.com": {
    "auth": "NTE3Njg5Nj...",
    "email": "you@example.com"
  },
  "registry.redhat.io": {
    "auth": "NTE3Njg5Nj...",
    "email": "you@example.com"
  }
}
}
}

```

### 3.3.5. Mirroring the OpenShift Container Platform image repository

Mirror the OpenShift Container Platform image repository to your registry to use during cluster installation or upgrade.

#### Prerequisites

- Your mirror host has access to the internet.
- You configured a mirror registry to use in your restricted network and can access the certificate and credentials that you configured.
- You downloaded the [pull secret from the Red Hat OpenShift Cluster Manager](#) and modified it to include authentication to your mirror repository.
- If you use self-signed certificates, you have specified a Subject Alternative Name in the certificates.

#### Procedure

Complete the following steps on the mirror host:

1. Review the [OpenShift Container Platform downloads page](#) to determine the version of OpenShift Container Platform that you want to install and determine the corresponding tag on the [Repository Tags](#) page.
2. Set the required environment variables:
  - a. Export the release version:

```
$ OCP_RELEASE=<release_version>
```

For **<release\_version>**, specify the tag that corresponds to the version of OpenShift Container Platform to install, such as **4.5.4**.

- b. Export the local registry name and host port:

```
$ LOCAL_REGISTRY='<local_registry_host_name>:<local_registry_host_port>'
```

For **<local\_registry\_host\_name>**, specify the registry domain name for your mirror repository, and for **<local\_registry\_host\_port>**, specify the port that it serves content on.

- c. Export the local repository name:

```
$ LOCAL_REPOSITORY='<local_repository_name>'
```

For **<local\_repository\_name>**, specify the name of the repository to create in your registry, such as **ocp4/openshift4**.

- d. Export the name of the repository to mirror:

```
$ PRODUCT_REPO='openshift-release-dev'
```

For a production release, you must specify **openshift-release-dev**.

- e. Export the path to your registry pull secret:

```
$ LOCAL_SECRET_JSON='<path_to_pull_secret>'
```

For **<path\_to\_pull\_secret>**, specify the absolute path to and file name of the pull secret for your mirror registry that you created.

- f. Export the release mirror:

```
$ RELEASE_NAME="ocp-release"
```

For a production release, you must specify **ocp-release**.

- g. Export the type of architecture for your server, such as **x86\_64**:

```
$ ARCHITECTURE=<server_architecture>
```

- h. Export the path to the directory to host the mirrored images:

```
$ REMOVABLE_MEDIA_PATH=<path> 1
```

- 1** Specify the full path, including the initial forward slash (/) character.

3. Mirror the version images to the mirror registry:

- If your mirror host does not have internet access, take the following actions:
  - i. Connect the removable media to a system that is connected to the internet.
  - ii. Review the images and configuration manifests to mirror:

```
$ oc adm release mirror -a ${LOCAL_SECRET_JSON} \
  --from=quay.io/${PRODUCT_REPO}/${RELEASE_NAME}:${OCP_RELEASE}-
  ${ARCHITECTURE} \
  --to=${LOCAL_REGISTRY}/${LOCAL_REPOSITORY} \
  --to-release-
  image=${LOCAL_REGISTRY}/${LOCAL_REPOSITORY}:${OCP_RELEASE}-
  ${ARCHITECTURE} --dry-run
```

- iii. Record the entire **imageContentSources** section from the output of the previous command. The information about your mirrors is unique to your mirrored repository, and you must add the **imageContentSources** section to the **install-config.yaml** file during installation.
- iv. Mirror the images to a directory on the removable media:

```
$ oc adm release mirror -a ${LOCAL_SECRET_JSON} --to-dir=${REMOVABLE_MEDIA_PATH}/mirror quay.io/${PRODUCT_REPO}/${RELEASE_NAME}:${OCP_RELEASE}-${ARCHITECTURE}
```

- v. Take the media to the restricted network environment and upload the images to the local container registry.

```
$ oc image mirror -a ${LOCAL_SECRET_JSON} --from-dir=${REMOVABLE_MEDIA_PATH}/mirror "file://openshift/release:${OCP_RELEASE}" ${LOCAL_REGISTRY}/${LOCAL_REPOSITORY} 1
```

- 1** For **REMOVABLE\_MEDIA\_PATH**, you must use the same path that you specified when you mirrored the images.



### IMPORTANT

Running **oc image mirror** might result in the following error: **error: unable to retrieve source image**. This error occurs when image indexes include references to images that no longer exist on the image registry. Image indexes might retain older references to allow users running those images an upgrade path to newer points on the upgrade graph. As a temporary workaround, you can use the **--skip-missing** option to bypass the error and continue downloading the image index. For more information, see [Service Mesh Operator mirroring failed](#).

- If the local container registry is connected to the mirror host, take the following actions:
  - i. Directly push the release images to the local registry by using following command:

```
$ oc adm release mirror -a ${LOCAL_SECRET_JSON} \
  --from=quay.io/${PRODUCT_REPO}/${RELEASE_NAME}:${OCP_RELEASE}-${ARCHITECTURE} \
  --to=${LOCAL_REGISTRY}/${LOCAL_REPOSITORY} \
  --to-release-image=${LOCAL_REGISTRY}/${LOCAL_REPOSITORY}:${OCP_RELEASE}-${ARCHITECTURE}
```

This command pulls the release information as a digest, and its output includes the **imageContentSources** data that you require when you install your cluster.

- ii. Record the entire **imageContentSources** section from the output of the previous command. The information about your mirrors is unique to your mirrored repository, and you must add the **imageContentSources** section to the **install-config.yaml** file during installation.

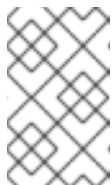
**NOTE**

The image name gets patched to Quay.io during the mirroring process, and the podman images will show Quay.io in the registry on the bootstrap virtual machine.

- To create the installation program that is based on the content that you mirrored, extract it and pin it to the release:

- If your mirror host does not have internet access, run the following command:

```
$ oc adm release extract -a ${LOCAL_SECRET_JSON} --icsp-file=<file> \ --
command=openshift-install
"${LOCAL_REGISTRY}/${LOCAL_REPOSITORY}:${OCP_RELEASE}"
```

- If the local container registry is connected to the mirror host, run the following command:

```
$ oc adm release extract -a ${LOCAL_SECRET_JSON} --command=openshift-install
"${LOCAL_REGISTRY}/${LOCAL_REPOSITORY}:${OCP_RELEASE}-
${ARCHITECTURE}"
```

**IMPORTANT**

To ensure that you use the correct images for the version of OpenShift Container Platform that you selected, you must extract the installation program from the mirrored content.

You must perform this step on a machine with an active internet connection.

- For clusters using installer-provisioned infrastructure, run the following command:

```
$ openshift-install
```

### 3.3.6. The Cluster Samples Operator in a disconnected environment

In a disconnected environment, you must take additional steps after you install a cluster to configure the Cluster Samples Operator. Review the following information in preparation.

#### 3.3.6.1. Cluster Samples Operator assistance for mirroring

During installation, OpenShift Container Platform creates a config map named **imagestreamtag-to-image** in the **openshift-cluster-samples-operator** namespace. The **imagestreamtag-to-image** config map contains an entry, the populating image, for each image stream tag.

The format of the key for each entry in the data field in the config map is **<image\_stream\_name>\_<image\_stream\_tag\_name>**.

During a disconnected installation of OpenShift Container Platform, the status of the Cluster Samples Operator is set to **Removed**. If you choose to change it to **Managed**, it installs samples.

**NOTE**

The use of samples in a network-restricted or discontinued environment may require access to services external to your network. Some example services include: Github, Maven Central, npm, RubyGems, PyPi and others. There might be additional steps to take that allow the cluster samples operators's objects to reach the services they require.

You can use this config map as a reference for which images need to be mirrored for your image streams to import.

- While the Cluster Samples Operator is set to **Removed**, you can create your mirrored registry, or determine which existing mirrored registry you want to use.
- Mirror the samples you want to the mirrored registry using the new config map as your guide.
- Add any of the image streams you did not mirror to the **skippedImagestreams** list of the Cluster Samples Operator configuration object.
- Set **samplesRegistry** of the Cluster Samples Operator configuration object to the mirrored registry.
- Then set the Cluster Samples Operator to **Managed** to install the image streams you have mirrored.

### 3.3.7. Mirroring Operator catalogs for use with disconnected clusters

You can mirror the Operator contents of a Red Hat-provided catalog, or a custom catalog, into a container image registry using the **oc adm catalog mirror** command. The target registry must support [Docker v2-2](#). For a cluster on a restricted network, this registry can be one that the cluster has network access to, such as a mirror registry created during a restricted network cluster installation.

**IMPORTANT**

- The OpenShift image registry cannot be used as the target registry because it does not support pushing without a tag, which is required during the mirroring process.
- Running **oc adm catalog mirror** might result in the following error: **error: unable to retrieve source image**. This error occurs when image indexes include references to images that no longer exist on the image registry. Image indexes might retain older references to allow users running those images an upgrade path to newer points on the upgrade graph. As a temporary workaround, you can use the **--skip-missing** option to bypass the error and continue downloading the image index. For more information, see [Service Mesh Operator mirroring failed](#).

The **oc adm catalog mirror** command also automatically mirrors the index image that is specified during the mirroring process, whether it be a Red Hat-provided index image or your own custom-built index image, to the target registry. You can then use the mirrored index image to create a catalog source that allows Operator Lifecycle Manager (OLM) to load the mirrored catalog onto your OpenShift Container Platform cluster.

#### Additional resources

- [Using Operator Lifecycle Manager on restricted networks](#)

### 3.3.7.1. Prerequisites

Mirroring Operator catalogs for use with disconnected clusters has the following prerequisites:

- Workstation with unrestricted network access.
- **podman** version 1.9.3 or later.
- If you want to filter, or *prune*, the default catalog and selectively mirror only a subset of Operators, see the following sections:
  - [Installing the opm CLI](#)
  - [Filtering a SQLite-based index image](#)

- If you want to mirror a Red Hat–provided catalog, run the following command on your workstation with unrestricted network access to authenticate with **registry.redhat.io**:

```
$ podman login registry.redhat.io
```

- Access to a mirror registry that supports [Docker v2-2](#).
- On your mirror registry, decide which repository, or namespace, to use for storing mirrored Operator content. For example, you might create an **olm-mirror** repository.
- If your mirror registry does not have internet access, connect removable media to your workstation with unrestricted network access.
- If you are working with private registries, including **registry.redhat.io**, set the **REG\_CREDS** environment variable to the file path of your registry credentials for use in later steps. For example, for the **podman** CLI:

```
$ REG_CREDS=${XDG_RUNTIME_DIR}/containers/auth.json
```

### 3.3.7.2. Extracting and mirroring catalog contents

The **oc adm catalog mirror** command extracts the contents of an index image to generate the manifests required for mirroring. The default behavior of the command generates manifests, then automatically mirrors all of the image content from the index image, as well as the index image itself, to your mirror registry.

Alternatively, if your mirror registry is on a completely disconnected, or *airgapped*, host, you can first mirror the content to removable media, move the media to the disconnected environment, then mirror the content from the media to the registry.

#### 3.3.7.2.1. Mirroring catalog contents to registries on the same network

If your mirror registry is co-located on the same network as your workstation with unrestricted network access, take the following actions on your workstation.

#### Procedure

1. If your mirror registry requires authentication, run the following command to log in to the registry:

```
$ podman login <mirror_registry>
```

2. Run the following command to extract and mirror the content to the mirror registry:

```
$ oc adm catalog mirror \
  <index_image> \ 1
  <mirror_registry>:<port>[/<repository>] \ 2
  [-a ${REG_CREDS}] \ 3
  [--insecure] \ 4
  [--index-filter-by-os='<platform>/<arch>'] \ 5
  [--manifests-only] 6
```

- 1** Specify the index image for the catalog that you want to mirror. For example, this might be a pruned index image that you created previously, or one of the source index images for the default catalogs, such as **registry.redhat.io/redhat/redhat-operator-index:v4.10**.
- 2** Specify the fully qualified domain name (FQDN) for the target registry to mirror the Operator contents to. The mirror registry **<repository>** can be any existing repository, or namespace, on the registry, for example **olm-mirror** as outlined in the prerequisites. If there is an existing repository found during mirroring, the repository name is added to the resulting image name. If you do not want the image name to include the repository name, omit the **<repository>** value from this line, for example **<mirror\_registry>:<port>**.
- 3** Optional: If required, specify the location of your registry credentials file. **{REG\_CREDS}** is required for **registry.redhat.io**.
- 4** Optional: If you do not want to configure trust for the target registry, add the **--insecure** flag.
- 5** Optional: Specify which platform and architecture of the index image to select when multiple variants are available. Images are passed as '**<platform>/<arch>[/<variant>]**'. This does not apply to images referenced by the index. Valid values are **linux/amd64**, **linux/ppc64le**, **linux/s390x**, and **.\***
- 6** Optional: Generate only the manifests required for mirroring, and do not actually mirror the image content to a registry. This option can be useful for reviewing what will be mirrored, and it allows you to make any changes to the mapping list if you require only a subset of packages. You can then use the **mapping.txt** file with the **oc image mirror** command to mirror the modified list of images in a later step. This flag is intended for only advanced selective mirroring of content from the catalog; the **opm index prune** command, if you used it previously to prune the index image, is suitable for most catalog management use cases.

### Example output

```
src image has index label for database path: /database/index.db
using database path mapping: /database/index.db:/tmp/153048078
wrote database to /tmp/153048078 1
...
wrote mirroring manifests to manifests-redhat-operator-index-1614211642 2
```

- 1** Directory for the temporary **index.db** database generated by the command.



- 2 Record the manifests directory name that is generated. This directory is referenced in subsequent procedures.



## NOTE

Red Hat Quay does not support nested repositories. As a result, running the **oc adm catalog mirror** command will fail with a **401** unauthorized error. As a workaround, you can use the **--max-components=2** option when running the **oc adm catalog mirror** command to disable the creation of nested repositories. For more information on this workaround, see the [Unauthorized error thrown while using catalog mirror command with Quay registry](#) Knowledgebase Solution.

## Additional resources

- [Architecture and operating system support for Operators](#)

### 3.3.7.2.2. Mirroring catalog contents to airgapped registries

If your mirror registry is on a completely disconnected, or airgapped, host, take the following actions.

#### Procedure

1. Run the following command on your workstation with unrestricted network access to mirror the content to local files:

```
$ oc adm catalog mirror \
  <index_image> \ 1
  file:///local/index \ 2
  -a ${REG_CREDS} \ 3
  --insecure \ 4
  --index-filter-by-os='<platform>/<arch>' 5
```

- 1 Specify the index image for the catalog that you want to mirror. For example, this might be a pruned index image that you created previously, or one of the source index images for the default catalogs, such as **registry.redhat.io/redhat/redhat-operator-index:v4.10**.
- 2 Specify the content to mirror to local files in your current directory.
- 3 Optional: If required, specify the location of your registry credentials file.
- 4 Optional: If you do not want to configure trust for the target registry, add the **--insecure** flag.
- 5 Optional: Specify which platform and architecture of the index image to select when multiple variants are available. Images are specified as '**<platform>/<arch>[/<variant>]**'. This does not apply to images referenced by the index. Valid values are **linux/amd64**, **linux/ppc64le**, **linux/s390x**, and **.\***

#### Example output

```
...
info: Mirroring completed in 5.93s (5.915MB/s)
```

wrote mirroring manifests to manifests-my-index-1614985528 **1**

To upload local images to a registry, run:

```
oc adm catalog mirror file:///local/index/myrepo/my-index:v1 REGISTRY/REPOSITORY 2
```

- 1** Record the manifests directory name that is generated. This directory is referenced in subsequent procedures.
- 2** Record the expanded **file://** path that is based on your provided index image. This path is referenced in a subsequent step.

This command creates a **v2/** directory in your current directory.

2. Copy the **v2/** directory to removable media.
3. Physically remove the media and attach it to a host in the disconnected environment that has access to the mirror registry.
4. If your mirror registry requires authentication, run the following command on your host in the disconnected environment to log in to the registry:

```
$ podman login <mirror_registry>
```

5. Run the following command from the parent directory containing the **v2/** directory to upload the images from local files to the mirror registry:

```
$ oc adm catalog mirror \
  file:///local/index/<repository>/<index_image>:<tag> \ 1
  <mirror_registry>:<port>[/<repository>] \ 2
  -a ${REG_CREDS} \ 3
  --insecure \ 4
  --index-filter-by-os='<platform>/<arch>' 5
```

- 1** Specify the **file://** path from the previous command output.
- 2** Specify the fully qualified domain name (FQDN) for the target registry to mirror the Operator contents to. The mirror registry **<repository>** can be any existing repository, or namespace, on the registry, for example **olm-mirror** as outlined in the prerequisites. If there is an existing repository found during mirroring, the repository name is added to the resulting image name. If you do not want the image name to include the repository name, omit the **<repository>** value from this line, for example **<mirror\_registry>:<port>**.
- 3** Optional: If required, specify the location of your registry credentials file.
- 4** Optional: If you do not want to configure trust for the target registry, add the **--insecure** flag.
- 5** Optional: Specify which platform and architecture of the index image to select when multiple variants are available. Images are specified as '**<platform>/<arch>[/<variant>]**'. This does not apply to images referenced by the index. Valid values are **linux/amd64**, **linux/ppc64le**, **linux/s390x**, and **.\***



## NOTE

Red Hat Quay does not support nested repositories. As a result, running the **oc adm catalog mirror** command will fail with a **401** unauthorized error. As a workaround, you can use the **--max-components=2** option when running the **oc adm catalog mirror** command to disable the creation of nested repositories. For more information on this workaround, see the [Unauthorized error thrown while using catalog mirror command with Quay registry](#) Knowledgebase Solution.

- Run the **oc adm catalog mirror** command again. Use the newly mirrored index image as the source and the same mirror registry target used in the previous step:

```
$ oc adm catalog mirror \
  <mirror_registry>:<port>/<index_image> \
  <mirror_registry>:<port>/[<repository>] \
  --manifests-only 1 \
  [-a ${REG_CREDS}] \
  [--insecure]
```

- The **--manifests-only** flag is required for this step so that the command does not copy all of the mirrored content again.

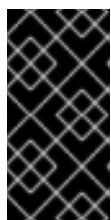

## IMPORTANT

This step is required because the image mappings in the **imageContentSourcePolicy.yaml** file generated during the previous step must be updated from local paths to valid mirror locations. Failure to do so will cause errors when you create the **ImageContentSourcePolicy** object in a later step.

After you mirror the catalog, you can continue with the remainder of your cluster installation. After your cluster installation has finished successfully, you must specify the manifests directory from this procedure to create the **ImageContentSourcePolicy** and **CatalogSource** objects. These objects are required to enable installation of Operators from OperatorHub.

### Additional resources

- [Architecture and operating system support for Operators](#)

### 3.3.7.3. Generated manifests

After mirroring Operator catalog content to your mirror registry, a manifests directory is generated in your current directory.

If you mirrored content to a registry on the same network, the directory name takes the following pattern:

```
manifests-<index_image_name>-<random_number>
```

If you mirrored content to a registry on a disconnected host in the previous section, the directory name takes the following pattern:

```
manifests-index/<repository>/<index_image_name>-<random_number>
```

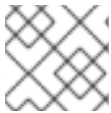
**NOTE**

The manifests directory name is referenced in subsequent procedures.

The manifests directory contains the following files, some of which might require further modification:

- The **catalogSource.yaml** file is a basic definition for a **CatalogSource** object that is pre-populated with your index image tag and other relevant metadata. This file can be used as is or modified to add the catalog source to your cluster.

**IMPORTANT**

If you mirrored the content to local files, you must modify your **catalogSource.yaml** file to remove any backslash (/) characters from the **metadata.name** field. Otherwise, when you attempt to create the object, it fails with an "invalid resource name" error.

- The **imageContentSourcePolicy.yaml** file defines an **ImageContentSourcePolicy** object that can configure nodes to translate between the image references stored in Operator manifests and the mirrored registry.

**NOTE**

If your cluster uses an **ImageContentSourcePolicy** object to configure repository mirroring, you can use only global pull secrets for mirrored registries. You cannot add a pull secret to a project.

- The **mapping.txt** file contains all of the source images and where to map them in the target registry. This file is compatible with the **oc image mirror** command and can be used to further customize the mirroring configuration.

**IMPORTANT**

If you used the **--manifests-only** flag during the mirroring process and want to further trim the subset of packages to mirror, see the steps in the [Mirroring a package manifest format catalog image](#) procedure of the OpenShift Container Platform 4.7 documentation about modifying your **mapping.txt** file and using the file with the **oc image mirror** command.

#### 3.3.7.4. Post-installation requirements

After you mirror the catalog, you can continue with the remainder of your cluster installation. After your cluster installation has finished successfully, you must specify the manifests directory from this procedure to create the **ImageContentSourcePolicy** and **CatalogSource** objects. These objects are required to populate and enable installation of Operators from OperatorHub.

#### Additional resources

- [Populating OperatorHub from mirrored Operator catalogs](#)

#### 3.3.8. Next steps

- Install a cluster on infrastructure that you provision in your restricted network, such as on [VMware vSphere](#), [bare metal](#), or [Amazon Web Services](#).

### 3.3.9. Additional resources

- See [Gathering data about specific features](#) for more information about using must-gather.

## 3.4. MIRRORING IMAGES FOR A DISCONNECTED INSTALLATION USING THE OC-MIRROR PLUGIN

You can ensure your clusters only use container images that satisfy your organizational controls on external content. Before you install a cluster on infrastructure that you provision in a restricted network, you must mirror the required container images into that environment. To mirror container images, you must have a registry for mirroring.

You can use the oc-mirror OpenShift CLI (**oc**) plugin to mirror images to a mirror registry in your fully or partially disconnected environments.



### IMPORTANT

Mirroring images for disconnected environments using the oc-mirror plugin is a Technology Preview feature only. Technology Preview features are not supported with Red Hat production service level agreements (SLAs) and might not be functionally complete. Red Hat does not recommend using them in production. These features provide early access to upcoming product features, enabling customers to test functionality and provide feedback during the development process.

For more information about the support scope of Red Hat Technology Preview features, see [Technology Preview Features Support Scope](#).

The following steps outline the high-level workflow on how to use the oc-mirror plugin to mirror images to a mirror registry:

1. Create an image set configuration file.
2. Mirror the image set to the mirror registry.
3. Configure your cluster to use the resources generated by the oc-mirror plugin.
4. Repeat these steps to update your mirror registry as necessary.

### 3.4.1. About the oc-mirror plugin

You can use the oc-mirror OpenShift CLI (**oc**) plugin to mirror all required OpenShift Container Platform content and other images to your mirror registry by using a single tool. It provides the following features:

- Provides a centralized method to mirror OpenShift Container Platform releases, Operators, helm charts, and other images.
- Maintains update paths for OpenShift Container Platform and Operators.
- Uses a declarative image set configuration file to include only the OpenShift Container Platform releases, Operators, and images that your cluster needs.

- Performs incremental mirroring, which reduces the size of future image sets.

When using the `oc-mirror` plugin, you specify which content to mirror in an image set configuration file. In this YAML file, you can fine-tune the configuration to only include the OpenShift Container Platform releases and Operators that your cluster needs. This reduces the amount of data that you need to download and transfer. The `oc-mirror` plugin can also mirror arbitrary helm charts and additional container images to assist users in seamlessly synchronizing their workloads onto mirror registries.

The first time you run the `oc-mirror` plugin, it populates your mirror registry with the required content to perform your disconnected cluster installation. In order for your disconnected cluster to continue receiving updates, you must keep your mirror registry updated. To update your mirror registry, you run the `oc-mirror` plugin using the same configuration as the first time you ran it. The `oc-mirror` plugin references the metadata from the storage backend and only downloads what has been released since the last time you ran the tool. This provides update paths for OpenShift Container Platform and Operators and performs dependency resolution as required.



### IMPORTANT

When using the `oc-mirror` CLI plugin to populate a mirror registry, any further updates to the mirror registry must be made using the `oc-mirror` tool.

## 3.4.2. About the mirror registry

You can mirror the images that are required for OpenShift Container Platform installation and subsequent product updates to a container mirror registry that supports [Docker v2-2](#), such as Red Hat Quay. If you do not have access to a large-scale container registry, you can use the *mirror registry for Red Hat OpenShift*, which is a small-scale container registry included with OpenShift Container Platform subscriptions.

Regardless of your chosen registry, the procedure to mirror content from Red Hat hosted sites on the internet to an isolated image registry is the same. After you mirror the content, you configure each cluster to retrieve this content from your mirror registry.



### IMPORTANT

The OpenShift image registry cannot be used as the target registry because it does not support pushing without a tag, which is required during the mirroring process.

If choosing a container registry that is not the *mirror registry for Red Hat OpenShift*, it must be reachable by every machine in the clusters that you provision. If the registry is unreachable, installation, updating, or normal operations such as workload relocation might fail. For that reason, you must run mirror registries in a highly available way, and the mirror registries must at least match the production availability of your OpenShift Container Platform clusters.

When you populate your mirror registry with OpenShift Container Platform images, you can follow two scenarios. If you have a host that can access both the internet and your mirror registry, but not your cluster nodes, you can directly mirror the content from that machine. This process is referred to as *connected mirroring*. If you have no such host, you must mirror the images to a file system and then bring that host or removable media into your restricted environment. This process is referred to as *disconnected mirroring*.

For mirrored registries, to view the source of pulled images, you must review the **Trying to access** log entry in the CRI-O logs. Other methods to view the image pull source, such as using the `crictl images` command on a node, show the non-mirrored image name, even though the image is pulled from the mirrored location.

**NOTE**

Red Hat does not test third party registries with OpenShift Container Platform.

**Additional resources**

- For information about viewing the CRI-O logs to view the image source, see [Viewing the image pull source](#).

**3.4.3. Prerequisites**

- You must have a container image registry that supports [Docker v2-2](#) in the location that will host the OpenShift Container Platform cluster, such as Red Hat Quay.

**NOTE**

If you use Red Hat Quay, you must use version 3.6 or later with the `oc-mirror` plugin. If you have an entitlement to Red Hat Quay, see the documentation on [deploying Red Hat Quay for proof-of-concept purposes](#) or [by using the Quay Operator](#). If you need additional assistance selecting and installing a registry, contact your sales representative or Red Hat Support.

If you do not already have an existing solution for a container image registry, subscribers of OpenShift Container Platform are provided a [mirror registry for Red Hat OpenShift](#). The *mirror registry for Red Hat OpenShift* is included with your subscription and is a small-scale container registry that can be used to mirror the required container images of OpenShift Container Platform in disconnected installations.

**3.4.4. Preparing your mirror hosts**

Before you can use the `oc-mirror` plugin to mirror images, you must install the plugin and create a container image registry credentials file to allow the mirroring from Red Hat to your mirror.

**3.4.4.1. Installing the `oc-mirror` OpenShift CLI plugin**

To use the `oc-mirror` OpenShift CLI plugin to mirror registry images, you must install the plugin. If you are mirroring image sets in a fully disconnected environment, ensure that you install the `oc-mirror` plugin on the host with internet access and the host in the disconnected environment with access to the mirror registry.

**Prerequisites**

- You have installed the OpenShift CLI (**oc**).

**Procedure**

1. Download the `oc-mirror` CLI plugin.
  - a. Navigate to the [Downloads](#) page of the [OpenShift Cluster Manager](#).
  - b. Under the **OpenShift disconnected installation tools** section, click **Download** for **OpenShift Client (oc) mirror plugin** and save the file.
2. Extract the archive:

```
$ tar xvzf oc-mirror.tar.gz
```

3. If necessary, update the plugin file to be executable:

```
$ chmod +x oc-mirror
```

**NOTE**

Do not rename the **oc-mirror** file.

4. Install the oc-mirror CLI plugin by placing the file in your **PATH**, for example, **/usr/local/bin**:

```
$ sudo mv oc-mirror /usr/local/bin/.
```

**Verification**

- Run **oc mirror help** to verify that the plugin was successfully installed:

```
$ oc mirror help
```

**Additional resources**

- [Installing and using CLI plugins](#)

**3.4.4.2. Configuring credentials that allow images to be mirrored**

Create a container image registry credentials file that allows mirroring images from Red Hat to your mirror.

**WARNING**

Do not use this image registry credentials file as the pull secret when you install a cluster. If you provide this file when you install cluster, all of the machines in the cluster will have write access to your mirror registry.

**WARNING**

This process requires that you have write access to a container image registry on the mirror registry and adds the credentials to a registry pull secret.

**Prerequisites**

- You configured a mirror registry to use in your disconnected environment.



- You identified an image repository location on your mirror registry to mirror images into.
- You provisioned a mirror registry account that allows images to be uploaded to that image repository.

## Procedure

Complete the following steps on the installation host:

1. Download your **registry.redhat.io** pull secret from the [Red Hat OpenShift Cluster Manager](#) .
2. Make a copy of your pull secret in JSON format:

```
$ cat ./pull-secret | jq . > <path>/<pull_secret_file_in_json> 1
```

- 1 Specify the path to the folder to store the pull secret in and a name for the JSON file that you create.

3. Save the file either as `~/.docker/config.json` or `$XDG_RUNTIME_DIR/containers/auth.json`. The contents of the file resemble the following example:

```
{
  "auths": {
    "cloud.openshift.com": {
      "auth": "b3BlbnNo...",
      "email": "you@example.com"
    },
    "quay.io": {
      "auth": "b3BlbnNo...",
      "email": "you@example.com"
    },
    "registry.connect.redhat.com": {
      "auth": "NTE3Njg5Nj...",
      "email": "you@example.com"
    },
    "registry.redhat.io": {
      "auth": "NTE3Njg5Nj...",
      "email": "you@example.com"
    }
  }
}
```

4. Generate the base64-encoded user name and password or token for your mirror registry:

```
$ echo -n '<user_name>:<password>' | base64 -w0 1
BGVtbYk3ZHAtdXs=
```

- 1 For `<user_name>` and `<password>`, specify the user name and password that you configured for your registry.

5. Edit the JSON file and add a section that describes your registry to it:

```
"auths": {
```

```
"<mirror_registry>": { 1
  "auth": "<credentials>", 2
  "email": "you@example.com"
}
},
```

- 1 For **<mirror\_registry>**, specify the registry domain name, and optionally the port, that your mirror registry uses to serve content. For example, **registry.example.com** or **registry.example.com:8443**
- 2 For **<credentials>**, specify the base64-encoded user name and password for the mirror registry.

The file resembles the following example:

```
{
  "auths": {
    "registry.example.com": {
      "auth": "BGVtbYk3ZHAqXs=",
      "email": "you@example.com"
    },
    "cloud.openshift.com": {
      "auth": "b3BlbnNo...",
      "email": "you@example.com"
    },
    "quay.io": {
      "auth": "b3BlbnNo...",
      "email": "you@example.com"
    },
    "registry.connect.redhat.com": {
      "auth": "NTE3Njg5Nj...",
      "email": "you@example.com"
    },
    "registry.redhat.io": {
      "auth": "NTE3Njg5Nj...",
      "email": "you@example.com"
    }
  }
}
```

### 3.4.5. Creating the image set configuration

Before you can use the `oc-mirror` plugin to mirror image sets, you must create an image set configuration file. This image set configuration file defines which OpenShift Container Platform releases, Operators, and other images to mirror, along with other configuration settings for the `oc-mirror` plugin.

You must specify a storage backend in the image set configuration file. This storage backend can be a local directory or a registry that supports [Docker v2-2](#). The `oc-mirror` plugin stores metadata in this storage backend during image set creation.



## IMPORTANT

Do not delete or modify the metadata that is generated by the `oc-mirror` plugin. You must use the same storage backend every time you run the `oc-mirror` plugin for the same mirror registry.

### Procedure

1. Create an **ImageSetConfiguration** resource that specifies the necessary configuration details:

#### Example ImageSetConfiguration file

```
apiVersion: mirror.openshift.io/v1alpha1
kind: ImageSetConfiguration
archiveSize: 4 1
mirror:
  ocp:
    channels:
      - name: stable-4.9 2
  operators:
    - catalog: registry.redhat.io/redhat/redhat-operator-index:v4.9 3
storageConfig: 4
registry:
  imageURL: example.com/example/oc-mirror 5
```

- 1** The maximum size, in GiB, of each file within the image set.
- 2** The channel to retrieve the OpenShift Container Platform images from.
- 3** The Operator catalog to retrieve the OpenShift Container Platform images from.
- 4** The back-end location to save the image set metadata to. This location can be a registry or local directory. It is required to specify **storageConfig** values.
- 5** The registry URL for the storage backend.

This example pulls images from the **stable-4.9** channel for the **registry.redhat.io/redhat/redhat-operator-index:v4.9** operator catalog and saves the image set metadata to the **example.com/example/oc-mirror** registry.

2. Save the file as **imageset-config.yaml**. This file is required by the **oc mirror** command when mirroring content.

### Additional resources

- [Image set configuration parameters](#)
- [Image set configuration examples](#)

### 3.4.6. Mirroring an image set to a mirror registry

You can use the `oc-mirror` CLI plugin to mirror images to a mirror registry in a [partially disconnected environment](#) or in a [fully disconnected environment](#).

These procedures assume that you already have your mirror registry set up.

### 3.4.6.1. Mirroring an image set in a partially disconnected environment

In a partially disconnected environment, you can mirror an image set directly to the target mirror registry.

#### 3.4.6.1.1. Mirroring from mirror to mirror

You can use the `oc-mirror` plugin to mirror an image set directly to a target mirror registry that is accessible during image set creation.



#### IMPORTANT

Depending on the configuration specified in the image set configuration file, using `oc-mirror` to mirror images might download several hundreds of gigabytes of data to disk before mirroring to the destination mirror registry.

The initial image set download when you populate the mirror registry is often the largest. Because you only download the images that changed since the last time you ran the command, when you run the `oc-mirror` plugin again, the generated image set is often smaller.

You are required to specify a storage backend in the image set configuration file. This storage backend can be a local directory or a Docker v2 registry. The `oc-mirror` plugin stores metadata in this storage backend during image set creation.



#### IMPORTANT

Do not delete or modify the metadata that is generated by the `oc-mirror` plugin. You must use the same storage backend every time you run the `oc-mirror` plugin for the same mirror registry.

#### Prerequisites

- You have access to the internet to obtain the necessary container images.
- You have installed the OpenShift CLI (**oc**).
- You have installed the **oc-mirror** CLI plugin.
- You have created the image set configuration file.

#### Procedure

- Run the **oc mirror** command to mirror the images from the specified image set configuration to a specified registry:

```
$ oc mirror --config=./imageset-config.yaml \ 1
docker://registry.example:5000 2
```

- 1 Pass in the image set configuration file that was created. This procedure assumes that it is named **imageset-config.yaml**.

- 2

Specify the registry to mirror the image set file to. The registry must start with **docker://**. If you specify a top-level namespace for the mirror registry, you must also use this same

### Verification

1. Navigate into the **oc-mirror-workspace/** directory that was generated.
2. Navigate into the results directory, for example, **results-1639608409/**.
3. Verify that YAML files are present for the **ImageContentSourcePolicy** and **CatalogSource** resources.

### Next steps

- Configure your cluster to use the resources generated by oc-mirror.

### 3.4.6.2. Mirroring an image set in a fully disconnected environment

To mirror an image set in a fully disconnected environment, you must first [mirror the image set to disk](#), then [mirror the image set file on disk to a mirror](#).

#### 3.4.6.2.1. Mirroring from mirror to disk

You can use the oc-mirror plugin to generate an image set and save the contents to disk. The generated image set can then be transferred to the disconnected environment and mirrored to the target registry.



#### IMPORTANT

Depending on the configuration specified in the image set configuration file, using oc-mirror to mirror images might download several hundreds of gigabytes of data to disk.

The initial image set download when you populate the mirror registry is often the largest. Because you only download the images that changed since the last time you ran the command, when you run the oc-mirror plugin again, the generated image set is often smaller.

You are required to specify a storage backend in the image set configuration file. This storage backend can be a local directory or a docker v2 registry. The oc-mirror plugin stores metadata in this storage backend during image set creation.



#### IMPORTANT

Do not delete or modify the metadata that is generated by the oc-mirror plugin. You must use the same storage backend every time you run the oc-mirror plugin for the same mirror registry.

### Prerequisites

- You have access to the internet to obtain the necessary container images.
- You have installed the OpenShift CLI (**oc**).

- You have installed the **oc-mirror** CLI plugin.
- You have created the image set configuration file.

### Procedure

- Run the **oc mirror** command to mirror the images from the specified image set configuration to disk:

```
$ oc mirror --config=./imageset-config.yaml \ 1  
file://<path_to_output_directory> 2
```

- 1 Pass in the image set configuration file that was created. This procedure assumes that it is named **imageset-config.yaml**.
- 2 Specify the target directory where you want to output the image set file. The target directory path must start with **file://**.

### Verification

1. Navigate to your output directory:

```
$ cd <path_to_output_directory>
```

2. Verify that an image set **.tar** file was created:

```
$ ls
```

#### Example output

```
mirror_seq1_000000.tar
```

### Next steps

- Transfer the image set **.tar** file to the disconnected environment.

#### 3.4.6.2.2. Mirroring from disk to mirror

You can use the **oc-mirror** plugin to mirror the contents of a generated image set to the target mirror registry.

### Prerequisites

- You have installed the OpenShift CLI (**oc**) in the disconnected environment.
- You have installed the **oc-mirror** CLI plugin in the disconnected environment.
- You have generated the image set file by using the **oc mirror** command.
- You have transferred the image set file to the disconnected environment.

### Procedure

- Run the **oc mirror** command to process the image set file on disk and mirror the contents to a target mirror registry:

```
$ oc mirror --from=./mirror_seq1_000000.tar \ 1
docker://registry.example:5000 2
```

- 1 Pass in the image set .tar file to mirror, named **mirror\_seq1\_000000.tar** in this example. If an **archiveSize** value was specified in the image set configuration file, the image set might be broken up into multiple .tar files. In this situation, you can pass in a directory that contains the image set .tar files.
- 2 Specify the registry to mirror the image set file to. The registry must start with **docker://**. If you specify a top-level namespace for the mirror registry, you must also use this same namespace on subsequent executions.

This command updates the mirror registry with the image set and generates the **ImageContentSourcePolicy** and **CatalogSource** resources.

### Verification

1. Navigate into the **oc-mirror-workspace/** directory that was generated.
2. Navigate into the results directory, for example, **results-1639608409/**.
3. Verify that YAML files are present for the **ImageContentSourcePolicy** and **CatalogSource** resources.

### Next steps

- Configure your cluster to use the resources generated by oc-mirror.

### 3.4.7. Configuring your cluster to use the resources generated by oc-mirror

After you have mirrored your image set to the mirror registry, you must apply the generated **ImageContentSourcePolicy**, **CatalogSource**, and release image signature resources into the cluster.

The **ImageContentSourcePolicy** resource associates the mirror registry with the source registry and redirects image pull requests from the online registries to the mirror registry. The **CatalogSource** resource is used by Operator Lifecycle Manager (OLM) to retrieve information about the available Operators in the mirror registry. The release image signatures are used to verify the mirrored release images.

### Prerequisites

- You have mirrored the image set to the registry mirror in the disconnected environment.
- You have access to the cluster as a user with the **cluster-admin** role.

### Procedure

1. Log in to the OpenShift CLI as a user with the **cluster-admin** role.
2. Apply the YAML files from the results directory to the cluster by running the following command:

```
$ oc apply -f ./oc-mirror-workspace/results-1639608409/
```

3. Apply the release image signatures to the cluster by running the following command:

```
$ oc apply -f ./oc-mirror-workspace/results-1639608409/release-signatures/
```

## Verification

1. Verify that the **ImageContentSourcePolicy** resources were successfully installed by running the following command:

```
$ oc get imagecontentsourcepolicy --all-namespaces
```

2. Verify that the **CatalogSource** resources were successfully installed by running the following command:

```
$ oc get catalogsource --all-namespaces
```

### 3.4.8. Updating your mirror registry

After you publish a full image set to the mirror registry, you can use the oc-mirror plugin to update the mirror registry with updated images.

When you run the oc-mirror plugin again, it generates an image set that only contains new and updated images since the previous execution.

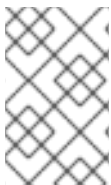

#### NOTE

You must use the same storage backend as the initial execution of oc-mirror for the same mirror registry. Do not delete or modify the metadata that is generated by the oc-mirror plugin.

Because it only pulls in the differences since the previous image set was created, the generated image set is often smaller and faster to process than the initial image set.



#### IMPORTANT

Generated image sets are sequential and must be synchronized to the target mirror registry in order.

## Prerequisites

- You have used the oc-mirror plugin to mirror the initial image set to your mirror registry.
- You have access to the storage backend that was used for the initial execution of the oc-mirror plugin.

## Procedure

1. Follow the same steps that you used to create the initial image set and mirror it to the mirror registry. For instructions, see *Mirroring an image set in a partially disconnected environment* or *Mirroring an image set in a fully disconnected environment*.





## IMPORTANT

- You must provide the same storage backend so that only a differential image set is created and mirrored.
- If you specified a top-level namespace for the mirror registry during the initial image set creation, then you must use this same namespace every time you run the oc-mirror plugin for the same mirror registry.

2. Configure your cluster to use the resources generated by oc-mirror.

### Additional resources

- [Mirroring an image set in a partially disconnected environment](#)
- [Mirroring an image set in a fully disconnected environment](#)
- [Configuring your cluster to use the resources generated by oc-mirror](#)

### 3.4.9. Image set configuration parameters

The oc-mirror plugin requires an image set configuration file that defines what images to mirror. The following table lists the available parameters for the **ImageSetConfiguration** resource.

Table 3.1. ImageSetConfiguration parameters

Parameter	Description	Values
<b>apiVersion</b>	The API version for the <b>ImageSetConfiguration</b> content.	String. For example: <b>mirror.openshift.io/v1alpha1</b> .
<b>archiveSize</b>	The maximum size, in GiB, of each archive file within the image set.	Integer. For example: <b>4</b>
<b>mirror</b>	The configuration of the image set.	Object
<b>mirror.additionalImages</b>	The additional images configuration of the image set.	Array of objects. For example: <pre> additionalImages:   - name:     registry.redhat.io/ubi8/ubi:latest </pre>
<b>mirror.additionalImages.name</b>	The tag of the image to mirror.	String. For example: <b>registry.redhat.io/ubi8/ubi:latest</b>

Parameter	Description	Values
<b>mirror.helm</b>	The helm configuration of the image set. Note that the oc-mirror plugin supports only helm charts that do not require user input when rendered.	Object
<b>mirror.helm.local</b>	The local helm charts to mirror.	Array of objects. For example: <pre>local:   - name:     podinfo     path:       /test/podinfo-       5.0.0.tar.gz</pre>
<b>mirror.helm.local.name</b>	The name of the local helm chart to mirror.	String. For example: <b>podinfo</b> .
<b>mirror.helm.local.path</b>	The path of the local helm chart to mirror.	String. For example: <b>/test/podinfo-5.0.0.tar.gz</b> .
<b>mirror.helm.repos</b>	The remote helm repositories to mirror from.	Array of objects. For example: <pre>repos:   - name:     podinfo     url:       https://example.github.io/podinfo     charts:       - name:         podinfo         version:           5.0.0</pre>
<b>mirror.helm.repos.name</b>	The name of the helm repository to mirror from.	String. For example: <b>podinfo</b> .
<b>mirror.helm.repos.url</b>	The URL of the helm repository to mirror from.	String. For example: <b>https://example.github.io/podinfo</b> .

Parameter	Description	Values
<b>mirror.helm.repos.charts</b>	The remote helm charts to mirror.	Array of objects.
<b>mirror.helm.repos.charts.name</b>	The name of the helm chart to mirror.	String. For example: <b>podinfo</b> .
<b>mirror.helm.repos.charts.version</b>	The version of the named helm chart to mirror.	String. For example: <b>5.0.0</b> .
<b>mirror.ocp</b>	The platform configuration of the image set.	Object
<b>mirror.ocp.channels</b>	The platform channel configuration of the image set.	Array of objects. For example: <pre> channels:   - name:     stable-4.7   - name:     stable-4.6 versions:   - '4.6.36'</pre>
<b>mirror.ocp.channels.name</b>	The name of the release channel.	String. For example: <b>stable-4.9</b> or <b>okd</b> .
<b>mirror.ocp.channels.versions</b>	The list of release versions within the named channel.	String. For example: <b>4.9.6</b> .
<b>mirror.operators</b>	The Operators configuration of the image set.	Array of objects. For example: <pre> operators:   - catalog:     registry.redhat.io/redhat/redhat-operator-index:v4.9     headsOnly:       false     packages:       - name:         elasticsearch-operator  startingVersion: '2.4.0'</pre>

Parameter	Description	Values
<b>mirror.operators.catalog</b>	The Operator catalog to include in the image set.	String. For example: <b>registry.redhat.io/redhat/redhat-operator-index:v4.9.</b>
<b>mirror.operators.headsOnly</b>	Toggles between downloading channel HEADs and full channels. Cannot be used in conjunction with <b>mirror.operators.packages.</b>	Boolean
<b>mirror.operators.packages</b>	The Operator packages configuration.	Array of objects. For example: <pre> operators:   - catalog:       registry.redhat.io/redhat/redhat-operator-index:v4.8       headsOnly:         false       packages:         - name:             elasticsearch-operator  startingVersion: '5.2.3-31' </pre>
<b>mirror.operators.packages.name</b>	The Operator package name to include in the image set	String. For example: <b>elasticsearch-operator.</b>
<b>mirror.operators.packages.startingVersion</b>	The starting version of the Operator package to mirror. All versions of the Operator are mirrored between the value of <b>startingVersion</b> and the HEAD version of each channel that contains the referenced version.	String. For example: <b>5.2.3-31.</b>
<b>mirror.operators.packages.channels</b>	The Operator package channel configuration.	Object
<b>mirror.operators.packages.channels.name</b>	The Operator channel name, unique within a package, to include in the image set.	String. For example: <b>fast</b> or <b>stable-v4.9.</b>

Parameter	Description	Values
<b>mirror.operators.packages.channels.startingVersion</b>	The starting version of the Operator channel to mirror. All versions of the Operator are mirrored between the value of <b>startingVersion</b> and the HEAD version of the specified channel.	String. For example: <b>5.2.3-31</b>
<b>storageConfig</b>	The back-end configuration of the image set.	Object
<b>storageConfig.local</b>	The local back-end configuration of the image set.	Object
<b>storageConfig.local.path</b>	The path of the directory to contain the image set metadata.	String. For example: <b>./path/to/dir/</b> .
<b>storageConfig.registry</b>	The registry back-end configuration of the image set.	Object
<b>storageConfig.registry.imageURL</b>	The back-end registry URI. Can optionally include a namespace reference in the URI.	String. For example: <b>quay.io/myuser/imageset:metadata</b> .
<b>storageConfig.registry.skipTLS</b>	Optionally skip TLS verification of the referenced back-end registry.	Boolean. The default value is <b>false</b> .

### 3.4.10. Image set configuration examples

The following **ImageSetConfiguration** file examples show the configuration for various mirroring use cases.

#### Use case: Including arbitrary images and helm charts

The following **ImageSetConfiguration** file uses a registry storage backend and includes helm charts and an additional Red Hat Universal Base Image (UBI).

#### Example ImageSetConfiguration file

```
apiVersion: mirror.openshift.io/v1alpha1
kind: ImageSetConfiguration
archiveSize: 4
storageConfig:
  registry:
    imageURL: example.com/example/oc-mirror
    skipTLS: false
mirror:
  ocp:
    channels:
```

```

- name: stable-4.10
operators:
- catalog: registry.redhat.io/redhat/redhat-operator-index:v4.10
helm:
repos:
- name: redhat-helm-charts
url: https://raw.githubusercontent.com/redhat-developer/redhat-helm-charts/master
charts:
- name: ibm-mongodb-enterprise-helm
version: 0.2.0
additionalImages:
- name: registry.redhat.io/ubi8/ubi:latest

```

### Use case: Including specific Operator versions

The following **ImageSetConfiguration** file uses a local storage backend and includes only the Red Hat Advanced Cluster Security for Kubernetes Operator, versions starting at 3.67.0 and later.

### Example ImageSetConfiguration file

```

apiVersion: mirror.openshift.io/v1alpha1
kind: ImageSetConfiguration
storageConfig:
local:
path: /home/user/metadata
mirror:
operators:
- catalog: registry.redhat.io/redhat/redhat-operator-index:v4.10
headsOnly: false
packages:
- name: rhacs-operator
channels:
- name: latest
startingVersion: 3.67.0

```

### 3.4.11. Command reference for oc-mirror

The following tables describe the **oc mirror** subcommands and flags:

Table 3.2. oc mirror subcommands

Subcommand	Description
<b>completion</b>	Generate the autocompletion script for the specified shell.
<b>describe</b>	Output the contents of an image set.
<b>help</b>	Show help about any subcommand.
<b>list</b>	List available platform and Operator content and their version.
<b>version</b>	Output the oc-mirror version.

Table 3.3. oc mirror flags

Flag	Description
<b>-c, --config &lt;string&gt;</b>	Specify the path to an image set configuration file.
<b>--continue-on-error</b>	If any non image-pull related error occurs, continue and attempt to mirror as much as possible.
<b>--dest-skip-tls</b>	Disable TLS validation for the target registry.
<b>--dest-use-http</b>	Use plain HTTP for the target registry.
<b>--dry-run</b>	Print actions without mirroring images.
<b>--from &lt;string&gt;</b>	Specify the path to an image set archive that was generated by an execution of oc-mirror to load into a target registry.
<b>-h, --help</b>	Show the help.
<b>--log-level &lt;string&gt;</b>	Specify the number for the log level verbosity. Valid values are <b>0 - 9</b> . The default is <b>0</b> .
<b>--manifests-only</b>	Generate manifests for <b>ImageContentSourcePolicy</b> objects to configure a cluster to use the mirror registry, but do not actually mirror any images. To use this flag, you must pass in an image set archive with the <b>--from</b> flag.
<b>--skip-cleanup</b>	Skip removal of artifact directories.
<b>--skip-image-pin</b>	Do not replace image tags with digest pins in Operator catalogs.
<b>--skip-missing</b>	If an image is not found, skip it instead of reporting an error and aborting execution. Does not apply to custom images explicitly specified in the image set configuration.
<b>--skip-verification</b>	Skip digest verification.
<b>--source-skip-tls</b>	Disable TLS validation for the source registry.
<b>--source-use-http</b>	Use plain HTTP for the source registry.

## CHAPTER 4. INSTALLING ON ALIBABA

### 4.1. PREPARING TO INSTALL ON ALIBABA CLOUD



#### IMPORTANT

Alibaba Cloud on OpenShift Container Platform is a Technology Preview feature only. Technology Preview features are not supported with Red Hat production service level agreements (SLAs) and might not be functionally complete. Red Hat does not recommend using them in production. These features provide early access to upcoming product features, enabling customers to test functionality and provide feedback during the development process.

For more information about the support scope of Red Hat Technology Preview features, see [Technology Preview Features Support Scope](#).

#### 4.1.1. Prerequisites

- You reviewed details about the [OpenShift Container Platform installation and update](#) processes.
- You read the documentation on [selecting a cluster installation method and preparing it for users](#).

#### 4.1.2. Requirements for installing OpenShift Container Platform on Alibaba Cloud

Before installing OpenShift Container Platform on Alibaba Cloud, you must configure and register your domain, create a Resource Access Management (RAM) user for the installation, and review the supported Alibaba Cloud data center regions and zones for the installation.

#### 4.1.3. Registering and Configuring Alibaba Cloud Domain

To install OpenShift Container Platform, the Alibaba Cloud account you use must have a dedicated public hosted zone in your account. This zone must be authoritative for the domain. This service provides cluster DNS resolution and name lookup for external connections to the cluster.

#### Procedure

1. Identify your domain, or subdomain, and registrar. You can transfer an existing domain and registrar or obtain a new one through Alibaba Cloud or another source.



#### NOTE

If you purchase a new domain through Alibaba Cloud, it takes time for the relevant DNS changes to propagate. For more information about purchasing domains through Alibaba Cloud, see [Alibaba Cloud domains](#).

2. If you are using an existing domain and registrar, migrate its DNS to Alibaba Cloud. See [Domain name transfer](#) in the Alibaba Cloud documentation.
3. Configure DNS for your domain. This includes:
  - [Registering a generic domain name](#).



- [Completing real-name verification for your domain name](#) .
  - [Applying for an Internet Content Provider \(ICP\) filing](#) .
  - [Enabling domain name resolution](#).  
Use an appropriate root domain, such as **openshiftcorp.com**, or subdomain, such as **clusters.openshiftcorp.com**.
4. If you are using a subdomain, follow the procedures of your company to add its delegation records to the parent domain.

#### 4.1.4. Supported Alibaba regions

You can deploy an OpenShift Container Platform cluster to the regions listed in the [Alibaba Regions and zones documentation](#).

#### 4.1.5. Next steps

- [Create the required Alibaba Cloud resources](#) .

## 4.2. CREATING THE REQUIRED ALIBABA CLOUD RESOURCES

Before you install OpenShift Container Platform, you must use the Alibaba Cloud console to create a Resource Access Management (RAM) user that has sufficient permissions to install OpenShift Container Platform into your Alibaba Cloud. This user must also have permissions to create new RAM users. You can also configure and use the **ccocli** tool to create new credentials for the OpenShift Container Platform components with the permissions that they require.



### IMPORTANT

Alibaba Cloud on OpenShift Container Platform is a Technology Preview feature only. Technology Preview features are not supported with Red Hat production service level agreements (SLAs) and might not be functionally complete. Red Hat does not recommend using them in production. These features provide early access to upcoming product features, enabling customers to test functionality and provide feedback during the development process.

For more information about the support scope of Red Hat Technology Preview features, see [Technology Preview Features Support Scope](#) .

### 4.2.1. Creating the required RAM user

You must have a Alibaba Cloud Resource Access Management (RAM) user for the installation that has sufficient privileges. You can use the Alibaba Cloud Resource Access Management console to create a new user or modify an existing user. Later, you create credentials in OpenShift Container Platform based on this user's permissions.

When you configure the RAM user, be sure to consider the following requirements:

- The user must have an Alibaba Cloud AccessKey ID and AccessKey secret pair.
  - For a new user, you can select **Open API Access** for the Access Mode when creating the user. This mode generates the required AccessKey pair.

- For an existing user, you can add an AccessKey pair or you can [obtain the AccessKey pair](#) for that user.



#### NOTE

When created, the AccessKey secret is displayed only once. You must immediately save the AccessKey pair because the AccessKey pair is required for API calls.

- Add the AccessKey ID and secret to the `~/.alibabacloud/credentials` file on your local computer. Alibaba Cloud automatically creates this file when you log in to the console. The Cloud Credential Operator (CCO) utility, `ccoutil`, uses these credentials when processing **Credential Request** objects.

For example:

```
[default]                # Default client
type = access_key        # Certification type: access_key
access_key_id = LTAI5t8cefXKmt    # Key 1
access_key_secret = wYx56mszAN4Uunfh    # Secret
```

- 1 Add your AccessKeyID and AccessKeySecret here.

- The RAM user must have the **AdministratorAccess** policy to ensure that the account has sufficient permission to create the OpenShift Container Platform cluster. This policy grants permissions to manage all Alibaba Cloud resources. When you attach the **AdministratorAccess** policy to a RAM user, you grant that user full access to all Alibaba Cloud services and resources. If you do not want to create a user with full access, create a custom policy with the following actions that you can add to your RAM user for installation. These actions are sufficient to install OpenShift Container Platform.

#### TIP

You can copy and paste the following JSON code into the Alibaba Cloud console to create a custom policy. For information on creating custom policies, see [Create a custom policy](#) in the Alibaba Cloud documentation.

#### Example 4.1. Example custom policy JSON file

```
{
  "Version": "1",
  "Statement": [
    {
      "Action": [
        "tag:ListTagResources",
        "tag:UntagResources"
      ],
      "Resource": "*",
      "Effect": "Allow"
    },
    {
      "Action": [
        "vpc:DescribeVpcs",
        "vpc:DeleteVpc",

```

```

    "vpc:DescribeVSwitches",
    "vpc:DeleteVSwitch",
    "vpc:DescribeEipAddresses",
    "vpc:DescribeNatGateways",
    "vpc:ReleaseEipAddress",
    "vpc:DeleteNatGateway",
    "vpc:DescribeSnatTableEntries",
    "vpc:CreateSnatEntry",
    "vpc:AssociateEipAddress",
    "vpc:ListTagResources",
    "vpc:TagResources",
    "vpc:DescribeVSwitchAttributes",
    "vpc:CreateVSwitch",
    "vpc:CreateNatGateway",
    "vpc:DescribeRouteTableList",
    "vpc:CreateVpc",
    "vpc:AllocateEipAddress",
    "vpc:ListEnhancedNatGatewayAvailableZones"
  ],
  "Resource": "*",
  "Effect": "Allow"
},
{
  "Action": [
    "ecs:ModifyInstanceAttribute",
    "ecs:DescribeSecurityGroups",
    "ecs>DeleteSecurityGroup",
    "ecs:DescribeSecurityGroupReferences",
    "ecs:DescribeSecurityGroupAttribute",
    "ecs:RevokeSecurityGroup",
    "ecs:DescribeInstances",
    "ecs>DeleteInstances",
    "ecs:DescribeNetworkInterfaces",
    "ecs:DescribeInstanceRamRole",
    "ecs:DescribeUserData",
    "ecs:DescribeDisks",
    "ecs:ListTagResources",
    "ecs:AuthorizeSecurityGroup",
    "ecs:RunInstances",
    "ecs:TagResources",
    "ecs:ModifySecurityGroupPolicy",
    "ecs:CreateSecurityGroup",
    "ecs:DescribeAvailableResource",
    "ecs:DescribeRegions",
    "ecs:AttachInstanceRamRole"
  ],
  "Resource": "*",
  "Effect": "Allow"
},
{
  "Action": [
    "pvtz:DescribeRegions",
    "pvtz:DescribeZones",
    "pvtz>DeleteZone",
    "pvtz>DeleteZoneRecord",
    "pvtz:BindZoneVpc",

```

```

    "pvtz:DescribeZoneRecords",
    "pvtz:AddZoneRecord",
    "pvtz:SetZoneRecordStatus",
    "pvtz:DescribeZoneInfo",
    "pvtz:DescribeSyncEcsHostTask",
    "pvtz:AddZone"
  ],
  "Resource": "*",
  "Effect": "Allow"
},
{
  "Action": [
    "slb:DescribeLoadBalancers",
    "slb:SetLoadBalancerDeleteProtection",
    "slb>DeleteLoadBalancer",
    "slb:SetLoadBalancerModificationProtection",
    "slb:DescribeLoadBalancerAttribute",
    "slb:AddBackendServers",
    "slb:DescribeLoadBalancerTCPLListenerAttribute",
    "slb:SetLoadBalancerTCPLListenerAttribute",
    "slb:StartLoadBalancerListener",
    "slb:CreateLoadBalancerTCPLListener",
    "slb:ListTagResources",
    "slb:TagResources",
    "slb:CreateLoadBalancer"
  ],
  "Resource": "*",
  "Effect": "Allow"
},
{
  "Action": [
    "ram:ListResourceGroups",
    "ram>DeleteResourceGroup",
    "ram:ListPolicyAttachments",
    "ram:DetachPolicy",
    "ram:GetResourceGroup",
    "ram>CreateResourceGroup",
    "ram>DeleteRole",
    "ram:GetPolicy",
    "ram>DeletePolicy",
    "ram:ListPoliciesForRole",
    "ram>CreateRole",
    "ram:AttachPolicyToRole",
    "ram:GetRole",
    "ram>CreatePolicy",
    "ram>CreateUser",
    "ram:DetachPolicyFromRole",
    "ram>CreatePolicyVersion",
    "ram:DetachPolicyFromUser",
    "ram:ListPoliciesForUser",
    "ram:AttachPolicyToUser",
    "ram>CreateUser",
    "ram:GetUser",
    "ram>DeleteUser",
    "ram>CreateAccessKey",
    "ram:ListAccessKeys",

```

```

    "ram:DeleteAccessKey",
    "ram:ListUsers",
    "ram:ListPolicyVersions"
  ],
  "Resource": "*",
  "Effect": "Allow"
},
{
  "Action": [
    "oss:DeleteBucket",
    "oss:DeleteBucketTagging",
    "oss:GetBucketTagging",
    "oss:GetBucketCors",
    "oss:GetBucketPolicy",
    "oss:GetBucketLifecycle",
    "oss:GetBucketReferer",
    "oss:GetBucketTransferAcceleration",
    "oss:GetBucketLog",
    "oss:GetBucketWebSite",
    "oss:GetBucketInfo",
    "oss:PutBucketTagging",
    "oss:PutBucket",
    "oss:OpenOssService",
    "oss:ListBuckets",
    "oss:GetService",
    "oss:PutBucketACL",
    "oss:GetBucketLogging",
    "oss:ListObjects",
    "oss:GetObject",
    "oss:PutObject",
    "oss:DeleteObject"
  ],
  "Resource": "*",
  "Effect": "Allow"
},
{
  "Action": [
    "alidns:DescribeDomainRecords",
    "alidns>DeleteDomainRecord",
    "alidns:DescribeDomains",
    "alidns:DescribeDomainRecordInfo",
    "alidns:AddDomainRecord",
    "alidns:SetDomainRecordStatus"
  ],
  "Resource": "*",
  "Effect": "Allow"
},
{
  "Action": "bssapi>CreateInstance",
  "Resource": "*",
  "Effect": "Allow"
},
{
  "Action": "ram:PassRole",
  "Resource": "*",
  "Effect": "Allow",

```

```

"Condition": {
  "StringEquals": {
    "acs:Service": "ecs.aliyuncs.com"
  }
}
]
}

```

For more information about creating a RAM user and granting permissions, see [Create a RAM user](#) and [Grant permissions to a RAM user](#) in the Alibaba Cloud documentation.

#### 4.2.2. Configuring the Cloud Credential Operator utility

To assign RAM users and policies that provide long-lived RAM AccessKeys (AKs) for each in-cluster component, extract and prepare the Cloud Credential Operator (CCO) utility (**ccoctl**) binary.

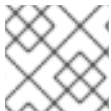

#### NOTE

The **ccoctl** utility is a Linux binary that must run in a Linux environment.

#### Prerequisites

- You have access to an OpenShift Container Platform account with cluster administrator access.
- You have installed the OpenShift CLI (**oc**).

#### Procedure

1. Obtain the OpenShift Container Platform release image:

```
$ RELEASE_IMAGE=$(./openshift-install version | awk '/release image/ {print $3}')
```

2. Get the CCO container image from the OpenShift Container Platform release image:

```
$ CCO_IMAGE=$(oc adm release info --image-for='cloud-credential-operator'
$RELEASE_IMAGE)
```



#### NOTE

Ensure that the architecture of the **\$RELEASE\_IMAGE** matches the architecture of the environment in which you will use the **ccoctl** tool.

3. Extract the **ccoctl** binary from the CCO container image within the OpenShift Container Platform release image:

```
$ oc image extract $CCO_IMAGE --file="/usr/bin/ccoctl" -a ~/.pull-secret
```

4. Change the permissions to make **ccoctl** executable:

```
$ chmod 775 ccoctl
```

## Verification

- To verify that **ccoctl** is ready to use, display the help file:

```
$ ccoctl --help
```

### Output of **ccoctl --help**

OpenShift credentials provisioning tool

Usage:

```
ccoctl [command]
```

Available Commands:

alibabacloud Manage credentials objects for alibaba cloud

aws Manage credentials objects for AWS cloud

gcp Manage credentials objects for Google cloud

help Help about any command

ibmcloud Manage credentials objects for IBM Cloud

Flags:

```
-h, --help help for ccoctl
```

Use "ccoctl [command] --help" for more information about a command.

## Additional resources

- [Preparing to update a cluster with manually maintained credentials](#)

### 4.2.3. Next steps

- Install a cluster on Alibaba Cloud infrastructure that is provisioned by the OpenShift Container Platform installation program, by using one of the following methods:
  - [Installing a cluster quickly on Alibaba Cloud](#) You can install a cluster quickly by using the default configuration options.
  - [Installing a customized cluster on Alibaba Cloud](#) The installation program allows for some customization to be applied at the installation stage. Many other customization options are available [post-installation](#).

## 4.3. INSTALLING A CLUSTER QUICKLY ON ALIBABA CLOUD

In OpenShift Container Platform version 4.10, you can install a cluster on Alibaba Cloud that uses the default configuration options.

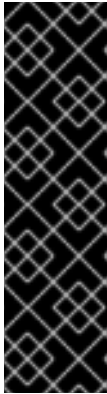

## IMPORTANT

Alibaba Cloud on OpenShift Container Platform is a Technology Preview feature only. Technology Preview features are not supported with Red Hat production service level agreements (SLAs) and might not be functionally complete. Red Hat does not recommend using them in production. These features provide early access to upcoming product features, enabling customers to test functionality and provide feedback during the development process.

For more information about the support scope of Red Hat Technology Preview features, see [Technology Preview Features Support Scope](#).

### 4.3.1. Prerequisites

- You reviewed details about the [OpenShift Container Platform installation and update](#) processes.
- You read the documentation on [selecting a cluster installation method and preparing it for users](#).
- You [registered your domain](#).
- If you use a firewall, you [configured it to allow the sites](#) that your cluster requires access to.
- You have [created the required Alibaba Cloud resources](#).
- If the cloud Resource Access Management (RAM) APIs are not accessible in your environment, or if you do not want to store an administrator-level credential secret in the kube-system namespace, you can [manually create and maintain Resource Access Management \(RAM\) credentials](#).

### 4.3.2. Internet access for OpenShift Container Platform

In OpenShift Container Platform 4.10, you require access to the internet to install your cluster.

You must have internet access to:

- Access [OpenShift Cluster Manager](#) to download the installation program and perform subscription management. If the cluster has internet access and you do not disable Telemetry, that service automatically entitles your cluster.
- Access [Quay.io](#) to obtain the packages that are required to install your cluster.
- Obtain the packages that are required to perform cluster updates.



## IMPORTANT

If your cluster cannot have direct internet access, you can perform a restricted network installation on some types of infrastructure that you provision. During that process, you download the required content and use it to populate a mirror registry with the installation packages. With some installation types, the environment that you install your cluster in will not require internet access. Before you update the cluster, you update the content of the mirror registry.

### 4.3.3. Generating a key pair for cluster node SSH access



During an OpenShift Container Platform installation, you can provide an SSH public key to the installation program. The key is passed to the Red Hat Enterprise Linux CoreOS (RHCOS) nodes through their Ignition config files and is used to authenticate SSH access to the nodes. The key is added to the `~/.ssh/authorized_keys` list for the **core** user on each node, which enables password-less authentication.

After the key is passed to the nodes, you can use the key pair to SSH in to the RHCOS nodes as the user **core**. To access the nodes through SSH, the private key identity must be managed by SSH for your local user.

If you want to SSH in to your cluster nodes to perform installation debugging or disaster recovery, you must provide the SSH public key during the installation process. The `./openshift-install gather` command also requires the SSH public key to be in place on the cluster nodes.

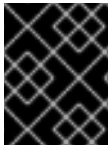

### IMPORTANT

Do not skip this procedure in production environments, where disaster recovery and debugging is required.



### NOTE

You must use a local key, not one that you configured with platform-specific approaches such as [AWS key pairs](#).

## Procedure

1. If you do not have an existing SSH key pair on your local machine to use for authentication onto your cluster nodes, create one. For example, on a computer that uses a Linux operating system, run the following command:

```
$ ssh-keygen -t ed25519 -N "" -f <path>/<file_name> 1
```

- 1 Specify the path and file name, such as `~/.ssh/id_ed25519`, of the new SSH key. If you have an existing key pair, ensure your public key is in the your `~/.ssh` directory.



### NOTE

If you plan to install an OpenShift Container Platform cluster that uses FIPS validated or Modules In Process cryptographic libraries on the **x86\_64** architecture, do not create a key that uses the **ed25519** algorithm. Instead, create a key that uses the **rsa** or **ecdsa** algorithm.

2. View the public SSH key:

```
$ cat <path>/<file_name>.pub
```

For example, run the following to view the `~/.ssh/id_ed25519.pub` public key:

```
$ cat ~/.ssh/id_ed25519.pub
```

3. Add the SSH private key identity to the SSH agent for your local user, if it has not already been added. SSH agent management of the key is required for password-less SSH authentication onto your cluster nodes, or if you want to use the `./openshift-install gather` command.

**NOTE**

On some distributions, default SSH private key identities such as `~/.ssh/id_rsa` and `~/.ssh/id_dsa` are managed automatically.

- a. If the **ssh-agent** process is not already running for your local user, start it as a background task:

```
$ eval "$(ssh-agent -s)"
```

**Example output**

```
Agent pid 31874
```

**NOTE**

If your cluster is in FIPS mode, only use FIPS-compliant algorithms to generate the SSH key. The key must be either RSA or ECDSA.

4. Add your SSH private key to the **ssh-agent**:

```
$ ssh-add <path>/<file_name> 1
```

- 1** Specify the path and file name for your SSH private key, such as `~/.ssh/id_ed25519`

**Example output**

```
Identity added: /home/<you>/<path>/<file_name> (<computer_name>)
```

**Next steps**

- When you install OpenShift Container Platform, provide the SSH public key to the installation program.

**4.3.4. Obtaining the installation program**

Before you install OpenShift Container Platform, download the installation file on a local computer.

**Prerequisites**

- You have a computer that runs Linux or macOS, with 500 MB of local disk space

**Procedure**

1. Access the [Infrastructure Provider](#) page on the OpenShift Cluster Manager site. If you have a Red Hat account, log in with your credentials. If you do not, create an account.

2. Select your infrastructure provider.
3. Navigate to the page for your installation type, download the installation program that corresponds with your host operating system and architecture, and place the file in the directory where you will store the installation configuration files.

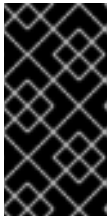

### IMPORTANT

The installation program creates several files on the computer that you use to install your cluster. You must keep the installation program and the files that the installation program creates after you finish installing the cluster. Both files are required to delete the cluster.

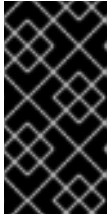

### IMPORTANT

Deleting the files created by the installation program does not remove your cluster, even if the cluster failed during installation. To remove your cluster, complete the OpenShift Container Platform uninstallation procedures for your specific cloud provider.

4. Extract the installation program. For example, on a computer that uses a Linux operating system, run the following command:

```
$ tar -xvf openshift-install-linux.tar.gz
```

5. Download your installation [pull secret from the Red Hat OpenShift Cluster Manager](#) . This pull secret allows you to authenticate with the services that are provided by the included authorities, including Quay.io, which serves the container images for OpenShift Container Platform components.

#### 4.3.5. Creating the installation configuration file

You can customize the OpenShift Container Platform cluster you install on Alibaba Cloud.

##### Prerequisites

- Obtain the OpenShift Container Platform installation program and the pull secret for your cluster.
- Obtain service principal permissions at the subscription level.

##### Procedure

1. Create the **install-config.yaml** file.
  - a. Change to the directory that contains the installation program and run the following command:

```
$ ./openshift-install create install-config --dir <installation_directory> 1
```

- 1** For **<installation\_directory>**, specify the directory name to store the files that the installation program creates.

**IMPORTANT**

Specify an empty directory. Some installation assets, like bootstrap X.509 certificates have short expiration intervals, so you must not reuse an installation directory. If you want to reuse individual files from another cluster installation, you can copy them into your directory. However, the file names for the installation assets might change between releases. Use caution when copying installation files from an earlier OpenShift Container Platform version.

- b. At the prompts, provide the configuration details for your cloud:
  - i. Optional: Select an SSH key to use to access your cluster machines.

**NOTE**

For production OpenShift Container Platform clusters on which you want to perform installation debugging or disaster recovery, specify an SSH key that your **ssh-agent** process uses.

- ii. Select **alibabacloud** as the platform to target.
  - iii. Select the region to deploy the cluster to.
  - iv. Select the base domain to deploy the cluster to. The base domain corresponds to the public DNS zone that you created for your cluster.
  - v. Provide a descriptive name for your cluster.
  - vi. Paste the [pull secret from the Red Hat OpenShift Cluster Manager](#) .
2. Installing the cluster into Alibaba Cloud requires that the Cloud Credential Operator (CCO) operate in manual mode. Modify the **install-config.yaml** file to set the **credentialsMode** parameter to **Manual**:

**Example install-config.yaml configuration file with credentialsMode set to Manual**

```
apiVersion: v1
baseDomain: cluster1.example.com
credentialsMode: Manual 1
compute:
- architecture: amd64
  hyperthreading: Enabled
...
```

- 1** Add this line to set the **credentialsMode** to **Manual**.

3. Back up the **install-config.yaml** file so that you can use it to install multiple clusters.

**IMPORTANT**

The **install-config.yaml** file is consumed during the installation process. If you want to reuse the file, you must back it up now.

### 4.3.6. Generating the required installation manifests

You must generate the Kubernetes manifest and Ignition config files that the cluster needs to configure the machines.

#### Procedure

1. Generate the manifests by running the following command from the directory that contains the installation program:

```
$ openshift-install create manifests --dir <installation_directory>
```

where:

**<installation\_directory>**

Specifies the directory in which the installation program creates files.

### 4.3.7. Creating credentials for OpenShift Container Platform components with the `ccoctl` tool

You can use the OpenShift Container Platform Cloud Credential Operator (CCO) utility to automate the creation of Alibaba Cloud RAM users and policies for each in-cluster component.



#### NOTE

By default, `ccoctl` creates objects in the directory in which the commands are run. To create the objects in a different directory, use the `--output-dir` flag. This procedure uses `<path_to_ccoctl_output_dir>` to refer to this directory.

#### Prerequisites

You must have:

- Extracted and prepared the `ccoctl` binary.
- Created a RAM user with sufficient permission to create the OpenShift Container Platform cluster.
- Added the AccessKeyID (`access_key_id`) and AccessKeySecret (`access_key_secret`) of that RAM user into the `~/.alibabacloud/credentials` file on your local computer.

#### Procedure

1. Set the `$RELEASE_IMAGE` variable by running the following command:

```
$ RELEASE_IMAGE=$(./openshift-install version | awk 'release image/ {print $3}')
```

2. Extract the list of `CredentialsRequest` objects from the OpenShift Container Platform release image by running the following command:

```
$ oc adm release extract \
  --credentials-requests \
  --cloud=alibabacloud \
```

```
--to=<path_to_directory_with_list_of_credentials_requests>/credrequests \ 1
$RELEASE_IMAGE
```

- 1** **credrequests** is the directory where the list of **CredentialsRequest** objects is stored. This command creates the directory if it does not exist.



#### NOTE

This command can take a few moments to run.

3. If your cluster uses cluster capabilities to disable one or more optional components, delete the **CredentialsRequest** custom resources for any disabled components.

### Example credrequests directory contents for OpenShift Container Platform 4.12 on Alibaba Cloud

```
0000_30_machine-api-operator_00_credentials-request.yaml 1
0000_50_cluster-image-registry-operator_01-registry-credentials-request-alibaba.yaml 2
0000_50_cluster-ingress-operator_00-ingress-credentials-request.yaml 3
0000_50_cluster-storage-operator_03_credentials_request_alibaba.yaml 4
```

- 1** The Machine API Operator CR is required.
- 2** The Image Registry Operator CR is required.
- 3** The Ingress Operator CR is required.
- 4** The Storage Operator CR is an optional component and might be disabled in your cluster.

4. Use the **ccoctl** tool to process all **CredentialsRequest** objects in the **credrequests** directory:
  - a. Run the following command to use the tool:

```
$ ccoctl alibabacloud create-ram-users \
--name <name> \
--region=<alibaba_region> \
--credentials-requests-dir=
<path_to_directory_with_list_of_credentials_requests>/credrequests \
--output-dir=<path_to_ccoctl_output_dir>
```

where:

- **<name>** is the name used to tag any cloud resources that are created for tracking.
- **<alibaba\_region>** is the Alibaba Cloud region in which cloud resources will be created.
- **<path\_to\_directory\_with\_list\_of\_credentials\_requests>/credrequests** is the directory containing the files for the component **CredentialsRequest** objects.
- **<path\_to\_ccoctl\_output\_dir>** is the directory where the generated component credentials secrets will be placed.

**NOTE**

If your cluster uses Technology Preview features that are enabled by the **TechPreviewNoUpgrade** feature set, you must include the **--enable-tech-preview** parameter.

**Example output**

```
2022/02/11 16:18:26 Created RAM User: user1-alicloud-openshift-machine-api-
alibabacloud-credentials
2022/02/11 16:18:27 Ready for creating new ram policy user1-alicloud-openshift-
machine-api-alibabacloud-credentials-policy-policy
2022/02/11 16:18:27 RAM policy user1-alicloud-openshift-machine-api-alibabacloud-
credentials-policy-policy has created
2022/02/11 16:18:28 Policy user1-alicloud-openshift-machine-api-alibabacloud-
credentials-policy-policy has attached on user user1-alicloud-openshift-machine-api-
alibabacloud-credentials
2022/02/11 16:18:29 Created access keys for RAM User: user1-alicloud-openshift-
machine-api-alibabacloud-credentials
2022/02/11 16:18:29 Saved credentials configuration to: user1-
alicloud/manifests/openshift-machine-api-alibabacloud-credentials-credentials.yaml
...
```

**NOTE**

A RAM user can have up to two AccessKeys at the same time. If you run **ccoctl alibabacloud create-ram-users** more than twice, the previous generated manifests secret becomes stale and you must reapply the newly generated secrets.

- b. Verify that the OpenShift Container Platform secrets are created:

```
$ ls <path_to_ccoctl_output_dir>/manifests
```

**Example output:**

```
openshift-cluster-csi-drivers-alibaba-disk-credentials-credentials.yaml
openshift-image-registry-installer-cloud-credentials-credentials.yaml
openshift-ingress-operator-cloud-credentials-credentials.yaml
openshift-machine-api-alibabacloud-credentials-credentials.yaml
```

You can verify that the RAM users and policies are created by querying Alibaba Cloud. For more information, refer to Alibaba Cloud documentation on listing RAM users and policies.

5. Copy the generated credential files to the target manifests directory:

```
$ cp ./<path_to_ccoctl_output_dir>/manifests/*credentials.yaml
./<path_to_installation>dir>/manifests/
```

where:

**<path\_to\_ccoctl\_output\_dir>**

Specifies the directory created by the **ccoctl alibabacloud create-ram-users** command.

**<path\_to\_installation\_dir>**

Specifies the directory in which the installation program creates files.

### 4.3.8. Deploying the cluster

You can install OpenShift Container Platform on a compatible cloud platform.



#### IMPORTANT

You can run the **create cluster** command of the installation program only once, during initial installation.

#### Prerequisites

- Configure an account with the cloud platform that hosts your cluster.
- Obtain the OpenShift Container Platform installation program and the pull secret for your cluster.

#### Procedure

1. Change to the directory that contains the installation program and initialize the cluster deployment:

```
$ ./openshift-install create cluster --dir <installation_directory> \ 1
--log-level=info 2
```

- 1** For **<installation\_directory>**, specify the location of your customized **./install-config.yaml** file.
- 2** To view different installation details, specify **warn**, **debug**, or **error** instead of **info**.



#### NOTE

If the cloud provider account that you configured on your host does not have sufficient permissions to deploy the cluster, the installation process stops, and the missing permissions are displayed.

When the cluster deployment completes, directions for accessing your cluster, including a link to its web console and credentials for the **kubeadmin** user, display in your terminal.

#### Example output

```
...
INFO Install complete!
INFO To access the cluster as the system:admin user when using 'oc', run 'export
KUBECONFIG=/home/myuser/install_dir/auth/kubeconfig'
INFO Access the OpenShift web-console here: https://console-openshift-
console.apps.mycluster.example.com
INFO Login to the console with user: "kubeadmin", and password: "4vYBz-Ee6gm-ymBZj-
Wt5AL"
INFO Time elapsed: 36m22s
```



**NOTE**

The cluster access and credential information also outputs to `<installation_directory>/openshift_install.log` when an installation succeeds.

**IMPORTANT**

- The Ignition config files that the installation program generates contain certificates that expire after 24 hours, which are then renewed at that time. If the cluster is shut down before renewing the certificates and the cluster is later restarted after the 24 hours have elapsed, the cluster automatically recovers the expired certificates. The exception is that you must manually approve the pending **node-bootstrapper** certificate signing requests (CSRs) to recover kubelet certificates. See the documentation for *Recovering from expired control plane certificates* for more information.
- It is recommended that you use Ignition config files within 12 hours after they are generated because the 24-hour certificate rotates from 16 to 22 hours after the cluster is installed. By using the Ignition config files within 12 hours, you can avoid installation failure if the certificate update runs during installation.

**IMPORTANT**

You must not delete the installation program or the files that the installation program creates. Both are required to delete the cluster.

### 4.3.9. Installing the OpenShift CLI by downloading the binary

You can install the OpenShift CLI (**oc**) to interact with OpenShift Container Platform from a command-line interface. You can install **oc** on Linux, Windows, or macOS.

**IMPORTANT**

If you installed an earlier version of **oc**, you cannot use it to complete all of the commands in OpenShift Container Platform 4.10. Download and install the new version of **oc**.

#### Installing the OpenShift CLI on Linux

You can install the OpenShift CLI (**oc**) binary on Linux by using the following procedure.

#### Procedure

1. Navigate to the [OpenShift Container Platform downloads page](#) on the Red Hat Customer Portal.
2. Select the appropriate version in the **Version** drop-down menu.
3. Click **Download Now** next to the **OpenShift v4.10 Linux Client** entry and save the file.
4. Unpack the archive:

```
$ tar xvf <file>
```

5. Place the **oc** binary in a directory that is on your **PATH**.

To check your **PATH**, execute the following command:

```
$ echo $PATH
```

After you install the OpenShift CLI, it is available using the **oc** command:

```
$ oc <command>
```

### Installing the OpenShift CLI on Windows

You can install the OpenShift CLI (**oc**) binary on Windows by using the following procedure.

#### Procedure

1. Navigate to the [OpenShift Container Platform downloads page](#) on the Red Hat Customer Portal.
2. Select the appropriate version in the **Version** drop-down menu.
3. Click **Download Now** next to the **OpenShift v4.10 Windows Client** entry and save the file.
4. Unzip the archive with a ZIP program.
5. Move the **oc** binary to a directory that is on your **PATH**.

To check your **PATH**, open the command prompt and execute the following command:

```
C:\> path
```

After you install the OpenShift CLI, it is available using the **oc** command:

```
C:\> oc <command>
```

### Installing the OpenShift CLI on macOS

You can install the OpenShift CLI (**oc**) binary on macOS by using the following procedure.

#### Procedure

1. Navigate to the [OpenShift Container Platform downloads page](#) on the Red Hat Customer Portal.
2. Select the appropriate version in the **Version** drop-down menu.
3. Click **Download Now** next to the **OpenShift v4.10 MacOSX Client** entry and save the file.
4. Unpack and unzip the archive.
5. Move the **oc** binary to a directory on your PATH.

To check your **PATH**, open a terminal and execute the following command:

```
$ echo $PATH
```

After you install the OpenShift CLI, it is available using the **oc** command:

```
$ oc <command>
```

### 4.3.10. Logging in to the cluster by using the CLI

You can log in to your cluster as a default system user by exporting the cluster **kubeconfig** file. The **kubeconfig** file contains information about the cluster that is used by the CLI to connect a client to the correct cluster and API server. The file is specific to a cluster and is created during OpenShift Container Platform installation.

#### Prerequisites

- You deployed an OpenShift Container Platform cluster.
- You installed the **oc** CLI.

#### Procedure

1. Export the **kubeadmin** credentials:

```
$ export KUBECONFIG=<installation_directory>/auth/kubeconfig 1
```

- 1** For **<installation\_directory>**, specify the path to the directory that you stored the installation files in.

2. Verify you can run **oc** commands successfully using the exported configuration:

```
$ oc whoami
```

#### Example output

```
system:admin
```

### 4.3.11. Logging in to the cluster by using the web console

The **kubeadmin** user exists by default after an OpenShift Container Platform installation. You can log in to your cluster as the **kubeadmin** user by using the OpenShift Container Platform web console.

#### Prerequisites

- You have access to the installation host.
- You completed a cluster installation and all cluster Operators are available.

#### Procedure

1. Obtain the password for the **kubeadmin** user from the **kubeadmin-password** file on the installation host:

```
$ cat <installation_directory>/auth/kubeadmin-password
```



#### NOTE

Alternatively, you can obtain the **kubeadmin** password from the **<installation\_directory>/openshift\_install.log** log file on the installation host.

2. List the OpenShift Container Platform web console route:

```
$ oc get routes -n openshift-console | grep 'console-openshift'
```



#### NOTE

Alternatively, you can obtain the OpenShift Container Platform route from the `<installation_directory>/openshift_install.log` log file on the installation host.

#### Example output

```
console    console-openshift-console.apps.<cluster_name>.<base_domain>    console
https     reencrypt/Redirect    None
```

3. Navigate to the route detailed in the output of the preceding command in a web browser and log in as the **kubeadmin** user.

### 4.3.12. Telemetry access for OpenShift Container Platform

In OpenShift Container Platform 4.10, the Telemetry service, which runs by default to provide metrics about cluster health and the success of updates, requires internet access. If your cluster is connected to the internet, Telemetry runs automatically, and your cluster is registered to [OpenShift Cluster Manager](#).

After you confirm that your [OpenShift Cluster Manager](#) inventory is correct, either maintained automatically by Telemetry or manually by using OpenShift Cluster Manager, [use subscription watch](#) to track your OpenShift Container Platform subscriptions at the account or multi-cluster level.

#### Additional resources

- See [Accessing the web console](#) for more details about accessing and understanding the OpenShift Container Platform web console.
- See [About remote health monitoring](#) for more information about the Telemetry service

### 4.3.13. Next steps

- [Validating an installation](#).
- [Customize your cluster](#).
- If necessary, you can [opt out of remote health reporting](#).

## 4.4. INSTALLING A CLUSTER ON ALIBABA CLOUD WITH CUSTOMIZATIONS

In OpenShift Container Platform version 4.10, you can install a customized cluster on infrastructure that the installation program provisions on Alibaba Cloud. To customize the installation, you modify parameters in the `install-config.yaml` file before you install the cluster.



## NOTE

The scope of the OpenShift Container Platform installation configurations is intentionally narrow. It is designed for simplicity and ensured success. You can complete many more OpenShift Container Platform configuration tasks after an installation completes.



## IMPORTANT

Alibaba Cloud on OpenShift Container Platform is a Technology Preview feature only. Technology Preview features are not supported with Red Hat production service level agreements (SLAs) and might not be functionally complete. Red Hat does not recommend using them in production. These features provide early access to upcoming product features, enabling customers to test functionality and provide feedback during the development process.

For more information about the support scope of Red Hat Technology Preview features, see [Technology Preview Features Support Scope](#).

### 4.4.1. Prerequisites

- You reviewed details about the [OpenShift Container Platform installation and update](#) processes.
- You read the documentation on [selecting a cluster installation method and preparing it for users](#).
- You [registered your domain](#).
- If you use a firewall, you [configured it to allow the sites](#) that your cluster requires access to.
- If the cloud Resource Access Management (RAM) APIs are not accessible in your environment, or if you do not want to store an administrator-level credential secret in the **kube-system** namespace, you can [manually create and maintain Resource Access Management \(RAM\) credentials](#).

### 4.4.2. Internet access for OpenShift Container Platform

In OpenShift Container Platform 4.10, you require access to the internet to install your cluster.

You must have internet access to:

- Access [OpenShift Cluster Manager](#) to download the installation program and perform subscription management. If the cluster has internet access and you do not disable Telemetry, that service automatically entitles your cluster.
- Access [Quay.io](#) to obtain the packages that are required to install your cluster.
- Obtain the packages that are required to perform cluster updates.



### IMPORTANT

If your cluster cannot have direct internet access, you can perform a restricted network installation on some types of infrastructure that you provision. During that process, you download the required content and use it to populate a mirror registry with the installation packages. With some installation types, the environment that you install your cluster in will not require internet access. Before you update the cluster, you update the content of the mirror registry.

#### 4.4.3. Generating a key pair for cluster node SSH access

During an OpenShift Container Platform installation, you can provide an SSH public key to the installation program. The key is passed to the Red Hat Enterprise Linux CoreOS (RHCOS) nodes through their Ignition config files and is used to authenticate SSH access to the nodes. The key is added to the `~/.ssh/authorized_keys` list for the **core** user on each node, which enables password-less authentication.

After the key is passed to the nodes, you can use the key pair to SSH in to the RHCOS nodes as the user **core**. To access the nodes through SSH, the private key identity must be managed by SSH for your local user.

If you want to SSH in to your cluster nodes to perform installation debugging or disaster recovery, you must provide the SSH public key during the installation process. The `./openshift-install gather` command also requires the SSH public key to be in place on the cluster nodes.

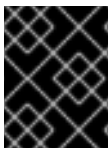

### IMPORTANT

Do not skip this procedure in production environments, where disaster recovery and debugging is required.



### NOTE

You must use a local key, not one that you configured with platform-specific approaches such as [AWS key pairs](#).

#### Procedure

1. If you do not have an existing SSH key pair on your local machine to use for authentication onto your cluster nodes, create one. For example, on a computer that uses a Linux operating system, run the following command:

```
$ ssh-keygen -t ed25519 -N "" -f <path>/<file_name> 1
```

- 1 Specify the path and file name, such as `~/.ssh/id_ed25519`, of the new SSH key. If you have an existing key pair, ensure your public key is in the your `~/.ssh` directory.



### NOTE

If you plan to install an OpenShift Container Platform cluster that uses FIPS validated or Modules In Progress cryptographic libraries on the **x86\_64** architecture, do not create a key that uses the **ed25519** algorithm. Instead, create a key that uses the **rsa** or **ecdsa** algorithm.

- View the public SSH key:

```
$ cat <path>/<file_name>.pub
```

For example, run the following to view the `~/.ssh/id_ed25519.pub` public key:

```
$ cat ~/.ssh/id_ed25519.pub
```

- Add the SSH private key identity to the SSH agent for your local user, if it has not already been added. SSH agent management of the key is required for password-less SSH authentication onto your cluster nodes, or if you want to use the `./openshift-install gather` command.

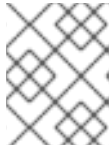

#### NOTE

On some distributions, default SSH private key identities such as `~/.ssh/id_rsa` and `~/.ssh/id_dsa` are managed automatically.

- If the `ssh-agent` process is not already running for your local user, start it as a background task:

```
$ eval "$(ssh-agent -s)"
```

#### Example output

```
Agent pid 31874
```



#### NOTE

If your cluster is in FIPS mode, only use FIPS-compliant algorithms to generate the SSH key. The key must be either RSA or ECDSA.

- Add your SSH private key to the `ssh-agent`:

```
$ ssh-add <path>/<file_name> 1
```

- 1** Specify the path and file name for your SSH private key, such as `~/.ssh/id_ed25519`

#### Example output

```
Identity added: /home/<you>/<path>/<file_name> (<computer_name>)
```

#### Next steps

- When you install OpenShift Container Platform, provide the SSH public key to the installation program.

#### 4.4.4. Obtaining the installation program

Before you install OpenShift Container Platform, download the installation file on a local computer.

## Prerequisites

- You have a computer that runs Linux or macOS, with 500 MB of local disk space

## Procedure

1. Access the [Infrastructure Provider](#) page on the OpenShift Cluster Manager site. If you have a Red Hat account, log in with your credentials. If you do not, create an account.
2. Select your infrastructure provider.
3. Navigate to the page for your installation type, download the installation program that corresponds with your host operating system and architecture, and place the file in the directory where you will store the installation configuration files.

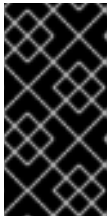

### IMPORTANT

The installation program creates several files on the computer that you use to install your cluster. You must keep the installation program and the files that the installation program creates after you finish installing the cluster. Both files are required to delete the cluster.



### IMPORTANT

Deleting the files created by the installation program does not remove your cluster, even if the cluster failed during installation. To remove your cluster, complete the OpenShift Container Platform uninstallation procedures for your specific cloud provider.

4. Extract the installation program. For example, on a computer that uses a Linux operating system, run the following command:

```
$ tar -xvf openshift-install-linux.tar.gz
```

5. Download your installation [pull secret from the Red Hat OpenShift Cluster Manager](#) . This pull secret allows you to authenticate with the services that are provided by the included authorities, including Quay.io, which serves the container images for OpenShift Container Platform components.

### 4.4.4.1. Creating the installation configuration file

You can customize the OpenShift Container Platform cluster you install on Alibaba Cloud.

## Prerequisites

- Obtain the OpenShift Container Platform installation program and the pull secret for your cluster.
- Obtain service principal permissions at the subscription level.

## Procedure

1. Create the **install-config.yaml** file.



- a. Change to the directory that contains the installation program and run the following command:

```
$ ./openshift-install create install-config --dir <installation_directory> 1
```

- 1** For **<installation\_directory>**, specify the directory name to store the files that the installation program creates.



### IMPORTANT

Specify an empty directory. Some installation assets, like bootstrap X.509 certificates have short expiration intervals, so you must not reuse an installation directory. If you want to reuse individual files from another cluster installation, you can copy them into your directory. However, the file names for the installation assets might change between releases. Use caution when copying installation files from an earlier OpenShift Container Platform version.

- b. At the prompts, provide the configuration details for your cloud:
- i. Optional: Select an SSH key to use to access your cluster machines.



### NOTE

For production OpenShift Container Platform clusters on which you want to perform installation debugging or disaster recovery, specify an SSH key that your **ssh-agent** process uses.

- ii. Select **alibabacloud** as the platform to target.
- iii. Select the region to deploy the cluster to.
- iv. Select the base domain to deploy the cluster to. The base domain corresponds to the public DNS zone that you created for your cluster.
- v. Provide a descriptive name for your cluster.
- vi. Paste the [pull secret from the Red Hat OpenShift Cluster Manager](#) .
2. Installing the cluster into Alibaba Cloud requires that the Cloud Credential Operator (CCO) operate in manual mode. Modify the **install-config.yaml** file to set the **credentialsMode** parameter to **Manual**:

### Example install-config.yaml configuration file with credentialsMode set to Manual

```
apiVersion: v1
baseDomain: cluster1.example.com
credentialsMode: Manual 1
compute:
- architecture: amd64
  hyperthreading: Enabled
...
```

1. Add this line to set the **credentialsMode** to **Manual**.
3. Modify the **install-config.yaml** file. You can find more information about the available parameters in the "Installation configuration parameters" section.
4. Back up the **install-config.yaml** file so that you can use it to install multiple clusters.

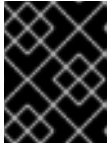

### IMPORTANT

The **install-config.yaml** file is consumed during the installation process. If you want to reuse the file, you must back it up now.

#### 4.4.4.2. Generating the required installation manifests

You must generate the Kubernetes manifest and Ignition config files that the cluster needs to configure the machines.

##### Procedure

1. Generate the manifests by running the following command from the directory that contains the installation program:

```
$ openshift-install create manifests --dir <installation_directory>
```

where:

**<installation\_directory>**

Specifies the directory in which the installation program creates files.

#### 4.4.4.3. Creating credentials for OpenShift Container Platform components with the **ccoctl** tool

You can use the OpenShift Container Platform Cloud Credential Operator (CCO) utility to automate the creation of Alibaba Cloud RAM users and policies for each in-cluster component.

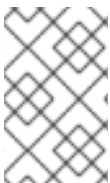

### NOTE

By default, **ccoctl** creates objects in the directory in which the commands are run. To create the objects in a different directory, use the **--output-dir** flag. This procedure uses **<path\_to\_ccoctl\_output\_dir>** to refer to this directory.

##### Prerequisites

You must have:

- Extracted and prepared the **ccoctl** binary.
- Created a RAM user with sufficient permission to create the OpenShift Container Platform cluster.
- Added the AccessKeyID (**access\_key\_id**) and AccessKeySecret (**access\_key\_secret**) of that RAM user into the [~/alibabacloud/credentials](#) file on your local computer.

##### Procedure

## Procedure

1. Set the **\$RELEASE\_IMAGE** variable by running the following command:

```
$ RELEASE_IMAGE=$(./openshift-install version | awk '/release image/ {print $3}')
```

2. Extract the list of **CredentialsRequest** objects from the OpenShift Container Platform release image by running the following command:

```
$ oc adm release extract \
--credentials-requests \
--cloud=alibabacloud \
--to=<path_to_directory_with_list_of_credentials_requests>/credrequests \ 1
$RELEASE_IMAGE
```

- 1** **credrequests** is the directory where the list of **CredentialsRequest** objects is stored. This command creates the directory if it does not exist.



### NOTE

This command can take a few moments to run.

3. If your cluster uses cluster capabilities to disable one or more optional components, delete the **CredentialsRequest** custom resources for any disabled components.

### Example credrequests directory contents for OpenShift Container Platform 4.12 on Alibaba Cloud

```
0000_30_machine-api-operator_00_credentials-request.yaml 1
0000_50_cluster-image-registry-operator_01-registry-credentials-request-alibaba.yaml 2
0000_50_cluster-ingress-operator_00-ingress-credentials-request.yaml 3
0000_50_cluster-storage-operator_03_credentials_request_alibaba.yaml 4
```

- 1** The Machine API Operator CR is required.
- 2** The Image Registry Operator CR is required.
- 3** The Ingress Operator CR is required.
- 4** The Storage Operator CR is an optional component and might be disabled in your cluster.

4. Use the **ccoctl** tool to process all **CredentialsRequest** objects in the **credrequests** directory:

- a. Run the following command to use the tool:

```
$ ccoctl alibabacloud create-ram-users \
--name <name> \
--region=<alibaba_region> \
--credentials-requests-dir=
<path_to_directory_with_list_of_credentials_requests>/credrequests \
--output-dir=<path_to_ccoctl_output_dir>
```

where:

- **<name>** is the name used to tag any cloud resources that are created for tracking.
- **<alibaba\_region>** is the Alibaba Cloud region in which cloud resources will be created.
- **<path\_to\_directory\_with\_list\_of\_credentials\_requests>/credrequests** is the directory containing the files for the component **CredentialsRequest** objects.
- **<path\_to\_ccoctl\_output\_dir>** is the directory where the generated component credentials secrets will be placed.



#### NOTE

If your cluster uses Technology Preview features that are enabled by the **TechPreviewNoUpgrade** feature set, you must include the **--enable-tech-preview** parameter.

#### Example output

```
2022/02/11 16:18:26 Created RAM User: user1-alicloud-openshift-machine-api-
alibabacloud-credentials
2022/02/11 16:18:27 Ready for creating new ram policy user1-alicloud-openshift-
machine-api-alibabacloud-credentials-policy-policy
2022/02/11 16:18:27 RAM policy user1-alicloud-openshift-machine-api-alibabacloud-
credentials-policy-policy has created
2022/02/11 16:18:28 Policy user1-alicloud-openshift-machine-api-alibabacloud-
credentials-policy-policy has attached on user user1-alicloud-openshift-machine-api-
alibabacloud-credentials
2022/02/11 16:18:29 Created access keys for RAM User: user1-alicloud-openshift-
machine-api-alibabacloud-credentials
2022/02/11 16:18:29 Saved credentials configuration to: user1-
alicloud/manifests/openshift-machine-api-alibabacloud-credentials-credentials.yaml
...
```



#### NOTE

A RAM user can have up to two AccessKeys at the same time. If you run **ccoctl alibabacloud create-ram-users** more than twice, the previous generated manifests secret becomes stale and you must reapply the newly generated secrets.

- Verify that the OpenShift Container Platform secrets are created:

```
$ ls <path_to_ccoctl_output_dir>/manifests
```

#### Example output:

```
openshift-cluster-csi-drivers-alibaba-disk-credentials-credentials.yaml
openshift-image-registry-installer-cloud-credentials-credentials.yaml
openshift-ingress-operator-cloud-credentials-credentials.yaml
openshift-machine-api-alibabacloud-credentials-credentials.yaml
```

You can verify that the RAM users and policies are created by querying Alibaba Cloud. For more information, refer to Alibaba Cloud documentation on listing RAM users and policies.

5. Copy the generated credential files to the target manifests directory:

```
$ cp ./<path_to_ccoctl_output_dir>/manifests/*credentials.yaml
./<path_to_installation_dir>/manifests/
```

where:

**<path\_to\_ccoctl\_output\_dir>**

Specifies the directory created by the **ccoctl alibabacloud create-ram-users** command.

**<path\_to\_installation\_dir>**

Specifies the directory in which the installation program creates files.

#### 4.4.4.4. Installation configuration parameters

Before you deploy an OpenShift Container Platform cluster, you provide parameter values to describe your account on the cloud platform that hosts your cluster and optionally customize your cluster's platform. When you create the **install-config.yaml** installation configuration file, you provide values for the required parameters through the command line. If you customize your cluster, you can modify the **install-config.yaml** file to provide more details about the platform.



#### NOTE

After installation, you cannot modify these parameters in the **install-config.yaml** file.

##### 4.4.4.4.1. Required configuration parameters

Required installation configuration parameters are described in the following table:

Table 4.1. Required parameters

Parameter	Description	Values
<b>apiVersion</b>	The API version for the <b>install-config.yaml</b> content. The current version is <b>v1</b> . The installer may also support older API versions.	String

Parameter	Description	Values
<b>baseDomain</b>	The base domain of your cloud provider. The base domain is used to create routes to your OpenShift Container Platform cluster components. The full DNS name for your cluster is a combination of the <b>baseDomain</b> and <b>metadata.name</b> parameter values that uses the <b>&lt;metadata.name&gt;</b> . <b>&lt;baseDomain&gt;</b> format.	A fully-qualified domain or subdomain name, such as <b>example.com</b> .
<b>metadata</b>	Kubernetes resource <b>ObjectMeta</b> , from which only the <b>name</b> parameter is consumed.	Object
<b>metadata.name</b>	The name of the cluster. DNS records for the cluster are all subdomains of <b>{{.metadata.name}}</b> . <b>{{.baseDomain}}</b> .	String of lowercase letters, hyphens (-), and periods (.), such as <b>dev</b> .
<b>platform</b>	The configuration for the specific platform upon which to perform the installation: <b>alibabacloud</b> , <b>aws</b> , <b>baremetal</b> , <b>azure</b> , <b>gcp</b> , <b>ibmcloud</b> , <b>openstack</b> , <b>ovirt</b> , <b>vsphere</b> , or <b>{}</b> . For additional information about <b>platform.&lt;platform&gt;</b> parameters, consult the table for your specific platform that follows.	Object
<b>pullSecret</b>	Get a <a href="#">pull secret from the Red Hat OpenShift Cluster Manager</a> to authenticate downloading container images for OpenShift Container Platform components from services such as Quay.io.	<pre>{   "auths":{     "cloud.openshift.com":{       "auth":"b3Blb=",       "email":"you@example.com"     },     "quay.io":{       "auth":"b3Blb=",       "email":"you@example.com"     }   } }</pre>

#### 4.4.4.4.2. Network configuration parameters

You can customize your installation configuration based on the requirements of your existing network infrastructure. For example, you can expand the IP address block for the cluster network or provide different IP address blocks than the defaults.

Only IPv4 addresses are supported.

Table 4.2. Network parameters

Parameter	Description	Values
<b>networking</b>	The configuration for the cluster network.	Object   <b>NOTE</b> You cannot modify parameters specified by the <b>networking</b> object after installation.
<b>networking.network Type</b>	The cluster network provider Container Network Interface (CNI) plugin to install.	Either <b>OpenShiftSDN</b> or <b>OVNKubernetes</b> . <b>OpenShiftSDN</b> is a CNI provider for all-Linux networks. <b>OVNKubernetes</b> is a CNI provider for Linux networks and hybrid networks that contain both Linux and Windows servers. The default value is <b>OpenShiftSDN</b> .
<b>networking.clusterNetwork</b>	The IP address blocks for pods.  The default value is <b>10.128.0.0/14</b> with a host prefix of <b>/23</b> .  If you specify multiple IP address blocks, the blocks must not overlap.	An array of objects. For example:  <pre>networking:   clusterNetwork:     - cidr: 10.128.0.0/14       hostPrefix: 23</pre>
<b>networking.clusterNetwork.cidr</b>	Required if you use <b>networking.clusterNetwork</b> . An IP address block.  An IPv4 network.	An IP address block in Classless Inter-Domain Routing (CIDR) notation. The prefix length for an IPv4 block is between <b>0</b> and <b>32</b> .
<b>networking.clusterNetwork.hostPrefix</b>	The subnet prefix length to assign to each individual node. For example, if <b>hostPrefix</b> is set to <b>23</b> then each node is assigned a <b>/23</b> subnet out of the given <b>cidr</b> . A <b>hostPrefix</b> value of <b>23</b> provides 510 ( $2^{(32 - 23)} - 2$ ) pod IP addresses.	A subnet prefix.  The default value is <b>23</b> .

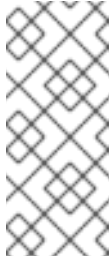
Parameter	Description	Values
<b>networking.serviceNetwork</b>	<p>The IP address block for services. The default value is <b>172.30.0.0/16</b>.</p> <p>The OpenShift SDN and OVN-Kubernetes network providers support only a single IP address block for the service network.</p>	<p>An array with an IP address block in CIDR format. For example:</p> <pre>networking:   serviceNetwork:     - 172.30.0.0/16</pre>
<b>networking.machineNetwork</b>	<p>The IP address blocks for machines.</p> <p>If you specify multiple IP address blocks, the blocks must not overlap.</p>	<p>An array of objects. For example:</p> <pre>networking:   machineNetwork:     - cidr: 10.0.0.0/16</pre>
<b>networking.machineNetwork.cidr</b>	<p>Required if you use <b>networking.machineNetwork</b>. An IP address block. The default value is <b>10.0.0.0/16</b> for all platforms other than libvirt. For libvirt, the default value is <b>192.168.126.0/24</b>.</p>	<p>An IP network block in CIDR notation.</p> <p>For example, <b>10.0.0.0/16</b>.</p> <div style="display: flex; align-items: flex-start;">  <div> <p><b>NOTE</b></p> <p>Set the <b>networking.machineNetwork</b> to match the CIDR that the preferred NIC resides in.</p> </div> </div>

#### 4.4.4.4.3. Optional configuration parameters

Optional installation configuration parameters are described in the following table:

**Table 4.3. Optional parameters**

Parameter	Description	Values
<b>additionalTrustBundle</b>	<p>A PEM-encoded X.509 certificate bundle that is added to the nodes' trusted certificate store. This trust bundle may also be used when a proxy has been configured.</p>	String





Parameter	Description	Values
<b>cgroupsV2</b>	Enables <a href="#">Linux control groups version 2</a> (cgroups v2) on specific nodes in your cluster. The OpenShift Container Platform process for enabling cgroups v2 disables all cgroup version 1 controllers and hierarchies. The OpenShift Container Platform cgroups version 2 feature is in Developer Preview and is not supported by Red Hat at this time.	<b>true</b>
<b>compute</b>	The configuration for the machines that comprise the compute nodes.	Array of <b>MachinePool</b> objects.
<b>compute.architecture</b>	Determines the instruction set architecture of the machines in the pool. Currently, clusters with varied architectures are not supported. All pools must specify the same architecture. Valid values are <b>amd64</b> (the default).	String
<b>compute.hyperthreading</b>	Whether to enable or disable simultaneous multithreading, or <b>hyperthreading</b> , on compute machines. By default, simultaneous multithreading is enabled to increase the performance of your machines' cores.   <b>IMPORTANT</b>  If you disable simultaneous multithreading, ensure that your capacity planning accounts for the dramatically decreased machine performance.	<b>Enabled</b> or <b>Disabled</b>
<b>compute.name</b>	Required if you use <b>compute</b> . The name of the machine pool.	<b>worker</b>
<b>compute.platform</b>	Required if you use <b>compute</b> . Use this parameter to specify the cloud provider to host the worker machines. This parameter value must match the <b>controlPlane.platform</b> parameter value.	<b>alibabacloud, aws, azure, gcp, ibmcloud, openstack, ovirt, vsphere</b> , or <b>{}</b>

Parameter	Description	Values
<b>compute.replicas</b>	The number of compute machines, which are also known as worker machines, to provision.	A positive integer greater than or equal to <b>2</b> . The default value is <b>3</b> .
<b>controlPlane</b>	The configuration for the machines that comprise the control plane.	Array of <b>MachinePool</b> objects.
<b>controlPlane.architecture</b>	Determines the instruction set architecture of the machines in the pool. Currently, clusters with varied architectures are not supported. All pools must specify the same architecture. Valid values are <b>amd64</b> (the default).	String
<b>controlPlane.hyperthreading</b>	<p>Whether to enable or disable simultaneous multithreading, or <b>hyperthreading</b>, on control plane machines. By default, simultaneous multithreading is enabled to increase the performance of your machines' cores.</p> <div style="display: flex; align-items: flex-start;"> <div style="flex: 1;">  </div> <div style="flex: 2;"> <p><b>IMPORTANT</b></p> <p>If you disable simultaneous multithreading, ensure that your capacity planning accounts for the dramatically decreased machine performance.</p> </div> </div>	<b>Enabled</b> or <b>Disabled</b>
<b>controlPlane.name</b>	Required if you use <b>controlPlane</b> . The name of the machine pool.	<b>master</b>

Parameter	Description	Values
<b>controlPlane.platform</b>	Required if you use <b>controlPlane</b> . Use this parameter to specify the cloud provider that hosts the control plane machines. This parameter value must match the <b>compute.platform</b> parameter value.	<b>alibabacloud, aws, azure, gcp, ibmcloud, openstack, ovirt, vsphere</b> , or {}
<b>controlPlane.replicas</b>	The number of control plane machines to provision.	The only supported value is <b>3</b> , which is the default value.
<b>credentialsMode</b>	<p>The Cloud Credential Operator (CCO) mode. If no mode is specified, the CCO dynamically tries to determine the capabilities of the provided credentials, with a preference for mint mode on the platforms where multiple modes are supported.</p> <div style="display: flex; align-items: flex-start;"> <div style="width: 20px; height: 20px; border: 1px solid black; margin-right: 10px;"></div> <div> <p><b>NOTE</b></p> <p>Not all CCO modes are supported for all cloud providers. For more information on CCO modes, see the <i>Cloud Credential Operator</i> entry in the <i>Cluster Operators reference</i> content.</p> </div> </div> <div style="display: flex; align-items: flex-start; margin-top: 10px;"> <div style="width: 20px; height: 20px; border: 1px solid black; margin-right: 10px;"></div> <div> <p><b>NOTE</b></p> <p>If your AWS account has service control policies (SCP) enabled, you must configure the <b>credentialsMode</b> parameter to <b>Mint, Passthrough</b> or <b>Manual</b>.</p> </div> </div>	<b>Mint, Passthrough, Manual</b> or an empty string ("").

Parameter	Description	Values
<b>fips</b>	<p>Enable or disable FIPS mode. The default is <b>false</b> (disabled). If FIPS mode is enabled, the Red Hat Enterprise Linux CoreOS (RHCOS) machines that OpenShift Container Platform runs on bypass the default Kubernetes cryptography suite and use the cryptography modules that are provided with RHCOS instead.</p> <div style="display: flex; align-items: flex-start;"> <div style="width: 20px; height: 100px; background: repeating-linear-gradient(45deg, transparent, transparent 2px, black 2px, black 4px); margin-right: 10px;"></div> <div> <p><b>IMPORTANT</b></p> <p>To enable FIPS mode for your cluster, you must run the installation program from a Red Hat Enterprise Linux (RHEL) computer configured to operate in FIPS mode. For more information about configuring FIPS mode on RHEL, see <a href="#">Installing the system in FIPS mode</a>. The use of FIPS validated or Modules In Process cryptographic libraries is only supported on OpenShift Container Platform deployments on the <b>x86_64</b> architecture.</p> </div> </div> <div style="display: flex; align-items: flex-start; margin-top: 10px;"> <div style="width: 20px; height: 50px; background: repeating-linear-gradient(45deg, transparent, transparent 2px, black 2px, black 4px); margin-right: 10px;"></div> <div> <p><b>NOTE</b></p> <p>If you are using Azure File storage, you cannot enable FIPS mode.</p> </div> </div>	<b>false</b> or <b>true</b>
<b>imageContentSources</b>	Sources and repositories for the release-image content.	Array of objects. Includes a <b>source</b> and, optionally, <b>mirrors</b> , as described in the following rows of this table.
<b>imageContentSources.source</b>	Required if you use <b>imageContentSources</b> . Specify the repository that users refer to, for example, in image pull specifications.	String
<b>imageContentSources.mirrors</b>	Specify one or more repositories that may also contain the same images.	Array of strings

Parameter	Description	Values
<b>publish</b>	How to publish or expose the user-facing endpoints of your cluster, such as the Kubernetes API, OpenShift routes.	<p><b>Internal</b> or <b>External</b>. The default value is <b>External</b>.</p> <p>Setting this field to <b>Internal</b> is not supported on non-cloud platforms and IBM Cloud VPC.</p> <div style="display: flex; align-items: flex-start;">  <div> <p><b>IMPORTANT</b></p> <p>If the value of the field is set to <b>Internal</b>, the cluster will become non-functional. For more information, refer to <a href="#">BZ#1953035</a>.</p> </div> </div>
<b>sshKey</b>	<p>The SSH key or keys to authenticate access your cluster machines.</p> <div style="display: flex; align-items: flex-start;">  <div> <p><b>NOTE</b></p> <p>For production OpenShift Container Platform clusters on which you want to perform installation debugging or disaster recovery, specify an SSH key that your <b>ssh-agent</b> process uses.</p> </div> </div>	<p>One or more keys. For example:</p> <pre>sshKey:   &lt;key1&gt;   &lt;key2&gt;   &lt;key3&gt;</pre>

#### 4.4.4.4.4. Additional Alibaba Cloud configuration parameters

Additional Alibaba Cloud configuration parameters are described in the following table. The **alibabacloud** parameters are the configuration used when installing on Alibaba Cloud. The **defaultMachinePlatform** parameters are the default configuration used when installing on Alibaba Cloud for machine pools that do not define their own platform configuration.

These parameters apply to both compute machines and control plane machines where specified.



#### NOTE

If defined, the parameters **compute.platform.alibabacloud** and **controlPlane.platform.alibabacloud** will overwrite **platform.alibabacloud.defaultMachinePlatform** settings for compute machines and control plane machines respectively.

Table 4.4. Optional Alibaba Cloud parameters

Parameter	Description	Values
<b>compute.platform.alibabacloud.imageID</b>	The imageID used to create the ECS instance. ImageID must belong to the same region as the cluster.	String.
<b>compute.platform.alibabacloud.instanceType</b>	InstanceType defines the ECS instance type. Example: <b>ecs.g6.large</b>	String.
<b>compute.platform.alibabacloud.systemDiskCategory</b>	Defines the category of the system disk. Examples: <b>cloud_efficiency,cloud_essd</b>	String.
<b>compute.platform.alibabacloud.systemDiskSize</b>	Defines the size of the system disk in gibibytes (GiB).	Integer.
<b>compute.platform.alibabacloud.zones</b>	The list of availability zones that can be used. Examples: <b>cn-hangzhou-h, cn-hangzhou-j</b>	String list.
<b>controlPlane.platform.alibabacloud.imageID</b>	The imageID used to create the ECS instance. ImageID must belong to the same region as the cluster.	String.
<b>controlPlane.platform.alibabacloud.instanceType</b>	InstanceType defines the ECS instance type. Example: <b>ecs.g6.xlarge</b>	String.
<b>controlPlane.platform.alibabacloud.systemDiskCategory</b>	Defines the category of the system disk. Examples: <b>cloud_efficiency,cloud_essd</b>	String.
<b>controlPlane.platform.alibabacloud.systemDiskSize</b>	Defines the size of the system disk in gibibytes (GiB).	Integer.
<b>controlPlane.platform.alibabacloud.zones</b>	The list of availability zones that can be used. Examples: <b>cn-hangzhou-h, cn-hangzhou-j</b>	String list.

Parameter	Description	Values
<b>platform.alibabacloud.region</b>	Required.The Alibaba Cloud region where the cluster will be created.	String.
<b>platform.alibabacloud.resourceGroupID</b>	The ID of an already existing resource group where the cluster will be installed. If empty, the installer will create a new resource group for the cluster.	String.
<b>platform.alibabacloud.tags</b>	Additional keys and values to apply to all Alibaba Cloud resources created for the cluster.	Object.
<b>platform.alibabacloud.vpcID</b>	The ID of an already existing VPC where the cluster should be installed. If empty, the installer will create a new VPC for the cluster.	String.
<b>platform.alibabacloud.vswitchIDs</b>	The ID list of already existing VSwitches where cluster resources will be created. The existing VSwitches can only be used when also using existing VPC. If empty, the installer will create new VSwitches for the cluster.	String list.
<b>platform.alibabacloud.defaultMachinePlatformImageID</b>	For both compute machines and control plane machines, the image ID that should be used to create ECS instance. If set, the image ID should belong to the same region as the cluster.	String.
<b>platform.alibabacloud.defaultMachinePlatformInstanceType</b>	For both compute machines and control plane machines, the ECS instance type used to create the ECS instance. Example: <b>ecs.g6.xlarge</b>	String.

Parameter	Description	Values
<b>platform.alibabacloud.defaultMachinePlatform.systemDiskCategory</b>	For both compute machines and control plane machines, the category of the system disk. Examples: <b>cloud_efficiency</b> , <b>cloud_essd</b> .	String, for example "", <b>cloud_efficiency</b> , <b>cloud_essd</b> .
<b>platform.alibabacloud.defaultMachinePlatform.systemDiskSize</b>	For both compute machines and control plane machines, the size of the system disk in gibibytes (GiB). The minimum is <b>120</b> .	Integer.
<b>platform.alibabacloud.defaultMachinePlatform.zones</b>	For both compute machines and control plane machines, the list of availability zones that can be used. Examples: <b>cn-hangzhou-h</b> , <b>cn-hangzhou-j</b>	String list.
<b>platform.alibabacloud.privateZoneID</b>	The ID of an existing private zone into which to add DNS records for the cluster's internal API. An existing private zone can only be used when also using existing VPC. The private zone must be associated with the VPC containing the subnets. Leave the private zone unset to have the installer create the private zone on your behalf.	String.

#### 4.4.4.5. Sample customized install-config.yaml file for Alibaba Cloud

You can customize the installation configuration file (**install-config.yaml**) to specify more details about your cluster's platform or modify the values of the required parameters.

```

apiVersion: v1
baseDomain: alicloud-dev.devcluster.openshift.com
credentialsMode: Manual
compute:
- architecture: amd64
  hyperthreading: Enabled
  name: worker
  platform: {}
  replicas: 3
controlPlane:
  architecture: amd64
  hyperthreading: Enabled
  name: master

```



```

platform: {}
replicas: 3
metadata:
  creationTimestamp: null
  name: test-cluster ❶
networking:
  clusterNetwork:
    - cidr: 10.128.0.0/14
      hostPrefix: 23
  machineNetwork:
    - cidr: 10.0.0.0/16
  networkType: OpenShiftSDN ❷
  serviceNetwork:
    - 172.30.0.0/16
platform:
  alibabacloud:
    defaultMachinePlatform: ❸
      instanceType: ecs.g6.xlarge
      systemDiskCategory: cloud_efficiency
      systemDiskSize: 200
    region: ap-southeast-1 ❹
    resourceGroupID: rg-acfnw6j3hyai ❺
    vpcID: vpc-0xifdjerdibmaqvjob2b
    vswitchIDs: ❻
      - vsw-0xi8ycgwc8wv5rhviwdq5
      - vsw-0xiy6v3z2tedv009b4pz2
  publish: External
  pullSecret: '{"auths": {"cloud.openshift.com": {"auth": ... }}' ❼
  sshKey: |
    ssh-rsa AAAA... ❽

```

- ❶ Required. The installation program prompts you for a cluster name.
- ❷ The cluster network plugin to install. The supported values are **OVNKubernetes** and **OpenShiftSDN**. The default value is **OVNKubernetes**.
- ❸ Optional. Specify parameters for machine pools that do not define their own platform configuration.
- ❹ Required. The installation program prompts you for the region to deploy the cluster to.
- ❺ Optional. Specify an existing resource group where the cluster should be installed.
- ❼ Required. The installation program prompts you for the pull secret.
- ❽ Optional. The installation program prompts you for the SSH key value that you use to access the machines in your cluster.
- ❻ Optional. These are example vswitchID values.

#### 4.4.4.6. Configuring the cluster-wide proxy during installation

Production environments can deny direct access to the internet and instead have an HTTP or HTTPS proxy available. You can configure a new OpenShift Container Platform cluster to use a proxy by configuring the proxy settings in the **install-config.yaml** file.

## Prerequisites

- You have an existing **install-config.yaml** file.
- You reviewed the sites that your cluster requires access to and determined whether any of them need to bypass the proxy. By default, all cluster egress traffic is proxied, including calls to hosting cloud provider APIs. You added sites to the **Proxy** object's **spec.noProxy** field to bypass the proxy if necessary.



### NOTE

The **Proxy** object **status.noProxy** field is populated with the values of the **networking.machineNetwork[].cidr**, **networking.clusterNetwork[].cidr**, and **networking.serviceNetwork[]** fields from your installation configuration.

For installations on Amazon Web Services (AWS), Google Cloud Platform (GCP), Microsoft Azure, and Red Hat OpenStack Platform (RHOSP), the **Proxy** object **status.noProxy** field is also populated with the instance metadata endpoint (**169.254.169.254**).

## Procedure

1. Edit your **install-config.yaml** file and add the proxy settings. For example:

```
apiVersion: v1
baseDomain: my.domain.com
proxy:
  httpProxy: http://<username>:<pswd>@<ip>:<port> 1
  httpsProxy: https://<username>:<pswd>@<ip>:<port> 2
  noProxy: example.com 3
  additionalTrustBundle: | 4
    -----BEGIN CERTIFICATE-----
    <MY_TRUSTED_CA_CERT>
    -----END CERTIFICATE-----
  ...
```

- 1 A proxy URL to use for creating HTTP connections outside the cluster. The URL scheme must be **http**.
- 2 A proxy URL to use for creating HTTPS connections outside the cluster.
- 3 A comma-separated list of destination domain names, IP addresses, or other network CIDRs to exclude from proxying. Preface a domain with **.** to match subdomains only. For example, **.y.com** matches **x.y.com**, but not **y.com**. Use **\*** to bypass the proxy for all destinations.
- 4 If provided, the installation program generates a config map that is named **user-ca-bundle** in the **openshift-config** namespace that contains one or more additional CA certificates that are required for proxying HTTPS connections. The Cluster Network Operator then creates a **trusted-ca-bundle** config map that merges these contents with the Red Hat Enterprise Linux CoreOS (RHCOS) trust bundle, and this config map is referenced in the

**trustedCA** field of the **Proxy** object. The **additionalTrustBundle** field is required unless the proxy's identity certificate is signed by an authority from the RHCOS trust bundle.

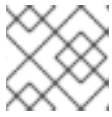

#### NOTE

The installation program does not support the proxy **readinessEndpoints** field.



#### NOTE

If the installer times out, restart and then complete the deployment by using the **wait-for** command of the installer. For example:

```
$ ./openshift-install wait-for install-complete --log-level debug
```

2. Save the file and reference it when installing OpenShift Container Platform.

The installation program creates a cluster-wide proxy that is named **cluster** that uses the proxy settings in the provided **install-config.yaml** file. If no proxy settings are provided, a **cluster Proxy** object is still created, but it will have a nil **spec**.



#### NOTE

Only the **Proxy** object named **cluster** is supported, and no additional proxies can be created.

### 4.4.5. Deploying the cluster

You can install OpenShift Container Platform on a compatible cloud platform.



#### IMPORTANT

You can run the **create cluster** command of the installation program only once, during initial installation.

#### Prerequisites

- Configure an account with the cloud platform that hosts your cluster.
- Obtain the OpenShift Container Platform installation program and the pull secret for your cluster.

#### Procedure

1. Change to the directory that contains the installation program and initialize the cluster deployment:

```
$ ./openshift-install create cluster --dir <installation_directory> \ 1
--log-level=info 2
```

- 1 For **<installation\_directory>**, specify the location of your customized **./install-config.yaml** file.

- 2 To view different installation details, specify **warn**, **debug**, or **error** instead of **info**.



## NOTE

If the cloud provider account that you configured on your host does not have sufficient permissions to deploy the cluster, the installation process stops, and the missing permissions are displayed.

When the cluster deployment completes, directions for accessing your cluster, including a link to its web console and credentials for the **kubeadmin** user, display in your terminal.

## Example output

```
...
INFO Install complete!
INFO To access the cluster as the system:admin user when using 'oc', run 'export
KUBECONFIG=/home/myuser/install_dir/auth/kubeconfig'
INFO Access the OpenShift web-console here: https://console-openshift-
console.apps.mycluster.example.com
INFO Login to the console with user: "kubeadmin", and password: "4vYBz-Ee6gm-ymBZj-
Wt5AL"
INFO Time elapsed: 36m22s
```



## NOTE

The cluster access and credential information also outputs to **<installation\_directory>/openshift\_install.log** when an installation succeeds.

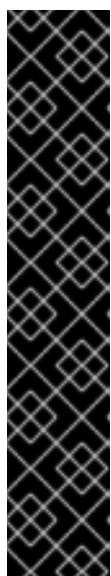

## IMPORTANT

- The Ignition config files that the installation program generates contain certificates that expire after 24 hours, which are then renewed at that time. If the cluster is shut down before renewing the certificates and the cluster is later restarted after the 24 hours have elapsed, the cluster automatically recovers the expired certificates. The exception is that you must manually approve the pending **node-bootstrapper** certificate signing requests (CSRs) to recover kubelet certificates. See the documentation for *Recovering from expired control plane certificates* for more information.
- It is recommended that you use Ignition config files within 12 hours after they are generated because the 24-hour certificate rotates from 16 to 22 hours after the cluster is installed. By using the Ignition config files within 12 hours, you can avoid installation failure if the certificate update runs during installation.



## IMPORTANT

You must not delete the installation program or the files that the installation program creates. Both are required to delete the cluster.

### 4.4.6. Installing the OpenShift CLI by downloading the binary

You can install the OpenShift CLI (**oc**) to interact with OpenShift Container Platform from a command-line interface. You can install **oc** on Linux, Windows, or macOS.

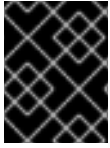

## IMPORTANT

If you installed an earlier version of **oc**, you cannot use it to complete all of the commands in OpenShift Container Platform 4.10. Download and install the new version of **oc**.

### Installing the OpenShift CLI on Linux

You can install the OpenShift CLI (**oc**) binary on Linux by using the following procedure.

#### Procedure

1. Navigate to the [OpenShift Container Platform downloads page](#) on the Red Hat Customer Portal.
2. Select the appropriate version in the **Version** drop-down menu.
3. Click **Download Now** next to the **OpenShift v4.10 Linux Client** entry and save the file.
4. Unpack the archive:

```
$ tar xvf <file>
```

5. Place the **oc** binary in a directory that is on your **PATH**.  
To check your **PATH**, execute the following command:

```
$ echo $PATH
```

After you install the OpenShift CLI, it is available using the **oc** command:

```
$ oc <command>
```

### Installing the OpenShift CLI on Windows

You can install the OpenShift CLI (**oc**) binary on Windows by using the following procedure.

#### Procedure

1. Navigate to the [OpenShift Container Platform downloads page](#) on the Red Hat Customer Portal.
2. Select the appropriate version in the **Version** drop-down menu.
3. Click **Download Now** next to the **OpenShift v4.10 Windows Client** entry and save the file.
4. Unzip the archive with a ZIP program.
5. Move the **oc** binary to a directory that is on your **PATH**.  
To check your **PATH**, open the command prompt and execute the following command:

```
C:\> path
```

After you install the OpenShift CLI, it is available using the **oc** command:

```
C:\> oc <command>
```

### Installing the OpenShift CLI on macOS

You can install the OpenShift CLI (**oc**) binary on macOS by using the following procedure.

#### Procedure

1. Navigate to the [OpenShift Container Platform downloads page](#) on the Red Hat Customer Portal.
2. Select the appropriate version in the **Version** drop-down menu.
3. Click **Download Now** next to the **OpenShift v4.10 MacOSX Client** entry and save the file.
4. Unpack and unzip the archive.
5. Move the **oc** binary to a directory on your PATH.  
To check your **PATH**, open a terminal and execute the following command:

```
$ echo $PATH
```

After you install the OpenShift CLI, it is available using the **oc** command:

```
$ oc <command>
```

### 4.4.7. Logging in to the cluster by using the CLI

You can log in to your cluster as a default system user by exporting the cluster **kubeconfig** file. The **kubeconfig** file contains information about the cluster that is used by the CLI to connect a client to the correct cluster and API server. The file is specific to a cluster and is created during OpenShift Container Platform installation.

#### Prerequisites

- You deployed an OpenShift Container Platform cluster.
- You installed the **oc** CLI.

#### Procedure

1. Export the **kubeadmin** credentials:

```
$ export KUBECONFIG=<installation_directory>/auth/kubeconfig 1
```

- 1** For **<installation\_directory>**, specify the path to the directory that you stored the installation files in.

2. Verify you can run **oc** commands successfully using the exported configuration:

```
$ oc whoami
```

#### Example output

```
system:admin
```

#### 4.4.8. Logging in to the cluster by using the web console

The **kubeadmin** user exists by default after an OpenShift Container Platform installation. You can log in to your cluster as the **kubeadmin** user by using the OpenShift Container Platform web console.

##### Prerequisites

- You have access to the installation host.
- You completed a cluster installation and all cluster Operators are available.

##### Procedure

1. Obtain the password for the **kubeadmin** user from the **kubeadmin-password** file on the installation host:

```
$ cat <installation_directory>/auth/kubeadmin-password
```

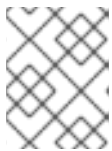

##### NOTE

Alternatively, you can obtain the **kubeadmin** password from the **<installation\_directory>/openshift\_install.log** log file on the installation host.

2. List the OpenShift Container Platform web console route:

```
$ oc get routes -n openshift-console | grep 'console-openshift'
```



##### NOTE

Alternatively, you can obtain the OpenShift Container Platform route from the **<installation\_directory>/openshift\_install.log** log file on the installation host.

##### Example output

```
console    console-openshift-console.apps.<cluster_name>.<base_domain>    console
https reencrypt/Redirect None
```

3. Navigate to the route detailed in the output of the preceding command in a web browser and log in as the **kubeadmin** user.

#### 4.4.9. Telemetry access for OpenShift Container Platform

In OpenShift Container Platform 4.10, the Telemetry service, which runs by default to provide metrics about cluster health and the success of updates, requires internet access. If your cluster is connected to the internet, Telemetry runs automatically, and your cluster is registered to [OpenShift Cluster Manager](#).

After you confirm that your [OpenShift Cluster Manager](#) inventory is correct, either maintained automatically by Telemetry or manually by using OpenShift Cluster Manager, [use subscription watch](#) to track your OpenShift Container Platform subscriptions at the account or multi-cluster level.

## Additional resources

- See [About remote health monitoring](#) for more information about the Telemetry service.
- See [Accessing the web console](#) for more details about accessing and understanding the OpenShift Container Platform web console
- See [Accessing the web console](#) for more details about accessing and understanding the OpenShift Container Platform web console.

### 4.4.10. Next steps

- [Validating an installation.](#)
- [Customize your cluster.](#)
- If necessary, you can [opt out of remote health reporting](#) .

## 4.5. INSTALLING A CLUSTER ON ALIBABA CLOUD WITH NETWORK CUSTOMIZATIONS

In OpenShift Container Platform 4.10, you can install a cluster on Alibaba Cloud with customized network configuration options. By customizing your network configuration, your cluster can coexist with existing IP address allocations in your environment and integrate with existing MTU and VXLAN configurations.

You must set most of the network configuration parameters during installation, and you can modify only **kubeProxy** configuration parameters in a running cluster.



### IMPORTANT

Alibaba Cloud on OpenShift Container Platform is a Technology Preview feature only. Technology Preview features are not supported with Red Hat production service level agreements (SLAs) and might not be functionally complete. Red Hat does not recommend using them in production. These features provide early access to upcoming product features, enabling customers to test functionality and provide feedback during the development process.

For more information about the support scope of Red Hat Technology Preview features, see [Technology Preview Features Support Scope](#) .

### 4.5.1. Prerequisites

- You reviewed details about the [OpenShift Container Platform installation and update](#) processes.
- You read the documentation on [selecting a cluster installation method and preparing it for users](#).
- You [registered your domain](#).
- If you use a firewall, you [configured it to allow the sites](#) that your cluster requires access to.
- If the cloud Resource Access Management (RAM) APIs are not accessible in your environment, or if you do not want to store an administrator-level credential secret in the **kube-system**



namespace, you can [manually create and maintain Resource Access Management \(RAM\) credentials](#).

### 4.5.2. Internet access for OpenShift Container Platform

In OpenShift Container Platform 4.10, you require access to the internet to install your cluster.

You must have internet access to:

- Access [OpenShift Cluster Manager](#) to download the installation program and perform subscription management. If the cluster has internet access and you do not disable Telemetry, that service automatically entitles your cluster.
- Access [Quay.io](#) to obtain the packages that are required to install your cluster.
- Obtain the packages that are required to perform cluster updates.



#### IMPORTANT

If your cluster cannot have direct internet access, you can perform a restricted network installation on some types of infrastructure that you provision. During that process, you download the required content and use it to populate a mirror registry with the installation packages. With some installation types, the environment that you install your cluster in will not require internet access. Before you update the cluster, you update the content of the mirror registry.

### 4.5.3. Generating a key pair for cluster node SSH access

During an OpenShift Container Platform installation, you can provide an SSH public key to the installation program. The key is passed to the Red Hat Enterprise Linux CoreOS (RHCOS) nodes through their Ignition config files and is used to authenticate SSH access to the nodes. The key is added to the `~/.ssh/authorized_keys` list for the **core** user on each node, which enables password-less authentication.

After the key is passed to the nodes, you can use the key pair to SSH in to the RHCOS nodes as the user **core**. To access the nodes through SSH, the private key identity must be managed by SSH for your local user.

If you want to SSH in to your cluster nodes to perform installation debugging or disaster recovery, you must provide the SSH public key during the installation process. The `./openshift-install gather` command also requires the SSH public key to be in place on the cluster nodes.

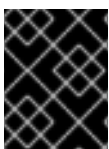

#### IMPORTANT

Do not skip this procedure in production environments, where disaster recovery and debugging is required.



#### NOTE

You must use a local key, not one that you configured with platform-specific approaches such as [AWS key pairs](#).

#### Procedure

1. If you do not have an existing SSH key pair on your local machine to use for authentication onto your cluster nodes, create one. For example, on a computer that uses a Linux operating system, run the following command:

```
$ ssh-keygen -t ed25519 -N "" -f <path>/<file_name> 1
```

- 1 Specify the path and file name, such as `~/.ssh/id_ed25519`, of the new SSH key. If you have an existing key pair, ensure your public key is in the your `~/.ssh` directory.



#### NOTE

If you plan to install an OpenShift Container Platform cluster that uses FIPS validated or Modules In Process cryptographic libraries on the **x86\_64** architecture, do not create a key that uses the **ed25519** algorithm. Instead, create a key that uses the **rsa** or **ecdsa** algorithm.

2. View the public SSH key:

```
$ cat <path>/<file_name>.pub
```

For example, run the following to view the `~/.ssh/id_ed25519.pub` public key:

```
$ cat ~/.ssh/id_ed25519.pub
```

3. Add the SSH private key identity to the SSH agent for your local user, if it has not already been added. SSH agent management of the key is required for password-less SSH authentication onto your cluster nodes, or if you want to use the `./openshift-install gather` command.



#### NOTE

On some distributions, default SSH private key identities such as `~/.ssh/id_rsa` and `~/.ssh/id_dsa` are managed automatically.

- a. If the **ssh-agent** process is not already running for your local user, start it as a background task:

```
$ eval "$(ssh-agent -s)"
```

#### Example output

```
Agent pid 31874
```



#### NOTE

If your cluster is in FIPS mode, only use FIPS-compliant algorithms to generate the SSH key. The key must be either RSA or ECDSA.

4. Add your SSH private key to the **ssh-agent**:

```
$ ssh-add <path>/<file_name> 1
```

- 1 Specify the path and file name for your SSH private key, such as `~/.ssh/id_ed25519`

### Example output

```
Identity added: /home/<you>/<path>/<file_name> (<computer_name>)
```

### Next steps

- When you install OpenShift Container Platform, provide the SSH public key to the installation program.

## 4.5.4. Obtaining the installation program

Before you install OpenShift Container Platform, download the installation file on a local computer.

### Prerequisites

- You have a computer that runs Linux or macOS, with 500 MB of local disk space

### Procedure

1. Access the [Infrastructure Provider](#) page on the OpenShift Cluster Manager site. If you have a Red Hat account, log in with your credentials. If you do not, create an account.
2. Select your infrastructure provider.
3. Navigate to the page for your installation type, download the installation program that corresponds with your host operating system and architecture, and place the file in the directory where you will store the installation configuration files.



#### IMPORTANT

The installation program creates several files on the computer that you use to install your cluster. You must keep the installation program and the files that the installation program creates after you finish installing the cluster. Both files are required to delete the cluster.

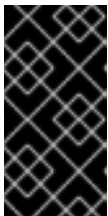

#### IMPORTANT

Deleting the files created by the installation program does not remove your cluster, even if the cluster failed during installation. To remove your cluster, complete the OpenShift Container Platform uninstallation procedures for your specific cloud provider.

4. Extract the installation program. For example, on a computer that uses a Linux operating system, run the following command:

```
$ tar -xvf openshift-install-linux.tar.gz
```

5. Download your installation [pull secret from the Red Hat OpenShift Cluster Manager](#) . This pull secret allows you to authenticate with the services that are provided by the included authorities, including Quay.io, which serves the container images for OpenShift Container Platform

components.

### 4.5.5. Network configuration phases

There are two phases prior to OpenShift Container Platform installation where you can customize the network configuration.

#### Phase 1

You can customize the following network-related fields in the **install-config.yaml** file before you create the manifest files:

- **networking.networkType**
- **networking.clusterNetwork**
- **networking.serviceNetwork**
- **networking.machineNetwork**

For more information on these fields, refer to *Installation configuration parameters*.



#### NOTE

Set the **networking.machineNetwork** to match the CIDR that the preferred NIC resides in.



#### IMPORTANT

The CIDR range **172.17.0.0/16** is reserved by libVirt. You cannot use this range or any range that overlaps with this range for any networks in your cluster.

#### Phase 2

After creating the manifest files by running **openshift-install create manifests**, you can define a customized Cluster Network Operator manifest with only the fields you want to modify. You can use the manifest to specify advanced network configuration.

You cannot override the values specified in phase 1 in the **install-config.yaml** file during phase 2. However, you can further customize the cluster network provider during phase 2.

#### 4.5.5.1. Creating the installation configuration file

You can customize the OpenShift Container Platform cluster you install on

#### Prerequisites

- Obtain the OpenShift Container Platform installation program and the pull secret for your cluster.
- Obtain service principal permissions at the subscription level.

#### Procedure

1. Create the **install-config.yaml** file.

- a. Change to the directory that contains the installation program and run the following command:

```
$ ./openshift-install create install-config --dir <installation_directory> 1
```

- 1** For **<installation\_directory>**, specify the directory name to store the files that the installation program creates.



### IMPORTANT

Specify an empty directory. Some installation assets, like bootstrap X.509 certificates have short expiration intervals, so you must not reuse an installation directory. If you want to reuse individual files from another cluster installation, you can copy them into your directory. However, the file names for the installation assets might change between releases. Use caution when copying installation files from an earlier OpenShift Container Platform version.

- b. At the prompts, provide the configuration details for your cloud:
- i. Optional: Select an SSH key to use to access your cluster machines.



### NOTE

For production OpenShift Container Platform clusters on which you want to perform installation debugging or disaster recovery, specify an SSH key that your **ssh-agent** process uses.

- ii. Enter a descriptive name for your cluster.
  - iii. Paste the [pull secret from the Red Hat OpenShift Cluster Manager](#) .
2. Modify the **install-config.yaml** file. You can find more information about the available parameters in the "Installation configuration parameters" section.
  3. Back up the **install-config.yaml** file so that you can use it to install multiple clusters.



### IMPORTANT

The **install-config.yaml** file is consumed during the installation process. If you want to reuse the file, you must back it up now.

#### 4.5.5.2. Generating the required installation manifests

You must generate the Kubernetes manifest and Ignition config files that the cluster needs to configure the machines.

#### Procedure

1. Generate the manifests by running the following command from the directory that contains the installation program:

```
$ openshift-install create manifests --dir <installation_directory>
```

where:

**<installation\_directory>**

Specifies the directory in which the installation program creates files.

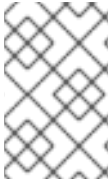

**NOTE**

By default, **ccoctl** creates objects in the directory in which the commands are run. To create the objects in a different directory, use the **--output-dir** flag. This procedure uses **<path\_to\_ccoctl\_output\_dir>** to refer to this directory.

## Prerequisites

You must have:

- Extracted and prepared the **ccoctl** binary.

## Procedure

1. Extract the list of **CredentialsRequest** objects from the OpenShift Container Platform release image by running the following command:

```
<1> `credrequests` is the directory where the list of `CredentialsRequest` objects is stored.
This command creates the directory if it does not exist.
```

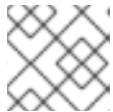

**NOTE**

This command can take a few moments to run.

### 4.5.5.3. Installation configuration parameters

Before you deploy an OpenShift Container Platform cluster, you provide parameter values to describe your account on the cloud platform that hosts your cluster and optionally customize your cluster's platform. When you create the **install-config.yaml** installation configuration file, you provide values for the required parameters through the command line. If you customize your cluster, you can modify the **install-config.yaml** file to provide more details about the platform.



**NOTE**

After installation, you cannot modify these parameters in the **install-config.yaml** file.

#### 4.5.5.3.1. Required configuration parameters

Required installation configuration parameters are described in the following table:

**Table 4.5. Required parameters**

Parameter	Description	Values
-----------	-------------	--------

Parameter	Description	Values
<b>apiVersion</b>	The API version for the <b>install-config.yaml</b> content. The current version is <b>v1</b> . The installer may also support older API versions.	String
<b>baseDomain</b>	The base domain of your cloud provider. The base domain is used to create routes to your OpenShift Container Platform cluster components. The full DNS name for your cluster is a combination of the <b>baseDomain</b> and <b>metadata.name</b> parameter values that uses the <b>&lt;metadata.name&gt;</b> . <b>&lt;baseDomain&gt;</b> format.	A fully-qualified domain or subdomain name, such as <b>example.com</b> .
<b>metadata</b>	Kubernetes resource <b>ObjectMeta</b> , from which only the <b>name</b> parameter is consumed.	Object
<b>metadata.name</b>	The name of the cluster. DNS records for the cluster are all subdomains of <b>{{.metadata.name}}</b> . <b>{{.baseDomain}}</b> .	String of lowercase letters, hyphens (-), and periods (.), such as <b>dev</b> .
<b>platform</b>	The configuration for the specific platform upon which to perform the installation: <b>alibabacloud</b> , <b>aws</b> , <b>baremetal</b> , <b>azure</b> , <b>gcp</b> , <b>ibmcloud</b> , <b>openstack</b> , <b>ovirt</b> , <b>vsphere</b> , or <b>{}</b> . For additional information about <b>platform.&lt;platform&gt;</b> parameters, consult the table for your specific platform that follows.	Object

Parameter	Description	Values
<b>pullSecret</b>	Get a <a href="#">pull secret from the Red Hat OpenShift Cluster Manager</a> to authenticate downloading container images for OpenShift Container Platform components from services such as Quay.io.	<pre>{   "auths":{     "cloud.openshift.com":{       "auth":"b3Blb=",       "email":"you@example.com"     },     "quay.io":{       "auth":"b3Blb=",       "email":"you@example.com"     }   } }</pre>

#### 4.5.5.3.2. Network configuration parameters

You can customize your installation configuration based on the requirements of your existing network infrastructure. For example, you can expand the IP address block for the cluster network or provide different IP address blocks than the defaults.

Only IPv4 addresses are supported.

Table 4.6. Network parameters

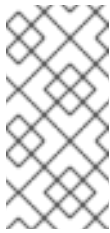
Parameter	Description	Values
<b>networking</b>	The configuration for the cluster network.	Object <div style="display: flex; align-items: center; margin-top: 10px;">  <div> <p><b>NOTE</b></p> <p>You cannot modify parameters specified by the <b>networking</b> object after installation.</p> </div> </div>
<b>networking.networkType</b>	The cluster network provider Container Network Interface (CNI) plugin to install.	Either <b>OpenShiftSDN</b> or <b>OVNKubernetes</b> . <b>OpenShiftSDN</b> is a CNI provider for all-Linux networks. <b>OVNKubernetes</b> is a CNI provider for Linux networks and hybrid networks that contain both Linux and Windows servers. The default value is <b>OpenShiftSDN</b> .





Parameter	Description	Values
<b>networking.clusterNetwork</b>	<p>The IP address blocks for pods.</p> <p>The default value is <b>10.128.0.0/14</b> with a host prefix of <b>/23</b>.</p> <p>If you specify multiple IP address blocks, the blocks must not overlap.</p>	<p>An array of objects. For example:</p> <pre>networking:   clusterNetwork:     - cidr: 10.128.0.0/14       hostPrefix: 23</pre>
<b>networking.clusterNetwork.cidr</b>	<p>Required if you use <b>networking.clusterNetwork</b>. An IP address block.</p> <p>An IPv4 network.</p>	<p>An IP address block in Classless Inter-Domain Routing (CIDR) notation. The prefix length for an IPv4 block is between <b>0</b> and <b>32</b>.</p>
<b>networking.clusterNetwork.hostPrefix</b>	<p>The subnet prefix length to assign to each individual node. For example, if <b>hostPrefix</b> is set to <b>23</b> then each node is assigned a <b>/23</b> subnet out of the given <b>cidr</b>. A <b>hostPrefix</b> value of <b>23</b> provides 510 (<math>2^{(32 - 23)} - 2</math>) pod IP addresses.</p>	<p>A subnet prefix.</p> <p>The default value is <b>23</b>.</p>
<b>networking.serviceNetwork</b>	<p>The IP address block for services. The default value is <b>172.30.0.0/16</b>.</p> <p>The OpenShift SDN and OVN-Kubernetes network providers support only a single IP address block for the service network.</p>	<p>An array with an IP address block in CIDR format. For example:</p> <pre>networking:   serviceNetwork:     - 172.30.0.0/16</pre>
<b>networking.machineNetwork</b>	<p>The IP address blocks for machines.</p> <p>If you specify multiple IP address blocks, the blocks must not overlap.</p>	<p>An array of objects. For example:</p> <pre>networking:   machineNetwork:     - cidr: 10.0.0.0/16</pre>
<b>networking.machineNetwork.cidr</b>	<p>Required if you use <b>networking.machineNetwork</b>. An IP address block. The default value is <b>10.0.0.0/16</b> for all platforms other than libvirt. For libvirt, the default value is <b>192.168.126.0/24</b>.</p>	<p>An IP network block in CIDR notation.</p> <p>For example, <b>10.0.0.0/16</b>.</p> <div style="display: flex; align-items: flex-start;">  <div> <p><b>NOTE</b></p> <p>Set the <b>networking.machineNetwork</b> to match the CIDR that the preferred NIC resides in.</p> </div> </div>



## 4.5.5.3.3. Optional configuration parameters

Optional installation configuration parameters are described in the following table:

Table 4.7. Optional parameters

Parameter	Description	Values
<b>additionalTrustBundle</b>	A PEM-encoded X.509 certificate bundle that is added to the nodes' trusted certificate store. This trust bundle may also be used when a proxy has been configured.	String
<b>cgroupsV2</b>	Enables <a href="#">Linux control groups version 2</a> (cgroups v2) on specific nodes in your cluster. The OpenShift Container Platform process for enabling cgroups v2 disables all cgroup version 1 controllers and hierarchies. The OpenShift Container Platform cgroups version 2 feature is in Developer Preview and is not supported by Red Hat at this time.	<b>true</b>
<b>compute</b>	The configuration for the machines that comprise the compute nodes.	Array of <b>MachinePool</b> objects.
<b>compute.architecture</b>	Determines the instruction set architecture of the machines in the pool. Currently, clusters with varied architectures are not supported. All pools must specify the same architecture. Valid values are <b>amd64</b> (the default).	String
<b>compute.hyperthreading</b>	Whether to enable or disable simultaneous multithreading, or <b>hyperthreading</b> , on compute machines. By default, simultaneous multithreading is enabled to increase the performance of your machines' cores.	<b>Enabled</b> or <b>Disabled</b>
	 <p><b>IMPORTANT</b></p> <p>If you disable simultaneous multithreading, ensure that your capacity planning accounts for the dramatically decreased machine performance.</p>	

Parameter	Description	Values
<b>compute.name</b>	Required if you use <b>compute</b> . The name of the machine pool.	<b>worker</b>
<b>compute.platform</b>	Required if you use <b>compute</b> . Use this parameter to specify the cloud provider to host the worker machines. This parameter value must match the <b>controlPlane.platform</b> parameter value.	<b>alibabacloud, aws, azure, gcp, ibmcloud, openstack, ovirt, vsphere</b> , or <b>{}</b>
<b>compute.replicas</b>	The number of compute machines, which are also known as worker machines, to provision.	A positive integer greater than or equal to <b>2</b> . The default value is <b>3</b> .
<b>controlPlane</b>	The configuration for the machines that comprise the control plane.	Array of <b>MachinePool</b> objects.
<b>controlPlane.architecture</b>	Determines the instruction set architecture of the machines in the pool. Currently, clusters with varied architectures are not supported. All pools must specify the same architecture. Valid values are <b>amd64</b> (the default).	String
<b>controlPlane.hyperthreading</b>	<p>Whether to enable or disable simultaneous multithreading, or <b>hyperthreading</b>, on control plane machines. By default, simultaneous multithreading is enabled to increase the performance of your machines' cores.</p> <div style="display: flex; align-items: center;">  <div> <p><b>IMPORTANT</b></p> <p>If you disable simultaneous multithreading, ensure that your capacity planning accounts for the dramatically decreased machine performance.</p> </div> </div>	<b>Enabled</b> or <b>Disabled</b>
<b>controlPlane.name</b>	Required if you use <b>controlPlane</b> . The name of the machine pool.	<b>master</b>

Parameter	Description	Values
<b>controlPlane.platform</b>	Required if you use <b>controlPlane</b> . Use this parameter to specify the cloud provider that hosts the control plane machines. This parameter value must match the <b>compute.platform</b> parameter value.	<b>alibabacloud, aws, azure, gcp, ibmcloud, openstack, ovirt, vsphere</b> , or {}
<b>controlPlane.replicas</b>	The number of control plane machines to provision.	The only supported value is <b>3</b> , which is the default value.
<b>credentialsMode</b>	<p>The Cloud Credential Operator (CCO) mode. If no mode is specified, the CCO dynamically tries to determine the capabilities of the provided credentials, with a preference for mint mode on the platforms where multiple modes are supported.</p> <div style="display: flex; align-items: flex-start;"> <div style="flex: 1;">  </div> <div style="flex: 2;"> <p><b>NOTE</b></p> <p>Not all CCO modes are supported for all cloud providers. For more information on CCO modes, see the <i>Cloud Credential Operator</i> entry in the <i>Cluster Operators reference</i> content.</p> </div> </div> <div style="display: flex; align-items: flex-start; margin-top: 10px;"> <div style="flex: 1;">  </div> <div style="flex: 2;"> <p><b>NOTE</b></p> <p>If your AWS account has service control policies (SCP) enabled, you must configure the <b>credentialsMode</b> parameter to <b>Mint, Passthrough</b> or <b>Manual</b>.</p> </div> </div>	<b>Mint, Passthrough, Manual</b> or an empty string ("").

Parameter	Description	Values
<b>fips</b>	<p>Enable or disable FIPS mode. The default is <b>false</b> (disabled). If FIPS mode is enabled, the Red Hat Enterprise Linux CoreOS (RHCOS) machines that OpenShift Container Platform runs on bypass the default Kubernetes cryptography suite and use the cryptography modules that are provided with RHCOS instead.</p> <div data-bbox="486 584 592 1361" style="background-color: black; color: white; padding: 5px; margin-bottom: 10px;"> <p><b>IMPORTANT</b></p> <p>To enable FIPS mode for your cluster, you must run the installation program from a Red Hat Enterprise Linux (RHEL) computer configured to operate in FIPS mode. For more information about configuring FIPS mode on RHEL, see <a href="#">Installing the system in FIPS mode</a>. The use of FIPS validated or Modules In Process cryptographic libraries is only supported on OpenShift Container Platform deployments on the <b>x86_64</b> architecture.</p> </div> <div data-bbox="486 1406 592 1608" style="background-color: #f0f0f0; padding: 5px;"> <p><b>NOTE</b></p> <p>If you are using Azure File storage, you cannot enable FIPS mode.</p> </div>	<b>false</b> or <b>true</b>

Parameter	Description	Values
<b>imageContentSources</b>	Sources and repositories for the release-image content.	Array of objects. Includes a <b>source</b> and, optionally, <b>mirrors</b> , as described in the following rows of this table.
<b>imageContentSources.source</b>	Required if you use <b>imageContentSources</b> . Specify the repository that users refer to, for example, in image pull specifications.	String
<b>imageContentSources.mirrors</b>	Specify one or more repositories that may also contain the same images.	Array of strings
<b>publish</b>	How to publish or expose the user-facing endpoints of your cluster, such as the Kubernetes API, OpenShift routes.	<p><b>Internal</b> or <b>External</b>. The default value is <b>External</b>.</p> <p>Setting this field to <b>Internal</b> is not supported on non-cloud platforms and IBM Cloud VPC.</p> <div style="display: flex; align-items: flex-start;"> <div style="width: 60px; height: 100px; background: repeating-linear-gradient(45deg, transparent, transparent 2px, black 2px, black 4px); margin-right: 10px;"></div> <div> <p><b>IMPORTANT</b></p> <p>If the value of the field is set to <b>Internal</b>, the cluster will become non-functional. For more information, refer to <a href="#">BZ#1953035</a>.</p> </div> </div>
<b>sshKey</b>	<p>The SSH key or keys to authenticate access your cluster machines.</p> <div style="display: flex; align-items: flex-start;"> <div style="width: 60px; height: 100px; background: repeating-linear-gradient(45deg, transparent, transparent 2px, black 2px, black 4px); margin-right: 10px;"></div> <div> <p><b>NOTE</b></p> <p>For production OpenShift Container Platform clusters on which you want to perform installation debugging or disaster recovery, specify an SSH key that your <b>ssh-agent</b> process uses.</p> </div> </div>	<p>One or more keys. For example:</p> <pre>sshKey:   &lt;key1&gt;   &lt;key2&gt;   &lt;key3&gt;</pre>

#### 4.5.5.4. Sample customized install-config.yaml file for Alibaba Cloud

You can customize the installation configuration file (**install-config.yaml**) to specify more details about your cluster's platform or modify the values of the required parameters.

```

apiVersion: v1
baseDomain: alicloud-dev.devcluster.openshift.com
credentialsMode: Manual
compute:
- architecture: amd64
  hyperthreading: Enabled
  name: worker
  platform: {}
  replicas: 3
controlPlane:
  architecture: amd64
  hyperthreading: Enabled
  name: master
  platform: {}
  replicas: 3
metadata:
  creationTimestamp: null
  name: test-cluster ❶
networking:
  clusterNetwork:
  - cidr: 10.128.0.0/14
    hostPrefix: 23
  machineNetwork:
  - cidr: 10.0.0.0/16
  networkType: OpenShiftSDN ❷
  serviceNetwork:
  - 172.30.0.0/16
platform:
  alibabacloud:
    defaultMachinePlatform: ❸
    instanceType: ecs.g6.xlarge
    systemDiskCategory: cloud_efficiency
    systemDiskSize: 200
    region: ap-southeast-1 ❹
    resourceGroupID: rg-acfnw6j3hyai ❺
    vpcID: vpc-0xifdjerdibmaqvtjob2b
    vswitchIDs: ❻
    - vsw-0xi8ycgwc8wv5rhviwdq5
    - vsw-0xiy6v3z2tedv009b4pz2
  publish: External
  pullSecret: '{"auths": {"cloud.openshift.com": {"auth": ... }}' ❼
  sshKey: |
    ssh-rsa AAAA... ❽

```

- ❶ Required. The installation program prompts you for a cluster name.
- ❷ The cluster network plugin to install. The supported values are **OVNKubernetes** and **OpenShiftSDN**. The default value is **OVNKubernetes**.
- ❸ Optional. Specify parameters for machine pools that do not define their own platform configuration.

- 4 Required. The installation program prompts you for the region to deploy the cluster to.
- 5 Optional. Specify an existing resource group where the cluster should be installed.
- 7 Required. The installation program prompts you for the pull secret.
- 8 Optional. The installation program prompts you for the SSH key value that you use to access the machines in your cluster.
- 6 Optional. These are example vswitchID values.

#### 4.5.5.5. Configuring the cluster-wide proxy during installation

Production environments can deny direct access to the internet and instead have an HTTP or HTTPS proxy available. You can configure a new OpenShift Container Platform cluster to use a proxy by configuring the proxy settings in the **install-config.yaml** file.

#### Prerequisites

- You have an existing **install-config.yaml** file.
- You reviewed the sites that your cluster requires access to and determined whether any of them need to bypass the proxy. By default, all cluster egress traffic is proxied, including calls to hosting cloud provider APIs. You added sites to the **Proxy** object's **spec.noProxy** field to bypass the proxy if necessary.



#### NOTE

The **Proxy** object **status.noProxy** field is populated with the values of the **networking.machineNetwork[].cidr**, **networking.clusterNetwork[].cidr**, and **networking.serviceNetwork[]** fields from your installation configuration.

For installations on Amazon Web Services (AWS), Google Cloud Platform (GCP), Microsoft Azure, and Red Hat OpenStack Platform (RHOSP), the **Proxy** object **status.noProxy** field is also populated with the instance metadata endpoint (**169.254.169.254**).

#### Procedure

1. Edit your **install-config.yaml** file and add the proxy settings. For example:

```

apiVersion: v1
baseDomain: my.domain.com
proxy:
  httpProxy: http://<username>:<pswd>@<ip>:<port> 1
  httpsProxy: https://<username>:<pswd>@<ip>:<port> 2
  noProxy: example.com 3
  additionalTrustBundle: | 4
    -----BEGIN CERTIFICATE-----
    <MY_TRUSTED_CA_CERT>
    -----END CERTIFICATE-----
  ...

```



- 1 A proxy URL to use for creating HTTP connections outside the cluster. The URL scheme must be **http**.
- 2 A proxy URL to use for creating HTTPS connections outside the cluster.
- 3 A comma-separated list of destination domain names, IP addresses, or other network CIDRs to exclude from proxying. Preface a domain with **.** to match subdomains only. For example, **.y.com** matches **x.y.com**, but not **y.com**. Use **\*** to bypass the proxy for all destinations.
- 4 If provided, the installation program generates a config map that is named **user-ca-bundle** in the **openshift-config** namespace that contains one or more additional CA certificates that are required for proxying HTTPS connections. The Cluster Network Operator then creates a **trusted-ca-bundle** config map that merges these contents with the Red Hat Enterprise Linux CoreOS (RHCOS) trust bundle, and this config map is referenced in the **trustedCA** field of the **Proxy** object. The **additionalTrustBundle** field is required unless the proxy's identity certificate is signed by an authority from the RHCOS trust bundle.

**NOTE**

The installation program does not support the proxy **readinessEndpoints** field.

**NOTE**

If the installer times out, restart and then complete the deployment by using the **wait-for** command of the installer. For example:

```
$. /openshift-install wait-for install-complete --log-level debug
```

2. Save the file and reference it when installing OpenShift Container Platform.

The installation program creates a cluster-wide proxy that is named **cluster** that uses the proxy settings in the provided **install-config.yaml** file. If no proxy settings are provided, a **cluster Proxy** object is still created, but it will have a nil **spec**.

**NOTE**

Only the **Proxy** object named **cluster** is supported, and no additional proxies can be created.

#### 4.5.6. Cluster Network Operator configuration

The configuration for the cluster network is specified as part of the Cluster Network Operator (CNO) configuration and stored in a custom resource (CR) object that is named **cluster**. The CR specifies the fields for the **Network** API in the **operator.openshift.io** API group.

The CNO configuration inherits the following fields during cluster installation from the **Network** API in the **Network.config.openshift.io** API group and these fields cannot be changed:

**clusterNetwork**

IP address pools from which pod IP addresses are allocated.

**serviceNetwork**

IP address pool for services.

### **defaultNetwork.type**

Cluster network provider, such as OpenShift SDN or OVN-Kubernetes.

You can specify the cluster network provider configuration for your cluster by setting the fields for the **defaultNetwork** object in the CNO object named **cluster**.

#### 4.5.6.1. Cluster Network Operator configuration object

The fields for the Cluster Network Operator (CNO) are described in the following table:

**Table 4.8. Cluster Network Operator configuration object**

Field	Type	Description
<b>metadata.name</b>	<b>string</b>	The name of the CNO object. This name is always <b>cluster</b> .
<b>spec.clusterNetwork</b>	<b>array</b>	<p>A list specifying the blocks of IP addresses from which pod IP addresses are allocated and the subnet prefix length assigned to each individual node in the cluster. For example:</p> <pre>spec:   clusterNetwork:   - cidr: 10.128.0.0/19     hostPrefix: 23   - cidr: 10.128.32.0/19     hostPrefix: 23</pre> <p>You can customize this field only in the <b>install-config.yaml</b> file before you create the manifests. The value is read-only in the manifest file.</p>
<b>spec.serviceNetwork</b>	<b>array</b>	<p>A block of IP addresses for services. The OpenShift SDN and OVN-Kubernetes Container Network Interface (CNI) network providers support only a single IP address block for the service network. For example:</p> <pre>spec:   serviceNetwork:   - 172.30.0.0/14</pre> <p>You can customize this field only in the <b>install-config.yaml</b> file before you create the manifests. The value is read-only in the manifest file.</p>
<b>spec.defaultNetwork</b>	<b>object</b>	Configures the Container Network Interface (CNI) cluster network provider for the cluster network.
<b>spec.kubeProxyConfig</b>	<b>object</b>	The fields for this object specify the kube-proxy configuration. If you are using the OVN-Kubernetes cluster network provider, the kube-proxy configuration has no effect.

**defaultNetwork object configuration**

The values for the **defaultNetwork** object are defined in the following table:

**Table 4.9. defaultNetwork object**

Field	Type	Description
<b>type</b>	<b>string</b>	<p>Either <b>OpenShiftSDN</b> or <b>OVNKubernetes</b>. The cluster network provider is selected during installation. This value cannot be changed after cluster installation.</p> <div style="display: flex; align-items: flex-start;"> <div style="flex: 1;">  </div> <div style="flex: 2;"> <p><b>NOTE</b></p> <p>OpenShift Container Platform uses the OpenShift SDN Container Network Interface (CNI) cluster network provider by default.</p> </div> </div>
<b>openshiftSDNConfig</b>	<b>object</b>	This object is only valid for the OpenShift SDN cluster network provider.
<b>ovnKubernetesConfig</b>	<b>object</b>	This object is only valid for the OVN-Kubernetes cluster network provider.

**Configuration for the OpenShift SDN CNI cluster network provider**

The following table describes the configuration fields for the OpenShift SDN Container Network Interface (CNI) cluster network provider.

**Table 4.10. openshiftSDNConfig object**

Field	Type	Description
<b>mode</b>	<b>string</b>	<p>Configures the network isolation mode for OpenShift SDN. The default value is <b>NetworkPolicy</b>.</p> <p>The values <b>Multitenant</b> and <b>Subnet</b> are available for backwards compatibility with OpenShift Container Platform 3.x but are not recommended. This value cannot be changed after cluster installation.</p>

Field	Type	Description
<b>mtu</b>	<b>integer</b>	<p>The maximum transmission unit (MTU) for the VXLAN overlay network. This is detected automatically based on the MTU of the primary network interface. You do not normally need to override the detected MTU.</p> <p>If the auto-detected value is not what you expect it to be, confirm that the MTU on the primary network interface on your nodes is correct. You cannot use this option to change the MTU value of the primary network interface on the nodes.</p> <p>If your cluster requires different MTU values for different nodes, you must set this value to <b>50</b> less than the lowest MTU value in your cluster. For example, if some nodes in your cluster have an MTU of <b>9001</b>, and some have an MTU of <b>1500</b>, you must set this value to <b>1450</b>.</p> <p>This value cannot be changed after cluster installation.</p>
<b>vxlanPort</b>	<b>integer</b>	<p>The port to use for all VXLAN packets. The default value is <b>4789</b>. This value cannot be changed after cluster installation.</p> <p>If you are running in a virtualized environment with existing nodes that are part of another VXLAN network, then you might be required to change this. For example, when running an OpenShift SDN overlay on top of VMware NSX-T, you must select an alternate port for the VXLAN, because both SDNs use the same default VXLAN port number.</p> <p>On Amazon Web Services (AWS), you can select an alternate port for the VXLAN between port <b>9000</b> and port <b>9999</b>.</p>

### Example OpenShift SDN configuration

```
defaultNetwork:
  type: OpenShiftSDN
  openshiftSDNConfig:
    mode: NetworkPolicy
    mtu: 1450
    vxlanPort: 4789
```

### Configuration for the OVN-Kubernetes CNI cluster network provider

The following table describes the configuration fields for the OVN-Kubernetes CNI cluster network provider.

Table 4.11. `ovnKubernetesConfig` object

Field	Type	Description
<b>mtu</b>	<b>integer</b>	<p>The maximum transmission unit (MTU) for the Geneve (Generic Network Virtualization Encapsulation) overlay network. This is detected automatically based on the MTU of the primary network interface. You do not normally need to override the detected MTU.</p> <p>If the auto-detected value is not what you expect it to be, confirm that the MTU on the primary network interface on your nodes is correct. You cannot use this option to change the MTU value of the primary network interface on the nodes.</p> <p>If your cluster requires different MTU values for different nodes, you must set this value to <b>100</b> less than the lowest MTU value in your cluster. For example, if some nodes in your cluster have an MTU of <b>9001</b>, and some have an MTU of <b>1500</b>, you must set this value to <b>1400</b>.</p>
<b>genevePort</b>	<b>integer</b>	The port to use for all Geneve packets. The default value is <b>6081</b> . This value cannot be changed after cluster installation.
<b>ipsecConfig</b>	<b>object</b>	Specify an empty object to enable IPsec encryption. This value cannot be changed after cluster installation.
<b>policyAuditConfig</b>	<b>object</b>	Specify a configuration object for customizing network policy audit logging. If unset, the defaults audit log settings are used.
<b>gatewayConfig</b>	<b>object</b>	<p>Optional: Specify a configuration object for customizing how egress traffic is sent to the node gateway.</p> <div style="display: flex; align-items: flex-start;"> <div style="flex: 1;">  </div> <div style="flex: 1; padding-left: 10px;"> <p><b>NOTE</b></p> <p>While migrating egress traffic, you can expect some disruption to workloads and service traffic until the Cluster Network Operator (CNO) successfully rolls out the changes.</p> </div> </div>

Table 4.12. **policyAuditConfig** object

Field	Type	Description
<b>rateLimit</b>	integer	The maximum number of messages to generate every second per node. The default value is <b>20</b> messages per second.
<b>maxFileSize</b>	integer	The maximum size for the audit log in bytes. The default value is <b>50000000</b> or 50 MB.

Field	Type	Description
<b>destination</b>	string	<p>One of the following additional audit log targets:</p> <p><b>libc</b> The libc <b>syslog()</b> function of the journald process on the host.</p> <p><b>udp:&lt;host&gt;:&lt;port&gt;</b> A syslog server. Replace <b>&lt;host&gt;:&lt;port&gt;</b> with the host and port of the syslog server.</p> <p><b>unix:&lt;file&gt;</b> A Unix Domain Socket file specified by <b>&lt;file&gt;</b>.</p> <p><b>null</b> Do not send the audit logs to any additional target.</p>
<b>syslogFacility</b>	string	The syslog facility, such as <b>kern</b> , as defined by RFC5424. The default value is <b>local0</b> .

Table 4.13. gatewayConfig object

Field	Type	Description
<b>routingViaHost</b>	<b>boolean</b>	<p>Set this field to <b>true</b> to send egress traffic from pods to the host networking stack. For highly-specialized installations and applications that rely on manually configured routes in the kernel routing table, you might want to route egress traffic to the host networking stack. By default, egress traffic is processed in OVN to exit the cluster and is not affected by specialized routes in the kernel routing table. The default value is <b>false</b>.</p> <p>This field has an interaction with the Open vSwitch hardware offloading feature. If you set this field to <b>true</b>, you do not receive the performance benefits of the offloading because egress traffic is processed by the host networking stack.</p>

### Example OVN-Kubernetes configuration with IPsec enabled

```

defaultNetwork:
  type: OVNKubernetes
  ovnKubernetesConfig:
    mtu: 1400
    genevePort: 6081
    ipsecConfig: {}

```

### kubeProxyConfig object configuration

The values for the **kubeProxyConfig** object are defined in the following table:

Table 4.14. kubeProxyConfig object

Field	Type	Description
<b>iptablesSyncPeriod</b>	<b>string</b>	<p>The refresh period for <b>iptables</b> rules. The default value is <b>30s</b>. Valid suffixes include <b>s</b>, <b>m</b>, and <b>h</b> and are described in the <a href="#">Go time package</a> documentation.</p> <div style="display: flex; align-items: flex-start;">  <div> <p><b>NOTE</b></p> <p>Because of performance improvements introduced in OpenShift Container Platform 4.3 and greater, adjusting the <b>iptablesSyncPeriod</b> parameter is no longer necessary.</p> </div> </div>
<b>proxyArguments.iptables-min-sync-period</b>	<b>array</b>	<p>The minimum duration before refreshing <b>iptables</b> rules. This field ensures that the refresh does not happen too frequently. Valid suffixes include <b>s</b>, <b>m</b>, and <b>h</b> and are described in the <a href="#">Go time package</a>. The default value is:</p> <pre>kubeProxyConfig:   proxyArguments:     iptables-min-sync-period:       - 0s</pre>

### 4.5.7. Specifying advanced network configuration

You can use advanced network configuration for your cluster network provider to integrate your cluster into your existing network environment. You can specify advanced network configuration only before you install the cluster.



#### IMPORTANT

Customizing your network configuration by modifying the OpenShift Container Platform manifest files created by the installation program is not supported. Applying a manifest file that you create, as in the following procedure, is supported.

#### Prerequisites

- You have created the **install-config.yaml** file and completed any modifications to it.

#### Procedure

- Change to the directory that contains the installation program and create the manifests:

```
$ ./openshift-install create manifests --dir <installation_directory> 1
```

- 1** **<installation\_directory>** specifies the name of the directory that contains the **install-config.yaml** file for your cluster.

2. Create a stub manifest file for the advanced network configuration that is named **cluster-network-03-config.yml** in the `<installation_directory>/manifests/` directory:

```
apiVersion: operator.openshift.io/v1
kind: Network
metadata:
  name: cluster
spec:
```

3. Specify the advanced network configuration for your cluster in the **cluster-network-03-config.yml** file, such as in the following examples:

#### Specify a different VXLAN port for the OpenShift SDN network provider

```
apiVersion: operator.openshift.io/v1
kind: Network
metadata:
  name: cluster
spec:
  defaultNetwork:
    openshiftSDNConfig:
      vxlanPort: 4800
```

#### Enable IPsec for the OVN-Kubernetes network provider

```
apiVersion: operator.openshift.io/v1
kind: Network
metadata:
  name: cluster
spec:
  defaultNetwork:
    ovnKubernetesConfig:
      ipsecConfig: {}
```

4. Optional: Back up the **manifests/cluster-network-03-config.yml** file. The installation program consumes the **manifests/** directory when you create the Ignition config files.

### 4.5.8. Configuring hybrid networking with OVN-Kubernetes

You can configure your cluster to use hybrid networking with OVN-Kubernetes. This allows a hybrid cluster that supports different node networking configurations. For example, this is necessary to run both Linux and Windows nodes in a cluster.

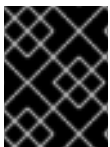

#### IMPORTANT

You must configure hybrid networking with OVN-Kubernetes during the installation of your cluster. You cannot switch to hybrid networking after the installation process.

#### Prerequisites

- You defined **OVNKubernetes** for the **networking.networkType** parameter in the **install-config.yaml** file. See the installation documentation for configuring OpenShift Container Platform network customizations on your chosen cloud provider for more information.



## Procedure

1. Change to the directory that contains the installation program and create the manifests:

```
$ ./openshift-install create manifests --dir <installation_directory>
```

where:

**<installation\_directory>**

Specifies the name of the directory that contains the **install-config.yaml** file for your cluster.

2. Create a stub manifest file for the advanced network configuration that is named **cluster-network-03-config.yaml** in the **<installation\_directory>/manifests/** directory:

```
$ cat <<EOF > <installation_directory>/manifests/cluster-network-03-config.yaml
apiVersion: operator.openshift.io/v1
kind: Network
metadata:
  name: cluster
spec:
  EOF
```

where:

**<installation\_directory>**

Specifies the directory name that contains the **manifests/** directory for your cluster.

3. Open the **cluster-network-03-config.yaml** file in an editor and configure OVN-Kubernetes with hybrid networking, such as in the following example:

### Specify a hybrid networking configuration

```
apiVersion: operator.openshift.io/v1
kind: Network
metadata:
  name: cluster
spec:
  defaultNetwork:
    ovnKubernetesConfig:
      hybridOverlayConfig:
        hybridClusterNetwork: 1
        - cidr: 10.132.0.0/14
        hostPrefix: 23
        hybridOverlayVXLANPort: 9898 2
```

- 1 Specify the CIDR configuration used for nodes on the additional overlay network. The **hybridClusterNetwork** CIDR cannot overlap with the **clusterNetwork** CIDR.
- 2 Specify a custom VXLAN port for the additional overlay network. This is required for running Windows nodes in a cluster installed on vSphere, and must not be configured for any other cloud provider. The custom port can be any open port excluding the default **4789** port. For more information on this requirement, see the Microsoft documentation on [Pod-to-pod connectivity between hosts is broken](#).

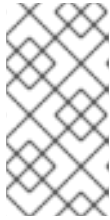
**NOTE**

Windows Server Long-Term Servicing Channel (LTSC): Windows Server 2019 is not supported on clusters with a custom **hybridOverlayVXLANPort** value because this Windows server version does not support selecting a custom VXLAN port.

4. Save the **cluster-network-03-config.yml** file and quit the text editor.
5. Optional: Back up the **manifests/cluster-network-03-config.yml** file. The installation program deletes the **manifests/** directory when creating the cluster.

**4.5.9. Deploying the cluster**

You can install OpenShift Container Platform on a compatible cloud platform.

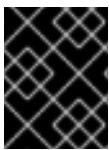
**IMPORTANT**

You can run the **create cluster** command of the installation program only once, during initial installation.

**Prerequisites**

- Configure an account with the cloud platform that hosts your cluster.
- Obtain the OpenShift Container Platform installation program and the pull secret for your cluster.

**Procedure**

1. Change to the directory that contains the installation program and initialize the cluster deployment:

```
$ ./openshift-install create cluster --dir <installation_directory> \ 1
--log-level=info 2
```

- 1** For **<installation\_directory>**, specify the location of your customized **./install-config.yaml** file.
- 2** To view different installation details, specify **warn**, **debug**, or **error** instead of **info**.

**NOTE**

If the cloud provider account that you configured on your host does not have sufficient permissions to deploy the cluster, the installation process stops, and the missing permissions are displayed.

When the cluster deployment completes, directions for accessing your cluster, including a link to its web console and credentials for the **kubeadmin** user, display in your terminal.

**Example output**

```

...
INFO Install complete!
INFO To access the cluster as the system:admin user when using 'oc', run 'export
KUBECONFIG=/home/myuser/install_dir/auth/kubeconfig'
INFO Access the OpenShift web-console here: https://console-openshift-
console.apps.mycluster.example.com
INFO Login to the console with user: "kubeadmin", and password: "4vYBz-Ee6gm-ymBZj-
Wt5AL"
INFO Time elapsed: 36m22s

```



## NOTE

The cluster access and credential information also outputs to **<installation\_directory>/openshift\_install.log** when an installation succeeds.

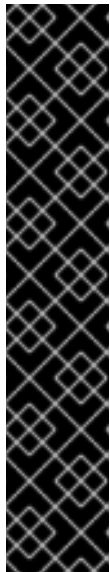

## IMPORTANT

- The Ignition config files that the installation program generates contain certificates that expire after 24 hours, which are then renewed at that time. If the cluster is shut down before renewing the certificates and the cluster is later restarted after the 24 hours have elapsed, the cluster automatically recovers the expired certificates. The exception is that you must manually approve the pending **node-bootstrapper** certificate signing requests (CSRs) to recover kubelet certificates. See the documentation for *Recovering from expired control plane certificates* for more information.
- It is recommended that you use Ignition config files within 12 hours after they are generated because the 24-hour certificate rotates from 16 to 22 hours after the cluster is installed. By using the Ignition config files within 12 hours, you can avoid installation failure if the certificate update runs during installation.



## IMPORTANT

You must not delete the installation program or the files that the installation program creates. Both are required to delete the cluster.

### 4.5.10. Installing the OpenShift CLI by downloading the binary

You can install the OpenShift CLI (**oc**) to interact with OpenShift Container Platform from a command-line interface. You can install **oc** on Linux, Windows, or macOS.

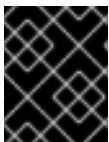

## IMPORTANT

If you installed an earlier version of **oc**, you cannot use it to complete all of the commands in OpenShift Container Platform 4.10. Download and install the new version of **oc**.

#### Installing the OpenShift CLI on Linux

You can install the OpenShift CLI (**oc**) binary on Linux by using the following procedure.

#### Procedure

1. Navigate to the [OpenShift Container Platform downloads page](#) on the Red Hat Customer Portal.
2. Select the appropriate version in the **Version** drop-down menu.
3. Click **Download Now** next to the **OpenShift v4.10 Linux Client** entry and save the file.
4. Unpack the archive:

```
$ tar xvf <file>
```

5. Place the **oc** binary in a directory that is on your **PATH**.  
To check your **PATH**, execute the following command:

```
$ echo $PATH
```

After you install the OpenShift CLI, it is available using the **oc** command:

```
$ oc <command>
```

### Installing the OpenShift CLI on Windows

You can install the OpenShift CLI (**oc**) binary on Windows by using the following procedure.

#### Procedure

1. Navigate to the [OpenShift Container Platform downloads page](#) on the Red Hat Customer Portal.
2. Select the appropriate version in the **Version** drop-down menu.
3. Click **Download Now** next to the **OpenShift v4.10 Windows Client** entry and save the file.
4. Unzip the archive with a ZIP program.
5. Move the **oc** binary to a directory that is on your **PATH**.  
To check your **PATH**, open the command prompt and execute the following command:

```
C:\> path
```

After you install the OpenShift CLI, it is available using the **oc** command:

```
C:\> oc <command>
```

### Installing the OpenShift CLI on macOS

You can install the OpenShift CLI (**oc**) binary on macOS by using the following procedure.

#### Procedure

1. Navigate to the [OpenShift Container Platform downloads page](#) on the Red Hat Customer Portal.
2. Select the appropriate version in the **Version** drop-down menu.
3. Click **Download Now** next to the **OpenShift v4.10 MacOSX Client** entry and save the file.

4. Unpack and unzip the archive.
5. Move the **oc** binary to a directory on your PATH.  
To check your **PATH**, open a terminal and execute the following command:

```
$ echo $PATH
```

After you install the OpenShift CLI, it is available using the **oc** command:

```
$ oc <command>
```

#### 4.5.11. Logging in to the cluster by using the CLI

You can log in to your cluster as a default system user by exporting the cluster **kubeconfig** file. The **kubeconfig** file contains information about the cluster that is used by the CLI to connect a client to the correct cluster and API server. The file is specific to a cluster and is created during OpenShift Container Platform installation.

##### Prerequisites

- You deployed an OpenShift Container Platform cluster.
- You installed the **oc** CLI.

##### Procedure

1. Export the **kubeadmin** credentials:

```
$ export KUBECONFIG=<installation_directory>/auth/kubeconfig 1
```

- 1** For **<installation\_directory>**, specify the path to the directory that you stored the installation files in.

2. Verify you can run **oc** commands successfully using the exported configuration:

```
$ oc whoami
```

##### Example output

```
system:admin
```

#### 4.5.12. Logging in to the cluster by using the web console

The **kubeadmin** user exists by default after an OpenShift Container Platform installation. You can log in to your cluster as the **kubeadmin** user by using the OpenShift Container Platform web console.

##### Prerequisites

- You have access to the installation host.
- You completed a cluster installation and all cluster Operators are available.

## Procedure

1. Obtain the password for the **kubeadmin** user from the **kubeadmin-password** file on the installation host:

```
$ cat <installation_directory>/auth/kubeadmin-password
```

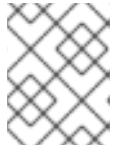

### NOTE

Alternatively, you can obtain the **kubeadmin** password from the **<installation\_directory>/openshift\_install.log** log file on the installation host.

2. List the OpenShift Container Platform web console route:

```
$ oc get routes -n openshift-console | grep 'console-openshift'
```

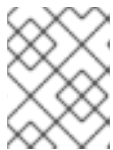

### NOTE

Alternatively, you can obtain the OpenShift Container Platform route from the **<installation\_directory>/openshift\_install.log** log file on the installation host.

## Example output

```
console    console-openshift-console.apps.<cluster_name>.<base_domain>    console
https    reencrypt/Redirect    None
```

3. Navigate to the route detailed in the output of the preceding command in a web browser and log in as the **kubeadmin** user.

## 4.5.13. Telemetry access for OpenShift Container Platform

In OpenShift Container Platform 4.10, the Telemetry service, which runs by default to provide metrics about cluster health and the success of updates, requires internet access. If your cluster is connected to the internet, Telemetry runs automatically, and your cluster is registered to [OpenShift Cluster Manager](#).

After you confirm that your [OpenShift Cluster Manager](#) inventory is correct, either maintained automatically by Telemetry or manually by using OpenShift Cluster Manager, [use subscription watch](#) to track your OpenShift Container Platform subscriptions at the account or multi-cluster level.

### Additional resources

- See [About remote health monitoring](#) for more information about the Telemetry service.
- See [Accessing the web console](#) for more details about accessing and understanding the OpenShift Container Platform web console
- See [Accessing the web console](#) for more details about accessing and understanding the OpenShift Container Platform web console.

## 4.5.14. Next steps

- [Validate an installation.](#)

- [Customize your cluster](#).
- If necessary, you can [opt out of remote health reporting](#).

## 4.6. INSTALLING A CLUSTER ON ALIBABA CLOUD INTO AN EXISTING VPC

In OpenShift Container Platform version 4.10, you can install a cluster into an existing Alibaba Virtual Private Cloud (VPC) on Alibaba Cloud Services. The installation program provisions the required infrastructure, which can then be customized. To customize the VPC installation, modify the parameters in the 'install-config.yaml' file before you install the cluster.

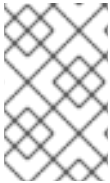

### NOTE

The scope of the OpenShift Container Platform installation configurations is intentionally narrow. It is designed for simplicity and ensured success. You can complete many more OpenShift Container Platform configuration tasks after an installation completes.



### IMPORTANT

Alibaba Cloud on OpenShift Container Platform is a Technology Preview feature only. Technology Preview features are not supported with Red Hat production service level agreements (SLAs) and might not be functionally complete. Red Hat does not recommend using them in production. These features provide early access to upcoming product features, enabling customers to test functionality and provide feedback during the development process.

For more information about the support scope of Red Hat Technology Preview features, see [Technology Preview Features Support Scope](#).

### 4.6.1. Prerequisites

- You reviewed details about the [OpenShift Container Platform installation and update](#) processes.
- You read the documentation on [selecting a cluster installation method and preparing it for users](#).
- You [registered your domain](#).
- If you use a firewall, you [configured it to allow the sites](#) that your cluster requires access to.
- If the cloud Resource Access Management (RAM) APIs are not accessible in your environment, or if you do not want to store an administrator-level credential secret in the **kube-system** namespace, you can [manually create and maintain Resource Access Management \(RAM\) credentials](#).

### 4.6.2. Using a custom VPC

In OpenShift Container Platform 4.10, you can deploy a cluster into existing subnets in an existing Virtual Private Cloud (VPC) in the Alibaba Cloud Platform. By deploying OpenShift Container Platform into an existing Alibaba VPC, you can avoid limit constraints in new accounts and more easily adhere to your

organization's operational constraints. If you cannot obtain the infrastructure creation permissions that are required to create the VPC yourself, use this installation option. You must configure networking using vSwitches.

#### 4.6.2.1. Requirements for using your VPC

The union of the VPC CIDR block and the machine network CIDR must be non-empty. The vSwitches must be within the machine network.

The installation program does not create the following components:

- VPC
- vSwitches
- Route table
- NAT gateway



#### NOTE

The installation program requires that you use the cloud-provided DNS server. Using a custom DNS server is not supported and causes the installation to fail.

#### 4.6.2.2. VPC validation

To ensure that the vSwitches you provide are suitable, the installation program confirms the following data:

- All the vSwitches that you specify must exist.
- You have provided one or more vSwitches for control plane machines and compute machines.
- The vSwitches' CIDRs belong to the machine CIDR that you specified.

#### 4.6.2.3. Division of permissions

Some individuals can create different resources in your cloud than others. For example, you might be able to create application-specific items, like instances, buckets, and load balancers, but not networking-related components, such as VPCs or vSwitches.

#### 4.6.2.4. Isolation between clusters

If you deploy OpenShift Container Platform into an existing network, the isolation of cluster services is reduced in the following ways:

- You can install multiple OpenShift Container Platform clusters in the same VPC.
- ICMP ingress is allowed to the entire network.
- TCP 22 ingress (SSH) is allowed to the entire network.
- Control plane TCP 6443 ingress (Kubernetes API) is allowed to the entire network.
- Control plane TCP 22623 ingress (MCS) is allowed to the entire network.



### 4.6.3. Internet access for OpenShift Container Platform

In OpenShift Container Platform 4.10, you require access to the internet to install your cluster.

You must have internet access to:

- Access [OpenShift Cluster Manager](#) to download the installation program and perform subscription management. If the cluster has internet access and you do not disable Telemetry, that service automatically entitles your cluster.
- Access [Quay.io](#) to obtain the packages that are required to install your cluster.
- Obtain the packages that are required to perform cluster updates.



#### IMPORTANT

If your cluster cannot have direct internet access, you can perform a restricted network installation on some types of infrastructure that you provision. During that process, you download the required content and use it to populate a mirror registry with the installation packages. With some installation types, the environment that you install your cluster in will not require internet access. Before you update the cluster, you update the content of the mirror registry.

### 4.6.4. Generating a key pair for cluster node SSH access

During an OpenShift Container Platform installation, you can provide an SSH public key to the installation program. The key is passed to the Red Hat Enterprise Linux CoreOS (RHCOS) nodes through their Ignition config files and is used to authenticate SSH access to the nodes. The key is added to the `~/.ssh/authorized_keys` list for the **core** user on each node, which enables password-less authentication.

After the key is passed to the nodes, you can use the key pair to SSH in to the RHCOS nodes as the user **core**. To access the nodes through SSH, the private key identity must be managed by SSH for your local user.

If you want to SSH in to your cluster nodes to perform installation debugging or disaster recovery, you must provide the SSH public key during the installation process. The `./openshift-install gather` command also requires the SSH public key to be in place on the cluster nodes.

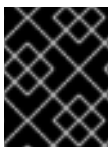

#### IMPORTANT

Do not skip this procedure in production environments, where disaster recovery and debugging is required.



#### NOTE

You must use a local key, not one that you configured with platform-specific approaches such as [AWS key pairs](#).

#### Procedure

1. If you do not have an existing SSH key pair on your local machine to use for authentication onto your cluster nodes, create one. For example, on a computer that uses a Linux operating system, run the following command:

```
$ ssh-keygen -t ed25519 -N "" -f <path>/<file_name> 1
```

- 1 Specify the path and file name, such as `~/.ssh/id_ed25519`, of the new SSH key. If you have an existing key pair, ensure your public key is in the your `~/.ssh` directory.



#### NOTE

If you plan to install an OpenShift Container Platform cluster that uses FIPS validated or Modules In Process cryptographic libraries on the **x86\_64** architecture, do not create a key that uses the **ed25519** algorithm. Instead, create a key that uses the **rsa** or **ecdsa** algorithm.

2. View the public SSH key:

```
$ cat <path>/<file_name>.pub
```

For example, run the following to view the `~/.ssh/id_ed25519.pub` public key:

```
$ cat ~/.ssh/id_ed25519.pub
```

3. Add the SSH private key identity to the SSH agent for your local user, if it has not already been added. SSH agent management of the key is required for password-less SSH authentication onto your cluster nodes, or if you want to use the `./openshift-install gather` command.



#### NOTE

On some distributions, default SSH private key identities such as `~/.ssh/id_rsa` and `~/.ssh/id_dsa` are managed automatically.

- a. If the **ssh-agent** process is not already running for your local user, start it as a background task:

```
$ eval "$(ssh-agent -s)"
```

#### Example output

```
Agent pid 31874
```



#### NOTE

If your cluster is in FIPS mode, only use FIPS-compliant algorithms to generate the SSH key. The key must be either RSA or ECDSA.

4. Add your SSH private key to the **ssh-agent**:

```
$ ssh-add <path>/<file_name> 1
```

- 1 Specify the path and file name for your SSH private key, such as `~/.ssh/id_ed25519`

## Example output

```
Identity added: /home/<you>/<path>/<file_name> (<computer_name>)
```

## Next steps

- When you install OpenShift Container Platform, provide the SSH public key to the installation program.

## 4.6.5. Obtaining the installation program

Before you install OpenShift Container Platform, download the installation file on a local computer.

## Prerequisites

- You have a computer that runs Linux or macOS, with 500 MB of local disk space

## Procedure

1. Access the [Infrastructure Provider](#) page on the OpenShift Cluster Manager site. If you have a Red Hat account, log in with your credentials. If you do not, create an account.
2. Select your infrastructure provider.
3. Navigate to the page for your installation type, download the installation program that corresponds with your host operating system and architecture, and place the file in the directory where you will store the installation configuration files.



### IMPORTANT

The installation program creates several files on the computer that you use to install your cluster. You must keep the installation program and the files that the installation program creates after you finish installing the cluster. Both files are required to delete the cluster.

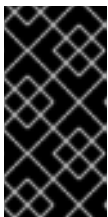

### IMPORTANT

Deleting the files created by the installation program does not remove your cluster, even if the cluster failed during installation. To remove your cluster, complete the OpenShift Container Platform uninstallation procedures for your specific cloud provider.

4. Extract the installation program. For example, on a computer that uses a Linux operating system, run the following command:

```
$ tar -xvf openshift-install-linux.tar.gz
```

5. Download your installation [pull secret from the Red Hat OpenShift Cluster Manager](#) . This pull secret allows you to authenticate with the services that are provided by the included authorities, including Quay.io, which serves the container images for OpenShift Container Platform components.

### 4.6.5.1. Creating the installation configuration file

You can customize the OpenShift Container Platform cluster you install on Alibaba Cloud.

#### Prerequisites

- Obtain the OpenShift Container Platform installation program and the pull secret for your cluster.
- Obtain service principal permissions at the subscription level.

#### Procedure

1. Create the **install-config.yaml** file.
  - a. Change to the directory that contains the installation program and run the following command:

```
$ ./openshift-install create install-config --dir <installation_directory> 1
```

- 1** For **<installation\_directory>**, specify the directory name to store the files that the installation program creates.



#### IMPORTANT

Specify an empty directory. Some installation assets, like bootstrap X.509 certificates have short expiration intervals, so you must not reuse an installation directory. If you want to reuse individual files from another cluster installation, you can copy them into your directory. However, the file names for the installation assets might change between releases. Use caution when copying installation files from an earlier OpenShift Container Platform version.

- b. At the prompts, provide the configuration details for your cloud:
  - i. Optional: Select an SSH key to use to access your cluster machines.



#### NOTE

For production OpenShift Container Platform clusters on which you want to perform installation debugging or disaster recovery, specify an SSH key that your **ssh-agent** process uses.

- ii. Select **alibabacloud** as the platform to target.
- iii. Select the region to deploy the cluster to.
- iv. Select the base domain to deploy the cluster to. The base domain corresponds to the public DNS zone that you created for your cluster.
- v. Provide a descriptive name for your cluster.
- vi. Paste the [pull secret from the Red Hat OpenShift Cluster Manager](#) .

- Installing the cluster into Alibaba Cloud requires that the Cloud Credential Operator (CCO) operate in manual mode. Modify the **install-config.yaml** file to set the **credentialsMode** parameter to **Manual**:

#### Example **install-config.yaml** configuration file with **credentialsMode** set to **Manual**

```
apiVersion: v1
baseDomain: cluster1.example.com
credentialsMode: Manual 1
compute:
- architecture: amd64
  hyperthreading: Enabled
...
```

- Add this line to set the **credentialsMode** to **Manual**.

- Modify the **install-config.yaml** file. You can find more information about the available parameters in the "Installation configuration parameters" section.
- Back up the **install-config.yaml** file so that you can use it to install multiple clusters.

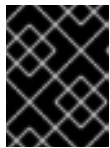

#### IMPORTANT

The **install-config.yaml** file is consumed during the installation process. If you want to reuse the file, you must back it up now.

#### 4.6.5.2. Installation configuration parameters

Before you deploy an OpenShift Container Platform cluster, you provide parameter values to describe your account on the cloud platform that hosts your cluster and optionally customize your cluster's platform. When you create the **install-config.yaml** installation configuration file, you provide values for the required parameters through the command line. If you customize your cluster, you can modify the **install-config.yaml** file to provide more details about the platform.



#### NOTE

After installation, you cannot modify these parameters in the **install-config.yaml** file.

##### 4.6.5.2.1. Required configuration parameters

Required installation configuration parameters are described in the following table:

Table 4.15. Required parameters

Parameter	Description	Values
<b>apiVersion</b>	The API version for the <b>install-config.yaml</b> content. The current version is <b>v1</b> . The installer may also support older API versions.	String

Parameter	Description	Values
<b>baseDomain</b>	The base domain of your cloud provider. The base domain is used to create routes to your OpenShift Container Platform cluster components. The full DNS name for your cluster is a combination of the <b>baseDomain</b> and <b>metadata.name</b> parameter values that uses the <b>&lt;metadata.name&gt;.&lt;baseDomain&gt;</b> format.	A fully-qualified domain or subdomain name, such as <b>example.com</b> .
<b>metadata</b>	Kubernetes resource <b>ObjectMeta</b> , from which only the <b>name</b> parameter is consumed.	Object
<b>metadata.name</b>	The name of the cluster. DNS records for the cluster are all subdomains of <b>{{.metadata.name}}</b> . <b>{{.baseDomain}}</b> .	String of lowercase letters, hyphens (-), and periods (.), such as <b>dev</b> .
<b>platform</b>	The configuration for the specific platform upon which to perform the installation: <b>alibabacloud, aws, baremetal, azure, gcp, ibmcloud, openstack, ovirt, vsphere</b> , or <b>{}</b> . For additional information about <b>platform.&lt;platform&gt;</b> parameters, consult the table for your specific platform that follows.	Object

Parameter	Description	Values
<b>pullSecret</b>	Get a <a href="#">pull secret from the Red Hat OpenShift Cluster Manager</a> to authenticate downloading container images for OpenShift Container Platform components from services such as Quay.io.	<pre>{   "auths":{     "cloud.openshift.com":{       "auth":"b3Blb=",       "email":"you@example.com"     },     "quay.io":{       "auth":"b3Blb=",       "email":"you@example.com"     }   } }</pre>

#### 4.6.5.2.2. Network configuration parameters

You can customize your installation configuration based on the requirements of your existing network infrastructure. For example, you can expand the IP address block for the cluster network or provide different IP address blocks than the defaults.

Only IPv4 addresses are supported.

Table 4.16. Network parameters

Parameter	Description	Values
<b>networking</b>	The configuration for the cluster network.	Object  <p><b>NOTE</b></p> <p>You cannot modify parameters specified by the <b>networking</b> object after installation.</p>
<b>networking.networkType</b>	The cluster network provider Container Network Interface (CNI) plugin to install.	Either <b>OpenShiftSDN</b> or <b>OVNKubernetes</b> . <b>OpenShiftSDN</b> is a CNI provider for all-Linux networks. <b>OVNKubernetes</b> is a CNI provider for Linux networks and hybrid networks that contain both Linux and Windows servers. The default value is <b>OpenShiftSDN</b> .

Parameter	Description	Values
<b>networking.clusterNetwork</b>	<p>The IP address blocks for pods.</p> <p>The default value is <b>10.128.0.0/14</b> with a host prefix of <b>/23</b>.</p> <p>If you specify multiple IP address blocks, the blocks must not overlap.</p>	<p>An array of objects. For example:</p> <pre>networking:   clusterNetwork:     - cidr: 10.128.0.0/14       hostPrefix: 23</pre>
<b>networking.clusterNetwork.cidr</b>	<p>Required if you use <b>networking.clusterNetwork</b>. An IP address block.</p> <p>An IPv4 network.</p>	<p>An IP address block in Classless Inter-Domain Routing (CIDR) notation. The prefix length for an IPv4 block is between <b>0</b> and <b>32</b>.</p>
<b>networking.clusterNetwork.hostPrefix</b>	<p>The subnet prefix length to assign to each individual node. For example, if <b>hostPrefix</b> is set to <b>23</b> then each node is assigned a <b>/23</b> subnet out of the given <b>cidr</b>. A <b>hostPrefix</b> value of <b>23</b> provides 510 (<math>2^{(32 - 23)} - 2</math>) pod IP addresses.</p>	<p>A subnet prefix.</p> <p>The default value is <b>23</b>.</p>
<b>networking.serviceNetwork</b>	<p>The IP address block for services. The default value is <b>172.30.0.0/16</b>.</p> <p>The OpenShift SDN and OVN-Kubernetes network providers support only a single IP address block for the service network.</p>	<p>An array with an IP address block in CIDR format. For example:</p> <pre>networking:   serviceNetwork:     - 172.30.0.0/16</pre>
<b>networking.machineNetwork</b>	<p>The IP address blocks for machines.</p> <p>If you specify multiple IP address blocks, the blocks must not overlap.</p>	<p>An array of objects. For example:</p> <pre>networking:   machineNetwork:     - cidr: 10.0.0.0/16</pre>
<b>networking.machineNetwork.cidr</b>	<p>Required if you use <b>networking.machineNetwork</b>. An IP address block. The default value is <b>10.0.0.0/16</b> for all platforms other than libvirt. For libvirt, the default value is <b>192.168.126.0/24</b>.</p>	<p>An IP network block in CIDR notation.</p> <p>For example, <b>10.0.0.0/16</b>.</p> <div style="display: flex; align-items: flex-start;">  <div> <p><b>NOTE</b></p> <p>Set the <b>networking.machineNetwork</b> to match the CIDR that the preferred NIC resides in.</p> </div> </div>





## 4.6.5.2.3. Optional configuration parameters

Optional installation configuration parameters are described in the following table:

Table 4.17. Optional parameters

Parameter	Description	Values
<b>additionalTrustBundle</b>	A PEM-encoded X.509 certificate bundle that is added to the nodes' trusted certificate store. This trust bundle may also be used when a proxy has been configured.	String
<b>cgroupsV2</b>	Enables <a href="#">Linux control groups version 2</a> (cgroups v2) on specific nodes in your cluster. The OpenShift Container Platform process for enabling cgroups v2 disables all cgroup version 1 controllers and hierarchies. The OpenShift Container Platform cgroups version 2 feature is in Developer Preview and is not supported by Red Hat at this time.	<b>true</b>
<b>compute</b>	The configuration for the machines that comprise the compute nodes.	Array of <b>MachinePool</b> objects.
<b>compute.architecture</b>	Determines the instruction set architecture of the machines in the pool. Currently, clusters with varied architectures are not supported. All pools must specify the same architecture. Valid values are <b>amd64</b> (the default).	String
<b>compute.hyperthreading</b>	Whether to enable or disable simultaneous multithreading, or <b>hyperthreading</b> , on compute machines. By default, simultaneous multithreading is enabled to increase the performance of your machines' cores.	<b>Enabled</b> or <b>Disabled</b>
	 <p><b>IMPORTANT</b></p> <p>If you disable simultaneous multithreading, ensure that your capacity planning accounts for the dramatically decreased machine performance.</p>	

Parameter	Description	Values
<b>compute.name</b>	Required if you use <b>compute</b> . The name of the machine pool.	<b>worker</b>
<b>compute.platform</b>	Required if you use <b>compute</b> . Use this parameter to specify the cloud provider to host the worker machines. This parameter value must match the <b>controlPlane.platform</b> parameter value.	<b>alibabacloud, aws, azure, gcp, ibmcloud, openstack, ovirt, vsphere</b> , or <b>{}</b>
<b>compute.replicas</b>	The number of compute machines, which are also known as worker machines, to provision.	A positive integer greater than or equal to <b>2</b> . The default value is <b>3</b> .
<b>controlPlane</b>	The configuration for the machines that comprise the control plane.	Array of <b>MachinePool</b> objects.
<b>controlPlane.architecture</b>	Determines the instruction set architecture of the machines in the pool. Currently, clusters with varied architectures are not supported. All pools must specify the same architecture. Valid values are <b>amd64</b> (the default).	String
<b>controlPlane.hyperthreading</b>	<p>Whether to enable or disable simultaneous multithreading, or <b>hyperthreading</b>, on control plane machines. By default, simultaneous multithreading is enabled to increase the performance of your machines' cores.</p> <div style="display: flex; align-items: center;">  <div> <p><b>IMPORTANT</b></p> <p>If you disable simultaneous multithreading, ensure that your capacity planning accounts for the dramatically decreased machine performance.</p> </div> </div>	<b>Enabled</b> or <b>Disabled</b>
<b>controlPlane.name</b>	Required if you use <b>controlPlane</b> . The name of the machine pool.	<b>master</b>

Parameter	Description	Values
<b>controlPlane.platform</b>	Required if you use <b>controlPlane</b> . Use this parameter to specify the cloud provider that hosts the control plane machines. This parameter value must match the <b>compute.platform</b> parameter value.	<b>alibabacloud, aws, azure, gcp, ibmcloud, openstack, ovirt, vsphere</b> , or {}
<b>controlPlane.replicas</b>	The number of control plane machines to provision.	The only supported value is <b>3</b> , which is the default value.
<b>credentialsMode</b>	<p>The Cloud Credential Operator (CCO) mode. If no mode is specified, the CCO dynamically tries to determine the capabilities of the provided credentials, with a preference for mint mode on the platforms where multiple modes are supported.</p> <div style="display: flex; align-items: flex-start;"> <div style="flex: 1;">  </div> <div style="flex: 2;"> <p><b>NOTE</b></p> <p>Not all CCO modes are supported for all cloud providers. For more information on CCO modes, see the <i>Cloud Credential Operator</i> entry in the <i>Cluster Operators reference</i> content.</p> </div> </div> <div style="display: flex; align-items: flex-start; margin-top: 10px;"> <div style="flex: 1;">  </div> <div style="flex: 2;"> <p><b>NOTE</b></p> <p>If your AWS account has service control policies (SCP) enabled, you must configure the <b>credentialsMode</b> parameter to <b>Mint, Passthrough</b> or <b>Manual</b>.</p> </div> </div>	<b>Mint, Passthrough, Manual</b> or an empty string ("").

Parameter	Description	Values
<p><b>fips</b></p>	<p>Enable or disable FIPS mode. The default is <b>false</b> (disabled). If FIPS mode is enabled, the Red Hat Enterprise Linux CoreOS (RHCOS) machines that OpenShift Container Platform runs on bypass the default Kubernetes cryptography suite and use the cryptography modules that are provided with RHCOS instead.</p> <div data-bbox="488 586 592 1361" style="background-color: black; color: white; padding: 5px; margin-bottom: 10px;"> <p><b>IMPORTANT</b></p> <p>To enable FIPS mode for your cluster, you must run the installation program from a Red Hat Enterprise Linux (RHEL) computer configured to operate in FIPS mode. For more information about configuring FIPS mode on RHEL, see <a href="#">Installing the system in FIPS mode</a>. The use of FIPS validated or Modules In Process cryptographic libraries is only supported on OpenShift Container Platform deployments on the <b>x86_64</b> architecture.</p> </div> <div data-bbox="488 1408 592 1603" style="background-color: black; color: white; padding: 5px;"> <p><b>NOTE</b></p> <p>If you are using Azure File storage, you cannot enable FIPS mode.</p> </div>	<p><b>false</b> or <b>true</b></p>

Parameter	Description	Values
<b>imageContentSources</b>	Sources and repositories for the release-image content.	Array of objects. Includes a <b>source</b> and, optionally, <b>mirrors</b> , as described in the following rows of this table.
<b>imageContentSources.source</b>	Required if you use <b>imageContentSources</b> . Specify the repository that users refer to, for example, in image pull specifications.	String
<b>imageContentSources.mirrors</b>	Specify one or more repositories that may also contain the same images.	Array of strings
<b>publish</b>	How to publish or expose the user-facing endpoints of your cluster, such as the Kubernetes API, OpenShift routes.	<p><b>Internal</b> or <b>External</b>. The default value is <b>External</b>.</p> <p>Setting this field to <b>Internal</b> is not supported on non-cloud platforms and IBM Cloud VPC.</p> <div style="display: flex; align-items: flex-start;">  <div> <p><b>IMPORTANT</b></p> <p>If the value of the field is set to <b>Internal</b>, the cluster will become non-functional. For more information, refer to <a href="#">BZ#1953035</a>.</p> </div> </div>
<b>sshKey</b>	<p>The SSH key or keys to authenticate access your cluster machines.</p> <div style="display: flex; align-items: flex-start;">  <div> <p><b>NOTE</b></p> <p>For production OpenShift Container Platform clusters on which you want to perform installation debugging or disaster recovery, specify an SSH key that your <b>ssh-agent</b> process uses.</p> </div> </div>	<p>One or more keys. For example:</p> <pre>sshKey:   &lt;key1&gt;   &lt;key2&gt;   &lt;key3&gt;</pre>

#### 4.6.5.2.4. Additional Alibaba Cloud configuration parameters

Additional Alibaba Cloud configuration parameters are described in the following table. The

**alibabacloud** parameters are the configuration used when installing on Alibaba Cloud. The **defaultMachinePlatform** parameters are the default configuration used when installing on Alibaba Cloud for machine pools that do not define their own platform configuration.

These parameters apply to both compute machines and control plane machines where specified.



#### NOTE

If defined, the parameters **compute.platform.alibabacloud** and **controlPlane.platform.alibabacloud** will overwrite **platform.alibabacloud.defaultMachinePlatform** settings for compute machines and control plane machines respectively.

Table 4.18. Optional Alibaba Cloud parameters

Parameter	Description	Values
<b>compute.platform.alibabacloud.imageID</b>	The imageID used to create the ECS instance. ImageID must belong to the same region as the cluster.	String.
<b>compute.platform.alibabacloud.instanceType</b>	InstanceType defines the ECS instance type. Example: <b>ecs.g6.large</b>	String.
<b>compute.platform.alibabacloud.systemDiskCategory</b>	Defines the category of the system disk. Examples: <b>cloud_efficiency,cloud_essd</b>	String.
<b>compute.platform.alibabacloud.systemDiskSize</b>	Defines the size of the system disk in gibibytes (GiB).	Integer.
<b>compute.platform.alibabacloud.zones</b>	The list of availability zones that can be used. Examples: <b>cn-hangzhou-h, cn-hangzhou-j</b>	String list.
<b>controlPlane.platform.alibabacloud.imageID</b>	The imageID used to create the ECS instance. ImageID must belong to the same region as the cluster.	String.
<b>controlPlane.platform.alibabacloud.instanceType</b>	InstanceType defines the ECS instance type. Example: <b>ecs.g6.xlarge</b>	String.

Parameter	Description	Values
<b>controlPlane.platform.alibabacloud.systemDiskCategory</b>	Defines the category of the system disk. Examples: <b>cloud_efficiency,cloud_essd</b>	String.
<b>controlPlane.platform.alibabacloud.systemDisksize</b>	Defines the size of the system disk in gibibytes (GiB).	Integer.
<b>controlPlane.platform.alibabacloud.zones</b>	The list of availability zones that can be used. Examples: <b>cn-hangzhou-h, cn-hangzhou-j</b>	String list.
<b>platform.alibabacloud.region</b>	Required.The Alibaba Cloud region where the cluster will be created.	String.
<b>platform.alibabacloud.resourceGroupID</b>	The ID of an already existing resource group where the cluster will be installed. If empty, the installer will create a new resource group for the cluster.	String.
<b>platform.alibabacloud.tags</b>	Additional keys and values to apply to all Alibaba Cloud resources created for the cluster.	Object.
<b>platform.alibabacloud.vpcID</b>	The ID of an already existing VPC where the cluster should be installed. If empty, the installer will create a new VPC for the cluster.	String.
<b>platform.alibabacloud.vswitchIDs</b>	The ID list of already existing VSwitches where cluster resources will be created. The existing VSwitches can only be used when also using existing VPC. If empty, the installer will create new VSwitches for the cluster.	String list.

Parameter	Description	Values
<b>platform.alibabacloud.defaultMachinePlatform.imageID</b>	For both compute machines and control plane machines, the image ID that should be used to create ECS instance. If set, the image ID should belong to the same region as the cluster.	String.
<b>platform.alibabacloud.defaultMachinePlatform.instanceType</b>	For both compute machines and control plane machines, the ECS instance type used to create the ECS instance. Example: <b>ecs.g6.xlarge</b>	String.
<b>platform.alibabacloud.defaultMachinePlatform.systemDiskCategory</b>	For both compute machines and control plane machines, the category of the system disk. Examples: <b>cloud_efficiency</b> , <b>cloud_essd</b> .	String, for example "", <b>cloud_efficiency</b> , <b>cloud_essd</b> .
<b>platform.alibabacloud.defaultMachinePlatform.systemDiskSize</b>	For both compute machines and control plane machines, the size of the system disk in gibibytes (GiB). The minimum is <b>120</b> .	Integer.
<b>platform.alibabacloud.defaultMachinePlatform.zones</b>	For both compute machines and control plane machines, the list of availability zones that can be used. Examples: <b>cn-hangzhou-h</b> , <b>cn-hangzhou-j</b>	String list.
<b>platform.alibabacloud.privateZoneID</b>	The ID of an existing private zone into which to add DNS records for the cluster's internal API. An existing private zone can only be used when also using existing VPC. The private zone must be associated with the VPC containing the subnets. Leave the private zone unset to have the installer create the private zone on your behalf.	String.

#### 4.6.5.3. Sample customized install-config.yaml file for Alibaba Cloud



You can customize the installation configuration file (**install-config.yaml**) to specify more details about your cluster's platform or modify the values of the required parameters.

```

apiVersion: v1
baseDomain: alicloud-dev.devcluster.openshift.com
credentialsMode: Manual
compute:
- architecture: amd64
  hyperthreading: Enabled
  name: worker
  platform: {}
  replicas: 3
controlPlane:
  architecture: amd64
  hyperthreading: Enabled
  name: master
  platform: {}
  replicas: 3
metadata:
  creationTimestamp: null
  name: test-cluster ❶
networking:
  clusterNetwork:
  - cidr: 10.128.0.0/14
    hostPrefix: 23
  machineNetwork:
  - cidr: 10.0.0.0/16
  networkType: OpenShiftSDN ❷
  serviceNetwork:
  - 172.30.0.0/16
platform:
  alibabacloud:
    defaultMachinePlatform: ❸
    instanceType: ecs.g6.xlarge
    systemDiskCategory: cloud_efficiency
    systemDiskSize: 200
    region: ap-southeast-1 ❹
    resourceGroupID: rg-acfnw6j3hyai ❺
    vpcID: vpc-0xifdjerdibmaqvtbody2b
    vswitchIDs: ❻
    - vsw-0xi8ycgwc8wv5rhviwdq5
    - vsw-0xiy6v3z2tedv009b4pz2
  publish: External
  pullSecret: '{"auths": {"cloud.openshift.com": {"auth": ... }}' ❼
  sshKey: |
    ssh-rsa AAAA... ❽

```

- ❶ Required. The installation program prompts you for a cluster name.
- ❷ The cluster network plugin to install. The supported values are **OVNKubernetes** and **OpenShiftSDN**. The default value is **OVNKubernetes**.
- ❸ Optional. Specify parameters for machine pools that do not define their own platform configuration.

- 4 Required. The installation program prompts you for the region to deploy the cluster to.
- 5 Optional. Specify an existing resource group where the cluster should be installed.
- 7 Required. The installation program prompts you for the pull secret.
- 8 Optional. The installation program prompts you for the SSH key value that you use to access the machines in your cluster.
- 6 Optional. These are example vswitchID values.

#### 4.6.5.4. Generating the required installation manifests

You must generate the Kubernetes manifest and Ignition config files that the cluster needs to configure the machines.

##### Procedure

1. Generate the manifests by running the following command from the directory that contains the installation program:

```
$ openshift-install create manifests --dir <installation_directory>
```

where:

**<installation\_directory>**

Specifies the directory in which the installation program creates files.

#### 4.6.5.5. Configuring the Cloud Credential Operator utility

To create and manage cloud credentials from outside of the cluster when the Cloud Credential Operator (CCO) is operating in manual mode, extract and prepare the CCO utility (**ccoctl**) binary.



##### NOTE

The **ccoctl** utility is a Linux binary that must run in a Linux environment.

##### Prerequisites

- You have access to an OpenShift Container Platform account with cluster administrator access.
- You have installed the OpenShift CLI (**oc**).

##### Procedure

1. Obtain the OpenShift Container Platform release image:

```
$ RELEASE_IMAGE=$(./openshift-install version | awk '/release image/ {print $3}')
```

2. Get the CCO container image from the OpenShift Container Platform release image:

```
$ CCO_IMAGE=$(oc adm release info --image-for='cloud-credential-operator' $RELEASE_IMAGE)
```

**NOTE**

Ensure that the architecture of the **\$RELEASE\_IMAGE** matches the architecture of the environment in which you will use the **ccoctl** tool.

3. Extract the **ccoctl** binary from the CCO container image within the OpenShift Container Platform release image:

```
$ oc image extract $CCO_IMAGE --file="/usr/bin/ccoctl" -a ~/.pull-secret
```

4. Change the permissions to make **ccoctl** executable:

```
$ chmod 775 ccoctl
```

**Verification**

- To verify that **ccoctl** is ready to use, display the help file:

```
$ ccoctl --help
```

**Output of ccoctl --help**

```
OpenShift credentials provisioning tool
```

```
Usage:
```

```
ccoctl [command]
```

```
Available Commands:
```

```
alibabacloud Manage credentials objects for alibaba cloud
```

```
aws          Manage credentials objects for AWS cloud
```

```
gcp          Manage credentials objects for Google cloud
```

```
help         Help about any command
```

```
ibmcloud     Manage credentials objects for IBM Cloud
```

```
Flags:
```

```
-h, --help  help for ccoctl
```

```
Use "ccoctl [command] --help" for more information about a command.
```

**4.6.5.6. Creating credentials for OpenShift Container Platform components with the ccoctl tool**

You can use the OpenShift Container Platform Cloud Credential Operator (CCO) utility to automate the creation of Alibaba Cloud RAM users and policies for each in-cluster component.

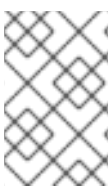
**NOTE**

By default, **ccoctl** creates objects in the directory in which the commands are run. To create the objects in a different directory, use the **--output-dir** flag. This procedure uses **<path\_to\_ccoctl\_output\_dir>** to refer to this directory.

**Prerequisites**

You must have:

- Extracted and prepared the **ccoctl** binary.
- Created a RAM user with sufficient permission to create the OpenShift Container Platform cluster.
- Added the AccessKeyID (**access\_key\_id**) and AccessKeySecret (**access\_key\_secret**) of that RAM user into the `~/.alibabacloud/credentials` file on your local computer.

## Procedure

1. Set the **\$RELEASE\_IMAGE** variable by running the following command:

```
$ RELEASE_IMAGE=$(./openshift-install version | awk '/release image/ {print $3}')
```

2. Extract the list of **CredentialsRequest** objects from the OpenShift Container Platform release image by running the following command:

```
$ oc adm release extract \
--credentials-requests \
--cloud=alibabacloud \
--to=<path_to_directory_with_list_of_credentials_requests>/credrequests \ 1
$RELEASE_IMAGE
```

- 1** **credrequests** is the directory where the list of **CredentialsRequest** objects is stored. This command creates the directory if it does not exist.



### NOTE

This command can take a few moments to run.

3. If your cluster uses cluster capabilities to disable one or more optional components, delete the **CredentialsRequest** custom resources for any disabled components.

### Example **credrequests** directory contents for OpenShift Container Platform 4.12 on Alibaba Cloud

```
0000_30_machine-api-operator_00_credentials-request.yaml 1
0000_50_cluster-image-registry-operator_01-registry-credentials-request-alibaba.yaml 2
0000_50_cluster-ingress-operator_00-ingress-credentials-request.yaml 3
0000_50_cluster-storage-operator_03_credentials_request_alibaba.yaml 4
```

- 1** The Machine API Operator CR is required.
- 2** The Image Registry Operator CR is required.
- 3** The Ingress Operator CR is required.
- 4** The Storage Operator CR is an optional component and might be disabled in your cluster.

4. Use the **ccoctl** tool to process all **CredentialsRequest** objects in the **credrequests** directory:

- a. Run the following command to use the tool:

```
$ ccoctl alibabacloud create-ram-users \
--name <name> \
--region=<alibaba_region> \
--credentials-requests-dir=
<path_to_directory_with_list_of_credentials_requests>/credrequests \
--output-dir=<path_to_ccoctl_output_dir>
```

where:

- **<name>** is the name used to tag any cloud resources that are created for tracking.
- **<alibaba\_region>** is the Alibaba Cloud region in which cloud resources will be created.
- **<path\_to\_directory\_with\_list\_of\_credentials\_requests>/credrequests** is the directory containing the files for the component **CredentialsRequest** objects.
- **<path\_to\_ccoctl\_output\_dir>** is the directory where the generated component credentials secrets will be placed.



#### NOTE

If your cluster uses Technology Preview features that are enabled by the **TechPreviewNoUpgrade** feature set, you must include the **--enable-tech-preview** parameter.

#### Example output

```
2022/02/11 16:18:26 Created RAM User: user1-alicloud-openshift-machine-api-
alibabacloud-credentials
2022/02/11 16:18:27 Ready for creating new ram policy user1-alicloud-openshift-
machine-api-alibabacloud-credentials-policy-policy
2022/02/11 16:18:27 RAM policy user1-alicloud-openshift-machine-api-alibabacloud-
credentials-policy-policy has created
2022/02/11 16:18:28 Policy user1-alicloud-openshift-machine-api-alibabacloud-
credentials-policy-policy has attached on user user1-alicloud-openshift-machine-api-
alibabacloud-credentials
2022/02/11 16:18:29 Created access keys for RAM User: user1-alicloud-openshift-
machine-api-alibabacloud-credentials
2022/02/11 16:18:29 Saved credentials configuration to: user1-
alicloud/manifests/openshift-machine-api-alibabacloud-credentials-credentials.yaml
...
```



#### NOTE

A RAM user can have up to two AccessKeys at the same time. If you run **ccoctl alibabacloud create-ram-users** more than twice, the previous generated manifests secret becomes stale and you must reapply the newly generated secrets.

- b. Verify that the OpenShift Container Platform secrets are created:

```
$ ls <path_to_ccoctl_output_dir>/manifests
```

-

**Example output:**

```
openshift-cluster-csi-drivers-alibaba-disk-credentials-credentials.yaml
openshift-image-registry-installer-cloud-credentials-credentials.yaml
openshift-ingress-operator-cloud-credentials-credentials.yaml
openshift-machine-api-alibabacloud-credentials-credentials.yaml
```

You can verify that the RAM users and policies are created by querying Alibaba Cloud. For more information, refer to Alibaba Cloud documentation on listing RAM users and policies.

5. Copy the generated credential files to the target manifests directory:

```
$ cp ./<path_to_ccoctl_output_dir>/manifests/*credentials.yaml
./<path_to_installation>dir/manifests/
```

where:

**<path\_to\_ccoctl\_output\_dir>**

Specifies the directory created by the **ccoctl alibabacloud create-ram-users** command.

**<path\_to\_installation\_dir>**

Specifies the directory in which the installation program creates files.

### 4.6.6. Deploying the cluster

You can install OpenShift Container Platform on a compatible cloud platform.

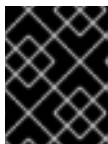
**IMPORTANT**

You can run the **create cluster** command of the installation program only once, during initial installation.

#### Prerequisites

- Configure an account with the cloud platform that hosts your cluster.
- Obtain the OpenShift Container Platform installation program and the pull secret for your cluster.

#### Procedure

1. Change to the directory that contains the installation program and initialize the cluster deployment:

```
$ ./openshift-install create cluster --dir <installation_directory> \ 1
--log-level=info 2
```

- 1** For **<installation\_directory>**, specify the location of your customized **./install-config.yaml** file.
- 2** To view different installation details, specify **warn**, **debug**, or **error** instead of **info**.

**NOTE**

If the cloud provider account that you configured on your host does not have sufficient permissions to deploy the cluster, the installation process stops, and the missing permissions are displayed.

When the cluster deployment completes, directions for accessing your cluster, including a link to its web console and credentials for the **kubeadmin** user, display in your terminal.

**Example output**

```
...
INFO Install complete!
INFO To access the cluster as the system:admin user when using 'oc', run 'export
KUBECONFIG=/home/myuser/install_dir/auth/kubeconfig'
INFO Access the OpenShift web-console here: https://console-openshift-
console.apps.mycluster.example.com
INFO Login to the console with user: "kubeadmin", and password: "4vYBz-Ee6gm-ymBZj-
Wt5AL"
INFO Time elapsed: 36m22s
```

**NOTE**

The cluster access and credential information also outputs to **<installation\_directory>/openshift\_install.log** when an installation succeeds.

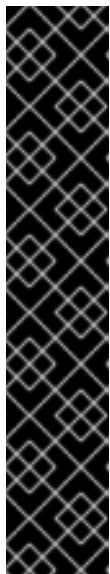
**IMPORTANT**

- The Ignition config files that the installation program generates contain certificates that expire after 24 hours, which are then renewed at that time. If the cluster is shut down before renewing the certificates and the cluster is later restarted after the 24 hours have elapsed, the cluster automatically recovers the expired certificates. The exception is that you must manually approve the pending **node-bootstrapper** certificate signing requests (CSRs) to recover kubelet certificates. See the documentation for *Recovering from expired control plane certificates* for more information.
- It is recommended that you use Ignition config files within 12 hours after they are generated because the 24-hour certificate rotates from 16 to 22 hours after the cluster is installed. By using the Ignition config files within 12 hours, you can avoid installation failure if the certificate update runs during installation.

**IMPORTANT**

You must not delete the installation program or the files that the installation program creates. Both are required to delete the cluster.

**4.6.7. Installing the OpenShift CLI by downloading the binary**

You can install the OpenShift CLI (**oc**) to interact with OpenShift Container Platform from a command-line interface. You can install **oc** on Linux, Windows, or macOS.

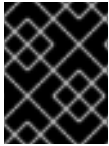

## IMPORTANT

If you installed an earlier version of **oc**, you cannot use it to complete all of the commands in OpenShift Container Platform 4.10. Download and install the new version of **oc**.

### Installing the OpenShift CLI on Linux

You can install the OpenShift CLI (**oc**) binary on Linux by using the following procedure.

#### Procedure

1. Navigate to the [OpenShift Container Platform downloads page](#) on the Red Hat Customer Portal.
2. Select the appropriate version in the **Version** drop-down menu.
3. Click **Download Now** next to the **OpenShift v4.10 Linux Client** entry and save the file.
4. Unpack the archive:

```
$ tar xvf <file>
```

5. Place the **oc** binary in a directory that is on your **PATH**.  
To check your **PATH**, execute the following command:

```
$ echo $PATH
```

After you install the OpenShift CLI, it is available using the **oc** command:

```
$ oc <command>
```

### Installing the OpenShift CLI on Windows

You can install the OpenShift CLI (**oc**) binary on Windows by using the following procedure.

#### Procedure

1. Navigate to the [OpenShift Container Platform downloads page](#) on the Red Hat Customer Portal.
2. Select the appropriate version in the **Version** drop-down menu.
3. Click **Download Now** next to the **OpenShift v4.10 Windows Client** entry and save the file.
4. Unzip the archive with a ZIP program.
5. Move the **oc** binary to a directory that is on your **PATH**.  
To check your **PATH**, open the command prompt and execute the following command:

```
C:\> path
```

After you install the OpenShift CLI, it is available using the **oc** command:

```
C:\> oc <command>
```



## Installing the OpenShift CLI on macOS

You can install the OpenShift CLI (**oc**) binary on macOS by using the following procedure.

### Procedure

1. Navigate to the [OpenShift Container Platform downloads page](#) on the Red Hat Customer Portal.
2. Select the appropriate version in the **Version** drop-down menu.
3. Click **Download Now** next to the **OpenShift v4.10 MacOSX Client** entry and save the file.
4. Unpack and unzip the archive.
5. Move the **oc** binary to a directory on your PATH.

To check your **PATH**, open a terminal and execute the following command:

```
$ echo $PATH
```

After you install the OpenShift CLI, it is available using the **oc** command:

```
$ oc <command>
```

### 4.6.8. Logging in to the cluster by using the CLI

You can log in to your cluster as a default system user by exporting the cluster **kubeconfig** file. The **kubeconfig** file contains information about the cluster that is used by the CLI to connect a client to the correct cluster and API server. The file is specific to a cluster and is created during OpenShift Container Platform installation.

#### Prerequisites

- You deployed an OpenShift Container Platform cluster.
- You installed the **oc** CLI.

#### Procedure

1. Export the **kubeadmin** credentials:

```
$ export KUBECONFIG=<installation_directory>/auth/kubeconfig 1
```

- 1** For **<installation\_directory>**, specify the path to the directory that you stored the installation files in.

2. Verify you can run **oc** commands successfully using the exported configuration:

```
$ oc whoami
```

#### Example output

```
system:admin
```

### 4.6.9. Logging in to the cluster by using the web console

The **kubeadmin** user exists by default after an OpenShift Container Platform installation. You can log in to your cluster as the **kubeadmin** user by using the OpenShift Container Platform web console.

#### Prerequisites

- You have access to the installation host.
- You completed a cluster installation and all cluster Operators are available.

#### Procedure

1. Obtain the password for the **kubeadmin** user from the **kubeadmin-password** file on the installation host:

```
$ cat <installation_directory>/auth/kubeadmin-password
```

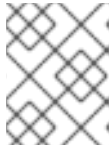

#### NOTE

Alternatively, you can obtain the **kubeadmin** password from the **<installation\_directory>/openshift\_install.log** log file on the installation host.

2. List the OpenShift Container Platform web console route:

```
$ oc get routes -n openshift-console | grep 'console-openshift'
```



#### NOTE

Alternatively, you can obtain the OpenShift Container Platform route from the **<installation\_directory>/openshift\_install.log** log file on the installation host.

#### Example output

```
console    console-openshift-console.apps.<cluster_name>.<base_domain>    console
https reencrypt/Redirect None
```

3. Navigate to the route detailed in the output of the preceding command in a web browser and log in as the **kubeadmin** user.

### 4.6.10. Telemetry access for OpenShift Container Platform

In OpenShift Container Platform 4.10, the Telemetry service, which runs by default to provide metrics about cluster health and the success of updates, requires internet access. If your cluster is connected to the internet, Telemetry runs automatically, and your cluster is registered to [OpenShift Cluster Manager](#).

After you confirm that your [OpenShift Cluster Manager](#) inventory is correct, either maintained automatically by Telemetry or manually by using OpenShift Cluster Manager, [use subscription watch](#) to track your OpenShift Container Platform subscriptions at the account or multi-cluster level.

#### Additional resources

- See [About remote health monitoring](#) for more information about the Telemetry service.
- See [Accessing the web console](#) for more details about accessing and understanding the OpenShift Container Platform web console

#### 4.6.11. Next steps

- [Validating an installation.](#)
- [Customize your cluster.](#)
- If necessary, you can [opt out of remote health reporting](#) .

## 4.7. UNINSTALLING A CLUSTER ON ALIBABA CLOUD

You can remove a cluster that you deployed to Alibaba Cloud.

### 4.7.1. Removing a cluster that uses installer-provisioned infrastructure

You can remove a cluster that uses installer-provisioned infrastructure from your cloud.



#### NOTE

After uninstallation, check your cloud provider for any resources not removed properly, especially with User Provisioned Infrastructure (UPI) clusters. There might be resources that the installer did not create or that the installer is unable to access.

#### Prerequisites

- Have a copy of the installation program that you used to deploy the cluster.
- Have the files that the installation program generated when you created your cluster.

#### Procedure

1. From the directory that contains the installation program on the computer that you used to install the cluster, run the following command:

```
$ ./openshift-install destroy cluster \
--dir <installation_directory> --log-level info 1 2
```

- 1** For **<installation\_directory>**, specify the path to the directory that you stored the installation files in.

- 2** To view different details, specify **warn**, **debug**, or **error** instead of **info**.



#### NOTE

You must specify the directory that contains the cluster definition files for your cluster. The installation program requires the **metadata.json** file in this directory to delete the cluster.

1. Optional: Delete the **<installation\_directory>** directory and the OpenShift Container Platform installation program.

## CHAPTER 5. INSTALLING ON AWS

### 5.1. PREPARING TO INSTALL ON AWS

#### 5.1.1. Prerequisites

- You reviewed details about the [OpenShift Container Platform installation and update](#) processes.
- You read the documentation on [selecting a cluster installation method and preparing it for users](#).

#### 5.1.2. Requirements for installing OpenShift Container Platform on AWS

Before installing OpenShift Container Platform on Amazon Web Services (AWS), you must create an AWS account. See [Configuring an AWS account](#) for details about configuring an account, account limits, account permissions, IAM user setup, and supported AWS regions.

If the cloud identity and access management (IAM) APIs are not accessible in your environment, or if you do not want to store an administrator-level credential secret in the **kube-system** namespace, see [Manually creating IAM for AWS](#) for other options, including [configuring the Cloud Credential Operator \(CCO\) to use the Amazon Web Services Security Token Service \(AWS STS\)](#).

#### 5.1.3. Choosing a method to install OpenShift Container Platform on AWS

You can install OpenShift Container Platform on installer-provisioned or user-provisioned infrastructure. The default installation type uses installer-provisioned infrastructure, where the installation program provisions the underlying infrastructure for the cluster. You can also install OpenShift Container Platform on infrastructure that you provision. If you do not use infrastructure that the installation program provisions, you must manage and maintain the cluster resources yourself.

See [Installation process](#) for more information about installer-provisioned and user-provisioned installation processes.

##### 5.1.3.1. Installing a cluster on installer-provisioned infrastructure

You can install a cluster on AWS infrastructure that is provisioned by the OpenShift Container Platform installation program, by using one of the following methods:

- [Installing a cluster quickly on AWS](#) You can install OpenShift Container Platform on AWS infrastructure that is provisioned by the OpenShift Container Platform installation program. You can install a cluster quickly by using the default configuration options.
- [Installing a customized cluster on AWS](#) You can install a customized cluster on AWS infrastructure that the installation program provisions. The installation program allows for some customization to be applied at the installation stage. Many other customization options are available [post-installation](#).
- [Installing a cluster on AWS with network customizations](#) You can customize your OpenShift Container Platform network configuration during installation, so that your cluster can coexist with your existing IP address allocations and adhere to your network requirements.
- [Installing a cluster on AWS in a restricted network](#) You can install OpenShift Container Platform on AWS on installer-provisioned infrastructure by using an internal mirror of the

installation release content. You can use this method to install a cluster that does not require an active internet connection to obtain the software components.

- **Installing a cluster on an existing Virtual Private Cloud** You can install OpenShift Container Platform on an existing AWS Virtual Private Cloud (VPC). You can use this installation method if you have constraints set by the guidelines of your company, such as limits when creating new accounts or infrastructure.
- **Installing a private cluster on an existing VPC** You can install a private cluster on an existing AWS VPC. You can use this method to deploy OpenShift Container Platform on an internal network that is not visible to the internet.
- **Installing a cluster on AWS into a government or secret region** OpenShift Container Platform can be deployed into AWS regions that are specifically designed for US government agencies at the federal, state, and local level, as well as contractors, educational institutions, and other US customers that must run sensitive workloads in the cloud.

### 5.1.3.2. Installing a cluster on user-provisioned infrastructure

You can install a cluster on AWS infrastructure that you provision, by using one of the following methods:

- **Installing a cluster on AWS infrastructure that you provide** You can install OpenShift Container Platform on AWS infrastructure that you provide. You can use the provided CloudFormation templates to create stacks of AWS resources that represent each of the components required for an OpenShift Container Platform installation.
- **Installing a cluster on AWS in a restricted network with user-provisioned infrastructure** You can install OpenShift Container Platform on AWS infrastructure that you provide by using an internal mirror of the installation release content. You can use this method to install a cluster that does not require an active internet connection to obtain the software components. You can also use this installation method to ensure that your clusters only use container images that satisfy your organizational controls on external content. While you can install OpenShift Container Platform by using the mirrored content, your cluster still requires internet access to use the AWS APIs.

### 5.1.4. Next steps

- [Configuring an AWS account](#)

## 5.2. CONFIGURING AN AWS ACCOUNT

Before you can install OpenShift Container Platform, you must configure an Amazon Web Services (AWS) account.

### 5.2.1. Configuring Route 53

To install OpenShift Container Platform, the Amazon Web Services (AWS) account you use must have a dedicated public hosted zone in your Route 53 service. This zone must be authoritative for the domain. The Route 53 service provides cluster DNS resolution and name lookup for external connections to the cluster.

#### Procedure

1. Identify your domain, or subdomain, and registrar. You can transfer an existing domain and registrar or obtain a new one through AWS or another source.

**NOTE**

If you purchase a new domain through AWS, it takes time for the relevant DNS changes to propagate. For more information about purchasing domains through AWS, see [Registering Domain Names Using Amazon Route 53](#) in the AWS documentation.

2. If you are using an existing domain and registrar, migrate its DNS to AWS. See [Making Amazon Route 53 the DNS Service for an Existing Domain](#) in the AWS documentation.
3. Create a public hosted zone for your domain or subdomain. See [Creating a Public Hosted Zone](#) in the AWS documentation.  
Use an appropriate root domain, such as **openshiftcorp.com**, or subdomain, such as **clusters.openshiftcorp.com**.
4. Extract the new authoritative name servers from the hosted zone records. See [Getting the Name Servers for a Public Hosted Zone](#) in the AWS documentation.
5. Update the registrar records for the AWS Route 53 name servers that your domain uses. For example, if you registered your domain to a Route 53 service in a different accounts, see the following topic in the AWS documentation: [Adding or Changing Name Servers or Glue Records](#).
6. If you are using a subdomain, add its delegation records to the parent domain. This gives Amazon Route 53 responsibility for the subdomain. Follow the delegation procedure outlined by the DNS provider of the parent domain. See [Creating a subdomain that uses Amazon Route 53 as the DNS service without migrating the parent domain](#) in the AWS documentation for an example high level procedure.

### 5.2.1.1. Ingress Operator endpoint configuration for AWS Route 53

If you install in either Amazon Web Services (AWS) GovCloud (US) US-West or US-East region, the Ingress Operator uses **us-gov-west-1** region for Route53 and tagging API clients.

The Ingress Operator uses <https://tagging.us-gov-west-1.amazonaws.com> as the tagging API endpoint if a tagging custom endpoint is configured that includes the string 'us-gov-east-1'.

For more information on AWS GovCloud (US) endpoints, see the [Service Endpoints](#) in the AWS documentation about GovCloud (US).

**IMPORTANT**

Private, disconnected installations are not supported for AWS GovCloud when you install in the **us-gov-east-1** region.

### Example Route 53 configuration

```
platform:
aws:
  region: us-gov-west-1
  serviceEndpoints:
  - name: ec2
    url: https://ec2.us-gov-west-1.amazonaws.com
  - name: elasticloadbalancing
    url: https://elasticloadbalancing.us-gov-west-1.amazonaws.com
  - name: route53
```

```
url: https://route53.us-gov.amazonaws.com 1
- name: tagging
url: https://tagging.us-gov-west-1.amazonaws.com 2
```

- 1** Route 53 defaults to <https://route53.us-gov.amazonaws.com> for both AWS GovCloud (US) regions.
- 2** Only the US-West region has endpoints for tagging. Omit this parameter if your cluster is in another region.

## 5.2.2. AWS account limits

The OpenShift Container Platform cluster uses a number of Amazon Web Services (AWS) components, and the default [Service Limits](#) affect your ability to install OpenShift Container Platform clusters. If you use certain cluster configurations, deploy your cluster in certain AWS regions, or run multiple clusters from your account, you might need to request additional resources for your AWS account.

The following table summarizes the AWS components whose limits can impact your ability to install and run OpenShift Container Platform clusters.

Component	Number of clusters available by default	Default AWS limit	Description
Instance Limits	Varies	Varies	<p>By default, each cluster creates the following instances:</p> <ul style="list-style-type: none"> <li>● One bootstrap machine, which is removed after installation</li> <li>● Three control plane nodes</li> <li>● Three worker nodes</li> </ul> <p>These instance type counts are within a new account's default limit. To deploy more worker nodes, enable autoscaling, deploy large workloads, or use a different instance type, review your account limits to ensure that your cluster can deploy the machines that you need.</p> <p>In most regions, the worker machines use an <b>m6i.large</b> instance and the bootstrap and control plane machines use <b>m6i.xlarge</b> instances. In some regions, including all regions that do not support these instance types, <b>m5.large</b> and <b>m5.xlarge</b> instances are used instead.</p>



Component	Number of clusters available by default	Default AWS limit	Description
Elastic IPs (EIPs)	0 to 1	5 EIPs per account	<p>To provision the cluster in a highly available configuration, the installation program creates a public and private subnet for each <a href="#">availability zone within a region</a>. Each private subnet requires a <a href="#">NAT Gateway</a>, and each NAT gateway requires a separate <a href="#">elastic IP</a>. Review the <a href="#">AWS region map</a> to determine how many availability zones are in each region. To take advantage of the default high availability, install the cluster in a region with at least three availability zones. To install a cluster in a region with more than five availability zones, you must increase the EIP limit.</p> <div style="display: flex; align-items: flex-start; margin-top: 10px;">  <div> <p><b>IMPORTANT</b></p> <p>To use the <b>us-east-1</b> region, you must increase the EIP limit for your account.</p> </div> </div>
Virtual Private Clouds (VPCs)	5	5 VPCs per region	Each cluster creates its own VPC.
Elastic Load Balancing (ELB/NLB)	3	20 per region	By default, each cluster creates internal and external network load balancers for the master API server and a single Classic Load Balancer for the router. Deploying more Kubernetes <b>Service</b> objects with type <b>LoadBalancer</b> will create additional <a href="#">load balancers</a> .
NAT Gateways	5	5 per availability zone	The cluster deploys one NAT gateway in each availability zone.
Elastic Network Interfaces (ENIs)	At least 12	350 per region	<p>The default installation creates 21 ENIs and an ENI for each availability zone in your region. For example, the <b>us-east-1</b> region contains six availability zones, so a cluster that is deployed in that zone uses 27 ENIs. Review the <a href="#">AWS region map</a> to determine how many availability zones are in each region.</p> <p>Additional ENIs are created for additional machines and ELB load balancers that are created by cluster usage and deployed workloads.</p>

Component	Number of clusters available by default	Default AWS limit	Description
VPC Gateway	20	20 per account	Each cluster creates a single VPC Gateway for S3 access.
S3 buckets	99	100 buckets per account	Because the installation process creates a temporary bucket and the registry component in each cluster creates a bucket, you can create only 99 OpenShift Container Platform clusters per AWS account.
Security Groups	250	2,500 per account	Each cluster creates 10 distinct security groups.

### 5.2.3. Required AWS permissions for the IAM user



#### NOTE

Your IAM user must have the permission **tag:GetResources** in the region **us-east-1** to delete the base cluster resources. As part of the AWS API requirement, the OpenShift Container Platform installation program performs various actions in this region.

When you attach the **AdministratorAccess** policy to the IAM user that you create in Amazon Web Services (AWS), you grant that user all of the required permissions. To deploy all components of an OpenShift Container Platform cluster, the IAM user requires the following permissions:

#### Example 5.1. Required EC2 permissions for installation

- **ec2:AuthorizeSecurityGroupEgress**
- **ec2:AuthorizeSecurityGroupIngress**
- **ec2:CopyImage**
- **ec2:CreateNetworkInterface**
- **ec2:AttachNetworkInterface**
- **ec2:CreateSecurityGroup**
- **ec2:CreateTags**
- **ec2:CreateVolume**
- **ec2>DeleteSecurityGroup**
- **ec2>DeleteSnapshot**
- **ec2>DeleteTags**

- **ec2:DeregisterImage**
- **ec2:DescribeAccountAttributes**
- **ec2:DescribeAddresses**
- **ec2:DescribeAvailabilityZones**
- **ec2:DescribeDhcpOptions**
- **ec2:DescribeImages**
- **ec2:DescribeInstanceAttribute**
- **ec2:DescribeInstanceCreditSpecifications**
- **ec2:DescribeInstances**
- **ec2:DescribeInstanceTypes**
- **ec2:DescribeInternetGateways**
- **ec2:DescribeKeyPairs**
- **ec2:DescribeNatGateways**
- **ec2:DescribeNetworkAcls**
- **ec2:DescribeNetworkInterfaces**
- **ec2:DescribePrefixLists**
- **ec2:DescribeRegions**
- **ec2:DescribeRouteTables**
- **ec2:DescribeSecurityGroups**
- **ec2:DescribeSubnets**
- **ec2:DescribeTags**
- **ec2:DescribeVolumes**
- **ec2:DescribeVpcAttribute**
- **ec2:DescribeVpcClassicLink**
- **ec2:DescribeVpcClassicLinkDnsSupport**
- **ec2:DescribeVpcEndpoints**
- **ec2:DescribeVpcs**
- **ec2:GetEbsDefaultKmsKeyId**
- **ec2:ModifyInstanceAttribute**

- **ec2:ModifyNetworkInterfaceAttribute**
- **ec2:RevokeSecurityGroupEgress**
- **ec2:RevokeSecurityGroupIngress**
- **ec2:RunInstances**
- **ec2:TerminateInstances**

#### Example 5.2. Required permissions for creating network resources during installation

- **ec2:AllocateAddress**
- **ec2:AssociateAddress**
- **ec2:AssociateDhcpOptions**
- **ec2:AssociateRouteTable**
- **ec2:AttachInternetGateway**
- **ec2:CreateDhcpOptions**
- **ec2:CreateInternetGateway**
- **ec2:CreateNatGateway**
- **ec2:CreateRoute**
- **ec2:CreateRouteTable**
- **ec2:CreateSubnet**
- **ec2:CreateVpc**
- **ec2:CreateVpcEndpoint**
- **ec2:ModifySubnetAttribute**
- **ec2:ModifyVpcAttribute**



#### NOTE

If you use an existing VPC, your account does not require these permissions for creating network resources.

#### Example 5.3. Required Elastic Load Balancing permissions (ELB) for installation

- **elasticloadbalancing:AddTags**
- **elasticloadbalancing:ApplySecurityGroupsToLoadBalancer**
- **elasticloadbalancing:AttachLoadBalancerToSubnets**

- **elasticloadbalancing:ConfigureHealthCheck**
- **elasticloadbalancing>CreateLoadBalancer**
- **elasticloadbalancing>CreateLoadBalancerListeners**
- **elasticloadbalancing>DeleteLoadBalancer**
- **elasticloadbalancing:DeregisterInstancesFromLoadBalancer**
- **elasticloadbalancing:DescribeInstanceHealth**
- **elasticloadbalancing:DescribeLoadBalancerAttributes**
- **elasticloadbalancing:DescribeLoadBalancers**
- **elasticloadbalancing:DescribeTags**
- **elasticloadbalancing:ModifyLoadBalancerAttributes**
- **elasticloadbalancing:RegisterInstancesWithLoadBalancer**
- **elasticloadbalancing:SetLoadBalancerPoliciesOfListener**

Example 5.4. Required Elastic Load Balancing permissions (ELBv2) for installation

- **elasticloadbalancing:AddTags**
- **elasticloadbalancing>CreateListener**
- **elasticloadbalancing>CreateLoadBalancer**
- **elasticloadbalancing>CreateTargetGroup**
- **elasticloadbalancing>DeleteLoadBalancer**
- **elasticloadbalancing:DeregisterTargets**
- **elasticloadbalancing:DescribeListeners**
- **elasticloadbalancing:DescribeLoadBalancerAttributes**
- **elasticloadbalancing:DescribeLoadBalancers**
- **elasticloadbalancing:DescribeTargetGroupAttributes**
- **elasticloadbalancing:DescribeTargetHealth**
- **elasticloadbalancing:ModifyLoadBalancerAttributes**
- **elasticloadbalancing:ModifyTargetGroup**
- **elasticloadbalancing:ModifyTargetGroupAttributes**
- **elasticloadbalancing:RegisterTargets**

### Example 5.5. Required IAM permissions for installation

- **iam:AddRoleToInstanceProfile**
- **iam:CreateInstanceProfile**
- **iam:CreateRole**
- **iam:DeleteInstanceProfile**
- **iam>DeleteRole**
- **iam>DeleteRolePolicy**
- **iam:GetInstanceProfile**
- **iam:GetRole**
- **iam:GetRolePolicy**
- **iam:GetUser**
- **iam:ListInstanceProfilesForRole**
- **iam:ListRoles**
- **iam:ListUsers**
- **iam:PassRole**
- **iam:PutRolePolicy**
- **iam:RemoveRoleFromInstanceProfile**
- **iam:SimulatePrincipalPolicy**
- **iam:TagRole**

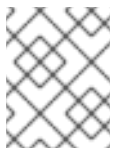

#### NOTE

If you have not created an elastic load balancer (ELB) in your AWS account, the IAM user also requires the **iam:CreateServiceLinkedRole** permission.

### Example 5.6. Required Route 53 permissions for installation

- **route53:ChangeResourceRecordSets**
- **route53:ChangeTagsForResource**
- **route53:CreateHostedZone**
- **route53>DeleteHostedZone**
- **route53:GetChange**

- **route53:GetHostedZone**
- **route53:ListHostedZones**
- **route53:ListHostedZonesByName**
- **route53:ListResourceRecordSets**
- **route53:ListTagsForResource**
- **route53:UpdateHostedZoneComment**

Example 5.7. Required S3 permissions for installation

- **s3:CreateBucket**
- **s3>DeleteBucket**
- **s3:GetAccelerateConfiguration**
- **s3:GetBucketAcl**
- **s3:GetBucketCors**
- **s3:GetBucketLocation**
- **s3:GetBucketLogging**
- **s3:GetBucketObjectLockConfiguration**
- **s3:GetBucketReplication**
- **s3:GetBucketRequestPayment**
- **s3:GetBucketTagging**
- **s3:GetBucketVersioning**
- **s3:GetBucketWebsite**
- **s3:GetEncryptionConfiguration**
- **s3:GetLifecycleConfiguration**
- **s3:GetReplicationConfiguration**
- **s3:ListBucket**
- **s3:PutBucketAcl**
- **s3:PutBucketTagging**
- **s3:PutEncryptionConfiguration**

Example 5.8. S3 permissions that cluster Operators require

- **s3:DeleteObject**
- **s3:GetObject**
- **s3:GetObjectAcl**
- **s3:GetObjectTagging**
- **s3:GetObjectVersion**
- **s3:PutObject**
- **s3:PutObjectAcl**
- **s3:PutObjectTagging**

Example 5.9. Required permissions to delete base cluster resources

- **autoscaling:DescribeAutoScalingGroups**
- **ec2:DeleteNetworkInterface**
- **ec2:DeleteVolume**
- **elasticloadbalancing:DeleteTargetGroup**
- **elasticloadbalancing:DescribeTargetGroups**
- **iam:DeleteAccessKey**
- **iam:DeleteUser**
- **iam>ListAttachedRolePolicies**
- **iam>ListInstanceProfiles**
- **iam>ListRolePolicies**
- **iam>ListUserPolicies**
- **s3:DeleteObject**
- **s3>ListBucketVersions**
- **tag:GetResources**

Example 5.10. Required permissions to delete network resources

- **ec2:DeleteDhcpOptions**
- **ec2:DeleteInternetGateway**
- **ec2:DeleteNatGateway**
- **ec2:DeleteRoute**



- **ec2:DeleteRouteTable**
- **ec2:DeleteSubnet**
- **ec2:DeleteVpc**
- **ec2:DeleteVpcEndpoints**
- **ec2:DetachInternetGateway**
- **ec2:DisassociateRouteTable**
- **ec2:ReleaseAddress**
- **ec2:ReplaceRouteTableAssociation**

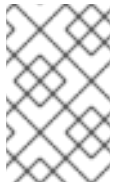

#### NOTE

If you use an existing VPC, your account does not require these permissions to delete network resources. Instead, your account only requires the **tag:UntagResources** permission to delete network resources.

#### Example 5.11. Required permissions to delete a cluster with shared instance roles

- **iam:UntagRole**

#### Example 5.12. Additional IAM and S3 permissions that are required to create manifests

- **iam:DeleteAccessKey**
- **iam:DeleteUser**
- **iam:DeleteUserPolicy**
- **iam:GetUserPolicy**
- **iam:ListAccessKeys**
- **iam:PutUserPolicy**
- **iam:TagUser**
- **s3:PutBucketPublicAccessBlock**
- **s3:GetBucketPublicAccessBlock**
- **s3:PutLifecycleConfiguration**
- **s3:HeadBucket**
- **s3:ListBucketMultipartUploads**
- **s3:AbortMultipartUpload**

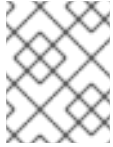
**NOTE**

If you are managing your cloud provider credentials with mint mode, the IAM user also requires the **iam:CreateAccessKey** and **iam:CreateUser** permissions.

**Example 5.13. Optional permissions for instance and quota checks for installation**

- **ec2:DescribeInstanceTypeOfferings**
- **servicequotas:ListAWSDefaultServiceQuotas**

**5.2.4. Creating an IAM user**

Each Amazon Web Services (AWS) account contains a root user account that is based on the email address you used to create the account. This is a highly-privileged account, and it is recommended to use it for only initial account and billing configuration, creating an initial set of users, and securing the account.

Before you install OpenShift Container Platform, create a secondary IAM administrative user. As you complete the [Creating an IAM User in Your AWS Account](#) procedure in the AWS documentation, set the following options:

**Procedure**

1. Specify the IAM user name and select **Programmatic access**.
2. Attach the **AdministratorAccess** policy to ensure that the account has sufficient permission to create the cluster. This policy provides the cluster with the ability to grant credentials to each OpenShift Container Platform component. The cluster grants the components only the credentials that they require.

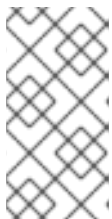
**NOTE**

While it is possible to create a policy that grants the all of the required AWS permissions and attach it to the user, this is not the preferred option. The cluster will not have the ability to grant additional credentials to individual components, so the same credentials are used by all components.

3. Optional: Add metadata to the user by attaching tags.
4. Confirm that the user name that you specified is granted the **AdministratorAccess** policy.
5. Record the access key ID and secret access key values. You must use these values when you configure your local machine to run the installation program.

**IMPORTANT**

You cannot use a temporary session token that you generated while using a multi-factor authentication device to authenticate to AWS when you deploy a cluster. The cluster continues to use your current AWS credentials to create AWS resources for the entire life of the cluster, so you must use key-based, long-lived credentials.

## Additional resources

- See [Manually creating IAM for AWS](#) for steps to set the Cloud Credential Operator (CCO) to manual mode prior to installation. Use this mode in environments where the cloud identity and access management (IAM) APIs are not reachable, or if you prefer not to store an administrator-level credential secret in the cluster **kube-system** project.

### 5.2.5. IAM Policies and AWS authentication

By default, the installation program creates instance profiles for the bootstrap, control plane, and compute instances with the necessary permissions for the cluster to operate.

However, you can create your own IAM roles and specify them as part of the installation process. You might need to specify your own roles to deploy the cluster or to manage the cluster after installation. For example:

- Your organization's security policies require that you use a more restrictive set of permissions to install the cluster.
- After the installation, the cluster is configured with an Operator that requires access to additional services.

If you choose to specify your own IAM roles, you can take the following steps:

- Begin with the default policies and adapt as required. For more information, see "Default permissions for IAM instance profiles".
- Use the AWS Identity and Access Management Access Analyzer (IAM Access Analyzer) to create a policy template that is based on the cluster's activity. For more information see, "Using AWS IAM Analyzer to create policy templates".

#### 5.2.5.1. Default permissions for IAM instance profiles

By default, the installation program creates IAM instance profiles for the bootstrap, control plane and worker instances with the necessary permissions for the cluster to operate.

The following lists specify the default permissions for control plane and compute machines:

##### Example 5.14. Default IAM role permissions for control plane instance profiles

- **ec2:AttachVolume**
- **ec2:AuthorizeSecurityGroupIngress**
- **ec2:CreateSecurityGroup**
- **ec2:CreateTags**
- **ec2:CreateVolume**
- **ec2>DeleteSecurityGroup**
- **ec2>DeleteVolume**
- **ec2:Describe\***
- **ec2:DetachVolume**

- **ec2:ModifyInstanceAttribute**
- **ec2:ModifyVolume**
- **ec2:RevokeSecurityGroupIngress**
- **elasticloadbalancing:AddTags**
- **elasticloadbalancing:AttachLoadBalancerToSubnets**
- **elasticloadbalancing:ApplySecurityGroupsToLoadBalancer**
- **elasticloadbalancing:CreateListener**
- **elasticloadbalancing:CreateLoadBalancer**
- **elasticloadbalancing:CreateLoadBalancerPolicy**
- **elasticloadbalancing:CreateLoadBalancerListeners**
- **elasticloadbalancing:CreateTargetGroup**
- **elasticloadbalancing:ConfigureHealthCheck**
- **elasticloadbalancing>DeleteListener**
- **elasticloadbalancing>DeleteLoadBalancer**
- **elasticloadbalancing>DeleteLoadBalancerListeners**
- **elasticloadbalancing>DeleteTargetGroup**
- **elasticloadbalancing:DeregisterInstancesFromLoadBalancer**
- **elasticloadbalancing:DeregisterTargets**
- **elasticloadbalancing:Describe\***
- **elasticloadbalancing:DetachLoadBalancerFromSubnets**
- **elasticloadbalancing:ModifyListener**
- **elasticloadbalancing:ModifyLoadBalancerAttributes**
- **elasticloadbalancing:ModifyTargetGroup**
- **elasticloadbalancing:ModifyTargetGroupAttributes**
- **elasticloadbalancing:RegisterInstancesWithLoadBalancer**
- **elasticloadbalancing:RegisterTargets**
- **elasticloadbalancing:SetLoadBalancerPoliciesForBackendServer**
- **elasticloadbalancing:SetLoadBalancerPoliciesOfListener**
- **kms:DescribeKey**

**Example 5.15. Default IAM role permissions for compute instance profiles**

- **ec2:DescribeInstances**
- **ec2:DescribeRegions**

**5.2.5.2. Specifying an existing IAM role**

Instead of allowing the installation program to create IAM instance profiles with the default permissions, you can use the **install-config.yaml** file to specify an existing IAM role for control plane and compute instances.

**Prerequisites**

- You have an existing **install-config.yaml** file.

**Procedure**

1. Update **compute.platform.aws.iamRole** with an existing role for the control plane machines.

**Sample install-config.yaml file with an IAM role for compute instances**

```
compute:
  - hyperthreading: Enabled
    name: worker
  platform:
    aws:
      iamRole: ExampleRole
```

2. Update **controlPlane.platform.aws.iamRole** with an existing role for the compute machines.

**Sample install-config.yaml file with an IAM role for control plane instances**

```
controlPlane:
  hyperthreading: Enabled
  name: master
  platform:
    aws:
      iamRole: ExampleRole
```

3. Save the file and reference it when installing the OpenShift Container Platform cluster.

**Additional resources**

- See [Deploying the cluster](#).

**5.2.5.3. Using AWS IAM Analyzer to create policy templates**

The minimal set of permissions that the control plane and compute instance profiles require depends on how the cluster is configured for its daily operation.

One way to determine which permissions the cluster instances require is to use the AWS Identity and Access Management Access Analyzer (IAM Access Analyzer) to create a policy template:

- A policy template contains the permissions the cluster has used over a specified period of time.
- You can then use the template to create policies with fine-grained permissions.

## Procedure

The overall process could be:

1. Ensure that CloudTrail is enabled. CloudTrail records all of the actions and events in your AWS account, including the API calls that are required to create a policy template. For more information, see the AWS documentation for [working with CloudTrail](#).
2. Create an instance profile for control plane instances and an instance profile for compute instances. Be sure to assign each role a permissive policy, such as PowerUserAccess. For more information, see the AWS documentation for [creating instance profile roles](#).
3. Install the cluster in a development environment and configure it as required. Be sure to deploy all of applications the cluster will host in a production environment.
4. Test the cluster thoroughly. Testing the cluster ensures that all of the required API calls are logged.
5. Use the IAM Access Analyzer to create a policy template for each instance profile. For more information, see the AWS documentation for [generating policies based on the CloudTrail logs](#).
6. Create and add a fine-grained policy to each instance profile.
7. Remove the permissive policy from each instance profile.
8. Deploy a production cluster using the existing instance profiles with the new policies.



### NOTE

You can add [IAM Conditions](#) to your policy to make it more restrictive and compliant with your organization security requirements.

## 5.2.6. Supported AWS Marketplace regions

Installing an OpenShift Container Platform cluster using an AWS Marketplace image is available to customers who purchase the offer in North America.

While the offer must be purchased in North America, you can deploy the cluster to any of the following supported partitions:

- Public
- GovCloud



### NOTE

Deploying a OpenShift Container Platform cluster using an AWS Marketplace image is not supported for the AWS secret regions or China regions.

## 5.2.7. Supported AWS regions

You can deploy an OpenShift Container Platform cluster to the following regions.



### NOTE

Your IAM user must have the permission **tag:GetResources** in the region **us-east-1** to delete the base cluster resources. As part of the AWS API requirement, the OpenShift Container Platform installation program performs various actions in this region.

### 5.2.7.1. AWS public regions

The following AWS public regions are supported:

- **af-south-1** (Cape Town)
- **ap-east-1** (Hong Kong)
- **ap-northeast-1** (Tokyo)
- **ap-northeast-2** (Seoul)
- **ap-northeast-3** (Osaka)
- **ap-south-1** (Mumbai)
- **ap-southeast-1** (Singapore)
- **ap-southeast-2** (Sydney)
- **ca-central-1** (Central)
- **eu-central-1** (Frankfurt)
- **eu-north-1** (Stockholm)
- **eu-south-1** (Milan)
- **eu-west-1** (Ireland)
- **eu-west-2** (London)
- **eu-west-3** (Paris)
- **me-south-1** (Bahrain)
- **sa-east-1** (São Paulo)
- **us-east-1** (N. Virginia)
- **us-east-2** (Ohio)
- **us-west-1** (N. California)
- **us-west-2** (Oregon)

### 5.2.7.2. AWS GovCloud regions

The following AWS GovCloud regions are supported:

- **us-gov-west-1**
- **us-gov-east-1**

### 5.2.7.3. AWS C2S Secret region

The **us-iso-east-1** region is supported.

### 5.2.7.4. AWS China regions

The following AWS China regions are supported:

- **cn-north-1** (Beijing)
- **cn-northwest-1** (Ningxia)

## 5.2.8. Next steps

- Install an OpenShift Container Platform cluster:
  - [Quickly install a cluster](#) with default options on installer-provisioned infrastructure
  - [Install a cluster with cloud customizations on installer-provisioned infrastructure](#)
  - [Install a cluster with network customizations on installer-provisioned infrastructure](#)
  - [Installing a cluster on user-provisioned infrastructure in AWS by using CloudFormation templates](#)

## 5.3. MANUALLY CREATING IAM FOR AWS

In environments where the cloud identity and access management (IAM) APIs are not reachable, or the administrator prefers not to store an administrator-level credential secret in the cluster **kube-system** namespace, you can put the Cloud Credential Operator (CCO) into manual mode before you install the cluster.

### 5.3.1. Alternatives to storing administrator-level secrets in the kube-system project

The Cloud Credential Operator (CCO) manages cloud provider credentials as Kubernetes custom resource definitions (CRDs). You can configure the CCO to suit the security requirements of your organization by setting different values for the **credentialsMode** parameter in the **install-config.yaml** file.

If you prefer not to store an administrator-level credential secret in the cluster **kube-system** project, you can choose one of the following options when installing OpenShift Container Platform:

- **Use the Amazon Web Services Security Token Service**  
You can use the CCO utility (**ccoctl**) to configure the cluster to use the Amazon Web Services Security Token Service (AWS STS). When the CCO utility is used to configure the cluster for STS, it assigns IAM roles that provide short-term, limited-privilege security credentials to components.

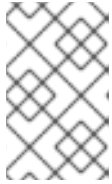

**NOTE**

This credentials strategy is supported for only new OpenShift Container Platform clusters and must be configured during installation. You cannot reconfigure an existing cluster that uses a different credentials strategy to use this feature.

- **Manage cloud credentials manually.**

You can set the **credentialsMode** parameter for the CCO to **Manual** to manage cloud credentials manually. Using manual mode allows each cluster component to have only the permissions it requires, without storing an administrator-level credential in the cluster. You can also use this mode if your environment does not have connectivity to the cloud provider public IAM endpoint. However, you must manually reconcile permissions with new release images for every upgrade. You must also manually supply credentials for every component that requests them.

- **Remove the administrator-level credential secret after installing OpenShift Container Platform with mint mode:**

If you are using the CCO with the **credentialsMode** parameter set to **Mint**, you can remove or rotate the administrator-level credential after installing OpenShift Container Platform. Mint mode is the default configuration for the CCO. This option requires the presence of the administrator-level credential during an installation. The administrator-level credential is used during the installation to mint other credentials with some permissions granted. The original credential secret is not stored in the cluster permanently.

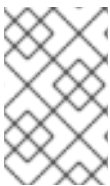
**NOTE**

Prior to a non z-stream upgrade, you must reinstate the credential secret with the administrator-level credential. If the credential is not present, the upgrade might be blocked.

**Additional resources**

- To learn how to use the CCO utility (**ccoctl**) to configure the CCO to use the AWS STS, see [Using manual mode with STS](#).
- To learn how to rotate or remove the administrator-level credential secret after installing OpenShift Container Platform, see [Rotating or removing cloud provider credentials](#).
- For a detailed description of all available CCO credential modes and their supported platforms, see [About the Cloud Credential Operator](#).

**5.3.2. Manually create IAM**

The Cloud Credential Operator (CCO) can be put into manual mode prior to installation in environments where the cloud identity and access management (IAM) APIs are not reachable, or the administrator prefers not to store an administrator-level credential secret in the cluster **kube-system** namespace.

**Procedure**

1. Change to the directory that contains the installation program and create the **install-config.yaml** file by running the following command:

```
$ openshift-install create install-config --dir <installation_directory>
```

where **<installation\_directory>** is the directory in which the installation program creates files.

2. Edit the **install-config.yaml** configuration file so that it contains the **credentialsMode** parameter set to **Manual**.

### Example install-config.yaml configuration file

```
apiVersion: v1
baseDomain: cluster1.example.com
credentialsMode: Manual 1
compute:
- architecture: amd64
  hyperthreading: Enabled
...
```

- 1** This line is added to set the **credentialsMode** parameter to **Manual**.

3. Generate the manifests by running the following command from the directory that contains the installation program:

```
$ openshift-install create manifests --dir <installation_directory>
```

where **<installation\_directory>** is the directory in which the installation program creates files.

4. From the directory that contains the installation program, obtain details of the OpenShift Container Platform release image that your **openshift-install** binary is built to use by running the following command:

```
$ openshift-install version
```

### Example output

```
release image quay.io/openshift-release-dev/ocp-release:4.y.z-x86_64
```

5. Locate all **CredentialsRequest** objects in this release image that target the cloud you are deploying on by running the following command:

```
$ oc adm release extract quay.io/openshift-release-dev/ocp-release:4.y.z-x86_64 \
  --credentials-requests \
  --cloud=aws
```

This command creates a YAML file for each **CredentialsRequest** object.

### Sample CredentialsRequest object

```
apiVersion: cloudcredential.openshift.io/v1
kind: CredentialsRequest
metadata:
  name: <component-credentials-request>
  namespace: openshift-cloud-credential-operator
...
spec:
  providerSpec:
```

```

apiVersion: cloudcredential.openshift.io/v1
kind: AWSProviderSpec
statementEntries:
- effect: Allow
  action:
  - iam:GetUser
  - iam:GetUserPolicy
  - iam:ListAccessKeys
  resource: "*"
...

```

6. Create YAML files for secrets in the **openshift-install** manifests directory that you generated previously. The secrets must be stored using the namespace and secret name defined in the **spec.secretRef** for each **CredentialsRequest** object.

### Sample CredentialsRequest object with secrets

```

apiVersion: cloudcredential.openshift.io/v1
kind: CredentialsRequest
metadata:
  name: <component-credentials-request>
  namespace: openshift-cloud-credential-operator
...
spec:
  providerSpec:
    apiVersion: cloudcredential.openshift.io/v1
    kind: AWSProviderSpec
    statementEntries:
    - effect: Allow
      action:
      - s3:CreateBucket
      - s3>DeleteBucket
      resource: "*"
    ...
  secretRef:
    name: <component-secret>
    namespace: <component-namespace>
...

```

### Sample Secret object

```

apiVersion: v1
kind: Secret
metadata:
  name: <component-secret>
  namespace: <component-namespace>
data:
  aws_access_key_id: <base64_encoded_aws_access_key_id>
  aws_secret_access_key: <base64_encoded_aws_secret_access_key>

```

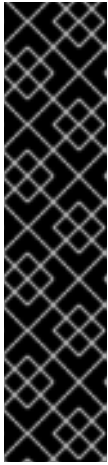

## IMPORTANT

The release image includes **CredentialsRequest** objects for Technology Preview features that are enabled by the **TechPreviewNoUpgrade** feature set. You can identify these objects by their use of the **release.openshift.io/feature-gate: TechPreviewNoUpgrade** annotation.

- If you are not using any of these features, do not create secrets for these objects. Creating secrets for Technology Preview features that you are not using can cause the installation to fail.
- If you are using any of these features, you must create secrets for the corresponding objects.

- To find **CredentialsRequest** objects with the **TechPreviewNoUpgrade** annotation, run the following command:

```
$ grep "release.openshift.io/feature-gate" *
```

### Example output

```
0000_30_capi-operator_00_credentials-request.yaml: release.openshift.io/feature-gate:
TechPreviewNoUpgrade
```

7. From the directory that contains the installation program, proceed with your cluster creation:

```
$ openshift-install create cluster --dir <installation_directory>
```



## IMPORTANT

Before upgrading a cluster that uses manually maintained credentials, you must ensure that the CCO is in an upgradeable state.

### Additional resources

- [Updating a cluster using the web console](#)
- [Updating a cluster using the CLI](#)

### 5.3.3. Mint mode

Mint mode is the default Cloud Credential Operator (CCO) credentials mode for OpenShift Container Platform on platforms that support it. In this mode, the CCO uses the provided administrator-level cloud credential to run the cluster. Mint mode is supported for AWS and GCP.

In mint mode, the **admin** credential is stored in the **kube-system** namespace and then used by the CCO to process the **CredentialsRequest** objects in the cluster and create users for each with specific permissions.

The benefits of mint mode include:

- Each cluster component has only the permissions it requires

- Automatic, on-going reconciliation for cloud credentials, including additional credentials or permissions that might be required for upgrades

One drawback is that mint mode requires **admin** credential storage in a cluster **kube-system** secret.

### 5.3.4. Mint mode with removal or rotation of the administrator-level credential

Currently, this mode is only supported on AWS and GCP.

In this mode, a user installs OpenShift Container Platform with an administrator-level credential just like the normal mint mode. However, this process removes the administrator-level credential secret from the cluster post-installation.

The administrator can have the Cloud Credential Operator make its own request for a read-only credential that allows it to verify if all **CredentialsRequest** objects have their required permissions, thus the administrator-level credential is not required unless something needs to be changed. After the associated credential is removed, it can be deleted or deactivated on the underlying cloud, if desired.



#### NOTE

Prior to a non z-stream upgrade, you must reinstate the credential secret with the administrator-level credential. If the credential is not present, the upgrade might be blocked.

The administrator-level credential is not stored in the cluster permanently.

Following these steps still requires the administrator-level credential in the cluster for brief periods of time. It also requires manually re-instating the secret with administrator-level credentials for each upgrade.

### 5.3.5. Next steps

- Install an OpenShift Container Platform cluster:
  - [Installing a cluster quickly on AWS](#) with default options on installer-provisioned infrastructure
  - [Install a cluster with cloud customizations on installer-provisioned infrastructure](#)
  - [Install a cluster with network customizations on installer-provisioned infrastructure](#)
  - [Installing a cluster on user-provisioned infrastructure in AWS by using CloudFormation templates](#)

## 5.4. INSTALLING A CLUSTER QUICKLY ON AWS

In OpenShift Container Platform version 4.10, you can install a cluster on Amazon Web Services (AWS) that uses the default configuration options.

### 5.4.1. Prerequisites

- You reviewed details about the [OpenShift Container Platform installation and update](#) processes.

- You read the documentation on [selecting a cluster installation method and preparing it for users](#).
- You [configured an AWS account](#) to host the cluster.

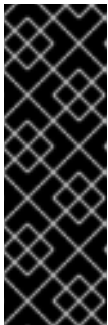

### IMPORTANT

If you have an AWS profile stored on your computer, it must not use a temporary session token that you generated while using a multi-factor authentication device. The cluster continues to use your current AWS credentials to create AWS resources for the entire life of the cluster, so you must use key-based, long-lived credentials. To generate appropriate keys, see [Managing Access Keys for IAM Users](#) in the AWS documentation. You can supply the keys when you run the installation program.

- If you use a firewall, you [configured it to allow the sites](#) that your cluster requires access to.
- If the cloud identity and access management (IAM) APIs are not accessible in your environment, or if you do not want to store an administrator-level credential secret in the **kube-system** namespace, you can [manually create and maintain IAM credentials](#). Manual mode can also be used in environments where the cloud IAM APIs are not reachable.

## 5.4.2. Internet access for OpenShift Container Platform

In OpenShift Container Platform 4.10, you require access to the internet to install your cluster.

You must have internet access to:

- Access [OpenShift Cluster Manager](#) to download the installation program and perform subscription management. If the cluster has internet access and you do not disable Telemetry, that service automatically entitles your cluster.
- Access [Quay.io](#) to obtain the packages that are required to install your cluster.
- Obtain the packages that are required to perform cluster updates.

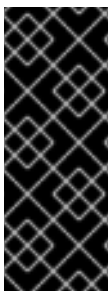

### IMPORTANT

If your cluster cannot have direct internet access, you can perform a restricted network installation on some types of infrastructure that you provision. During that process, you download the required content and use it to populate a mirror registry with the installation packages. With some installation types, the environment that you install your cluster in will not require internet access. Before you update the cluster, you update the content of the mirror registry.

## 5.4.3. Generating a key pair for cluster node SSH access

During an OpenShift Container Platform installation, you can provide an SSH public key to the installation program. The key is passed to the Red Hat Enterprise Linux CoreOS (RHCOS) nodes through their Ignition config files and is used to authenticate SSH access to the nodes. The key is added to the `~/.ssh/authorized_keys` list for the **core** user on each node, which enables password-less authentication.

After the key is passed to the nodes, you can use the key pair to SSH in to the RHCOS nodes as the user **core**. To access the nodes through SSH, the private key identity must be managed by SSH for your local user.

If you want to SSH in to your cluster nodes to perform installation debugging or disaster recovery, you must provide the SSH public key during the installation process. The **./openshift-install gather** command also requires the SSH public key to be in place on the cluster nodes.

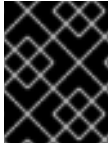

### IMPORTANT

Do not skip this procedure in production environments, where disaster recovery and debugging is required.



### NOTE

You must use a local key, not one that you configured with platform-specific approaches such as [AWS key pairs](#).

## Procedure

1. If you do not have an existing SSH key pair on your local machine to use for authentication onto your cluster nodes, create one. For example, on a computer that uses a Linux operating system, run the following command:

```
$ ssh-keygen -t ed25519 -N "" -f <path>/<file_name> 1
```

- 1 Specify the path and file name, such as `~/.ssh/id_ed25519`, of the new SSH key. If you have an existing key pair, ensure your public key is in the your `~/.ssh` directory.



### NOTE

If you plan to install an OpenShift Container Platform cluster that uses FIPS validated or Modules In Process cryptographic libraries on the **x86\_64** architecture, do not create a key that uses the **ed25519** algorithm. Instead, create a key that uses the **rsa** or **ecdsa** algorithm.

2. View the public SSH key:

```
$ cat <path>/<file_name>.pub
```

For example, run the following to view the `~/.ssh/id_ed25519.pub` public key:

```
$ cat ~/.ssh/id_ed25519.pub
```

3. Add the SSH private key identity to the SSH agent for your local user, if it has not already been added. SSH agent management of the key is required for password-less SSH authentication onto your cluster nodes, or if you want to use the **./openshift-install gather** command.

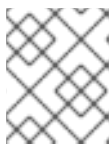

### NOTE

On some distributions, default SSH private key identities such as `~/.ssh/id_rsa` and `~/.ssh/id_dsa` are managed automatically.

- a. If the **ssh-agent** process is not already running for your local user, start it as a background task:

```
$ eval "$(ssh-agent -s)"
```

#### Example output

```
Agent pid 31874
```



#### NOTE

If your cluster is in FIPS mode, only use FIPS-compliant algorithms to generate the SSH key. The key must be either RSA or ECDSA.

4. Add your SSH private key to the **ssh-agent**:

```
$ ssh-add <path>/<file_name> 1
```

- 1** Specify the path and file name for your SSH private key, such as `~/.ssh/id_ed25519`

#### Example output

```
Identity added: /home/<you>/<path>/<file_name> (<computer_name>)
```

#### Next steps

- When you install OpenShift Container Platform, provide the SSH public key to the installation program.

### 5.4.4. Obtaining the installation program

Before you install OpenShift Container Platform, download the installation file on a local computer.

#### Prerequisites

- You have a computer that runs Linux or macOS, with 500 MB of local disk space

#### Procedure

1. Access the [Infrastructure Provider](#) page on the OpenShift Cluster Manager site. If you have a Red Hat account, log in with your credentials. If you do not, create an account.
2. Select your infrastructure provider.
3. Navigate to the page for your installation type, download the installation program that corresponds with your host operating system and architecture, and place the file in the directory where you will store the installation configuration files.



**IMPORTANT**

The installation program creates several files on the computer that you use to install your cluster. You must keep the installation program and the files that the installation program creates after you finish installing the cluster. Both files are required to delete the cluster.

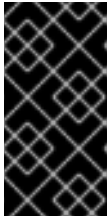
**IMPORTANT**

Deleting the files created by the installation program does not remove your cluster, even if the cluster failed during installation. To remove your cluster, complete the OpenShift Container Platform uninstallation procedures for your specific cloud provider.

4. Extract the installation program. For example, on a computer that uses a Linux operating system, run the following command:

```
$ tar -xvf openshift-install-linux.tar.gz
```

5. Download your installation [pull secret from the Red Hat OpenShift Cluster Manager](#). This pull secret allows you to authenticate with the services that are provided by the included authorities, including Quay.io, which serves the container images for OpenShift Container Platform components.

### 5.4.5. Deploying the cluster

You can install OpenShift Container Platform on a compatible cloud platform.

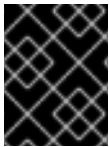
**IMPORTANT**

You can run the **create cluster** command of the installation program only once, during initial installation.

#### Prerequisites

- Configure an account with the cloud platform that hosts your cluster.
- Obtain the OpenShift Container Platform installation program and the pull secret for your cluster.

#### Procedure

1. Change to the directory that contains the installation program and initialize the cluster deployment:

```
$ ./openshift-install create cluster --dir <installation_directory> \ 1  
--log-level=info 2
```

- 1** For **<installation\_directory>**, specify the directory name to store the files that the installation program creates.

- 2** To view different installation details, specify **warn**, **debug**, or **error** instead of **info**.

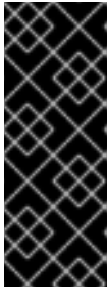
**IMPORTANT**

Specify an empty directory. Some installation assets, like bootstrap X.509 certificates have short expiration intervals, so you must not reuse an installation directory. If you want to reuse individual files from another cluster installation, you can copy them into your directory. However, the file names for the installation assets might change between releases. Use caution when copying installation files from an earlier OpenShift Container Platform version.

Provide values at the prompts:

- a. Optional: Select an SSH key to use to access your cluster machines.

**NOTE**

For production OpenShift Container Platform clusters on which you want to perform installation debugging or disaster recovery, specify an SSH key that your **ssh-agent** process uses.

- b. Select **aws** as the platform to target.
- c. If you do not have an Amazon Web Services (AWS) profile stored on your computer, enter the AWS access key ID and secret access key for the user that you configured to run the installation program.

**NOTE**

The AWS access key ID and secret access key are stored in `~/.aws/credentials` in the home directory of the current user on the installation host. You are prompted for the credentials by the installation program if the credentials for the exported profile are not present in the file. Any credentials that you provide to the installation program are stored in the file.

- d. Select the AWS region to deploy the cluster to.
- e. Select the base domain for the Route 53 service that you configured for your cluster.
- f. Enter a descriptive name for your cluster.
- g. Paste the [pull secret from the Red Hat OpenShift Cluster Manager](#) .

**NOTE**

If the cloud provider account that you configured on your host does not have sufficient permissions to deploy the cluster, the installation process stops, and the missing permissions are displayed.

When the cluster deployment completes, directions for accessing your cluster, including a link to its web console and credentials for the **kubeadmin** user, display in your terminal.

**Example output**

...

```

INFO Install complete!
INFO To access the cluster as the system:admin user when using 'oc', run 'export
KUBECONFIG=/home/myuser/install_dir/auth/kubeconfig'
INFO Access the OpenShift web-console here: https://console-openshift-
console.apps.mycluster.example.com
INFO Login to the console with user: "kubeadmin", and password: "4vYBz-Ee6gm-ymBZj-
Wt5AL"
INFO Time elapsed: 36m22s

```

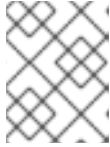

#### NOTE

The cluster access and credential information also outputs to `<installation_directory>/openshift_install.log` when an installation succeeds.



#### IMPORTANT

- The Ignition config files that the installation program generates contain certificates that expire after 24 hours, which are then renewed at that time. If the cluster is shut down before renewing the certificates and the cluster is later restarted after the 24 hours have elapsed, the cluster automatically recovers the expired certificates. The exception is that you must manually approve the pending **node-bootstrapper** certificate signing requests (CSRs) to recover kubelet certificates. See the documentation for *Recovering from expired control plane certificates* for more information.
- It is recommended that you use Ignition config files within 12 hours after they are generated because the 24-hour certificate rotates from 16 to 22 hours after the cluster is installed. By using the Ignition config files within 12 hours, you can avoid installation failure if the certificate update runs during installation.

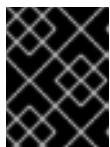

#### IMPORTANT

You must not delete the installation program or the files that the installation program creates. Both are required to delete the cluster.

2. Optional: Remove or disable the **AdministratorAccess** policy from the IAM account that you used to install the cluster.



#### NOTE

The elevated permissions provided by the **AdministratorAccess** policy are required only during installation.

#### Additional resources

- See [Configuration and credential file settings](#) in the AWS documentation for more information about AWS profile and credential configuration.

### 5.4.6. Installing the OpenShift CLI by downloading the binary

You can install the OpenShift CLI (**oc**) to interact with OpenShift Container Platform from a command-line interface. You can install **oc** on Linux, Windows, or macOS.

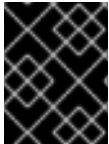

## IMPORTANT

If you installed an earlier version of **oc**, you cannot use it to complete all of the commands in OpenShift Container Platform 4.10. Download and install the new version of **oc**.

### Installing the OpenShift CLI on Linux

You can install the OpenShift CLI (**oc**) binary on Linux by using the following procedure.

#### Procedure

1. Navigate to the [OpenShift Container Platform downloads page](#) on the Red Hat Customer Portal.
2. Select the appropriate version in the **Version** drop-down menu.
3. Click **Download Now** next to the **OpenShift v4.10 Linux Client** entry and save the file.
4. Unpack the archive:

```
$ tar xvf <file>
```

5. Place the **oc** binary in a directory that is on your **PATH**.  
To check your **PATH**, execute the following command:

```
$ echo $PATH
```

After you install the OpenShift CLI, it is available using the **oc** command:

```
$ oc <command>
```

### Installing the OpenShift CLI on Windows

You can install the OpenShift CLI (**oc**) binary on Windows by using the following procedure.

#### Procedure

1. Navigate to the [OpenShift Container Platform downloads page](#) on the Red Hat Customer Portal.
2. Select the appropriate version in the **Version** drop-down menu.
3. Click **Download Now** next to the **OpenShift v4.10 Windows Client** entry and save the file.
4. Unzip the archive with a ZIP program.
5. Move the **oc** binary to a directory that is on your **PATH**.  
To check your **PATH**, open the command prompt and execute the following command:

```
C:\> path
```

After you install the OpenShift CLI, it is available using the **oc** command:

```
C:\> oc <command>
```

## Installing the OpenShift CLI on macOS

You can install the OpenShift CLI (**oc**) binary on macOS by using the following procedure.

### Procedure

1. Navigate to the [OpenShift Container Platform downloads page](#) on the Red Hat Customer Portal.
2. Select the appropriate version in the **Version** drop-down menu.
3. Click **Download Now** next to the **OpenShift v4.10 MacOSX Client** entry and save the file.
4. Unpack and unzip the archive.
5. Move the **oc** binary to a directory on your **PATH**.  
To check your **PATH**, open a terminal and execute the following command:

```
$ echo $PATH
```

After you install the OpenShift CLI, it is available using the **oc** command:

```
$ oc <command>
```

### 5.4.7. Logging in to the cluster by using the CLI

You can log in to your cluster as a default system user by exporting the cluster **kubeconfig** file. The **kubeconfig** file contains information about the cluster that is used by the CLI to connect a client to the correct cluster and API server. The file is specific to a cluster and is created during OpenShift Container Platform installation.

#### Prerequisites

- You deployed an OpenShift Container Platform cluster.
- You installed the **oc** CLI.

#### Procedure

1. Export the **kubeadmin** credentials:

```
$ export KUBECONFIG=<installation_directory>/auth/kubeconfig 1
```

- 1** For **<installation\_directory>**, specify the path to the directory that you stored the installation files in.

2. Verify you can run **oc** commands successfully using the exported configuration:

```
$ oc whoami
```

#### Example output

```
system:admin
```

## 5.4.8. Logging in to the cluster by using the web console

The **kubeadmin** user exists by default after an OpenShift Container Platform installation. You can log in to your cluster as the **kubeadmin** user by using the OpenShift Container Platform web console.

### Prerequisites

- You have access to the installation host.
- You completed a cluster installation and all cluster Operators are available.

### Procedure

1. Obtain the password for the **kubeadmin** user from the **kubeadmin-password** file on the installation host:

```
$ cat <installation_directory>/auth/kubeadmin-password
```



#### NOTE

Alternatively, you can obtain the **kubeadmin** password from the **<installation\_directory>/openshift\_install.log** log file on the installation host.

2. List the OpenShift Container Platform web console route:

```
$ oc get routes -n openshift-console | grep 'console-openshift'
```



#### NOTE

Alternatively, you can obtain the OpenShift Container Platform route from the **<installation\_directory>/openshift\_install.log** log file on the installation host.

### Example output

```
console    console-openshift-console.apps.<cluster_name>.<base_domain>    console
https      reencrypt/Redirect      None
```

3. Navigate to the route detailed in the output of the preceding command in a web browser and log in as the **kubeadmin** user.

### Additional resources

- See [Accessing the web console](#) for more details about accessing and understanding the OpenShift Container Platform web console.

## 5.4.9. Telemetry access for OpenShift Container Platform

In OpenShift Container Platform 4.10, the Telemetry service, which runs by default to provide metrics about cluster health and the success of updates, requires internet access. If your cluster is connected to the internet, Telemetry runs automatically, and your cluster is registered to [OpenShift Cluster Manager](#).

After you confirm that your [OpenShift Cluster Manager](#) inventory is correct, either maintained automatically by Telemetry or manually by using OpenShift Cluster Manager, [use subscription watch](#) to track your OpenShift Container Platform subscriptions at the account or multi-cluster level.

### Additional resources

- See [About remote health monitoring](#) for more information about the Telemetry service

### 5.4.10. Next steps

- [Validating an installation.](#)
- [Customize your cluster.](#)
- If necessary, you can [opt out of remote health reporting](#) .
- If necessary, you can [remove cloud provider credentials](#).

## 5.5. INSTALLING A CLUSTER ON AWS WITH CUSTOMIZATIONS

In OpenShift Container Platform version 4.10, you can install a customized cluster on infrastructure that the installation program provisions on Amazon Web Services (AWS). To customize the installation, you modify parameters in the **install-config.yaml** file before you install the cluster.



### NOTE

The scope of the OpenShift Container Platform installation configurations is intentionally narrow. It is designed for simplicity and ensured success. You can complete many more OpenShift Container Platform configuration tasks after an installation completes.

### 5.5.1. Prerequisites

- You reviewed details about the [OpenShift Container Platform installation and update](#) processes.
- You read the documentation on [selecting a cluster installation method and preparing it for users](#).
- You [configured an AWS account](#) to host the cluster.

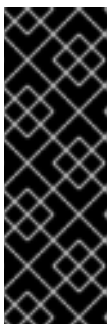

### IMPORTANT

If you have an AWS profile stored on your computer, it must not use a temporary session token that you generated while using a multi-factor authentication device. The cluster continues to use your current AWS credentials to create AWS resources for the entire life of the cluster, so you must use long-lived credentials. To generate appropriate keys, see [Managing Access Keys for IAM Users](#) in the AWS documentation. You can supply the keys when you run the installation program.

- If you use a firewall, you [configured it to allow the sites](#) that your cluster requires access to.

- If the cloud identity and access management (IAM) APIs are not accessible in your environment, or if you do not want to store an administrator-level credential secret in the **kube-system** namespace, you can [manually create and maintain IAM credentials](#).

### 5.5.2. Internet access for OpenShift Container Platform

In OpenShift Container Platform 4.10, you require access to the internet to install your cluster.

You must have internet access to:

- Access [OpenShift Cluster Manager](#) to download the installation program and perform subscription management. If the cluster has internet access and you do not disable Telemetry, that service automatically entitles your cluster.
- Access [Quay.io](#) to obtain the packages that are required to install your cluster.
- Obtain the packages that are required to perform cluster updates.



#### IMPORTANT

If your cluster cannot have direct internet access, you can perform a restricted network installation on some types of infrastructure that you provision. During that process, you download the required content and use it to populate a mirror registry with the installation packages. With some installation types, the environment that you install your cluster in will not require internet access. Before you update the cluster, you update the content of the mirror registry.

### 5.5.3. Generating a key pair for cluster node SSH access

During an OpenShift Container Platform installation, you can provide an SSH public key to the installation program. The key is passed to the Red Hat Enterprise Linux CoreOS (RHCOS) nodes through their Ignition config files and is used to authenticate SSH access to the nodes. The key is added to the `~/.ssh/authorized_keys` list for the **core** user on each node, which enables password-less authentication.

After the key is passed to the nodes, you can use the key pair to SSH in to the RHCOS nodes as the user **core**. To access the nodes through SSH, the private key identity must be managed by SSH for your local user.

If you want to SSH in to your cluster nodes to perform installation debugging or disaster recovery, you must provide the SSH public key during the installation process. The **`./openshift-install gather`** command also requires the SSH public key to be in place on the cluster nodes.



#### IMPORTANT

Do not skip this procedure in production environments, where disaster recovery and debugging is required.



#### NOTE

You must use a local key, not one that you configured with platform-specific approaches such as [AWS key pairs](#).

#### Procedure



1. If you do not have an existing SSH key pair on your local machine to use for authentication onto your cluster nodes, create one. For example, on a computer that uses a Linux operating system, run the following command:

```
$ ssh-keygen -t ed25519 -N "" -f <path>/<file_name> 1
```

- 1 Specify the path and file name, such as `~/.ssh/id_ed25519`, of the new SSH key. If you have an existing key pair, ensure your public key is in the your `~/.ssh` directory.



#### NOTE

If you plan to install an OpenShift Container Platform cluster that uses FIPS validated or Modules In Process cryptographic libraries on the **x86\_64** architecture, do not create a key that uses the **ed25519** algorithm. Instead, create a key that uses the **rsa** or **ecdsa** algorithm.

2. View the public SSH key:

```
$ cat <path>/<file_name>.pub
```

For example, run the following to view the `~/.ssh/id_ed25519.pub` public key:

```
$ cat ~/.ssh/id_ed25519.pub
```

3. Add the SSH private key identity to the SSH agent for your local user, if it has not already been added. SSH agent management of the key is required for password-less SSH authentication onto your cluster nodes, or if you want to use the `./openshift-install gather` command.

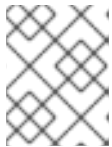

#### NOTE

On some distributions, default SSH private key identities such as `~/.ssh/id_rsa` and `~/.ssh/id_dsa` are managed automatically.

- a. If the **ssh-agent** process is not already running for your local user, start it as a background task:

```
$ eval "$(ssh-agent -s)"
```

#### Example output

```
Agent pid 31874
```



#### NOTE

If your cluster is in FIPS mode, only use FIPS-compliant algorithms to generate the SSH key. The key must be either RSA or ECDSA.

4. Add your SSH private key to the **ssh-agent**:

```
$ ssh-add <path>/<file_name> 1
```

- 1 Specify the path and file name for your SSH private key, such as `~/.ssh/id_ed25519`

### Example output

```
Identity added: /home/<you>/<path>/<file_name> (<computer_name>)
```

### Next steps

- When you install OpenShift Container Platform, provide the SSH public key to the installation program.

## 5.5.4. Obtaining an AWS Marketplace image

If you are deploying an OpenShift Container Platform cluster using an AWS Marketplace image, you must first subscribe through AWS. Subscribing to the offer provides you with the AMI ID that the installation program uses to deploy worker nodes.

### Prerequisites

- You have an AWS account to purchase the offer. This account does not have to be the same account that is used to install the cluster.

### Procedure

1. Complete the OpenShift Container Platform subscription from the [AWS Marketplace](#).
2. Record the AMI ID for your specific region. As part of the installation process, you must update the **install-config.yaml** file with this value before deploying the cluster.

### Sample install-config.yaml file with AWS Marketplace worker nodes

```
apiVersion: v1
baseDomain: example.com
compute:
- hyperthreading: Enabled
  name: worker
  platform:
    aws:
      amiID: ami-06c4d345f7c207239 1
      type: m5.4xlarge
    replicas: 3
  metadata:
    name: test-cluster
  platform:
    aws:
      region: us-east-2 2
  sshKey: ssh-ed25519 AAAA...
  pullSecret: '{"auths": ...}'
```

- 1 The AMI ID from your AWS Marketplace subscription.

- 2

Your AMI ID is associated with a specific AWS region. When creating the installation configuration file, ensure that you select the same AWS region that you specified when configuring your

### 5.5.5. Obtaining the installation program

Before you install OpenShift Container Platform, download the installation file on a local computer.

#### Prerequisites

- You have a computer that runs Linux or macOS, with 500 MB of local disk space

#### Procedure

1. Access the [Infrastructure Provider](#) page on the OpenShift Cluster Manager site. If you have a Red Hat account, log in with your credentials. If you do not, create an account.
2. Select your infrastructure provider.
3. Navigate to the page for your installation type, download the installation program that corresponds with your host operating system and architecture, and place the file in the directory where you will store the installation configuration files.



#### IMPORTANT

The installation program creates several files on the computer that you use to install your cluster. You must keep the installation program and the files that the installation program creates after you finish installing the cluster. Both files are required to delete the cluster.



#### IMPORTANT

Deleting the files created by the installation program does not remove your cluster, even if the cluster failed during installation. To remove your cluster, complete the OpenShift Container Platform uninstallation procedures for your specific cloud provider.

4. Extract the installation program. For example, on a computer that uses a Linux operating system, run the following command:

```
$ tar -xvf openshift-install-linux.tar.gz
```

5. Download your installation [pull secret from the Red Hat OpenShift Cluster Manager](#). This pull secret allows you to authenticate with the services that are provided by the included authorities, including Quay.io, which serves the container images for OpenShift Container Platform components.

### 5.5.6. Creating the installation configuration file

You can customize the OpenShift Container Platform cluster you install on Amazon Web Services (AWS).

#### Prerequisites

- Obtain the OpenShift Container Platform installation program and the pull secret for your cluster.
- Obtain service principal permissions at the subscription level.

## Procedure

1. Create the **install-config.yaml** file.
  - a. Change to the directory that contains the installation program and run the following command:

```

$ ./openshift-install create install-config --dir <installation_directory> 1

```

- 1 For **<installation\_directory>**, specify the directory name to store the files that the installation program creates.



### IMPORTANT

Specify an empty directory. Some installation assets, like bootstrap X.509 certificates have short expiration intervals, so you must not reuse an installation directory. If you want to reuse individual files from another cluster installation, you can copy them into your directory. However, the file names for the installation assets might change between releases. Use caution when copying installation files from an earlier OpenShift Container Platform version.

- b. At the prompts, provide the configuration details for your cloud:
  - i. Optional: Select an SSH key to use to access your cluster machines.



### NOTE

For production OpenShift Container Platform clusters on which you want to perform installation debugging or disaster recovery, specify an SSH key that your **ssh-agent** process uses.

- ii. Select **AWS** as the platform to target.
  - iii. If you do not have an Amazon Web Services (AWS) profile stored on your computer, enter the AWS access key ID and secret access key for the user that you configured to run the installation program.
  - iv. Select the AWS region to deploy the cluster to.
  - v. Select the base domain for the Route 53 service that you configured for your cluster.
  - vi. Enter a descriptive name for your cluster.
  - vii. Paste the [pull secret from the Red Hat OpenShift Cluster Manager](#) .
2. Modify the **install-config.yaml** file. You can find more information about the available parameters in the "Installation configuration parameters" section.

3. Back up the **install-config.yaml** file so that you can use it to install multiple clusters.

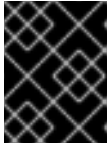

### IMPORTANT

The **install-config.yaml** file is consumed during the installation process. If you want to reuse the file, you must back it up now.

#### 5.5.6.1. Installation configuration parameters

Before you deploy an OpenShift Container Platform cluster, you provide parameter values to describe your account on the cloud platform that hosts your cluster and optionally customize your cluster's platform. When you create the **install-config.yaml** installation configuration file, you provide values for the required parameters through the command line. If you customize your cluster, you can modify the **install-config.yaml** file to provide more details about the platform.



### NOTE

After installation, you cannot modify these parameters in the **install-config.yaml** file.

##### 5.5.6.1.1. Required configuration parameters

Required installation configuration parameters are described in the following table:

Table 5.1. Required parameters

Parameter	Description	Values
<b>apiVersion</b>	The API version for the <b>install-config.yaml</b> content. The current version is <b>v1</b> . The installer may also support older API versions.	String
<b>baseDomain</b>	The base domain of your cloud provider. The base domain is used to create routes to your OpenShift Container Platform cluster components. The full DNS name for your cluster is a combination of the <b>baseDomain</b> and <b>metadata.name</b> parameter values that uses the <b>&lt;metadata.name&gt;</b> . <b>&lt;baseDomain&gt;</b> format.	A fully-qualified domain or subdomain name, such as <b>example.com</b> .
<b>metadata</b>	Kubernetes resource <b>ObjectMeta</b> , from which only the <b>name</b> parameter is consumed.	Object

Parameter	Description	Values
<b>metadata.name</b>	The name of the cluster. DNS records for the cluster are all subdomains of <b>{{.metadata.name}}.{{.baseDomain}}</b> .	String of lowercase letters, hyphens (-), and periods (.), such as <b>dev</b> .
<b>platform</b>	The configuration for the specific platform upon which to perform the installation: <b>alibabacloud, aws, baremetal, azure, gcp, ibmcloud, openstack, ovirt, vsphere</b> , or <b>{}</b> . For additional information about <b>platform.&lt;platform&gt;</b> parameters, consult the table for your specific platform that follows.	Object
<b>pullSecret</b>	Get a <a href="#">pull secret from the Red Hat OpenShift Cluster Manager</a> to authenticate downloading container images for OpenShift Container Platform components from services such as Quay.io.	<pre>{   "auths":{     "cloud.openshift.com":{       "auth":"b3Blb=",       "email":"you@example.com"     },     "quay.io":{       "auth":"b3Blb=",       "email":"you@example.com"     }   } }</pre>

#### 5.5.6.1.2. Network configuration parameters

You can customize your installation configuration based on the requirements of your existing network infrastructure. For example, you can expand the IP address block for the cluster network or provide different IP address blocks than the defaults.

Only IPv4 addresses are supported.

Table 5.2. Network parameters

Parameter	Description	Values
-----------	-------------	--------

Parameter	Description	Values
<b>networking</b>	The configuration for the cluster network.	Object  <b>NOTE</b> You cannot modify parameters specified by the <b>networking</b> object after installation.
<b>networking.networkType</b>	The cluster network provider Container Network Interface (CNI) plugin to install.	Either <b>OpenShiftSDN</b> or <b>OVNKubernetes</b> . <b>OpenShiftSDN</b> is a CNI provider for all-Linux networks. <b>OVNKubernetes</b> is a CNI provider for Linux networks and hybrid networks that contain both Linux and Windows servers. The default value is <b>OpenShiftSDN</b> .
<b>networking.clusterNetwork</b>	The IP address blocks for pods.  The default value is <b>10.128.0.0/14</b> with a host prefix of <b>/23</b> .  If you specify multiple IP address blocks, the blocks must not overlap.	An array of objects. For example:  <pre>networking:   clusterNetwork:     - cidr: 10.128.0.0/14       hostPrefix: 23</pre>
<b>networking.clusterNetwork.cidr</b>	Required if you use <b>networking.clusterNetwork</b> . An IP address block.  An IPv4 network.	An IP address block in Classless Inter-Domain Routing (CIDR) notation. The prefix length for an IPv4 block is between <b>0</b> and <b>32</b> .
<b>networking.clusterNetwork.hostPrefix</b>	The subnet prefix length to assign to each individual node. For example, if <b>hostPrefix</b> is set to <b>23</b> then each node is assigned a <b>/23</b> subnet out of the given <b>cidr</b> . A <b>hostPrefix</b> value of <b>23</b> provides 510 ( $2^{(32 - 23)} - 2$ ) pod IP addresses.	A subnet prefix.  The default value is <b>23</b> .
<b>networking.serviceNetwork</b>	The IP address block for services. The default value is <b>172.30.0.0/16</b> .  The OpenShift SDN and OVN-Kubernetes network providers support only a single IP address block for the service network.	An array with an IP address block in CIDR format. For example:  <pre>networking:   serviceNetwork:     - 172.30.0.0/16</pre>

Parameter	Description	Values
<b>networking.machineNetwork</b>	The IP address blocks for machines.  If you specify multiple IP address blocks, the blocks must not overlap.	An array of objects. For example:  <pre>networking:   machineNetwork:   - cidr: 10.0.0.0/16</pre>
<b>networking.machineNetwork.cidr</b>	Required if you use <b>networking.machineNetwork</b> . An IP address block. The default value is <b>10.0.0.0/16</b> for all platforms other than libvirt. For libvirt, the default value is <b>192.168.126.0/24</b> .	An IP network block in CIDR notation.  For example, <b>10.0.0.0/16</b> .   <p><b>NOTE</b></p> <p>Set the <b>networking.machineNetwork</b> to match the CIDR that the preferred NIC resides in.</p>

### 5.5.6.1.3. Optional configuration parameters

Optional installation configuration parameters are described in the following table:

Table 5.3. Optional parameters

Parameter	Description	Values
<b>additionalTrustBundle</b>	A PEM-encoded X.509 certificate bundle that is added to the nodes' trusted certificate store. This trust bundle may also be used when a proxy has been configured.	String
<b>cgroupsV2</b>	Enables <a href="#">Linux control groups version 2</a> (cgroups v2) on specific nodes in your cluster. The OpenShift Container Platform process for enabling cgroups v2 disables all cgroup version 1 controllers and hierarchies. The OpenShift Container Platform cgroups version 2 feature is in Developer Preview and is not supported by Red Hat at this time.	<b>true</b>
<b>compute</b>	The configuration for the machines that comprise the compute nodes.	Array of <b>MachinePool</b> objects.



Parameter	Description	Values
<b>compute.architecture</b>	Determines the instruction set architecture of the machines in the pool. Currently, clusters with varied architectures are not supported. All pools must specify the same architecture. Valid values are <b>amd64</b> and <b>arm64</b> . See <i>Supported installation methods for different platforms</i> in <i>Installing</i> documentation for information about instance availability.	String
<b>compute.hyperthreading</b>	Whether to enable or disable simultaneous multithreading, or <b>hyperthreading</b> , on compute machines. By default, simultaneous multithreading is enabled to increase the performance of your machines' cores.   <b>IMPORTANT</b> If you disable simultaneous multithreading, ensure that your capacity planning accounts for the dramatically decreased machine performance.	<b>Enabled</b> or <b>Disabled</b>
<b>compute.name</b>	Required if you use <b>compute</b> . The name of the machine pool.	<b>worker</b>
<b>compute.platform</b>	Required if you use <b>compute</b> . Use this parameter to specify the cloud provider to host the worker machines. This parameter value must match the <b>controlPlane.platform</b> parameter value.	<b>alibabacloud, aws, azure, gcp, ibmcloud, openstack, ovirt, vsphere</b> , or <b>{}</b>
<b>compute.replicas</b>	The number of compute machines, which are also known as worker machines, to provision.	A positive integer greater than or equal to <b>2</b> . The default value is <b>3</b> .
<b>controlPlane</b>	The configuration for the machines that comprise the control plane.	Array of <b>MachinePool</b> objects.

Parameter	Description	Values
<b>controlPlane.architecture</b>	Determines the instruction set architecture of the machines in the pool. Currently, clusters with varied architectures are not supported. All pools must specify the same architecture. Valid values are <b>amd64</b> and <b>arm64</b> . See <i>Supported installation methods for different platforms</i> in <i>Installing</i> documentation for information about instance availability.	String
<b>controlPlane.hyperthreading</b>	Whether to enable or disable simultaneous multithreading, or <b>hyperthreading</b> , on control plane machines. By default, simultaneous multithreading is enabled to increase the performance of your machines' cores.   <b>IMPORTANT</b> If you disable simultaneous multithreading, ensure that your capacity planning accounts for the dramatically decreased machine performance.	<b>Enabled</b> or <b>Disabled</b>
<b>controlPlane.name</b>	Required if you use <b>controlPlane</b> . The name of the machine pool.	<b>master</b>
<b>controlPlane.platform</b>	Required if you use <b>controlPlane</b> . Use this parameter to specify the cloud provider that hosts the control plane machines. This parameter value must match the <b>compute.platform</b> parameter value.	<b>alibabacloud, aws, azure, gcp, ibmcloud, openstack, ovirt, vsphere, or {}</b>
<b>controlPlane.replicas</b>	The number of control plane machines to provision.	The only supported value is <b>3</b> , which is the default value.

Parameter	Description	Values
<p><b>credentialsMode</b></p>	<p>The Cloud Credential Operator (CCO) mode. If no mode is specified, the CCO dynamically tries to determine the capabilities of the provided credentials, with a preference for mint mode on the platforms where multiple modes are supported.</p> <div data-bbox="486 517 595 864" style="border: 1px solid black; padding: 5px; margin-bottom: 10px;"> <p><b>NOTE</b></p> <p>Not all CCO modes are supported for all cloud providers. For more information on CCO modes, see the <i>Cloud Credential Operator</i> entry in the <i>Cluster Operators</i> reference content.</p> </div> <div data-bbox="486 913 595 1261" style="border: 1px solid black; padding: 5px;"> <p><b>NOTE</b></p> <p>If your AWS account has service control policies (SCP) enabled, you must configure the <b>credentialsMode</b> parameter to <b>Mint</b>, <b>Passthrough</b> or <b>Manual</b>.</p> </div>	<p><b>Mint, Passthrough, Manual</b> or an empty string ("").</p>

Parameter	Description	Values
<b>fips</b>	<p>Enable or disable FIPS mode. The default is <b>false</b> (disabled). If FIPS mode is enabled, the Red Hat Enterprise Linux CoreOS (RHCOS) machines that OpenShift Container Platform runs on bypass the default Kubernetes cryptography suite and use the cryptography modules that are provided with RHCOS instead.</p> <div style="display: flex; align-items: flex-start;"> <div style="width: 20px; height: 100px; background: repeating-linear-gradient(45deg, transparent, transparent 2px, black 2px, black 4px); margin-right: 10px;"></div> <div> <p><b>IMPORTANT</b></p> <p>To enable FIPS mode for your cluster, you must run the installation program from a Red Hat Enterprise Linux (RHEL) computer configured to operate in FIPS mode. For more information about configuring FIPS mode on RHEL, see <a href="#">Installing the system in FIPS mode</a>. The use of FIPS validated or Modules In Process cryptographic libraries is only supported on OpenShift Container Platform deployments on the <b>x86_64</b> architecture.</p> </div> </div> <div style="display: flex; align-items: flex-start; margin-top: 10px;"> <div style="width: 20px; height: 100px; background: repeating-linear-gradient(45deg, transparent, transparent 2px, black 2px, black 4px); margin-right: 10px;"></div> <div> <p><b>NOTE</b></p> <p>If you are using Azure File storage, you cannot enable FIPS mode.</p> </div> </div>	<b>false</b> or <b>true</b>
<b>imageContentSources</b>	Sources and repositories for the release-image content.	Array of objects. Includes a <b>source</b> and, optionally, <b>mirrors</b> , as described in the following rows of this table.
<b>imageContentSources.source</b>	Required if you use <b>imageContentSources</b> . Specify the repository that users refer to, for example, in image pull specifications.	String
<b>imageContentSources.mirrors</b>	Specify one or more repositories that may also contain the same images.	Array of strings

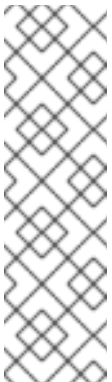
Parameter	Description	Values
<b>publish</b>	How to publish or expose the user-facing endpoints of your cluster, such as the Kubernetes API, OpenShift routes.	<b>Internal</b> or <b>External</b> . To deploy a private cluster, which cannot be accessed from the internet, set <b>publish</b> to <b>Internal</b> . The default value is <b>External</b> .
<b>sshKey</b>	<p>The SSH key or keys to authenticate access your cluster machines.</p>  <p><b>NOTE</b></p> <p>For production OpenShift Container Platform clusters on which you want to perform installation debugging or disaster recovery, specify an SSH key that your <b>ssh-agent</b> process uses.</p>	<p>One or more keys. For example:</p> <pre>sshKey:   &lt;key1&gt;   &lt;key2&gt;   &lt;key3&gt;</pre>

#### 5.5.6.1.4. Optional AWS configuration parameters

Optional AWS configuration parameters are described in the following table:

Table 5.4. Optional AWS parameters

Parameter	Description	Values
<b>compute.platform.aws.amiID</b>	The AWS AMI used to boot compute machines for the cluster. This is required for regions that require a custom RHCOS AMI.	Any published or custom RHCOS AMI that belongs to the set AWS region. See <i>RHCOS AMIs for AWS infrastructure</i> for available AMI IDs.
<b>compute.platform.aws.iamRole</b>	A pre-existing AWS IAM role applied to the compute machine pool instance profiles. You can use these fields to match naming schemes and include predefined permissions boundaries for your IAM roles. If undefined, the installation program creates a new IAM role.	The name of a valid AWS IAM role.

Parameter	Description	Values
<b>compute.platform.aws.rootVolume.iops</b>	The Input/Output Operations Per Second (IOPS) that is reserved for the root volume.	Integer, for example <b>4000</b> .
<b>compute.platform.aws.rootVolume.size</b>	The size in GiB of the root volume.	Integer, for example <b>500</b> .
<b>compute.platform.aws.rootVolume.type</b>	The type of the root volume.	Valid <a href="#">AWS EBS volume type</a> , such as <b>io1</b> .
<b>compute.platform.aws.rootVolume.kmsKeyARN</b>	The Amazon Resource Name (key ARN) of a KMS key. This is required to encrypt OS volumes of worker nodes with a specific KMS key.	Valid <a href="#">key ID</a> or the <a href="#">key ARN</a>
<b>compute.platform.aws.type</b>	The EC2 instance type for the compute machines.	Valid AWS instance type, such as <b>m4.2xlarge</b> . See the <b>Supported AWS machine types</b> table that follows.
<b>compute.platform.aws.zones</b>	The availability zones where the installation program creates machines for the compute machine pool. If you provide your own VPC, you must provide a subnet in that availability zone.	A list of valid AWS availability zones, such as <b>us-east-1c</b> , in a <a href="#">YAML sequence</a> .
<b>compute.aws.region</b>	The AWS region that the installation program creates compute resources in.	Any valid <a href="#">AWS region</a> , such as <b>us-east-1</b> .   <b>IMPORTANT</b> When running on ARM based AWS instances, ensure that you enter a region where AWS Graviton processors are available. See <a href="#">Global availability map</a> in the AWS documentation.
<b>controlPlane.platform.aws.amiID</b>	The AWS AMI used to boot control plane machines for the cluster. This is required for regions that require a custom RHCOS AMI.	Any published or custom RHCOS AMI that belongs to the set AWS region. See <i>RHCOS AMIs for AWS infrastructure</i> for available AMI IDs.

Parameter	Description	Values
<b>controlPlane.platform.aws.iamRole</b>	A pre-existing AWS IAM role applied to the control plane machine pool instance profiles. You can use these fields to match naming schemes and include predefined permissions boundaries for your IAM roles. If undefined, the installation program creates a new IAM role.	The name of a valid AWS IAM role.
<b>controlPlane.platform.aws.rootVolume.kmsKeyARN</b>	The Amazon Resource Name (key ARN) of a KMS key. This is required to encrypt OS volumes of control plane nodes with a specific KMS key.	Valid <a href="#">key ID</a> and the <a href="#">key ARN</a>
<b>controlPlane.platform.aws.type</b>	The EC2 instance type for the control plane machines.	Valid AWS instance type, such as <b>m6i.xlarge</b> . See the <b>Supported AWS machine types</b> table that follows.
<b>controlPlane.platform.aws.zones</b>	The availability zones where the installation program creates machines for the control plane machine pool.	A list of valid AWS availability zones, such as <b>us-east-1c</b> , in a <a href="#">YAML sequence</a> .
<b>controlPlane.aws.region</b>	The AWS region that the installation program creates control plane resources in.	Valid <a href="#">AWS region</a> , such as <b>us-east-1</b> .
<b>platform.aws.amiID</b>	The AWS AMI used to boot all machines for the cluster. If set, the AMI must belong to the same region as the cluster. This is required for regions that require a custom RHCOS AMI.	Any published or custom RHCOS AMI that belongs to the set AWS region. See <i>RHCOS AMIs for AWS infrastructure</i> for available AMI IDs.

Parameter	Description	Values
<b>platform.aws.hostedZone</b>	An existing Route 53 private hosted zone for the cluster. You can only use a pre-existing hosted zone when also supplying your own VPC. The hosted zone must already be associated with the user-provided VPC before installation. Also, the domain of the hosted zone must be the cluster domain or a parent of the cluster domain. If undefined, the installation program creates a new hosted zone.	String, for example <b>Z3URY6TWQ91KVV</b> .
<b>platform.aws.serviceEndpoints.name</b>	The AWS service endpoint name. Custom endpoints are only required for cases where alternative AWS endpoints, like FIPS, must be used. Custom API endpoints can be specified for EC2, S3, IAM, Elastic Load Balancing, Tagging, Route 53, and STS AWS services.	Valid <a href="#">AWS service endpoint</a> name.
<b>platform.aws.serviceEndpoints.url</b>	The AWS service endpoint URL. The URL must use the <b>https</b> protocol and the host must trust the certificate.	Valid <a href="#">AWS service endpoint</a> URL.
<b>platform.aws.userTags</b>	A map of keys and values that the installation program adds as tags to all resources that it creates.	Any valid YAML map, such as key value pairs in the <b>&lt;key&gt;: &lt;value&gt;</b> format. For more information about AWS tags, see <a href="#">Tagging Your Amazon EC2 Resources</a> in the AWS documentation.



Parameter	Description	Values
<b>platform.aws.subnets</b>	If you provide the VPC instead of allowing the installation program to create the VPC for you, specify the subnet for the cluster to use. The subnet must be part of the same <b>machineNetwork[].cidr</b> ranges that you specify. For a standard cluster, specify a public and a private subnet for each availability zone. For a private cluster, specify a private subnet for each availability zone.	Valid subnet IDs.

### 5.5.6.2. Minimum resource requirements for cluster installation

Each cluster machine must meet the following minimum requirements:

**Table 5.5. Minimum resource requirements**

Machine	Operating System	vCPU [1]	Virtual RAM	Storage	IOPS [2]
Bootstrap	RHCOS	4	16 GB	100 GB	300
Control plane	RHCOS	4	16 GB	100 GB	300
Compute	RHCOS, RHEL 8.4, or RHEL 8.5 [3]	2	8 GB	100 GB	300

1. One vCPU is equivalent to one physical core when simultaneous multithreading (SMT), or hyperthreading, is not enabled. When enabled, use the following formula to calculate the corresponding ratio:  $(\text{threads per core} \times \text{cores}) \times \text{sockets} = \text{vCPUs}$ .
2. OpenShift Container Platform and Kubernetes are sensitive to disk performance, and faster storage is recommended, particularly for etcd on the control plane nodes which require a 10 ms p99 fsync duration. Note that on many cloud platforms, storage size and IOPS scale together, so you might need to over-allocate storage volume to obtain sufficient performance.
3. As with all user-provisioned installations, if you choose to use RHEL compute machines in your cluster, you take responsibility for all operating system life cycle management and maintenance, including performing system updates, applying patches, and completing all other required tasks. Use of RHEL 7 compute machines is deprecated and has been removed in OpenShift Container Platform 4.10 and later.

If an instance type for your platform meets the minimum requirements for cluster machines, it is supported to use in OpenShift Container Platform.

### 5.5.6.3. Tested instance types for AWS

The following Amazon Web Services (AWS) instance types have been tested with OpenShift Container Platform.



#### NOTE

Use the machine types included in the following charts for your AWS instances. If you use an instance type that is not listed in the chart, ensure that the instance size you use matches the minimum resource requirements that are listed in "Minimum resource requirements for cluster installation".

#### Example 5.16. Machine types based on 64-bit x86 architecture

- **c4.\***
- **c5.\***
- **c5a.\***
- **i3.\***
- **m4.\***
- **m5.\***
- **m5a.\***
- **m6i.\***
- **r4.\***
- **r5.\***
- **r5a.\***
- **r6i.\***
- **t3.\***
- **t3a.\***

### 5.5.6.4. Tested instance types for AWS on 64-bit ARM infrastructures

The following Amazon Web Services (AWS) ARM64 instance types have been tested with OpenShift Container Platform.



#### NOTE

Use the machine types included in the following charts for your AWS ARM instances. If you use an instance type that is not listed in the chart, ensure that the instance size you use matches the minimum resource requirements that are listed in "Minimum resource requirements for cluster installation".

### Example 5.17. Machine types based on 64-bit ARM architecture

- **c6g.\***
- **m6g.\***

#### 5.5.6.5. Sample customized install-config.yaml file for AWS

You can customize the installation configuration file (**install-config.yaml**) to specify more details about your OpenShift Container Platform cluster's platform or modify the values of the required parameters.



#### IMPORTANT

This sample YAML file is provided for reference only. You must obtain your **install-config.yaml** file by using the installation program and modify it.

```

apiVersion: v1
baseDomain: example.com 1
credentialsMode: Mint 2
controlPlane: 3 4
  hyperthreading: Enabled 5
  name: master
  platform:
    aws:
      zones:
      - us-west-2a
      - us-west-2b
    rootVolume:
      iops: 4000
      size: 500
      type: io1 6
      type: m6i.xlarge
    replicas: 3
compute: 7
- hyperthreading: Enabled 8
  name: worker
  platform:
    aws:
      rootVolume:
        iops: 2000
        size: 500
        type: io1 9
        type: c5.4xlarge
      zones:
      - us-west-2c
    replicas: 3
metadata:
  name: test-cluster 10
networking:
  clusterNetwork:
  - cidr: 10.128.0.0/14
  hostPrefix: 23

```

```

machineNetwork:
- cidr: 10.0.0.0/16
networkType: OpenShiftSDN
serviceNetwork:
- 172.30.0.0/16
platform:
aws:
region: us-west-2 11
userTags:
adminContact: jdoe
costCenter: 7536
amiID: ami-96c6f8f7 12
serviceEndpoints: 13
- name: ec2
url: https://vpce-id.ec2.us-west-2.vpce.amazonaws.com
fips: false 14
sshKey: ssh-ed25519 AAAA... 15
pullSecret: '{"auths": ...}' 16

```

- 1 10 11 16** Required. The installation program prompts you for this value.
- 2** Optional: Add this parameter to force the Cloud Credential Operator (CCO) to use the specified mode, instead of having the CCO dynamically try to determine the capabilities of the credentials. For details about CCO modes, see the *Cloud Credential Operator* entry in the *Red Hat Operators reference* content.
- 3 7** If you do not provide these parameters and values, the installation program provides the default value.
- 4** The **controlPlane** section is a single mapping, but the **compute** section is a sequence of mappings. To meet the requirements of the different data structures, the first line of the **compute** section must begin with a hyphen, -, and the first line of the **controlPlane** section must not. Only one control plane pool is used.
- 5 8** Whether to enable or disable simultaneous multithreading, or **hyperthreading**. By default, simultaneous multithreading is enabled to increase the performance of your machines' cores. You can disable it by setting the parameter value to **Disabled**. If you disable simultaneous multithreading in some cluster machines, you must disable it in all cluster machines.



### IMPORTANT

If you disable simultaneous multithreading, ensure that your capacity planning accounts for the dramatically decreased machine performance. Use larger instance types, such as **m4.2xlarge** or **m5.2xlarge**, for your machines if you disable simultaneous multithreading.

- 6 9** To configure faster storage for etcd, especially for larger clusters, set the storage type as **io1** and set **iops** to **2000**.
- 12** The ID of the AMI used to boot machines for the cluster. If set, the AMI must belong to the same region as the cluster.
- 13** The AWS service endpoints. Custom endpoints are required when installing to an unknown AWS region. The endpoint URL must use the **https** protocol and the host must trust the certificate.

- 14 Whether to enable or disable FIPS mode. By default, FIPS mode is not enabled. If FIPS mode is enabled, the Red Hat Enterprise Linux CoreOS (RHCOS) machines that OpenShift Container



### IMPORTANT

To enable FIPS mode for your cluster, you must run the installation program from a Red Hat Enterprise Linux (RHEL) computer configured to operate in FIPS mode. For more information about configuring FIPS mode on RHEL, see [Installing the system in FIPS mode](#). The use of FIPS validated or Modules In Process cryptographic libraries is only supported on OpenShift Container Platform deployments on the **x86\_64** architecture.

- 15 You can optionally provide the **sshKey** value that you use to access the machines in your cluster.



### NOTE

For production OpenShift Container Platform clusters on which you want to perform installation debugging or disaster recovery, specify an SSH key that your **ssh-agent** process uses.

#### 5.5.6.6. Configuring the cluster-wide proxy during installation

Production environments can deny direct access to the internet and instead have an HTTP or HTTPS proxy available. You can configure a new OpenShift Container Platform cluster to use a proxy by configuring the proxy settings in the **install-config.yaml** file.

#### Prerequisites

- You have an existing **install-config.yaml** file.
- You reviewed the sites that your cluster requires access to and determined whether any of them need to bypass the proxy. By default, all cluster egress traffic is proxied, including calls to hosting cloud provider APIs. You added sites to the **Proxy** object's **spec.noProxy** field to bypass the proxy if necessary.



### NOTE

The **Proxy** object **status.noProxy** field is populated with the values of the **networking.machineNetwork[].cidr**, **networking.clusterNetwork[].cidr**, and **networking.serviceNetwork[]** fields from your installation configuration.

For installations on Amazon Web Services (AWS), Google Cloud Platform (GCP), Microsoft Azure, and Red Hat OpenStack Platform (RHOSP), the **Proxy** object **status.noProxy** field is also populated with the instance metadata endpoint (**169.254.169.254**).

- You have added the **ec2.<region>.amazonaws.com**, **elasticloadbalancing.<region>.amazonaws.com**, and **s3.<region>.amazonaws.com** endpoints to your VPC endpoint. These endpoints are required to complete requests from the nodes to the AWS EC2 API. Because the proxy works on the container level, not the node level, you must route these requests to the AWS EC2 API through the AWS private network. Adding the public IP address of the EC2 API to your allowlist in your proxy server is not sufficient.

## Procedure

1. Edit your **install-config.yaml** file and add the proxy settings. For example:

```

apiVersion: v1
baseDomain: my.domain.com
proxy:
  httpProxy: http://<username>:<pswd>@<ip>:<port> 1
  httpsProxy: https://<username>:<pswd>@<ip>:<port> 2
  noProxy: example.com 3
  additionalTrustBundle: | 4
    -----BEGIN CERTIFICATE-----
    <MY_TRUSTED_CA_CERT>
    -----END CERTIFICATE-----
...

```

- 1 A proxy URL to use for creating HTTP connections outside the cluster. The URL scheme must be **http**.
- 2 A proxy URL to use for creating HTTPS connections outside the cluster.
- 3 A comma-separated list of destination domain names, IP addresses, or other network CIDRs to exclude from proxying. Preface a domain with **.** to match subdomains only. For example, **.y.com** matches **x.y.com**, but not **y.com**. Use **\*** to bypass the proxy for all destinations.
- 4 If provided, the installation program generates a config map that is named **user-ca-bundle** in the **openshift-config** namespace that contains one or more additional CA certificates that are required for proxying HTTPS connections. The Cluster Network Operator then creates a **trusted-ca-bundle** config map that merges these contents with the Red Hat Enterprise Linux CoreOS (RHCOS) trust bundle, and this config map is referenced in the **trustedCA** field of the **Proxy** object. The **additionalTrustBundle** field is required unless the proxy's identity certificate is signed by an authority from the RHCOS trust bundle.

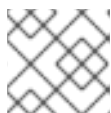

### NOTE

The installation program does not support the proxy **readinessEndpoints** field.



### NOTE

If the installer times out, restart and then complete the deployment by using the **wait-for** command of the installer. For example:

```
$ ./openshift-install wait-for install-complete --log-level debug
```

2. Save the file and reference it when installing OpenShift Container Platform.

The installation program creates a cluster-wide proxy that is named **cluster** that uses the proxy settings in the provided **install-config.yaml** file. If no proxy settings are provided, a **cluster Proxy** object is still created, but it will have a nil **spec**.

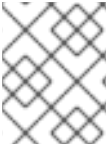
**NOTE**

Only the **Proxy** object named **cluster** is supported, and no additional proxies can be created.

### 5.5.7. Deploying the cluster

You can install OpenShift Container Platform on a compatible cloud platform.

**IMPORTANT**

You can run the **create cluster** command of the installation program only once, during initial installation.

#### Prerequisites

- Configure an account with the cloud platform that hosts your cluster.
- Obtain the OpenShift Container Platform installation program and the pull secret for your cluster.

#### Procedure

1. Change to the directory that contains the installation program and initialize the cluster deployment:

```
$ ./openshift-install create cluster --dir <installation_directory> \ 1
--log-level=info 2
```

- 1** For **<installation\_directory>**, specify the location of your customized **./install-config.yaml** file.
- 2** To view different installation details, specify **warn**, **debug**, or **error** instead of **info**.

**NOTE**

If the cloud provider account that you configured on your host does not have sufficient permissions to deploy the cluster, the installation process stops, and the missing permissions are displayed.

When the cluster deployment completes, directions for accessing your cluster, including a link to its web console and credentials for the **kubeadmin** user, display in your terminal.

#### Example output

```
...
INFO Install complete!
INFO To access the cluster as the system:admin user when using 'oc', run 'export
KUBECONFIG=/home/myuser/install_dir/auth/kubeconfig'
INFO Access the OpenShift web-console here: https://console-openshift-
console.apps.mycluster.example.com
```

```
INFO Login to the console with user: "kubeadmin", and password: "4vYBz-Ee6gm-ymBZj-
Wt5AL"
INFO Time elapsed: 36m22s
```

**NOTE**

The cluster access and credential information also outputs to `<installation_directory>/openshift_install.log` when an installation succeeds.

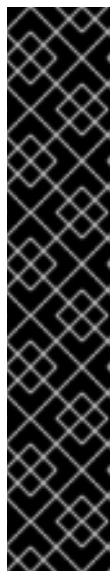
**IMPORTANT**

- The Ignition config files that the installation program generates contain certificates that expire after 24 hours, which are then renewed at that time. If the cluster is shut down before renewing the certificates and the cluster is later restarted after the 24 hours have elapsed, the cluster automatically recovers the expired certificates. The exception is that you must manually approve the pending **node-bootstrapper** certificate signing requests (CSRs) to recover kubelet certificates. See the documentation for *Recovering from expired control plane certificates* for more information.
- It is recommended that you use Ignition config files within 12 hours after they are generated because the 24-hour certificate rotates from 16 to 22 hours after the cluster is installed. By using the Ignition config files within 12 hours, you can avoid installation failure if the certificate update runs during installation.

**IMPORTANT**

You must not delete the installation program or the files that the installation program creates. Both are required to delete the cluster.

2. Optional: Remove or disable the **AdministratorAccess** policy from the IAM account that you used to install the cluster.

**NOTE**

The elevated permissions provided by the **AdministratorAccess** policy are required only during installation.

### 5.5.8. Installing the OpenShift CLI by downloading the binary

You can install the OpenShift CLI (**oc**) to interact with OpenShift Container Platform from a command-line interface. You can install **oc** on Linux, Windows, or macOS.

**IMPORTANT**

If you installed an earlier version of **oc**, you cannot use it to complete all of the commands in OpenShift Container Platform 4.10. Download and install the new version of **oc**.

#### Installing the OpenShift CLI on Linux

You can install the OpenShift CLI (**oc**) binary on Linux by using the following procedure.

#### Procedure



1. Navigate to the [OpenShift Container Platform downloads page](#) on the Red Hat Customer Portal.
2. Select the appropriate version in the **Version** drop-down menu.
3. Click **Download Now** next to the **OpenShift v4.10 Linux Client** entry and save the file.
4. Unpack the archive:

```
$ tar xvf <file>
```

5. Place the **oc** binary in a directory that is on your **PATH**.  
To check your **PATH**, execute the following command:

```
$ echo $PATH
```

After you install the OpenShift CLI, it is available using the **oc** command:

```
$ oc <command>
```

### Installing the OpenShift CLI on Windows

You can install the OpenShift CLI (**oc**) binary on Windows by using the following procedure.

#### Procedure

1. Navigate to the [OpenShift Container Platform downloads page](#) on the Red Hat Customer Portal.
2. Select the appropriate version in the **Version** drop-down menu.
3. Click **Download Now** next to the **OpenShift v4.10 Windows Client** entry and save the file.
4. Unzip the archive with a ZIP program.
5. Move the **oc** binary to a directory that is on your **PATH**.  
To check your **PATH**, open the command prompt and execute the following command:

```
C:\> path
```

After you install the OpenShift CLI, it is available using the **oc** command:

```
C:\> oc <command>
```

### Installing the OpenShift CLI on macOS

You can install the OpenShift CLI (**oc**) binary on macOS by using the following procedure.

#### Procedure

1. Navigate to the [OpenShift Container Platform downloads page](#) on the Red Hat Customer Portal.
2. Select the appropriate version in the **Version** drop-down menu.
3. Click **Download Now** next to the **OpenShift v4.10 MacOSX Client** entry and save the file.

4. Unpack and unzip the archive.
5. Move the **oc** binary to a directory on your PATH.  
To check your **PATH**, open a terminal and execute the following command:

```
$ echo $PATH
```

After you install the OpenShift CLI, it is available using the **oc** command:

```
$ oc <command>
```

### 5.5.9. Logging in to the cluster by using the CLI

You can log in to your cluster as a default system user by exporting the cluster **kubeconfig** file. The **kubeconfig** file contains information about the cluster that is used by the CLI to connect a client to the correct cluster and API server. The file is specific to a cluster and is created during OpenShift Container Platform installation.

#### Prerequisites

- You deployed an OpenShift Container Platform cluster.
- You installed the **oc** CLI.

#### Procedure

1. Export the **kubeadmin** credentials:

```
$ export KUBECONFIG=<installation_directory>/auth/kubeconfig 1
```

- 1** For **<installation\_directory>**, specify the path to the directory that you stored the installation files in.

2. Verify you can run **oc** commands successfully using the exported configuration:

```
$ oc whoami
```

#### Example output

```
system:admin
```

### 5.5.10. Logging in to the cluster by using the web console

The **kubeadmin** user exists by default after an OpenShift Container Platform installation. You can log in to your cluster as the **kubeadmin** user by using the OpenShift Container Platform web console.

#### Prerequisites

- You have access to the installation host.
- You completed a cluster installation and all cluster Operators are available.

## Procedure

1. Obtain the password for the **kubeadmin** user from the **kubeadmin-password** file on the installation host:

```
$ cat <installation_directory>/auth/kubeadmin-password
```

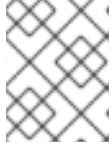

### NOTE

Alternatively, you can obtain the **kubeadmin** password from the **<installation\_directory>/openshift\_install.log** log file on the installation host.

2. List the OpenShift Container Platform web console route:

```
$ oc get routes -n openshift-console | grep 'console-openshift'
```

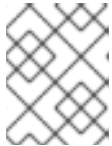

### NOTE

Alternatively, you can obtain the OpenShift Container Platform route from the **<installation\_directory>/openshift\_install.log** log file on the installation host.

## Example output

```
console    console-openshift-console.apps.<cluster_name>.<base_domain>    console
https    reencrypt/Redirect    None
```

3. Navigate to the route detailed in the output of the preceding command in a web browser and log in as the **kubeadmin** user.

## Additional resources

- See [Accessing the web console](#) for more details about accessing and understanding the OpenShift Container Platform web console.

### 5.5.11. Telemetry access for OpenShift Container Platform

In OpenShift Container Platform 4.10, the Telemetry service, which runs by default to provide metrics about cluster health and the success of updates, requires internet access. If your cluster is connected to the internet, Telemetry runs automatically, and your cluster is registered to [OpenShift Cluster Manager](#).

After you confirm that your [OpenShift Cluster Manager](#) inventory is correct, either maintained automatically by Telemetry or manually by using OpenShift Cluster Manager, [use subscription watch](#) to track your OpenShift Container Platform subscriptions at the account or multi-cluster level.

## Additional resources

- See [About remote health monitoring](#) for more information about the Telemetry service.

### 5.5.12. Next steps

- [Validating an installation.](#)

- [Customize your cluster](#).
- If necessary, you can [opt out of remote health reporting](#).
- If necessary, you can [remove cloud provider credentials](#).

## 5.6. INSTALLING A CLUSTER ON AWS WITH NETWORK CUSTOMIZATIONS

In OpenShift Container Platform version 4.10, you can install a cluster on Amazon Web Services (AWS) with customized network configuration options. By customizing your network configuration, your cluster can coexist with existing IP address allocations in your environment and integrate with existing MTU and VXLAN configurations.

You must set most of the network configuration parameters during installation, and you can modify only **kubeProxy** configuration parameters in a running cluster.

### 5.6.1. Prerequisites

- You reviewed details about the [OpenShift Container Platform installation and update](#) processes.
- You read the documentation on [selecting a cluster installation method and preparing it for users](#).
- You [configured an AWS account](#) to host the cluster.



#### IMPORTANT

If you have an AWS profile stored on your computer, it must not use a temporary session token that you generated while using a multi-factor authentication device. The cluster continues to use your current AWS credentials to create AWS resources for the entire life of the cluster, so you must use key-based, long-lived credentials. To generate appropriate keys, see [Managing Access Keys for IAM Users](#) in the AWS documentation. You can supply the keys when you run the installation program.

- If you use a firewall, you [configured it to allow the sites](#) that your cluster requires access to.
- If the cloud identity and access management (IAM) APIs are not accessible in your environment, or if you do not want to store an administrator-level credential secret in the **kube-system** namespace, you can [manually create and maintain IAM credentials](#).

### 5.6.2. Internet access for OpenShift Container Platform

In OpenShift Container Platform 4.10, you require access to the internet to install your cluster.

You must have internet access to:

- Access [OpenShift Cluster Manager](#) to download the installation program and perform subscription management. If the cluster has internet access and you do not disable Telemetry, that service automatically entitles your cluster.
- Access [Quay.io](#) to obtain the packages that are required to install your cluster.

- Obtain the packages that are required to perform cluster updates.



### IMPORTANT

If your cluster cannot have direct internet access, you can perform a restricted network installation on some types of infrastructure that you provision. During that process, you download the required content and use it to populate a mirror registry with the installation packages. With some installation types, the environment that you install your cluster in will not require internet access. Before you update the cluster, you update the content of the mirror registry.

### 5.6.3. Generating a key pair for cluster node SSH access

During an OpenShift Container Platform installation, you can provide an SSH public key to the installation program. The key is passed to the Red Hat Enterprise Linux CoreOS (RHCOS) nodes through their Ignition config files and is used to authenticate SSH access to the nodes. The key is added to the `~/.ssh/authorized_keys` list for the **core** user on each node, which enables password-less authentication.

After the key is passed to the nodes, you can use the key pair to SSH in to the RHCOS nodes as the user **core**. To access the nodes through SSH, the private key identity must be managed by SSH for your local user.

If you want to SSH in to your cluster nodes to perform installation debugging or disaster recovery, you must provide the SSH public key during the installation process. The `./openshift-install gather` command also requires the SSH public key to be in place on the cluster nodes.

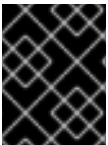

### IMPORTANT

Do not skip this procedure in production environments, where disaster recovery and debugging is required.

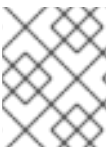

### NOTE

You must use a local key, not one that you configured with platform-specific approaches such as [AWS key pairs](#).

### Procedure

1. If you do not have an existing SSH key pair on your local machine to use for authentication onto your cluster nodes, create one. For example, on a computer that uses a Linux operating system, run the following command:

```
$ ssh-keygen -t ed25519 -N "" -f <path>/<file_name> 1
```

- 1 Specify the path and file name, such as `~/.ssh/id_ed25519`, of the new SSH key. If you have an existing key pair, ensure your public key is in the your `~/.ssh` directory.

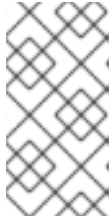
**NOTE**

If you plan to install an OpenShift Container Platform cluster that uses FIPS validated or Modules In Process cryptographic libraries on the **x86\_64** architecture, do not create a key that uses the **ed25519** algorithm. Instead, create a key that uses the **rsa** or **ecdsa** algorithm.

2. View the public SSH key:

```
$ cat <path>/<file_name>.pub
```

For example, run the following to view the `~/.ssh/id_ed25519.pub` public key:

```
$ cat ~/.ssh/id_ed25519.pub
```

3. Add the SSH private key identity to the SSH agent for your local user, if it has not already been added. SSH agent management of the key is required for password-less SSH authentication onto your cluster nodes, or if you want to use the `./openshift-install gather` command.

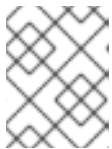
**NOTE**

On some distributions, default SSH private key identities such as `~/.ssh/id_rsa` and `~/.ssh/id_dsa` are managed automatically.

- a. If the **ssh-agent** process is not already running for your local user, start it as a background task:

```
$ eval "$(ssh-agent -s)"
```

**Example output**

```
Agent pid 31874
```

**NOTE**

If your cluster is in FIPS mode, only use FIPS-compliant algorithms to generate the SSH key. The key must be either RSA or ECDSA.

4. Add your SSH private key to the **ssh-agent**:

```
$ ssh-add <path>/<file_name> 1
```

- 1** Specify the path and file name for your SSH private key, such as `~/.ssh/id_ed25519`

**Example output**

```
Identity added: /home/<you>/<path>/<file_name> (<computer_name>)
```

**Next steps**

- When you install OpenShift Container Platform, provide the SSH public key to the installation program.

### 5.6.4. Obtaining the installation program

Before you install OpenShift Container Platform, download the installation file on a local computer.

#### Prerequisites

- You have a computer that runs Linux or macOS, with 500 MB of local disk space

#### Procedure

1. Access the [Infrastructure Provider](#) page on the OpenShift Cluster Manager site. If you have a Red Hat account, log in with your credentials. If you do not, create an account.
2. Select your infrastructure provider.
3. Navigate to the page for your installation type, download the installation program that corresponds with your host operating system and architecture, and place the file in the directory where you will store the installation configuration files.

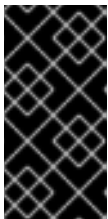

#### IMPORTANT

The installation program creates several files on the computer that you use to install your cluster. You must keep the installation program and the files that the installation program creates after you finish installing the cluster. Both files are required to delete the cluster.

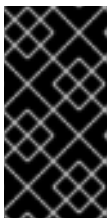

#### IMPORTANT

Deleting the files created by the installation program does not remove your cluster, even if the cluster failed during installation. To remove your cluster, complete the OpenShift Container Platform uninstallation procedures for your specific cloud provider.

4. Extract the installation program. For example, on a computer that uses a Linux operating system, run the following command:

```
$ tar -xvf openshift-install-linux.tar.gz
```

5. Download your installation [pull secret from the Red Hat OpenShift Cluster Manager](#). This pull secret allows you to authenticate with the services that are provided by the included authorities, including Quay.io, which serves the container images for OpenShift Container Platform components.

### 5.6.5. Network configuration phases

There are two phases prior to OpenShift Container Platform installation where you can customize the network configuration.

#### Phase 1

You can customize the following network-related fields in the **install-config.yaml** file before you create the manifest files:

- **networking.networkType**
- **networking.clusterNetwork**
- **networking.serviceNetwork**
- **networking.machineNetwork**

For more information on these fields, refer to *Installation configuration parameters*.



#### NOTE

Set the **networking.machineNetwork** to match the CIDR that the preferred NIC resides in.



#### IMPORTANT

The CIDR range **172.17.0.0/16** is reserved by libVirt. You cannot use this range or any range that overlaps with this range for any networks in your cluster.

## Phase 2

After creating the manifest files by running **openshift-install create manifests**, you can define a customized Cluster Network Operator manifest with only the fields you want to modify. You can use the manifest to specify advanced network configuration.

You cannot override the values specified in phase 1 in the **install-config.yaml** file during phase 2. However, you can further customize the cluster network provider during phase 2.

### 5.6.6. Creating the installation configuration file

You can customize the OpenShift Container Platform cluster you install on Amazon Web Services (AWS).

#### Prerequisites

- Obtain the OpenShift Container Platform installation program and the pull secret for your cluster.
- Obtain service principal permissions at the subscription level.

#### Procedure

1. Create the **install-config.yaml** file.
  - a. Change to the directory that contains the installation program and run the following command:

```
$. /openshift-install create install-config --dir <installation_directory> 1
```

- 1** For **<installation\_directory>**, specify the directory name to store the files that the installation program creates.



**IMPORTANT**

Specify an empty directory. Some installation assets, like bootstrap X.509 certificates have short expiration intervals, so you must not reuse an installation directory. If you want to reuse individual files from another cluster installation, you can copy them into your directory. However, the file names for the installation assets might change between releases. Use caution when copying installation files from an earlier OpenShift Container Platform version.

- b. At the prompts, provide the configuration details for your cloud:
  - i. Optional: Select an SSH key to use to access your cluster machines.

**NOTE**

For production OpenShift Container Platform clusters on which you want to perform installation debugging or disaster recovery, specify an SSH key that your **ssh-agent** process uses.

- ii. Select **AWS** as the platform to target.
  - iii. If you do not have an Amazon Web Services (AWS) profile stored on your computer, enter the AWS access key ID and secret access key for the user that you configured to run the installation program.
  - iv. Select the AWS region to deploy the cluster to.
  - v. Select the base domain for the Route 53 service that you configured for your cluster.
  - vi. Enter a descriptive name for your cluster.
  - vii. Paste the [pull secret from the Red Hat OpenShift Cluster Manager](#) .
2. Modify the **install-config.yaml** file. You can find more information about the available parameters in the "Installation configuration parameters" section.
  3. Back up the **install-config.yaml** file so that you can use it to install multiple clusters.

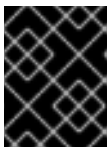
**IMPORTANT**

The **install-config.yaml** file is consumed during the installation process. If you want to reuse the file, you must back it up now.

**5.6.6.1. Installation configuration parameters**

Before you deploy an OpenShift Container Platform cluster, you provide parameter values to describe your account on the cloud platform that hosts your cluster and optionally customize your cluster's platform. When you create the **install-config.yaml** installation configuration file, you provide values for the required parameters through the command line. If you customize your cluster, you can modify the **install-config.yaml** file to provide more details about the platform.

**NOTE**

After installation, you cannot modify these parameters in the **install-config.yaml** file.

## 5.6.6.1.1. Required configuration parameters

Required installation configuration parameters are described in the following table:

Table 5.6. Required parameters

Parameter	Description	Values
<b>apiVersion</b>	The API version for the <b>install-config.yaml</b> content. The current version is <b>v1</b> . The installer may also support older API versions.	String
<b>baseDomain</b>	The base domain of your cloud provider. The base domain is used to create routes to your OpenShift Container Platform cluster components. The full DNS name for your cluster is a combination of the <b>baseDomain</b> and <b>metadata.name</b> parameter values that uses the <b>&lt;metadata.name&gt;.&lt;baseDomain&gt;</b> format.	A fully-qualified domain or subdomain name, such as <b>example.com</b> .
<b>metadata</b>	Kubernetes resource <b>ObjectMeta</b> , from which only the <b>name</b> parameter is consumed.	Object
<b>metadata.name</b>	The name of the cluster. DNS records for the cluster are all subdomains of <b>{{.metadata.name}}</b> . <b>{{.baseDomain}}</b> .	String of lowercase letters, hyphens (-), and periods (.), such as <b>dev</b> .
<b>platform</b>	The configuration for the specific platform upon which to perform the installation: <b>alibabacloud</b> , <b>aws</b> , <b>baremetal</b> , <b>azure</b> , <b>gcp</b> , <b>ibmcloud</b> , <b>openstack</b> , <b>ovirt</b> , <b>vsphere</b> , or <b>{}</b> . For additional information about <b>platform.&lt;platform&gt;</b> parameters, consult the table for your specific platform that follows.	Object

Parameter	Description	Values
<b>pullSecret</b>	Get a <a href="#">pull secret from the Red Hat OpenShift Cluster Manager</a> to authenticate downloading container images for OpenShift Container Platform components from services such as Quay.io.	<pre>{   "auths":{     "cloud.openshift.com":{       "auth":"b3Blb=",       "email":"you@example.com"     },     "quay.io":{       "auth":"b3Blb=",       "email":"you@example.com"     }   } }</pre>

#### 5.6.6.1.2. Network configuration parameters

You can customize your installation configuration based on the requirements of your existing network infrastructure. For example, you can expand the IP address block for the cluster network or provide different IP address blocks than the defaults.

Only IPv4 addresses are supported.

Table 5.7. Network parameters

Parameter	Description	Values
<b>networking</b>	The configuration for the cluster network.	Object  <div style="margin-left: 20px;"> <p><b>NOTE</b></p> <p>You cannot modify parameters specified by the <b>networking</b> object after installation.</p> </div>
<b>networking.networkType</b>	The cluster network provider Container Network Interface (CNI) plugin to install.	Either <b>OpenShiftSDN</b> or <b>OVNKubernetes</b> . <b>OpenShiftSDN</b> is a CNI provider for all-Linux networks. <b>OVNKubernetes</b> is a CNI provider for Linux networks and hybrid networks that contain both Linux and Windows servers. The default value is <b>OpenShiftSDN</b> .

Parameter	Description	Values
<b>networking.clusterNetwork</b>	<p>The IP address blocks for pods.</p> <p>The default value is <b>10.128.0.0/14</b> with a host prefix of <b>/23</b>.</p> <p>If you specify multiple IP address blocks, the blocks must not overlap.</p>	<p>An array of objects. For example:</p> <pre>networking:   clusterNetwork:     - cidr: 10.128.0.0/14       hostPrefix: 23</pre>
<b>networking.clusterNetwork.cidr</b>	<p>Required if you use <b>networking.clusterNetwork</b>. An IP address block.</p> <p>An IPv4 network.</p>	<p>An IP address block in Classless Inter-Domain Routing (CIDR) notation. The prefix length for an IPv4 block is between <b>0</b> and <b>32</b>.</p>
<b>networking.clusterNetwork.hostPrefix</b>	<p>The subnet prefix length to assign to each individual node. For example, if <b>hostPrefix</b> is set to <b>23</b> then each node is assigned a <b>/23</b> subnet out of the given <b>cidr</b>. A <b>hostPrefix</b> value of <b>23</b> provides 510 (<math>2^{(32 - 23)} - 2</math>) pod IP addresses.</p>	<p>A subnet prefix.</p> <p>The default value is <b>23</b>.</p>
<b>networking.serviceNetwork</b>	<p>The IP address block for services. The default value is <b>172.30.0.0/16</b>.</p> <p>The OpenShift SDN and OVN-Kubernetes network providers support only a single IP address block for the service network.</p>	<p>An array with an IP address block in CIDR format. For example:</p> <pre>networking:   serviceNetwork:     - 172.30.0.0/16</pre>
<b>networking.machineNetwork</b>	<p>The IP address blocks for machines.</p> <p>If you specify multiple IP address blocks, the blocks must not overlap.</p>	<p>An array of objects. For example:</p> <pre>networking:   machineNetwork:     - cidr: 10.0.0.0/16</pre>
<b>networking.machineNetwork.cidr</b>	<p>Required if you use <b>networking.machineNetwork</b>. An IP address block. The default value is <b>10.0.0.0/16</b> for all platforms other than libvirt. For libvirt, the default value is <b>192.168.126.0/24</b>.</p>	<p>An IP network block in CIDR notation.</p> <p>For example, <b>10.0.0.0/16</b>.</p> <div style="display: flex; align-items: flex-start;">  <div> <p><b>NOTE</b></p> <p>Set the <b>networking.machineNetwork</b> to match the CIDR that the preferred NIC resides in.</p> </div> </div>

### 5.6.6.1.3. Optional configuration parameters



Optional installation configuration parameters are described in the following table:

**Table 5.8. Optional parameters**

Parameter	Description	Values
<b>additionalTrustBundle</b>	A PEM-encoded X.509 certificate bundle that is added to the nodes' trusted certificate store. This trust bundle may also be used when a proxy has been configured.	String
<b>cgroupsV2</b>	Enables <a href="#">Linux control groups version 2</a> (cgroups v2) on specific nodes in your cluster. The OpenShift Container Platform process for enabling cgroups v2 disables all cgroup version 1 controllers and hierarchies. The OpenShift Container Platform cgroups version 2 feature is in Developer Preview and is not supported by Red Hat at this time.	<b>true</b>
<b>compute</b>	The configuration for the machines that comprise the compute nodes.	Array of <b>MachinePool</b> objects.
<b>compute.architecture</b>	Determines the instruction set architecture of the machines in the pool. Currently, clusters with varied architectures are not supported. All pools must specify the same architecture. Valid values are <b>amd64</b> and <b>arm64</b> . See <i>Supported installation methods for different platforms</i> in <i>Installing</i> documentation for information about instance availability.	String

Parameter	Description	Values
<b>compute.hyperthreading</b>	<p>Whether to enable or disable simultaneous multithreading, or <b>hyperthreading</b>, on compute machines. By default, simultaneous multithreading is enabled to increase the performance of your machines' cores.</p> <div style="display: flex; align-items: center;">  <div> <p><b>IMPORTANT</b></p> <p>If you disable simultaneous multithreading, ensure that your capacity planning accounts for the dramatically decreased machine performance.</p> </div> </div>	<b>Enabled</b> or <b>Disabled</b>
<b>compute.name</b>	Required if you use <b>compute</b> . The name of the machine pool.	<b>worker</b>
<b>compute.platform</b>	Required if you use <b>compute</b> . Use this parameter to specify the cloud provider to host the worker machines. This parameter value must match the <b>controlPlane.platform</b> parameter value.	<b>alibabacloud, aws, azure, gcp, ibmcloud, openstack, ovirt, vsphere, or {}</b>
<b>compute.replicas</b>	The number of compute machines, which are also known as worker machines, to provision.	A positive integer greater than or equal to <b>2</b> . The default value is <b>3</b> .
<b>controlPlane</b>	The configuration for the machines that comprise the control plane.	Array of <b>MachinePool</b> objects.

Parameter	Description	Values
<b>controlPlane.architecture</b>	Determines the instruction set architecture of the machines in the pool. Currently, clusters with varied architectures are not supported. All pools must specify the same architecture. Valid values are <b>amd64</b> and <b>arm64</b> . See <i>Supported installation methods for different platforms</i> in <i>Installing</i> documentation for information about instance availability.	String
<b>controlPlane.hypertreading</b>	Whether to enable or disable simultaneous multithreading, or <b>hyperthreading</b> , on control plane machines. By default, simultaneous multithreading is enabled to increase the performance of your machines' cores.   <b>IMPORTANT</b> If you disable simultaneous multithreading, ensure that your capacity planning accounts for the dramatically decreased machine performance.	<b>Enabled</b> or <b>Disabled</b>
<b>controlPlane.name</b>	Required if you use <b>controlPlane</b> . The name of the machine pool.	<b>master</b>
<b>controlPlane.platform</b>	Required if you use <b>controlPlane</b> . Use this parameter to specify the cloud provider that hosts the control plane machines. This parameter value must match the <b>compute.platform</b> parameter value.	<b>alibabacloud, aws, azure, gcp, ibmcloud, openstack, ovirt, vsphere, or {}</b>
<b>controlPlane.replicas</b>	The number of control plane machines to provision.	The only supported value is <b>3</b> , which is the default value.

Parameter	Description	Values
<b>credentialsMode</b>	<p>The Cloud Credential Operator (CCO) mode. If no mode is specified, the CCO dynamically tries to determine the capabilities of the provided credentials, with a preference for mint mode on the platforms where multiple modes are supported.</p> <div data-bbox="485 512 595 862" style="border: 1px solid black; padding: 5px; margin-bottom: 10px;">  </div> <p><b>NOTE</b></p> <p>Not all CCO modes are supported for all cloud providers. For more information on CCO modes, see the <i>Cloud Credential Operator</i> entry in the <i>Cluster Operators reference content</i>.</p> <div data-bbox="485 909 595 1258" style="border: 1px solid black; padding: 5px;">  </div> <p><b>NOTE</b></p> <p>If your AWS account has service control policies (SCP) enabled, you must configure the <b>credentialsMode</b> parameter to <b>Mint</b>, <b>Passthrough</b> or <b>Manual</b>.</p>	<b>Mint, Passthrough, Manual</b> or an empty string ("").



Parameter	Description	Values
<b>fips</b>	<p>Enable or disable FIPS mode. The default is <b>false</b> (disabled). If FIPS mode is enabled, the Red Hat Enterprise Linux CoreOS (RHCOS) machines that OpenShift Container Platform runs on bypass the default Kubernetes cryptography suite and use the cryptography modules that are provided with RHCOS instead.</p> <div data-bbox="486 584 592 1361" style="background-color: black; color: white; padding: 5px;"> <p><b>IMPORTANT</b></p> <p>To enable FIPS mode for your cluster, you must run the installation program from a Red Hat Enterprise Linux (RHEL) computer configured to operate in FIPS mode. For more information about configuring FIPS mode on RHEL, see <a href="#">Installing the system in FIPS mode</a>. The use of FIPS validated or Modules In Process cryptographic libraries is only supported on OpenShift Container Platform deployments on the <b>x86_64</b> architecture.</p> </div> <div data-bbox="486 1406 592 1603" style="background-color: #f0f0f0; padding: 5px;"> <p><b>NOTE</b></p> <p>If you are using Azure File storage, you cannot enable FIPS mode.</p> </div>	<b>false</b> or <b>true</b>
<b>imageContentSources</b>	Sources and repositories for the release-image content.	Array of objects. Includes a <b>source</b> and, optionally, <b>mirrors</b> , as described in the following rows of this table.

Parameter	Description	Values
<b>imageContentSources.source</b>	Required if you use <b>imageContentSources</b> . Specify the repository that users refer to, for example, in image pull specifications.	String
<b>imageContentSources.mirrors</b>	Specify one or more repositories that may also contain the same images.	Array of strings
<b>publish</b>	How to publish or expose the user-facing endpoints of your cluster, such as the Kubernetes API, OpenShift routes.	<b>Internal</b> or <b>External</b> . To deploy a private cluster, which cannot be accessed from the internet, set <b>publish</b> to <b>Internal</b> . The default value is <b>External</b> .
<b>sshKey</b>	<p>The SSH key or keys to authenticate access your cluster machines.</p>  <p><b>NOTE</b></p> <p>For production OpenShift Container Platform clusters on which you want to perform installation debugging or disaster recovery, specify an SSH key that your <b>ssh-agent</b> process uses.</p>	<p>One or more keys. For example:</p> <pre>sshKey:   &lt;key1&gt;   &lt;key2&gt;   &lt;key3&gt;</pre>

#### 5.6.6.1.4. Optional AWS configuration parameters

Optional AWS configuration parameters are described in the following table:

Table 5.9. Optional AWS parameters

Parameter	Description	Values
-----------	-------------	--------

Parameter	Description	Values
<b>compute.platform.aws.amiID</b>	The AWS AMI used to boot compute machines for the cluster. This is required for regions that require a custom RHCOS AMI.	Any published or custom RHCOS AMI that belongs to the set AWS region. See <i>RHCOS AMIs for AWS infrastructure</i> for available AMI IDs.
<b>compute.platform.aws.iamRole</b>	A pre-existing AWS IAM role applied to the compute machine pool instance profiles. You can use these fields to match naming schemes and include predefined permissions boundaries for your IAM roles. If undefined, the installation program creates a new IAM role.	The name of a valid AWS IAM role.
<b>compute.platform.aws.rootVolume.iops</b>	The Input/Output Operations Per Second (IOPS) that is reserved for the root volume.	Integer, for example <b>4000</b> .
<b>compute.platform.aws.rootVolume.size</b>	The size in GiB of the root volume.	Integer, for example <b>500</b> .
<b>compute.platform.aws.rootVolume.type</b>	The type of the root volume.	Valid <a href="#">AWS EBS volume type</a> , such as <b>io1</b> .
<b>compute.platform.aws.rootVolume.kmsKeyARN</b>	The Amazon Resource Name (key ARN) of a KMS key. This is required to encrypt OS volumes of worker nodes with a specific KMS key.	Valid <a href="#">key ID</a> or the <a href="#">key ARN</a>
<b>compute.platform.aws.type</b>	The EC2 instance type for the compute machines.	Valid AWS instance type, such as <b>m4.2xlarge</b> . See the <b>Supported AWS machine types</b> table that follows.
<b>compute.platform.aws.zones</b>	The availability zones where the installation program creates machines for the compute machine pool. If you provide your own VPC, you must provide a subnet in that availability zone.	A list of valid AWS availability zones, such as <b>us-east-1c</b> , in a <a href="#">YAML sequence</a> .

Parameter	Description	Values
<b>compute.aws.region</b>	The AWS region that the installation program creates compute resources in.	Any valid <a href="#">AWS region</a> , such as <b>us-east-1</b> .   <b>IMPORTANT</b>  When running on ARM based AWS instances, ensure that you enter a region where AWS Graviton processors are available. See <a href="#">Global availability map</a> in the AWS documentation.
<b>controlPlane.platform.aws.amiID</b>	The AWS AMI used to boot control plane machines for the cluster. This is required for regions that require a custom RHCOS AMI.	Any published or custom RHCOS AMI that belongs to the set AWS region. See <i>RHCOS AMIs for AWS infrastructure</i> for available AMI IDs.
<b>controlPlane.platform.aws.iamRole</b>	A pre-existing AWS IAM role applied to the control plane machine pool instance profiles. You can use these fields to match naming schemes and include predefined permissions boundaries for your IAM roles. If undefined, the installation program creates a new IAM role.	The name of a valid AWS IAM role.
<b>controlPlane.platform.aws.rootVolume.kmsKeyARN</b>	The Amazon Resource Name (key ARN) of a KMS key. This is required to encrypt OS volumes of control plane nodes with a specific KMS key.	Valid <a href="#">key ID</a> and the <a href="#">key ARN</a>
<b>controlPlane.platform.aws.type</b>	The EC2 instance type for the control plane machines.	Valid AWS instance type, such as <b>m6i.xlarge</b> . See the <b>Supported AWS machine types</b> table that follows.
<b>controlPlane.platform.aws.zones</b>	The availability zones where the installation program creates machines for the control plane machine pool.	A list of valid AWS availability zones, such as <b>us-east-1c</b> , in a <a href="#">YAML sequence</a> .
<b>controlPlane.aws.region</b>	The AWS region that the installation program creates control plane resources in.	Valid <a href="#">AWS region</a> , such as <b>us-east-1</b> .

Parameter	Description	Values
<b>platform.aws.amiID</b>	The AWS AMI used to boot all machines for the cluster. If set, the AMI must belong to the same region as the cluster. This is required for regions that require a custom RHCOS AMI.	Any published or custom RHCOS AMI that belongs to the set AWS region. See <i>RHCOS AMIs for AWS infrastructure</i> for available AMI IDs.
<b>platform.aws.hostedZone</b>	An existing Route 53 private hosted zone for the cluster. You can only use a pre-existing hosted zone when also supplying your own VPC. The hosted zone must already be associated with the user-provided VPC before installation. Also, the domain of the hosted zone must be the cluster domain or a parent of the cluster domain. If undefined, the installation program creates a new hosted zone.	String, for example <b>Z3URY6TWQ91KVV</b> .
<b>platform.aws.serviceEndpoints.name</b>	The AWS service endpoint name. Custom endpoints are only required for cases where alternative AWS endpoints, like FIPS, must be used. Custom API endpoints can be specified for EC2, S3, IAM, Elastic Load Balancing, Tagging, Route 53, and STS AWS services.	Valid <a href="#">AWS service endpoint</a> name.
<b>platform.aws.serviceEndpoints.url</b>	The AWS service endpoint URL. The URL must use the <b>https</b> protocol and the host must trust the certificate.	Valid <a href="#">AWS service endpoint</a> URL.
<b>platform.aws.userTags</b>	A map of keys and values that the installation program adds as tags to all resources that it creates.	Any valid YAML map, such as key value pairs in the <b>&lt;key&gt;: &lt;value&gt;</b> format. For more information about AWS tags, see <a href="#">Tagging Your Amazon EC2 Resources</a> in the AWS documentation.

Parameter	Description	Values
<b>platform.aws.subnets</b>	If you provide the VPC instead of allowing the installation program to create the VPC for you, specify the subnet for the cluster to use. The subnet must be part of the same <b>machineNetwork[].cidr</b> ranges that you specify. For a standard cluster, specify a public and a private subnet for each availability zone. For a private cluster, specify a private subnet for each availability zone.	Valid subnet IDs.

### 5.6.6.2. Minimum resource requirements for cluster installation

Each cluster machine must meet the following minimum requirements:

**Table 5.10. Minimum resource requirements**

Machine	Operating System	vCPU [1]	Virtual RAM	Storage	IOPS [2]
Bootstrap	RHCOS	4	16 GB	100 GB	300
Control plane	RHCOS	4	16 GB	100 GB	300
Compute	RHCOS, RHEL 8.4, or RHEL 8.5 [3]	2	8 GB	100 GB	300

1. One vCPU is equivalent to one physical core when simultaneous multithreading (SMT), or hyperthreading, is not enabled. When enabled, use the following formula to calculate the corresponding ratio:  $(\text{threads per core} \times \text{cores}) \times \text{sockets} = \text{vCPUs}$ .
2. OpenShift Container Platform and Kubernetes are sensitive to disk performance, and faster storage is recommended, particularly for etcd on the control plane nodes which require a 10 ms p99 fsync duration. Note that on many cloud platforms, storage size and IOPS scale together, so you might need to over-allocate storage volume to obtain sufficient performance.
3. As with all user-provisioned installations, if you choose to use RHEL compute machines in your cluster, you take responsibility for all operating system life cycle management and maintenance, including performing system updates, applying patches, and completing all other required tasks. Use of RHEL 7 compute machines is deprecated and has been removed in OpenShift Container Platform 4.10 and later.

If an instance type for your platform meets the minimum requirements for cluster machines, it is supported to use in OpenShift Container Platform.

### 5.6.6.3. Tested instance types for AWS

The following Amazon Web Services (AWS) instance types have been tested with OpenShift Container Platform.



#### NOTE

Use the machine types included in the following charts for your AWS instances. If you use an instance type that is not listed in the chart, ensure that the instance size you use matches the minimum resource requirements that are listed in "Minimum resource requirements for cluster installation".

#### Example 5.18. Machine types based on 64-bit x86 architecture

- **c4.\***
- **c5.\***
- **c5a.\***
- **i3.\***
- **m4.\***
- **m5.\***
- **m5a.\***
- **m6i.\***
- **r4.\***
- **r5.\***
- **r5a.\***
- **r6i.\***
- **t3.\***
- **t3a.\***

### 5.6.6.4. Tested instance types for AWS on 64-bit ARM infrastructures

The following Amazon Web Services (AWS) ARM64 instance types have been tested with OpenShift Container Platform.



#### NOTE

Use the machine types included in the following charts for your AWS ARM instances. If you use an instance type that is not listed in the chart, ensure that the instance size you use matches the minimum resource requirements that are listed in "Minimum resource requirements for cluster installation".

**Example 5.19. Machine types based on 64-bit ARM architecture**

- **c6g.\***
- **m6g.\***

**5.6.6.5. Sample customized install-config.yaml file for AWS**

You can customize the installation configuration file (**install-config.yaml**) to specify more details about your OpenShift Container Platform cluster's platform or modify the values of the required parameters.

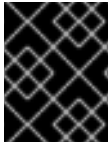
**IMPORTANT**

This sample YAML file is provided for reference only. You must obtain your **install-config.yaml** file by using the installation program and modify it.

```

apiVersion: v1
baseDomain: example.com 1
credentialsMode: Mint 2
controlPlane: 3 4
  hyperthreading: Enabled 5
  name: master
  platform:
    aws:
      zones:
      - us-west-2a
      - us-west-2b
      rootVolume:
        iops: 4000
        size: 500
        type: io1 6
        type: m6i.xlarge
      replicas: 3
compute: 7
- hyperthreading: Enabled 8
  name: worker
  platform:
    aws:
      rootVolume:
        iops: 2000
        size: 500
        type: io1 9
        type: c5.4xlarge
      zones:
      - us-west-2c
      replicas: 3
metadata:
  name: test-cluster 10
networking: 11
  clusterNetwork:
  - cidr: 10.128.0.0/14
  hostPrefix: 23

```



```

machineNetwork:
- cidr: 10.0.0.0/16
networkType: OpenShiftSDN
serviceNetwork:
- 172.30.0.0/16
platform:
aws:
region: us-west-2 12
userTags:
adminContact: jdoe
costCenter: 7536
amiID: ami-96c6f8f7 13
serviceEndpoints: 14
- name: ec2
url: https://vpce-id.ec2.us-west-2.vpce.amazonaws.com
fips: false 15
sshKey: ssh-ed25519 AAAA... 16
pullSecret: '{"auths": ...}' 17

```

- 1 10 12 17 Required. The installation program prompts you for this value.
- 2 Optional: Add this parameter to force the Cloud Credential Operator (CCO) to use the specified mode, instead of having the CCO dynamically try to determine the capabilities of the credentials. For details about CCO modes, see the *Cloud Credential Operator* entry in the *Red Hat Operators reference* content.
- 3 7 11 If you do not provide these parameters and values, the installation program provides the default value.
- 4 The **controlPlane** section is a single mapping, but the **compute** section is a sequence of mappings. To meet the requirements of the different data structures, the first line of the **compute** section must begin with a hyphen, -, and the first line of the **controlPlane** section must not. Only one control plane pool is used.
- 5 8 Whether to enable or disable simultaneous multithreading, or **hyperthreading**. By default, simultaneous multithreading is enabled to increase the performance of your machines' cores. You can disable it by setting the parameter value to **Disabled**. If you disable simultaneous multithreading in some cluster machines, you must disable it in all cluster machines.



### IMPORTANT

If you disable simultaneous multithreading, ensure that your capacity planning accounts for the dramatically decreased machine performance. Use larger instance types, such as **m4.2xlarge** or **m5.2xlarge**, for your machines if you disable simultaneous multithreading.

- 6 9 To configure faster storage for etcd, especially for larger clusters, set the storage type as **io1** and set **iops** to **2000**.
- 13 The ID of the AMI used to boot machines for the cluster. If set, the AMI must belong to the same region as the cluster.
- 14 The AWS service endpoints. Custom endpoints are required when installing to an unknown AWS region. The endpoint URL must use the **https** protocol and the host must trust the certificate.

- 15 Whether to enable or disable FIPS mode. By default, FIPS mode is not enabled. If FIPS mode is enabled, the Red Hat Enterprise Linux CoreOS (RHCOS) machines that OpenShift Container



### IMPORTANT

To enable FIPS mode for your cluster, you must run the installation program from a Red Hat Enterprise Linux (RHEL) computer configured to operate in FIPS mode. For more information about configuring FIPS mode on RHEL, see [Installing the system in FIPS mode](#). The use of FIPS validated or Modules In Process cryptographic libraries is only supported on OpenShift Container Platform deployments on the **x86\_64** architecture.

- 16 You can optionally provide the **sshKey** value that you use to access the machines in your cluster.



### NOTE

For production OpenShift Container Platform clusters on which you want to perform installation debugging or disaster recovery, specify an SSH key that your **ssh-agent** process uses.

#### 5.6.6.6. Configuring the cluster-wide proxy during installation

Production environments can deny direct access to the internet and instead have an HTTP or HTTPS proxy available. You can configure a new OpenShift Container Platform cluster to use a proxy by configuring the proxy settings in the **install-config.yaml** file.

#### Prerequisites

- You have an existing **install-config.yaml** file.
- You reviewed the sites that your cluster requires access to and determined whether any of them need to bypass the proxy. By default, all cluster egress traffic is proxied, including calls to hosting cloud provider APIs. You added sites to the **Proxy** object's **spec.noProxy** field to bypass the proxy if necessary.



### NOTE

The **Proxy** object **status.noProxy** field is populated with the values of the **networking.machineNetwork[].cidr**, **networking.clusterNetwork[].cidr**, and **networking.serviceNetwork[]** fields from your installation configuration.

For installations on Amazon Web Services (AWS), Google Cloud Platform (GCP), Microsoft Azure, and Red Hat OpenStack Platform (RHOSP), the **Proxy** object **status.noProxy** field is also populated with the instance metadata endpoint (**169.254.169.254**).

- You have added the **ec2.<region>.amazonaws.com**, **elasticloadbalancing.<region>.amazonaws.com**, and **s3.<region>.amazonaws.com** endpoints to your VPC endpoint. These endpoints are required to complete requests from the nodes to the AWS EC2 API. Because the proxy works on the container level, not the node level, you must route these requests to the AWS EC2 API through the AWS private network. Adding the public IP address of the EC2 API to your allowlist in your proxy server is not sufficient.

## Procedure

1. Edit your **install-config.yaml** file and add the proxy settings. For example:

```

apiVersion: v1
baseDomain: my.domain.com
proxy:
  httpProxy: http://<username>:<pswd>@<ip>:<port> 1
  httpsProxy: https://<username>:<pswd>@<ip>:<port> 2
  noProxy: example.com 3
  additionalTrustBundle: | 4
    -----BEGIN CERTIFICATE-----
    <MY_TRUSTED_CA_CERT>
    -----END CERTIFICATE-----
  ...

```

- 1 A proxy URL to use for creating HTTP connections outside the cluster. The URL scheme must be **http**.
- 2 A proxy URL to use for creating HTTPS connections outside the cluster.
- 3 A comma-separated list of destination domain names, IP addresses, or other network CIDRs to exclude from proxying. Preface a domain with **.** to match subdomains only. For example, **.y.com** matches **x.y.com**, but not **y.com**. Use **\*** to bypass the proxy for all destinations.
- 4 If provided, the installation program generates a config map that is named **user-ca-bundle** in the **openshift-config** namespace that contains one or more additional CA certificates that are required for proxying HTTPS connections. The Cluster Network Operator then creates a **trusted-ca-bundle** config map that merges these contents with the Red Hat Enterprise Linux CoreOS (RHCOS) trust bundle, and this config map is referenced in the **trustedCA** field of the **Proxy** object. The **additionalTrustBundle** field is required unless the proxy's identity certificate is signed by an authority from the RHCOS trust bundle.



### NOTE

The installation program does not support the proxy **readinessEndpoints** field.

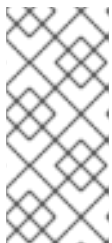

### NOTE

If the installer times out, restart and then complete the deployment by using the **wait-for** command of the installer. For example:

```
$ ./openshift-install wait-for install-complete --log-level debug
```

2. Save the file and reference it when installing OpenShift Container Platform.

The installation program creates a cluster-wide proxy that is named **cluster** that uses the proxy settings in the provided **install-config.yaml** file. If no proxy settings are provided, a **cluster Proxy** object is still created, but it will have a nil **spec**.

**NOTE**

Only the **Proxy** object named **cluster** is supported, and no additional proxies can be created.

### 5.6.7. Cluster Network Operator configuration

The configuration for the cluster network is specified as part of the Cluster Network Operator (CNO) configuration and stored in a custom resource (CR) object that is named **cluster**. The CR specifies the fields for the **Network** API in the **operator.openshift.io** API group.

The CNO configuration inherits the following fields during cluster installation from the **Network** API in the **Network.config.openshift.io** API group and these fields cannot be changed:

#### **clusterNetwork**

IP address pools from which pod IP addresses are allocated.

#### **serviceNetwork**

IP address pool for services.

#### **defaultNetwork.type**

Cluster network provider, such as OpenShift SDN or OVN-Kubernetes.

You can specify the cluster network provider configuration for your cluster by setting the fields for the **defaultNetwork** object in the CNO object named **cluster**.

#### 5.6.7.1. Cluster Network Operator configuration object

The fields for the Cluster Network Operator (CNO) are described in the following table:

**Table 5.11. Cluster Network Operator configuration object**

Field	Type	Description
<b>metadata.name</b>	<b>string</b>	The name of the CNO object. This name is always <b>cluster</b> .
<b>spec.clusterNetwork</b>	<b>array</b>	<p>A list specifying the blocks of IP addresses from which pod IP addresses are allocated and the subnet prefix length assigned to each individual node in the cluster. For example:</p> <pre>spec:   clusterNetwork:   - cidr: 10.128.0.0/19     hostPrefix: 23   - cidr: 10.128.32.0/19     hostPrefix: 23</pre> <p>You can customize this field only in the <b>install-config.yaml</b> file before you create the manifests. The value is read-only in the manifest file.</p>

Field	Type	Description
<b>spec.serviceNetwork</b>	<b>array</b>	<p>A block of IP addresses for services. The OpenShift SDN and OVN-Kubernetes Container Network Interface (CNI) network providers support only a single IP address block for the service network. For example:</p> <pre>spec:   serviceNetwork:   - 172.30.0.0/14</pre> <p>You can customize this field only in the <b>install-config.yaml</b> file before you create the manifests. The value is read-only in the manifest file.</p>
<b>spec.defaultNetwork</b>	<b>object</b>	Configures the Container Network Interface (CNI) cluster network provider for the cluster network.
<b>spec.kubeProxyConfig</b>	<b>object</b>	The fields for this object specify the kube-proxy configuration. If you are using the OVN-Kubernetes cluster network provider, the kube-proxy configuration has no effect.

#### defaultNetwork object configuration

The values for the **defaultNetwork** object are defined in the following table:

Table 5.12. defaultNetwork object

Field	Type	Description
<b>type</b>	<b>string</b>	<p>Either <b>OpenShiftSDN</b> or <b>OVNKubernetes</b>. The cluster network provider is selected during installation. This value cannot be changed after cluster installation.</p> <div style="display: flex; align-items: flex-start;"> <div style="flex: 1;">  </div> <div style="flex: 2;"> <p><b>NOTE</b></p> <p>OpenShift Container Platform uses the OpenShift SDN Container Network Interface (CNI) cluster network provider by default.</p> </div> </div>
<b>openshiftSDNConfig</b>	<b>object</b>	This object is only valid for the OpenShift SDN cluster network provider.
<b>ovnKubernetesConfig</b>	<b>object</b>	This object is only valid for the OVN-Kubernetes cluster network provider.

#### Configuration for the OpenShift SDN CNI cluster network provider

The following table describes the configuration fields for the OpenShift SDN Container Network Interface (CNI) cluster network provider.

Table 5.13. openshiftSDNConfig object

Field	Type	Description
<b>mode</b>	<b>string</b>	<p>Configures the network isolation mode for OpenShift SDN. The default value is <b>NetworkPolicy</b>.</p> <p>The values <b>Multitenant</b> and <b>Subnet</b> are available for backwards compatibility with OpenShift Container Platform 3.x but are not recommended. This value cannot be changed after cluster installation.</p>
<b>mtu</b>	<b>integer</b>	<p>The maximum transmission unit (MTU) for the VXLAN overlay network. This is detected automatically based on the MTU of the primary network interface. You do not normally need to override the detected MTU.</p> <p>If the auto-detected value is not what you expect it to be, confirm that the MTU on the primary network interface on your nodes is correct. You cannot use this option to change the MTU value of the primary network interface on the nodes.</p> <p>If your cluster requires different MTU values for different nodes, you must set this value to <b>50</b> less than the lowest MTU value in your cluster. For example, if some nodes in your cluster have an MTU of <b>9001</b>, and some have an MTU of <b>1500</b>, you must set this value to <b>1450</b>.</p> <p>This value cannot be changed after cluster installation.</p>
<b>vxlanPort</b>	<b>integer</b>	<p>The port to use for all VXLAN packets. The default value is <b>4789</b>. This value cannot be changed after cluster installation.</p> <p>If you are running in a virtualized environment with existing nodes that are part of another VXLAN network, then you might be required to change this. For example, when running an OpenShift SDN overlay on top of VMware NSX-T, you must select an alternate port for the VXLAN, because both SDNs use the same default VXLAN port number.</p> <p>On Amazon Web Services (AWS), you can select an alternate port for the VXLAN between port <b>9000</b> and port <b>9999</b>.</p>

### Example OpenShift SDN configuration

```
defaultNetwork:
  type: OpenShiftSDN
  openshiftSDNConfig:
    mode: NetworkPolicy
    mtu: 1450
    vxlanPort: 4789
```

### Configuration for the OVN-Kubernetes CNI cluster network provider

The following table describes the configuration fields for the OVN-Kubernetes CNI cluster network provider.

Table 5.14. `ovnKubernetesConfig` object

Field	Type	Description
<code>mtu</code>	<code>integer</code>	<p>The maximum transmission unit (MTU) for the Geneve (Generic Network Virtualization Encapsulation) overlay network. This is detected automatically based on the MTU of the primary network interface. You do not normally need to override the detected MTU.</p> <p>If the auto-detected value is not what you expect it to be, confirm that the MTU on the primary network interface on your nodes is correct. You cannot use this option to change the MTU value of the primary network interface on the nodes.</p> <p>If your cluster requires different MTU values for different nodes, you must set this value to <b>100</b> less than the lowest MTU value in your cluster. For example, if some nodes in your cluster have an MTU of <b>9001</b>, and some have an MTU of <b>1500</b>, you must set this value to <b>1400</b>.</p>
<code>genevePort</code>	<code>integer</code>	The port to use for all Geneve packets. The default value is <b>6081</b> . This value cannot be changed after cluster installation.
<code>ipsecConfig</code>	<code>object</code>	Specify an empty object to enable IPsec encryption. This value cannot be changed after cluster installation.
<code>policyAuditConfig</code>	<code>object</code>	Specify a configuration object for customizing network policy audit logging. If unset, the defaults audit log settings are used.
<code>gatewayConfig</code>	<code>object</code>	<p>Optional: Specify a configuration object for customizing how egress traffic is sent to the node gateway.</p> <div style="display: flex; align-items: flex-start;"> <div style="flex: 1;">  </div> <div style="flex: 1; padding-left: 10px;"> <p><b>NOTE</b></p> <p>While migrating egress traffic, you can expect some disruption to workloads and service traffic until the Cluster Network Operator (CNO) successfully rolls out the changes.</p> </div> </div>

Table 5.15. `policyAuditConfig` object

Field	Type	Description
<code>rateLimit</code>	<code>integer</code>	The maximum number of messages to generate every second per node. The default value is <b>20</b> messages per second.

Field	Type	Description
<b>maxFileSize</b>	integer	The maximum size for the audit log in bytes. The default value is <b>50000000</b> or 50 MB.
<b>destination</b>	string	One of the following additional audit log targets:  <b>libc</b> The libc <b>syslog()</b> function of the journald process on the host. <b>udp:&lt;host&gt;:&lt;port&gt;</b> A syslog server. Replace <b>&lt;host&gt;:&lt;port&gt;</b> with the host and port of the syslog server. <b>unix:&lt;file&gt;</b> A Unix Domain Socket file specified by <b>&lt;file&gt;</b> . <b>null</b> Do not send the audit logs to any additional target.
<b>syslogFacility</b>	string	The syslog facility, such as <b>kern</b> , as defined by RFC5424. The default value is <b>local0</b> .

Table 5.16. gatewayConfig object

Field	Type	Description
<b>routingViaHost</b>	<b>boolean</b>	Set this field to <b>true</b> to send egress traffic from pods to the host networking stack. For highly-specialized installations and applications that rely on manually configured routes in the kernel routing table, you might want to route egress traffic to the host networking stack. By default, egress traffic is processed in OVN to exit the cluster and is not affected by specialized routes in the kernel routing table. The default value is <b>false</b> .  This field has an interaction with the Open vSwitch hardware offloading feature. If you set this field to <b>true</b> , you do not receive the performance benefits of the offloading because egress traffic is processed by the host networking stack.

### Example OVN-Kubernetes configuration with IPsec enabled

```
defaultNetwork:
  type: OVNKubernetes
  ovnKubernetesConfig:
    mtu: 1400
    genevePort: 6081
    ipsecConfig: {}
```

### kubeProxyConfig object configuration

The values for the **kubeProxyConfig** object are defined in the following table:



Table 5.17. kubeProxyConfig object

Field	Type	Description
<b>iptablesSyncPeriod</b>	<b>string</b>	<p>The refresh period for <b>iptables</b> rules. The default value is <b>30s</b>. Valid suffixes include <b>s</b>, <b>m</b>, and <b>h</b> and are described in the <a href="#">Go time package</a> documentation.</p> <div style="display: flex; align-items: flex-start;">  <div> <p><b>NOTE</b></p> <p>Because of performance improvements introduced in OpenShift Container Platform 4.3 and greater, adjusting the <b>iptablesSyncPeriod</b> parameter is no longer necessary.</p> </div> </div>
<b>proxyArguments.iptables-min-sync-period</b>	<b>array</b>	<p>The minimum duration before refreshing <b>iptables</b> rules. This field ensures that the refresh does not happen too frequently. Valid suffixes include <b>s</b>, <b>m</b>, and <b>h</b> and are described in the <a href="#">Go time package</a>. The default value is:</p> <pre>kubeProxyConfig:   proxyArguments:     iptables-min-sync-period:       - 0s</pre>

### 5.6.8. Specifying advanced network configuration

You can use advanced network configuration for your cluster network provider to integrate your cluster into your existing network environment. You can specify advanced network configuration only before you install the cluster.



#### IMPORTANT

Customizing your network configuration by modifying the OpenShift Container Platform manifest files created by the installation program is not supported. Applying a manifest file that you create, as in the following procedure, is supported.

#### Prerequisites

- You have created the **install-config.yaml** file and completed any modifications to it.

#### Procedure

- Change to the directory that contains the installation program and create the manifests:

```
$ ./openshift-install create manifests --dir <installation_directory> 1
```

1 **<installation\_directory>** specifies the name of the directory that contains the **install-config.yaml** file for your cluster.

2. Create a stub manifest file for the advanced network configuration that is named **cluster-network-03-config.yml** in the **<installation\_directory>/manifests/** directory:

```
apiVersion: operator.openshift.io/v1
kind: Network
metadata:
  name: cluster
spec:
```

3. Specify the advanced network configuration for your cluster in the **cluster-network-03-config.yml** file, such as in the following examples:

#### Specify a different VXLAN port for the OpenShift SDN network provider

```
apiVersion: operator.openshift.io/v1
kind: Network
metadata:
  name: cluster
spec:
  defaultNetwork:
    openshiftSDNConfig:
      vxlanPort: 4800
```

#### Enable IPsec for the OVN-Kubernetes network provider

```
apiVersion: operator.openshift.io/v1
kind: Network
metadata:
  name: cluster
spec:
  defaultNetwork:
    ovnKubernetesConfig:
      ipsecConfig: {}
```

4. Optional: Back up the **manifests/cluster-network-03-config.yml** file. The installation program consumes the **manifests/** directory when you create the Ignition config files.



#### NOTE

For more information on using a Network Load Balancer (NLB) on AWS, see [Configuring Ingress cluster traffic on AWS using a Network Load Balancer](#).

### 5.6.9. Configuring an Ingress Controller Network Load Balancer on a new AWS cluster

You can create an Ingress Controller backed by an AWS Network Load Balancer (NLB) on a new cluster.

#### Prerequisites

- Create the **install-config.yaml** file and complete any modifications to it.

## Procedure

Create an Ingress Controller backed by an AWS NLB on a new cluster.

1. Change to the directory that contains the installation program and create the manifests:

```
$ ./openshift-install create manifests --dir <installation_directory> 1
```

- 1 For **<installation\_directory>**, specify the name of the directory that contains the **install-config.yaml** file for your cluster.

2. Create a file that is named **cluster-ingress-default-ingresscontroller.yaml** in the **<installation\_directory>/manifests/** directory:

```
$ touch <installation_directory>/manifests/cluster-ingress-default-ingresscontroller.yaml 1
```

- 1 For **<installation\_directory>**, specify the directory name that contains the **manifests/** directory for your cluster.

After creating the file, several network configuration files are in the **manifests/** directory, as shown:

```
$ ls <installation_directory>/manifests/cluster-ingress-default-ingresscontroller.yaml
```

### Example output

```
cluster-ingress-default-ingresscontroller.yaml
```

3. Open the **cluster-ingress-default-ingresscontroller.yaml** file in an editor and enter a custom resource (CR) that describes the Operator configuration you want:

```
apiVersion: operator.openshift.io/v1
kind: IngressController
metadata:
  creationTimestamp: null
  name: default
  namespace: openshift-ingress-operator
spec:
  endpointPublishingStrategy:
    loadBalancer:
      scope: External
      providerParameters:
        type: AWS
      aws:
        type: NLB
    type: LoadBalancerService
```

4. Save the **cluster-ingress-default-ingresscontroller.yaml** file and quit the text editor.
5. Optional: Back up the **manifests/cluster-ingress-default-ingresscontroller.yaml** file. The installation program deletes the **manifests/** directory when creating the cluster.

## 5.6.10. Configuring hybrid networking with OVN-Kubernetes

You can configure your cluster to use hybrid networking with OVN-Kubernetes. This allows a hybrid cluster that supports different node networking configurations. For example, this is necessary to run both Linux and Windows nodes in a cluster.



### IMPORTANT

You must configure hybrid networking with OVN-Kubernetes during the installation of your cluster. You cannot switch to hybrid networking after the installation process.

### Prerequisites

- You defined **OVNKubernetes** for the **networking.networkType** parameter in the **install-config.yaml** file. See the installation documentation for configuring OpenShift Container Platform network customizations on your chosen cloud provider for more information.

### Procedure

- Change to the directory that contains the installation program and create the manifests:

```
$ ./openshift-install create manifests --dir <installation_directory>
```

where:

**<installation\_directory>**

Specifies the name of the directory that contains the **install-config.yaml** file for your cluster.

- Create a stub manifest file for the advanced network configuration that is named **cluster-network-03-config.yml** in the **<installation\_directory>/manifests/** directory:

```
$ cat <<EOF > <installation_directory>/manifests/cluster-network-03-config.yml
apiVersion: operator.openshift.io/v1
kind: Network
metadata:
  name: cluster
spec:
EOF
```

where:

**<installation\_directory>**

Specifies the directory name that contains the **manifests/** directory for your cluster.

- Open the **cluster-network-03-config.yml** file in an editor and configure OVN-Kubernetes with hybrid networking, such as in the following example:

### Specify a hybrid networking configuration

```
apiVersion: operator.openshift.io/v1
kind: Network
metadata:
  name: cluster
```

```
spec:
  defaultNetwork:
    ovnKubernetesConfig:
      hybridOverlayConfig:
        hybridClusterNetwork: 1
        - cidr: 10.132.0.0/14
          hostPrefix: 23
        hybridOverlayVXLANPort: 9898 2
```

- 1 Specify the CIDR configuration used for nodes on the additional overlay network. The **hybridClusterNetwork** CIDR cannot overlap with the **clusterNetwork** CIDR.
- 2 Specify a custom VXLAN port for the additional overlay network. This is required for running Windows nodes in a cluster installed on vSphere, and must not be configured for any other cloud provider. The custom port can be any open port excluding the default **4789** port. For more information on this requirement, see the Microsoft documentation on [Pod-to-pod connectivity between hosts is broken](#).



#### NOTE

Windows Server Long-Term Servicing Channel (LTSC): Windows Server 2019 is not supported on clusters with a custom **hybridOverlayVXLANPort** value because this Windows server version does not support selecting a custom VXLAN port.

4. Save the **cluster-network-03-config.yml** file and quit the text editor.
5. Optional: Back up the **manifests/cluster-network-03-config.yml** file. The installation program deletes the **manifests/** directory when creating the cluster.



#### NOTE

For more information on using Linux and Windows nodes in the same cluster, see [Understanding Windows container workloads](#).

### 5.6.11. Deploying the cluster

You can install OpenShift Container Platform on a compatible cloud platform.

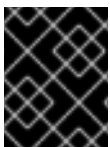

#### IMPORTANT

You can run the **create cluster** command of the installation program only once, during initial installation.

#### Prerequisites

- Configure an account with the cloud platform that hosts your cluster.
- Obtain the OpenShift Container Platform installation program and the pull secret for your cluster.

#### Procedure

1. Change to the directory that contains the installation program and initialize the cluster deployment:

```
$ ./openshift-install create cluster --dir <installation_directory> \ 1
--log-level=info 2
```

- 1** For **<installation\_directory>**, specify the location of your customized **./install-config.yaml** file.
- 2** To view different installation details, specify **warn**, **debug**, or **error** instead of **info**.



#### NOTE

If the cloud provider account that you configured on your host does not have sufficient permissions to deploy the cluster, the installation process stops, and the missing permissions are displayed.

When the cluster deployment completes, directions for accessing your cluster, including a link to its web console and credentials for the **kubeadmin** user, display in your terminal.

#### Example output

```
...
INFO Install complete!
INFO To access the cluster as the system:admin user when using 'oc', run 'export
KUBECONFIG=/home/myuser/install_dir/auth/kubeconfig'
INFO Access the OpenShift web-console here: https://console-openshift-
console.apps.mycluster.example.com
INFO Login to the console with user: "kubeadmin", and password: "4vYBz-Ee6gm-ymBZj-
Wt5AL"
INFO Time elapsed: 36m22s
```



#### NOTE

The cluster access and credential information also outputs to **<installation\_directory>/openshift\_install.log** when an installation succeeds.



#### IMPORTANT

- The Ignition config files that the installation program generates contain certificates that expire after 24 hours, which are then renewed at that time. If the cluster is shut down before renewing the certificates and the cluster is later restarted after the 24 hours have elapsed, the cluster automatically recovers the expired certificates. The exception is that you must manually approve the pending **node-bootstrapper** certificate signing requests (CSRs) to recover kubelet certificates. See the documentation for *Recovering from expired control plane certificates* for more information.
- It is recommended that you use Ignition config files within 12 hours after they are generated because the 24-hour certificate rotates from 16 to 22 hours after the cluster is installed. By using the Ignition config files within 12 hours, you can avoid installation failure if the certificate update runs during installation.

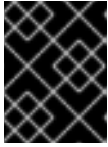
**IMPORTANT**

You must not delete the installation program or the files that the installation program creates. Both are required to delete the cluster.

- Optional: Remove or disable the **AdministratorAccess** policy from the IAM account that you used to install the cluster.

**NOTE**

The elevated permissions provided by the **AdministratorAccess** policy are required only during installation.

### 5.6.12. Installing the OpenShift CLI by downloading the binary

You can install the OpenShift CLI (**oc**) to interact with OpenShift Container Platform from a command-line interface. You can install **oc** on Linux, Windows, or macOS.

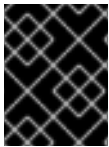
**IMPORTANT**

If you installed an earlier version of **oc**, you cannot use it to complete all of the commands in OpenShift Container Platform 4.10. Download and install the new version of **oc**.

#### Installing the OpenShift CLI on Linux

You can install the OpenShift CLI (**oc**) binary on Linux by using the following procedure.

##### Procedure

- Navigate to the [OpenShift Container Platform downloads page](#) on the Red Hat Customer Portal.
- Select the appropriate version in the **Version** drop-down menu.
- Click **Download Now** next to the **OpenShift v4.10 Linux Client** entry and save the file.
- Unpack the archive:

```
$ tar xvf <file>
```

- Place the **oc** binary in a directory that is on your **PATH**. To check your **PATH**, execute the following command:

```
$ echo $PATH
```

After you install the OpenShift CLI, it is available using the **oc** command:

```
$ oc <command>
```

#### Installing the OpenShift CLI on Windows

You can install the OpenShift CLI (**oc**) binary on Windows by using the following procedure.

##### Procedure

1. Navigate to the [OpenShift Container Platform downloads page](#) on the Red Hat Customer Portal.
2. Select the appropriate version in the **Version** drop-down menu.
3. Click **Download Now** next to the **OpenShift v4.10 Windows Client** entry and save the file.
4. Unzip the archive with a ZIP program.
5. Move the **oc** binary to a directory that is on your **PATH**.  
To check your **PATH**, open the command prompt and execute the following command:

```
C:\> path
```

After you install the OpenShift CLI, it is available using the **oc** command:

```
C:\> oc <command>
```

### Installing the OpenShift CLI on macOS

You can install the OpenShift CLI (**oc**) binary on macOS by using the following procedure.

#### Procedure

1. Navigate to the [OpenShift Container Platform downloads page](#) on the Red Hat Customer Portal.
2. Select the appropriate version in the **Version** drop-down menu.
3. Click **Download Now** next to the **OpenShift v4.10 MacOSX Client** entry and save the file.
4. Unpack and unzip the archive.
5. Move the **oc** binary to a directory on your PATH.  
To check your **PATH**, open a terminal and execute the following command:

```
$ echo $PATH
```

After you install the OpenShift CLI, it is available using the **oc** command:

```
$ oc <command>
```

### 5.6.13. Logging in to the cluster by using the CLI

You can log in to your cluster as a default system user by exporting the cluster **kubeconfig** file. The **kubeconfig** file contains information about the cluster that is used by the CLI to connect a client to the correct cluster and API server. The file is specific to a cluster and is created during OpenShift Container Platform installation.

#### Prerequisites

- You deployed an OpenShift Container Platform cluster.
- You installed the **oc** CLI.



## Procedure

1. Export the **kubeadmin** credentials:

```
$ export KUBECONFIG=<installation_directory>/auth/kubeconfig 1
```

- 1** For **<installation\_directory>**, specify the path to the directory that you stored the installation files in.

2. Verify you can run **oc** commands successfully using the exported configuration:

```
$ oc whoami
```

### Example output

```
system:admin
```

## 5.6.14. Logging in to the cluster by using the web console

The **kubeadmin** user exists by default after an OpenShift Container Platform installation. You can log in to your cluster as the **kubeadmin** user by using the OpenShift Container Platform web console.

### Prerequisites

- You have access to the installation host.
- You completed a cluster installation and all cluster Operators are available.

## Procedure

1. Obtain the password for the **kubeadmin** user from the **kubeadmin-password** file on the installation host:

```
$ cat <installation_directory>/auth/kubeadmin-password
```



### NOTE

Alternatively, you can obtain the **kubeadmin** password from the **<installation\_directory>/openshift\_install.log** log file on the installation host.

2. List the OpenShift Container Platform web console route:

```
$ oc get routes -n openshift-console | grep 'console-openshift'
```



### NOTE

Alternatively, you can obtain the OpenShift Container Platform route from the **<installation\_directory>/openshift\_install.log** log file on the installation host.

### Example output

```
-
```

```
console console-openshift-console.apps.<cluster_name>.<base_domain> console
https reencrypt/Redirect None
```

3. Navigate to the route detailed in the output of the preceding command in a web browser and log in as the **kubeadmin** user.

### Additional resources

- See [Accessing the web console](#) for more details about accessing and understanding the OpenShift Container Platform web console.

## 5.6.15. Telemetry access for OpenShift Container Platform

In OpenShift Container Platform 4.10, the Telemetry service, which runs by default to provide metrics about cluster health and the success of updates, requires internet access. If your cluster is connected to the internet, Telemetry runs automatically, and your cluster is registered to [OpenShift Cluster Manager](#).

After you confirm that your [OpenShift Cluster Manager](#) inventory is correct, either maintained automatically by Telemetry or manually by using OpenShift Cluster Manager, [use subscription watch](#) to track your OpenShift Container Platform subscriptions at the account or multi-cluster level.

### Additional resources

- See [About remote health monitoring](#) for more information about the Telemetry service.

## 5.6.16. Next steps

- [Validating an installation.](#)
- [Customize your cluster.](#)
- If necessary, you can [opt out of remote health reporting](#) .
- If necessary, you can [remove cloud provider credentials](#).

## 5.7. INSTALLING A CLUSTER ON AWS IN A RESTRICTED NETWORK

In OpenShift Container Platform version 4.10, you can install a cluster on Amazon Web Services (AWS) in a restricted network by creating an internal mirror of the installation release content on an existing Amazon Virtual Private Cloud (VPC).

### 5.7.1. Prerequisites

- You reviewed details about the [OpenShift Container Platform installation and update](#) processes.
- You read the documentation on [selecting a cluster installation method and preparing it for users](#).
- You [mirrored the images for a disconnected installation](#) to your registry and obtained the **imageContentSources** data for your version of OpenShift Container Platform.

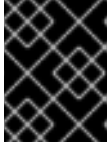

### IMPORTANT

Because the installation media is on the mirror host, you can use that computer to complete all installation steps.

- You have an existing VPC in AWS. When installing to a restricted network using installer-provisioned infrastructure, you cannot use the installer-provisioned VPC. You must use a user-provisioned VPC that satisfies one of the following requirements:
  - Contains the mirror registry
  - Has firewall rules or a peering connection to access the mirror registry hosted elsewhere
- You [configured an AWS account](#) to host the cluster.

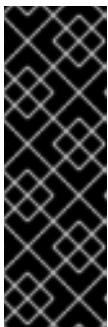

### IMPORTANT

If you have an AWS profile stored on your computer, it must not use a temporary session token that you generated while using a multi-factor authentication device. The cluster continues to use your current AWS credentials to create AWS resources for the entire life of the cluster, so you must use key-based, long-lived credentials. To generate appropriate keys, see [Managing Access Keys for IAM Users](#) in the AWS documentation. You can supply the keys when you run the installation program.

- You downloaded the AWS CLI and installed it on your computer. See [Install the AWS CLI Using the Bundled Installer \(Linux, macOS, or Unix\)](#) in the AWS documentation.
- If you use a firewall and plan to use the Telemetry service, you [configured the firewall to allow the sites](#) that your cluster requires access to.



### NOTE

If you are configuring a proxy, be sure to also review this site list.

- If the cloud identity and access management (IAM) APIs are not accessible in your environment, or if you do not want to store an administrator-level credential secret in the **kube-system** namespace, you can [manually create and maintain IAM credentials](#).

## 5.7.2. About installations in restricted networks

In OpenShift Container Platform 4.10, you can perform an installation that does not require an active connection to the internet to obtain software components. Restricted network installations can be completed using installer-provisioned infrastructure or user-provisioned infrastructure, depending on the cloud platform to which you are installing the cluster.

If you choose to perform a restricted network installation on a cloud platform, you still require access to its cloud APIs. Some cloud functions, like Amazon Web Service's Route 53 DNS and IAM services, require internet access. Depending on your network, you might require less internet access for an installation on bare metal hardware or on VMware vSphere.

To complete a restricted network installation, you must create a registry that mirrors the contents of the OpenShift image registry and contains the installation media. You can create this registry on a mirror host, which can access both the internet and your closed network, or by using other methods that meet

your restrictions.

### 5.7.2.1. Additional limits

Clusters in restricted networks have the following additional limitations and restrictions:

- The **ClusterVersion** status includes an **Unable to retrieve available updates** error.
- By default, you cannot use the contents of the Developer Catalog because you cannot access the required image stream tags.

### 5.7.3. About using a custom VPC

In OpenShift Container Platform 4.10, you can deploy a cluster into existing subnets in an existing Amazon Virtual Private Cloud (VPC) in Amazon Web Services (AWS). By deploying OpenShift Container Platform into an existing AWS VPC, you might be able to avoid limit constraints in new accounts or more easily abide by the operational constraints that your company's guidelines set. If you cannot obtain the infrastructure creation permissions that are required to create the VPC yourself, use this installation option.

Because the installation program cannot know what other components are also in your existing subnets, it cannot choose subnet CIDRs and so forth on your behalf. You must configure networking for the subnets that you install your cluster to yourself.

#### 5.7.3.1. Requirements for using your VPC

The installation program no longer creates the following components:

- Internet gateways
- NAT gateways
- Subnets
- Route tables
- VPCs
- VPC DHCP options
- VPC endpoints



#### NOTE

The installation program requires that you use the cloud-provided DNS server. Using a custom DNS server is not supported and causes the installation to fail.

If you use a custom VPC, you must correctly configure it and its subnets for the installation program and the cluster to use. See [Amazon VPC console wizard configurations](#) and [Work with VPCs and subnets](#) in the AWS documentation for more information on creating and managing an AWS VPC.

The installation program cannot:

- Subdivide network ranges for the cluster to use.

- Set route tables for the subnets.
- Set VPC options like DHCP.

You must complete these tasks before you install the cluster. See [VPC networking components](#) and [Route tables for your VPC](#) for more information on configuring networking in an AWS VPC.

Your VPC must meet the following characteristics:

- The VPC must not use the **kubernetes.io/cluster/.\*: owned** tag. The installation program modifies your subnets to add the **kubernetes.io/cluster/.\*: shared** tag, so your subnets must have at least one free tag slot available for it. See [Tag Restrictions](#) in the AWS documentation to confirm that the installation program can add a tag to each subnet that you specify.
- You must enable the **enableDnsSupport** and **enableDnsHostnames** attributes in your VPC, so that the cluster can use the Route 53 zones that are attached to the VPC to resolve cluster's internal DNS records. See [DNS Support in Your VPC](#) in the AWS documentation. If you prefer to use your own Route 53 hosted private zone, you must associate the existing hosted zone with your VPC prior to installing a cluster. You can define your hosted zone using the **platform.aws.hostedZone** field in the **install-config.yaml** file.

If you are working in a disconnected environment, you are unable to reach the public IP addresses for EC2 and ELB endpoints. To resolve this, you must create a VPC endpoint and attach it to the subnet that the clusters are using. The endpoints should be named as follows:

- **ec2.<region>.amazonaws.com**
- **elasticloadbalancing.<region>.amazonaws.com**
- **s3.<region>.amazonaws.com**

### Required VPC components

You must provide a suitable VPC and subnets that allow communication to your machines.

Component	AWS type	Description
VPC	<ul style="list-style-type: none"> <li>• <b>AWS::EC2::VPC</b></li> <li>• <b>AWS::EC2::VPCEndpoint</b></li> </ul>	You must provide a public VPC for the cluster to use. The VPC uses an endpoint that references the route tables for each subnet to improve communication with the registry that is hosted in S3.
Public subnets	<ul style="list-style-type: none"> <li>• <b>AWS::EC2::Subnet</b></li> <li>• <b>AWS::EC2::SubnetNetworkAclAssociation</b></li> </ul>	Your VPC must have public subnets for between 1 and 3 availability zones and associate them with appropriate Ingress rules.

Component	AWS type	Description												
Internet gateway	<ul style="list-style-type: none"> <li>● <b>AWS::EC2::InternetGateway</b></li> <li>● <b>AWS::EC2::VPCGatewayAttachment</b></li> <li>● <b>AWS::EC2::RouteTable</b></li> <li>● <b>AWS::EC2::Route</b></li> <li>● <b>AWS::EC2::SubnetRouteTableAssociation</b></li> <li>● <b>AWS::EC2::NatGateway</b></li> <li>● <b>AWS::EC2::EIP</b></li> </ul>	<p>You must have a public internet gateway, with public routes, attached to the VPC. In the provided templates, each public subnet has a NAT gateway with an EIP address. These NAT gateways allow cluster resources, like private subnet instances, to reach the internet and are not required for some restricted network or proxy scenarios.</p>												
Network access control	<ul style="list-style-type: none"> <li>● <b>AWS::EC2::NetworkAcl</b></li> <li>● <b>AWS::EC2::NetworkAclEntry</b></li> </ul>	<p>You must allow the VPC to access the following ports:</p> <table border="1"> <thead> <tr> <th>Port</th> <th>Reason</th> </tr> </thead> <tbody> <tr> <td><b>80</b></td> <td>Inbound HTTP traffic</td> </tr> <tr> <td><b>443</b></td> <td>Inbound HTTPS traffic</td> </tr> <tr> <td><b>22</b></td> <td>Inbound SSH traffic</td> </tr> <tr> <td><b>1024 - 65535</b></td> <td>Inbound ephemeral traffic</td> </tr> <tr> <td><b>0 - 65535</b></td> <td>Outbound ephemeral traffic</td> </tr> </tbody> </table>	Port	Reason	<b>80</b>	Inbound HTTP traffic	<b>443</b>	Inbound HTTPS traffic	<b>22</b>	Inbound SSH traffic	<b>1024 - 65535</b>	Inbound ephemeral traffic	<b>0 - 65535</b>	Outbound ephemeral traffic
Port	Reason													
<b>80</b>	Inbound HTTP traffic													
<b>443</b>	Inbound HTTPS traffic													
<b>22</b>	Inbound SSH traffic													
<b>1024 - 65535</b>	Inbound ephemeral traffic													
<b>0 - 65535</b>	Outbound ephemeral traffic													
Private subnets	<ul style="list-style-type: none"> <li>● <b>AWS::EC2::Subnet</b></li> <li>● <b>AWS::EC2::RouteTable</b></li> <li>● <b>AWS::EC2::SubnetRouteTableAssociation</b></li> </ul>	<p>Your VPC can have private subnets. The provided CloudFormation templates can create private subnets for between 1 and 3 availability zones. If you use private subnets, you must provide appropriate routes and tables for them.</p>												

### 5.7.3.2. VPC validation

To ensure that the subnets that you provide are suitable, the installation program confirms the following data:

- All the subnets that you specify exist.
- You provide private subnets.
- The subnet CIDRs belong to the machine CIDR that you specified.
- You provide subnets for each availability zone. Each availability zone contains no more than one public and one private subnet. If you use a private cluster, provide only a private subnet for each availability zone. Otherwise, provide exactly one public and private subnet for each availability zone.
- You provide a public subnet for each private subnet availability zone. Machines are not provisioned in availability zones that you do not provide private subnets for.

If you destroy a cluster that uses an existing VPC, the VPC is not deleted. When you remove the OpenShift Container Platform cluster from a VPC, the **kubernetes.io/cluster/.\*: shared** tag is removed from the subnets that it used.

### 5.7.3.3. Division of permissions

Starting with OpenShift Container Platform 4.3, you do not need all of the permissions that are required for an installation program-provisioned infrastructure cluster to deploy a cluster. This change mimics the division of permissions that you might have at your company: some individuals can create different resource in your clouds than others. For example, you might be able to create application-specific items, like instances, buckets, and load balancers, but not networking-related components such as VPCs, subnets, or ingress rules.

The AWS credentials that you use when you create your cluster do not need the networking permissions that are required to make VPCs and core networking components within the VPC, such as subnets, routing tables, internet gateways, NAT, and VPN. You still need permission to make the application resources that the machines within the cluster require, such as ELBs, security groups, S3 buckets, and nodes.

### 5.7.3.4. Isolation between clusters

If you deploy OpenShift Container Platform to an existing network, the isolation of cluster services is reduced in the following ways:

- You can install multiple OpenShift Container Platform clusters in the same VPC.
- ICMP ingress is allowed from the entire network.
- TCP 22 ingress (SSH) is allowed to the entire network.
- Control plane TCP 6443 ingress (Kubernetes API) is allowed to the entire network.
- Control plane TCP 22623 ingress (MCS) is allowed to the entire network.

## 5.7.4. Internet access for OpenShift Container Platform

In OpenShift Container Platform 4.10, you require access to the internet to obtain the images that are necessary to install your cluster.

You must have internet access to:

- Access [OpenShift Cluster Manager](#) to download the installation program and perform subscription management. If the cluster has internet access and you do not disable Telemetry, that service automatically entitles your cluster.
- Access [Quay.io](#) to obtain the packages that are required to install your cluster.
- Obtain the packages that are required to perform cluster updates.



### IMPORTANT

If your cluster cannot have direct internet access, you can perform a restricted network installation on some types of infrastructure that you provision. During that process, you download the required content and use it to populate a mirror registry with the installation packages. With some installation types, the environment that you install your cluster in will not require internet access. Before you update the cluster, you update the content of the mirror registry.

## 5.7.5. Generating a key pair for cluster node SSH access

During an OpenShift Container Platform installation, you can provide an SSH public key to the installation program. The key is passed to the Red Hat Enterprise Linux CoreOS (RHCOS) nodes through their Ignition config files and is used to authenticate SSH access to the nodes. The key is added to the `~/.ssh/authorized_keys` list for the **core** user on each node, which enables password-less authentication.

After the key is passed to the nodes, you can use the key pair to SSH in to the RHCOS nodes as the user **core**. To access the nodes through SSH, the private key identity must be managed by SSH for your local user.

If you want to SSH in to your cluster nodes to perform installation debugging or disaster recovery, you must provide the SSH public key during the installation process. The `./openshift-install gather` command also requires the SSH public key to be in place on the cluster nodes.



### IMPORTANT

Do not skip this procedure in production environments, where disaster recovery and debugging is required.



### NOTE

You must use a local key, not one that you configured with platform-specific approaches such as [AWS key pairs](#).

### Procedure

1. If you do not have an existing SSH key pair on your local machine to use for authentication onto your cluster nodes, create one. For example, on a computer that uses a Linux operating system, run the following command:

```
$ ssh-keygen -t ed25519 -N "" -f <path>/<file_name> 1
```

- 1** Specify the path and file name, such as `~/.ssh/id_ed25519`, of the new SSH key. If you have an existing key pair, ensure your public key is in the your `~/.ssh` directory.



**NOTE**

If you plan to install an OpenShift Container Platform cluster that uses FIPS validated or Modules In Process cryptographic libraries on the **x86\_64** architecture, do not create a key that uses the **ed25519** algorithm. Instead, create a key that uses the **rsa** or **ecdsa** algorithm.

2. View the public SSH key:

```
$ cat <path>/<file_name>.pub
```

For example, run the following to view the `~/.ssh/id_ed25519.pub` public key:

```
$ cat ~/.ssh/id_ed25519.pub
```

3. Add the SSH private key identity to the SSH agent for your local user, if it has not already been added. SSH agent management of the key is required for password-less SSH authentication onto your cluster nodes, or if you want to use the `./openshift-install gather` command.

**NOTE**

On some distributions, default SSH private key identities such as `~/.ssh/id_rsa` and `~/.ssh/id_dsa` are managed automatically.

- a. If the **ssh-agent** process is not already running for your local user, start it as a background task:

```
$ eval "$(ssh-agent -s)"
```

**Example output**

```
Agent pid 31874
```

**NOTE**

If your cluster is in FIPS mode, only use FIPS-compliant algorithms to generate the SSH key. The key must be either RSA or ECDSA.

4. Add your SSH private key to the **ssh-agent**:

```
$ ssh-add <path>/<file_name> 1
```

- 1** Specify the path and file name for your SSH private key, such as `~/.ssh/id_ed25519`

**Example output**

```
Identity added: /home/<you>/<path>/<file_name> (<computer_name>)
```

**Next steps**

- When you install OpenShift Container Platform, provide the SSH public key to the installation program.

### 5.7.6. Creating the installation configuration file

You can customize the OpenShift Container Platform cluster you install on Amazon Web Services (AWS).

#### Prerequisites

- Obtain the OpenShift Container Platform installation program and the pull secret for your cluster. For a restricted network installation, these files are on your mirror host.
- Have the **imageContentSources** values that were generated during mirror registry creation.
- Obtain the contents of the certificate for your mirror registry.
- Obtain service principal permissions at the subscription level.

#### Procedure

1. Create the **install-config.yaml** file.
  - a. Change to the directory that contains the installation program and run the following command:

```
$. /openshift-install create install-config --dir <installation_directory> 1
```

- 1** For **<installation\_directory>**, specify the directory name to store the files that the installation program creates.



#### IMPORTANT

Specify an empty directory. Some installation assets, like bootstrap X.509 certificates have short expiration intervals, so you must not reuse an installation directory. If you want to reuse individual files from another cluster installation, you can copy them into your directory. However, the file names for the installation assets might change between releases. Use caution when copying installation files from an earlier OpenShift Container Platform version.

- b. At the prompts, provide the configuration details for your cloud:
  - i. Optional: Select an SSH key to use to access your cluster machines.



#### NOTE

For production OpenShift Container Platform clusters on which you want to perform installation debugging or disaster recovery, specify an SSH key that your **ssh-agent** process uses.

- ii. Select **AWS** as the platform to target.

- iii. If you do not have an Amazon Web Services (AWS) profile stored on your computer, enter the AWS access key ID and secret access key for the user that you configured to run the installation program.
  - iv. Select the AWS region to deploy the cluster to.
  - v. Select the base domain for the Route 53 service that you configured for your cluster.
  - vi. Enter a descriptive name for your cluster.
  - vii. Paste the [pull secret from the Red Hat OpenShift Cluster Manager](#) .
2. Edit the **install-config.yaml** file to give the additional information that is required for an installation in a restricted network.
- a. Update the **pullSecret** value to contain the authentication information for your registry:

```
pullSecret: '{"auths":{"<mirror_host_name>:5000": {"auth": "<credentials>","email":
"you@example.com"}}}'
```

For **<mirror\_host\_name>**, specify the registry domain name that you specified in the certificate for your mirror registry, and for **<credentials>**, specify the base64-encoded user name and password for your mirror registry.

- b. Add the **additionalTrustBundle** parameter and value.

```
additionalTrustBundle: |
  -----BEGIN CERTIFICATE-----
  //////////////////////////////////////////////////////////////////////////////////////////////////////////////////
  -----END CERTIFICATE-----
```

The value must be the contents of the certificate file that you used for your mirror registry. The certificate file can be an existing, trusted certificate authority, or the self-signed certificate that you generated for the mirror registry.

- c. Define the subnets for the VPC to install the cluster in:

```
subnets:
- subnet-1
- subnet-2
- subnet-3
```

- d. Add the image content resources, which resemble the following YAML excerpt:

```
imageContentSources:
- mirrors:
  - <mirror_host_name>:5000/<repo_name>/release
  source: quay.io/openshift-release-dev/ocp-release
- mirrors:
  - <mirror_host_name>:5000/<repo_name>/release
  source: registry.redhat.io/ocp/release
```

For these values, use the **imageContentSources** that you recorded during mirror registry creation.

3. Make any other modifications to the **install-config.yaml** file that you require. You can find more information about the available parameters in the **Installation configuration parameters** section.
4. Back up the **install-config.yaml** file so that you can use it to install multiple clusters.

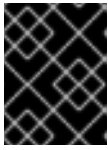

### IMPORTANT

The **install-config.yaml** file is consumed during the installation process. If you want to reuse the file, you must back it up now.

#### 5.7.6.1. Installation configuration parameters

Before you deploy an OpenShift Container Platform cluster, you provide parameter values to describe your account on the cloud platform that hosts your cluster and optionally customize your cluster's platform. When you create the **install-config.yaml** installation configuration file, you provide values for the required parameters through the command line. If you customize your cluster, you can modify the **install-config.yaml** file to provide more details about the platform.



### NOTE

After installation, you cannot modify these parameters in the **install-config.yaml** file.

##### 5.7.6.1.1. Required configuration parameters

Required installation configuration parameters are described in the following table:

Table 5.18. Required parameters

Parameter	Description	Values
<b>apiVersion</b>	The API version for the <b>install-config.yaml</b> content. The current version is <b>v1</b> . The installer may also support older API versions.	String
<b>baseDomain</b>	The base domain of your cloud provider. The base domain is used to create routes to your OpenShift Container Platform cluster components. The full DNS name for your cluster is a combination of the <b>baseDomain</b> and <b>metadata.name</b> parameter values that uses the <b>&lt;metadata.name&gt;</b> . <b>&lt;baseDomain&gt;</b> format.	A fully-qualified domain or subdomain name, such as <b>example.com</b> .

Parameter	Description	Values
<b>metadata</b>	Kubernetes resource <b>ObjectMeta</b> , from which only the <b>name</b> parameter is consumed.	Object
<b>metadata.name</b>	The name of the cluster. DNS records for the cluster are all subdomains of <b>{{.metadata.name}}</b> . <b>{{.baseDomain}}</b> .	String of lowercase letters, hyphens (-), and periods (.), such as <b>dev</b> .
<b>platform</b>	The configuration for the specific platform upon which to perform the installation: <b>alibabacloud, aws, baremetal, azure, gcp, ibmcloud, openstack, ovirt, vsphere</b> , or <b>{}</b> . For additional information about <b>platform.&lt;platform&gt;</b> parameters, consult the table for your specific platform that follows.	Object
<b>pullSecret</b>	Get a <a href="#">pull secret from the Red Hat OpenShift Cluster Manager</a> to authenticate downloading container images for OpenShift Container Platform components from services such as Quay.io.	<pre>{   "auths":{     "cloud.openshift.com":{       "auth":"b3Blb=",       "email":"you@example.com"     },     "quay.io":{       "auth":"b3Blb=",       "email":"you@example.com"     }   } }</pre>

#### 5.7.6.1.2. Network configuration parameters

You can customize your installation configuration based on the requirements of your existing network infrastructure. For example, you can expand the IP address block for the cluster network or provide different IP address blocks than the defaults.

Only IPv4 addresses are supported.

**Table 5.19. Network parameters**

Parameter	Description	Values
<b>networking</b>	The configuration for the cluster network.	Object  <b>NOTE</b> You cannot modify parameters specified by the <b>networking</b> object after installation.
<b>networking.networkType</b>	The cluster network provider Container Network Interface (CNI) plugin to install.	Either <b>OpenShiftSDN</b> or <b>OVNKubernetes</b> . <b>OpenShiftSDN</b> is a CNI provider for all-Linux networks. <b>OVNKubernetes</b> is a CNI provider for Linux networks and hybrid networks that contain both Linux and Windows servers. The default value is <b>OpenShiftSDN</b> .
<b>networking.clusterNetwork</b>	The IP address blocks for pods.  The default value is <b>10.128.0.0/14</b> with a host prefix of <b>/23</b> .  If you specify multiple IP address blocks, the blocks must not overlap.	An array of objects. For example:  <pre>networking:   clusterNetwork:   - cidr: 10.128.0.0/14     hostPrefix: 23</pre>
<b>networking.clusterNetwork.cidr</b>	Required if you use <b>networking.clusterNetwork</b> . An IP address block.  An IPv4 network.	An IP address block in Classless Inter-Domain Routing (CIDR) notation. The prefix length for an IPv4 block is between <b>0</b> and <b>32</b> .
<b>networking.clusterNetwork.hostPrefix</b>	The subnet prefix length to assign to each individual node. For example, if <b>hostPrefix</b> is set to <b>23</b> then each node is assigned a <b>/23</b> subnet out of the given <b>cidr</b> . A <b>hostPrefix</b> value of <b>23</b> provides 510 ( $2^{(32 - 23)} - 2$ ) pod IP addresses.	A subnet prefix.  The default value is <b>23</b> .
<b>networking.serviceNetwork</b>	The IP address block for services. The default value is <b>172.30.0.0/16</b> .  The OpenShift SDN and OVN-Kubernetes network providers support only a single IP address block for the service network.	An array with an IP address block in CIDR format. For example:  <pre>networking:   serviceNetwork:   - 172.30.0.0/16</pre>

Parameter	Description	Values
<b>networking.machineNetwork</b>	The IP address blocks for machines.  If you specify multiple IP address blocks, the blocks must not overlap.	An array of objects. For example:  <pre>networking:   machineNetwork:   - cidr: 10.0.0.0/16</pre>
<b>networking.machineNetwork.cidr</b>	Required if you use <b>networking.machineNetwork</b> . An IP address block. The default value is <b>10.0.0.0/16</b> for all platforms other than libvirt. For libvirt, the default value is <b>192.168.126.0/24</b> .	An IP network block in CIDR notation.  For example, <b>10.0.0.0/16</b> .   <p><b>NOTE</b></p> <p>Set the <b>networking.machineNetwork</b> to match the CIDR that the preferred NIC resides in.</p>

### 5.7.6.1.3. Optional configuration parameters

Optional installation configuration parameters are described in the following table:



Table 5.20. Optional parameters

Parameter	Description	Values
<b>additionalTrustBundle</b>	A PEM-encoded X.509 certificate bundle that is added to the nodes' trusted certificate store. This trust bundle may also be used when a proxy has been configured.	String
<b>cgroupsV2</b>	Enables <a href="#">Linux control groups version 2</a> (cgroups v2) on specific nodes in your cluster. The OpenShift Container Platform process for enabling cgroups v2 disables all cgroup version 1 controllers and hierarchies. The OpenShift Container Platform cgroups version 2 feature is in Developer Preview and is not supported by Red Hat at this time.	<b>true</b>
<b>compute</b>	The configuration for the machines that comprise the compute nodes.	Array of <b>MachinePool</b> objects.

Parameter	Description	Values
<b>compute.architecture</b>	Determines the instruction set architecture of the machines in the pool. Currently, clusters with varied architectures are not supported. All pools must specify the same architecture. Valid values are <b>amd64</b> (the default).	String
<b>compute.hyperthreading</b>	Whether to enable or disable simultaneous multithreading, or <b>hyperthreading</b> , on compute machines. By default, simultaneous multithreading is enabled to increase the performance of your machines' cores.   <b>IMPORTANT</b> If you disable simultaneous multithreading, ensure that your capacity planning accounts for the dramatically decreased machine performance.	<b>Enabled</b> or <b>Disabled</b>
<b>compute.name</b>	Required if you use <b>compute</b> . The name of the machine pool.	<b>worker</b>
<b>compute.platform</b>	Required if you use <b>compute</b> . Use this parameter to specify the cloud provider to host the worker machines. This parameter value must match the <b>controlPlane.platform</b> parameter value.	<b>alibabacloud, aws, azure, gcp, ibmcloud, openstack, ovirt, vsphere</b> , or <b>{}</b>
<b>compute.replicas</b>	The number of compute machines, which are also known as worker machines, to provision.	A positive integer greater than or equal to <b>2</b> . The default value is <b>3</b> .
<b>controlPlane</b>	The configuration for the machines that comprise the control plane.	Array of <b>MachinePool</b> objects.



Parameter	Description	Values
<b>controlPlane.architecture</b>	Determines the instruction set architecture of the machines in the pool. Currently, clusters with varied architectures are not supported. All pools must specify the same architecture. Valid values are <b>amd64</b> (the default).	String
<b>controlPlane.hypertreading</b>	Whether to enable or disable simultaneous multithreading, or <b>hyperthreading</b> , on control plane machines. By default, simultaneous multithreading is enabled to increase the performance of your machines' cores.   <b>IMPORTANT</b>  If you disable simultaneous multithreading, ensure that your capacity planning accounts for the dramatically decreased machine performance.	<b>Enabled</b> or <b>Disabled</b>
<b>controlPlane.name</b>	Required if you use <b>controlPlane</b> . The name of the machine pool.	<b>master</b>
<b>controlPlane.platform</b>	Required if you use <b>controlPlane</b> . Use this parameter to specify the cloud provider that hosts the control plane machines. This parameter value must match the <b>compute.platform</b> parameter value.	<b>alibabacloud, aws, azure, gcp, ibmcloud, openstack, ovirt, vsphere, or {}</b>
<b>controlPlane.replicas</b>	The number of control plane machines to provision.	The only supported value is <b>3</b> , which is the default value.

Parameter	Description	Values
<b>credentialsMode</b>	<p>The Cloud Credential Operator (CCO) mode. If no mode is specified, the CCO dynamically tries to determine the capabilities of the provided credentials, with a preference for mint mode on the platforms where multiple modes are supported.</p> <p> <b>NOTE</b></p> <p>Not all CCO modes are supported for all cloud providers. For more information on CCO modes, see the <i>Cloud Credential Operator</i> entry in the <i>Cluster Operators reference content</i>.</p> <p> <b>NOTE</b></p> <p>If your AWS account has service control policies (SCP) enabled, you must configure the <b>credentialsMode</b> parameter to <b>Mint</b>, <b>Passthrough</b> or <b>Manual</b>.</p>	<b>Mint, Passthrough, Manual</b> or an empty string ("").

Parameter	Description	Values
<b>fips</b>	<p>Enable or disable FIPS mode. The default is <b>false</b> (disabled). If FIPS mode is enabled, the Red Hat Enterprise Linux CoreOS (RHCOS) machines that OpenShift Container Platform runs on bypass the default Kubernetes cryptography suite and use the cryptography modules that are provided with RHCOS instead.</p> <div style="display: flex; align-items: flex-start;"> <div style="width: 20px; height: 100px; background: repeating-linear-gradient(45deg, transparent, transparent 2px, black 2px, black 4px); margin-right: 10px;"></div> <div> <p><b>IMPORTANT</b></p> <p>To enable FIPS mode for your cluster, you must run the installation program from a Red Hat Enterprise Linux (RHEL) computer configured to operate in FIPS mode. For more information about configuring FIPS mode on RHEL, see <a href="#">Installing the system in FIPS mode</a>. The use of FIPS validated or Modules In Process cryptographic libraries is only supported on OpenShift Container Platform deployments on the <b>x86_64</b> architecture.</p> </div> </div> <div style="display: flex; align-items: flex-start; margin-top: 10px;"> <div style="width: 20px; height: 50px; background: repeating-linear-gradient(45deg, transparent, transparent 2px, black 2px, black 4px); margin-right: 10px;"></div> <div> <p><b>NOTE</b></p> <p>If you are using Azure File storage, you cannot enable FIPS mode.</p> </div> </div>	<b>false</b> or <b>true</b>
<b>imageContentSources</b>	Sources and repositories for the release-image content.	Array of objects. Includes a <b>source</b> and, optionally, <b>mirrors</b> , as described in the following rows of this table.
<b>imageContentSources.source</b>	Required if you use <b>imageContentSources</b> . Specify the repository that users refer to, for example, in image pull specifications.	String
<b>imageContentSources.mirrors</b>	Specify one or more repositories that may also contain the same images.	Array of strings

Parameter	Description	Values
<b>publish</b>	How to publish or expose the user-facing endpoints of your cluster, such as the Kubernetes API, OpenShift routes.	<b>Internal</b> or <b>External</b> . To deploy a private cluster, which cannot be accessed from the internet, set <b>publish</b> to <b>Internal</b> . The default value is <b>External</b> .
<b>sshKey</b>	<p>The SSH key or keys to authenticate access your cluster machines.</p>  <p><b>NOTE</b></p> <p>For production OpenShift Container Platform clusters on which you want to perform installation debugging or disaster recovery, specify an SSH key that your <b>ssh-agent</b> process uses.</p>	<p>One or more keys. For example:</p> <pre>sshKey:   &lt;key1&gt;   &lt;key2&gt;   &lt;key3&gt;</pre>

#### 5.7.6.1.4. Optional AWS configuration parameters

Optional AWS configuration parameters are described in the following table:

Table 5.21. Optional AWS parameters

Parameter	Description	Values
<b>compute.platform.aws.amiID</b>	The AWS AMI used to boot compute machines for the cluster. This is required for regions that require a custom RHCOS AMI.	Any published or custom RHCOS AMI that belongs to the set AWS region. See <i>RHCOS AMIs for AWS infrastructure</i> for available AMI IDs.
<b>compute.platform.aws.iamRole</b>	A pre-existing AWS IAM role applied to the compute machine pool instance profiles. You can use these fields to match naming schemes and include predefined permissions boundaries for your IAM roles. If undefined, the installation program creates a new IAM role.	The name of a valid AWS IAM role.

Parameter	Description	Values
<b>compute.platform.aws.rootVolume.iops</b>	The Input/Output Operations Per Second (IOPS) that is reserved for the root volume.	Integer, for example <b>4000</b> .
<b>compute.platform.aws.rootVolume.size</b>	The size in GiB of the root volume.	Integer, for example <b>500</b> .
<b>compute.platform.aws.rootVolume.type</b>	The type of the root volume.	Valid <a href="#">AWS EBS volume type</a> , such as <b>io1</b> .
<b>compute.platform.aws.rootVolume.kmsKeyARN</b>	The Amazon Resource Name (key ARN) of a KMS key. This is required to encrypt OS volumes of worker nodes with a specific KMS key.	Valid <a href="#">key ID</a> or the <a href="#">key ARN</a>
<b>compute.platform.aws.type</b>	The EC2 instance type for the compute machines.	Valid AWS instance type, such as <b>m4.2xlarge</b> . See the <b>Supported AWS machine types</b> table that follows.
<b>compute.platform.aws.zones</b>	The availability zones where the installation program creates machines for the compute machine pool. If you provide your own VPC, you must provide a subnet in that availability zone.	A list of valid AWS availability zones, such as <b>us-east-1c</b> , in a <a href="#">YAML sequence</a> .
<b>compute.aws.region</b>	The AWS region that the installation program creates compute resources in.	Any valid <a href="#">AWS region</a> , such as <b>us-east-1</b> .   <b>IMPORTANT</b> When running on ARM based AWS instances, ensure that you enter a region where AWS Graviton processors are available. See <a href="#">Global availability map</a> in the AWS documentation.
<b>controlPlane.platform.aws.amiID</b>	The AWS AMI used to boot control plane machines for the cluster. This is required for regions that require a custom RHCOS AMI.	Any published or custom RHCOS AMI that belongs to the set AWS region. See <i>RHCOS AMIs for AWS infrastructure</i> for available AMI IDs.

Parameter	Description	Values
<b>controlPlane.platform.aws.iamRole</b>	A pre-existing AWS IAM role applied to the control plane machine pool instance profiles. You can use these fields to match naming schemes and include predefined permissions boundaries for your IAM roles. If undefined, the installation program creates a new IAM role.	The name of a valid AWS IAM role.
<b>controlPlane.platform.aws.rootVolume.kmsKeyARN</b>	The Amazon Resource Name (key ARN) of a KMS key. This is required to encrypt OS volumes of control plane nodes with a specific KMS key.	Valid <a href="#">key ID</a> and the <a href="#">key ARN</a>
<b>controlPlane.platform.aws.type</b>	The EC2 instance type for the control plane machines.	Valid AWS instance type, such as <b>m6i.xlarge</b> . See the <b>Supported AWS machine types</b> table that follows.
<b>controlPlane.platform.aws.zones</b>	The availability zones where the installation program creates machines for the control plane machine pool.	A list of valid AWS availability zones, such as <b>us-east-1c</b> , in a <a href="#">YAML sequence</a> .
<b>controlPlane.aws.region</b>	The AWS region that the installation program creates control plane resources in.	Valid <a href="#">AWS region</a> , such as <b>us-east-1</b> .
<b>platform.aws.amiID</b>	The AWS AMI used to boot all machines for the cluster. If set, the AMI must belong to the same region as the cluster. This is required for regions that require a custom RHCOS AMI.	Any published or custom RHCOS AMI that belongs to the set AWS region. See <i>RHCOS AMIs for AWS infrastructure</i> for available AMI IDs.

Parameter	Description	Values
<b>platform.aws.hostedZone</b>	An existing Route 53 private hosted zone for the cluster. You can only use a pre-existing hosted zone when also supplying your own VPC. The hosted zone must already be associated with the user-provided VPC before installation. Also, the domain of the hosted zone must be the cluster domain or a parent of the cluster domain. If undefined, the installation program creates a new hosted zone.	String, for example <b>Z3URY6TWQ91KVV</b> .
<b>platform.aws.serviceEndpoints.name</b>	The AWS service endpoint name. Custom endpoints are only required for cases where alternative AWS endpoints, like FIPS, must be used. Custom API endpoints can be specified for EC2, S3, IAM, Elastic Load Balancing, Tagging, Route 53, and STS AWS services.	Valid <a href="#">AWS service endpoint</a> name.
<b>platform.aws.serviceEndpoints.url</b>	The AWS service endpoint URL. The URL must use the <b>https</b> protocol and the host must trust the certificate.	Valid <a href="#">AWS service endpoint</a> URL.
<b>platform.aws.userTags</b>	A map of keys and values that the installation program adds as tags to all resources that it creates.	Any valid YAML map, such as key value pairs in the <b>&lt;key&gt;: &lt;value&gt;</b> format. For more information about AWS tags, see <a href="#">Tagging Your Amazon EC2 Resources</a> in the AWS documentation.

Parameter	Description	Values
<b>platform.aws.subnets</b>	If you provide the VPC instead of allowing the installation program to create the VPC for you, specify the subnet for the cluster to use. The subnet must be part of the same <b>machineNetwork[].cidr</b> ranges that you specify. For a standard cluster, specify a public and a private subnet for each availability zone. For a private cluster, specify a private subnet for each availability zone.	Valid subnet IDs.

### 5.7.6.2. Minimum resource requirements for cluster installation

Each cluster machine must meet the following minimum requirements:

**Table 5.22. Minimum resource requirements**

Machine	Operating System	vCPU [1]	Virtual RAM	Storage	IOPS [2]
Bootstrap	RHCOS	4	16 GB	100 GB	300
Control plane	RHCOS	4	16 GB	100 GB	300
Compute	RHCOS, RHEL 8.4, or RHEL 8.5 [3]	2	8 GB	100 GB	300

1. One vCPU is equivalent to one physical core when simultaneous multithreading (SMT), or hyperthreading, is not enabled. When enabled, use the following formula to calculate the corresponding ratio: (threads per core × cores) × sockets = vCPUs.
2. OpenShift Container Platform and Kubernetes are sensitive to disk performance, and faster storage is recommended, particularly for etcd on the control plane nodes which require a 10 ms p99 fsync duration. Note that on many cloud platforms, storage size and IOPS scale together, so you might need to over-allocate storage volume to obtain sufficient performance.
3. As with all user-provisioned installations, if you choose to use RHEL compute machines in your cluster, you take responsibility for all operating system life cycle management and maintenance, including performing system updates, applying patches, and completing all other required tasks. Use of RHEL 7 compute machines is deprecated and has been removed in OpenShift Container Platform 4.10 and later.

If an instance type for your platform meets the minimum requirements for cluster machines, it is supported to use in OpenShift Container Platform.



### 5.7.6.3. Sample customized install-config.yaml file for AWS

You can customize the installation configuration file (**install-config.yaml**) to specify more details about your OpenShift Container Platform cluster's platform or modify the values of the required parameters.



#### IMPORTANT

This sample YAML file is provided for reference only. You must obtain your **install-config.yaml** file by using the installation program and modify it.

```

apiVersion: v1
baseDomain: example.com 1
credentialsMode: Mint 2
controlPlane: 3 4
  hyperthreading: Enabled 5
  name: master
  platform:
    aws:
      zones:
      - us-west-2a
      - us-west-2b
      rootVolume:
        iops: 4000
        size: 500
        type: io1 6
      type: m6i.xlarge
    replicas: 3
compute: 7
- hyperthreading: Enabled 8
  name: worker
  platform:
    aws:
      rootVolume:
        iops: 2000
        size: 500
        type: io1 9
      type: c5.4xlarge
      zones:
      - us-west-2c
    replicas: 3
metadata:
  name: test-cluster 10
networking:
  clusterNetwork:
  - cidr: 10.128.0.0/14
    hostPrefix: 23
  machineNetwork:
  - cidr: 10.0.0.0/16
  networkType: OpenShiftSDN
  serviceNetwork:
  - 172.30.0.0/16
platform:
  aws:
    region: us-west-2 11

```

```

userTags:
  adminContact: jdoe
  costCenter: 7536
subnets: 12
- subnet-1
- subnet-2
- subnet-3
amiID: ami-96c6f8f7 13
serviceEndpoints: 14
- name: ec2
  url: https://vpce-id.ec2.us-west-2.vpce.amazonaws.com
hostedZone: Z3URY6TWQ91KVV 15
fips: false 16
sshKey: ssh-ed25519 AAAA... 17
pullSecret: '{"auths":{"<local_registry>":{"auth": "<credentials>","email": "you@example.com"}}}' 18
additionalTrustBundle: | 19
-----BEGIN CERTIFICATE-----
<MY_TRUSTED_CA_CERT>
-----END CERTIFICATE-----
imageContentSources: 20
- mirrors:
- <local_registry>/<local_repository_name>/release
  source: quay.io/openshift-release-dev/ocp-release
- mirrors:
- <local_registry>/<local_repository_name>/release
  source: quay.io/openshift-release-dev/ocp-v4.0-art-dev

```

- 1 10 11 Required. The installation program prompts you for this value.
- 2 Optional: Add this parameter to force the Cloud Credential Operator (CCO) to use the specified mode, instead of having the CCO dynamically try to determine the capabilities of the credentials. For details about CCO modes, see the *Cloud Credential Operator* entry in the *Red Hat Operators reference* content.
- 3 7 If you do not provide these parameters and values, the installation program provides the default value.
- 4 The **controlPlane** section is a single mapping, but the **compute** section is a sequence of mappings. To meet the requirements of the different data structures, the first line of the **compute** section must begin with a hyphen, -, and the first line of the **controlPlane** section must not. Only one control plane pool is used.
- 5 8 Whether to enable or disable simultaneous multithreading, or **hyperthreading**. By default, simultaneous multithreading is enabled to increase the performance of your machines' cores. You can disable it by setting the parameter value to **Disabled**. If you disable simultaneous multithreading in some cluster machines, you must disable it in all cluster machines.



## IMPORTANT

If you disable simultaneous multithreading, ensure that your capacity planning accounts for the dramatically decreased machine performance. Use larger instance types, such as **m4.2xlarge** or **m5.2xlarge**, for your machines if you disable simultaneous multithreading.

- 6 9 To configure faster storage for etcd, especially for larger clusters, set the storage type as **io1** and set **iops** to **2000**.
- 12 If you provide your own VPC, specify subnets for each availability zone that your cluster uses.
- 13 The ID of the AMI used to boot machines for the cluster. If set, the AMI must belong to the same region as the cluster.
- 14 The AWS service endpoints. Custom endpoints are required when installing to an unknown AWS region. The endpoint URL must use the **https** protocol and the host must trust the certificate.
- 15 The ID of your existing Route 53 private hosted zone. Providing an existing hosted zone requires that you supply your own VPC and the hosted zone is already associated with the VPC prior to installing your cluster. If undefined, the installation program creates a new hosted zone.
- 16 Whether to enable or disable FIPS mode. By default, FIPS mode is not enabled. If FIPS mode is enabled, the Red Hat Enterprise Linux CoreOS (RHCOS) machines that OpenShift Container Platform runs on bypass the default Kubernetes cryptography suite and use the cryptography modules that are provided with RHCOS instead.

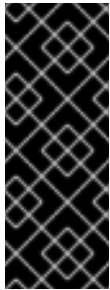

### IMPORTANT

To enable FIPS mode for your cluster, you must run the installation program from a Red Hat Enterprise Linux (RHEL) computer configured to operate in FIPS mode. For more information about configuring FIPS mode on RHEL, see [Installing the system in FIPS mode](#). The use of FIPS validated or Modules In Progress cryptographic libraries is only supported on OpenShift Container Platform deployments on the **x86\_64** architecture.

- 17 You can optionally provide the **sshKey** value that you use to access the machines in your cluster.



### NOTE

For production OpenShift Container Platform clusters on which you want to perform installation debugging or disaster recovery, specify an SSH key that your **ssh-agent** process uses.

- 18 For **<local\_registry>**, specify the registry domain name, and optionally the port, that your mirror registry uses to serve content. For example **registry.example.com** or **registry.example.com:5000**. For **<credentials>**, specify the base64-encoded user name and password for your mirror registry.
- 19 Provide the contents of the certificate file that you used for your mirror registry.
- 20 Provide the **imageContentSources** section from the output of the command to mirror the repository.

#### 5.7.6.4. Configuring the cluster-wide proxy during installation

Production environments can deny direct access to the internet and instead have an HTTP or HTTPS proxy available. You can configure a new OpenShift Container Platform cluster to use a proxy by configuring the proxy settings in the **install-config.yaml** file.

## Prerequisites

- You have an existing **install-config.yaml** file.
- You reviewed the sites that your cluster requires access to and determined whether any of them need to bypass the proxy. By default, all cluster egress traffic is proxied, including calls to hosting cloud provider APIs. You added sites to the **Proxy** object's **spec.noProxy** field to bypass the proxy if necessary.



### NOTE

The **Proxy** object **status.noProxy** field is populated with the values of the **networking.machineNetwork[].cidr**, **networking.clusterNetwork[].cidr**, and **networking.serviceNetwork[]** fields from your installation configuration.

For installations on Amazon Web Services (AWS), Google Cloud Platform (GCP), Microsoft Azure, and Red Hat OpenStack Platform (RHOSP), the **Proxy** object **status.noProxy** field is also populated with the instance metadata endpoint (**169.254.169.254**).

- You have added the **ec2.<region>.amazonaws.com**, **elasticloadbalancing.<region>.amazonaws.com**, and **s3.<region>.amazonaws.com** endpoints to your VPC endpoint. These endpoints are required to complete requests from the nodes to the AWS EC2 API. Because the proxy works on the container level, not the node level, you must route these requests to the AWS EC2 API through the AWS private network. Adding the public IP address of the EC2 API to your allowlist in your proxy server is not sufficient.

## Procedure

1. Edit your **install-config.yaml** file and add the proxy settings. For example:

```
apiVersion: v1
baseDomain: my.domain.com
proxy:
  httpProxy: http://<username>:<pswd>@<ip>:<port> 1
  httpsProxy: https://<username>:<pswd>@<ip>:<port> 2
  noProxy: example.com 3
  additionalTrustBundle: | 4
    -----BEGIN CERTIFICATE-----
    <MY_TRUSTED_CA_CERT>
    -----END CERTIFICATE-----
  ...
```

- 1 A proxy URL to use for creating HTTP connections outside the cluster. The URL scheme must be **http**.
- 2 A proxy URL to use for creating HTTPS connections outside the cluster.
- 3 A comma-separated list of destination domain names, IP addresses, or other network CIDRs to exclude from proxying. Preface a domain with **.** to match subdomains only. For example, **.y.com** matches **x.y.com**, but not **y.com**. Use **\*** to bypass the proxy for all destinations.
- 4 If provided, the installation program generates a config map that is named **user-ca-bundle** in the **openshift-config** namespace that contains one or more additional CA certificates that can be used to verify HTTPS connections. The OpenShift Container Platform

that are required for proxying HTTPS connections. The Cluster Network Operator then creates a **trusted-ca-bundle** config map that merges these contents with the Red Hat Enterprise Linux CoreOS (RHCOS) trust bundle, and this config map is referenced in the **trustedCA** field of the **Proxy** object. The **additionalTrustBundle** field is required unless the proxy's identity certificate is signed by an authority from the RHCOS trust bundle.

**NOTE**

The installation program does not support the proxy **readinessEndpoints** field.

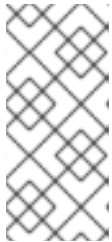
**NOTE**

If the installer times out, restart and then complete the deployment by using the **wait-for** command of the installer. For example:

```
$ ./openshift-install wait-for install-complete --log-level debug
```

2. Save the file and reference it when installing OpenShift Container Platform.

The installation program creates a cluster-wide proxy that is named **cluster** that uses the proxy settings in the provided **install-config.yaml** file. If no proxy settings are provided, a **cluster Proxy** object is still created, but it will have a nil **spec**.

**NOTE**

Only the **Proxy** object named **cluster** is supported, and no additional proxies can be created.

### 5.7.7. Deploying the cluster

You can install OpenShift Container Platform on a compatible cloud platform.

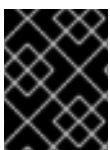
**IMPORTANT**

You can run the **create cluster** command of the installation program only once, during initial installation.

#### Prerequisites

- Configure an account with the cloud platform that hosts your cluster.
- Obtain the OpenShift Container Platform installation program and the pull secret for your cluster.

#### Procedure

1. Change to the directory that contains the installation program and initialize the cluster deployment:

```
$ ./openshift-install create cluster --dir <installation_directory> \ 1  
--log-level=info 2
```

- 1 For `<installation_directory>`, specify the location of your customized `./install-config.yaml` file.
- 2 To view different installation details, specify **warn**, **debug**, or **error** instead of **info**.



#### NOTE

If the cloud provider account that you configured on your host does not have sufficient permissions to deploy the cluster, the installation process stops, and the missing permissions are displayed.

When the cluster deployment completes, directions for accessing your cluster, including a link to its web console and credentials for the **kubeadmin** user, display in your terminal.

#### Example output

```
...
INFO Install complete!
INFO To access the cluster as the system:admin user when using 'oc', run 'export
KUBECONFIG=/home/myuser/install_dir/auth/kubeconfig'
INFO Access the OpenShift web-console here: https://console-openshift-
console.apps.mycluster.example.com
INFO Login to the console with user: "kubeadmin", and password: "4vYBz-Ee6gm-ymBZj-
Wt5AL"
INFO Time elapsed: 36m22s
```



#### NOTE

The cluster access and credential information also outputs to `<installation_directory>/openshift_install.log` when an installation succeeds.



#### IMPORTANT

- The Ignition config files that the installation program generates contain certificates that expire after 24 hours, which are then renewed at that time. If the cluster is shut down before renewing the certificates and the cluster is later restarted after the 24 hours have elapsed, the cluster automatically recovers the expired certificates. The exception is that you must manually approve the pending **node-bootstrapper** certificate signing requests (CSRs) to recover kubelet certificates. See the documentation for *Recovering from expired control plane certificates* for more information.
- It is recommended that you use Ignition config files within 12 hours after they are generated because the 24-hour certificate rotates from 16 to 22 hours after the cluster is installed. By using the Ignition config files within 12 hours, you can avoid installation failure if the certificate update runs during installation.



#### IMPORTANT

You must not delete the installation program or the files that the installation program creates. Both are required to delete the cluster.

- Optional: Remove or disable the **AdministratorAccess** policy from the IAM account that you used to install the cluster.

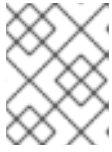

#### NOTE

The elevated permissions provided by the **AdministratorAccess** policy are required only during installation.

### 5.7.8. Installing the OpenShift CLI by downloading the binary

You can install the OpenShift CLI (**oc**) to interact with OpenShift Container Platform from a command-line interface. You can install **oc** on Linux, Windows, or macOS.



#### IMPORTANT

If you installed an earlier version of **oc**, you cannot use it to complete all of the commands in OpenShift Container Platform 4.10. Download and install the new version of **oc**.

#### Installing the OpenShift CLI on Linux

You can install the OpenShift CLI (**oc**) binary on Linux by using the following procedure.

##### Procedure

- Navigate to the [OpenShift Container Platform downloads page](#) on the Red Hat Customer Portal.
- Select the appropriate version in the **Version** drop-down menu.
- Click **Download Now** next to the **OpenShift v4.10 Linux Client** entry and save the file.
- Unpack the archive:

```
$ tar xvf <file>
```

- Place the **oc** binary in a directory that is on your **PATH**. To check your **PATH**, execute the following command:

```
$ echo $PATH
```

After you install the OpenShift CLI, it is available using the **oc** command:

```
$ oc <command>
```

#### Installing the OpenShift CLI on Windows

You can install the OpenShift CLI (**oc**) binary on Windows by using the following procedure.

##### Procedure

- Navigate to the [OpenShift Container Platform downloads page](#) on the Red Hat Customer Portal.
- Select the appropriate version in the **Version** drop-down menu.

3. Click **Download Now** next to the **OpenShift v4.10 Windows Client** entry and save the file.
4. Unzip the archive with a ZIP program.
5. Move the **oc** binary to a directory that is on your **PATH**.  
To check your **PATH**, open the command prompt and execute the following command:

```
C:\> path
```

After you install the OpenShift CLI, it is available using the **oc** command:

```
C:\> oc <command>
```

### Installing the OpenShift CLI on macOS

You can install the OpenShift CLI (**oc**) binary on macOS by using the following procedure.

#### Procedure

1. Navigate to the [OpenShift Container Platform downloads page](#) on the Red Hat Customer Portal.
2. Select the appropriate version in the **Version** drop-down menu.
3. Click **Download Now** next to the **OpenShift v4.10 MacOSX Client** entry and save the file.
4. Unpack and unzip the archive.
5. Move the **oc** binary to a directory on your PATH.  
To check your **PATH**, open a terminal and execute the following command:

```
$ echo $PATH
```

After you install the OpenShift CLI, it is available using the **oc** command:

```
$ oc <command>
```

### 5.7.9. Logging in to the cluster by using the CLI

You can log in to your cluster as a default system user by exporting the cluster **kubeconfig** file. The **kubeconfig** file contains information about the cluster that is used by the CLI to connect a client to the correct cluster and API server. The file is specific to a cluster and is created during OpenShift Container Platform installation.

#### Prerequisites

- You deployed an OpenShift Container Platform cluster.
- You installed the **oc** CLI.

#### Procedure

1. Export the **kubeadmin** credentials:



```
$ export KUBECONFIG=<installation_directory>/auth/kubeconfig 1
```

- 1** For **<installation\_directory>**, specify the path to the directory that you stored the installation files in.

- Verify you can run **oc** commands successfully using the exported configuration:

```
$ oc whoami
```

#### Example output

```
system:admin
```

### 5.7.10. Disabling the default OperatorHub sources

Operator catalogs that source content provided by Red Hat and community projects are configured for OperatorHub by default during an OpenShift Container Platform installation. In a restricted network environment, you must disable the default catalogs as a cluster administrator.

#### Procedure

- Disable the sources for the default catalogs by adding **disableAllDefaultSources: true** to the **OperatorHub** object:

```
$ oc patch OperatorHub cluster --type json \
  -p '[{"op": "add", "path": "/spec/disableAllDefaultSources", "value": true}]'
```

#### TIP

Alternatively, you can use the web console to manage catalog sources. From the **Administration** → **Cluster Settings** → **Configuration** → **OperatorHub** page, click the **Sources** tab, where you can create, delete, disable, and enable individual sources.

### 5.7.11. Telemetry access for OpenShift Container Platform

In OpenShift Container Platform 4.10, the Telemetry service, which runs by default to provide metrics about cluster health and the success of updates, requires internet access. If your cluster is connected to the internet, Telemetry runs automatically, and your cluster is registered to [OpenShift Cluster Manager](#).

After you confirm that your [OpenShift Cluster Manager](#) inventory is correct, either maintained automatically by Telemetry or manually by using OpenShift Cluster Manager, [use subscription watch](#) to track your OpenShift Container Platform subscriptions at the account or multi-cluster level.

#### Additional resources

- See [About remote health monitoring](#) for more information about the Telemetry service

### 5.7.12. Next steps

- [Validate an installation.](#)

- [Customize your cluster](#).
- [Configure image streams](#) for the Cluster Samples Operator and the **must-gather** tool.
- Learn how to [use Operator Lifecycle Manager \(OLM\) on restricted networks](#).
- If the mirror registry that you used to install your cluster has a trusted CA, add it to the cluster by [configuring additional trust stores](#).
- If necessary, you can [opt out of remote health reporting](#).

## 5.8. INSTALLING A CLUSTER ON AWS INTO AN EXISTING VPC

In OpenShift Container Platform version 4.10, you can install a cluster into an existing Amazon Virtual Private Cloud (VPC) on Amazon Web Services (AWS). The installation program provisions the rest of the required infrastructure, which you can further customize. To customize the installation, you modify parameters in the **install-config.yaml** file before you install the cluster.

### 5.8.1. Prerequisites

- You reviewed details about the [OpenShift Container Platform installation and update](#) processes.
- You read the documentation on [selecting a cluster installation method and preparing it for users](#).
- You [configured an AWS account](#) to host the cluster.



#### IMPORTANT

If you have an AWS profile stored on your computer, it must not use a temporary session token that you generated while using a multi-factor authentication device. The cluster continues to use your current AWS credentials to create AWS resources for the entire life of the cluster, so you must use long-lived credentials. To generate appropriate keys, see [Managing Access Keys for IAM Users](#) in the AWS documentation. You can supply the keys when you run the installation program.

- If you use a firewall, you [configured it to allow the sites](#) that your cluster requires access to.
- If the cloud identity and access management (IAM) APIs are not accessible in your environment, or if you do not want to store an administrator-level credential secret in the **kube-system** namespace, you can [manually create and maintain IAM credentials](#).

### 5.8.2. About using a custom VPC

In OpenShift Container Platform 4.10, you can deploy a cluster into existing subnets in an existing Amazon Virtual Private Cloud (VPC) in Amazon Web Services (AWS). By deploying OpenShift Container Platform into an existing AWS VPC, you might be able to avoid limit constraints in new accounts or more easily abide by the operational constraints that your company's guidelines set. If you cannot obtain the infrastructure creation permissions that are required to create the VPC yourself, use this installation option.

Because the installation program cannot know what other components are also in your existing subnets, it cannot choose subnet CIDRs and so forth on your behalf. You must configure networking for the subnets that you install your cluster to yourself.

### 5.8.2.1. Requirements for using your VPC

The installation program no longer creates the following components:

- Internet gateways
- NAT gateways
- Subnets
- Route tables
- VPCs
- VPC DHCP options
- VPC endpoints



#### NOTE

The installation program requires that you use the cloud-provided DNS server. Using a custom DNS server is not supported and causes the installation to fail.

If you use a custom VPC, you must correctly configure it and its subnets for the installation program and the cluster to use. See [Amazon VPC console wizard configurations](#) and [Work with VPCs and subnets](#) in the AWS documentation for more information on creating and managing an AWS VPC.

The installation program cannot:

- Subdivide network ranges for the cluster to use.
- Set route tables for the subnets.
- Set VPC options like DHCP.

You must complete these tasks before you install the cluster. See [VPC networking components](#) and [Route tables for your VPC](#) for more information on configuring networking in an AWS VPC.

Your VPC must meet the following characteristics:

- Create a public and private subnet for each availability zone that your cluster uses. Each availability zone can contain no more than one public and one private subnet. For an example of this type of configuration, see [VPC with public and private subnets \(NAT\)](#) in the AWS documentation.  
Record each subnet ID. Completing the installation requires that you enter these values in the **platform** section of the **install-config.yaml** file. See [Finding a subnet ID](#) in the AWS documentation.
- The VPC's CIDR block must contain the **Networking.MachineCIDR** range, which is the IP address pool for cluster machines. The subnet CIDR blocks must belong to the machine CIDR that you specify.

- The VPC must have a public internet gateway attached to it. For each availability zone:
  - The public subnet requires a route to the internet gateway.
  - The public subnet requires a NAT gateway with an EIP address.
  - The private subnet requires a route to the NAT gateway in public subnet.
- The VPC must not use the **kubernetes.io/cluster/.\*: owned** tag. The installation program modifies your subnets to add the **kubernetes.io/cluster/.\*: shared** tag, so your subnets must have at least one free tag slot available for it. See [Tag Restrictions](#) in the AWS documentation to confirm that the installation program can add a tag to each subnet that you specify.
- You must enable the **enableDnsSupport** and **enableDnsHostnames** attributes in your VPC, so that the cluster can use the Route 53 zones that are attached to the VPC to resolve cluster's internal DNS records. See [DNS Support in Your VPC](#) in the AWS documentation. If you prefer to use your own Route 53 hosted private zone, you must associate the existing hosted zone with your VPC prior to installing a cluster. You can define your hosted zone using the **platform.aws.hostedZone** field in the **install-config.yaml** file.

If you are working in a disconnected environment, you are unable to reach the public IP addresses for EC2 and ELB endpoints. To resolve this, you must create a VPC endpoint and attach it to the subnet that the clusters are using. The endpoints should be named as follows:

- **ec2.<region>.amazonaws.com**
- **elasticloadbalancing.<region>.amazonaws.com**
- **s3.<region>.amazonaws.com**

### Required VPC components

You must provide a suitable VPC and subnets that allow communication to your machines.

Component	AWS type	Description
VPC	<ul style="list-style-type: none"> <li>• <b>AWS::EC2::VPC</b></li> <li>• <b>AWS::EC2::VPCEndpoint</b></li> </ul>	You must provide a public VPC for the cluster to use. The VPC uses an endpoint that references the route tables for each subnet to improve communication with the registry that is hosted in S3.
Public subnets	<ul style="list-style-type: none"> <li>• <b>AWS::EC2::Subnet</b></li> <li>• <b>AWS::EC2::SubnetNetworkAclAssociation</b></li> </ul>	Your VPC must have public subnets for between 1 and 3 availability zones and associate them with appropriate Ingress rules.

Component	AWS type	Description												
Internet gateway	<ul style="list-style-type: none"> <li>● <b>AWS::EC2::InternetGateway</b></li> <li>● <b>AWS::EC2::VPCGatewayAttachment</b></li> <li>● <b>AWS::EC2::RouteTable</b></li> <li>● <b>AWS::EC2::Route</b></li> <li>● <b>AWS::EC2::SubnetRouteTableAssociation</b></li> <li>● <b>AWS::EC2::NatGateway</b></li> <li>● <b>AWS::EC2::EIP</b></li> </ul>	<p>You must have a public internet gateway, with public routes, attached to the VPC. In the provided templates, each public subnet has a NAT gateway with an EIP address. These NAT gateways allow cluster resources, like private subnet instances, to reach the internet and are not required for some restricted network or proxy scenarios.</p>												
Network access control	<ul style="list-style-type: none"> <li>● <b>AWS::EC2::NetworkAcl</b></li> <li>● <b>AWS::EC2::NetworkAclEntry</b></li> </ul>	<p>You must allow the VPC to access the following ports:</p> <table border="1"> <thead> <tr> <th>Port</th> <th>Reason</th> </tr> </thead> <tbody> <tr> <td><b>80</b></td> <td>Inbound HTTP traffic</td> </tr> <tr> <td><b>443</b></td> <td>Inbound HTTPS traffic</td> </tr> <tr> <td><b>22</b></td> <td>Inbound SSH traffic</td> </tr> <tr> <td><b>1024 - 65535</b></td> <td>Inbound ephemeral traffic</td> </tr> <tr> <td><b>0 - 65535</b></td> <td>Outbound ephemeral traffic</td> </tr> </tbody> </table>	Port	Reason	<b>80</b>	Inbound HTTP traffic	<b>443</b>	Inbound HTTPS traffic	<b>22</b>	Inbound SSH traffic	<b>1024 - 65535</b>	Inbound ephemeral traffic	<b>0 - 65535</b>	Outbound ephemeral traffic
Port	Reason													
<b>80</b>	Inbound HTTP traffic													
<b>443</b>	Inbound HTTPS traffic													
<b>22</b>	Inbound SSH traffic													
<b>1024 - 65535</b>	Inbound ephemeral traffic													
<b>0 - 65535</b>	Outbound ephemeral traffic													
Private subnets	<ul style="list-style-type: none"> <li>● <b>AWS::EC2::Subnet</b></li> <li>● <b>AWS::EC2::RouteTable</b></li> <li>● <b>AWS::EC2::SubnetRouteTableAssociation</b></li> </ul>	<p>Your VPC can have private subnets. The provided CloudFormation templates can create private subnets for between 1 and 3 availability zones. If you use private subnets, you must provide appropriate routes and tables for them.</p>												

### 5.8.2.2. VPC validation

To ensure that the subnets that you provide are suitable, the installation program confirms the following data:

- All the subnets that you specify exist.
- You provide private subnets.
- The subnet CIDRs belong to the machine CIDR that you specified.
- You provide subnets for each availability zone. Each availability zone contains no more than one public and one private subnet. If you use a private cluster, provide only a private subnet for each availability zone. Otherwise, provide exactly one public and private subnet for each availability zone.
- You provide a public subnet for each private subnet availability zone. Machines are not provisioned in availability zones that you do not provide private subnets for.

If you destroy a cluster that uses an existing VPC, the VPC is not deleted. When you remove the OpenShift Container Platform cluster from a VPC, the **kubernetes.io/cluster/.\*: shared** tag is removed from the subnets that it used.

### 5.8.2.3. Division of permissions

Starting with OpenShift Container Platform 4.3, you do not need all of the permissions that are required for an installation program-provisioned infrastructure cluster to deploy a cluster. This change mimics the division of permissions that you might have at your company: some individuals can create different resource in your clouds than others. For example, you might be able to create application-specific items, like instances, buckets, and load balancers, but not networking-related components such as VPCs, subnets, or ingress rules.

The AWS credentials that you use when you create your cluster do not need the networking permissions that are required to make VPCs and core networking components within the VPC, such as subnets, routing tables, internet gateways, NAT, and VPN. You still need permission to make the application resources that the machines within the cluster require, such as ELBs, security groups, S3 buckets, and nodes.

### 5.8.2.4. Isolation between clusters

If you deploy OpenShift Container Platform to an existing network, the isolation of cluster services is reduced in the following ways:

- You can install multiple OpenShift Container Platform clusters in the same VPC.
- ICMP ingress is allowed from the entire network.
- TCP 22 ingress (SSH) is allowed to the entire network.
- Control plane TCP 6443 ingress (Kubernetes API) is allowed to the entire network.
- Control plane TCP 22623 ingress (MCS) is allowed to the entire network.

### 5.8.3. Internet access for OpenShift Container Platform

In OpenShift Container Platform 4.10, you require access to the internet to install your cluster.

You must have internet access to:

- Access [OpenShift Cluster Manager](#) to download the installation program and perform subscription management. If the cluster has internet access and you do not disable Telemetry, that service automatically entitles your cluster.
- Access [Quay.io](#) to obtain the packages that are required to install your cluster.
- Obtain the packages that are required to perform cluster updates.



### IMPORTANT

If your cluster cannot have direct internet access, you can perform a restricted network installation on some types of infrastructure that you provision. During that process, you download the required content and use it to populate a mirror registry with the installation packages. With some installation types, the environment that you install your cluster in will not require internet access. Before you update the cluster, you update the content of the mirror registry.

#### 5.8.4. Generating a key pair for cluster node SSH access

During an OpenShift Container Platform installation, you can provide an SSH public key to the installation program. The key is passed to the Red Hat Enterprise Linux CoreOS (RHCOS) nodes through their Ignition config files and is used to authenticate SSH access to the nodes. The key is added to the `~/.ssh/authorized_keys` list for the **core** user on each node, which enables password-less authentication.

After the key is passed to the nodes, you can use the key pair to SSH in to the RHCOS nodes as the user **core**. To access the nodes through SSH, the private key identity must be managed by SSH for your local user.

If you want to SSH in to your cluster nodes to perform installation debugging or disaster recovery, you must provide the SSH public key during the installation process. The `./openshift-install gather` command also requires the SSH public key to be in place on the cluster nodes.



### IMPORTANT

Do not skip this procedure in production environments, where disaster recovery and debugging is required.



### NOTE

You must use a local key, not one that you configured with platform-specific approaches such as [AWS key pairs](#).

#### Procedure

1. If you do not have an existing SSH key pair on your local machine to use for authentication onto your cluster nodes, create one. For example, on a computer that uses a Linux operating system, run the following command:

```
$ ssh-keygen -t ed25519 -N "" -f <path>/<file_name> 1
```

- 1 Specify the path and file name, such as `~/.ssh/id_ed25519`, of the new SSH key. If you have an existing key pair, ensure your public key is in the your `~/.ssh` directory.

**NOTE**

If you plan to install an OpenShift Container Platform cluster that uses FIPS validated or Modules In Process cryptographic libraries on the **x86\_64** architecture, do not create a key that uses the **ed25519** algorithm. Instead, create a key that uses the **rsa** or **ecdsa** algorithm.

2. View the public SSH key:

```
$ cat <path>/<file_name>.pub
```

For example, run the following to view the `~/.ssh/id_ed25519.pub` public key:

```
$ cat ~/.ssh/id_ed25519.pub
```

3. Add the SSH private key identity to the SSH agent for your local user, if it has not already been added. SSH agent management of the key is required for password-less SSH authentication onto your cluster nodes, or if you want to use the `./openshift-install gather` command.

**NOTE**

On some distributions, default SSH private key identities such as `~/.ssh/id_rsa` and `~/.ssh/id_dsa` are managed automatically.

- a. If the **ssh-agent** process is not already running for your local user, start it as a background task:

```
$ eval "$(ssh-agent -s)"
```

**Example output**

```
Agent pid 31874
```

**NOTE**

If your cluster is in FIPS mode, only use FIPS-compliant algorithms to generate the SSH key. The key must be either RSA or ECDSA.

4. Add your SSH private key to the **ssh-agent**:

```
$ ssh-add <path>/<file_name> 1
```

- 1** Specify the path and file name for your SSH private key, such as `~/.ssh/id_ed25519`

**Example output**

```
Identity added: /home/<you>/<path>/<file_name> (<computer_name>)
```

**Next steps**



- When you install OpenShift Container Platform, provide the SSH public key to the installation program.

### 5.8.5. Obtaining the installation program

Before you install OpenShift Container Platform, download the installation file on a local computer.

#### Prerequisites

- You have a computer that runs Linux or macOS, with 500 MB of local disk space

#### Procedure

1. Access the [Infrastructure Provider](#) page on the OpenShift Cluster Manager site. If you have a Red Hat account, log in with your credentials. If you do not, create an account.
2. Select your infrastructure provider.
3. Navigate to the page for your installation type, download the installation program that corresponds with your host operating system and architecture, and place the file in the directory where you will store the installation configuration files.

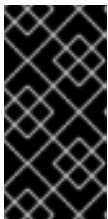

#### IMPORTANT

The installation program creates several files on the computer that you use to install your cluster. You must keep the installation program and the files that the installation program creates after you finish installing the cluster. Both files are required to delete the cluster.



#### IMPORTANT

Deleting the files created by the installation program does not remove your cluster, even if the cluster failed during installation. To remove your cluster, complete the OpenShift Container Platform uninstallation procedures for your specific cloud provider.

4. Extract the installation program. For example, on a computer that uses a Linux operating system, run the following command:

```
$ tar -xvf openshift-install-linux.tar.gz
```

5. Download your installation [pull secret from the Red Hat OpenShift Cluster Manager](#) . This pull secret allows you to authenticate with the services that are provided by the included authorities, including Quay.io, which serves the container images for OpenShift Container Platform components.

### 5.8.6. Creating the installation configuration file

You can customize the OpenShift Container Platform cluster you install on Amazon Web Services (AWS).

#### Prerequisites

- Obtain the OpenShift Container Platform installation program and the pull secret for your cluster.
- Obtain service principal permissions at the subscription level.

## Procedure

1. Create the **install-config.yaml** file.
  - a. Change to the directory that contains the installation program and run the following command:

```
$ ./openshift-install create install-config --dir <installation_directory> 1
```

- 1** For **<installation\_directory>**, specify the directory name to store the files that the installation program creates.



### IMPORTANT

Specify an empty directory. Some installation assets, like bootstrap X.509 certificates have short expiration intervals, so you must not reuse an installation directory. If you want to reuse individual files from another cluster installation, you can copy them into your directory. However, the file names for the installation assets might change between releases. Use caution when copying installation files from an earlier OpenShift Container Platform version.

- b. At the prompts, provide the configuration details for your cloud:
  - i. Optional: Select an SSH key to use to access your cluster machines.



### NOTE

For production OpenShift Container Platform clusters on which you want to perform installation debugging or disaster recovery, specify an SSH key that your **ssh-agent** process uses.

- ii. Select **AWS** as the platform to target.
  - iii. If you do not have an Amazon Web Services (AWS) profile stored on your computer, enter the AWS access key ID and secret access key for the user that you configured to run the installation program.
  - iv. Select the AWS region to deploy the cluster to.
  - v. Select the base domain for the Route 53 service that you configured for your cluster.
  - vi. Enter a descriptive name for your cluster.
  - vii. Paste the [pull secret from the Red Hat OpenShift Cluster Manager](#) .
2. Modify the **install-config.yaml** file. You can find more information about the available parameters in the "Installation configuration parameters" section.

3. Back up the **install-config.yaml** file so that you can use it to install multiple clusters.

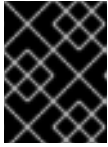

### IMPORTANT

The **install-config.yaml** file is consumed during the installation process. If you want to reuse the file, you must back it up now.

#### 5.8.6.1. Installation configuration parameters

Before you deploy an OpenShift Container Platform cluster, you provide parameter values to describe your account on the cloud platform that hosts your cluster and optionally customize your cluster's platform. When you create the **install-config.yaml** installation configuration file, you provide values for the required parameters through the command line. If you customize your cluster, you can modify the **install-config.yaml** file to provide more details about the platform.



### NOTE

After installation, you cannot modify these parameters in the **install-config.yaml** file.

##### 5.8.6.1.1. Required configuration parameters

Required installation configuration parameters are described in the following table:

Table 5.23. Required parameters

Parameter	Description	Values
<b>apiVersion</b>	The API version for the <b>install-config.yaml</b> content. The current version is <b>v1</b> . The installer may also support older API versions.	String
<b>baseDomain</b>	The base domain of your cloud provider. The base domain is used to create routes to your OpenShift Container Platform cluster components. The full DNS name for your cluster is a combination of the <b>baseDomain</b> and <b>metadata.name</b> parameter values that uses the <b>&lt;metadata.name&gt;</b> . <b>&lt;baseDomain&gt;</b> format.	A fully-qualified domain or subdomain name, such as <b>example.com</b> .
<b>metadata</b>	Kubernetes resource <b>ObjectMeta</b> , from which only the <b>name</b> parameter is consumed.	Object

Parameter	Description	Values
<b>metadata.name</b>	The name of the cluster. DNS records for the cluster are all subdomains of <b>{{.metadata.name}}.{{.baseDomain}}</b> .	String of lowercase letters, hyphens (-), and periods (.), such as <b>dev</b> .
<b>platform</b>	The configuration for the specific platform upon which to perform the installation: <b>alibabacloud, aws, baremetal, azure, gcp, ibmcloud, openstack, ovirt, vsphere</b> , or <b>{}</b> . For additional information about <b>platform.&lt;platform&gt;</b> parameters, consult the table for your specific platform that follows.	Object
<b>pullSecret</b>	Get a <a href="#">pull secret from the Red Hat OpenShift Cluster Manager</a> to authenticate downloading container images for OpenShift Container Platform components from services such as Quay.io.	<pre>{   "auths":{     "cloud.openshift.com":{       "auth":"b3Blb=",       "email":"you@example.com"     },     "quay.io":{       "auth":"b3Blb=",       "email":"you@example.com"     }   } }</pre>

#### 5.8.6.1.2. Network configuration parameters

You can customize your installation configuration based on the requirements of your existing network infrastructure. For example, you can expand the IP address block for the cluster network or provide different IP address blocks than the defaults.

Only IPv4 addresses are supported.

**Table 5.24. Network parameters**

Parameter	Description	Values
-----------	-------------	--------

Parameter	Description	Values
<b>networking</b>	The configuration for the cluster network.	Object  <b>NOTE</b> You cannot modify parameters specified by the <b>networking</b> object after installation.
<b>networking.networkType</b>	The cluster network provider Container Network Interface (CNI) plugin to install.	Either <b>OpenShiftSDN</b> or <b>OVNKubernetes</b> . <b>OpenShiftSDN</b> is a CNI provider for all-Linux networks. <b>OVNKubernetes</b> is a CNI provider for Linux networks and hybrid networks that contain both Linux and Windows servers. The default value is <b>OpenShiftSDN</b> .
<b>networking.clusterNetwork</b>	The IP address blocks for pods.  The default value is <b>10.128.0.0/14</b> with a host prefix of <b>/23</b> .  If you specify multiple IP address blocks, the blocks must not overlap.	An array of objects. For example:  <pre>networking:   clusterNetwork:     - cidr: 10.128.0.0/14       hostPrefix: 23</pre>
<b>networking.clusterNetwork.cidr</b>	Required if you use <b>networking.clusterNetwork</b> . An IP address block.  An IPv4 network.	An IP address block in Classless Inter-Domain Routing (CIDR) notation. The prefix length for an IPv4 block is between <b>0</b> and <b>32</b> .
<b>networking.clusterNetwork.hostPrefix</b>	The subnet prefix length to assign to each individual node. For example, if <b>hostPrefix</b> is set to <b>23</b> then each node is assigned a <b>/23</b> subnet out of the given <b>cidr</b> . A <b>hostPrefix</b> value of <b>23</b> provides 510 ( $2^{(32 - 23)} - 2$ ) pod IP addresses.	A subnet prefix.  The default value is <b>23</b> .
<b>networking.serviceNetwork</b>	The IP address block for services. The default value is <b>172.30.0.0/16</b> .  The OpenShift SDN and OVN-Kubernetes network providers support only a single IP address block for the service network.	An array with an IP address block in CIDR format. For example:  <pre>networking:   serviceNetwork:     - 172.30.0.0/16</pre>

Parameter	Description	Values
<b>networking.machineNetwork</b>	The IP address blocks for machines.  If you specify multiple IP address blocks, the blocks must not overlap.	An array of objects. For example:  <pre>networking:   machineNetwork:   - cidr: 10.0.0.0/16</pre>
<b>networking.machineNetwork.cidr</b>	Required if you use <b>networking.machineNetwork</b> . An IP address block. The default value is <b>10.0.0.0/16</b> for all platforms other than libvirt. For libvirt, the default value is <b>192.168.126.0/24</b> .	An IP network block in CIDR notation.  For example, <b>10.0.0.0/16</b> .   <p><b>NOTE</b></p> <p>Set the <b>networking.machineNetwork</b> to match the CIDR that the preferred NIC resides in.</p>

### 5.8.6.1.3. Optional configuration parameters

Optional installation configuration parameters are described in the following table:



Table 5.25. Optional parameters

Parameter	Description	Values
<b>additionalTrustBundle</b>	A PEM-encoded X.509 certificate bundle that is added to the nodes' trusted certificate store. This trust bundle may also be used when a proxy has been configured.	String
<b>cgroupsV2</b>	Enables <a href="#">Linux control groups version 2</a> (cgroups v2) on specific nodes in your cluster. The OpenShift Container Platform process for enabling cgroups v2 disables all cgroup version 1 controllers and hierarchies. The OpenShift Container Platform cgroups version 2 feature is in Developer Preview and is not supported by Red Hat at this time.	<b>true</b>
<b>compute</b>	The configuration for the machines that comprise the compute nodes.	Array of <b>MachinePool</b> objects.

Parameter	Description	Values
<b>compute.architecture</b>	Determines the instruction set architecture of the machines in the pool. Currently, clusters with varied architectures are not supported. All pools must specify the same architecture. Valid values are <b>amd64</b> and <b>arm64</b> . See <i>Supported installation methods for different platforms</i> in <i>Installing</i> documentation for information about instance availability.	String
<b>compute.hyperthreading</b>	Whether to enable or disable simultaneous multithreading, or <b>hyperthreading</b> , on compute machines. By default, simultaneous multithreading is enabled to increase the performance of your machines' cores.   <b>IMPORTANT</b>  If you disable simultaneous multithreading, ensure that your capacity planning accounts for the dramatically decreased machine performance.	<b>Enabled</b> or <b>Disabled</b>
<b>compute.name</b>	Required if you use <b>compute</b> . The name of the machine pool.	<b>worker</b>
<b>compute.platform</b>	Required if you use <b>compute</b> . Use this parameter to specify the cloud provider to host the worker machines. This parameter value must match the <b>controlPlane.platform</b> parameter value.	<b>alibabacloud, aws, azure, gcp, ibmcloud, openstack, ovirt, vsphere</b> , or <b>{}</b>
<b>compute.replicas</b>	The number of compute machines, which are also known as worker machines, to provision.	A positive integer greater than or equal to <b>2</b> . The default value is <b>3</b> .
<b>controlPlane</b>	The configuration for the machines that comprise the control plane.	Array of <b>MachinePool</b> objects.

Parameter	Description	Values
<b>controlPlane.architecture</b>	Determines the instruction set architecture of the machines in the pool. Currently, clusters with varied architectures are not supported. All pools must specify the same architecture. Valid values are <b>amd64</b> and <b>arm64</b> . See <i>Supported installation methods for different platforms</i> in <i>Installing</i> documentation for information about instance availability.	String
<b>controlPlane.hyperthreading</b>	Whether to enable or disable simultaneous multithreading, or <b>hyperthreading</b> , on control plane machines. By default, simultaneous multithreading is enabled to increase the performance of your machines' cores.   <b>IMPORTANT</b> If you disable simultaneous multithreading, ensure that your capacity planning accounts for the dramatically decreased machine performance.	<b>Enabled</b> or <b>Disabled</b>
<b>controlPlane.name</b>	Required if you use <b>controlPlane</b> . The name of the machine pool.	<b>master</b>
<b>controlPlane.platform</b>	Required if you use <b>controlPlane</b> . Use this parameter to specify the cloud provider that hosts the control plane machines. This parameter value must match the <b>compute.platform</b> parameter value.	<b>alibabacloud, aws, azure, gcp, ibmcloud, openstack, ovirt, vsphere, or {}</b>
<b>controlPlane.replicas</b>	The number of control plane machines to provision.	The only supported value is <b>3</b> , which is the default value.



Parameter	Description	Values
<b>credentialsMode</b>	<p>The Cloud Credential Operator (CCO) mode. If no mode is specified, the CCO dynamically tries to determine the capabilities of the provided credentials, with a preference for mint mode on the platforms where multiple modes are supported.</p> <div data-bbox="485 510 595 862" style="border: 1px solid gray; padding: 5px; margin-bottom: 10px;">  </div> <p><b>NOTE</b></p> <p>Not all CCO modes are supported for all cloud providers. For more information on CCO modes, see the <i>Cloud Credential Operator</i> entry in the <i>Cluster Operators reference</i> content.</p> <div data-bbox="485 909 595 1261" style="border: 1px solid gray; padding: 5px;">  </div> <p><b>NOTE</b></p> <p>If your AWS account has service control policies (SCP) enabled, you must configure the <b>credentialsMode</b> parameter to <b>Mint</b>, <b>Passthrough</b> or <b>Manual</b>.</p>	<b>Mint, Passthrough, Manual</b> or an empty string ("").

Parameter	Description	Values
<b>fips</b>	<p>Enable or disable FIPS mode. The default is <b>false</b> (disabled). If FIPS mode is enabled, the Red Hat Enterprise Linux CoreOS (RHCOS) machines that OpenShift Container Platform runs on bypass the default Kubernetes cryptography suite and use the cryptography modules that are provided with RHCOS instead.</p> <div style="display: flex; align-items: flex-start;"> <div style="width: 20px; height: 100px; background: repeating-linear-gradient(45deg, transparent, transparent 2px, black 2px, black 4px); margin-right: 10px;"></div> <div> <p><b>IMPORTANT</b></p> <p>To enable FIPS mode for your cluster, you must run the installation program from a Red Hat Enterprise Linux (RHEL) computer configured to operate in FIPS mode. For more information about configuring FIPS mode on RHEL, see <a href="#">Installing the system in FIPS mode</a>. The use of FIPS validated or Modules In Process cryptographic libraries is only supported on OpenShift Container Platform deployments on the <b>x86_64</b> architecture.</p> </div> </div> <div style="display: flex; align-items: flex-start; margin-top: 10px;"> <div style="width: 20px; height: 50px; background: repeating-linear-gradient(45deg, transparent, transparent 2px, black 2px, black 4px); margin-right: 10px;"></div> <div> <p><b>NOTE</b></p> <p>If you are using Azure File storage, you cannot enable FIPS mode.</p> </div> </div>	<b>false</b> or <b>true</b>
<b>imageContentSources</b>	Sources and repositories for the release-image content.	Array of objects. Includes a <b>source</b> and, optionally, <b>mirrors</b> , as described in the following rows of this table.
<b>imageContentSources.source</b>	Required if you use <b>imageContentSources</b> . Specify the repository that users refer to, for example, in image pull specifications.	String

Parameter	Description	Values
<b>imageContentSources.mirrors</b>	Specify one or more repositories that may also contain the same images.	Array of strings
<b>publish</b>	How to publish or expose the user-facing endpoints of your cluster, such as the Kubernetes API, OpenShift routes.	<b>Internal</b> or <b>External</b> . To deploy a private cluster, which cannot be accessed from the internet, set <b>publish</b> to <b>Internal</b> . The default value is <b>External</b> .
<b>sshKey</b>	<p>The SSH key or keys to authenticate access your cluster machines.</p>  <p><b>NOTE</b></p> <p>For production OpenShift Container Platform clusters on which you want to perform installation debugging or disaster recovery, specify an SSH key that your <b>ssh-agent</b> process uses.</p>	<p>One or more keys. For example:</p> <pre>sshKey:   &lt;key1&gt;   &lt;key2&gt;   &lt;key3&gt;</pre>

#### 5.8.6.1.4. Optional AWS configuration parameters

Optional AWS configuration parameters are described in the following table:

Table 5.26. Optional AWS parameters

Parameter	Description	Values
<b>compute.platform.aws.amiID</b>	The AWS AMI used to boot compute machines for the cluster. This is required for regions that require a custom RHCOS AMI.	Any published or custom RHCOS AMI that belongs to the set AWS region. See <i>RHCOS AMIs for AWS infrastructure</i> for available AMI IDs.
<b>compute.platform.aws.iamRole</b>	A pre-existing AWS IAM role applied to the compute machine pool instance profiles. You can use these fields to match naming schemes and include predefined permissions boundaries for your IAM roles. If undefined, the installation program creates a new IAM role.	The name of a valid AWS IAM role.

Parameter	Description	Values
<code>compute.platform.aws.rootVolume.iops</code>	The Input/Output Operations Per Second (IOPS) that is reserved for the root volume.	Integer, for example <b>4000</b> .
<code>compute.platform.aws.rootVolume.size</code>	The size in GiB of the root volume.	Integer, for example <b>500</b> .
<code>compute.platform.aws.rootVolume.type</code>	The type of the root volume.	Valid <a href="#">AWS EBS volume type</a> , such as <b>io1</b> .
<code>compute.platform.aws.rootVolume.kmsKeyARN</code>	The Amazon Resource Name (key ARN) of a KMS key. This is required to encrypt OS volumes of worker nodes with a specific KMS key.	Valid <a href="#">key ID</a> or the <a href="#">key ARN</a>
<code>compute.platform.aws.type</code>	The EC2 instance type for the compute machines.	Valid AWS instance type, such as <b>m4.2xlarge</b> . See the <a href="#">Supported AWS machine types</a> table that follows.
<code>compute.platform.aws.zones</code>	The availability zones where the installation program creates machines for the compute machine pool. If you provide your own VPC, you must provide a subnet in that availability zone.	A list of valid AWS availability zones, such as <b>us-east-1c</b> , in a <a href="#">YAML sequence</a> .
<code>compute.aws.region</code>	The AWS region that the installation program creates compute resources in.	Any valid <a href="#">AWS region</a> , such as <b>us-east-1</b> .   <b>IMPORTANT</b>  When running on ARM based AWS instances, ensure that you enter a region where AWS Graviton processors are available. See <a href="#">Global availability map</a> in the AWS documentation.
<code>controlPlane.platform.aws.amiID</code>	The AWS AMI used to boot control plane machines for the cluster. This is required for regions that require a custom RHCOS AMI.	Any published or custom RHCOS AMI that belongs to the set AWS region. See <a href="#">RHCOS AMIs for AWS infrastructure</a> for available AMI IDs.

Parameter	Description	Values
<b>controlPlane.platform.aws.iamRole</b>	A pre-existing AWS IAM role applied to the control plane machine pool instance profiles. You can use these fields to match naming schemes and include predefined permissions boundaries for your IAM roles. If undefined, the installation program creates a new IAM role.	The name of a valid AWS IAM role.
<b>controlPlane.platform.aws.rootVolume.kmsKeyARN</b>	The Amazon Resource Name (key ARN) of a KMS key. This is required to encrypt OS volumes of control plane nodes with a specific KMS key.	Valid <a href="#">key ID</a> and the <a href="#">key ARN</a>
<b>controlPlane.platform.aws.type</b>	The EC2 instance type for the control plane machines.	Valid AWS instance type, such as <b>m6i.xlarge</b> . See the <b>Supported AWS machine types</b> table that follows.
<b>controlPlane.platform.aws.zones</b>	The availability zones where the installation program creates machines for the control plane machine pool.	A list of valid AWS availability zones, such as <b>us-east-1c</b> , in a <a href="#">YAML sequence</a> .
<b>controlPlane.aws.region</b>	The AWS region that the installation program creates control plane resources in.	Valid <a href="#">AWS region</a> , such as <b>us-east-1</b> .
<b>platform.aws.amiID</b>	The AWS AMI used to boot all machines for the cluster. If set, the AMI must belong to the same region as the cluster. This is required for regions that require a custom RHCOS AMI.	Any published or custom RHCOS AMI that belongs to the set AWS region. See <i>RHCOS AMIs for AWS infrastructure</i> for available AMI IDs.

Parameter	Description	Values
<b>platform.aws.hostedZone</b>	An existing Route 53 private hosted zone for the cluster. You can only use a pre-existing hosted zone when also supplying your own VPC. The hosted zone must already be associated with the user-provided VPC before installation. Also, the domain of the hosted zone must be the cluster domain or a parent of the cluster domain. If undefined, the installation program creates a new hosted zone.	String, for example <b>Z3URY6TWQ91KVV</b> .
<b>platform.aws.serviceEndpoints.name</b>	The AWS service endpoint name. Custom endpoints are only required for cases where alternative AWS endpoints, like FIPS, must be used. Custom API endpoints can be specified for EC2, S3, IAM, Elastic Load Balancing, Tagging, Route 53, and STS AWS services.	Valid <a href="#">AWS service endpoint</a> name.
<b>platform.aws.serviceEndpoints.url</b>	The AWS service endpoint URL. The URL must use the <b>https</b> protocol and the host must trust the certificate.	Valid <a href="#">AWS service endpoint</a> URL.
<b>platform.aws.userTags</b>	A map of keys and values that the installation program adds as tags to all resources that it creates.	Any valid YAML map, such as key value pairs in the <b>&lt;key&gt;: &lt;value&gt;</b> format. For more information about AWS tags, see <a href="#">Tagging Your Amazon EC2 Resources</a> in the AWS documentation.

Parameter	Description	Values
<b>platform.aws.subnets</b>	If you provide the VPC instead of allowing the installation program to create the VPC for you, specify the subnet for the cluster to use. The subnet must be part of the same <b>machineNetwork[].cidr</b> ranges that you specify. For a standard cluster, specify a public and a private subnet for each availability zone. For a private cluster, specify a private subnet for each availability zone.	Valid subnet IDs.

### 5.8.6.2. Minimum resource requirements for cluster installation

Each cluster machine must meet the following minimum requirements:

**Table 5.27. Minimum resource requirements**

Machine	Operating System	vCPU [1]	Virtual RAM	Storage	IOPS [2]
Bootstrap	RHCOS	4	16 GB	100 GB	300
Control plane	RHCOS	4	16 GB	100 GB	300
Compute	RHCOS, RHEL 8.4, or RHEL 8.5 [3]	2	8 GB	100 GB	300

1. One vCPU is equivalent to one physical core when simultaneous multithreading (SMT), or hyperthreading, is not enabled. When enabled, use the following formula to calculate the corresponding ratio:  $(\text{threads per core} \times \text{cores}) \times \text{sockets} = \text{vCPUs}$ .
2. OpenShift Container Platform and Kubernetes are sensitive to disk performance, and faster storage is recommended, particularly for etcd on the control plane nodes which require a 10 ms p99 fsync duration. Note that on many cloud platforms, storage size and IOPS scale together, so you might need to over-allocate storage volume to obtain sufficient performance.
3. As with all user-provisioned installations, if you choose to use RHEL compute machines in your cluster, you take responsibility for all operating system life cycle management and maintenance, including performing system updates, applying patches, and completing all other required tasks. Use of RHEL 7 compute machines is deprecated and has been removed in OpenShift Container Platform 4.10 and later.

If an instance type for your platform meets the minimum requirements for cluster machines, it is supported to use in OpenShift Container Platform.

### 5.8.6.3. Tested instance types for AWS

The following Amazon Web Services (AWS) instance types have been tested with OpenShift Container Platform.



#### NOTE

Use the machine types included in the following charts for your AWS instances. If you use an instance type that is not listed in the chart, ensure that the instance size you use matches the minimum resource requirements that are listed in "Minimum resource requirements for cluster installation".

#### Example 5.20. Machine types based on 64-bit x86 architecture

- **c4.\***
- **c5.\***
- **c5a.\***
- **i3.\***
- **m4.\***
- **m5.\***
- **m5a.\***
- **m6i.\***
- **r4.\***
- **r5.\***
- **r5a.\***
- **r6i.\***
- **t3.\***
- **t3a.\***

### 5.8.6.4. Tested instance types for AWS on 64-bit ARM infrastructures

The following Amazon Web Services (AWS) ARM64 instance types have been tested with OpenShift Container Platform.



#### NOTE

Use the machine types included in the following charts for your AWS ARM instances. If you use an instance type that is not listed in the chart, ensure that the instance size you use matches the minimum resource requirements that are listed in "Minimum resource requirements for cluster installation".



### Example 5.21. Machine types based on 64-bit ARM architecture

- **c6g.\***
- **m6g.\***

#### 5.8.6.5. Sample customized install-config.yaml file for AWS

You can customize the installation configuration file (**install-config.yaml**) to specify more details about your OpenShift Container Platform cluster's platform or modify the values of the required parameters.

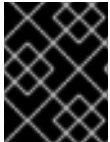

#### IMPORTANT

This sample YAML file is provided for reference only. You must obtain your **install-config.yaml** file by using the installation program and modify it.

```

apiVersion: v1
baseDomain: example.com 1
credentialsMode: Mint 2
controlPlane: 3 4
  hyperthreading: Enabled 5
  name: master
  platform:
    aws:
      zones:
      - us-west-2a
      - us-west-2b
    rootVolume:
      iops: 4000
      size: 500
      type: io1 6
      type: m6i.xlarge
    replicas: 3
compute: 7
- hyperthreading: Enabled 8
  name: worker
  platform:
    aws:
      rootVolume:
        iops: 2000
        size: 500
        type: io1 9
        type: c5.4xlarge
      zones:
      - us-west-2c
    replicas: 3
metadata:
  name: test-cluster 10
networking:
  clusterNetwork:
  - cidr: 10.128.0.0/14
  hostPrefix: 23

```

```

machineNetwork:
- cidr: 10.0.0.0/16
networkType: OpenShiftSDN
serviceNetwork:
- 172.30.0.0/16
platform:
aws:
region: us-west-2 11
userTags:
adminContact: jdoe
costCenter: 7536
subnets: 12
- subnet-1
- subnet-2
- subnet-3
amiID: ami-96c6f8f7 13
serviceEndpoints: 14
- name: ec2
url: https://vpce-id.ec2.us-west-2.vpce.amazonaws.com
hostedZone: Z3URY6TWQ91KVV 15
fips: false 16
sshKey: ssh-ed25519 AAAA... 17
pullSecret: '{"auths": ...}' 18

```

- 1 10 11 18** Required. The installation program prompts you for this value.
- 2** Optional: Add this parameter to force the Cloud Credential Operator (CCO) to use the specified mode, instead of having the CCO dynamically try to determine the capabilities of the credentials. For details about CCO modes, see the *Cloud Credential Operator* entry in the *Red Hat Operators reference* content.
- 3 7** If you do not provide these parameters and values, the installation program provides the default value.
- 4** The **controlPlane** section is a single mapping, but the **compute** section is a sequence of mappings. To meet the requirements of the different data structures, the first line of the **compute** section must begin with a hyphen, -, and the first line of the **controlPlane** section must not. Only one control plane pool is used.
- 5 8** Whether to enable or disable simultaneous multithreading, or **hyperthreading**. By default, simultaneous multithreading is enabled to increase the performance of your machines' cores. You can disable it by setting the parameter value to **Disabled**. If you disable simultaneous multithreading in some cluster machines, you must disable it in all cluster machines.



### IMPORTANT

If you disable simultaneous multithreading, ensure that your capacity planning accounts for the dramatically decreased machine performance. Use larger instance types, such as **m4.2xlarge** or **m5.2xlarge**, for your machines if you disable simultaneous multithreading.

- 6 9** To configure faster storage for etcd, especially for larger clusters, set the storage type as **io1** and set **iops** to **2000**.

- 12 If you provide your own VPC, specify subnets for each availability zone that your cluster uses.
- 13 The ID of the AMI used to boot machines for the cluster. If set, the AMI must belong to the same region as the cluster.
- 14 The AWS service endpoints. Custom endpoints are required when installing to an unknown AWS region. The endpoint URL must use the **https** protocol and the host must trust the certificate.
- 15 The ID of your existing Route 53 private hosted zone. Providing an existing hosted zone requires that you supply your own VPC and the hosted zone is already associated with the VPC prior to installing your cluster. If undefined, the installation program creates a new hosted zone.
- 16 Whether to enable or disable FIPS mode. By default, FIPS mode is not enabled. If FIPS mode is enabled, the Red Hat Enterprise Linux CoreOS (RHCOS) machines that OpenShift Container Platform runs on bypass the default Kubernetes cryptography suite and use the cryptography modules that are provided with RHCOS instead.



### IMPORTANT

To enable FIPS mode for your cluster, you must run the installation program from a Red Hat Enterprise Linux (RHEL) computer configured to operate in FIPS mode. For more information about configuring FIPS mode on RHEL, see [Installing the system in FIPS mode](#). The use of FIPS validated or Modules In Process cryptographic libraries is only supported on OpenShift Container Platform deployments on the **x86\_64** architecture.

- 17 You can optionally provide the **sshKey** value that you use to access the machines in your cluster.



### NOTE

For production OpenShift Container Platform clusters on which you want to perform installation debugging or disaster recovery, specify an SSH key that your **ssh-agent** process uses.

#### 5.8.6.6. Configuring the cluster-wide proxy during installation

Production environments can deny direct access to the internet and instead have an HTTP or HTTPS proxy available. You can configure a new OpenShift Container Platform cluster to use a proxy by configuring the proxy settings in the **install-config.yaml** file.

#### Prerequisites

- You have an existing **install-config.yaml** file.
- You reviewed the sites that your cluster requires access to and determined whether any of them need to bypass the proxy. By default, all cluster egress traffic is proxied, including calls to hosting cloud provider APIs. You added sites to the **Proxy** object's **spec.noProxy** field to bypass the proxy if necessary.



## NOTE

The **Proxy** object **status.noProxy** field is populated with the values of the **networking.machineNetwork[].cidr**, **networking.clusterNetwork[].cidr**, and **networking.serviceNetwork[]** fields from your installation configuration.

For installations on Amazon Web Services (AWS), Google Cloud Platform (GCP), Microsoft Azure, and Red Hat OpenStack Platform (RHOSP), the **Proxy** object **status.noProxy** field is also populated with the instance metadata endpoint (**169.254.169.254**).

- You have added the **ec2.<region>.amazonaws.com**, **elasticloadbalancing.<region>.amazonaws.com**, and **s3.<region>.amazonaws.com** endpoints to your VPC endpoint. These endpoints are required to complete requests from the nodes to the AWS EC2 API. Because the proxy works on the container level, not the node level, you must route these requests to the AWS EC2 API through the AWS private network. Adding the public IP address of the EC2 API to your allowlist in your proxy server is not sufficient.

## Procedure

- Edit your **install-config.yaml** file and add the proxy settings. For example:

```
apiVersion: v1
baseDomain: my.domain.com
proxy:
  httpProxy: http://<username>:<pswd>@<ip>:<port> 1
  httpsProxy: https://<username>:<pswd>@<ip>:<port> 2
  noProxy: example.com 3
  additionalTrustBundle: | 4
    -----BEGIN CERTIFICATE-----
    <MY_TRUSTED_CA_CERT>
    -----END CERTIFICATE-----
  ...
```

- A proxy URL to use for creating HTTP connections outside the cluster. The URL scheme must be **http**.
- A proxy URL to use for creating HTTPS connections outside the cluster.
- A comma-separated list of destination domain names, IP addresses, or other network CIDRs to exclude from proxying. Preface a domain with **.** to match subdomains only. For example, **.y.com** matches **x.y.com**, but not **y.com**. Use **\*** to bypass the proxy for all destinations.
- If provided, the installation program generates a config map that is named **user-ca-bundle** in the **openshift-config** namespace that contains one or more additional CA certificates that are required for proxying HTTPS connections. The Cluster Network Operator then creates a **trusted-ca-bundle** config map that merges these contents with the Red Hat Enterprise Linux CoreOS (RHCOS) trust bundle, and this config map is referenced in the **trustedCA** field of the **Proxy** object. The **additionalTrustBundle** field is required unless the proxy's identity certificate is signed by an authority from the RHCOS trust bundle.

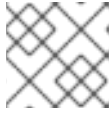
**NOTE**

The installation program does not support the proxy **readinessEndpoints** field.

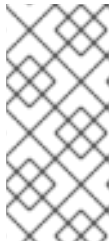
**NOTE**

If the installer times out, restart and then complete the deployment by using the **wait-for** command of the installer. For example:

```
$ ./openshift-install wait-for install-complete --log-level debug
```

2. Save the file and reference it when installing OpenShift Container Platform.

The installation program creates a cluster-wide proxy that is named **cluster** that uses the proxy settings in the provided **install-config.yaml** file. If no proxy settings are provided, a **cluster Proxy** object is still created, but it will have a nil **spec**.

**NOTE**

Only the **Proxy** object named **cluster** is supported, and no additional proxies can be created.

### 5.8.7. Deploying the cluster

You can install OpenShift Container Platform on a compatible cloud platform.

**IMPORTANT**

You can run the **create cluster** command of the installation program only once, during initial installation.

#### Prerequisites

- Configure an account with the cloud platform that hosts your cluster.
- Obtain the OpenShift Container Platform installation program and the pull secret for your cluster.

#### Procedure

1. Change to the directory that contains the installation program and initialize the cluster deployment:

```
$ ./openshift-install create cluster --dir <installation_directory> \ 1
--log-level=info 2
```

**1** For **<installation\_directory>**, specify the location of your customized **./install-config.yaml** file.

**2** To view different installation details, specify **warn**, **debug**, or **error** instead of **info**.

**NOTE**

If the cloud provider account that you configured on your host does not have sufficient permissions to deploy the cluster, the installation process stops, and the missing permissions are displayed.

When the cluster deployment completes, directions for accessing your cluster, including a link to its web console and credentials for the **kubeadmin** user, display in your terminal.

**Example output**

```
...
INFO Install complete!
INFO To access the cluster as the system:admin user when using 'oc', run 'export
KUBECONFIG=/home/myuser/install_dir/auth/kubeconfig'
INFO Access the OpenShift web-console here: https://console-openshift-
console.apps.mycluster.example.com
INFO Login to the console with user: "kubeadmin", and password: "4vYBz-Ee6gm-ymBZj-
Wt5AL"
INFO Time elapsed: 36m22s
```

**NOTE**

The cluster access and credential information also outputs to **<installation\_directory>/.openshift\_install.log** when an installation succeeds.

**IMPORTANT**

- The Ignition config files that the installation program generates contain certificates that expire after 24 hours, which are then renewed at that time. If the cluster is shut down before renewing the certificates and the cluster is later restarted after the 24 hours have elapsed, the cluster automatically recovers the expired certificates. The exception is that you must manually approve the pending **node-bootstrapper** certificate signing requests (CSRs) to recover kubelet certificates. See the documentation for *Recovering from expired control plane certificates* for more information.
- It is recommended that you use Ignition config files within 12 hours after they are generated because the 24-hour certificate rotates from 16 to 22 hours after the cluster is installed. By using the Ignition config files within 12 hours, you can avoid installation failure if the certificate update runs during installation.

**IMPORTANT**

You must not delete the installation program or the files that the installation program creates. Both are required to delete the cluster.

2. Optional: Remove or disable the **AdministratorAccess** policy from the IAM account that you used to install the cluster.

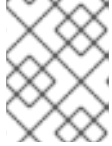
**NOTE**

The elevated permissions provided by the **AdministratorAccess** policy are required only during installation.

### 5.8.8. Installing the OpenShift CLI by downloading the binary

You can install the OpenShift CLI (**oc**) to interact with OpenShift Container Platform from a command-line interface. You can install **oc** on Linux, Windows, or macOS.

**IMPORTANT**

If you installed an earlier version of **oc**, you cannot use it to complete all of the commands in OpenShift Container Platform 4.10. Download and install the new version of **oc**.

#### Installing the OpenShift CLI on Linux

You can install the OpenShift CLI (**oc**) binary on Linux by using the following procedure.

##### Procedure

1. Navigate to the [OpenShift Container Platform downloads page](#) on the Red Hat Customer Portal.
2. Select the appropriate version in the **Version** drop-down menu.
3. Click **Download Now** next to the **OpenShift v4.10 Linux Client** entry and save the file.
4. Unpack the archive:

```
$ tar xvf <file>
```

5. Place the **oc** binary in a directory that is on your **PATH**.  
To check your **PATH**, execute the following command:

```
$ echo $PATH
```

After you install the OpenShift CLI, it is available using the **oc** command:

```
$ oc <command>
```

#### Installing the OpenShift CLI on Windows

You can install the OpenShift CLI (**oc**) binary on Windows by using the following procedure.

##### Procedure

1. Navigate to the [OpenShift Container Platform downloads page](#) on the Red Hat Customer Portal.
2. Select the appropriate version in the **Version** drop-down menu.
3. Click **Download Now** next to the **OpenShift v4.10 Windows Client** entry and save the file.
4. Unzip the archive with a ZIP program.

5. Move the **oc** binary to a directory that is on your **PATH**.  
To check your **PATH**, open the command prompt and execute the following command:

```
C:\> path
```

After you install the OpenShift CLI, it is available using the **oc** command:

```
C:\> oc <command>
```

### Installing the OpenShift CLI on macOS

You can install the OpenShift CLI (**oc**) binary on macOS by using the following procedure.

#### Procedure

1. Navigate to the [OpenShift Container Platform downloads page](#) on the Red Hat Customer Portal.
2. Select the appropriate version in the **Version** drop-down menu.
3. Click **Download Now** next to the **OpenShift v4.10 MacOSX Client** entry and save the file.
4. Unpack and unzip the archive.
5. Move the **oc** binary to a directory on your PATH.  
To check your **PATH**, open a terminal and execute the following command:

```
$ echo $PATH
```

After you install the OpenShift CLI, it is available using the **oc** command:

```
$ oc <command>
```

### 5.8.9. Logging in to the cluster by using the CLI

You can log in to your cluster as a default system user by exporting the cluster **kubeconfig** file. The **kubeconfig** file contains information about the cluster that is used by the CLI to connect a client to the correct cluster and API server. The file is specific to a cluster and is created during OpenShift Container Platform installation.

#### Prerequisites

- You deployed an OpenShift Container Platform cluster.
- You installed the **oc** CLI.

#### Procedure

1. Export the **kubeadmin** credentials:

```
$ export KUBECONFIG=<installation_directory>/auth/kubeconfig 1
```

- 1** For **<installation\_directory>**, specify the path to the directory that you stored the installation files in.



2. Verify you can run **oc** commands successfully using the exported configuration:

```
$ oc whoami
```

#### Example output

```
system:admin
```

### 5.8.10. Logging in to the cluster by using the web console

The **kubeadmin** user exists by default after an OpenShift Container Platform installation. You can log in to your cluster as the **kubeadmin** user by using the OpenShift Container Platform web console.

#### Prerequisites

- You have access to the installation host.
- You completed a cluster installation and all cluster Operators are available.

#### Procedure

1. Obtain the password for the **kubeadmin** user from the **kubeadmin-password** file on the installation host:

```
$ cat <installation_directory>/auth/kubeadmin-password
```



#### NOTE

Alternatively, you can obtain the **kubeadmin** password from the **<installation\_directory>/openshift\_install.log** log file on the installation host.

2. List the OpenShift Container Platform web console route:

```
$ oc get routes -n openshift-console | grep 'console-openshift'
```

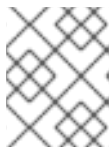

#### NOTE

Alternatively, you can obtain the OpenShift Container Platform route from the **<installation\_directory>/openshift\_install.log** log file on the installation host.

#### Example output

```
console console-openshift-console.apps.<cluster_name>.<base_domain> console
https reencrypt/Redirect None
```

3. Navigate to the route detailed in the output of the preceding command in a web browser and log in as the **kubeadmin** user.

#### Additional resources

- See [Accessing the web console](#) for more details about accessing and understanding the OpenShift Container Platform web console.

### 5.8.11. Telemetry access for OpenShift Container Platform

In OpenShift Container Platform 4.10, the Telemetry service, which runs by default to provide metrics about cluster health and the success of updates, requires internet access. If your cluster is connected to the internet, Telemetry runs automatically, and your cluster is registered to [OpenShift Cluster Manager](#).

After you confirm that your [OpenShift Cluster Manager](#) inventory is correct, either maintained automatically by Telemetry or manually by using OpenShift Cluster Manager, [use subscription watch](#) to track your OpenShift Container Platform subscriptions at the account or multi-cluster level.

#### Additional resources

- See [About remote health monitoring](#) for more information about the Telemetry service.

### 5.8.12. Next steps

- [Validating an installation.](#)
- [Customize your cluster.](#)
- If necessary, you can [opt out of remote health reporting](#) .
- If necessary, you can [remove cloud provider credentials](#).

## 5.9. INSTALLING A PRIVATE CLUSTER ON AWS

In OpenShift Container Platform version 4.10, you can install a private cluster into an existing VPC on Amazon Web Services (AWS). The installation program provisions the rest of the required infrastructure, which you can further customize. To customize the installation, you modify parameters in the **install-config.yaml** file before you install the cluster.

### 5.9.1. Prerequisites

- You reviewed details about the [OpenShift Container Platform installation and update](#) processes.
- You read the documentation on [selecting a cluster installation method and preparing it for users](#).
- You [configured an AWS account](#) to host the cluster.

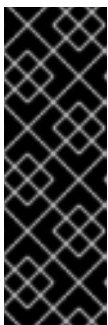

#### IMPORTANT

If you have an AWS profile stored on your computer, it must not use a temporary session token that you generated while using a multi-factor authentication device. The cluster continues to use your current AWS credentials to create AWS resources for the entire life of the cluster, so you must use long-lived credentials. To generate appropriate keys, see [Managing Access Keys for IAM Users](#) in the AWS documentation. You can supply the keys when you run the installation program.

- If you use a firewall, you [configured it to allow the sites](#) that your cluster requires access to.
- If the cloud identity and access management (IAM) APIs are not accessible in your environment, or if you do not want to store an administrator-level credential secret in the **kube-system** namespace, you can [manually create and maintain IAM credentials](#).

## 5.9.2. Private clusters

You can deploy a private OpenShift Container Platform cluster that does not expose external endpoints. Private clusters are accessible from only an internal network and are not visible to the internet.

By default, OpenShift Container Platform is provisioned to use publicly-accessible DNS and endpoints. A private cluster sets the DNS, Ingress Controller, and API server to private when you deploy your cluster. This means that the cluster resources are only accessible from your internal network and are not visible to the internet.



### IMPORTANT

If the cluster has any public subnets, load balancer services created by administrators might be publicly accessible. To ensure cluster security, verify that these services are explicitly annotated as private.

To deploy a private cluster, you must:

- Use existing networking that meets your requirements. Your cluster resources might be shared between other clusters on the network.
- Deploy from a machine that has access to:
  - The API services for the cloud to which you provision.
  - The hosts on the network that you provision.
  - The internet to obtain installation media.

You can use any machine that meets these access requirements and follows your company's guidelines. For example, this machine can be a bastion host on your cloud network or a machine that has access to the network through a VPN.

### 5.9.2.1. Private clusters in AWS

To create a private cluster on Amazon Web Services (AWS), you must provide an existing private VPC and subnets to host the cluster. The installation program must also be able to resolve the DNS records that the cluster requires. The installation program configures the Ingress Operator and API server for access from only the private network.

The cluster still requires access to internet to access the AWS APIs.

The following items are not required or created when you install a private cluster:

- Public subnets
- Public load balancers, which support public ingress
- A public Route 53 zone that matches the **baseDomain** for the cluster

The installation program does use the **baseDomain** that you specify to create a private Route 53 zone and the required records for the cluster. The cluster is configured so that the Operators do not create public records for the cluster and all cluster machines are placed in the private subnets that you specify.

#### 5.9.2.1.1. Limitations

The ability to add public functionality to a private cluster is limited.

- You cannot make the Kubernetes API endpoints public after installation without taking additional actions, including creating public subnets in the VPC for each availability zone in use, creating a public load balancer, and configuring the control plane security groups to allow traffic from the internet on 6443 (Kubernetes API port).
- If you use a public Service type load balancer, you must tag a public subnet in each availability zone with **kubernetes.io/cluster/<cluster-infra-id>: shared** so that AWS can use them to create public load balancers.

### 5.9.3. About using a custom VPC

In OpenShift Container Platform 4.10, you can deploy a cluster into existing subnets in an existing Amazon Virtual Private Cloud (VPC) in Amazon Web Services (AWS). By deploying OpenShift Container Platform into an existing AWS VPC, you might be able to avoid limit constraints in new accounts or more easily abide by the operational constraints that your company's guidelines set. If you cannot obtain the infrastructure creation permissions that are required to create the VPC yourself, use this installation option.

Because the installation program cannot know what other components are also in your existing subnets, it cannot choose subnet CIDRs and so forth on your behalf. You must configure networking for the subnets that you install your cluster to yourself.

#### 5.9.3.1. Requirements for using your VPC

The installation program no longer creates the following components:

- Internet gateways
- NAT gateways
- Subnets
- Route tables
- VPCs
- VPC DHCP options
- VPC endpoints



#### NOTE

The installation program requires that you use the cloud-provided DNS server. Using a custom DNS server is not supported and causes the installation to fail.

If you use a custom VPC, you must correctly configure it and its subnets for the installation program and the cluster to use. See [Amazon VPC console wizard configurations](#) and [Work with VPCs and subnets](#) in the AWS documentation for more information on creating and managing an AWS VPC.

The installation program cannot:

- Subdivide network ranges for the cluster to use.
- Set route tables for the subnets.
- Set VPC options like DHCP.

You must complete these tasks before you install the cluster. See [VPC networking components](#) and [Route tables for your VPC](#) for more information on configuring networking in an AWS VPC.

Your VPC must meet the following characteristics:

- The VPC must not use the **kubernetes.io/cluster/.\*: owned** tag. The installation program modifies your subnets to add the **kubernetes.io/cluster/.\*: shared** tag, so your subnets must have at least one free tag slot available for it. See [Tag Restrictions](#) in the AWS documentation to confirm that the installation program can add a tag to each subnet that you specify.
- You must enable the **enableDnsSupport** and **enableDnsHostnames** attributes in your VPC, so that the cluster can use the Route 53 zones that are attached to the VPC to resolve cluster's internal DNS records. See [DNS Support in Your VPC](#) in the AWS documentation. If you prefer to use your own Route 53 hosted private zone, you must associate the existing hosted zone with your VPC prior to installing a cluster. You can define your hosted zone using the **platform.aws.hostedZone** field in the **install-config.yaml** file.

If you are working in a disconnected environment, you are unable to reach the public IP addresses for EC2 and ELB endpoints. To resolve this, you must create a VPC endpoint and attach it to the subnet that the clusters are using. The endpoints should be named as follows:

- **ec2.<region>.amazonaws.com**
- **elasticloadbalancing.<region>.amazonaws.com**
- **s3.<region>.amazonaws.com**

## Required VPC components

You must provide a suitable VPC and subnets that allow communication to your machines.

Component	AWS type	Description
VPC	<ul style="list-style-type: none"> <li>• <b>AWS::EC2::VPC</b></li> <li>• <b>AWS::EC2::VPCEndpoint</b></li> </ul>	You must provide a public VPC for the cluster to use. The VPC uses an endpoint that references the route tables for each subnet to improve communication with the registry that is hosted in S3.

Component	AWS type	Description												
Public subnets	<ul style="list-style-type: none"> <li>● <b>AWS::EC2::Subnet</b></li> <li>● <b>AWS::EC2::SubnetNetworkACLAssociation</b></li> </ul>	Your VPC must have public subnets for between 1 and 3 availability zones and associate them with appropriate Ingress rules.												
Internet gateway	<ul style="list-style-type: none"> <li>● <b>AWS::EC2::InternetGateway</b></li> <li>● <b>AWS::EC2::VPCElasticGatewayAttachment</b></li> <li>● <b>AWS::EC2::RouteTable</b></li> <li>● <b>AWS::EC2::Route</b></li> <li>● <b>AWS::EC2::SubnetRouteTableAssociation</b></li> <li>● <b>AWS::EC2::NATGateway</b></li> <li>● <b>AWS::EC2::EIP</b></li> </ul>	You must have a public internet gateway, with public routes, attached to the VPC. In the provided templates, each public subnet has a NAT gateway with an EIP address. These NAT gateways allow cluster resources, like private subnet instances, to reach the internet and are not required for some restricted network or proxy scenarios.												
Network access control	<ul style="list-style-type: none"> <li>● <b>AWS::EC2::NetworkACL</b></li> <li>● <b>AWS::EC2::NetworkACLEntry</b></li> </ul>	<p>You must allow the VPC to access the following ports:</p> <table border="1"> <thead> <tr> <th>Port</th> <th>Reason</th> </tr> </thead> <tbody> <tr> <td><b>80</b></td> <td>Inbound HTTP traffic</td> </tr> <tr> <td><b>443</b></td> <td>Inbound HTTPS traffic</td> </tr> <tr> <td><b>22</b></td> <td>Inbound SSH traffic</td> </tr> <tr> <td><b>1024 - 65535</b></td> <td>Inbound ephemeral traffic</td> </tr> <tr> <td><b>0 - 65535</b></td> <td>Outbound ephemeral traffic</td> </tr> </tbody> </table>	Port	Reason	<b>80</b>	Inbound HTTP traffic	<b>443</b>	Inbound HTTPS traffic	<b>22</b>	Inbound SSH traffic	<b>1024 - 65535</b>	Inbound ephemeral traffic	<b>0 - 65535</b>	Outbound ephemeral traffic
Port	Reason													
<b>80</b>	Inbound HTTP traffic													
<b>443</b>	Inbound HTTPS traffic													
<b>22</b>	Inbound SSH traffic													
<b>1024 - 65535</b>	Inbound ephemeral traffic													
<b>0 - 65535</b>	Outbound ephemeral traffic													
Private subnets	<ul style="list-style-type: none"> <li>● <b>AWS::EC2::Subnet</b></li> <li>● <b>AWS::EC2::RouteTable</b></li> <li>● <b>AWS::EC2::SubnetRouteTableAssociation</b></li> </ul>	Your VPC can have private subnets. The provided CloudFormation templates can create private subnets for between 1 and 3 availability zones. If you use private subnets, you must provide appropriate routes and tables for them.												

### 5.9.3.2. VPC validation

To ensure that the subnets that you provide are suitable, the installation program confirms the following data:

- All the subnets that you specify exist.
- You provide private subnets.
- The subnet CIDRs belong to the machine CIDR that you specified.
- You provide subnets for each availability zone. Each availability zone contains no more than one public and one private subnet. If you use a private cluster, provide only a private subnet for each availability zone. Otherwise, provide exactly one public and private subnet for each availability zone.
- You provide a public subnet for each private subnet availability zone. Machines are not provisioned in availability zones that you do not provide private subnets for.

If you destroy a cluster that uses an existing VPC, the VPC is not deleted. When you remove the OpenShift Container Platform cluster from a VPC, the **kubernetes.io/cluster/.\*: shared** tag is removed from the subnets that it used.

### 5.9.3.3. Division of permissions

Starting with OpenShift Container Platform 4.3, you do not need all of the permissions that are required for an installation program-provisioned infrastructure cluster to deploy a cluster. This change mimics the division of permissions that you might have at your company: some individuals can create different resource in your clouds than others. For example, you might be able to create application-specific items, like instances, buckets, and load balancers, but not networking-related components such as VPCs, subnets, or ingress rules.

The AWS credentials that you use when you create your cluster do not need the networking permissions that are required to make VPCs and core networking components within the VPC, such as subnets, routing tables, internet gateways, NAT, and VPN. You still need permission to make the application resources that the machines within the cluster require, such as ELBs, security groups, S3 buckets, and nodes.

### 5.9.3.4. Isolation between clusters

If you deploy OpenShift Container Platform to an existing network, the isolation of cluster services is reduced in the following ways:

- You can install multiple OpenShift Container Platform clusters in the same VPC.
- ICMP ingress is allowed from the entire network.
- TCP 22 ingress (SSH) is allowed to the entire network.
- Control plane TCP 6443 ingress (Kubernetes API) is allowed to the entire network.
- Control plane TCP 22623 ingress (MCS) is allowed to the entire network.

## 5.9.4. Internet access for OpenShift Container Platform

In OpenShift Container Platform 4.10, you require access to the internet to install your cluster.

You must have internet access to:

- Access [OpenShift Cluster Manager](#) to download the installation program and perform subscription management. If the cluster has internet access and you do not disable Telemetry, that service automatically entitles your cluster.
- Access [Quay.io](#) to obtain the packages that are required to install your cluster.
- Obtain the packages that are required to perform cluster updates.



### IMPORTANT

If your cluster cannot have direct internet access, you can perform a restricted network installation on some types of infrastructure that you provision. During that process, you download the required content and use it to populate a mirror registry with the installation packages. With some installation types, the environment that you install your cluster in will not require internet access. Before you update the cluster, you update the content of the mirror registry.

## 5.9.5. Generating a key pair for cluster node SSH access

During an OpenShift Container Platform installation, you can provide an SSH public key to the installation program. The key is passed to the Red Hat Enterprise Linux CoreOS (RHCOS) nodes through their Ignition config files and is used to authenticate SSH access to the nodes. The key is added to the `~/.ssh/authorized_keys` list for the **core** user on each node, which enables password-less authentication.

After the key is passed to the nodes, you can use the key pair to SSH in to the RHCOS nodes as the user **core**. To access the nodes through SSH, the private key identity must be managed by SSH for your local user.

If you want to SSH in to your cluster nodes to perform installation debugging or disaster recovery, you must provide the SSH public key during the installation process. The `./openshift-install gather` command also requires the SSH public key to be in place on the cluster nodes.



### IMPORTANT

Do not skip this procedure in production environments, where disaster recovery and debugging is required.



### NOTE

You must use a local key, not one that you configured with platform-specific approaches such as [AWS key pairs](#).

### Procedure

1. If you do not have an existing SSH key pair on your local machine to use for authentication onto your cluster nodes, create one. For example, on a computer that uses a Linux operating system, run the following command:

```
$ ssh-keygen -t ed25519 -N "" -f <path>/<file_name> 1
```



- 1 Specify the path and file name, such as `~/.ssh/id_ed25519`, of the new SSH key. If you have an existing key pair, ensure your public key is in the your `~/.ssh` directory.

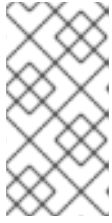

#### NOTE

If you plan to install an OpenShift Container Platform cluster that uses FIPS validated or Modules In Process cryptographic libraries on the **x86\_64** architecture, do not create a key that uses the **ed25519** algorithm. Instead, create a key that uses the **rsa** or **ecdsa** algorithm.

2. View the public SSH key:

```
$ cat <path>/<file_name>.pub
```

For example, run the following to view the `~/.ssh/id_ed25519.pub` public key:

```
$ cat ~/.ssh/id_ed25519.pub
```

3. Add the SSH private key identity to the SSH agent for your local user, if it has not already been added. SSH agent management of the key is required for password-less SSH authentication onto your cluster nodes, or if you want to use the **./openshift-install gather** command.

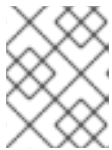

#### NOTE

On some distributions, default SSH private key identities such as `~/.ssh/id_rsa` and `~/.ssh/id_dsa` are managed automatically.

- a. If the **ssh-agent** process is not already running for your local user, start it as a background task:

```
$ eval "$(ssh-agent -s)"
```

#### Example output

```
Agent pid 31874
```



#### NOTE

If your cluster is in FIPS mode, only use FIPS-compliant algorithms to generate the SSH key. The key must be either RSA or ECDSA.

4. Add your SSH private key to the **ssh-agent**:

```
$ ssh-add <path>/<file_name> 1
```

- 1 Specify the path and file name for your SSH private key, such as `~/.ssh/id_ed25519`

#### Example output

Identity added: /home/<you>/<path>/<file\_name> (<computer\_name>)

### Next steps

- When you install OpenShift Container Platform, provide the SSH public key to the installation program.

## 5.9.6. Obtaining the installation program

Before you install OpenShift Container Platform, download the installation file on a local computer.

### Prerequisites

- You have a computer that runs Linux or macOS, with 500 MB of local disk space

### Procedure

1. Access the [Infrastructure Provider](#) page on the OpenShift Cluster Manager site. If you have a Red Hat account, log in with your credentials. If you do not, create an account.
2. Select your infrastructure provider.
3. Navigate to the page for your installation type, download the installation program that corresponds with your host operating system and architecture, and place the file in the directory where you will store the installation configuration files.



#### IMPORTANT

The installation program creates several files on the computer that you use to install your cluster. You must keep the installation program and the files that the installation program creates after you finish installing the cluster. Both files are required to delete the cluster.



#### IMPORTANT

Deleting the files created by the installation program does not remove your cluster, even if the cluster failed during installation. To remove your cluster, complete the OpenShift Container Platform uninstallation procedures for your specific cloud provider.

4. Extract the installation program. For example, on a computer that uses a Linux operating system, run the following command:

```
$ tar -xvf openshift-install-linux.tar.gz
```

5. Download your installation [pull secret from the Red Hat OpenShift Cluster Manager](#) . This pull secret allows you to authenticate with the services that are provided by the included authorities, including Quay.io, which serves the container images for OpenShift Container Platform components.

## 5.9.7. Manually creating the installation configuration file

For installations of a private OpenShift Container Platform cluster that are only accessible from an internal network and are not visible to the internet, you must manually generate your installation configuration file.

## Prerequisites

- You have an SSH public key on your local machine to provide to the installation program. The key will be used for SSH authentication onto your cluster nodes for debugging and disaster recovery.
- You have obtained the OpenShift Container Platform installation program and the pull secret for your cluster.

## Procedure

1. Create an installation directory to store your required installation assets in:

```
$ mkdir <installation_directory>
```

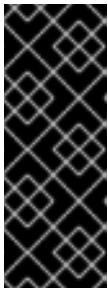

### IMPORTANT

You must create a directory. Some installation assets, like bootstrap X.509 certificates have short expiration intervals, so you must not reuse an installation directory. If you want to reuse individual files from another cluster installation, you can copy them into your directory. However, the file names for the installation assets might change between releases. Use caution when copying installation files from an earlier OpenShift Container Platform version.

2. Customize the sample **install-config.yaml** file template that is provided and save it in the **<installation\_directory>**.



### NOTE

You must name this configuration file **install-config.yaml**.



### NOTE

For some platform types, you can alternatively run **./openshift-install create install-config --dir <installation\_directory>** to generate an **install-config.yaml** file. You can provide details about your cluster configuration at the prompts.

3. Back up the **install-config.yaml** file so that you can use it to install multiple clusters.

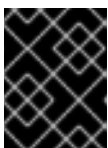

### IMPORTANT

The **install-config.yaml** file is consumed during the next step of the installation process. You must back it up now.

### 5.9.7.1. Installation configuration parameters

Before you deploy an OpenShift Container Platform cluster, you provide parameter values to describe your account on the cloud platform that hosts your cluster and optionally customize your cluster's platform. When you create the **install-config.yaml** installation configuration file, you provide values for

the required parameters through the command line. If you customize your cluster, you can modify the **install-config.yaml** file to provide more details about the platform.

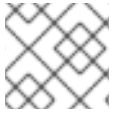

## NOTE

After installation, you cannot modify these parameters in the **install-config.yaml** file.

### 5.9.7.1.1. Required configuration parameters

Required installation configuration parameters are described in the following table:

Table 5.28. Required parameters

Parameter	Description	Values
<b>apiVersion</b>	The API version for the <b>install-config.yaml</b> content. The current version is <b>v1</b> . The installer may also support older API versions.	String
<b>baseDomain</b>	The base domain of your cloud provider. The base domain is used to create routes to your OpenShift Container Platform cluster components. The full DNS name for your cluster is a combination of the <b>baseDomain</b> and <b>metadata.name</b> parameter values that uses the <b>&lt;metadata.name&gt;</b> . <b>&lt;baseDomain&gt;</b> format.	A fully-qualified domain or subdomain name, such as <b>example.com</b> .
<b>metadata</b>	Kubernetes resource <b>ObjectMeta</b> , from which only the <b>name</b> parameter is consumed.	Object
<b>metadata.name</b>	The name of the cluster. DNS records for the cluster are all subdomains of <b>{{.metadata.name}}</b> . <b>{{.baseDomain}}</b> .	String of lowercase letters, hyphens (-), and periods (.), such as <b>dev</b> .

Parameter	Description	Values
<b>platform</b>	The configuration for the specific platform upon which to perform the installation: <b>alibabacloud</b> , <b>aws</b> , <b>baremetal</b> , <b>azure</b> , <b>gcp</b> , <b>ibmcloud</b> , <b>openstack</b> , <b>ovirt</b> , <b>vsphere</b> , or <b>{}</b> . For additional information about <b>platform.&lt;platform&gt;</b> parameters, consult the table for your specific platform that follows.	Object
<b>pullSecret</b>	Get a <a href="#">pull secret from the Red Hat OpenShift Cluster Manager</a> to authenticate downloading container images for OpenShift Container Platform components from services such as Quay.io.	<pre>{   "auths":{     "cloud.openshift.com":{       "auth":"b3Blb=",       "email":"you@example.com"     },     "quay.io":{       "auth":"b3Blb=",       "email":"you@example.com"     }   } }</pre>

### 5.9.7.1.2. Network configuration parameters

You can customize your installation configuration based on the requirements of your existing network infrastructure. For example, you can expand the IP address block for the cluster network or provide different IP address blocks than the defaults.

Only IPv4 addresses are supported.

**Table 5.29. Network parameters**

Parameter	Description	Values
<b>networking</b>	The configuration for the cluster network.	<p>Object</p>  <p><b>NOTE</b></p> <p>You cannot modify parameters specified by the <b>networking</b> object after installation.</p>

Parameter	Description	Values
<b>networking.networkType</b>	The cluster network provider Container Network Interface (CNI) plugin to install.	Either <b>OpenShiftSDN</b> or <b>OVNKubernetes</b> . <b>OpenShiftSDN</b> is a CNI provider for all-Linux networks. <b>OVNKubernetes</b> is a CNI provider for Linux networks and hybrid networks that contain both Linux and Windows servers. The default value is <b>OpenShiftSDN</b> .
<b>networking.clusterNetwork</b>	The IP address blocks for pods.  The default value is <b>10.128.0.0/14</b> with a host prefix of <b>/23</b> .  If you specify multiple IP address blocks, the blocks must not overlap.	An array of objects. For example:  <pre>networking:   clusterNetwork:     - cidr: 10.128.0.0/14       hostPrefix: 23</pre>
<b>networking.clusterNetwork.cidr</b>	Required if you use <b>networking.clusterNetwork</b> . An IP address block.  An IPv4 network.	An IP address block in Classless Inter-Domain Routing (CIDR) notation. The prefix length for an IPv4 block is between <b>0</b> and <b>32</b> .
<b>networking.clusterNetwork.hostPrefix</b>	The subnet prefix length to assign to each individual node. For example, if <b>hostPrefix</b> is set to <b>23</b> then each node is assigned a <b>/23</b> subnet out of the given <b>cidr</b> . A <b>hostPrefix</b> value of <b>23</b> provides 510 ( $2^{(32 - 23)} - 2$ ) pod IP addresses.	A subnet prefix.  The default value is <b>23</b> .
<b>networking.serviceNetwork</b>	The IP address block for services. The default value is <b>172.30.0.0/16</b> .  The OpenShift SDN and OVN-Kubernetes network providers support only a single IP address block for the service network.	An array with an IP address block in CIDR format. For example:  <pre>networking:   serviceNetwork:     - 172.30.0.0/16</pre>
<b>networking.machineNetwork</b>	The IP address blocks for machines.  If you specify multiple IP address blocks, the blocks must not overlap.	An array of objects. For example:  <pre>networking:   machineNetwork:     - cidr: 10.0.0.0/16</pre>

Parameter	Description	Values
<b>networking.machineNetwork.cidr</b>	Required if you use <b>networking.machineNetwork</b> . An IP address block. The default value is <b>10.0.0.0/16</b> for all platforms other than libvirt. For libvirt, the default value is <b>192.168.126.0/24</b> .	An IP network block in CIDR notation. For example, <b>10.0.0.0/16</b> .  <b>NOTE</b> Set the <b>networking.machineNetwork</b> to match the CIDR that the preferred NIC resides in.

### 5.9.7.1.3. Optional configuration parameters

Optional installation configuration parameters are described in the following table:



Table 5.30. Optional parameters



Parameter	Description	Values
<b>additionalTrustBundle</b>	A PEM-encoded X.509 certificate bundle that is added to the nodes' trusted certificate store. This trust bundle may also be used when a proxy has been configured.	String
<b>cgroupsV2</b>	Enables <a href="#">Linux control groups version 2</a> (cgroups v2) on specific nodes in your cluster. The OpenShift Container Platform process for enabling cgroups v2 disables all cgroup version 1 controllers and hierarchies. The OpenShift Container Platform cgroups version 2 feature is in Developer Preview and is not supported by Red Hat at this time.	<b>true</b>
<b>compute</b>	The configuration for the machines that comprise the compute nodes.	Array of <b>MachinePool</b> objects.

Parameter	Description	Values
<b>compute.architecture</b>	Determines the instruction set architecture of the machines in the pool. Currently, clusters with varied architectures are not supported. All pools must specify the same architecture. Valid values are <b>amd64</b> and <b>arm64</b> . See <i>Supported installation methods for different platforms</i> in <i>Installing</i> documentation for information about instance availability.	String
<b>compute.hyperthreading</b>	Whether to enable or disable simultaneous multithreading, or <b>hyperthreading</b> , on compute machines. By default, simultaneous multithreading is enabled to increase the performance of your machines' cores.   <b>IMPORTANT</b>  If you disable simultaneous multithreading, ensure that your capacity planning accounts for the dramatically decreased machine performance.	<b>Enabled</b> or <b>Disabled</b>
<b>compute.name</b>	Required if you use <b>compute</b> . The name of the machine pool.	<b>worker</b>
<b>compute.platform</b>	Required if you use <b>compute</b> . Use this parameter to specify the cloud provider to host the worker machines. This parameter value must match the <b>controlPlane.platform</b> parameter value.	<b>alibabacloud, aws, azure, gcp, ibmcloud, openstack, ovirt, vsphere, or {}</b>
<b>compute.replicas</b>	The number of compute machines, which are also known as worker machines, to provision.	A positive integer greater than or equal to <b>2</b> . The default value is <b>3</b> .
<b>controlPlane</b>	The configuration for the machines that comprise the control plane.	Array of <b>MachinePool</b> objects.



Parameter	Description	Values
<b>controlPlane.architecture</b>	Determines the instruction set architecture of the machines in the pool. Currently, clusters with varied architectures are not supported. All pools must specify the same architecture. Valid values are <b>amd64</b> and <b>arm64</b> . See <i>Supported installation methods for different platforms</i> in <i>Installing</i> documentation for information about instance availability.	String
<b>controlPlane.hypertreading</b>	Whether to enable or disable simultaneous multithreading, or <b>hyperthreading</b> , on control plane machines. By default, simultaneous multithreading is enabled to increase the performance of your machines' cores.   <b>IMPORTANT</b> If you disable simultaneous multithreading, ensure that your capacity planning accounts for the dramatically decreased machine performance.	<b>Enabled</b> or <b>Disabled</b>
<b>controlPlane.name</b>	Required if you use <b>controlPlane</b> . The name of the machine pool.	<b>master</b>
<b>controlPlane.platform</b>	Required if you use <b>controlPlane</b> . Use this parameter to specify the cloud provider that hosts the control plane machines. This parameter value must match the <b>compute.platform</b> parameter value.	<b>alibabacloud, aws, azure, gcp, ibmcloud, openstack, ovirt, vsphere, or {}</b>
<b>controlPlane.replicas</b>	The number of control plane machines to provision.	The only supported value is <b>3</b> , which is the default value.

Parameter	Description	Values
<b>credentialsMode</b>	<p>The Cloud Credential Operator (CCO) mode. If no mode is specified, the CCO dynamically tries to determine the capabilities of the provided credentials, with a preference for mint mode on the platforms where multiple modes are supported.</p> <p> <b>NOTE</b></p> <p>Not all CCO modes are supported for all cloud providers. For more information on CCO modes, see the <i>Cloud Credential Operator</i> entry in the <i>Cluster Operators reference</i> content.</p> <p> <b>NOTE</b></p> <p>If your AWS account has service control policies (SCP) enabled, you must configure the <b>credentialsMode</b> parameter to <b>Mint</b>, <b>Passthrough</b> or <b>Manual</b>.</p>	<b>Mint, Passthrough, Manual</b> or an empty string ("").

Parameter	Description	Values
<b>fips</b>	<p>Enable or disable FIPS mode. The default is <b>false</b> (disabled). If FIPS mode is enabled, the Red Hat Enterprise Linux CoreOS (RHCOS) machines that OpenShift Container Platform runs on bypass the default Kubernetes cryptography suite and use the cryptography modules that are provided with RHCOS instead.</p> <div data-bbox="488 589 592 1361" style="background-color: black; width: 100%; height: 100%; position: relative;">  </div> <p><b>IMPORTANT</b></p> <p>To enable FIPS mode for your cluster, you must run the installation program from a Red Hat Enterprise Linux (RHEL) computer configured to operate in FIPS mode. For more information about configuring FIPS mode on RHEL, see <a href="#">Installing the system in FIPS mode</a>. The use of FIPS validated or Modules In Process cryptographic libraries is only supported on OpenShift Container Platform deployments on the <b>x86_64</b> architecture.</p> <div data-bbox="488 1413 592 1608" style="background-color: black; width: 100%; height: 100%; position: relative;">  </div> <p><b>NOTE</b></p> <p>If you are using Azure File storage, you cannot enable FIPS mode.</p>	<b>false</b> or <b>true</b>
<b>imageContentSources</b>	Sources and repositories for the release-image content.	Array of objects. Includes a <b>source</b> and, optionally, <b>mirrors</b> , as described in the following rows of this table.
<b>imageContentSources.source</b>	Required if you use <b>imageContentSources</b> . Specify the repository that users refer to, for example, in image pull specifications.	String

Parameter	Description	Values
<b>imageContentSources.mirrors</b>	Specify one or more repositories that may also contain the same images.	Array of strings
<b>publish</b>	How to publish or expose the user-facing endpoints of your cluster, such as the Kubernetes API, OpenShift routes.	<b>Internal</b> or <b>External</b> . To deploy a private cluster, which cannot be accessed from the internet, set <b>publish</b> to <b>Internal</b> . The default value is <b>External</b> .
<b>sshKey</b>	<p>The SSH key or keys to authenticate access your cluster machines.</p>  <p><b>NOTE</b></p> <p>For production OpenShift Container Platform clusters on which you want to perform installation debugging or disaster recovery, specify an SSH key that your <b>ssh-agent</b> process uses.</p>	<p>One or more keys. For example:</p> <pre>sshKey:   &lt;key1&gt;   &lt;key2&gt;   &lt;key3&gt;</pre>

#### 5.9.7.1.4. Optional AWS configuration parameters

Optional AWS configuration parameters are described in the following table:

Table 5.31. Optional AWS parameters

Parameter	Description	Values
<b>compute.platform.aws.amiID</b>	The AWS AMI used to boot compute machines for the cluster. This is required for regions that require a custom RHCOS AMI.	Any published or custom RHCOS AMI that belongs to the set AWS region. See <i>RHCOS AMIs for AWS infrastructure</i> for available AMI IDs.
<b>compute.platform.aws.iamRole</b>	A pre-existing AWS IAM role applied to the compute machine pool instance profiles. You can use these fields to match naming schemes and include predefined permissions boundaries for your IAM roles. If undefined, the installation program creates a new IAM role.	The name of a valid AWS IAM role.

Parameter	Description	Values
<code>compute.platform.aws.rootVolume.iops</code>	The Input/Output Operations Per Second (IOPS) that is reserved for the root volume.	Integer, for example <b>4000</b> .
<code>compute.platform.aws.rootVolume.size</code>	The size in GiB of the root volume.	Integer, for example <b>500</b> .
<code>compute.platform.aws.rootVolume.type</code>	The type of the root volume.	Valid <a href="#">AWS EBS volume type</a> , such as <b>io1</b> .
<code>compute.platform.aws.rootVolume.kmsKeyARN</code>	The Amazon Resource Name (key ARN) of a KMS key. This is required to encrypt OS volumes of worker nodes with a specific KMS key.	Valid <a href="#">key ID</a> or the <a href="#">key ARN</a>
<code>compute.platform.aws.type</code>	The EC2 instance type for the compute machines.	Valid AWS instance type, such as <b>m4.2xlarge</b> . See the <a href="#">Supported AWS machine types</a> table that follows.
<code>compute.platform.aws.zones</code>	The availability zones where the installation program creates machines for the compute machine pool. If you provide your own VPC, you must provide a subnet in that availability zone.	A list of valid AWS availability zones, such as <b>us-east-1c</b> , in a <a href="#">YAML sequence</a> .
<code>compute.aws.region</code>	The AWS region that the installation program creates compute resources in.	Any valid <a href="#">AWS region</a> , such as <b>us-east-1</b> .   <b>IMPORTANT</b>  When running on ARM based AWS instances, ensure that you enter a region where AWS Graviton processors are available. See <a href="#">Global availability map</a> in the AWS documentation.
<code>controlPlane.platform.aws.amiID</code>	The AWS AMI used to boot control plane machines for the cluster. This is required for regions that require a custom RHCOS AMI.	Any published or custom RHCOS AMI that belongs to the set AWS region. See <i>RHCOS AMIs for AWS infrastructure</i> for available AMI IDs.

Parameter	Description	Values
<b>controlPlane.platform.aws.iamRole</b>	A pre-existing AWS IAM role applied to the control plane machine pool instance profiles. You can use these fields to match naming schemes and include predefined permissions boundaries for your IAM roles. If undefined, the installation program creates a new IAM role.	The name of a valid AWS IAM role.
<b>controlPlane.platform.aws.rootVolume.kmsKeyARN</b>	The Amazon Resource Name (key ARN) of a KMS key. This is required to encrypt OS volumes of control plane nodes with a specific KMS key.	Valid <a href="#">key ID</a> and the <a href="#">key ARN</a>
<b>controlPlane.platform.aws.type</b>	The EC2 instance type for the control plane machines.	Valid AWS instance type, such as <b>m6i.xlarge</b> . See the <b>Supported AWS machine types</b> table that follows.
<b>controlPlane.platform.aws.zones</b>	The availability zones where the installation program creates machines for the control plane machine pool.	A list of valid AWS availability zones, such as <b>us-east-1c</b> , in a <a href="#">YAML sequence</a> .
<b>controlPlane.aws.region</b>	The AWS region that the installation program creates control plane resources in.	Valid <a href="#">AWS region</a> , such as <b>us-east-1</b> .
<b>platform.aws.amiID</b>	The AWS AMI used to boot all machines for the cluster. If set, the AMI must belong to the same region as the cluster. This is required for regions that require a custom RHCOS AMI.	Any published or custom RHCOS AMI that belongs to the set AWS region. See <i>RHCOS AMIs for AWS infrastructure</i> for available AMI IDs.

Parameter	Description	Values
<b>platform.aws.hostedZone</b>	An existing Route 53 private hosted zone for the cluster. You can only use a pre-existing hosted zone when also supplying your own VPC. The hosted zone must already be associated with the user-provided VPC before installation. Also, the domain of the hosted zone must be the cluster domain or a parent of the cluster domain. If undefined, the installation program creates a new hosted zone.	String, for example <b>Z3URY6TWQ91KVV</b> .
<b>platform.aws.serviceEndpoints.name</b>	The AWS service endpoint name. Custom endpoints are only required for cases where alternative AWS endpoints, like FIPS, must be used. Custom API endpoints can be specified for EC2, S3, IAM, Elastic Load Balancing, Tagging, Route 53, and STS AWS services.	Valid <a href="#">AWS service endpoint</a> name.
<b>platform.aws.serviceEndpoints.url</b>	The AWS service endpoint URL. The URL must use the <b>https</b> protocol and the host must trust the certificate.	Valid <a href="#">AWS service endpoint</a> URL.
<b>platform.aws.userTags</b>	A map of keys and values that the installation program adds as tags to all resources that it creates.	Any valid YAML map, such as key value pairs in the <b>&lt;key&gt;: &lt;value&gt;</b> format. For more information about AWS tags, see <a href="#">Tagging Your Amazon EC2 Resources</a> in the AWS documentation.

Parameter	Description	Values
<b>platform.aws.subnets</b>	If you provide the VPC instead of allowing the installation program to create the VPC for you, specify the subnet for the cluster to use. The subnet must be part of the same <b>machineNetwork[].cidr</b> ranges that you specify. For a standard cluster, specify a public and a private subnet for each availability zone. For a private cluster, specify a private subnet for each availability zone.	Valid subnet IDs.

### 5.9.7.2. Minimum resource requirements for cluster installation

Each cluster machine must meet the following minimum requirements:

**Table 5.32. Minimum resource requirements**

Machine	Operating System	vCPU [1]	Virtual RAM	Storage	IOPS [2]
Bootstrap	RHCOS	4	16 GB	100 GB	300
Control plane	RHCOS	4	16 GB	100 GB	300
Compute	RHCOS, RHEL 8.4, or RHEL 8.5 [3]	2	8 GB	100 GB	300

1. One vCPU is equivalent to one physical core when simultaneous multithreading (SMT), or hyperthreading, is not enabled. When enabled, use the following formula to calculate the corresponding ratio: (threads per core × cores) × sockets = vCPUs.
2. OpenShift Container Platform and Kubernetes are sensitive to disk performance, and faster storage is recommended, particularly for etcd on the control plane nodes which require a 10 ms p99 fsync duration. Note that on many cloud platforms, storage size and IOPS scale together, so you might need to over-allocate storage volume to obtain sufficient performance.
3. As with all user-provisioned installations, if you choose to use RHEL compute machines in your cluster, you take responsibility for all operating system life cycle management and maintenance, including performing system updates, applying patches, and completing all other required tasks. Use of RHEL 7 compute machines is deprecated and has been removed in OpenShift Container Platform 4.10 and later.

If an instance type for your platform meets the minimum requirements for cluster machines, it is supported to use in OpenShift Container Platform.



### 5.9.7.3. Tested instance types for AWS

The following Amazon Web Services (AWS) instance types have been tested with OpenShift Container Platform.



#### NOTE

Use the machine types included in the following charts for your AWS instances. If you use an instance type that is not listed in the chart, ensure that the instance size you use matches the minimum resource requirements that are listed in "Minimum resource requirements for cluster installation".

#### Example 5.22. Machine types based on 64-bit x86 architecture

- **c4.\***
- **c5.\***
- **c5a.\***
- **i3.\***
- **m4.\***
- **m5.\***
- **m5a.\***
- **m6i.\***
- **r4.\***
- **r5.\***
- **r5a.\***
- **r6i.\***
- **t3.\***
- **t3a.\***

### 5.9.7.4. Tested instance types for AWS on 64-bit ARM infrastructures

The following Amazon Web Services (AWS) ARM64 instance types have been tested with OpenShift Container Platform.



#### NOTE

Use the machine types included in the following charts for your AWS ARM instances. If you use an instance type that is not listed in the chart, ensure that the instance size you use matches the minimum resource requirements that are listed in "Minimum resource requirements for cluster installation".

**Example 5.23. Machine types based on 64-bit ARM architecture**

- **c6g.\***
- **m6g.\***

**5.9.7.5. Sample customized install-config.yaml file for AWS**

You can customize the installation configuration file (**install-config.yaml**) to specify more details about your OpenShift Container Platform cluster's platform or modify the values of the required parameters.

**IMPORTANT**

This sample YAML file is provided for reference only. You must obtain your **install-config.yaml** file by using the installation program and modify it.

```

apiVersion: v1
baseDomain: example.com 1
credentialsMode: Mint 2
controlPlane: 3 4
  hyperthreading: Enabled 5
  name: master
  platform:
    aws:
      zones:
      - us-west-2a
      - us-west-2b
      rootVolume:
        iops: 4000
        size: 500
        type: io1 6
        type: m6i.xlarge
      replicas: 3
compute: 7
  - hyperthreading: Enabled 8
  name: worker
  platform:
    aws:
      rootVolume:
        iops: 2000
        size: 500
        type: io1 9
        type: c5.4xlarge
      zones:
      - us-west-2c
      replicas: 3
metadata:
  name: test-cluster 10
networking:
  clusterNetwork:
  - cidr: 10.128.0.0/14
  hostPrefix: 23

```

```

machineNetwork:
- cidr: 10.0.0.0/16
networkType: OpenShiftSDN
serviceNetwork:
- 172.30.0.0/16
platform:
aws:
region: us-west-2 11
userTags:
adminContact: jdoe
costCenter: 7536
subnets: 12
- subnet-1
- subnet-2
- subnet-3
amiID: ami-96c6f8f7 13
serviceEndpoints: 14
- name: ec2
url: https://vpce-id.ec2.us-west-2.vpce.amazonaws.com
hostedZone: Z3URY6TWQ91KVV 15
fips: false 16
sshKey: ssh-ed25519 AAAA... 17
publish: Internal 18
pullSecret: '{"auths": ...}' 19

```

- 1 10 11 19 Required. The installation program prompts you for this value.
- 2 Optional: Add this parameter to force the Cloud Credential Operator (CCO) to use the specified mode, instead of having the CCO dynamically try to determine the capabilities of the credentials. For details about CCO modes, see the *Cloud Credential Operator* entry in the *Red Hat Operators reference* content.
- 3 7 If you do not provide these parameters and values, the installation program provides the default value.
- 4 The **controlPlane** section is a single mapping, but the **compute** section is a sequence of mappings. To meet the requirements of the different data structures, the first line of the **compute** section must begin with a hyphen, -, and the first line of the **controlPlane** section must not. Only one control plane pool is used.
- 5 8 Whether to enable or disable simultaneous multithreading, or **hyperthreading**. By default, simultaneous multithreading is enabled to increase the performance of your machines' cores. You can disable it by setting the parameter value to **Disabled**. If you disable simultaneous multithreading in some cluster machines, you must disable it in all cluster machines.



### IMPORTANT

If you disable simultaneous multithreading, ensure that your capacity planning accounts for the dramatically decreased machine performance. Use larger instance types, such as **m4.2xlarge** or **m5.2xlarge**, for your machines if you disable simultaneous multithreading.

- 6 9 To configure faster storage for etcd, especially for larger clusters, set the storage type as **io1** and set **iops** to **2000**.

- 12 If you provide your own VPC, specify subnets for each availability zone that your cluster uses.
- 13 The ID of the AMI used to boot machines for the cluster. If set, the AMI must belong to the same region as the cluster.
- 14 The AWS service endpoints. Custom endpoints are required when installing to an unknown AWS region. The endpoint URL must use the **https** protocol and the host must trust the certificate.
- 15 The ID of your existing Route 53 private hosted zone. Providing an existing hosted zone requires that you supply your own VPC and the hosted zone is already associated with the VPC prior to installing your cluster. If undefined, the installation program creates a new hosted zone.
- 16 Whether to enable or disable FIPS mode. By default, FIPS mode is not enabled. If FIPS mode is enabled, the Red Hat Enterprise Linux CoreOS (RHCOS) machines that OpenShift Container Platform runs on bypass the default Kubernetes cryptography suite and use the cryptography modules that are provided with RHCOS instead.



### IMPORTANT

To enable FIPS mode for your cluster, you must run the installation program from a Red Hat Enterprise Linux (RHEL) computer configured to operate in FIPS mode. For more information about configuring FIPS mode on RHEL, see [Installing the system in FIPS mode](#). The use of FIPS validated or Modules In Process cryptographic libraries is only supported on OpenShift Container Platform deployments on the **x86\_64** architecture.

- 17 You can optionally provide the **sshKey** value that you use to access the machines in your cluster.



### NOTE

For production OpenShift Container Platform clusters on which you want to perform installation debugging or disaster recovery, specify an SSH key that your **ssh-agent** process uses.

- 18 How to publish the user-facing endpoints of your cluster. Set **publish** to **Internal** to deploy a private cluster, which cannot be accessed from the internet. The default value is **External**.

#### 5.9.7.6. Configuring the cluster-wide proxy during installation

Production environments can deny direct access to the internet and instead have an HTTP or HTTPS proxy available. You can configure a new OpenShift Container Platform cluster to use a proxy by configuring the proxy settings in the **install-config.yaml** file.

#### Prerequisites

- You have an existing **install-config.yaml** file.
- You reviewed the sites that your cluster requires access to and determined whether any of them need to bypass the proxy. By default, all cluster egress traffic is proxied, including calls to hosting cloud provider APIs. You added sites to the **Proxy** object's **spec.noProxy** field to bypass the proxy if necessary.

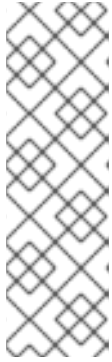

## NOTE

The **Proxy** object **status.noProxy** field is populated with the values of the **networking.machineNetwork[].cidr**, **networking.clusterNetwork[].cidr**, and **networking.serviceNetwork[]** fields from your installation configuration.

For installations on Amazon Web Services (AWS), Google Cloud Platform (GCP), Microsoft Azure, and Red Hat OpenStack Platform (RHOSP), the **Proxy** object **status.noProxy** field is also populated with the instance metadata endpoint (**169.254.169.254**).

- You have added the **ec2.<region>.amazonaws.com**, **elasticloadbalancing.<region>.amazonaws.com**, and **s3.<region>.amazonaws.com** endpoints to your VPC endpoint. These endpoints are required to complete requests from the nodes to the AWS EC2 API. Because the proxy works on the container level, not the node level, you must route these requests to the AWS EC2 API through the AWS private network. Adding the public IP address of the EC2 API to your allowlist in your proxy server is not sufficient.

## Procedure

- Edit your **install-config.yaml** file and add the proxy settings. For example:

```
apiVersion: v1
baseDomain: my.domain.com
proxy:
  httpProxy: http://<username>:<pswd>@<ip>:<port> 1
  httpsProxy: https://<username>:<pswd>@<ip>:<port> 2
  noProxy: example.com 3
  additionalTrustBundle: | 4
    -----BEGIN CERTIFICATE-----
    <MY_TRUSTED_CA_CERT>
    -----END CERTIFICATE-----
...

```

- A proxy URL to use for creating HTTP connections outside the cluster. The URL scheme must be **http**.
- A proxy URL to use for creating HTTPS connections outside the cluster.
- A comma-separated list of destination domain names, IP addresses, or other network CIDRs to exclude from proxying. Preface a domain with **.** to match subdomains only. For example, **.y.com** matches **x.y.com**, but not **y.com**. Use **\*** to bypass the proxy for all destinations.
- If provided, the installation program generates a config map that is named **user-ca-bundle** in the **openshift-config** namespace that contains one or more additional CA certificates that are required for proxying HTTPS connections. The Cluster Network Operator then creates a **trusted-ca-bundle** config map that merges these contents with the Red Hat Enterprise Linux CoreOS (RHCOS) trust bundle, and this config map is referenced in the **trustedCA** field of the **Proxy** object. The **additionalTrustBundle** field is required unless the proxy's identity certificate is signed by an authority from the RHCOS trust bundle.

**NOTE**

The installation program does not support the proxy **readinessEndpoints** field.

**NOTE**

If the installer times out, restart and then complete the deployment by using the **wait-for** command of the installer. For example:

```
$ ./openshift-install wait-for install-complete --log-level debug
```

2. Save the file and reference it when installing OpenShift Container Platform.

The installation program creates a cluster-wide proxy that is named **cluster** that uses the proxy settings in the provided **install-config.yaml** file. If no proxy settings are provided, a **cluster Proxy** object is still created, but it will have a nil **spec**.

**NOTE**

Only the **Proxy** object named **cluster** is supported, and no additional proxies can be created.

### 5.9.8. Deploying the cluster

You can install OpenShift Container Platform on a compatible cloud platform.

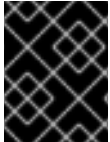
**IMPORTANT**

You can run the **create cluster** command of the installation program only once, during initial installation.

#### Prerequisites

- Configure an account with the cloud platform that hosts your cluster.
- Obtain the OpenShift Container Platform installation program and the pull secret for your cluster.

#### Procedure

1. Change to the directory that contains the installation program and initialize the cluster deployment:

```
$ ./openshift-install create cluster --dir <installation_directory> \ 1
--log-level=info 2
```

**1** For **<installation\_directory>**, specify the location of your customized **./install-config.yaml** file.

**2** To view different installation details, specify **warn**, **debug**, or **error** instead of **info**.

**NOTE**

If the cloud provider account that you configured on your host does not have sufficient permissions to deploy the cluster, the installation process stops, and the missing permissions are displayed.

When the cluster deployment completes, directions for accessing your cluster, including a link to its web console and credentials for the **kubeadmin** user, display in your terminal.

**Example output**

```
...
INFO Install complete!
INFO To access the cluster as the system:admin user when using 'oc', run 'export
KUBECONFIG=/home/myuser/install_dir/auth/kubeconfig'
INFO Access the OpenShift web-console here: https://console-openshift-
console.apps.mycluster.example.com
INFO Login to the console with user: "kubeadmin", and password: "4vYBz-Ee6gm-ymBZj-
Wt5AL"
INFO Time elapsed: 36m22s
```

**NOTE**

The cluster access and credential information also outputs to **<installation\_directory>/openshift\_install.log** when an installation succeeds.

**IMPORTANT**

- The Ignition config files that the installation program generates contain certificates that expire after 24 hours, which are then renewed at that time. If the cluster is shut down before renewing the certificates and the cluster is later restarted after the 24 hours have elapsed, the cluster automatically recovers the expired certificates. The exception is that you must manually approve the pending **node-bootstrapper** certificate signing requests (CSRs) to recover kubelet certificates. See the documentation for *Recovering from expired control plane certificates* for more information.
- It is recommended that you use Ignition config files within 12 hours after they are generated because the 24-hour certificate rotates from 16 to 22 hours after the cluster is installed. By using the Ignition config files within 12 hours, you can avoid installation failure if the certificate update runs during installation.

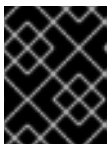
**IMPORTANT**

You must not delete the installation program or the files that the installation program creates. Both are required to delete the cluster.

2. Optional: Remove or disable the **AdministratorAccess** policy from the IAM account that you used to install the cluster.

**NOTE**

The elevated permissions provided by the **AdministratorAccess** policy are required only during installation.

### 5.9.9. Installing the OpenShift CLI by downloading the binary

You can install the OpenShift CLI (**oc**) to interact with OpenShift Container Platform from a command-line interface. You can install **oc** on Linux, Windows, or macOS.

**IMPORTANT**

If you installed an earlier version of **oc**, you cannot use it to complete all of the commands in OpenShift Container Platform 4.10. Download and install the new version of **oc**.

#### Installing the OpenShift CLI on Linux

You can install the OpenShift CLI (**oc**) binary on Linux by using the following procedure.

##### Procedure

1. Navigate to the [OpenShift Container Platform downloads page](#) on the Red Hat Customer Portal.
2. Select the appropriate version in the **Version** drop-down menu.
3. Click **Download Now** next to the **OpenShift v4.10 Linux Client** entry and save the file.
4. Unpack the archive:

```
$ tar xvf <file>
```

5. Place the **oc** binary in a directory that is on your **PATH**.  
To check your **PATH**, execute the following command:

```
$ echo $PATH
```

After you install the OpenShift CLI, it is available using the **oc** command:

```
$ oc <command>
```

#### Installing the OpenShift CLI on Windows

You can install the OpenShift CLI (**oc**) binary on Windows by using the following procedure.

##### Procedure

1. Navigate to the [OpenShift Container Platform downloads page](#) on the Red Hat Customer Portal.
2. Select the appropriate version in the **Version** drop-down menu.
3. Click **Download Now** next to the **OpenShift v4.10 Windows Client** entry and save the file.
4. Unzip the archive with a ZIP program.



5. Move the **oc** binary to a directory that is on your **PATH**.  
To check your **PATH**, open the command prompt and execute the following command:

```
C:\> path
```

After you install the OpenShift CLI, it is available using the **oc** command:

```
C:\> oc <command>
```

### Installing the OpenShift CLI on macOS

You can install the OpenShift CLI (**oc**) binary on macOS by using the following procedure.

#### Procedure

1. Navigate to the [OpenShift Container Platform downloads page](#) on the Red Hat Customer Portal.
2. Select the appropriate version in the **Version** drop-down menu.
3. Click **Download Now** next to the **OpenShift v4.10 MacOSX Client** entry and save the file.
4. Unpack and unzip the archive.
5. Move the **oc** binary to a directory on your PATH.  
To check your **PATH**, open a terminal and execute the following command:

```
$ echo $PATH
```

After you install the OpenShift CLI, it is available using the **oc** command:

```
$ oc <command>
```

### 5.9.10. Logging in to the cluster by using the CLI

You can log in to your cluster as a default system user by exporting the cluster **kubeconfig** file. The **kubeconfig** file contains information about the cluster that is used by the CLI to connect a client to the correct cluster and API server. The file is specific to a cluster and is created during OpenShift Container Platform installation.

#### Prerequisites

- You deployed an OpenShift Container Platform cluster.
- You installed the **oc** CLI.

#### Procedure

1. Export the **kubeadmin** credentials:

```
$ export KUBECONFIG=<installation_directory>/auth/kubeconfig 1
```

- 1** For **<installation\_directory>**, specify the path to the directory that you stored the installation files in.

2. Verify you can run **oc** commands successfully using the exported configuration:

```
$ oc whoami
```

#### Example output

```
system:admin
```

### 5.9.11. Logging in to the cluster by using the web console

The **kubeadmin** user exists by default after an OpenShift Container Platform installation. You can log in to your cluster as the **kubeadmin** user by using the OpenShift Container Platform web console.

#### Prerequisites

- You have access to the installation host.
- You completed a cluster installation and all cluster Operators are available.

#### Procedure

1. Obtain the password for the **kubeadmin** user from the **kubeadmin-password** file on the installation host:

```
$ cat <installation_directory>/auth/kubeadmin-password
```



#### NOTE

Alternatively, you can obtain the **kubeadmin** password from the **<installation\_directory>/openshift\_install.log** log file on the installation host.

2. List the OpenShift Container Platform web console route:

```
$ oc get routes -n openshift-console | grep 'console-openshift'
```



#### NOTE

Alternatively, you can obtain the OpenShift Container Platform route from the **<installation\_directory>/openshift\_install.log** log file on the installation host.

#### Example output

```
console console-openshift-console.apps.<cluster_name>.<base_domain> console
https reencrypt/Redirect None
```

3. Navigate to the route detailed in the output of the preceding command in a web browser and log in as the **kubeadmin** user.

#### Additional resources

- See [Accessing the web console](#) for more details about accessing and understanding the OpenShift Container Platform web console.

### 5.9.12. Telemetry access for OpenShift Container Platform

In OpenShift Container Platform 4.10, the Telemetry service, which runs by default to provide metrics about cluster health and the success of updates, requires internet access. If your cluster is connected to the internet, Telemetry runs automatically, and your cluster is registered to [OpenShift Cluster Manager](#).

After you confirm that your [OpenShift Cluster Manager](#) inventory is correct, either maintained automatically by Telemetry or manually by using OpenShift Cluster Manager, [use subscription watch](#) to track your OpenShift Container Platform subscriptions at the account or multi-cluster level.

#### Additional resources

- See [About remote health monitoring](#) for more information about the Telemetry service.

### 5.9.13. Next steps

- [Validating an installation.](#)
- [Customize your cluster.](#)
- If necessary, you can [opt out of remote health reporting](#) .
- If necessary, you can [remove cloud provider credentials](#).

## 5.10. INSTALLING A CLUSTER ON AWS INTO A GOVERNMENT REGION

In OpenShift Container Platform version 4.10, you can install a cluster on Amazon Web Services (AWS) into a government region. To configure the region, modify parameters in the **install-config.yaml** file before you install the cluster.

### 5.10.1. Prerequisites

- You reviewed details about the [OpenShift Container Platform installation and update](#) processes.
- You read the documentation on [selecting a cluster installation method and preparing it for users](#).
- You [configured an AWS account](#) to host the cluster.

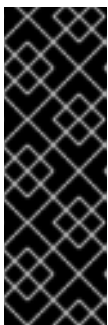

#### IMPORTANT

If you have an AWS profile stored on your computer, it must not use a temporary session token that you generated while using a multi-factor authentication device. The cluster continues to use your current AWS credentials to create AWS resources for the entire life of the cluster, so you must use long-lived credentials. To generate appropriate keys, see [Managing Access Keys for IAM Users](#) in the AWS documentation. You can supply the keys when you run the installation program.

- If you use a firewall, you [configured it to allow the sites](#) that your cluster requires access to.

- If the cloud identity and access management (IAM) APIs are not accessible in your environment, or if you do not want to store an administrator-level credential secret in the **kube-system** namespace, you can [manually create and maintain IAM credentials](#).

### 5.10.2. AWS government regions

OpenShift Container Platform supports deploying a cluster to an [AWS GovCloud \(US\)](#) region.

The following AWS GovCloud partitions are supported:

- **us-gov-east-1**
- **us-gov-west-1**

### 5.10.3. Installation requirements

Before you can install the cluster, you must:

- Provide an existing private AWS VPC and subnets to host the cluster. Public zones are not supported in Route 53 in AWS GovCloud. As a result, clusters must be private when you deploy to an AWS government region.
- Manually create the installation configuration file (**install-config.yaml**).

### 5.10.4. Private clusters

You can deploy a private OpenShift Container Platform cluster that does not expose external endpoints. Private clusters are accessible from only an internal network and are not visible to the internet.



#### NOTE

Public zones are not supported in Route 53 in an AWS GovCloud Region. Therefore, clusters must be private if they are deployed to an AWS GovCloud Region.

By default, OpenShift Container Platform is provisioned to use publicly-accessible DNS and endpoints. A private cluster sets the DNS, Ingress Controller, and API server to private when you deploy your cluster. This means that the cluster resources are only accessible from your internal network and are not visible to the internet.



#### IMPORTANT

If the cluster has any public subnets, load balancer services created by administrators might be publicly accessible. To ensure cluster security, verify that these services are explicitly annotated as private.

To deploy a private cluster, you must:

- Use existing networking that meets your requirements. Your cluster resources might be shared between other clusters on the network.
- Deploy from a machine that has access to:
  - The API services for the cloud to which you provision.

- The hosts on the network that you provision.
- The internet to obtain installation media.

You can use any machine that meets these access requirements and follows your company's guidelines. For example, this machine can be a bastion host on your cloud network or a machine that has access to the network through a VPN.

#### 5.10.4.1. Private clusters in AWS

To create a private cluster on Amazon Web Services (AWS), you must provide an existing private VPC and subnets to host the cluster. The installation program must also be able to resolve the DNS records that the cluster requires. The installation program configures the Ingress Operator and API server for access from only the private network.

The cluster still requires access to internet to access the AWS APIs.

The following items are not required or created when you install a private cluster:

- Public subnets
- Public load balancers, which support public ingress
- A public Route 53 zone that matches the **baseDomain** for the cluster

The installation program does use the **baseDomain** that you specify to create a private Route 53 zone and the required records for the cluster. The cluster is configured so that the Operators do not create public records for the cluster and all cluster machines are placed in the private subnets that you specify.

##### 5.10.4.1.1. Limitations

The ability to add public functionality to a private cluster is limited.

- You cannot make the Kubernetes API endpoints public after installation without taking additional actions, including creating public subnets in the VPC for each availability zone in use, creating a public load balancer, and configuring the control plane security groups to allow traffic from the internet on 6443 (Kubernetes API port).
- If you use a public Service type load balancer, you must tag a public subnet in each availability zone with **kubernetes.io/cluster/<cluster-infra-id>: shared** so that AWS can use them to create public load balancers.

#### 5.10.5. About using a custom VPC

In OpenShift Container Platform 4.10, you can deploy a cluster into existing subnets in an existing Amazon Virtual Private Cloud (VPC) in Amazon Web Services (AWS). By deploying OpenShift Container Platform into an existing AWS VPC, you might be able to avoid limit constraints in new accounts or more easily abide by the operational constraints that your company's guidelines set. If you cannot obtain the infrastructure creation permissions that are required to create the VPC yourself, use this installation option.

Because the installation program cannot know what other components are also in your existing subnets, it cannot choose subnet CIDRs and so forth on your behalf. You must configure networking for the subnets that you install your cluster to yourself.

##### 5.10.5.1. Requirements for using your VPC

The installation program no longer creates the following components:

- Internet gateways
- NAT gateways
- Subnets
- Route tables
- VPCs
- VPC DHCP options
- VPC endpoints



#### NOTE

The installation program requires that you use the cloud-provided DNS server. Using a custom DNS server is not supported and causes the installation to fail.

If you use a custom VPC, you must correctly configure it and its subnets for the installation program and the cluster to use. See [Amazon VPC console wizard configurations](#) and [Work with VPCs and subnets](#) in the AWS documentation for more information on creating and managing an AWS VPC.

The installation program cannot:

- Subdivide network ranges for the cluster to use.
- Set route tables for the subnets.
- Set VPC options like DHCP.

You must complete these tasks before you install the cluster. See [VPC networking components](#) and [Route tables for your VPC](#) for more information on configuring networking in an AWS VPC.

Your VPC must meet the following characteristics:

- The VPC must not use the **kubernetes.io/cluster/.\*: owned** tag.  
The installation program modifies your subnets to add the **kubernetes.io/cluster/.\*: shared** tag, so your subnets must have at least one free tag slot available for it. See [Tag Restrictions](#) in the AWS documentation to confirm that the installation program can add a tag to each subnet that you specify.
- You must enable the **enableDnsSupport** and **enableDnsHostnames** attributes in your VPC, so that the cluster can use the Route 53 zones that are attached to the VPC to resolve cluster's internal DNS records. See [DNS Support in Your VPC](#) in the AWS documentation.  
If you prefer to use your own Route 53 hosted private zone, you must associate the existing hosted zone with your VPC prior to installing a cluster. You can define your hosted zone using the **platform.aws.hostedZone** field in the **install-config.yaml** file.

If you are working in a disconnected environment, you are unable to reach the public IP addresses for EC2 and ELB endpoints. To resolve this, you must create a VPC endpoint and attach it to the subnet that the clusters are using. The endpoints should be named as follows:

- **ec2.<region>.amazonaws.com**

- `elasticloadbalancing.<region>.amazonaws.com`
- `s3.<region>.amazonaws.com`

## Required VPC components

You must provide a suitable VPC and subnets that allow communication to your machines.

Component	AWS type	Description								
VPC	<ul style="list-style-type: none"> <li>• <b>AWS::EC2::VPC</b></li> <li>• <b>AWS::EC2::VPCEndpoint</b></li> </ul>	You must provide a public VPC for the cluster to use. The VPC uses an endpoint that references the route tables for each subnet to improve communication with the registry that is hosted in S3.								
Public subnets	<ul style="list-style-type: none"> <li>• <b>AWS::EC2::Subnet</b></li> <li>• <b>AWS::EC2::SubnetNetworkACLAssociation</b></li> </ul>	Your VPC must have public subnets for between 1 and 3 availability zones and associate them with appropriate Ingress rules.								
Internet gateway	<ul style="list-style-type: none"> <li>• <b>AWS::EC2::InternetGateway</b></li> <li>• <b>AWS::EC2::VPCGatewayAttachment</b></li> <li>• <b>AWS::EC2::RouteTable</b></li> <li>• <b>AWS::EC2::Route</b></li> <li>• <b>AWS::EC2::SubnetRouteTableAssociation</b></li> <li>• <b>AWS::EC2::NatGateway</b></li> <li>• <b>AWS::EC2::EIP</b></li> </ul>	You must have a public internet gateway, with public routes, attached to the VPC. In the provided templates, each public subnet has a NAT gateway with an EIP address. These NAT gateways allow cluster resources, like private subnet instances, to reach the internet and are not required for some restricted network or proxy scenarios.								
Network access control	<ul style="list-style-type: none"> <li>• <b>AWS::EC2::NetworkACL</b></li> <li>• <b>AWS::EC2::NetworkACLEntry</b></li> </ul>	<p>You must allow the VPC to access the following ports:</p> <table border="1"> <thead> <tr> <th>Port</th> <th>Reason</th> </tr> </thead> <tbody> <tr> <td><b>80</b></td> <td>Inbound HTTP traffic</td> </tr> <tr> <td><b>443</b></td> <td>Inbound HTTPS traffic</td> </tr> <tr> <td><b>22</b></td> <td>Inbound SSH traffic</td> </tr> </tbody> </table>	Port	Reason	<b>80</b>	Inbound HTTP traffic	<b>443</b>	Inbound HTTPS traffic	<b>22</b>	Inbound SSH traffic
Port	Reason									
<b>80</b>	Inbound HTTP traffic									
<b>443</b>	Inbound HTTPS traffic									
<b>22</b>	Inbound SSH traffic									

Component	AWS type	Description	
		<b>1024 - 65535</b>	Inbound ephemeral traffic
		<b>0 - 65535</b>	Outbound ephemeral traffic
Private subnets	<ul style="list-style-type: none"> <li>● <b>AWS::EC2::Subnet</b></li> <li>● <b>AWS::EC2::RouteTable</b></li> <li>● <b>AWS::EC2::SubnetRouteTableAssociation</b></li> </ul>	Your VPC can have private subnets. The provided CloudFormation templates can create private subnets for between 1 and 3 availability zones. If you use private subnets, you must provide appropriate routes and tables for them.	

### 5.10.5.2. VPC validation

To ensure that the subnets that you provide are suitable, the installation program confirms the following data:

- All the subnets that you specify exist.
- You provide private subnets.
- The subnet CIDRs belong to the machine CIDR that you specified.
- You provide subnets for each availability zone. Each availability zone contains no more than one public and one private subnet. If you use a private cluster, provide only a private subnet for each availability zone. Otherwise, provide exactly one public and private subnet for each availability zone.
- You provide a public subnet for each private subnet availability zone. Machines are not provisioned in availability zones that you do not provide private subnets for.

If you destroy a cluster that uses an existing VPC, the VPC is not deleted. When you remove the OpenShift Container Platform cluster from a VPC, the **kubernetes.io/cluster/.\*: shared** tag is removed from the subnets that it used.

### 5.10.5.3. Division of permissions

Starting with OpenShift Container Platform 4.3, you do not need all of the permissions that are required for an installation program-provisioned infrastructure cluster to deploy a cluster. This change mimics the division of permissions that you might have at your company: some individuals can create different resource in your clouds than others. For example, you might be able to create application-specific items, like instances, buckets, and load balancers, but not networking-related components such as VPCs, subnets, or ingress rules.

The AWS credentials that you use when you create your cluster do not need the networking permissions that are required to make VPCs and core networking components within the VPC, such as subnets, routing tables, internet gateways, NAT, and VPN. You still need permission to make the application resources that the machines within the cluster require, such as ELBs, security groups, S3 buckets, and nodes.



#### 5.10.5.4. Isolation between clusters

If you deploy OpenShift Container Platform to an existing network, the isolation of cluster services is reduced in the following ways:

- You can install multiple OpenShift Container Platform clusters in the same VPC.
- ICMP ingress is allowed from the entire network.
- TCP 22 ingress (SSH) is allowed to the entire network.
- Control plane TCP 6443 ingress (Kubernetes API) is allowed to the entire network.
- Control plane TCP 22623 ingress (MCS) is allowed to the entire network.

#### 5.10.6. Internet access for OpenShift Container Platform

In OpenShift Container Platform 4.10, you require access to the internet to install your cluster.

You must have internet access to:

- Access [OpenShift Cluster Manager](#) to download the installation program and perform subscription management. If the cluster has internet access and you do not disable Telemetry, that service automatically entitles your cluster.
- Access [Quay.io](#) to obtain the packages that are required to install your cluster.
- Obtain the packages that are required to perform cluster updates.

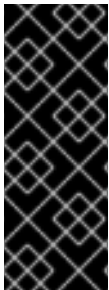

#### IMPORTANT

If your cluster cannot have direct internet access, you can perform a restricted network installation on some types of infrastructure that you provision. During that process, you download the required content and use it to populate a mirror registry with the installation packages. With some installation types, the environment that you install your cluster in will not require internet access. Before you update the cluster, you update the content of the mirror registry.

#### 5.10.7. Generating a key pair for cluster node SSH access

During an OpenShift Container Platform installation, you can provide an SSH public key to the installation program. The key is passed to the Red Hat Enterprise Linux CoreOS (RHCOS) nodes through their Ignition config files and is used to authenticate SSH access to the nodes. The key is added to the `~/.ssh/authorized_keys` list for the **core** user on each node, which enables password-less authentication.

After the key is passed to the nodes, you can use the key pair to SSH in to the RHCOS nodes as the user **core**. To access the nodes through SSH, the private key identity must be managed by SSH for your local user.

If you want to SSH in to your cluster nodes to perform installation debugging or disaster recovery, you must provide the SSH public key during the installation process. The `./openshift-install gather` command also requires the SSH public key to be in place on the cluster nodes.

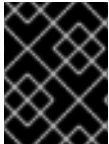
**IMPORTANT**

Do not skip this procedure in production environments, where disaster recovery and debugging is required.

**NOTE**

You must use a local key, not one that you configured with platform-specific approaches such as [AWS key pairs](#).

**Procedure**

1. If you do not have an existing SSH key pair on your local machine to use for authentication onto your cluster nodes, create one. For example, on a computer that uses a Linux operating system, run the following command:

```
$ ssh-keygen -t ed25519 -N "" -f <path>/<file_name> 1
```

- 1 Specify the path and file name, such as `~/.ssh/id_ed25519`, of the new SSH key. If you have an existing key pair, ensure your public key is in the your `~/.ssh` directory.

**NOTE**

If you plan to install an OpenShift Container Platform cluster that uses FIPS validated or Modules In Process cryptographic libraries on the **x86\_64** architecture, do not create a key that uses the **ed25519** algorithm. Instead, create a key that uses the **rsa** or **ecdsa** algorithm.

2. View the public SSH key:

```
$ cat <path>/<file_name>.pub
```

For example, run the following to view the `~/.ssh/id_ed25519.pub` public key:

```
$ cat ~/.ssh/id_ed25519.pub
```

3. Add the SSH private key identity to the SSH agent for your local user, if it has not already been added. SSH agent management of the key is required for password-less SSH authentication onto your cluster nodes, or if you want to use the `./openshift-install gather` command.

**NOTE**

On some distributions, default SSH private key identities such as `~/.ssh/id_rsa` and `~/.ssh/id_dsa` are managed automatically.

- a. If the **ssh-agent** process is not already running for your local user, start it as a background task:

```
$ eval "$(ssh-agent -s)"
```

**Example output**

Agent pid 31874



#### NOTE

If your cluster is in FIPS mode, only use FIPS-compliant algorithms to generate the SSH key. The key must be either RSA or ECDSA.

4. Add your SSH private key to the **ssh-agent**:

```
$ ssh-add <path>/<file_name> 1
```

- 1** Specify the path and file name for your SSH private key, such as `~/.ssh/id_ed25519`

#### Example output

```
Identity added: /home/<you>/<path>/<file_name> (<computer_name>)
```

#### Next steps

- When you install OpenShift Container Platform, provide the SSH public key to the installation program.

### 5.10.8. Obtaining an AWS Marketplace image

If you are deploying an OpenShift Container Platform cluster using an AWS Marketplace image, you must first subscribe through AWS. Subscribing to the offer provides you with the AMI ID that the installation program uses to deploy worker nodes.

#### Prerequisites

- You have an AWS account to purchase the offer. This account does not have to be the same account that is used to install the cluster.

#### Procedure

1. Complete the OpenShift Container Platform subscription from the [AWS Marketplace](#).
2. Record the AMI ID for your specific region. As part of the installation process, you must update the **install-config.yaml** file with this value before deploying the cluster.

#### Sample **install-config.yaml** file with AWS Marketplace worker nodes

```
apiVersion: v1
baseDomain: example.com
compute:
- hyperthreading: Enabled
  name: worker
platform:
aws:
  amiID: ami-06c4d345f7c207239 1
  type: m5.4xlarge
```

```

replicas: 3
metadata:
  name: test-cluster
platform:
  aws:
    region: us-east-2 2
sshKey: ssh-ed25519 AAAA...
pullSecret: '{"auths": ...}'

```

- 1 The AMI ID from your AWS Marketplace subscription.
- 2 Your AMI ID is associated with a specific AWS region. When creating the installation configuration file, ensure that you select the same AWS region that you specified when configuring your subscription.

### 5.10.9. Obtaining the installation program

Before you install OpenShift Container Platform, download the installation file on a local computer.

#### Prerequisites

- You have a computer that runs Linux or macOS, with 500 MB of local disk space

#### Procedure

1. Access the [Infrastructure Provider](#) page on the OpenShift Cluster Manager site. If you have a Red Hat account, log in with your credentials. If you do not, create an account.
2. Select your infrastructure provider.
3. Navigate to the page for your installation type, download the installation program that corresponds with your host operating system and architecture, and place the file in the directory where you will store the installation configuration files.



#### IMPORTANT

The installation program creates several files on the computer that you use to install your cluster. You must keep the installation program and the files that the installation program creates after you finish installing the cluster. Both files are required to delete the cluster.



#### IMPORTANT

Deleting the files created by the installation program does not remove your cluster, even if the cluster failed during installation. To remove your cluster, complete the OpenShift Container Platform uninstallation procedures for your specific cloud provider.

4. Extract the installation program. For example, on a computer that uses a Linux operating system, run the following command:

```
$ tar -xvf openshift-install-linux.tar.gz
```

- Download your installation [pull secret from the Red Hat OpenShift Cluster Manager](#) . This pull secret allows you to authenticate with the services that are provided by the included authorities, including Quay.io, which serves the container images for OpenShift Container Platform components.

### 5.10.10. Manually creating the installation configuration file

Installing the cluster requires that you manually generate the installation configuration file.

#### Prerequisites

- You have an SSH public key on your local machine to provide to the installation program. The key will be used for SSH authentication onto your cluster nodes for debugging and disaster recovery.
- You have obtained the OpenShift Container Platform installation program and the pull secret for your cluster.

#### Procedure

- Create an installation directory to store your required installation assets in:

```
$ mkdir <installation_directory>
```

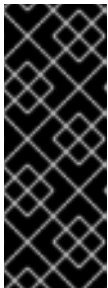

#### IMPORTANT

You must create a directory. Some installation assets, like bootstrap X.509 certificates have short expiration intervals, so you must not reuse an installation directory. If you want to reuse individual files from another cluster installation, you can copy them into your directory. However, the file names for the installation assets might change between releases. Use caution when copying installation files from an earlier OpenShift Container Platform version.

- Customize the sample **install-config.yaml** file template that is provided and save it in the **<installation\_directory>**.



#### NOTE

You must name this configuration file **install-config.yaml**.

- Back up the **install-config.yaml** file so that you can use it to install multiple clusters.

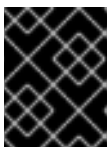

#### IMPORTANT

The **install-config.yaml** file is consumed during the next step of the installation process. You must back it up now.

#### 5.10.10.1. Installation configuration parameters

Before you deploy an OpenShift Container Platform cluster, you provide parameter values to describe your account on the cloud platform that hosts your cluster and optionally customize your cluster's platform. When you create the **install-config.yaml** installation configuration file, you provide values for

the required parameters through the command line. If you customize your cluster, you can modify the **install-config.yaml** file to provide more details about the platform.

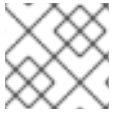

## NOTE

After installation, you cannot modify these parameters in the **install-config.yaml** file.

### 5.10.10.1.1. Required configuration parameters

Required installation configuration parameters are described in the following table:

Table 5.33. Required parameters

Parameter	Description	Values
<b>apiVersion</b>	The API version for the <b>install-config.yaml</b> content. The current version is <b>v1</b> . The installer may also support older API versions.	String
<b>baseDomain</b>	The base domain of your cloud provider. The base domain is used to create routes to your OpenShift Container Platform cluster components. The full DNS name for your cluster is a combination of the <b>baseDomain</b> and <b>metadata.name</b> parameter values that uses the <b>&lt;metadata.name&gt;</b> . <b>&lt;baseDomain&gt;</b> format.	A fully-qualified domain or subdomain name, such as <b>example.com</b> .
<b>metadata</b>	Kubernetes resource <b>ObjectMeta</b> , from which only the <b>name</b> parameter is consumed.	Object
<b>metadata.name</b>	The name of the cluster. DNS records for the cluster are all subdomains of <b>{{.metadata.name}}</b> . <b>{{.baseDomain}}</b> .	String of lowercase letters, hyphens (-), and periods (.), such as <b>dev</b> .

Parameter	Description	Values
<b>platform</b>	The configuration for the specific platform upon which to perform the installation: <b>alibabacloud</b> , <b>aws</b> , <b>baremetal</b> , <b>azure</b> , <b>gcp</b> , <b>ibmcloud</b> , <b>openstack</b> , <b>ovirt</b> , <b>vsphere</b> , or <b>{}</b> . For additional information about <b>platform.&lt;platform&gt;</b> parameters, consult the table for your specific platform that follows.	Object
<b>pullSecret</b>	Get a <a href="#">pull secret from the Red Hat OpenShift Cluster Manager</a> to authenticate downloading container images for OpenShift Container Platform components from services such as Quay.io.	<pre>{   "auths":{     "cloud.openshift.com":{       "auth":"b3Blb=",       "email":"you@example.com"     },     "quay.io":{       "auth":"b3Blb=",       "email":"you@example.com"     }   } }</pre>

#### 5.10.10.1.2. Network configuration parameters

You can customize your installation configuration based on the requirements of your existing network infrastructure. For example, you can expand the IP address block for the cluster network or provide different IP address blocks than the defaults.

Only IPv4 addresses are supported.

**Table 5.34. Network parameters**

Parameter	Description	Values
<b>networking</b>	The configuration for the cluster network.	<p>Object</p>  <p><b>NOTE</b></p> <p>You cannot modify parameters specified by the <b>networking</b> object after installation.</p>

Parameter	Description	Values
<b>networking.networkType</b>	The cluster network provider Container Network Interface (CNI) plugin to install.	Either <b>OpenShiftSDN</b> or <b>OVNKubernetes</b> . <b>OpenShiftSDN</b> is a CNI provider for all-Linux networks. <b>OVNKubernetes</b> is a CNI provider for Linux networks and hybrid networks that contain both Linux and Windows servers. The default value is <b>OpenShiftSDN</b> .
<b>networking.clusterNetwork</b>	The IP address blocks for pods.  The default value is <b>10.128.0.0/14</b> with a host prefix of <b>/23</b> .  If you specify multiple IP address blocks, the blocks must not overlap.	An array of objects. For example:  <pre>networking:   clusterNetwork:     - cidr: 10.128.0.0/14       hostPrefix: 23</pre>
<b>networking.clusterNetwork.cidr</b>	Required if you use <b>networking.clusterNetwork</b> . An IP address block.  An IPv4 network.	An IP address block in Classless Inter-Domain Routing (CIDR) notation. The prefix length for an IPv4 block is between <b>0</b> and <b>32</b> .
<b>networking.clusterNetwork.hostPrefix</b>	The subnet prefix length to assign to each individual node. For example, if <b>hostPrefix</b> is set to <b>23</b> then each node is assigned a <b>/23</b> subnet out of the given <b>cidr</b> . A <b>hostPrefix</b> value of <b>23</b> provides 510 ( $2^{(32 - 23)} - 2$ ) pod IP addresses.	A subnet prefix.  The default value is <b>23</b> .
<b>networking.serviceNetwork</b>	The IP address block for services. The default value is <b>172.30.0.0/16</b> .  The OpenShift SDN and OVN-Kubernetes network providers support only a single IP address block for the service network.	An array with an IP address block in CIDR format. For example:  <pre>networking:   serviceNetwork:     - 172.30.0.0/16</pre>
<b>networking.machineNetwork</b>	The IP address blocks for machines.  If you specify multiple IP address blocks, the blocks must not overlap.	An array of objects. For example:  <pre>networking:   machineNetwork:     - cidr: 10.0.0.0/16</pre>



Parameter	Description	Values
<b>networking.machineNetwork.cidr</b>	Required if you use <b>networking.machineNetwork</b> . An IP address block. The default value is <b>10.0.0.0/16</b> for all platforms other than libvirt. For libvirt, the default value is <b>192.168.126.0/24</b> .	An IP network block in CIDR notation. For example, <b>10.0.0.0/16</b> .  <b>NOTE</b> Set the <b>networking.machineNetwork</b> to match the CIDR that the preferred NIC resides in.

### 5.10.10.1.3. Optional configuration parameters



Optional installation configuration parameters are described in the following table:

Table 5.35. Optional parameters

Parameter	Description	Values
<b>additionalTrustBundle</b>	A PEM-encoded X.509 certificate bundle that is added to the nodes' trusted certificate store. This trust bundle may also be used when a proxy has been configured.	String
<b>cgroupsV2</b>	Enables <a href="#">Linux control groups version 2</a> (cgroups v2) on specific nodes in your cluster. The OpenShift Container Platform process for enabling cgroups v2 disables all cgroup version 1 controllers and hierarchies. The OpenShift Container Platform cgroups version 2 feature is in Developer Preview and is not supported by Red Hat at this time.	<b>true</b>
<b>compute</b>	The configuration for the machines that comprise the compute nodes.	Array of <b>MachinePool</b> objects.

Parameter	Description	Values
<b>compute.architecture</b>	Determines the instruction set architecture of the machines in the pool. Currently, clusters with varied architectures are not supported. All pools must specify the same architecture. Valid values are <b>amd64</b> (the default).	String
<b>compute.hyperthreading</b>	Whether to enable or disable simultaneous multithreading, or <b>hyperthreading</b> , on compute machines. By default, simultaneous multithreading is enabled to increase the performance of your machines' cores.   <b>IMPORTANT</b> If you disable simultaneous multithreading, ensure that your capacity planning accounts for the dramatically decreased machine performance.	<b>Enabled</b> or <b>Disabled</b>
<b>compute.name</b>	Required if you use <b>compute</b> . The name of the machine pool.	<b>worker</b>
<b>compute.platform</b>	Required if you use <b>compute</b> . Use this parameter to specify the cloud provider to host the worker machines. This parameter value must match the <b>controlPlane.platform</b> parameter value.	<b>alibabacloud, aws, azure, gcp, ibmcloud, openstack, ovirt, vsphere</b> , or <b>{}</b>
<b>compute.replicas</b>	The number of compute machines, which are also known as worker machines, to provision.	A positive integer greater than or equal to <b>2</b> . The default value is <b>3</b> .
<b>controlPlane</b>	The configuration for the machines that comprise the control plane.	Array of <b>MachinePool</b> objects.

Parameter	Description	Values
<b>controlPlane.architecture</b>	Determines the instruction set architecture of the machines in the pool. Currently, clusters with varied architectures are not supported. All pools must specify the same architecture. Valid values are <b>amd64</b> (the default).	String
<b>controlPlane.hypertreading</b>	Whether to enable or disable simultaneous multithreading, or <b>hyperthreading</b> , on control plane machines. By default, simultaneous multithreading is enabled to increase the performance of your machines' cores.   <b>IMPORTANT</b>  If you disable simultaneous multithreading, ensure that your capacity planning accounts for the dramatically decreased machine performance.	<b>Enabled</b> or <b>Disabled</b>
<b>controlPlane.name</b>	Required if you use <b>controlPlane</b> . The name of the machine pool.	<b>master</b>
<b>controlPlane.platform</b>	Required if you use <b>controlPlane</b> . Use this parameter to specify the cloud provider that hosts the control plane machines. This parameter value must match the <b>compute.platform</b> parameter value.	<b>alibabacloud, aws, azure, gcp, ibmcloud, openstack, ovirt, vsphere, or {}</b>
<b>controlPlane.replicas</b>	The number of control plane machines to provision.	The only supported value is <b>3</b> , which is the default value.

Parameter	Description	Values
<b>credentialsMode</b>	<p>The Cloud Credential Operator (CCO) mode. If no mode is specified, the CCO dynamically tries to determine the capabilities of the provided credentials, with a preference for mint mode on the platforms where multiple modes are supported.</p> <div data-bbox="486 510 595 862" style="border: 1px solid black; padding: 5px; margin-bottom: 10px;">  </div> <p><b>NOTE</b></p> <p>Not all CCO modes are supported for all cloud providers. For more information on CCO modes, see the <i>Cloud Credential Operator</i> entry in the <i>Cluster Operators reference content</i>.</p> <div data-bbox="486 907 595 1258" style="border: 1px solid black; padding: 5px;">  </div> <p><b>NOTE</b></p> <p>If your AWS account has service control policies (SCP) enabled, you must configure the <b>credentialsMode</b> parameter to <b>Mint</b>, <b>Passthrough</b> or <b>Manual</b>.</p>	<b>Mint, Passthrough, Manual</b> or an empty string ("").

Parameter	Description	Values
<b>fips</b>	<p>Enable or disable FIPS mode. The default is <b>false</b> (disabled). If FIPS mode is enabled, the Red Hat Enterprise Linux CoreOS (RHCOS) machines that OpenShift Container Platform runs on bypass the default Kubernetes cryptography suite and use the cryptography modules that are provided with RHCOS instead.</p> <div style="display: flex; align-items: flex-start;"> <div style="width: 20px; height: 100px; background: repeating-linear-gradient(45deg, transparent, transparent 2px, black 2px, black 4px); margin-right: 10px;"></div> <div> <p><b>IMPORTANT</b></p> <p>To enable FIPS mode for your cluster, you must run the installation program from a Red Hat Enterprise Linux (RHEL) computer configured to operate in FIPS mode. For more information about configuring FIPS mode on RHEL, see <a href="#">Installing the system in FIPS mode</a>. The use of FIPS validated or Modules In Process cryptographic libraries is only supported on OpenShift Container Platform deployments on the <b>x86_64</b> architecture.</p> </div> </div> <div style="display: flex; align-items: flex-start; margin-top: 10px;"> <div style="width: 20px; height: 100px; background: repeating-linear-gradient(45deg, transparent, transparent 2px, black 2px, black 4px); margin-right: 10px;"></div> <div> <p><b>NOTE</b></p> <p>If you are using Azure File storage, you cannot enable FIPS mode.</p> </div> </div>	<b>false</b> or <b>true</b>
<b>imageContentSources</b>	Sources and repositories for the release-image content.	Array of objects. Includes a <b>source</b> and, optionally, <b>mirrors</b> , as described in the following rows of this table.
<b>imageContentSources.source</b>	Required if you use <b>imageContentSources</b> . Specify the repository that users refer to, for example, in image pull specifications.	String
<b>imageContentSources.mirrors</b>	Specify one or more repositories that may also contain the same images.	Array of strings

Parameter	Description	Values
<b>publish</b>	How to publish or expose the user-facing endpoints of your cluster, such as the Kubernetes API, OpenShift routes.	<b>Internal</b> or <b>External</b> . To deploy a private cluster, which cannot be accessed from the internet, set <b>publish</b> to <b>Internal</b> . The default value is <b>External</b> .
<b>sshKey</b>	<p>The SSH key or keys to authenticate access your cluster machines.</p>  <p><b>NOTE</b></p> <p>For production OpenShift Container Platform clusters on which you want to perform installation debugging or disaster recovery, specify an SSH key that your <b>ssh-agent</b> process uses.</p>	<p>One or more keys. For example:</p> <pre>sshKey:   &lt;key1&gt;   &lt;key2&gt;   &lt;key3&gt;</pre>

#### 5.10.10.1.4. Optional AWS configuration parameters

Optional AWS configuration parameters are described in the following table:

Table 5.36. Optional AWS parameters

Parameter	Description	Values
<b>compute.platform.aws.amiID</b>	The AWS AMI used to boot compute machines for the cluster. This is required for regions that require a custom RHCOS AMI.	Any published or custom RHCOS AMI that belongs to the set AWS region. See <i>RHCOS AMIs for AWS infrastructure</i> for available AMI IDs.
<b>compute.platform.aws.iamRole</b>	A pre-existing AWS IAM role applied to the compute machine pool instance profiles. You can use these fields to match naming schemes and include predefined permissions boundaries for your IAM roles. If undefined, the installation program creates a new IAM role.	The name of a valid AWS IAM role.

Parameter	Description	Values
<b>compute.platform.aws.rootVolume.iops</b>	The Input/Output Operations Per Second (IOPS) that is reserved for the root volume.	Integer, for example <b>4000</b> .
<b>compute.platform.aws.rootVolume.size</b>	The size in GiB of the root volume.	Integer, for example <b>500</b> .
<b>compute.platform.aws.rootVolume.type</b>	The type of the root volume.	Valid <a href="#">AWS EBS volume type</a> , such as <b>io1</b> .
<b>compute.platform.aws.rootVolume.kmsKeyARN</b>	The Amazon Resource Name (key ARN) of a KMS key. This is required to encrypt OS volumes of worker nodes with a specific KMS key.	Valid <a href="#">key ID</a> or the <a href="#">key ARN</a>
<b>compute.platform.aws.type</b>	The EC2 instance type for the compute machines.	Valid AWS instance type, such as <b>m4.2xlarge</b> . See the <a href="#">Supported AWS machine types</a> table that follows.
<b>compute.platform.aws.zones</b>	The availability zones where the installation program creates machines for the compute machine pool. If you provide your own VPC, you must provide a subnet in that availability zone.	A list of valid AWS availability zones, such as <b>us-east-1c</b> , in a <a href="#">YAML sequence</a> .
<b>compute.aws.region</b>	The AWS region that the installation program creates compute resources in.	Any valid <a href="#">AWS region</a> , such as <b>us-east-1</b> .   <b>IMPORTANT</b> When running on ARM based AWS instances, ensure that you enter a region where AWS Graviton processors are available. See <a href="#">Global availability map</a> in the AWS documentation.
<b>controlPlane.platform.aws.amiID</b>	The AWS AMI used to boot control plane machines for the cluster. This is required for regions that require a custom RHCOS AMI.	Any published or custom RHCOS AMI that belongs to the set AWS region. See <i>RHCOS AMIs for AWS infrastructure</i> for available AMI IDs.

Parameter	Description	Values
<b>controlPlane.platform.aws.iamRole</b>	A pre-existing AWS IAM role applied to the control plane machine pool instance profiles. You can use these fields to match naming schemes and include predefined permissions boundaries for your IAM roles. If undefined, the installation program creates a new IAM role.	The name of a valid AWS IAM role.
<b>controlPlane.platform.aws.rootVolume.kmsKeyARN</b>	The Amazon Resource Name (key ARN) of a KMS key. This is required to encrypt OS volumes of control plane nodes with a specific KMS key.	Valid <a href="#">key ID</a> and the <a href="#">key ARN</a>
<b>controlPlane.platform.aws.type</b>	The EC2 instance type for the control plane machines.	Valid AWS instance type, such as <b>m6i.xlarge</b> . See the <b>Supported AWS machine types</b> table that follows.
<b>controlPlane.platform.aws.zones</b>	The availability zones where the installation program creates machines for the control plane machine pool.	A list of valid AWS availability zones, such as <b>us-east-1c</b> , in a <a href="#">YAML sequence</a> .
<b>controlPlane.aws.region</b>	The AWS region that the installation program creates control plane resources in.	Valid <a href="#">AWS region</a> , such as <b>us-east-1</b> .
<b>platform.aws.amiID</b>	The AWS AMI used to boot all machines for the cluster. If set, the AMI must belong to the same region as the cluster. This is required for regions that require a custom RHCOS AMI.	Any published or custom RHCOS AMI that belongs to the set AWS region. See <i>RHCOS AMIs for AWS infrastructure</i> for available AMI IDs.



Parameter	Description	Values
<b>platform.aws.hostedZone</b>	An existing Route 53 private hosted zone for the cluster. You can only use a pre-existing hosted zone when also supplying your own VPC. The hosted zone must already be associated with the user-provided VPC before installation. Also, the domain of the hosted zone must be the cluster domain or a parent of the cluster domain. If undefined, the installation program creates a new hosted zone.	String, for example <b>Z3URY6TWQ91KVV</b> .
<b>platform.aws.serviceEndpoints.name</b>	The AWS service endpoint name. Custom endpoints are only required for cases where alternative AWS endpoints, like FIPS, must be used. Custom API endpoints can be specified for EC2, S3, IAM, Elastic Load Balancing, Tagging, Route 53, and STS AWS services.	Valid <a href="#">AWS service endpoint</a> name.
<b>platform.aws.serviceEndpoints.url</b>	The AWS service endpoint URL. The URL must use the <b>https</b> protocol and the host must trust the certificate.	Valid <a href="#">AWS service endpoint</a> URL.
<b>platform.aws.userTags</b>	A map of keys and values that the installation program adds as tags to all resources that it creates.	Any valid YAML map, such as key value pairs in the <b>&lt;key&gt;: &lt;value&gt;</b> format. For more information about AWS tags, see <a href="#">Tagging Your Amazon EC2 Resources</a> in the AWS documentation.

Parameter	Description	Values
<b>platform.aws.subnets</b>	If you provide the VPC instead of allowing the installation program to create the VPC for you, specify the subnet for the cluster to use. The subnet must be part of the same <b>machineNetwork[].cidr</b> ranges that you specify. For a standard cluster, specify a public and a private subnet for each availability zone. For a private cluster, specify a private subnet for each availability zone.	Valid subnet IDs.

### 5.10.10.2. Minimum resource requirements for cluster installation

Each cluster machine must meet the following minimum requirements:

**Table 5.37. Minimum resource requirements**

Machine	Operating System	vCPU [1]	Virtual RAM	Storage	IOPS [2]
Bootstrap	RHCOS	4	16 GB	100 GB	300
Control plane	RHCOS	4	16 GB	100 GB	300
Compute	RHCOS, RHEL 8.4, or RHEL 8.5 [3]	2	8 GB	100 GB	300

1. One vCPU is equivalent to one physical core when simultaneous multithreading (SMT), or hyperthreading, is not enabled. When enabled, use the following formula to calculate the corresponding ratio:  $(\text{threads per core} \times \text{cores}) \times \text{sockets} = \text{vCPUs}$ .
2. OpenShift Container Platform and Kubernetes are sensitive to disk performance, and faster storage is recommended, particularly for etcd on the control plane nodes which require a 10 ms p99 fsync duration. Note that on many cloud platforms, storage size and IOPS scale together, so you might need to over-allocate storage volume to obtain sufficient performance.
3. As with all user-provisioned installations, if you choose to use RHEL compute machines in your cluster, you take responsibility for all operating system life cycle management and maintenance, including performing system updates, applying patches, and completing all other required tasks. Use of RHEL 7 compute machines is deprecated and has been removed in OpenShift Container Platform 4.10 and later.

If an instance type for your platform meets the minimum requirements for cluster machines, it is supported to use in OpenShift Container Platform.

### 5.10.10.3. Tested instance types for AWS

The following Amazon Web Services (AWS) instance types have been tested with OpenShift Container Platform.



#### NOTE

Use the machine types included in the following charts for your AWS instances. If you use an instance type that is not listed in the chart, ensure that the instance size you use matches the minimum resource requirements that are listed in "Minimum resource requirements for cluster installation".

#### Example 5.24. Machine types based on 64-bit x86 architecture

- **c4.\***
- **c5.\***
- **c5a.\***
- **i3.\***
- **m4.\***
- **m5.\***
- **m5a.\***
- **m6i.\***
- **r4.\***
- **r5.\***
- **r5a.\***
- **r6i.\***
- **t3.\***
- **t3a.\***

### 5.10.10.4. Tested instance types for AWS on 64-bit ARM infrastructures

The following Amazon Web Services (AWS) ARM64 instance types have been tested with OpenShift Container Platform.



#### NOTE

Use the machine types included in the following charts for your AWS ARM instances. If you use an instance type that is not listed in the chart, ensure that the instance size you use matches the minimum resource requirements that are listed in "Minimum resource requirements for cluster installation".

**Example 5.25. Machine types based on 64-bit ARM architecture**

- **c6g.\***
- **m6g.\***

**5.10.10.5. Sample customized install-config.yaml file for AWS**

You can customize the installation configuration file (**install-config.yaml**) to specify more details about your OpenShift Container Platform cluster's platform or modify the values of the required parameters.

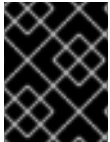
**IMPORTANT**

This sample YAML file is provided for reference only. Use it as a resource to enter parameter values into the installation configuration file that you created manually.

```

apiVersion: v1
baseDomain: example.com 1
credentialsMode: Mint 2
controlPlane: 3 4
  hyperthreading: Enabled 5
  name: master
  platform:
    aws:
      zones:
      - us-gov-west-1a
      - us-gov-west-1b
      rootVolume:
        iops: 4000
        size: 500
        type: io1 6
        type: m6i.xlarge
      replicas: 3
compute: 7
  - hyperthreading: Enabled 8
    name: worker
    platform:
      aws:
        rootVolume:
          iops: 2000
          size: 500
          type: io1 9
          type: c5.4xlarge
        zones:
        - us-gov-west-1c
      replicas: 3
metadata:
  name: test-cluster 10
networking:
  clusterNetwork:
  - cidr: 10.128.0.0/14
    hostPrefix: 23

```

```

machineNetwork:
- cidr: 10.0.0.0/16
networkType: OpenShiftSDN
serviceNetwork:
- 172.30.0.0/16
platform:
aws:
region: us-gov-west-1 11
userTags:
adminContact: jdoe
costCenter: 7536
subnets: 12
- subnet-1
- subnet-2
- subnet-3
amiID: ami-96c6f8f7 13
serviceEndpoints: 14
- name: ec2
url: https://vpce-id.ec2.us-west-2.vpce.amazonaws.com
hostedZone: Z3URY6TWQ91KVV 15
fips: false 16
sshKey: ssh-ed25519 AAAA... 17
publish: Internal 18
pullSecret: '{"auths": ...}' 19

```

1 10 11 19 Required.

- 2 Optional: Add this parameter to force the Cloud Credential Operator (CCO) to use the specified mode, instead of having the CCO dynamically try to determine the capabilities of the credentials. For details about CCO modes, see the *Cloud Credential Operator* entry in the *Red Hat Operators reference* content.
- 3 7 If you do not provide these parameters and values, the installation program provides the default value.
- 4 The **controlPlane** section is a single mapping, but the **compute** section is a sequence of mappings. To meet the requirements of the different data structures, the first line of the **compute** section must begin with a hyphen, -, and the first line of the **controlPlane** section must not. Only one control plane pool is used.
- 5 8 Whether to enable or disable simultaneous multithreading, or **hyperthreading**. By default, simultaneous multithreading is enabled to increase the performance of your machines' cores. You can disable it by setting the parameter value to **Disabled**. If you disable simultaneous multithreading in some cluster machines, you must disable it in all cluster machines.



### IMPORTANT

If you disable simultaneous multithreading, ensure that your capacity planning accounts for the dramatically decreased machine performance. Use larger instance types, such as **m4.2xlarge** or **m5.2xlarge**, for your machines if you disable simultaneous multithreading.

- 6 9 To configure faster storage for etcd, especially for larger clusters, set the storage type as **io1** and set **iops** to **2000**.

- 12 If you provide your own VPC, specify subnets for each availability zone that your cluster uses.
- 13 The ID of the AMI used to boot machines for the cluster. If set, the AMI must belong to the same region as the cluster.
- 14 The AWS service endpoints. Custom endpoints are required when installing to an unknown AWS region. The endpoint URL must use the **https** protocol and the host must trust the certificate.
- 15 The ID of your existing Route 53 private hosted zone. Providing an existing hosted zone requires that you supply your own VPC and the hosted zone is already associated with the VPC prior to installing your cluster. If undefined, the installation program creates a new hosted zone.
- 16 Whether to enable or disable FIPS mode. By default, FIPS mode is not enabled. If FIPS mode is enabled, the Red Hat Enterprise Linux CoreOS (RHCOS) machines that OpenShift Container Platform runs on bypass the default Kubernetes cryptography suite and use the cryptography modules that are provided with RHCOS instead.



### IMPORTANT

To enable FIPS mode for your cluster, you must run the installation program from a Red Hat Enterprise Linux (RHEL) computer configured to operate in FIPS mode. For more information about configuring FIPS mode on RHEL, see [Installing the system in FIPS mode](#). The use of FIPS validated or Modules In Process cryptographic libraries is only supported on OpenShift Container Platform deployments on the **x86\_64** architecture.

- 17 You can optionally provide the **sshKey** value that you use to access the machines in your cluster.



### NOTE

For production OpenShift Container Platform clusters on which you want to perform installation debugging or disaster recovery, specify an SSH key that your **ssh-agent** process uses.

- 18 How to publish the user-facing endpoints of your cluster. Set **publish** to **Internal** to deploy a private cluster, which cannot be accessed from the internet. The default value is **External**.

#### 5.10.10.6. Configuring the cluster-wide proxy during installation

Production environments can deny direct access to the internet and instead have an HTTP or HTTPS proxy available. You can configure a new OpenShift Container Platform cluster to use a proxy by configuring the proxy settings in the **install-config.yaml** file.

#### Prerequisites

- You have an existing **install-config.yaml** file.
- You reviewed the sites that your cluster requires access to and determined whether any of them need to bypass the proxy. By default, all cluster egress traffic is proxied, including calls to hosting cloud provider APIs. You added sites to the **Proxy** object's **spec.noProxy** field to bypass the proxy if necessary.



## NOTE

The **Proxy** object **status.noProxy** field is populated with the values of the **networking.machineNetwork[].cidr**, **networking.clusterNetwork[].cidr**, and **networking.serviceNetwork[]** fields from your installation configuration.

For installations on Amazon Web Services (AWS), Google Cloud Platform (GCP), Microsoft Azure, and Red Hat OpenStack Platform (RHOSP), the **Proxy** object **status.noProxy** field is also populated with the instance metadata endpoint (**169.254.169.254**).

- You have added the **ec2.<region>.amazonaws.com**, **elasticloadbalancing.<region>.amazonaws.com**, and **s3.<region>.amazonaws.com** endpoints to your VPC endpoint. These endpoints are required to complete requests from the nodes to the AWS EC2 API. Because the proxy works on the container level, not the node level, you must route these requests to the AWS EC2 API through the AWS private network. Adding the public IP address of the EC2 API to your allowlist in your proxy server is not sufficient.

## Procedure

- Edit your **install-config.yaml** file and add the proxy settings. For example:

```
apiVersion: v1
baseDomain: my.domain.com
proxy:
  httpProxy: http://<username>:<pswd>@<ip>:<port> 1
  httpsProxy: https://<username>:<pswd>@<ip>:<port> 2
  noProxy: example.com 3
  additionalTrustBundle: | 4
    -----BEGIN CERTIFICATE-----
    <MY_TRUSTED_CA_CERT>
    -----END CERTIFICATE-----
  ...
```

- A proxy URL to use for creating HTTP connections outside the cluster. The URL scheme must be **http**.
- A proxy URL to use for creating HTTPS connections outside the cluster.
- A comma-separated list of destination domain names, IP addresses, or other network CIDRs to exclude from proxying. Preface a domain with **.** to match subdomains only. For example, **.y.com** matches **x.y.com**, but not **y.com**. Use **\*** to bypass the proxy for all destinations.
- If provided, the installation program generates a config map that is named **user-ca-bundle** in the **openshift-config** namespace that contains one or more additional CA certificates that are required for proxying HTTPS connections. The Cluster Network Operator then creates a **trusted-ca-bundle** config map that merges these contents with the Red Hat Enterprise Linux CoreOS (RHCOS) trust bundle, and this config map is referenced in the **trustedCA** field of the **Proxy** object. The **additionalTrustBundle** field is required unless the proxy's identity certificate is signed by an authority from the RHCOS trust bundle.

**NOTE**

The installation program does not support the proxy **readinessEndpoints** field.

**NOTE**

If the installer times out, restart and then complete the deployment by using the **wait-for** command of the installer. For example:

```
$. /openshift-install wait-for install-complete --log-level debug
```

2. Save the file and reference it when installing OpenShift Container Platform.

The installation program creates a cluster-wide proxy that is named **cluster** that uses the proxy settings in the provided **install-config.yaml** file. If no proxy settings are provided, a **cluster Proxy** object is still created, but it will have a nil **spec**.

**NOTE**

Only the **Proxy** object named **cluster** is supported, and no additional proxies can be created.

### 5.10.11. Deploying the cluster

You can install OpenShift Container Platform on a compatible cloud platform.

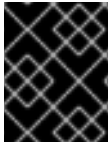
**IMPORTANT**

You can run the **create cluster** command of the installation program only once, during initial installation.

#### Prerequisites

- Configure an account with the cloud platform that hosts your cluster.
- Obtain the OpenShift Container Platform installation program and the pull secret for your cluster.

#### Procedure

1. Change to the directory that contains the installation program and initialize the cluster deployment:

```
$. /openshift-install create cluster --dir <installation_directory> \ 1
--log-level=info 2
```

**1** For **<installation\_directory>**, specify the location of your customized **./install-config.yaml** file.

**2** To view different installation details, specify **warn**, **debug**, or **error** instead of **info**.



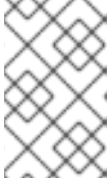

## NOTE

If the cloud provider account that you configured on your host does not have sufficient permissions to deploy the cluster, the installation process stops, and the missing permissions are displayed.

When the cluster deployment completes, directions for accessing your cluster, including a link to its web console and credentials for the **kubeadmin** user, display in your terminal.

## Example output

```
...
INFO Install complete!
INFO To access the cluster as the system:admin user when using 'oc', run 'export
KUBECONFIG=/home/myuser/install_dir/auth/kubeconfig'
INFO Access the OpenShift web-console here: https://console-openshift-
console.apps.mycluster.example.com
INFO Login to the console with user: "kubeadmin", and password: "4vYBz-Ee6gm-ymBZj-
Wt5AL"
INFO Time elapsed: 36m22s
```



## NOTE

The cluster access and credential information also outputs to **<installation\_directory>/openshift\_install.log** when an installation succeeds.



## IMPORTANT

- The Ignition config files that the installation program generates contain certificates that expire after 24 hours, which are then renewed at that time. If the cluster is shut down before renewing the certificates and the cluster is later restarted after the 24 hours have elapsed, the cluster automatically recovers the expired certificates. The exception is that you must manually approve the pending **node-bootstrapper** certificate signing requests (CSRs) to recover kubelet certificates. See the documentation for *Recovering from expired control plane certificates* for more information.
- It is recommended that you use Ignition config files within 12 hours after they are generated because the 24-hour certificate rotates from 16 to 22 hours after the cluster is installed. By using the Ignition config files within 12 hours, you can avoid installation failure if the certificate update runs during installation.

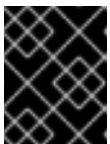

## IMPORTANT

You must not delete the installation program or the files that the installation program creates. Both are required to delete the cluster.

2. Optional: Remove or disable the **AdministratorAccess** policy from the IAM account that you used to install the cluster.

**NOTE**

The elevated permissions provided by the **AdministratorAccess** policy are required only during installation.

### 5.10.12. Installing the OpenShift CLI by downloading the binary

You can install the OpenShift CLI (**oc**) to interact with OpenShift Container Platform from a command-line interface. You can install **oc** on Linux, Windows, or macOS.

**IMPORTANT**

If you installed an earlier version of **oc**, you cannot use it to complete all of the commands in OpenShift Container Platform 4.10. Download and install the new version of **oc**.

#### Installing the OpenShift CLI on Linux

You can install the OpenShift CLI (**oc**) binary on Linux by using the following procedure.

##### Procedure

1. Navigate to the [OpenShift Container Platform downloads page](#) on the Red Hat Customer Portal.
2. Select the appropriate version in the **Version** drop-down menu.
3. Click **Download Now** next to the **OpenShift v4.10 Linux Client** entry and save the file.
4. Unpack the archive:

```
$ tar xvf <file>
```

5. Place the **oc** binary in a directory that is on your **PATH**.  
To check your **PATH**, execute the following command:

```
$ echo $PATH
```

After you install the OpenShift CLI, it is available using the **oc** command:

```
$ oc <command>
```

#### Installing the OpenShift CLI on Windows

You can install the OpenShift CLI (**oc**) binary on Windows by using the following procedure.

##### Procedure

1. Navigate to the [OpenShift Container Platform downloads page](#) on the Red Hat Customer Portal.
2. Select the appropriate version in the **Version** drop-down menu.
3. Click **Download Now** next to the **OpenShift v4.10 Windows Client** entry and save the file.
4. Unzip the archive with a ZIP program.

5. Move the **oc** binary to a directory that is on your **PATH**.  
To check your **PATH**, open the command prompt and execute the following command:

```
C:\> path
```

After you install the OpenShift CLI, it is available using the **oc** command:

```
C:\> oc <command>
```

### Installing the OpenShift CLI on macOS

You can install the OpenShift CLI (**oc**) binary on macOS by using the following procedure.

#### Procedure

1. Navigate to the [OpenShift Container Platform downloads page](#) on the Red Hat Customer Portal.
2. Select the appropriate version in the **Version** drop-down menu.
3. Click **Download Now** next to the **OpenShift v4.10 MacOSX Client** entry and save the file.
4. Unpack and unzip the archive.
5. Move the **oc** binary to a directory on your PATH.  
To check your **PATH**, open a terminal and execute the following command:

```
$ echo $PATH
```

After you install the OpenShift CLI, it is available using the **oc** command:

```
$ oc <command>
```

### 5.10.13. Logging in to the cluster by using the CLI

You can log in to your cluster as a default system user by exporting the cluster **kubeconfig** file. The **kubeconfig** file contains information about the cluster that is used by the CLI to connect a client to the correct cluster and API server. The file is specific to a cluster and is created during OpenShift Container Platform installation.

#### Prerequisites

- You deployed an OpenShift Container Platform cluster.
- You installed the **oc** CLI.

#### Procedure

1. Export the **kubeadmin** credentials:

```
$ export KUBECONFIG=<installation_directory>/auth/kubeconfig 1
```

- 1** For **<installation\_directory>**, specify the path to the directory that you stored the installation files in.

2. Verify you can run **oc** commands successfully using the exported configuration:

```
$ oc whoami
```

#### Example output

```
system:admin
```

### 5.10.14. Logging in to the cluster by using the web console

The **kubeadmin** user exists by default after an OpenShift Container Platform installation. You can log in to your cluster as the **kubeadmin** user by using the OpenShift Container Platform web console.

#### Prerequisites

- You have access to the installation host.
- You completed a cluster installation and all cluster Operators are available.

#### Procedure

1. Obtain the password for the **kubeadmin** user from the **kubeadmin-password** file on the installation host:

```
$ cat <installation_directory>/auth/kubeadmin-password
```

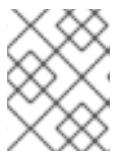

#### NOTE

Alternatively, you can obtain the **kubeadmin** password from the **<installation\_directory>/openshift\_install.log** log file on the installation host.

2. List the OpenShift Container Platform web console route:

```
$ oc get routes -n openshift-console | grep 'console-openshift'
```



#### NOTE

Alternatively, you can obtain the OpenShift Container Platform route from the **<installation\_directory>/openshift\_install.log** log file on the installation host.

#### Example output

```
console console-openshift-console.apps.<cluster_name>.<base_domain> console
https reencrypt/Redirect None
```

3. Navigate to the route detailed in the output of the preceding command in a web browser and log in as the **kubeadmin** user.

#### Additional resources

- See [Accessing the web console](#) for more details about accessing and understanding the OpenShift Container Platform web console.

### 5.10.15. Telemetry access for OpenShift Container Platform

In OpenShift Container Platform 4.10, the Telemetry service, which runs by default to provide metrics about cluster health and the success of updates, requires internet access. If your cluster is connected to the internet, Telemetry runs automatically, and your cluster is registered to [OpenShift Cluster Manager](#).

After you confirm that your [OpenShift Cluster Manager](#) inventory is correct, either maintained automatically by Telemetry or manually by using OpenShift Cluster Manager, [use subscription watch](#) to track your OpenShift Container Platform subscriptions at the account or multi-cluster level.

#### Additional resources

- See [About remote health monitoring](#) for more information about the Telemetry service.

### 5.10.16. Next steps

- [Validating an installation](#).
- [Customize your cluster](#).
- If necessary, you can [opt out of remote health reporting](#).
- If necessary, you can [remove cloud provider credentials](#).

## 5.11. INSTALLING A CLUSTER ON AWS INTO A TOP SECRET REGION

In OpenShift Container Platform version 4.10, you can install a cluster on Amazon Web Services (AWS) into a Commercial Cloud Services (C2S) Top Secret Region. To configure the region, modify parameters in the `install config.yaml` file before you install the cluster.

### 5.11.1. Prerequisites

- You reviewed details about the [OpenShift Container Platform installation and update](#) processes.
- You read the documentation on [selecting a cluster installation method and preparing it for users](#).
- You [configured an AWS account](#) to host the cluster.

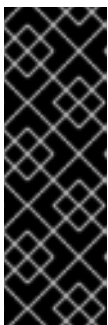

#### IMPORTANT

If you have an AWS profile stored on your computer, it must not use a temporary session token that you generated while using a multifactor authentication device. The cluster continues to use your current AWS credentials to create AWS resources for the entire life of the cluster, so you must use long-lived credentials. To generate appropriate keys, see [Managing Access Keys for IAM Users](#) in the AWS documentation. You can supply the keys when you run the installation program.

- If you use a firewall, you [configured it to allow the sites](#) that your cluster requires access to.

- If the cloud identity and access management (IAM) APIs are not accessible in your environment, or if you do not want to store an administrator-level credential secret in the **kube-system** namespace, you can [manually create and maintain IAM credentials](#).

### 5.11.2. AWS Top Secret Region

OpenShift Container Platform supports deploying a cluster to an [AWS Commercial Cloud Services \(C2S\) Top Secret Region](#).

The C2S Top Secret Region does not have a published Red Hat Enterprise Linux CoreOS (RHCOS) Amazon Machine Images (AMI) to select, so you must upload a custom AMI that belongs to that region.

The following AWS Top Secret Region partition is supported:

- **us-iso-east-1**



#### NOTE

The maximum supported MTU in an AWS Top Secret Region is not the same as AWS commercial. For more information about configuring MTU during installation, see the *Cluster Network Operator configuration object* section in *Installing a cluster on AWS with network customizations*

### 5.11.3. Installation requirements

Red Hat does not publish a Red Hat Enterprise Linux CoreOS (RHCOS) Amazon Machine Image for the AWS Top Secret Region.

Before you can install the cluster, you must:

- Upload a custom RHCOS AMI.
- Manually create the installation configuration file (**install-config.yaml**).
- Specify the AWS region, and the accompanying custom AMI, in the installation configuration file.

You cannot use the OpenShift Container Platform installation program to create the installation configuration file. The installer does not list an AWS region without native support for an RHCOS AMI.



#### IMPORTANT

You must also define a custom CA certificate in the **additionalTrustBundle** field of the **install-config.yaml** file because the AWS API requires a custom CA trust bundle. To allow the installation program to access the AWS API, the CA certificates must also be defined on the machine that runs the installation program. You must add the CA bundle to the trust store on the machine, use the **AWS\_CA\_BUNDLE** environment variable, or define the CA bundle in the **ca\_bundle** field of the AWS config file.

### 5.11.4. Private clusters

You can deploy a private OpenShift Container Platform cluster that does not expose external endpoints. Private clusters are accessible from only an internal network and are not visible to the internet.

**NOTE**

Public zones are not supported in Route 53 in an AWS Top Secret Region. Therefore, clusters must be private if they are deployed to an AWS Top Secret Region.

By default, OpenShift Container Platform is provisioned to use publicly-accessible DNS and endpoints. A private cluster sets the DNS, Ingress Controller, and API server to private when you deploy your cluster. This means that the cluster resources are only accessible from your internal network and are not visible to the internet.

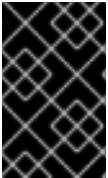
**IMPORTANT**

If the cluster has any public subnets, load balancer services created by administrators might be publicly accessible. To ensure cluster security, verify that these services are explicitly annotated as private.

To deploy a private cluster, you must:

- Use existing networking that meets your requirements. Your cluster resources might be shared between other clusters on the network.
- Deploy from a machine that has access to:
  - The API services for the cloud to which you provision.
  - The hosts on the network that you provision.
  - The internet to obtain installation media.

You can use any machine that meets these access requirements and follows your company's guidelines. For example, this machine can be a bastion host on your cloud network or a machine that has access to the network through a VPN.

#### 5.11.4.1. Private clusters in AWS

To create a private cluster on Amazon Web Services (AWS), you must provide an existing private VPC and subnets to host the cluster. The installation program must also be able to resolve the DNS records that the cluster requires. The installation program configures the Ingress Operator and API server for access from only the private network.

The cluster still requires access to internet to access the AWS APIs.

The following items are not required or created when you install a private cluster:

- Public subnets
- Public load balancers, which support public ingress
- A public Route 53 zone that matches the **baseDomain** for the cluster

The installation program does use the **baseDomain** that you specify to create a private Route 53 zone and the required records for the cluster. The cluster is configured so that the Operators do not create public records for the cluster and all cluster machines are placed in the private subnets that you specify.

##### 5.11.4.1.1. Limitations

The ability to add public functionality to a private cluster is limited.

- You cannot make the Kubernetes API endpoints public after installation without taking additional actions, including creating public subnets in the VPC for each availability zone in use, creating a public load balancer, and configuring the control plane security groups to allow traffic from the internet on 6443 (Kubernetes API port).
- If you use a public Service type load balancer, you must tag a public subnet in each availability zone with **kubernetes.io/cluster/<cluster-infra-id>: shared** so that AWS can use them to create public load balancers.

### 5.11.5. About using a custom VPC

In OpenShift Container Platform 4.10, you can deploy a cluster into existing subnets in an existing Amazon Virtual Private Cloud (VPC) in Amazon Web Services (AWS). By deploying OpenShift Container Platform into an existing AWS VPC, you might be able to avoid limit constraints in new accounts or more easily abide by the operational constraints that your company's guidelines set. If you cannot obtain the infrastructure creation permissions that are required to create the VPC yourself, use this installation option.

Because the installation program cannot know what other components are also in your existing subnets, it cannot choose subnet CIDRs and so forth on your behalf. You must configure networking for the subnets that you install your cluster to yourself.

#### 5.11.5.1. Requirements for using your VPC

The installation program no longer creates the following components:

- Internet gateways
- NAT gateways
- Subnets
- Route tables
- VPCs
- VPC DHCP options
- VPC endpoints



#### NOTE

The installation program requires that you use the cloud-provided DNS server. Using a custom DNS server is not supported and causes the installation to fail.

If you use a custom VPC, you must correctly configure it and its subnets for the installation program and the cluster to use. See [Amazon VPC console wizard configurations](#) and [Work with VPCs and subnets](#) in the AWS documentation for more information on creating and managing an AWS VPC.

The installation program cannot:

- Subdivide network ranges for the cluster to use.
- Set route tables for the subnets.



- Set VPC options like DHCP.

You must complete these tasks before you install the cluster. See [VPC networking components](#) and [Route tables for your VPC](#) for more information on configuring networking in an AWS VPC.

Your VPC must meet the following characteristics:

- The VPC must not use the **kubernetes.io/cluster/.\*: owned** tag. The installation program modifies your subnets to add the **kubernetes.io/cluster/.\*: shared** tag, so your subnets must have at least one free tag slot available for it. See [Tag Restrictions](#) in the AWS documentation to confirm that the installation program can add a tag to each subnet that you specify.
- You must enable the **enableDnsSupport** and **enableDnsHostnames** attributes in your VPC, so that the cluster can use the Route 53 zones that are attached to the VPC to resolve cluster's internal DNS records. See [DNS Support in Your VPC](#) in the AWS documentation. If you prefer to use your own Route 53 hosted private zone, you must associate the existing hosted zone with your VPC prior to installing a cluster. You can define your hosted zone using the **platform.aws.hostedZone** field in the **install-config.yaml** file.
- A cluster in a Top Secret Region is unable to reach the public IP addresses for the EC2 and ELB endpoints. You must create a VPC endpoint and attach it to the subnet that the clusters are using. Name the endpoints as follows:
  - **elasticloadbalancing.<region>.c2s.ic.gov**
  - **ec2.<region>.c2s.ic.gov**
  - **s3.<region>.c2s.ic.gov**

## Required VPC components

You must provide a suitable VPC and subnets that allow communication to your machines.

Component	AWS type	Description
VPC	<ul style="list-style-type: none"> <li>• <b>AWS::EC2::VPC</b></li> <li>• <b>AWS::EC2::VPCEndpoint</b></li> </ul>	You must provide a public VPC for the cluster to use. The VPC uses an endpoint that references the route tables for each subnet to improve communication with the registry that is hosted in S3.
Public subnets	<ul style="list-style-type: none"> <li>• <b>AWS::EC2::Subnet</b></li> <li>• <b>AWS::EC2::SubnetNetworkAclAssociation</b></li> </ul>	Your VPC must have public subnets for between 1 and 3 availability zones and associate them with appropriate Ingress rules.

Component	AWS type	Description												
Internet gateway	<ul style="list-style-type: none"> <li>● <b>AWS::EC2::InternetGateway</b></li> <li>● <b>AWS::EC2::VPCElasticGatewayAttachment</b></li> <li>● <b>AWS::EC2::RouteTable</b></li> <li>● <b>AWS::EC2::Route</b></li> <li>● <b>AWS::EC2::SubnetRouteTableAssociation</b></li> <li>● <b>AWS::EC2::NatGateway</b></li> <li>● <b>AWS::EC2::EIP</b></li> </ul>	<p>You must have a public internet gateway, with public routes, attached to the VPC. In the provided templates, each public subnet has a NAT gateway with an EIP address. These NAT gateways allow cluster resources, like private subnet instances, to reach the internet and are not required for some restricted network or proxy scenarios.</p>												
Network access control	<ul style="list-style-type: none"> <li>● <b>AWS::EC2::NetworkAcl</b></li> <li>● <b>AWS::EC2::NetworkAclEntry</b></li> </ul>	<p>You must allow the VPC to access the following ports:</p> <table border="1"> <thead> <tr> <th>Port</th> <th>Reason</th> </tr> </thead> <tbody> <tr> <td><b>80</b></td> <td>Inbound HTTP traffic</td> </tr> <tr> <td><b>443</b></td> <td>Inbound HTTPS traffic</td> </tr> <tr> <td><b>22</b></td> <td>Inbound SSH traffic</td> </tr> <tr> <td><b>1024 - 65535</b></td> <td>Inbound ephemeral traffic</td> </tr> <tr> <td><b>0 - 65535</b></td> <td>Outbound ephemeral traffic</td> </tr> </tbody> </table>	Port	Reason	<b>80</b>	Inbound HTTP traffic	<b>443</b>	Inbound HTTPS traffic	<b>22</b>	Inbound SSH traffic	<b>1024 - 65535</b>	Inbound ephemeral traffic	<b>0 - 65535</b>	Outbound ephemeral traffic
Port	Reason													
<b>80</b>	Inbound HTTP traffic													
<b>443</b>	Inbound HTTPS traffic													
<b>22</b>	Inbound SSH traffic													
<b>1024 - 65535</b>	Inbound ephemeral traffic													
<b>0 - 65535</b>	Outbound ephemeral traffic													
Private subnets	<ul style="list-style-type: none"> <li>● <b>AWS::EC2::Subnet</b></li> <li>● <b>AWS::EC2::RouteTable</b></li> <li>● <b>AWS::EC2::SubnetRouteTableAssociation</b></li> </ul>	<p>Your VPC can have private subnets. The provided CloudFormation templates can create private subnets for between 1 and 3 availability zones. If you use private subnets, you must provide appropriate routes and tables for them.</p>												

### 5.11.5.2. VPC validation

To ensure that the subnets that you provide are suitable, the installation program confirms the following data:

- All the subnets that you specify exist.
- You provide private subnets.
- The subnet CIDRs belong to the machine CIDR that you specified.
- You provide subnets for each availability zone. Each availability zone contains no more than one public and one private subnet. If you use a private cluster, provide only a private subnet for each availability zone. Otherwise, provide exactly one public and private subnet for each availability zone.
- You provide a public subnet for each private subnet availability zone. Machines are not provisioned in availability zones that you do not provide private subnets for.

If you destroy a cluster that uses an existing VPC, the VPC is not deleted. When you remove the OpenShift Container Platform cluster from a VPC, the **kubernetes.io/cluster/.\*: shared** tag is removed from the subnets that it used.

### 5.11.5.3. Division of permissions

Starting with OpenShift Container Platform 4.3, you do not need all of the permissions that are required for an installation program-provisioned infrastructure cluster to deploy a cluster. This change mimics the division of permissions that you might have at your company: some individuals can create different resource in your clouds than others. For example, you might be able to create application-specific items, like instances, buckets, and load balancers, but not networking-related components such as VPCs, subnets, or ingress rules.

The AWS credentials that you use when you create your cluster do not need the networking permissions that are required to make VPCs and core networking components within the VPC, such as subnets, routing tables, internet gateways, NAT, and VPN. You still need permission to make the application resources that the machines within the cluster require, such as ELBs, security groups, S3 buckets, and nodes.

### 5.11.5.4. Isolation between clusters

If you deploy OpenShift Container Platform to an existing network, the isolation of cluster services is reduced in the following ways:

- You can install multiple OpenShift Container Platform clusters in the same VPC.
- ICMP ingress is allowed from the entire network.
- TCP 22 ingress (SSH) is allowed to the entire network.
- Control plane TCP 6443 ingress (Kubernetes API) is allowed to the entire network.
- Control plane TCP 22623 ingress (MCS) is allowed to the entire network.

### 5.11.6. Internet access for OpenShift Container Platform

In OpenShift Container Platform 4.10, you require access to the internet to install your cluster.

You must have internet access to:

- Access [OpenShift Cluster Manager](#) to download the installation program and perform subscription management. If the cluster has internet access and you do not disable Telemetry, that service automatically entitles your cluster.
- Access [Quay.io](#) to obtain the packages that are required to install your cluster.
- Obtain the packages that are required to perform cluster updates.

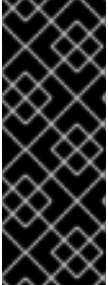

### IMPORTANT

If your cluster cannot have direct internet access, you can perform a restricted network installation on some types of infrastructure that you provision. During that process, you download the required content and use it to populate a mirror registry with the installation packages. With some installation types, the environment that you install your cluster in will not require internet access. Before you update the cluster, you update the content of the mirror registry.

## 5.11.7. Uploading a custom RHCOS AMI in AWS

If you are deploying to a custom Amazon Web Services (AWS) region, you must upload a custom Red Hat Enterprise Linux CoreOS (RHCOS) Amazon Machine Image (AMI) that belongs to that region.

### Prerequisites

- You configured an AWS account.
- You created an Amazon S3 bucket with the required IAM [service role](#).
- You uploaded your RHCOS VMDK file to Amazon S3. The RHCOS VMDK file must be the highest version that is less than or equal to the OpenShift Container Platform version you are installing.
- You downloaded the AWS CLI and installed it on your computer. See [Install the AWS CLI Using the Bundled Installer](#).

### Procedure

1. Export your AWS profile as an environment variable:

```
$ export AWS_PROFILE=<aws_profile> 1
```

2. Export the region to associate with your custom AMI as an environment variable:

```
$ export AWS_DEFAULT_REGION=<aws_region> 1
```

3. Export the version of RHCOS you uploaded to Amazon S3 as an environment variable:

```
$ export RHCOS_VERSION=<version> 1
```

1 1 1 The RHCOS VMDK version, like **4.10.0**.

4. Export the Amazon S3 bucket name as an environment variable:

```
$ export VMIMPORT_BUCKET_NAME=<s3_bucket_name>
```

5. Create the **containers.json** file and define your RHCOS VMDK file:

```
$ cat <<EOF > containers.json
{
  "Description": "rhcos- $\{RHCOS\_VERSION\}$ -x86_64-aws.x86_64",
  "Format": "vmdk",
  "UserBucket": {
    "S3Bucket": " $\{VMIMPORT\_BUCKET\_NAME\}$ ",
    "S3Key": "rhcos- $\{RHCOS\_VERSION\}$ -x86_64-aws.x86_64.vmdk"
  }
}
EOF
```

6. Import the RHCOS disk as an Amazon EBS snapshot:

```
$ aws ec2 import-snapshot --region  $\{AWS\_DEFAULT\_REGION\}$  \
  --description "<description>" \ 1
  --disk-container "file://<file_path>/containers.json" 2
```

1 The description of your RHCOS disk being imported, like **rhcos- $\{RHCOS\_VERSION\}$ -x86\_64-aws.x86\_64**.

2 The file path to the JSON file describing your RHCOS disk. The JSON file should contain your Amazon S3 bucket name and key.

7. Check the status of the image import:

```
$ watch -n 5 aws ec2 describe-import-snapshot-tasks --region  $\{AWS\_DEFAULT\_REGION\}$ 
```

### Example output

```
{
  "ImportSnapshotTasks": [
    {
      "Description": "rhcos-4.7.0-x86_64-aws.x86_64",
      "ImportTaskId": "import-snap-fh6i8uil",
      "SnapshotTaskDetail": {
        "Description": "rhcos-4.7.0-x86_64-aws.x86_64",
        "DiskImageSize": 819056640.0,
        "Format": "VMDK",
        "SnapshotId": "snap-06331325870076318",
        "Status": "completed",
        "UserBucket": {
          "S3Bucket": "external-images",
          "S3Key": "rhcos-4.7.0-x86_64-aws.x86_64.vmdk"
        }
      }
    }
  ]
}
```

Copy the **SnapshotId** to register the image.

8. Create a custom RHCOS AMI from the RHCOS snapshot:

```
$ aws ec2 register-image \
  --region ${AWS_DEFAULT_REGION} \
  --architecture x86_64 \ 1
  --description "rhcos-${RHCOS_VERSION}-x86_64-aws.x86_64" \ 2
  --ena-support \
  --name "rhcos-${RHCOS_VERSION}-x86_64-aws.x86_64" \ 3
  --virtualization-type hvm \
  --root-device-name '/dev/xvda' \
  --block-device-mappings 'DeviceName=/dev/xvda,Ebs=
  {DeleteOnTermination=true,SnapshotId=<snapshot_ID>}' 4
```

- 1 The RHCOS VMDK architecture type, like **x86\_64**, **s390x**, or **ppc64le**.
- 2 The **Description** from the imported snapshot.
- 3 The name of the RHCOS AMI.
- 4 The **SnapshotID** from the imported snapshot.

To learn more about these APIs, see the AWS documentation for [importing snapshots](#) and [creating EBS-backed AMIs](#).

### 5.11.8. Generating a key pair for cluster node SSH access

During an OpenShift Container Platform installation, you can provide an SSH public key to the installation program. The key is passed to the Red Hat Enterprise Linux CoreOS (RHCOS) nodes through their Ignition config files and is used to authenticate SSH access to the nodes. The key is added to the `~/.ssh/authorized_keys` list for the **core** user on each node, which enables password-less authentication.

After the key is passed to the nodes, you can use the key pair to SSH in to the RHCOS nodes as the user **core**. To access the nodes through SSH, the private key identity must be managed by SSH for your local user.

If you want to SSH in to your cluster nodes to perform installation debugging or disaster recovery, you must provide the SSH public key during the installation process. The `./openshift-install gather` command also requires the SSH public key to be in place on the cluster nodes.



#### IMPORTANT

Do not skip this procedure in production environments, where disaster recovery and debugging is required.



#### NOTE

You must use a local key, not one that you configured with platform-specific approaches such as [AWS key pairs](#).

#### Procedure

1. If you do not have an existing SSH key pair on your local machine to use for authentication onto your cluster nodes, create one. For example, on a computer that uses a Linux operating system, run the following command:

```
$ ssh-keygen -t ed25519 -N "" -f <path>/<file_name> 1
```

- 1 Specify the path and file name, such as `~/.ssh/id_ed25519`, of the new SSH key. If you have an existing key pair, ensure your public key is in the your `~/.ssh` directory.



#### NOTE

If you plan to install an OpenShift Container Platform cluster that uses FIPS validated or Modules In Process cryptographic libraries on the **x86\_64** architecture, do not create a key that uses the **ed25519** algorithm. Instead, create a key that uses the **rsa** or **ecdsa** algorithm.

2. View the public SSH key:

```
$ cat <path>/<file_name>.pub
```

For example, run the following to view the `~/.ssh/id_ed25519.pub` public key:

```
$ cat ~/.ssh/id_ed25519.pub
```

3. Add the SSH private key identity to the SSH agent for your local user, if it has not already been added. SSH agent management of the key is required for password-less SSH authentication onto your cluster nodes, or if you want to use the `./openshift-install gather` command.



#### NOTE

On some distributions, default SSH private key identities such as `~/.ssh/id_rsa` and `~/.ssh/id_dsa` are managed automatically.

- a. If the **ssh-agent** process is not already running for your local user, start it as a background task:

```
$ eval "$(ssh-agent -s)"
```

#### Example output

```
Agent pid 31874
```



#### NOTE

If your cluster is in FIPS mode, only use FIPS-compliant algorithms to generate the SSH key. The key must be either RSA or ECDSA.

4. Add your SSH private key to the **ssh-agent**:

```
$ ssh-add <path>/<file_name> 1
```

- 1 Specify the path and file name for your SSH private key, such as `~/.ssh/id_ed25519`

### Example output

```
Identity added: /home/<you>/<path>/<file_name> (<computer_name>)
```

### Next steps

- When you install OpenShift Container Platform, provide the SSH public key to the installation program.

## 5.11.9. Obtaining the installation program

Before you install OpenShift Container Platform, download the installation file on a local computer.

### Prerequisites

- You have a computer that runs Linux or macOS, with 500 MB of local disk space

### Procedure

1. Access the [Infrastructure Provider](#) page on the OpenShift Cluster Manager site. If you have a Red Hat account, log in with your credentials. If you do not, create an account.
2. Select your infrastructure provider.
3. Navigate to the page for your installation type, download the installation program that corresponds with your host operating system and architecture, and place the file in the directory where you will store the installation configuration files.

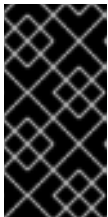

#### IMPORTANT

The installation program creates several files on the computer that you use to install your cluster. You must keep the installation program and the files that the installation program creates after you finish installing the cluster. Both files are required to delete the cluster.

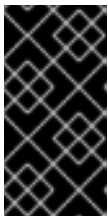

#### IMPORTANT

Deleting the files created by the installation program does not remove your cluster, even if the cluster failed during installation. To remove your cluster, complete the OpenShift Container Platform uninstallation procedures for your specific cloud provider.

4. Extract the installation program. For example, on a computer that uses a Linux operating system, run the following command:

```
$ tar -xvf openshift-install-linux.tar.gz
```

5. Download your installation [pull secret from the Red Hat OpenShift Cluster Manager](#) . This pull secret allows you to authenticate with the services that are provided by the included authorities, including Quay.io, which serves the container images for OpenShift Container Platform



components.

### 5.11.10. Manually creating the installation configuration file

Installing the cluster requires that you manually generate the installation configuration file.

#### Prerequisites

- You have uploaded a custom RHCOS AMI.
- You have an SSH public key on your local machine to provide to the installation program. The key will be used for SSH authentication onto your cluster nodes for debugging and disaster recovery.
- You have obtained the OpenShift Container Platform installation program and the pull secret for your cluster.

#### Procedure

1. Create an installation directory to store your required installation assets in:

```
$ mkdir <installation_directory>
```



#### IMPORTANT

You must create a directory. Some installation assets, like bootstrap X.509 certificates have short expiration intervals, so you must not reuse an installation directory. If you want to reuse individual files from another cluster installation, you can copy them into your directory. However, the file names for the installation assets might change between releases. Use caution when copying installation files from an earlier OpenShift Container Platform version.

2. Customize the sample **install-config.yaml** file template that is provided and save it in the **<installation\_directory>**.



#### NOTE

You must name this configuration file **install-config.yaml**.

3. Back up the **install-config.yaml** file so that you can use it to install multiple clusters.

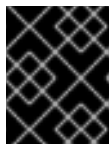

#### IMPORTANT

The **install-config.yaml** file is consumed during the next step of the installation process. You must back it up now.

#### 5.11.10.1. Installation configuration parameters

Before you deploy an OpenShift Container Platform cluster, you provide parameter values to describe your account on the cloud platform that hosts your cluster and optionally customize your cluster's platform. When you create the **install-config.yaml** installation configuration file, you provide values for the required parameters through the command line. If you customize your cluster, you can modify the **install-config.yaml** file to provide more details about the platform.

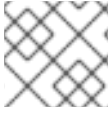
**NOTE**

After installation, you cannot modify these parameters in the **install-config.yaml** file.

**5.11.10.1.1. Required configuration parameters**

Required installation configuration parameters are described in the following table:

**Table 5.38. Required parameters**

Parameter	Description	Values
<b>apiVersion</b>	The API version for the <b>install-config.yaml</b> content. The current version is <b>v1</b> . The installer may also support older API versions.	String
<b>baseDomain</b>	The base domain of your cloud provider. The base domain is used to create routes to your OpenShift Container Platform cluster components. The full DNS name for your cluster is a combination of the <b>baseDomain</b> and <b>metadata.name</b> parameter values that uses the <b>&lt;metadata.name&gt;.&lt;baseDomain&gt;</b> format.	A fully-qualified domain or subdomain name, such as <b>example.com</b> .
<b>metadata</b>	Kubernetes resource <b>ObjectMeta</b> , from which only the <b>name</b> parameter is consumed.	Object
<b>metadata.name</b>	The name of the cluster. DNS records for the cluster are all subdomains of <b>{{.metadata.name}}.{{.baseDomain}}</b> .	String of lowercase letters, hyphens (-), and periods (.), such as <b>dev</b> .

Parameter	Description	Values
<b>platform</b>	The configuration for the specific platform upon which to perform the installation: <b>alibabacloud</b> , <b>aws</b> , <b>baremetal</b> , <b>azure</b> , <b>gcp</b> , <b>ibmcloud</b> , <b>openstack</b> , <b>ovirt</b> , <b>vsphere</b> , or <b>{}</b> . For additional information about <b>platform.&lt;platform&gt;</b> parameters, consult the table for your specific platform that follows.	Object
<b>pullSecret</b>	Get a <a href="#">pull secret from the Red Hat OpenShift Cluster Manager</a> to authenticate downloading container images for OpenShift Container Platform components from services such as Quay.io.	<pre>{   "auths":{     "cloud.openshift.com":{       "auth":"b3Blb=",       "email":"you@example.com"     },     "quay.io":{       "auth":"b3Blb=",       "email":"you@example.com"     }   } }</pre>

#### 5.11.10.1.2. Network configuration parameters

You can customize your installation configuration based on the requirements of your existing network infrastructure. For example, you can expand the IP address block for the cluster network or provide different IP address blocks than the defaults.

Only IPv4 addresses are supported.

**Table 5.39. Network parameters**

Parameter	Description	Values
-----------	-------------	--------

Parameter	Description	Values
<b>networking</b>	The configuration for the cluster network.	Object  <b>NOTE</b> You cannot modify parameters specified by the <b>networking</b> object after installation.
<b>networking.networkType</b>	The cluster network provider Container Network Interface (CNI) plugin to install.	Either <b>OpenShiftSDN</b> or <b>OVNKubernetes</b> . <b>OpenShiftSDN</b> is a CNI provider for all-Linux networks. <b>OVNKubernetes</b> is a CNI provider for Linux networks and hybrid networks that contain both Linux and Windows servers. The default value is <b>OpenShiftSDN</b> .
<b>networking.clusterNetwork</b>	The IP address blocks for pods.  The default value is <b>10.128.0.0/14</b> with a host prefix of <b>/23</b> .  If you specify multiple IP address blocks, the blocks must not overlap.	An array of objects. For example:  <pre>networking:   clusterNetwork:     - cidr: 10.128.0.0/14       hostPrefix: 23</pre>
<b>networking.clusterNetwork.cidr</b>	Required if you use <b>networking.clusterNetwork</b> . An IP address block.  An IPv4 network.	An IP address block in Classless Inter-Domain Routing (CIDR) notation. The prefix length for an IPv4 block is between <b>0</b> and <b>32</b> .
<b>networking.clusterNetwork.hostPrefix</b>	The subnet prefix length to assign to each individual node. For example, if <b>hostPrefix</b> is set to <b>23</b> then each node is assigned a <b>/23</b> subnet out of the given <b>cidr</b> . A <b>hostPrefix</b> value of <b>23</b> provides 510 ( $2^{(32 - 23)} - 2$ ) pod IP addresses.	A subnet prefix.  The default value is <b>23</b> .
<b>networking.serviceNetwork</b>	The IP address block for services. The default value is <b>172.30.0.0/16</b> .  The OpenShift SDN and OVN-Kubernetes network providers support only a single IP address block for the service network.	An array with an IP address block in CIDR format. For example:  <pre>networking:   serviceNetwork:     - 172.30.0.0/16</pre>

Parameter	Description	Values
<b>networking.machineNetwork</b>	The IP address blocks for machines.  If you specify multiple IP address blocks, the blocks must not overlap.	An array of objects. For example:  <pre>networking:   machineNetwork:   - cidr: 10.0.0.0/16</pre>
<b>networking.machineNetwork.cidr</b>	Required if you use <b>networking.machineNetwork</b> . An IP address block. The default value is <b>10.0.0.0/16</b> for all platforms other than libvirt. For libvirt, the default value is <b>192.168.126.0/24</b> .	An IP network block in CIDR notation.  For example, <b>10.0.0.0/16</b> .   <p><b>NOTE</b></p> <p>Set the <b>networking.machineNetwork</b> to match the CIDR that the preferred NIC resides in.</p>

### 5.11.10.1.3. Optional configuration parameters

Optional installation configuration parameters are described in the following table:

Table 5.40. Optional parameters

Parameter	Description	Values
<b>additionalTrustBundle</b>	A PEM-encoded X.509 certificate bundle that is added to the nodes' trusted certificate store. This trust bundle may also be used when a proxy has been configured.	String
<b>cgroupsV2</b>	Enables <a href="#">Linux control groups version 2</a> (cgroups v2) on specific nodes in your cluster. The OpenShift Container Platform process for enabling cgroups v2 disables all cgroup version 1 controllers and hierarchies. The OpenShift Container Platform cgroups version 2 feature is in Developer Preview and is not supported by Red Hat at this time.	<b>true</b>

Parameter	Description	Values
<b>compute</b>	The configuration for the machines that comprise the compute nodes.	Array of <b>MachinePool</b> objects.
<b>compute.architecture</b>	Determines the instruction set architecture of the machines in the pool. Currently, clusters with varied architectures are not supported. All pools must specify the same architecture. Valid values are <b>amd64</b> (the default).	String
<b>compute.hyperthreading</b>	Whether to enable or disable simultaneous multithreading, or <b>hyperthreading</b> , on compute machines. By default, simultaneous multithreading is enabled to increase the performance of your machines' cores.   <b>IMPORTANT</b>  If you disable simultaneous multithreading, ensure that your capacity planning accounts for the dramatically decreased machine performance.	<b>Enabled</b> or <b>Disabled</b>
<b>compute.name</b>	Required if you use <b>compute</b> . The name of the machine pool.	<b>worker</b>
<b>compute.platform</b>	Required if you use <b>compute</b> . Use this parameter to specify the cloud provider to host the worker machines. This parameter value must match the <b>controlPlane.platform</b> parameter value.	<b>alibabacloud, aws, azure, gcp, ibmcloud, openstack, ovirt, vsphere</b> , or <b>{}</b>
<b>compute.replicas</b>	The number of compute machines, which are also known as worker machines, to provision.	A positive integer greater than or equal to <b>2</b> . The default value is <b>3</b> .
<b>controlPlane</b>	The configuration for the machines that comprise the control plane.	Array of <b>MachinePool</b> objects.

Parameter	Description	Values
<b>controlPlane.architecture</b>	Determines the instruction set architecture of the machines in the pool. Currently, clusters with varied architectures are not supported. All pools must specify the same architecture. Valid values are <b>amd64</b> (the default).	String
<b>controlPlane.hypertreading</b>	Whether to enable or disable simultaneous multithreading, or <b>hyperthreading</b> , on control plane machines. By default, simultaneous multithreading is enabled to increase the performance of your machines' cores.   <b>IMPORTANT</b>  If you disable simultaneous multithreading, ensure that your capacity planning accounts for the dramatically decreased machine performance.	<b>Enabled</b> or <b>Disabled</b>
<b>controlPlane.name</b>	Required if you use <b>controlPlane</b> . The name of the machine pool.	<b>master</b>
<b>controlPlane.platform</b>	Required if you use <b>controlPlane</b> . Use this parameter to specify the cloud provider that hosts the control plane machines. This parameter value must match the <b>compute.platform</b> parameter value.	<b>alibabacloud, aws, azure, gcp, ibmcloud, openstack, ovirt, vsphere, or {}</b>
<b>controlPlane.replicas</b>	The number of control plane machines to provision.	The only supported value is <b>3</b> , which is the default value.

Parameter	Description	Values
<b>credentialsMode</b>	<p>The Cloud Credential Operator (CCO) mode. If no mode is specified, the CCO dynamically tries to determine the capabilities of the provided credentials, with a preference for mint mode on the platforms where multiple modes are supported.</p> <div data-bbox="485 510 595 862" style="border: 1px solid black; padding: 5px; margin-bottom: 10px;"> <p><b>NOTE</b></p> <p>Not all CCO modes are supported for all cloud providers. For more information on CCO modes, see the <i>Cloud Credential Operator</i> entry in the <i>Cluster Operators reference</i> content.</p> </div> <div data-bbox="485 907 595 1258" style="border: 1px solid black; padding: 5px;"> <p><b>NOTE</b></p> <p>If your AWS account has service control policies (SCP) enabled, you must configure the <b>credentialsMode</b> parameter to <b>Mint</b>, <b>Passthrough</b> or <b>Manual</b>.</p> </div>	<b>Mint, Passthrough, Manual</b> or an empty string ("").



Parameter	Description	Values
<b>fips</b>	<p>Enable or disable FIPS mode. The default is <b>false</b> (disabled). If FIPS mode is enabled, the Red Hat Enterprise Linux CoreOS (RHCOS) machines that OpenShift Container Platform runs on bypass the default Kubernetes cryptography suite and use the cryptography modules that are provided with RHCOS instead.</p> <div style="display: flex; align-items: flex-start;"> <div style="width: 60px; height: 100%; background: repeating-linear-gradient(45deg, transparent, transparent 2px, black 2px, black 4px); margin-right: 10px;"></div> <div> <p><b>IMPORTANT</b></p> <p>To enable FIPS mode for your cluster, you must run the installation program from a Red Hat Enterprise Linux (RHEL) computer configured to operate in FIPS mode. For more information about configuring FIPS mode on RHEL, see <a href="#">Installing the system in FIPS mode</a>. The use of FIPS validated or Modules In Process cryptographic libraries is only supported on OpenShift Container Platform deployments on the <b>x86_64</b> architecture.</p> </div> </div> <div style="display: flex; align-items: flex-start; margin-top: 10px;"> <div style="width: 60px; height: 100%; background: repeating-linear-gradient(45deg, transparent, transparent 2px, black 2px, black 4px); margin-right: 10px;"></div> <div> <p><b>NOTE</b></p> <p>If you are using Azure File storage, you cannot enable FIPS mode.</p> </div> </div>	<b>false</b> or <b>true</b>
<b>imageContentSources</b>	Sources and repositories for the release-image content.	Array of objects. Includes a <b>source</b> and, optionally, <b>mirrors</b> , as described in the following rows of this table.
<b>imageContentSources.source</b>	Required if you use <b>imageContentSources</b> . Specify the repository that users refer to, for example, in image pull specifications.	String
<b>imageContentSources.mirrors</b>	Specify one or more repositories that may also contain the same images.	Array of strings

Parameter	Description	Values
<b>publish</b>	How to publish or expose the user-facing endpoints of your cluster, such as the Kubernetes API, OpenShift routes.	<b>Internal</b> or <b>External</b> . To deploy a private cluster, which cannot be accessed from the internet, set <b>publish</b> to <b>Internal</b> . The default value is <b>External</b> .
<b>sshKey</b>	<p>The SSH key or keys to authenticate access your cluster machines.</p>  <p><b>NOTE</b></p> <p>For production OpenShift Container Platform clusters on which you want to perform installation debugging or disaster recovery, specify an SSH key that your <b>ssh-agent</b> process uses.</p>	<p>One or more keys. For example:</p> <pre>sshKey:   &lt;key1&gt;   &lt;key2&gt;   &lt;key3&gt;</pre>

#### 5.11.10.1.4. Optional AWS configuration parameters

Optional AWS configuration parameters are described in the following table:

Table 5.41. Optional AWS parameters

Parameter	Description	Values
<b>compute.platform.aws.amiID</b>	The AWS AMI used to boot compute machines for the cluster. This is required for regions that require a custom RHCOS AMI.	Any published or custom RHCOS AMI that belongs to the set AWS region. See <i>RHCOS AMIs for AWS infrastructure</i> for available AMI IDs.
<b>compute.platform.aws.iamRole</b>	A pre-existing AWS IAM role applied to the compute machine pool instance profiles. You can use these fields to match naming schemes and include predefined permissions boundaries for your IAM roles. If undefined, the installation program creates a new IAM role.	The name of a valid AWS IAM role.

Parameter	Description	Values
<b>compute.platform.aws.rootVolume.iops</b>	The Input/Output Operations Per Second (IOPS) that is reserved for the root volume.	Integer, for example <b>4000</b> .
<b>compute.platform.aws.rootVolume.size</b>	The size in GiB of the root volume.	Integer, for example <b>500</b> .
<b>compute.platform.aws.rootVolume.type</b>	The type of the root volume.	Valid <a href="#">AWS EBS volume type</a> , such as <b>io1</b> .
<b>compute.platform.aws.rootVolume.kmsKeyARN</b>	The Amazon Resource Name (key ARN) of a KMS key. This is required to encrypt OS volumes of worker nodes with a specific KMS key.	Valid <a href="#">key ID</a> or the <a href="#">key ARN</a>
<b>compute.platform.aws.type</b>	The EC2 instance type for the compute machines.	Valid AWS instance type, such as <b>m4.2xlarge</b> . See the <a href="#">Supported AWS machine types</a> table that follows.
<b>compute.platform.aws.zones</b>	The availability zones where the installation program creates machines for the compute machine pool. If you provide your own VPC, you must provide a subnet in that availability zone.	A list of valid AWS availability zones, such as <b>us-east-1c</b> , in a <a href="#">YAML sequence</a> .
<b>compute.aws.region</b>	The AWS region that the installation program creates compute resources in.	Any valid <a href="#">AWS region</a> , such as <b>us-east-1</b> .   <b>IMPORTANT</b> When running on ARM based AWS instances, ensure that you enter a region where AWS Graviton processors are available. See <a href="#">Global availability map</a> in the AWS documentation.
<b>controlPlane.platform.aws.amiID</b>	The AWS AMI used to boot control plane machines for the cluster. This is required for regions that require a custom RHCOS AMI.	Any published or custom RHCOS AMI that belongs to the set AWS region. See <i>RHCOS AMIs for AWS infrastructure</i> for available AMI IDs.

Parameter	Description	Values
<b>controlPlane.platform.aws.iamRole</b>	A pre-existing AWS IAM role applied to the control plane machine pool instance profiles. You can use these fields to match naming schemes and include predefined permissions boundaries for your IAM roles. If undefined, the installation program creates a new IAM role.	The name of a valid AWS IAM role.
<b>controlPlane.platform.aws.rootVolume.kmsKeyARN</b>	The Amazon Resource Name (key ARN) of a KMS key. This is required to encrypt OS volumes of control plane nodes with a specific KMS key.	Valid <a href="#">key ID</a> and the <a href="#">key ARN</a>
<b>controlPlane.platform.aws.type</b>	The EC2 instance type for the control plane machines.	Valid AWS instance type, such as <b>m6i.xlarge</b> . See the <b>Supported AWS machine types</b> table that follows.
<b>controlPlane.platform.aws.zones</b>	The availability zones where the installation program creates machines for the control plane machine pool.	A list of valid AWS availability zones, such as <b>us-east-1c</b> , in a <a href="#">YAML sequence</a> .
<b>controlPlane.aws.region</b>	The AWS region that the installation program creates control plane resources in.	Valid <a href="#">AWS region</a> , such as <b>us-east-1</b> .
<b>platform.aws.amiID</b>	The AWS AMI used to boot all machines for the cluster. If set, the AMI must belong to the same region as the cluster. This is required for regions that require a custom RHCOS AMI.	Any published or custom RHCOS AMI that belongs to the set AWS region. See <i>RHCOS AMIs for AWS infrastructure</i> for available AMI IDs.

Parameter	Description	Values
<b>platform.aws.hostedZone</b>	An existing Route 53 private hosted zone for the cluster. You can only use a pre-existing hosted zone when also supplying your own VPC. The hosted zone must already be associated with the user-provided VPC before installation. Also, the domain of the hosted zone must be the cluster domain or a parent of the cluster domain. If undefined, the installation program creates a new hosted zone.	String, for example <b>Z3URY6TWQ91KVV</b> .
<b>platform.aws.serviceEndpoints.name</b>	The AWS service endpoint name. Custom endpoints are only required for cases where alternative AWS endpoints, like FIPS, must be used. Custom API endpoints can be specified for EC2, S3, IAM, Elastic Load Balancing, Tagging, Route 53, and STS AWS services.	Valid <a href="#">AWS service endpoint</a> name.
<b>platform.aws.serviceEndpoints.url</b>	The AWS service endpoint URL. The URL must use the <b>https</b> protocol and the host must trust the certificate.	Valid <a href="#">AWS service endpoint</a> URL.
<b>platform.aws.userTags</b>	A map of keys and values that the installation program adds as tags to all resources that it creates.	Any valid YAML map, such as key value pairs in the <b>&lt;key&gt;: &lt;value&gt;</b> format. For more information about AWS tags, see <a href="#">Tagging Your Amazon EC2 Resources</a> in the AWS documentation.

Parameter	Description	Values
<b>platform.aws.subnets</b>	If you provide the VPC instead of allowing the installation program to create the VPC for you, specify the subnet for the cluster to use. The subnet must be part of the same <b>machineNetwork[].cidr</b> ranges that you specify. For a standard cluster, specify a public and a private subnet for each availability zone. For a private cluster, specify a private subnet for each availability zone.	Valid subnet IDs.

### 5.11.10.2. Tested instance types for AWS

The following Amazon Web Services (AWS) instance types have been tested with OpenShift Container Platform.



#### NOTE

Use the machine types included in the following charts for your AWS instances. If you use an instance type that is not listed in the chart, ensure that the instance size you use matches the minimum resource requirements that are listed in "Minimum resource requirements for cluster installation".

#### Example 5.26. Machine types based on 64-bit x86 architecture for secret regions

- **c4.\***
- **c5.\***
- **i3.\***
- **m4.\***
- **m5.\***
- **r4.\***
- **r5.\***
- **t3.\***

### 5.11.10.3. Sample customized install-config.yaml file for AWS

You can customize the installation configuration file (**install-config.yaml**) to specify more details about your OpenShift Container Platform cluster's platform or modify the values of the required parameters.



## IMPORTANT

This sample YAML file is provided for reference only. Use it as a resource to enter parameter values into the installation configuration file that you created manually.

```

apiVersion: v1
baseDomain: example.com 1
credentialsMode: Mint 2
controlPlane: 3 4
  hyperthreading: Enabled 5
  name: master
  platform:
    aws:
      zones:
      - us-iso-east-1a
      - us-iso-east-1b
      rootVolume:
        iops: 4000
        size: 500
        type: io1 6
      type: m6i.xlarge
  replicas: 3
compute: 7
- hyperthreading: Enabled 8
  name: worker
  platform:
    aws:
      rootVolume:
        iops: 2000
        size: 500
        type: io1 9
      type: c5.4xlarge
      zones:
      - us-iso-east-1a
      - us-iso-east-1b
      replicas: 3
  metadata:
    name: test-cluster 10
networking:
  clusterNetwork:
  - cidr: 10.128.0.0/14
    hostPrefix: 23
  machineNetwork:
  - cidr: 10.0.0.0/16
  networkType: OpenShiftSDN
  serviceNetwork:
  - 172.30.0.0/16
platform:
  aws:
    region: us-iso-east-1 11
  userTags:
    adminContact: jdoe
    costCenter: 7536
  subnets: 12

```

```

- subnet-1
- subnet-2
- subnet-3
amiID: ami-96c6f8f7 13 14
serviceEndpoints: 15
  - name: ec2
    url: https://vpce-id.ec2.us-west-2.vpce.amazonaws.com
hostedZone: Z3URY6TWQ91KVV 16
fips: false 17
sshKey: ssh-ed25519 AAAA... 18
publish: Internal 19
pullSecret: '{"auths": ...}' 20
additionalTrustBundle: | 21
  -----BEGIN CERTIFICATE-----
  <MY_TRUSTED_CA_CERT>
  -----END CERTIFICATE-----

```

1 10 11 13 20 Required.

- 2 Optional: Add this parameter to force the Cloud Credential Operator (CCO) to use the specified mode, instead of having the CCO dynamically try to determine the capabilities of the credentials. For details about CCO modes, see the *Cloud Credential Operator* entry in the *Red Hat Operators reference* content.
- 3 7 If you do not provide these parameters and values, the installation program provides the default value.
- 4 The **controlPlane** section is a single mapping, but the **compute** section is a sequence of mappings. To meet the requirements of the different data structures, the first line of the **compute** section must begin with a hyphen, -, and the first line of the **controlPlane** section must not. Only one control plane pool is used.
- 5 8 Whether to enable or disable simultaneous multithreading, or **hyperthreading**. By default, simultaneous multithreading is enabled to increase the performance of your machines' cores. You can disable it by setting the parameter value to **Disabled**. If you disable simultaneous multithreading in some cluster machines, you must disable it in all cluster machines.



### IMPORTANT

If you disable simultaneous multithreading, ensure that your capacity planning accounts for the dramatically decreased machine performance. Use larger instance types, such as **m4.2xlarge** or **m5.2xlarge**, for your machines if you disable simultaneous multithreading.

- 6 9 To configure faster storage for etcd, especially for larger clusters, set the storage type as **io1** and set **iops** to **2000**.
- 12 If you provide your own VPC, specify subnets for each availability zone that your cluster uses.
- 14 The ID of the AMI used to boot machines for the cluster. If set, the AMI must belong to the same region as the cluster.
- 15 The AWS service endpoints. Custom endpoints are required when installing to an unknown AWS region. The endpoint URL must use the **https** protocol and the host must trust the certificate.



- 16 The ID of your existing Route 53 private hosted zone. Providing an existing hosted zone requires that you supply your own VPC and the hosted zone is already associated with the VPC prior to
- 17 Whether to enable or disable FIPS mode. By default, FIPS mode is not enabled. If FIPS mode is enabled, the Red Hat Enterprise Linux CoreOS (RHCOS) machines that OpenShift Container Platform runs on bypass the default Kubernetes cryptography suite and use the cryptography modules that are provided with RHCOS instead.



### IMPORTANT

To enable FIPS mode for your cluster, you must run the installation program from a Red Hat Enterprise Linux (RHEL) computer configured to operate in FIPS mode. For more information about configuring FIPS mode on RHEL, see [Installing the system in FIPS mode](#). The use of FIPS validated or Modules In Process cryptographic libraries is only supported on OpenShift Container Platform deployments on the **x86\_64** architecture.

- 18 You can optionally provide the **sshKey** value that you use to access the machines in your cluster.



### NOTE

For production OpenShift Container Platform clusters on which you want to perform installation debugging or disaster recovery, specify an SSH key that your **ssh-agent** process uses.

- 19 How to publish the user-facing endpoints of your cluster. Set **publish** to **Internal** to deploy a private cluster, which cannot be accessed from the internet. The default value is **External**.
- 21 The custom CA certificate. This is required when deploying to the AWS C2S Top Secret Region because the AWS API requires a custom CA trust bundle.

#### 5.11.10.4. Configuring the cluster-wide proxy during installation

Production environments can deny direct access to the internet and instead have an HTTP or HTTPS proxy available. You can configure a new OpenShift Container Platform cluster to use a proxy by configuring the proxy settings in the **install-config.yaml** file.

#### Prerequisites

- You have an existing **install-config.yaml** file.
- You reviewed the sites that your cluster requires access to and determined whether any of them need to bypass the proxy. By default, all cluster egress traffic is proxied, including calls to hosting cloud provider APIs. You added sites to the **Proxy** object's **spec.noProxy** field to bypass the proxy if necessary.



## NOTE

The **Proxy** object **status.noProxy** field is populated with the values of the **networking.machineNetwork[].cidr**, **networking.clusterNetwork[].cidr**, and **networking.serviceNetwork[]** fields from your installation configuration.

For installations on Amazon Web Services (AWS), Google Cloud Platform (GCP), Microsoft Azure, and Red Hat OpenStack Platform (RHOSP), the **Proxy** object **status.noProxy** field is also populated with the instance metadata endpoint (**169.254.169.254**).

## Procedure

1. Edit your **install-config.yaml** file and add the proxy settings. For example:

```
apiVersion: v1
baseDomain: my.domain.com
proxy:
  httpProxy: http://<username>:<pswd>@<ip>:<port> 1
  httpsProxy: https://<username>:<pswd>@<ip>:<port> 2
  noProxy: example.com 3
  additionalTrustBundle: | 4
    -----BEGIN CERTIFICATE-----
    <MY_TRUSTED_CA_CERT>
    -----END CERTIFICATE-----
  ...
```

- 1 A proxy URL to use for creating HTTP connections outside the cluster. The URL scheme must be **http**.
- 2 A proxy URL to use for creating HTTPS connections outside the cluster.
- 3 A comma-separated list of destination domain names, IP addresses, or other network CIDRs to exclude from proxying. Preface a domain with **.** to match subdomains only. For example, **.y.com** matches **x.y.com**, but not **y.com**. Use **\*** to bypass the proxy for all destinations.
- 4 If provided, the installation program generates a config map that is named **user-ca-bundle** in the **openshift-config** namespace that contains one or more additional CA certificates that are required for proxying HTTPS connections. The Cluster Network Operator then creates a **trusted-ca-bundle** config map that merges these contents with the Red Hat Enterprise Linux CoreOS (RHCOS) trust bundle, and this config map is referenced in the **trustedCA** field of the **Proxy** object. The **additionalTrustBundle** field is required unless the proxy's identity certificate is signed by an authority from the RHCOS trust bundle.



## NOTE

The installation program does not support the proxy **readinessEndpoints** field.

**NOTE**

If the installer times out, restart and then complete the deployment by using the **wait-for** command of the installer. For example:

```
$ ./openshift-install wait-for install-complete --log-level debug
```

2. Save the file and reference it when installing OpenShift Container Platform.

The installation program creates a cluster-wide proxy that is named **cluster** that uses the proxy settings in the provided **install-config.yaml** file. If no proxy settings are provided, a **cluster Proxy** object is still created, but it will have a nil **spec**.

**NOTE**

Only the **Proxy** object named **cluster** is supported, and no additional proxies can be created.

### 5.11.11. Deploying the cluster

You can install OpenShift Container Platform on a compatible cloud platform.

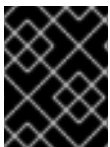
**IMPORTANT**

You can run the **create cluster** command of the installation program only once, during initial installation.

#### Prerequisites

- Configure an account with the cloud platform that hosts your cluster.
- Obtain the OpenShift Container Platform installation program and the pull secret for your cluster.

#### Procedure

1. Change to the directory that contains the installation program and initialize the cluster deployment:

```
$ ./openshift-install create cluster --dir <installation_directory> \ 1  
--log-level=info 2
```

- 1** For **<installation\_directory>**, specify the location of your customized **./install-config.yaml** file.
- 2** To view different installation details, specify **warn**, **debug**, or **error** instead of **info**.

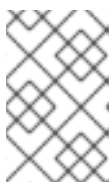
**NOTE**

If the cloud provider account that you configured on your host does not have sufficient permissions to deploy the cluster, the installation process stops, and the missing permissions are displayed.

When the cluster deployment completes, directions for accessing your cluster, including a link to its web console and credentials for the **kubeadmin** user, display in your terminal.

### Example output

```
...
INFO Install complete!
INFO To access the cluster as the system:admin user when using 'oc', run 'export
KUBECONFIG=/home/myuser/install_dir/auth/kubeconfig'
INFO Access the OpenShift web-console here: https://console-openshift-
console.apps.mycluster.example.com
INFO Login to the console with user: "kubeadmin", and password: "4vYBz-Ee6gm-ymBZj-
Wt5AL"
INFO Time elapsed: 36m22s
```



#### NOTE

The cluster access and credential information also outputs to **<installation\_directory>/openshift\_install.log** when an installation succeeds.

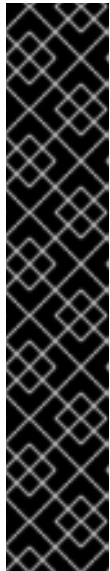

#### IMPORTANT

- The Ignition config files that the installation program generates contain certificates that expire after 24 hours, which are then renewed at that time. If the cluster is shut down before renewing the certificates and the cluster is later restarted after the 24 hours have elapsed, the cluster automatically recovers the expired certificates. The exception is that you must manually approve the pending **node-bootstrapper** certificate signing requests (CSRs) to recover kubelet certificates. See the documentation for *Recovering from expired control plane certificates* for more information.
- It is recommended that you use Ignition config files within 12 hours after they are generated because the 24-hour certificate rotates from 16 to 22 hours after the cluster is installed. By using the Ignition config files within 12 hours, you can avoid installation failure if the certificate update runs during installation.



#### IMPORTANT

You must not delete the installation program or the files that the installation program creates. Both are required to delete the cluster.

- Optional: Remove or disable the **AdministratorAccess** policy from the IAM account that you used to install the cluster.



#### NOTE

The elevated permissions provided by the **AdministratorAccess** policy are required only during installation.

## 5.11.12. Installing the OpenShift CLI by downloading the binary

You can install the OpenShift CLI (**oc**) to interact with OpenShift Container Platform from a command-line interface. You can install **oc** on Linux, Windows, or macOS.

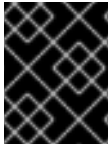

## IMPORTANT

If you installed an earlier version of **oc**, you cannot use it to complete all of the commands in OpenShift Container Platform 4.10. Download and install the new version of **oc**.

### Installing the OpenShift CLI on Linux

You can install the OpenShift CLI (**oc**) binary on Linux by using the following procedure.

#### Procedure

1. Navigate to the [OpenShift Container Platform downloads page](#) on the Red Hat Customer Portal.
2. Select the appropriate version in the **Version** drop-down menu.
3. Click **Download Now** next to the **OpenShift v4.10 Linux Client** entry and save the file.
4. Unpack the archive:

```
$ tar xvf <file>
```

5. Place the **oc** binary in a directory that is on your **PATH**.  
To check your **PATH**, execute the following command:

```
$ echo $PATH
```

After you install the OpenShift CLI, it is available using the **oc** command:

```
$ oc <command>
```

### Installing the OpenShift CLI on Windows

You can install the OpenShift CLI (**oc**) binary on Windows by using the following procedure.

#### Procedure

1. Navigate to the [OpenShift Container Platform downloads page](#) on the Red Hat Customer Portal.
2. Select the appropriate version in the **Version** drop-down menu.
3. Click **Download Now** next to the **OpenShift v4.10 Windows Client** entry and save the file.
4. Unzip the archive with a ZIP program.
5. Move the **oc** binary to a directory that is on your **PATH**.  
To check your **PATH**, open the command prompt and execute the following command:

```
C:\> path
```

After you install the OpenShift CLI, it is available using the **oc** command:

-

```
C:\> oc <command>
```

### Installing the OpenShift CLI on macOS

You can install the OpenShift CLI (**oc**) binary on macOS by using the following procedure.

#### Procedure

1. Navigate to the [OpenShift Container Platform downloads page](#) on the Red Hat Customer Portal.
2. Select the appropriate version in the **Version** drop-down menu.
3. Click **Download Now** next to the **OpenShift v4.10 MacOSX Client** entry and save the file.
4. Unpack and unzip the archive.
5. Move the **oc** binary to a directory on your PATH.  
To check your **PATH**, open a terminal and execute the following command:

```
$ echo $PATH
```

After you install the OpenShift CLI, it is available using the **oc** command:

```
$ oc <command>
```

### 5.11.13. Logging in to the cluster by using the CLI

You can log in to your cluster as a default system user by exporting the cluster **kubeconfig** file. The **kubeconfig** file contains information about the cluster that is used by the CLI to connect a client to the correct cluster and API server. The file is specific to a cluster and is created during OpenShift Container Platform installation.

#### Prerequisites

- You deployed an OpenShift Container Platform cluster.
- You installed the **oc** CLI.

#### Procedure

1. Export the **kubeadmin** credentials:

```
$ export KUBECONFIG=<installation_directory>/auth/kubeconfig 1
```

- 1** For **<installation\_directory>**, specify the path to the directory that you stored the installation files in.

2. Verify you can run **oc** commands successfully using the exported configuration:

```
$ oc whoami
```

#### Example output

```
system:admin
```

### 5.11.14. Logging in to the cluster by using the web console

The **kubeadmin** user exists by default after an OpenShift Container Platform installation. You can log in to your cluster as the **kubeadmin** user by using the OpenShift Container Platform web console.

#### Prerequisites

- You have access to the installation host.
- You completed a cluster installation and all cluster Operators are available.

#### Procedure

1. Obtain the password for the **kubeadmin** user from the **kubeadmin-password** file on the installation host:

```
$ cat <installation_directory>/auth/kubeadmin-password
```



#### NOTE

Alternatively, you can obtain the **kubeadmin** password from the **<installation\_directory>/openshift\_install.log** log file on the installation host.

2. List the OpenShift Container Platform web console route:

```
$ oc get routes -n openshift-console | grep 'console-openshift'
```



#### NOTE

Alternatively, you can obtain the OpenShift Container Platform route from the **<installation\_directory>/openshift\_install.log** log file on the installation host.

#### Example output

```
console    console-openshift-console.apps.<cluster_name>.<base_domain>    console
https reencrypt/Redirect None
```

3. Navigate to the route detailed in the output of the preceding command in a web browser and log in as the **kubeadmin** user.

#### Additional resources

- See [Accessing the web console](#) for more details about accessing and understanding the OpenShift Container Platform web console.

### 5.11.15. Telemetry access for OpenShift Container Platform

In OpenShift Container Platform 4.10, the Telemetry service, which runs by default to provide metrics about cluster health and the success of updates, requires internet access. If your cluster is connected to the internet, Telemetry runs automatically, and your cluster is registered to [OpenShift Cluster Manager](#).

After you confirm that your [OpenShift Cluster Manager](#) inventory is correct, either maintained automatically by Telemetry or manually by using OpenShift Cluster Manager, [use subscription watch](#) to track your OpenShift Container Platform subscriptions at the account or multi-cluster level.

### Additional resources

- See [About remote health monitoring](#) for more information about the Telemetry service.

### 5.11.16. Next steps

- [Validating an installation](#).
- [Customize your cluster](#).
- If necessary, you can [opt out of remote health reporting](#).
- If necessary, you can [remove cloud provider credentials](#).

## 5.12. INSTALLING A CLUSTER ON AWS CHINA

In OpenShift Container Platform version 4.10, you can install a cluster to the following Amazon Web Services (AWS) China regions:

- **cn-north-1** (Beijing)
- **cn-northwest-1** (Ningxia)

### 5.12.1. Prerequisites

- You have an Internet Content Provider (ICP) license.
- You reviewed details about the [OpenShift Container Platform installation and update](#) processes.
- You read the documentation on [selecting a cluster installation method and preparing it for users](#).
- You [configured an AWS account](#) to host the cluster.
- If you use a firewall, you [configured it to allow the sites](#) that your cluster requires access to.
- If the cloud identity and access management (IAM) APIs are not accessible in your environment, or if you do not want to store an administrator-level credential secret in the **kube-system** namespace, you can [manually create and maintain IAM credentials](#).





## IMPORTANT

If you have an AWS profile stored on your computer, it must not use a temporary session token that you generated while using a multi-factor authentication device. The cluster continues to use your current AWS credentials to create AWS resources for the entire life of the cluster, so you must use long-lived credentials. To generate appropriate keys, see [Managing Access Keys for IAM Users](#) in the AWS documentation. You can supply the keys when you run the installation program.

### 5.12.2. Installation requirements

Red Hat does not publish a Red Hat Enterprise Linux CoreOS (RHCOS) Amazon Machine Image (AMI) for the AWS China regions.

Before you can install the cluster, you must:

- Upload a custom RHCOS AMI.
- Manually create the installation configuration file (**install-config.yaml**).
- Specify the AWS region, and the accompanying custom AMI, in the installation configuration file.

You cannot use the OpenShift Container Platform installation program to create the installation configuration file. The installer does not list an AWS region without native support for an RHCOS AMI.

### 5.12.3. Internet access for OpenShift Container Platform

In OpenShift Container Platform 4.10, you require access to the internet to install your cluster.

You must have internet access to:

- Access [OpenShift Cluster Manager](#) to download the installation program and perform subscription management. If the cluster has internet access and you do not disable Telemetry, that service automatically entitles your cluster.
- Access [Quay.io](#) to obtain the packages that are required to install your cluster.
- Obtain the packages that are required to perform cluster updates.

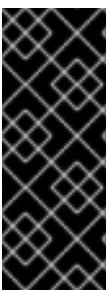

## IMPORTANT

If your cluster cannot have direct internet access, you can perform a restricted network installation on some types of infrastructure that you provision. During that process, you download the required content and use it to populate a mirror registry with the installation packages. With some installation types, the environment that you install your cluster in will not require internet access. Before you update the cluster, you update the content of the mirror registry.

### 5.12.4. Private clusters

You can deploy a private OpenShift Container Platform cluster that does not expose external endpoints. Private clusters are accessible from only an internal network and are not visible to the internet.

By default, OpenShift Container Platform is provisioned to use publicly-accessible DNS and endpoints. A private cluster sets the DNS, Ingress Controller, and API server to private when you deploy your cluster. This means that the cluster resources are only accessible from your internal network and are not visible to the internet.

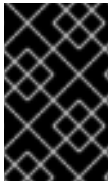

### IMPORTANT

If the cluster has any public subnets, load balancer services created by administrators might be publicly accessible. To ensure cluster security, verify that these services are explicitly annotated as private.

To deploy a private cluster, you must:

- Use existing networking that meets your requirements. Your cluster resources might be shared between other clusters on the network.
- Deploy from a machine that has access to:
  - The API services for the cloud to which you provision.
  - The hosts on the network that you provision.
  - The internet to obtain installation media.

You can use any machine that meets these access requirements and follows your company's guidelines. For example, this machine can be a bastion host on your cloud network.



### NOTE

AWS China does not support a VPN connection between the VPC and your network. For more information about the Amazon VPC service in the Beijing and Ningxia regions, see [Amazon Virtual Private Cloud](#) in the AWS China documentation.

#### 5.12.4.1. Private clusters in AWS

To create a private cluster on Amazon Web Services (AWS), you must provide an existing private VPC and subnets to host the cluster. The installation program must also be able to resolve the DNS records that the cluster requires. The installation program configures the Ingress Operator and API server for access from only the private network.

The cluster still requires access to internet to access the AWS APIs.

The following items are not required or created when you install a private cluster:

- Public subnets
- Public load balancers, which support public ingress
- A public Route 53 zone that matches the **baseDomain** for the cluster

The installation program does use the **baseDomain** that you specify to create a private Route 53 zone and the required records for the cluster. The cluster is configured so that the Operators do not create public records for the cluster and all cluster machines are placed in the private subnets that you specify.

##### 5.12.4.1.1. Limitations

The ability to add public functionality to a private cluster is limited.

- You cannot make the Kubernetes API endpoints public after installation without taking additional actions, including creating public subnets in the VPC for each availability zone in use, creating a public load balancer, and configuring the control plane security groups to allow traffic from the internet on 6443 (Kubernetes API port).
- If you use a public Service type load balancer, you must tag a public subnet in each availability zone with **kubernetes.io/cluster/<cluster-infra-id>: shared** so that AWS can use them to create public load balancers.

### 5.12.5. About using a custom VPC

In OpenShift Container Platform 4.10, you can deploy a cluster into existing subnets in an existing Amazon Virtual Private Cloud (VPC) in Amazon Web Services (AWS). By deploying OpenShift Container Platform into an existing AWS VPC, you might be able to avoid limit constraints in new accounts or more easily abide by the operational constraints that your company's guidelines set. If you cannot obtain the infrastructure creation permissions that are required to create the VPC yourself, use this installation option.

Because the installation program cannot know what other components are also in your existing subnets, it cannot choose subnet CIDRs and so forth on your behalf. You must configure networking for the subnets that you install your cluster to yourself.

#### 5.12.5.1. Requirements for using your VPC

The installation program no longer creates the following components:

- Internet gateways
- NAT gateways
- Subnets
- Route tables
- VPCs
- VPC DHCP options
- VPC endpoints



#### NOTE

The installation program requires that you use the cloud-provided DNS server. Using a custom DNS server is not supported and causes the installation to fail.

If you use a custom VPC, you must correctly configure it and its subnets for the installation program and the cluster to use. See [Amazon VPC console wizard configurations](#) and [Work with VPCs and subnets](#) in the AWS documentation for more information on creating and managing an AWS VPC.

The installation program cannot:

- Subdivide network ranges for the cluster to use.
- Set route tables for the subnets.

- Set VPC options like DHCP.

You must complete these tasks before you install the cluster. See [VPC networking components](#) and [Route tables for your VPC](#) for more information on configuring networking in an AWS VPC.

Your VPC must meet the following characteristics:

- The VPC must not use the **kubernetes.io/cluster/.\*: owned** tag. The installation program modifies your subnets to add the **kubernetes.io/cluster/.\*: shared** tag, so your subnets must have at least one free tag slot available for it. See [Tag Restrictions](#) in the AWS documentation to confirm that the installation program can add a tag to each subnet that you specify.
- You must enable the **enableDnsSupport** and **enableDnsHostnames** attributes in your VPC, so that the cluster can use the Route 53 zones that are attached to the VPC to resolve cluster's internal DNS records. See [DNS Support in Your VPC](#) in the AWS documentation. If you prefer to use your own Route 53 hosted private zone, you must associate the existing hosted zone with your VPC prior to installing a cluster. You can define your hosted zone using the **platform.aws.hostedZone** field in the **install-config.yaml** file.

If you are working in a disconnected environment, you are unable to reach the public IP addresses for EC2 and ELB endpoints. To resolve this, you must create a VPC endpoint and attach it to the subnet that the clusters are using. The endpoints should be named as follows:

- **ec2.<region>.amazonaws.com.cn**
- **elasticloadbalancing.<region>.amazonaws.com**
- **s3.<region>.amazonaws.com**

### Required VPC components

You must provide a suitable VPC and subnets that allow communication to your machines.

Component	AWS type	Description
VPC	<ul style="list-style-type: none"> <li>• <b>AWS::EC2::VPC</b></li> <li>• <b>AWS::EC2::VPCEndpoint</b></li> </ul>	You must provide a public VPC for the cluster to use. The VPC uses an endpoint that references the route tables for each subnet to improve communication with the registry that is hosted in S3.
Public subnets	<ul style="list-style-type: none"> <li>• <b>AWS::EC2::Subnet</b></li> <li>• <b>AWS::EC2::SubnetNetworkACLAssociation</b></li> </ul>	Your VPC must have public subnets for between 1 and 3 availability zones and associate them with appropriate Ingress rules.

Component	AWS type	Description												
Internet gateway	<ul style="list-style-type: none"> <li>● <b>AWS::EC2::InternetGateway</b></li> <li>● <b>AWS::EC2::VPCElasticGatewayAttachment</b></li> <li>● <b>AWS::EC2::RouteTable</b></li> <li>● <b>AWS::EC2::Route</b></li> <li>● <b>AWS::EC2::SubnetRouteTableAssociation</b></li> <li>● <b>AWS::EC2::NatGateway</b></li> <li>● <b>AWS::EC2::EIP</b></li> </ul>	<p>You must have a public internet gateway, with public routes, attached to the VPC. In the provided templates, each public subnet has a NAT gateway with an EIP address. These NAT gateways allow cluster resources, like private subnet instances, to reach the internet and are not required for some restricted network or proxy scenarios.</p>												
Network access control	<ul style="list-style-type: none"> <li>● <b>AWS::EC2::NetworkAcl</b></li> <li>● <b>AWS::EC2::NetworkAclEntry</b></li> </ul>	<p>You must allow the VPC to access the following ports:</p> <table border="1"> <thead> <tr> <th>Port</th> <th>Reason</th> </tr> </thead> <tbody> <tr> <td><b>80</b></td> <td>Inbound HTTP traffic</td> </tr> <tr> <td><b>443</b></td> <td>Inbound HTTPS traffic</td> </tr> <tr> <td><b>22</b></td> <td>Inbound SSH traffic</td> </tr> <tr> <td><b>1024 - 65535</b></td> <td>Inbound ephemeral traffic</td> </tr> <tr> <td><b>0 - 65535</b></td> <td>Outbound ephemeral traffic</td> </tr> </tbody> </table>	Port	Reason	<b>80</b>	Inbound HTTP traffic	<b>443</b>	Inbound HTTPS traffic	<b>22</b>	Inbound SSH traffic	<b>1024 - 65535</b>	Inbound ephemeral traffic	<b>0 - 65535</b>	Outbound ephemeral traffic
Port	Reason													
<b>80</b>	Inbound HTTP traffic													
<b>443</b>	Inbound HTTPS traffic													
<b>22</b>	Inbound SSH traffic													
<b>1024 - 65535</b>	Inbound ephemeral traffic													
<b>0 - 65535</b>	Outbound ephemeral traffic													
Private subnets	<ul style="list-style-type: none"> <li>● <b>AWS::EC2::Subnet</b></li> <li>● <b>AWS::EC2::RouteTable</b></li> <li>● <b>AWS::EC2::SubnetRouteTableAssociation</b></li> </ul>	<p>Your VPC can have private subnets. The provided CloudFormation templates can create private subnets for between 1 and 3 availability zones. If you use private subnets, you must provide appropriate routes and tables for them.</p>												

### 5.12.5.2. VPC validation

To ensure that the subnets that you provide are suitable, the installation program confirms the following data:

- All the subnets that you specify exist.
- You provide private subnets.
- The subnet CIDRs belong to the machine CIDR that you specified.
- You provide subnets for each availability zone. Each availability zone contains no more than one public and one private subnet. If you use a private cluster, provide only a private subnet for each availability zone. Otherwise, provide exactly one public and private subnet for each availability zone.
- You provide a public subnet for each private subnet availability zone. Machines are not provisioned in availability zones that you do not provide private subnets for.

If you destroy a cluster that uses an existing VPC, the VPC is not deleted. When you remove the OpenShift Container Platform cluster from a VPC, the **kubernetes.io/cluster/.\*: shared** tag is removed from the subnets that it used.

### 5.12.5.3. Division of permissions

Starting with OpenShift Container Platform 4.3, you do not need all of the permissions that are required for an installation program-provisioned infrastructure cluster to deploy a cluster. This change mimics the division of permissions that you might have at your company: some individuals can create different resource in your clouds than others. For example, you might be able to create application-specific items, like instances, buckets, and load balancers, but not networking-related components such as VPCs, subnets, or ingress rules.

The AWS credentials that you use when you create your cluster do not need the networking permissions that are required to make VPCs and core networking components within the VPC, such as subnets, routing tables, internet gateways, NAT, and VPN. You still need permission to make the application resources that the machines within the cluster require, such as ELBs, security groups, S3 buckets, and nodes.

### 5.12.5.4. Isolation between clusters

If you deploy OpenShift Container Platform to an existing network, the isolation of cluster services is reduced in the following ways:

- You can install multiple OpenShift Container Platform clusters in the same VPC.
- ICMP ingress is allowed from the entire network.
- TCP 22 ingress (SSH) is allowed to the entire network.
- Control plane TCP 6443 ingress (Kubernetes API) is allowed to the entire network.
- Control plane TCP 22623 ingress (MCS) is allowed to the entire network.

### 5.12.6. Generating a key pair for cluster node SSH access

During an OpenShift Container Platform installation, you can provide an SSH public key to the installation program. The key is passed to the Red Hat Enterprise Linux CoreOS (RHCOS) nodes through their Ignition config files and is used to authenticate SSH access to the nodes. The key is added to the `~/.ssh/authorized_keys` list for the **core** user on each node, which enables password-less authentication.

After the key is passed to the nodes, you can use the key pair to SSH in to the RHCOS nodes as the user **core**. To access the nodes through SSH, the private key identity must be managed by SSH for your local user.

If you want to SSH in to your cluster nodes to perform installation debugging or disaster recovery, you must provide the SSH public key during the installation process. The **./openshift-install gather** command also requires the SSH public key to be in place on the cluster nodes.

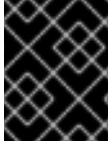

### IMPORTANT

Do not skip this procedure in production environments, where disaster recovery and debugging is required.



### NOTE

You must use a local key, not one that you configured with platform-specific approaches such as [AWS key pairs](#).

## Procedure

1. If you do not have an existing SSH key pair on your local machine to use for authentication onto your cluster nodes, create one. For example, on a computer that uses a Linux operating system, run the following command:

```
$ ssh-keygen -t ed25519 -N "" -f <path>/<file_name> 1
```

- 1 Specify the path and file name, such as `~/.ssh/id_ed25519`, of the new SSH key. If you have an existing key pair, ensure your public key is in the your `~/.ssh` directory.

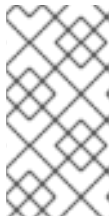

### NOTE

If you plan to install an OpenShift Container Platform cluster that uses FIPS validated or Modules In Process cryptographic libraries on the **x86\_64** architecture, do not create a key that uses the **ed25519** algorithm. Instead, create a key that uses the **rsa** or **ecdsa** algorithm.

2. View the public SSH key:

```
$ cat <path>/<file_name>.pub
```

For example, run the following to view the `~/.ssh/id_ed25519.pub` public key:

```
$ cat ~/.ssh/id_ed25519.pub
```

3. Add the SSH private key identity to the SSH agent for your local user, if it has not already been added. SSH agent management of the key is required for password-less SSH authentication onto your cluster nodes, or if you want to use the **./openshift-install gather** command.

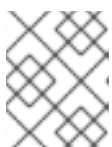

### NOTE

On some distributions, default SSH private key identities such as `~/.ssh/id_rsa` and `~/.ssh/id_dsa` are managed automatically.

- a. If the **ssh-agent** process is not already running for your local user, start it as a background task:

```
$ eval "$(ssh-agent -s)"
```

#### Example output

```
Agent pid 31874
```



#### NOTE

If your cluster is in FIPS mode, only use FIPS-compliant algorithms to generate the SSH key. The key must be either RSA or ECDSA.

4. Add your SSH private key to the **ssh-agent**:

```
$ ssh-add <path>/<file_name> 1
```

- 1** Specify the path and file name for your SSH private key, such as `~/.ssh/id_ed25519`

#### Example output

```
Identity added: /home/<you>/<path>/<file_name> (<computer_name>)
```

#### Next steps

- When you install OpenShift Container Platform, provide the SSH public key to the installation program.

### 5.12.7. Uploading a custom RHCOS AMI in AWS

If you are deploying to a custom Amazon Web Services (AWS) region, you must upload a custom Red Hat Enterprise Linux CoreOS (RHCOS) Amazon Machine Image (AMI) that belongs to that region.

#### Prerequisites

- You configured an AWS account.
- You created an Amazon S3 bucket with the required IAM [service role](#).
- You uploaded your RHCOS VMDK file to Amazon S3. The RHCOS VMDK file must be the highest version that is less than or equal to the OpenShift Container Platform version you are installing.
- You downloaded the AWS CLI and installed it on your computer. See [Install the AWS CLI Using the Bundled Installer](#).

#### Procedure

1. Export your AWS profile as an environment variable:



```
$ export AWS_PROFILE=<aws_profile> 1
```

- 1 The AWS profile name that holds your AWS credentials, like **beijingadmin**.

2. Export the region to associate with your custom AMI as an environment variable:

```
$ export AWS_DEFAULT_REGION=<aws_region> 1
```

- 1 The AWS region, like **cn-north-1**.

3. Export the version of RHCOS you uploaded to Amazon S3 as an environment variable:

```
$ export RHCOS_VERSION=<version> 1
```

- 1 The RHCOS VMDK version, like **4.10.0**.

4. Export the Amazon S3 bucket name as an environment variable:

```
$ export VMIMPORT_BUCKET_NAME=<s3_bucket_name>
```

5. Create the **containers.json** file and define your RHCOS VMDK file:

```
$ cat <<EOF > containers.json
{
  "Description": "rhcos- $\{RHCOS\_VERSION\}$ -x86_64-aws.x86_64",
  "Format": "vmdk",
  "UserBucket": {
    "S3Bucket": " $\{VMIMPORT\_BUCKET\_NAME\}$ ",
    "S3Key": "rhcos- $\{RHCOS\_VERSION\}$ -x86_64-aws.x86_64.vmdk"
  }
}
EOF
```

6. Import the RHCOS disk as an Amazon EBS snapshot:

```
$ aws ec2 import-snapshot --region  $\{AWS\_DEFAULT\_REGION\}$  \
  --description "<description>" 1 \
  --disk-container "file://<file_path>/containers.json" 2
```

- 1 The description of your RHCOS disk being imported, like **rhcos- $\{RHCOS\_VERSION\}$ -x86\_64-aws.x86\_64**.

- 2 The file path to the JSON file describing your RHCOS disk. The JSON file should contain your Amazon S3 bucket name and key.

7. Check the status of the image import:

```
$ watch -n 5 aws ec2 describe-import-snapshot-tasks --region  $\{AWS\_DEFAULT\_REGION\}$ 
```

## Example output

```
{
  "ImportSnapshotTasks": [
    {
      "Description": "rhcos-4.7.0-x86_64-aws.x86_64",
      "ImportTaskId": "import-snap-fh6i8uil",
      "SnapshotTaskDetail": {
        "Description": "rhcos-4.7.0-x86_64-aws.x86_64",
        "DiskImageSize": 819056640.0,
        "Format": "VMDK",
        "SnapshotId": "snap-06331325870076318",
        "Status": "completed",
        "UserBucket": {
          "S3Bucket": "external-images",
          "S3Key": "rhcos-4.7.0-x86_64-aws.x86_64.vmdk"
        }
      }
    }
  ]
}
```

Copy the **SnapshotId** to register the image.

8. Create a custom RHCOS AMI from the RHCOS snapshot:

```
$ aws ec2 register-image \
  --region ${AWS_DEFAULT_REGION} \
  --architecture x86_64 1 \
  --description "rhcos-${RHCOS_VERSION}-x86_64-aws.x86_64" 2 \
  --ena-support \
  --name "rhcos-${RHCOS_VERSION}-x86_64-aws.x86_64" 3 \
  --virtualization-type hvm \
  --root-device-name '/dev/xvda' \
  --block-device-mappings 'DeviceName=/dev/xvda,Ebs={DeleteOnTermination=true,SnapshotId=<snapshot_ID>}' 4
```

- 1** The RHCOS VMDK architecture type, like **x86\_64**, **s390x**, or **ppc64le**.
- 2** The **Description** from the imported snapshot.
- 3** The name of the RHCOS AMI.
- 4** The **SnapshotID** from the imported snapshot.

To learn more about these APIs, see the AWS documentation for [importing snapshots](#) and [creating EBS-backed AMIs](#).

### 5.12.8. Obtaining the installation program

Before you install OpenShift Container Platform, download the installation file on a local computer.

#### Prerequisites

- You have a computer that runs Linux or macOS, with 500 MB of local disk space

### Procedure

1. Access the [Infrastructure Provider](#) page on the OpenShift Cluster Manager site. If you have a Red Hat account, log in with your credentials. If you do not, create an account.
2. Select your infrastructure provider.
3. Navigate to the page for your installation type, download the installation program that corresponds with your host operating system and architecture, and place the file in the directory where you will store the installation configuration files.



#### IMPORTANT

The installation program creates several files on the computer that you use to install your cluster. You must keep the installation program and the files that the installation program creates after you finish installing the cluster. Both files are required to delete the cluster.

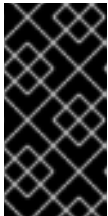

#### IMPORTANT

Deleting the files created by the installation program does not remove your cluster, even if the cluster failed during installation. To remove your cluster, complete the OpenShift Container Platform uninstallation procedures for your specific cloud provider.

4. Extract the installation program. For example, on a computer that uses a Linux operating system, run the following command:

```
$ tar -xvf openshift-install-linux.tar.gz
```

5. Download your installation [pull secret from the Red Hat OpenShift Cluster Manager](#) . This pull secret allows you to authenticate with the services that are provided by the included authorities, including Quay.io, which serves the container images for OpenShift Container Platform components.

### 5.12.9. Manually creating the installation configuration file

Installing the cluster requires that you manually generate the installation configuration file.

#### Prerequisites

- You have uploaded a custom RHCOS AMI.
- You have an SSH public key on your local machine to provide to the installation program. The key will be used for SSH authentication onto your cluster nodes for debugging and disaster recovery.
- You have obtained the OpenShift Container Platform installation program and the pull secret for your cluster.

### Procedure

1. Create an installation directory to store your required installation assets in:

```
$ mkdir <installation_directory>
```



### IMPORTANT

You must create a directory. Some installation assets, like bootstrap X.509 certificates have short expiration intervals, so you must not reuse an installation directory. If you want to reuse individual files from another cluster installation, you can copy them into your directory. However, the file names for the installation assets might change between releases. Use caution when copying installation files from an earlier OpenShift Container Platform version.

2. Customize the sample **install-config.yaml** file template that is provided and save it in the **<installation\_directory>**.



### NOTE

You must name this configuration file **install-config.yaml**.

3. Back up the **install-config.yaml** file so that you can use it to install multiple clusters.



### IMPORTANT

The **install-config.yaml** file is consumed during the next step of the installation process. You must back it up now.

#### 5.12.9.1. Installation configuration parameters

Before you deploy an OpenShift Container Platform cluster, you provide parameter values to describe your account on the cloud platform that hosts your cluster and optionally customize your cluster's platform. When you create the **install-config.yaml** installation configuration file, you provide values for the required parameters through the command line. If you customize your cluster, you can modify the **install-config.yaml** file to provide more details about the platform.



### NOTE

After installation, you cannot modify these parameters in the **install-config.yaml** file.

##### 5.12.9.1.1. Required configuration parameters

Required installation configuration parameters are described in the following table:

Table 5.42. Required parameters

Parameter	Description	Values
<b>apiVersion</b>	The API version for the <b>install-config.yaml</b> content. The current version is <b>v1</b> . The installer may also support older API versions.	String

Parameter	Description	Values
<b>baseDomain</b>	The base domain of your cloud provider. The base domain is used to create routes to your OpenShift Container Platform cluster components. The full DNS name for your cluster is a combination of the <b>baseDomain</b> and <b>metadata.name</b> parameter values that uses the <b>&lt;metadata.name&gt;.&lt;baseDomain&gt;</b> format.	A fully-qualified domain or subdomain name, such as <b>example.com</b> .
<b>metadata</b>	Kubernetes resource <b>ObjectMeta</b> , from which only the <b>name</b> parameter is consumed.	Object
<b>metadata.name</b>	The name of the cluster. DNS records for the cluster are all subdomains of <b>{{.metadata.name}}.{{.baseDomain}}</b> .	String of lowercase letters, hyphens (-), and periods (.), such as <b>dev</b> .
<b>platform</b>	The configuration for the specific platform upon which to perform the installation: <b>alibabacloud, aws, baremetal, azure, gcp, ibmcloud, openstack, ovirt, vsphere</b> , or <b>{}</b> . For additional information about <b>platform.&lt;platform&gt;</b> parameters, consult the table for your specific platform that follows.	Object
<b>pullSecret</b>	Get a <a href="#">pull secret from the Red Hat OpenShift Cluster Manager</a> to authenticate downloading container images for OpenShift Container Platform components from services such as Quay.io.	<pre>{   "auths":{     "cloud.openshift.com":{       "auth":"b3Blb=",       "email":"you@example.com"     },     "quay.io":{       "auth":"b3Blb=",       "email":"you@example.com"     }   } }</pre>

## 5.12.9.1.2. Network configuration parameters

You can customize your installation configuration based on the requirements of your existing network infrastructure. For example, you can expand the IP address block for the cluster network or provide different IP address blocks than the defaults.

Only IPv4 addresses are supported.

Table 5.43. Network parameters

Parameter	Description	Values
<b>networking</b>	The configuration for the cluster network.	Object   <b>NOTE</b> You cannot modify parameters specified by the <b>networking</b> object after installation.
<b>networking.networkType</b>	The cluster network provider Container Network Interface (CNI) plugin to install.	Either <b>OpenShiftSDN</b> or <b>OVNKubernetes</b> . <b>OpenShiftSDN</b> is a CNI provider for all-Linux networks. <b>OVNKubernetes</b> is a CNI provider for Linux networks and hybrid networks that contain both Linux and Windows servers. The default value is <b>OpenShiftSDN</b> .
<b>networking.clusterNetwork</b>	The IP address blocks for pods.  The default value is <b>10.128.0.0/14</b> with a host prefix of <b>/23</b> .  If you specify multiple IP address blocks, the blocks must not overlap.	An array of objects. For example:  <pre>networking:   clusterNetwork:     - cidr: 10.128.0.0/14       hostPrefix: 23</pre>
<b>networking.clusterNetwork.cidr</b>	Required if you use <b>networking.clusterNetwork</b> . An IP address block.  An IPv4 network.	An IP address block in Classless Inter-Domain Routing (CIDR) notation. The prefix length for an IPv4 block is between <b>0</b> and <b>32</b> .
<b>networking.clusterNetwork.hostPrefix</b>	The subnet prefix length to assign to each individual node. For example, if <b>hostPrefix</b> is set to <b>23</b> then each node is assigned a <b>/23</b> subnet out of the given <b>cidr</b> . A <b>hostPrefix</b> value of <b>23</b> provides 510 ( $2^{(32 - 23)} - 2$ ) pod IP addresses.	A subnet prefix.  The default value is <b>23</b> .

Parameter	Description	Values
<b>networking.serviceNetwork</b>	<p>The IP address block for services. The default value is <b>172.30.0.0/16</b>.</p> <p>The OpenShift SDN and OVN-Kubernetes network providers support only a single IP address block for the service network.</p>	<p>An array with an IP address block in CIDR format. For example:</p> <pre>networking:   serviceNetwork:     - 172.30.0.0/16</pre>
<b>networking.machineNetwork</b>	<p>The IP address blocks for machines.</p> <p>If you specify multiple IP address blocks, the blocks must not overlap.</p>	<p>An array of objects. For example:</p> <pre>networking:   machineNetwork:     - cidr: 10.0.0.0/16</pre>
<b>networking.machineNetwork.cidr</b>	<p>Required if you use <b>networking.machineNetwork</b>. An IP address block. The default value is <b>10.0.0.0/16</b> for all platforms other than libvirt. For libvirt, the default value is <b>192.168.126.0/24</b>.</p>	<p>An IP network block in CIDR notation.</p> <p>For example, <b>10.0.0.0/16</b>.</p> <div style="display: flex; align-items: flex-start;">  <div> <p><b>NOTE</b></p> <p>Set the <b>networking.machineNetwork</b> to match the CIDR that the preferred NIC resides in.</p> </div> </div>

### 5.12.9.1.3. Optional configuration parameters

Optional installation configuration parameters are described in the following table:



**Table 5.44. Optional parameters**

Parameter	Description	Values
<b>additionalTrustBundle</b>	<p>A PEM-encoded X.509 certificate bundle that is added to the nodes' trusted certificate store. This trust bundle may also be used when a proxy has been configured.</p>	String



Parameter	Description	Values
<b>cgroupsV2</b>	Enables <a href="#">Linux control groups version 2</a> (cgroups v2) on specific nodes in your cluster. The OpenShift Container Platform process for enabling cgroups v2 disables all cgroup version 1 controllers and hierarchies. The OpenShift Container Platform cgroups version 2 feature is in Developer Preview and is not supported by Red Hat at this time.	<b>true</b>
<b>compute</b>	The configuration for the machines that comprise the compute nodes.	Array of <b>MachinePool</b> objects.
<b>compute.architecture</b>	Determines the instruction set architecture of the machines in the pool. Currently, clusters with varied architectures are not supported. All pools must specify the same architecture. Valid values are <b>amd64</b> (the default).	String
<b>compute.hyperthreading</b>	Whether to enable or disable simultaneous multithreading, or <b>hyperthreading</b> , on compute machines. By default, simultaneous multithreading is enabled to increase the performance of your machines' cores.   <b>IMPORTANT</b>  If you disable simultaneous multithreading, ensure that your capacity planning accounts for the dramatically decreased machine performance.	<b>Enabled</b> or <b>Disabled</b>
<b>compute.name</b>	Required if you use <b>compute</b> . The name of the machine pool.	<b>worker</b>
<b>compute.platform</b>	Required if you use <b>compute</b> . Use this parameter to specify the cloud provider to host the worker machines. This parameter value must match the <b>controlPlane.platform</b> parameter value.	<b>alibabacloud, aws, azure, gcp, ibmcloud, openstack, ovirt, vsphere</b> , or <b>{}</b>



Parameter	Description	Values
<b>compute.replicas</b>	The number of compute machines, which are also known as worker machines, to provision.	A positive integer greater than or equal to <b>2</b> . The default value is <b>3</b> .
<b>controlPlane</b>	The configuration for the machines that comprise the control plane.	Array of <b>MachinePool</b> objects.
<b>controlPlane.architecture</b>	Determines the instruction set architecture of the machines in the pool. Currently, clusters with varied architectures are not supported. All pools must specify the same architecture. Valid values are <b>amd64</b> (the default).	String
<b>controlPlane.hyperthreading</b>	<p>Whether to enable or disable simultaneous multithreading, or <b>hyperthreading</b>, on control plane machines. By default, simultaneous multithreading is enabled to increase the performance of your machines' cores.</p> <div data-bbox="485 1384 592 1702" data-label="Image"> </div> <p><b>IMPORTANT</b></p> <p>If you disable simultaneous multithreading, ensure that your capacity planning accounts for the dramatically decreased machine performance.</p>	<b>Enabled</b> or <b>Disabled</b>
<b>controlPlane.name</b>	Required if you use <b>controlPlane</b> . The name of the machine pool.	<b>master</b>

Parameter	Description	Values
<b>controlPlane.platform</b>	Required if you use <b>controlPlane</b> . Use this parameter to specify the cloud provider that hosts the control plane machines. This parameter value must match the <b>compute.platform</b> parameter value.	<b>alibabacloud, aws, azure, gcp, ibmcloud, openstack, ovirt, vsphere</b> , or {}
<b>controlPlane.replicas</b>	The number of control plane machines to provision.	The only supported value is <b>3</b> , which is the default value.
<b>credentialsMode</b>	<p>The Cloud Credential Operator (CCO) mode. If no mode is specified, the CCO dynamically tries to determine the capabilities of the provided credentials, with a preference for mint mode on the platforms where multiple modes are supported.</p> <div style="display: flex; align-items: flex-start;"> <div style="flex: 1;">  </div> <div style="flex: 2;"> <p><b>NOTE</b></p> <p>Not all CCO modes are supported for all cloud providers. For more information on CCO modes, see the <i>Cloud Credential Operator</i> entry in the <i>Cluster Operators reference</i> content.</p> </div> </div> <div style="display: flex; align-items: flex-start; margin-top: 10px;"> <div style="flex: 1;">  </div> <div style="flex: 2;"> <p><b>NOTE</b></p> <p>If your AWS account has service control policies (SCP) enabled, you must configure the <b>credentialsMode</b> parameter to <b>Mint, Passthrough</b> or <b>Manual</b>.</p> </div> </div>	<b>Mint, Passthrough, Manual</b> or an empty string ("").

Parameter	Description	Values
<b>fips</b>	<p>Enable or disable FIPS mode. The default is <b>false</b> (disabled). If FIPS mode is enabled, the Red Hat Enterprise Linux CoreOS (RHCOS) machines that OpenShift Container Platform runs on bypass the default Kubernetes cryptography suite and use the cryptography modules that are provided with RHCOS instead.</p> <div style="display: flex; align-items: flex-start;"> <div style="width: 20px; height: 100px; background: repeating-linear-gradient(45deg, transparent, transparent 2px, black 2px, black 4px); margin-right: 10px;"></div> <div> <p><b>IMPORTANT</b></p> <p>To enable FIPS mode for your cluster, you must run the installation program from a Red Hat Enterprise Linux (RHEL) computer configured to operate in FIPS mode. For more information about configuring FIPS mode on RHEL, see <a href="#">Installing the system in FIPS mode</a>. The use of FIPS validated or Modules In Process cryptographic libraries is only supported on OpenShift Container Platform deployments on the <b>x86_64</b> architecture.</p> </div> </div> <div style="display: flex; align-items: flex-start; margin-top: 20px;"> <div style="width: 20px; height: 100px; background: repeating-linear-gradient(45deg, transparent, transparent 2px, black 2px, black 4px); margin-right: 10px;"></div> <div> <p><b>NOTE</b></p> <p>If you are using Azure File storage, you cannot enable FIPS mode.</p> </div> </div>	<b>false</b> or <b>true</b>
<b>imageContentSources</b>	Sources and repositories for the release-image content.	Array of objects. Includes a <b>source</b> and, optionally, <b>mirrors</b> , as described in the following rows of this table.
<b>imageContentSources.source</b>	Required if you use <b>imageContentSources</b> . Specify the repository that users refer to, for example, in image pull specifications.	String
<b>imageContentSources.mirrors</b>	Specify one or more repositories that may also contain the same images.	Array of strings

Parameter	Description	Values
<b>publish</b>	How to publish or expose the user-facing endpoints of your cluster, such as the Kubernetes API, OpenShift routes.	<p><b>Internal</b> or <b>External</b>. The default value is <b>External</b>.</p> <p>Setting this field to <b>Internal</b> is not supported on non-cloud platforms and IBM Cloud VPC.</p> <div style="display: flex; align-items: flex-start;">  <div> <p><b>IMPORTANT</b></p> <p>If the value of the field is set to <b>Internal</b>, the cluster will become non-functional. For more information, refer to <a href="#">BZ#1953035</a>.</p> </div> </div>
<b>sshKey</b>	<p>The SSH key or keys to authenticate access your cluster machines.</p> <div style="display: flex; align-items: flex-start;">  <div> <p><b>NOTE</b></p> <p>For production OpenShift Container Platform clusters on which you want to perform installation debugging or disaster recovery, specify an SSH key that your <b>ssh-agent</b> process uses.</p> </div> </div>	<p>One or more keys. For example:</p> <pre>sshKey:   &lt;key1&gt;   &lt;key2&gt;   &lt;key3&gt;</pre>

### 5.12.9.2. Sample customized install-config.yaml file for AWS

You can customize the installation configuration file (**install-config.yaml**) to specify more details about your OpenShift Container Platform cluster's platform or modify the values of the required parameters.

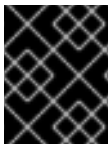

#### IMPORTANT

This sample YAML file is provided for reference only. Use it as a resource to enter parameter values into the installation configuration file that you created manually.

```
apiVersion: v1
baseDomain: example.com 1
credentialsMode: Mint 2
controlPlane: 3 4
  hyperthreading: Enabled 5
name: master
platform:
  aws:
```

```

zones:
- cn-north-1a
- cn-north-1b
rootVolume:
  iops: 4000
  size: 500
  type: io1 6
  type: m6i.xlarge
replicas: 3
compute: 7
- hyperthreading: Enabled 8
name: worker
platform:
  aws:
    rootVolume:
      iops: 2000
      size: 500
      type: io1 9
    type: c5.4xlarge
    zones:
      - cn-north-1a
    replicas: 3
metadata:
  name: test-cluster 10
networking:
  clusterNetwork:
    - cidr: 10.128.0.0/14
      hostPrefix: 23
  machineNetwork:
    - cidr: 10.0.0.0/16
  networkType: OpenShiftSDN
  serviceNetwork:
    - 172.30.0.0/16
platform:
  aws:
    region: cn-north-1 11
    userTags:
      adminContact: jdoe
      costCenter: 7536
    subnets: 12
    - subnet-1
    - subnet-2
    - subnet-3
    amiID: ami-96c6f8f7 13 14
    serviceEndpoints: 15
    - name: ec2
      url: https://vpce-id.ec2.cn-north-1.vpce.amazonaws.com.cn
    hostedZone: Z3URY6TWQ91KVV 16
  fips: false 17
  sshKey: ssh-ed25519 AAAA... 18
  publish: Internal 19
  pullSecret: '{"auths": ...}' 20

```

**1** **10** **11** **13** **20** Required.

- 2 Optional: Add this parameter to force the Cloud Credential Operator (CCO) to use the specified mode, instead of having the CCO dynamically try to determine the capabilities of the credentials.
- 3 7 If you do not provide these parameters and values, the installation program provides the default value.
- 4 The **controlPlane** section is a single mapping, but the **compute** section is a sequence of mappings. To meet the requirements of the different data structures, the first line of the **compute** section must begin with a hyphen, -, and the first line of the **controlPlane** section must not. Only one control plane pool is used.
- 5 8 Whether to enable or disable simultaneous multithreading, or **hyperthreading**. By default, simultaneous multithreading is enabled to increase the performance of your machines' cores. You can disable it by setting the parameter value to **Disabled**. If you disable simultaneous multithreading in some cluster machines, you must disable it in all cluster machines.



### IMPORTANT

If you disable simultaneous multithreading, ensure that your capacity planning accounts for the dramatically decreased machine performance. Use larger instance types, such as **m4.2xlarge** or **m5.2xlarge**, for your machines if you disable simultaneous multithreading.

- 6 9 To configure faster storage for etcd, especially for larger clusters, set the storage type as **io1** and set **iops** to **2000**.
- 12 If you provide your own VPC, specify subnets for each availability zone that your cluster uses.
- 14 The ID of the AMI used to boot machines for the cluster. If set, the AMI must belong to the same region as the cluster.
- 15 The AWS service endpoints. Custom endpoints are required when installing to an unknown AWS region. The endpoint URL must use the **https** protocol and the host must trust the certificate.
- 16 The ID of your existing Route 53 private hosted zone. Providing an existing hosted zone requires that you supply your own VPC and the hosted zone is already associated with the VPC prior to installing your cluster. If undefined, the installation program creates a new hosted zone.
- 17 Whether to enable or disable FIPS mode. By default, FIPS mode is not enabled. If FIPS mode is enabled, the Red Hat Enterprise Linux CoreOS (RHCOS) machines that OpenShift Container Platform runs on bypass the default Kubernetes cryptography suite and use the cryptography modules that are provided with RHCOS instead.

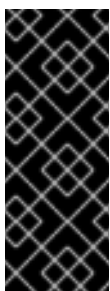

### IMPORTANT

To enable FIPS mode for your cluster, you must run the installation program from a Red Hat Enterprise Linux (RHEL) computer configured to operate in FIPS mode. For more information about configuring FIPS mode on RHEL, see [Installing the system in FIPS mode](#). The use of FIPS validated or Modules In Process cryptographic libraries is only supported on OpenShift Container Platform deployments on the **x86\_64** architecture.

- 18 You can optionally provide the **sshKey** value that you use to access the machines in your cluster.

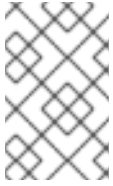
**NOTE**

For production OpenShift Container Platform clusters on which you want to perform installation debugging or disaster recovery, specify an SSH key that your **ssh-agent** process uses.

- 19** How to publish the user-facing endpoints of your cluster. Set **publish** to **Internal** to deploy a private cluster, which cannot be accessed from the internet. The default value is **External**.

### 5.12.9.3. Minimum resource requirements for cluster installation

Each cluster machine must meet the following minimum requirements:

**Table 5.45. Minimum resource requirements**

Machine	Operating System	vCPU [1]	Virtual RAM	Storage	IOPS [2]
Bootstrap	RHCOS	4	16 GB	100 GB	300
Control plane	RHCOS	4	16 GB	100 GB	300
Compute	RHCOS, RHEL 8.4, or RHEL 8.5 [3]	2	8 GB	100 GB	300

1. One vCPU is equivalent to one physical core when simultaneous multithreading (SMT), or hyperthreading, is not enabled. When enabled, use the following formula to calculate the corresponding ratio:  $(\text{threads per core} \times \text{cores}) \times \text{sockets} = \text{vCPUs}$ .
2. OpenShift Container Platform and Kubernetes are sensitive to disk performance, and faster storage is recommended, particularly for etcd on the control plane nodes which require a 10 ms p99 fsync duration. Note that on many cloud platforms, storage size and IOPS scale together, so you might need to over-allocate storage volume to obtain sufficient performance.
3. As with all user-provisioned installations, if you choose to use RHEL compute machines in your cluster, you take responsibility for all operating system life cycle management and maintenance, including performing system updates, applying patches, and completing all other required tasks. Use of RHEL 7 compute machines is deprecated and has been removed in OpenShift Container Platform 4.10 and later.

If an instance type for your platform meets the minimum requirements for cluster machines, it is supported to use in OpenShift Container Platform.

### 5.12.9.4. Tested instance types for AWS

The following Amazon Web Services (AWS) instance types have been tested with OpenShift Container Platform.

**NOTE**

Use the machine types included in the following charts for your AWS instances. If you use an instance type that is not listed in the chart, ensure that the instance size you use matches the minimum resource requirements that are listed in "Minimum resource requirements for cluster installation".

**Example 5.27. Machine types based on 64-bit x86 architecture**

- **c4.\***
- **c5.\***
- **c5a.\***
- **i3.\***
- **m4.\***
- **m5.\***
- **m5a.\***
- **m6i.\***
- **r4.\***
- **r5.\***
- **r5a.\***
- **r6i.\***
- **t3.\***
- **t3a.\***

**5.12.9.5. Tested instance types for AWS on 64-bit ARM infrastructures**

The following Amazon Web Services (AWS) ARM64 instance types have been tested with OpenShift Container Platform.

**NOTE**

Use the machine types included in the following charts for your AWS ARM instances. If you use an instance type that is not listed in the chart, ensure that the instance size you use matches the minimum resource requirements that are listed in "Minimum resource requirements for cluster installation".

**Example 5.28. Machine types based on 64-bit ARM architecture**

- **c6g.\***
- **m6g.\***



### 5.12.9.6. Configuring the cluster-wide proxy during installation

Production environments can deny direct access to the internet and instead have an HTTP or HTTPS proxy available. You can configure a new OpenShift Container Platform cluster to use a proxy by configuring the proxy settings in the **install-config.yaml** file.

#### Prerequisites

- You have an existing **install-config.yaml** file.
- You reviewed the sites that your cluster requires access to and determined whether any of them need to bypass the proxy. By default, all cluster egress traffic is proxied, including calls to hosting cloud provider APIs. You added sites to the **Proxy** object's **spec.noProxy** field to bypass the proxy if necessary.



#### NOTE

The **Proxy** object **status.noProxy** field is populated with the values of the **networking.machineNetwork[].cidr**, **networking.clusterNetwork[].cidr**, and **networking.serviceNetwork[]** fields from your installation configuration.

For installations on Amazon Web Services (AWS), Google Cloud Platform (GCP), Microsoft Azure, and Red Hat OpenStack Platform (RHOSP), the **Proxy** object **status.noProxy** field is also populated with the instance metadata endpoint (**169.254.169.254**).

- You have added the **ec2.<region>.amazonaws.com.cn**, **elasticloadbalancing.<region>.amazonaws.com**, and **s3.<region>.amazonaws.com** endpoints to your VPC endpoint. These endpoints are required to complete requests from the nodes to the AWS EC2 API. Because the proxy works on the container level, not the node level, you must route these requests to the AWS EC2 API through the AWS private network. Adding the public IP address of the EC2 API to your allowlist in your proxy server is not sufficient.

#### Procedure

1. Edit your **install-config.yaml** file and add the proxy settings. For example:

```
apiVersion: v1
baseDomain: my.domain.com
proxy:
  httpProxy: http://<username>:<pswd>@<ip>:<port> 1
  httpsProxy: https://<username>:<pswd>@<ip>:<port> 2
  noProxy: example.com 3
additionalTrustBundle: | 4
  -----BEGIN CERTIFICATE-----
  <MY_TRUSTED_CA_CERT>
  -----END CERTIFICATE-----
...
```

- 1 A proxy URL to use for creating HTTP connections outside the cluster. The URL scheme must be **http**.

- 2 A proxy URL to use for creating HTTPS connections outside the cluster.
- 3 A comma-separated list of destination domain names, IP addresses, or other network CIDRs to exclude from proxying. Preface a domain with `.` to match subdomains only. For example, `.y.com` matches `x.y.com`, but not `y.com`. Use `*` to bypass the proxy for all destinations.
- 4 If provided, the installation program generates a config map that is named **user-ca-bundle** in the **openshift-config** namespace that contains one or more additional CA certificates that are required for proxying HTTPS connections. The Cluster Network Operator then creates a **trusted-ca-bundle** config map that merges these contents with the Red Hat Enterprise Linux CoreOS (RHCOS) trust bundle, and this config map is referenced in the **trustedCA** field of the **Proxy** object. The **additionalTrustBundle** field is required unless the proxy's identity certificate is signed by an authority from the RHCOS trust bundle.

**NOTE**

The installation program does not support the proxy **readinessEndpoints** field.

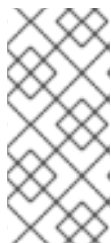
**NOTE**

If the installer times out, restart and then complete the deployment by using the **wait-for** command of the installer. For example:

```
$ ./openshift-install wait-for install-complete --log-level debug
```

2. Save the file and reference it when installing OpenShift Container Platform.

The installation program creates a cluster-wide proxy that is named **cluster** that uses the proxy settings in the provided **install-config.yaml** file. If no proxy settings are provided, a **cluster Proxy** object is still created, but it will have a nil **spec**.

**NOTE**

Only the **Proxy** object named **cluster** is supported, and no additional proxies can be created.

### 5.12.10. Deploying the cluster

You can install OpenShift Container Platform on a compatible cloud platform.

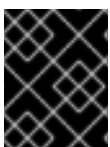
**IMPORTANT**

You can run the **create cluster** command of the installation program only once, during initial installation.

#### Prerequisites

- Configure an account with the cloud platform that hosts your cluster.
- Obtain the OpenShift Container Platform installation program and the pull secret for your cluster.

## Procedure

1. Change to the directory that contains the installation program and initialize the cluster deployment:

```
$ ./openshift-install create cluster --dir <installation_directory> \ 1
--log-level=info 2
```

- 1 For **<installation\_directory>**, specify the location of your customized **./install-config.yaml** file.
- 2 To view different installation details, specify **warn**, **debug**, or **error** instead of **info**.



### NOTE

If the cloud provider account that you configured on your host does not have sufficient permissions to deploy the cluster, the installation process stops, and the missing permissions are displayed.

When the cluster deployment completes, directions for accessing your cluster, including a link to its web console and credentials for the **kubeadmin** user, display in your terminal.

### Example output

```
...
INFO Install complete!
INFO To access the cluster as the system:admin user when using 'oc', run 'export
KUBECONFIG=/home/myuser/install_dir/auth/kubeconfig'
INFO Access the OpenShift web-console here: https://console-openshift-
console.apps.mycluster.example.com
INFO Login to the console with user: "kubeadmin", and password: "4vYBz-Ee6gm-ymBZj-
Wt5AL"
INFO Time elapsed: 36m22s
```



### NOTE

The cluster access and credential information also outputs to **<installation\_directory>/./openshift\_install.log** when an installation succeeds.

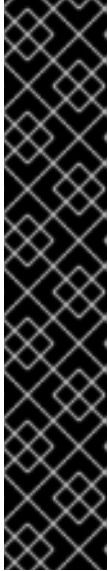
**IMPORTANT**

- The Ignition config files that the installation program generates contain certificates that expire after 24 hours, which are then renewed at that time. If the cluster is shut down before renewing the certificates and the cluster is later restarted after the 24 hours have elapsed, the cluster automatically recovers the expired certificates. The exception is that you must manually approve the pending **node-bootstrapper** certificate signing requests (CSRs) to recover kubelet certificates. See the documentation for *Recovering from expired control plane certificates* for more information.
- It is recommended that you use Ignition config files within 12 hours after they are generated because the 24-hour certificate rotates from 16 to 22 hours after the cluster is installed. By using the Ignition config files within 12 hours, you can avoid installation failure if the certificate update runs during installation.

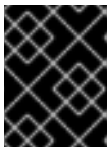
**IMPORTANT**

You must not delete the installation program or the files that the installation program creates. Both are required to delete the cluster.

2. Optional: Remove or disable the **AdministratorAccess** policy from the IAM account that you used to install the cluster.

**NOTE**

The elevated permissions provided by the **AdministratorAccess** policy are required only during installation.

### 5.12.11. Installing the OpenShift CLI by downloading the binary

You can install the OpenShift CLI (**oc**) to interact with OpenShift Container Platform from a command-line interface. You can install **oc** on Linux, Windows, or macOS.

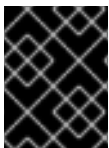
**IMPORTANT**

If you installed an earlier version of **oc**, you cannot use it to complete all of the commands in OpenShift Container Platform 4.10. Download and install the new version of **oc**.

#### Installing the OpenShift CLI on Linux

You can install the OpenShift CLI (**oc**) binary on Linux by using the following procedure.

#### Procedure

1. Navigate to the [OpenShift Container Platform downloads page](#) on the Red Hat Customer Portal.
2. Select the appropriate version in the **Version** drop-down menu.
3. Click **Download Now** next to the **OpenShift v4.10 Linux Client** entry and save the file.
4. Unpack the archive:

```
$ tar xvf <file>
```

5. Place the **oc** binary in a directory that is on your **PATH**.  
To check your **PATH**, execute the following command:

```
$ echo $PATH
```

After you install the OpenShift CLI, it is available using the **oc** command:

```
$ oc <command>
```

### Installing the OpenShift CLI on Windows

You can install the OpenShift CLI (**oc**) binary on Windows by using the following procedure.

#### Procedure

1. Navigate to the [OpenShift Container Platform downloads page](#) on the Red Hat Customer Portal.
2. Select the appropriate version in the **Version** drop-down menu.
3. Click **Download Now** next to the **OpenShift v4.10 Windows Client** entry and save the file.
4. Unzip the archive with a ZIP program.
5. Move the **oc** binary to a directory that is on your **PATH**.  
To check your **PATH**, open the command prompt and execute the following command:

```
C:\> path
```

After you install the OpenShift CLI, it is available using the **oc** command:

```
C:\> oc <command>
```

### Installing the OpenShift CLI on macOS

You can install the OpenShift CLI (**oc**) binary on macOS by using the following procedure.

#### Procedure

1. Navigate to the [OpenShift Container Platform downloads page](#) on the Red Hat Customer Portal.
2. Select the appropriate version in the **Version** drop-down menu.
3. Click **Download Now** next to the **OpenShift v4.10 MacOSX Client** entry and save the file.
4. Unpack and unzip the archive.
5. Move the **oc** binary to a directory on your **PATH**.  
To check your **PATH**, open a terminal and execute the following command:

```
$ echo $PATH
```

After you install the OpenShift CLI, it is available using the **oc** command:

```
$ oc <command>
```

### 5.12.12. Logging in to the cluster by using the CLI

You can log in to your cluster as a default system user by exporting the cluster **kubeconfig** file. The **kubeconfig** file contains information about the cluster that is used by the CLI to connect a client to the correct cluster and API server. The file is specific to a cluster and is created during OpenShift Container Platform installation.

#### Prerequisites

- You deployed an OpenShift Container Platform cluster.
- You installed the **oc** CLI.

#### Procedure

1. Export the **kubeadmin** credentials:

```
$ export KUBECONFIG=<installation_directory>/auth/kubeconfig 1
```

- 1** For **<installation\_directory>**, specify the path to the directory that you stored the installation files in.

2. Verify you can run **oc** commands successfully using the exported configuration:

```
$ oc whoami
```

#### Example output

```
system:admin
```

### 5.12.13. Logging in to the cluster by using the web console

The **kubeadmin** user exists by default after an OpenShift Container Platform installation. You can log in to your cluster as the **kubeadmin** user by using the OpenShift Container Platform web console.

#### Prerequisites

- You have access to the installation host.
- You completed a cluster installation and all cluster Operators are available.

#### Procedure

1. Obtain the password for the **kubeadmin** user from the **kubeadmin-password** file on the installation host:

```
$ cat <installation_directory>/auth/kubeadmin-password
```

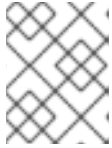
**NOTE**

Alternatively, you can obtain the **kubeadmin** password from the **<installation\_directory>/openshift\_install.log** log file on the installation host.

- List the OpenShift Container Platform web console route:

```
$ oc get routes -n openshift-console | grep 'console-openshift'
```

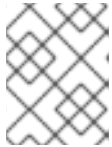
**NOTE**

Alternatively, you can obtain the OpenShift Container Platform route from the **<installation\_directory>/openshift\_install.log** log file on the installation host.

**Example output**

```
console    console-openshift-console.apps.<cluster_name>.<base_domain>    console
https reencrypt/Redirect None
```

- Navigate to the route detailed in the output of the preceding command in a web browser and log in as the **kubeadmin** user.

#### 5.12.14. Telemetry access for OpenShift Container Platform

In OpenShift Container Platform 4.10, the Telemetry service, which runs by default to provide metrics about cluster health and the success of updates, requires internet access. If your cluster is connected to the internet, Telemetry runs automatically, and your cluster is registered to [OpenShift Cluster Manager](#).

After you confirm that your [OpenShift Cluster Manager](#) inventory is correct, either maintained automatically by Telemetry or manually by using OpenShift Cluster Manager, [use subscription watch](#) to track your OpenShift Container Platform subscriptions at the account or multi-cluster level.

#### Additional resources

- See [Accessing the web console](#) for more details about accessing and understanding the OpenShift Container Platform web console.
- See [About remote health monitoring](#) for more information about the Telemetry service.

#### 5.12.15. Next steps

- [Validating an installation.](#)
- [Customize your cluster.](#)
- If necessary, you can [opt out of remote health reporting](#).
- If necessary, you can [remove cloud provider credentials](#).

## 5.13. INSTALLING A CLUSTER ON USER-PROVISIONED INFRASTRUCTURE IN AWS BY USING CLOUDFORMATION TEMPLATES

In OpenShift Container Platform version 4.10, you can install a cluster on Amazon Web Services (AWS) that uses infrastructure that you provide.

One way to create this infrastructure is to use the provided CloudFormation templates. You can modify the templates to customize your infrastructure or use the information that they contain to create AWS objects according to your company's policies.



### IMPORTANT

The steps for performing a user-provisioned infrastructure installation are provided as an example only. Installing a cluster with infrastructure you provide requires knowledge of the cloud provider and the installation process of OpenShift Container Platform. Several CloudFormation templates are provided to assist in completing these steps or to help model your own. You are also free to create the required resources through other methods; the templates are just an example.

#### 5.13.1. Prerequisites

- You reviewed details about the [OpenShift Container Platform installation and update](#) processes.
- You read the documentation on [selecting a cluster installation method and preparing it for users](#).
- You [configured an AWS account](#) to host the cluster.

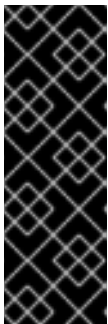

### IMPORTANT

If you have an AWS profile stored on your computer, it must not use a temporary session token that you generated while using a multi-factor authentication device. The cluster continues to use your current AWS credentials to create AWS resources for the entire life of the cluster, so you must use key-based, long-lived credentials. To generate appropriate keys, see [Managing Access Keys for IAM Users](#) in the AWS documentation. You can supply the keys when you run the installation program.

- You downloaded the AWS CLI and installed it on your computer. See [Install the AWS CLI Using the Bundled Installer \(Linux, macOS, or UNIX\)](#) in the AWS documentation.
- If you use a firewall, you [configured it to allow the sites](#) that your cluster requires access to.



### NOTE

Be sure to also review this site list if you are configuring a proxy.

- If the cloud identity and access management (IAM) APIs are not accessible in your environment, or if you do not want to store an administrator-level credential secret in the **kube-system** namespace, you can [manually create and maintain IAM credentials](#).

#### 5.13.2. Internet access for OpenShift Container Platform

In OpenShift Container Platform 4.10, you require access to the internet to install your cluster.

You must have internet access to:



- Access [OpenShift Cluster Manager](#) to download the installation program and perform subscription management. If the cluster has internet access and you do not disable Telemetry, that service automatically entitles your cluster.
- Access [Quay.io](#) to obtain the packages that are required to install your cluster.
- Obtain the packages that are required to perform cluster updates.

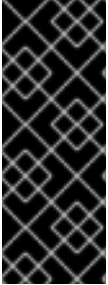

### IMPORTANT

If your cluster cannot have direct internet access, you can perform a restricted network installation on some types of infrastructure that you provision. During that process, you download the required content and use it to populate a mirror registry with the installation packages. With some installation types, the environment that you install your cluster in will not require internet access. Before you update the cluster, you update the content of the mirror registry.

## 5.13.3. Requirements for a cluster with user-provisioned infrastructure

For a cluster that contains user-provisioned infrastructure, you must deploy all of the required machines.

This section describes the requirements for deploying OpenShift Container Platform on user-provisioned infrastructure.

### 5.13.3.1. Required machines for cluster installation

The smallest OpenShift Container Platform clusters require the following hosts:

**Table 5.46. Minimum required hosts**

Hosts	Description
One temporary bootstrap machine	The cluster requires the bootstrap machine to deploy the OpenShift Container Platform cluster on the three control plane machines. You can remove the bootstrap machine after you install the cluster.
Three control plane machines	The control plane machines run the Kubernetes and OpenShift Container Platform services that form the control plane.
At least two compute machines, which are also known as worker machines.	The workloads requested by OpenShift Container Platform users run on the compute machines.

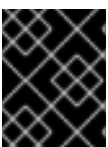

### IMPORTANT

To maintain high availability of your cluster, use separate physical hosts for these cluster machines.

The bootstrap and control plane machines must use Red Hat Enterprise Linux CoreOS (RHCOS) as the operating system. However, the compute machines can choose between Red Hat Enterprise Linux CoreOS (RHCOS), Red Hat Enterprise Linux (RHEL) 8.4, or RHEL 8.5.

Note that RHCOS is based on Red Hat Enterprise Linux (RHEL) 8 and inherits all of its hardware certifications and requirements. See [Red Hat Enterprise Linux technology capabilities and limits](#).

### 5.13.3.2. Minimum resource requirements for cluster installation

Each cluster machine must meet the following minimum requirements:

**Table 5.47. Minimum resource requirements**

Machine	Operating System	vCPU [1]	Virtual RAM	Storage	IOPS [2]
Bootstrap	RHCOS	4	16 GB	100 GB	300
Control plane	RHCOS	4	16 GB	100 GB	300
Compute	RHCOS, RHEL 8.4, or RHEL 8.5 [3]	2	8 GB	100 GB	300

1. One vCPU is equivalent to one physical core when simultaneous multithreading (SMT), or hyperthreading, is not enabled. When enabled, use the following formula to calculate the corresponding ratio:  $(\text{threads per core} \times \text{cores}) \times \text{sockets} = \text{vCPUs}$ .
2. OpenShift Container Platform and Kubernetes are sensitive to disk performance, and faster storage is recommended, particularly for etcd on the control plane nodes which require a 10 ms p99 fsync duration. Note that on many cloud platforms, storage size and IOPS scale together, so you might need to over-allocate storage volume to obtain sufficient performance.
3. As with all user-provisioned installations, if you choose to use RHEL compute machines in your cluster, you take responsibility for all operating system life cycle management and maintenance, including performing system updates, applying patches, and completing all other required tasks. Use of RHEL 7 compute machines is deprecated and has been removed in OpenShift Container Platform 4.10 and later.

If an instance type for your platform meets the minimum requirements for cluster machines, it is supported to use in OpenShift Container Platform.

### 5.13.3.3. Tested instance types for AWS

The following Amazon Web Services (AWS) instance types have been tested with OpenShift Container Platform.



#### NOTE

Use the machine types included in the following charts for your AWS instances. If you use an instance type that is not listed in the chart, ensure that the instance size you use matches the minimum resource requirements that are listed in "Minimum resource requirements for cluster installation".

#### Example 5.29. Machine types based on 64-bit x86 architecture

- c4.\*
- c5.\*
- c5a.\*
- i3.\*
- m4.\*
- m5.\*
- m5a.\*
- m6i.\*
- r4.\*
- r5.\*
- r5a.\*
- r6i.\*
- t3.\*
- t3a.\*

#### 5.13.3.4. Tested instance types for AWS on 64-bit ARM infrastructures

The following Amazon Web Services (AWS) ARM64 instance types have been tested with OpenShift Container Platform.



#### NOTE

Use the machine types included in the following charts for your AWS ARM instances. If you use an instance type that is not listed in the chart, ensure that the instance size you use matches the minimum resource requirements that are listed in "Minimum resource requirements for cluster installation".

#### Example 5.30. Machine types based on 64-bit ARM architecture

- c6g.\*
- m6g.\*

#### 5.13.3.5. Certificate signing requests management

Because your cluster has limited access to automatic machine management when you use infrastructure that you provision, you must provide a mechanism for approving cluster certificate signing requests (CSRs) after installation. The **kube-controller-manager** only approves the kubelet client CSRs. The **machine-approver** cannot guarantee the validity of a serving certificate that is requested by using

kubelet credentials because it cannot confirm that the correct machine issued the request. You must determine and implement a method of verifying the validity of the kubelet serving certificate requests and approving them.

#### 5.13.4. Required AWS infrastructure components

To install OpenShift Container Platform on user-provisioned infrastructure in Amazon Web Services (AWS), you must manually create both the machines and their supporting infrastructure.

For more information about the integration testing for different platforms, see the [OpenShift Container Platform 4.x Tested Integrations](#) page.

By using the provided CloudFormation templates, you can create stacks of AWS resources that represent the following components:

- An AWS Virtual Private Cloud (VPC)
- Networking and load balancing components
- Security groups and roles
- An OpenShift Container Platform bootstrap node
- OpenShift Container Platform control plane nodes
- An OpenShift Container Platform compute node

Alternatively, you can manually create the components or you can reuse existing infrastructure that meets the cluster requirements. Review the CloudFormation templates for more details about how the components interrelate.

##### 5.13.4.1. Other infrastructure components

- A VPC
- DNS entries
- Load balancers (classic or network) and listeners
- A public and a private Route 53 zone
- Security groups
- IAM roles
- S3 buckets

If you are working in a disconnected environment or use a proxy, you cannot reach the public IP addresses for EC2 and ELB endpoints. To reach these endpoints, you must create a VPC endpoint and attach it to the subnet that the clusters are using. Create the following endpoints:

- **ec2.<region>.amazonaws.com**
- **elasticloadbalancing.<region>.amazonaws.com**
- **s3.<region>.amazonaws.com**

## Required VPC components

You must provide a suitable VPC and subnets that allow communication to your machines.

Component	AWS type	Description										
VPC	<ul style="list-style-type: none"> <li>● <b>AWS::EC2::VPC</b></li> <li>● <b>AWS::EC2::VPCEndpoint</b></li> </ul>	You must provide a public VPC for the cluster to use. The VPC uses an endpoint that references the route tables for each subnet to improve communication with the registry that is hosted in S3.										
Public subnets	<ul style="list-style-type: none"> <li>● <b>AWS::EC2::Subnet</b></li> <li>● <b>AWS::EC2::SubnetNetworkACLAssociation</b></li> </ul>	Your VPC must have public subnets for between 1 and 3 availability zones and associate them with appropriate Ingress rules.										
Internet gateway	<ul style="list-style-type: none"> <li>● <b>AWS::EC2::InternetGateway</b></li> <li>● <b>AWS::EC2::VPCGatewayAttachment</b></li> <li>● <b>AWS::EC2::RouteTable</b></li> <li>● <b>AWS::EC2::Route</b></li> <li>● <b>AWS::EC2::SubnetRouteTableAssociation</b></li> <li>● <b>AWS::EC2::NatGateway</b></li> <li>● <b>AWS::EC2::EIP</b></li> </ul>	You must have a public internet gateway, with public routes, attached to the VPC. In the provided templates, each public subnet has a NAT gateway with an EIP address. These NAT gateways allow cluster resources, like private subnet instances, to reach the internet and are not required for some restricted network or proxy scenarios.										
Network access control	<ul style="list-style-type: none"> <li>● <b>AWS::EC2::NetworkACL</b></li> <li>● <b>AWS::EC2::NetworkACLEntry</b></li> </ul>	<p>You must allow the VPC to access the following ports:</p> <table border="1"> <thead> <tr> <th>Port</th> <th>Reason</th> </tr> </thead> <tbody> <tr> <td><b>80</b></td> <td>Inbound HTTP traffic</td> </tr> <tr> <td><b>443</b></td> <td>Inbound HTTPS traffic</td> </tr> <tr> <td><b>22</b></td> <td>Inbound SSH traffic</td> </tr> <tr> <td><b>1024 - 65535</b></td> <td>Inbound ephemeral traffic</td> </tr> </tbody> </table>	Port	Reason	<b>80</b>	Inbound HTTP traffic	<b>443</b>	Inbound HTTPS traffic	<b>22</b>	Inbound SSH traffic	<b>1024 - 65535</b>	Inbound ephemeral traffic
Port	Reason											
<b>80</b>	Inbound HTTP traffic											
<b>443</b>	Inbound HTTPS traffic											
<b>22</b>	Inbound SSH traffic											
<b>1024 - 65535</b>	Inbound ephemeral traffic											

Component	AWS type	Description	
		<b>0 - 65535</b>	Outbound ephemeral traffic
Private subnets	<ul style="list-style-type: none"> <li>● <b>AWS::EC2::Subnet</b></li> <li>● <b>AWS::EC2::RouteTable</b></li> <li>● <b>AWS::EC2::SubnetRouteTableAssociation</b></li> </ul>	Your VPC can have private subnets. The provided CloudFormation templates can create private subnets for between 1 and 3 availability zones. If you use private subnets, you must provide appropriate routes and tables for them.	

### Required DNS and load balancing components

Your DNS and load balancer configuration needs to use a public hosted zone and can use a private hosted zone similar to the one that the installation program uses if it provisions the cluster's infrastructure. You must create a DNS entry that resolves to your load balancer. An entry for **api.<cluster\_name>.<domain>** must point to the external load balancer, and an entry for **api-int.<cluster\_name>.<domain>** must point to the internal load balancer.

The cluster also requires load balancers and listeners for port 6443, which are required for the Kubernetes API and its extensions, and port 22623, which are required for the Ignition config files for new machines. The targets will be the control plane nodes. Port 6443 must be accessible to both clients external to the cluster and nodes within the cluster. Port 22623 must be accessible to nodes within the cluster.

Component	AWS type	Description
DNS	<b>AWS::Route53::HostedZone</b>	The hosted zone for your internal DNS.
etcd record sets	<b>AWS::Route53::RecordSet</b>	The registration records for etcd for your control plane machines.
Public load balancer	<b>AWS::ElasticLoadBalancingV2::LoadBalancer</b>	The load balancer for your public subnets.
External API server record	<b>AWS::Route53::RecordSetGroup</b>	Alias records for the external API server.
External listener	<b>AWS::ElasticLoadBalancingV2::Listener</b>	A listener on port 6443 for the external load balancer.

Component	AWS type	Description
External target group	<b>AWS::ElasticLoadBalancingV2::TargetGroup</b>	The target group for the external load balancer.
Private load balancer	<b>AWS::ElasticLoadBalancingV2::LoadBalancer</b>	The load balancer for your private subnets.
Internal API server record	<b>AWS::Route53::RecordSetGroup</b>	Alias records for the internal API server.
Internal listener	<b>AWS::ElasticLoadBalancingV2::Listener</b>	A listener on port 22623 for the internal load balancer.
Internal target group	<b>AWS::ElasticLoadBalancingV2::TargetGroup</b>	The target group for the internal load balancer.
Internal listener	<b>AWS::ElasticLoadBalancingV2::Listener</b>	A listener on port 6443 for the internal load balancer.
Internal target group	<b>AWS::ElasticLoadBalancingV2::TargetGroup</b>	The target group for the internal load balancer.

## Security groups

The control plane and worker machines require access to the following ports:

Group	Type	IP Protocol	Port range
<b>MasterSecurityGroup</b>	<b>AWS::EC2::SecurityGroup</b>	<b>icmp</b>	<b>0</b>
		<b>tcp</b>	<b>22</b>
		<b>tcp</b>	<b>6443</b>
		<b>tcp</b>	<b>22623</b>

Group	Type	IP Protocol	Port range
<b>WorkerSecurityGroup</b>	<b>AWS::EC2::SecurityGroup</b>	<b>icmp</b>	<b>0</b>
		<b>tcp</b>	<b>22</b>
<b>BootstrapSecurityGroup</b>	<b>AWS::EC2::SecurityGroup</b>	<b>tcp</b>	<b>22</b>
		<b>tcp</b>	<b>19531</b>

## Control plane Ingress

The control plane machines require the following Ingress groups. Each Ingress group is a **AWS::EC2::SecurityGroupIngress** resource.

Ingress group	Description	IP protocol	Port range
<b>MasterIngressEtcd</b>	etcd	<b>tcp</b>	<b>2379- 2380</b>
<b>MasterIngressVxlan</b>	Vxlan packets	<b>udp</b>	<b>4789</b>
<b>MasterIngressWorkerVxlan</b>	Vxlan packets	<b>udp</b>	<b>4789</b>
<b>MasterIngressInternal</b>	Internal cluster communication and Kubernetes proxy metrics	<b>tcp</b>	<b>9000 - 9999</b>
<b>MasterIngressWorkerInternal</b>	Internal cluster communication	<b>tcp</b>	<b>9000 - 9999</b>
<b>MasterIngressKube</b>	Kubernetes kubelet, scheduler and controller manager	<b>tcp</b>	<b>10250 - 10259</b>
<b>MasterIngressWorkerKube</b>	Kubernetes kubelet, scheduler and controller manager	<b>tcp</b>	<b>10250 - 10259</b>
<b>MasterIngressIngressServices</b>	Kubernetes Ingress services	<b>tcp</b>	<b>30000 - 32767</b>
<b>MasterIngressWorkerIngressServices</b>	Kubernetes Ingress services	<b>tcp</b>	<b>30000 - 32767</b>
<b>MasterIngressGeneve</b>	Geneve packets	<b>udp</b>	<b>6081</b>



Ingress group	Description	IP protocol	Port range
<b>MasterIngress WorkerGeneve</b>	Geneve packets	<b>udp</b>	<b>6081</b>
<b>MasterIngress IpsecIke</b>	IPsec IKE packets	<b>udp</b>	<b>500</b>
<b>MasterIngress WorkerIpsecIke</b>	IPsec IKE packets	<b>udp</b>	<b>500</b>
<b>MasterIngress IpsecNat</b>	IPsec NAT-T packets	<b>udp</b>	<b>4500</b>
<b>MasterIngress WorkerIpsecNat</b>	IPsec NAT-T packets	<b>udp</b>	<b>4500</b>
<b>MasterIngress IpsecEsp</b>	IPsec ESP packets	<b>50</b>	<b>All</b>
<b>MasterIngress WorkerIpsecEsp</b>	IPsec ESP packets	<b>50</b>	<b>All</b>
<b>MasterIngress InternalUDP</b>	Internal cluster communication	<b>udp</b>	<b>9000 - 9999</b>
<b>MasterIngress WorkerInternalUDP</b>	Internal cluster communication	<b>udp</b>	<b>9000 - 9999</b>
<b>MasterIngress IngressServicesUDP</b>	Kubernetes Ingress services	<b>udp</b>	<b>30000 - 32767</b>
<b>MasterIngress WorkerIngressServicesUDP</b>	Kubernetes Ingress services	<b>udp</b>	<b>30000 - 32767</b>

## Worker Ingress

The worker machines require the following Ingress groups. Each Ingress group is a **AWS::EC2::SecurityGroupIngress** resource.

Ingress group	Description	IP protocol	Port range
<b>WorkerIngress Vxlan</b>	Vxlan packets	<b>udp</b>	<b>4789</b>
<b>WorkerIngress WorkerVxlan</b>	Vxlan packets	<b>udp</b>	<b>4789</b>
<b>WorkerIngress Internal</b>	Internal cluster communication	<b>tcp</b>	<b>9000 - 9999</b>
<b>WorkerIngress WorkerInternal</b>	Internal cluster communication	<b>tcp</b>	<b>9000 - 9999</b>
<b>WorkerIngress Kube</b>	Kubernetes kubelet, scheduler, and controller manager	<b>tcp</b>	<b>10250</b>
<b>WorkerIngress WorkerKube</b>	Kubernetes kubelet, scheduler, and controller manager	<b>tcp</b>	<b>10250</b>
<b>WorkerIngress IngressServices</b>	Kubernetes Ingress services	<b>tcp</b>	<b>30000 - 32767</b>
<b>WorkerIngress WorkerIngressServices</b>	Kubernetes Ingress services	<b>tcp</b>	<b>30000 - 32767</b>
<b>WorkerIngress Geneve</b>	Geneve packets	<b>udp</b>	<b>6081</b>
<b>WorkerIngress MasterGeneve</b>	Geneve packets	<b>udp</b>	<b>6081</b>
<b>WorkerIngress IpsecIke</b>	IPsec IKE packets	<b>udp</b>	<b>500</b>
<b>WorkerIngress MasterIpsecIke</b>	IPsec IKE packets	<b>udp</b>	<b>500</b>
<b>WorkerIngress IpsecNat</b>	IPsec NAT-T packets	<b>udp</b>	<b>4500</b>
<b>WorkerIngress MasterIpsecNat</b>	IPsec NAT-T packets	<b>udp</b>	<b>4500</b>

Ingress group	Description	IP protocol	Port range
<b>WorkerIngress IpsecEsp</b>	IPsec ESP packets	<b>50</b>	<b>All</b>
<b>WorkerIngress MasterIpsecEsp</b>	IPsec ESP packets	<b>50</b>	<b>All</b>
<b>WorkerIngress InternalUDP</b>	Internal cluster communication	<b>udp</b>	<b>9000 - 9999</b>
<b>WorkerIngress MasterInternal UDP</b>	Internal cluster communication	<b>udp</b>	<b>9000 - 9999</b>
<b>WorkerIngress IngressServices UDP</b>	Kubernetes Ingress services	<b>udp</b>	<b>30000 - 32767</b>
<b>WorkerIngress MasterIngress ServicesUDP</b>	Kubernetes Ingress services	<b>udp</b>	<b>30000 - 32767</b>

## Roles and instance profiles

You must grant the machines permissions in AWS. The provided CloudFormation templates grant the machines **Allow** permissions for the following **AWS::IAM::Role** objects and provide a **AWS::IAM::InstanceProfile** for each set of roles. If you do not use the templates, you can grant the machines the following broad permissions or the following individual permissions.

Role	Effect	Action	Resource
Master	<b>Allow</b>	<b>ec2:*</b>	<b>*</b>
	<b>Allow</b>	<b>elasticloadbalancing :*</b>	<b>*</b>
	<b>Allow</b>	<b>iam:PassRole</b>	<b>*</b>
	<b>Allow</b>	<b>s3:GetObject</b>	<b>*</b>
Worker	<b>Allow</b>	<b>ec2:Describe*</b>	<b>*</b>
Bootstrap	<b>Allow</b>	<b>ec2:Describe*</b>	<b>*</b>

Role	Effect	Action	Resource
	<b>Allow</b>	<b>ec2:AttachVolume</b>	*
	<b>Allow</b>	<b>ec2:DetachVolume</b>	*

### 5.13.4.2. Cluster machines

You need **AWS::EC2::Instance** objects for the following machines:

- A bootstrap machine. This machine is required during installation, but you can remove it after your cluster deploys.
- Three control plane machines. The control plane machines are not governed by a machine set.
- Compute machines. You must create at least two compute machines, which are also known as worker machines, during installation. These machines are not governed by a machine set.

### 5.13.4.3. Required AWS permissions for the IAM user



#### NOTE

Your IAM user must have the permission **tag:GetResources** in the region **us-east-1** to delete the base cluster resources. As part of the AWS API requirement, the OpenShift Container Platform installation program performs various actions in this region.

When you attach the **AdministratorAccess** policy to the IAM user that you create in Amazon Web Services (AWS), you grant that user all of the required permissions. To deploy all components of an OpenShift Container Platform cluster, the IAM user requires the following permissions:

#### Example 5.31. Required EC2 permissions for installation

- **ec2:AuthorizeSecurityGroupEgress**
- **ec2:AuthorizeSecurityGroupIngress**
- **ec2:CopyImage**
- **ec2>CreateNetworkInterface**
- **ec2:AttachNetworkInterface**
- **ec2:CreateSecurityGroup**
- **ec2:CreateTags**
- **ec2:CreateVolume**
- **ec2>DeleteSecurityGroup**
- **ec2>DeleteSnapshot**
- **ec2>DeleteTags**

- **ec2:DeregisterImage**
- **ec2:DescribeAccountAttributes**
- **ec2:DescribeAddresses**
- **ec2:DescribeAvailabilityZones**
- **ec2:DescribeDhcpOptions**
- **ec2:DescribeImages**
- **ec2:DescribeInstanceAttribute**
- **ec2:DescribeInstanceCreditSpecifications**
- **ec2:DescribeInstances**
- **ec2:DescribeInstanceTypes**
- **ec2:DescribeInternetGateways**
- **ec2:DescribeKeyPairs**
- **ec2:DescribeNatGateways**
- **ec2:DescribeNetworkAcls**
- **ec2:DescribeNetworkInterfaces**
- **ec2:DescribePrefixLists**
- **ec2:DescribeRegions**
- **ec2:DescribeRouteTables**
- **ec2:DescribeSecurityGroups**
- **ec2:DescribeSubnets**
- **ec2:DescribeTags**
- **ec2:DescribeVolumes**
- **ec2:DescribeVpcAttribute**
- **ec2:DescribeVpcClassicLink**
- **ec2:DescribeVpcClassicLinkDnsSupport**
- **ec2:DescribeVpcEndpoints**
- **ec2:DescribeVpcs**
- **ec2:GetEbsDefaultKmsKeyId**
- **ec2:ModifyInstanceAttribute**

- **ec2:ModifyNetworkInterfaceAttribute**
- **ec2:RevokeSecurityGroupEgress**
- **ec2:RevokeSecurityGroupIngress**
- **ec2:RunInstances**
- **ec2:TerminateInstances**

Example 5.32. Required permissions for creating network resources during installation

- **ec2:AllocateAddress**
- **ec2:AssociateAddress**
- **ec2:AssociateDhcpOptions**
- **ec2:AssociateRouteTable**
- **ec2:AttachInternetGateway**
- **ec2:CreateDhcpOptions**
- **ec2:CreateInternetGateway**
- **ec2:CreateNatGateway**
- **ec2:CreateRoute**
- **ec2:CreateRouteTable**
- **ec2:CreateSubnet**
- **ec2:CreateVpc**
- **ec2:CreateVpcEndpoint**
- **ec2:ModifySubnetAttribute**
- **ec2:ModifyVpcAttribute**

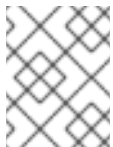

**NOTE**

If you use an existing VPC, your account does not require these permissions for creating network resources.

Example 5.33. Required Elastic Load Balancing permissions (ELB) for installation

- **elasticloadbalancing:AddTags**
- **elasticloadbalancing:ApplySecurityGroupsToLoadBalancer**
- **elasticloadbalancing:AttachLoadBalancerToSubnets**

- **elasticloadbalancing:ConfigureHealthCheck**
- **elasticloadbalancing>CreateLoadBalancer**
- **elasticloadbalancing>CreateLoadBalancerListeners**
- **elasticloadbalancing>DeleteLoadBalancer**
- **elasticloadbalancing:DeregisterInstancesFromLoadBalancer**
- **elasticloadbalancing:DescribeInstanceHealth**
- **elasticloadbalancing:DescribeLoadBalancerAttributes**
- **elasticloadbalancing:DescribeLoadBalancers**
- **elasticloadbalancing:DescribeTags**
- **elasticloadbalancing:ModifyLoadBalancerAttributes**
- **elasticloadbalancing:RegisterInstancesWithLoadBalancer**
- **elasticloadbalancing:SetLoadBalancerPoliciesOfListener**

Example 5.34. Required Elastic Load Balancing permissions (ELBv2) for installation

- **elasticloadbalancing:AddTags**
- **elasticloadbalancing>CreateListener**
- **elasticloadbalancing>CreateLoadBalancer**
- **elasticloadbalancing>CreateTargetGroup**
- **elasticloadbalancing>DeleteLoadBalancer**
- **elasticloadbalancing:DeregisterTargets**
- **elasticloadbalancing:DescribeListeners**
- **elasticloadbalancing:DescribeLoadBalancerAttributes**
- **elasticloadbalancing:DescribeLoadBalancers**
- **elasticloadbalancing:DescribeTargetGroupAttributes**
- **elasticloadbalancing:DescribeTargetHealth**
- **elasticloadbalancing:ModifyLoadBalancerAttributes**
- **elasticloadbalancing:ModifyTargetGroup**
- **elasticloadbalancing:ModifyTargetGroupAttributes**
- **elasticloadbalancing:RegisterTargets**

**Example 5.35. Required IAM permissions for installation**

- **iam:AddRoleToInstanceProfile**
- **iam:CreateInstanceProfile**
- **iam:CreateRole**
- **iam:DeleteInstanceProfile**
- **iam>DeleteRole**
- **iam>DeleteRolePolicy**
- **iam:GetInstanceProfile**
- **iam:GetRole**
- **iam:GetRolePolicy**
- **iam:GetUser**
- **iam:ListInstanceProfilesForRole**
- **iam:ListRoles**
- **iam:ListUsers**
- **iam:PassRole**
- **iam:PutRolePolicy**
- **iam:RemoveRoleFromInstanceProfile**
- **iam:SimulatePrincipalPolicy**
- **iam:TagRole**

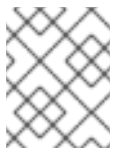
**NOTE**

If you have not created an elastic load balancer (ELB) in your AWS account, the IAM user also requires the **iam:CreateServiceLinkedRole** permission.

**Example 5.36. Required Route 53 permissions for installation**

- **route53:ChangeResourceRecordSets**
- **route53:ChangeTagsForResource**
- **route53:CreateHostedZone**
- **route53>DeleteHostedZone**
- **route53:GetChange**



- **route53:GetHostedZone**
- **route53:ListHostedZones**
- **route53:ListHostedZonesByName**
- **route53:ListResourceRecordSets**
- **route53:ListTagsForResource**
- **route53:UpdateHostedZoneComment**

Example 5.37. Required S3 permissions for installation

- **s3:CreateBucket**
- **s3>DeleteBucket**
- **s3:GetAccelerateConfiguration**
- **s3:GetBucketAcl**
- **s3:GetBucketCors**
- **s3:GetBucketLocation**
- **s3:GetBucketLogging**
- **s3:GetBucketObjectLockConfiguration**
- **s3:GetBucketReplication**
- **s3:GetBucketRequestPayment**
- **s3:GetBucketTagging**
- **s3:GetBucketVersioning**
- **s3:GetBucketWebsite**
- **s3:GetEncryptionConfiguration**
- **s3:GetLifecycleConfiguration**
- **s3:GetReplicationConfiguration**
- **s3:ListBucket**
- **s3:PutBucketAcl**
- **s3:PutBucketTagging**
- **s3:PutEncryptionConfiguration**

Example 5.38. S3 permissions that cluster Operators require

- **s3:DeleteObject**
- **s3:GetObject**
- **s3:GetObjectAcl**
- **s3:GetObjectTagging**
- **s3:GetObjectVersion**
- **s3:PutObject**
- **s3:PutObjectAcl**
- **s3:PutObjectTagging**

Example 5.39. Required permissions to delete base cluster resources

- **autoscaling:DescribeAutoScalingGroups**
- **ec2:DeleteNetworkInterface**
- **ec2:DeleteVolume**
- **elasticloadbalancing:DeleteTargetGroup**
- **elasticloadbalancing:DescribeTargetGroups**
- **iam:DeleteAccessKey**
- **iam:DeleteUser**
- **iam>ListAttachedRolePolicies**
- **iam>ListInstanceProfiles**
- **iam>ListRolePolicies**
- **iam>ListUserPolicies**
- **s3:DeleteObject**
- **s3>ListBucketVersions**
- **tag:GetResources**

Example 5.40. Required permissions to delete network resources

- **ec2:DeleteDhcpOptions**
- **ec2:DeleteInternetGateway**
- **ec2:DeleteNatGateway**
- **ec2:DeleteRoute**

- **ec2:DeleteRouteTable**
- **ec2:DeleteSubnet**
- **ec2:DeleteVpc**
- **ec2:DeleteVpcEndpoints**
- **ec2:DetachInternetGateway**
- **ec2:DisassociateRouteTable**
- **ec2:ReleaseAddress**
- **ec2:ReplaceRouteTableAssociation**

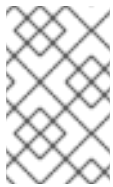

#### NOTE

If you use an existing VPC, your account does not require these permissions to delete network resources. Instead, your account only requires the **tag:UntagResources** permission to delete network resources.

#### Example 5.41. Required permissions to delete a cluster with shared instance roles

- **iam:UntagRole**

#### Example 5.42. Additional IAM and S3 permissions that are required to create manifests

- **iam:DeleteAccessKey**
- **iam:DeleteUser**
- **iam:DeleteUserPolicy**
- **iam:GetUserPolicy**
- **iam:ListAccessKeys**
- **iam:PutUserPolicy**
- **iam:TagUser**
- **s3:PutBucketPublicAccessBlock**
- **s3:GetBucketPublicAccessBlock**
- **s3:PutLifecycleConfiguration**
- **s3:HeadBucket**
- **s3:ListBucketMultipartUploads**
- **s3:AbortMultipartUpload**

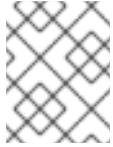
**NOTE**

If you are managing your cloud provider credentials with mint mode, the IAM user also requires the **iam:CreateAccessKey** and **iam:CreateUser** permissions.

**Example 5.43. Optional permissions for instance and quota checks for installation**

- **ec2:DescribeInstanceTypeOfferings**
- **servicequotas:ListAWSDefaultServiceQuotas**

### 5.13.5. Obtaining an AWS Marketplace image

If you are deploying an OpenShift Container Platform cluster using an AWS Marketplace image, you must first subscribe through AWS. Subscribing to the offer provides you with the AMI ID that the installation program uses to deploy worker nodes.

**Prerequisites**

- You have an AWS account to purchase the offer. This account does not have to be the same account that is used to install the cluster.

**Procedure**

1. Complete the OpenShift Container Platform subscription from the [AWS Marketplace](#).
2. Record the AMI ID for your specific region. If you use the CloudFormation template to deploy your worker nodes, you must update the **worker0.type.properties.ImageID** parameter with this value.

### 5.13.6. Obtaining the installation program

Before you install OpenShift Container Platform, download the installation file on a local computer.

**Prerequisites**

- You have a computer that runs Linux or macOS, with 500 MB of local disk space

**Procedure**

1. Access the [Infrastructure Provider](#) page on the OpenShift Cluster Manager site. If you have a Red Hat account, log in with your credentials. If you do not, create an account.
2. Select your infrastructure provider.
3. Navigate to the page for your installation type, download the installation program that corresponds with your host operating system and architecture, and place the file in the directory where you will store the installation configuration files.

**IMPORTANT**

The installation program creates several files on the computer that you use to install your cluster. You must keep the installation program and the files that the installation program creates after you finish installing the cluster. Both files are required to delete the cluster.

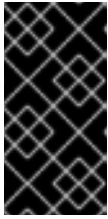
**IMPORTANT**

Deleting the files created by the installation program does not remove your cluster, even if the cluster failed during installation. To remove your cluster, complete the OpenShift Container Platform uninstallation procedures for your specific cloud provider.

4. Extract the installation program. For example, on a computer that uses a Linux operating system, run the following command:

```
$ tar -xvf openshift-install-linux.tar.gz
```

5. Download your installation [pull secret from the Red Hat OpenShift Cluster Manager](#). This pull secret allows you to authenticate with the services that are provided by the included authorities, including Quay.io, which serves the container images for OpenShift Container Platform components.

### 5.13.7. Generating a key pair for cluster node SSH access

During an OpenShift Container Platform installation, you can provide an SSH public key to the installation program. The key is passed to the Red Hat Enterprise Linux CoreOS (RHCOS) nodes through their Ignition config files and is used to authenticate SSH access to the nodes. The key is added to the `~/.ssh/authorized_keys` list for the **core** user on each node, which enables password-less authentication.

After the key is passed to the nodes, you can use the key pair to SSH in to the RHCOS nodes as the user **core**. To access the nodes through SSH, the private key identity must be managed by SSH for your local user.

If you want to SSH in to your cluster nodes to perform installation debugging or disaster recovery, you must provide the SSH public key during the installation process. The `./openshift-install gather` command also requires the SSH public key to be in place on the cluster nodes.

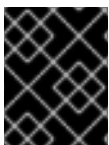
**IMPORTANT**

Do not skip this procedure in production environments, where disaster recovery and debugging is required.

**NOTE**

You must use a local key, not one that you configured with platform-specific approaches such as [AWS key pairs](#).

**Procedure**

1. If you do not have an existing SSH key pair on your local machine to use for authentication onto your cluster nodes, create one. For example, on a computer that uses a Linux operating system, run the following command:

```
$ ssh-keygen -t ed25519 -N "" -f <path>/<file_name> 1
```

- 1 Specify the path and file name, such as `~/.ssh/id_ed25519`, of the new SSH key. If you have an existing key pair, ensure your public key is in the your `~/.ssh` directory.



#### NOTE

If you plan to install an OpenShift Container Platform cluster that uses FIPS validated or Modules In Progress cryptographic libraries on the **x86\_64** architecture, do not create a key that uses the **ed25519** algorithm. Instead, create a key that uses the **rsa** or **ecdsa** algorithm.

2. View the public SSH key:

```
$ cat <path>/<file_name>.pub
```

For example, run the following to view the `~/.ssh/id_ed25519.pub` public key:

```
$ cat ~/.ssh/id_ed25519.pub
```

3. Add the SSH private key identity to the SSH agent for your local user, if it has not already been added. SSH agent management of the key is required for password-less SSH authentication onto your cluster nodes, or if you want to use the `./openshift-install gather` command.



#### NOTE

On some distributions, default SSH private key identities such as `~/.ssh/id_rsa` and `~/.ssh/id_dsa` are managed automatically.

- a. If the **ssh-agent** process is not already running for your local user, start it as a background task:

```
$ eval "$(ssh-agent -s)"
```

#### Example output

```
Agent pid 31874
```



#### NOTE

If your cluster is in FIPS mode, only use FIPS-compliant algorithms to generate the SSH key. The key must be either RSA or ECDSA.

4. Add your SSH private key to the **ssh-agent**:

```
$ ssh-add <path>/<file_name> 1
```

- 1 Specify the path and file name for your SSH private key, such as `~/.ssh/id_ed25519`

### Example output

```
Identity added: /home/<you>/<path>/<file_name> (<computer_name>)
```

### Next steps

- When you install OpenShift Container Platform, provide the SSH public key to the installation program. If you install a cluster on infrastructure that you provision, you must provide the key to the installation program.

## 5.13.8. Creating the installation files for AWS

To install OpenShift Container Platform on Amazon Web Services (AWS) using user-provisioned infrastructure, you must generate the files that the installation program needs to deploy your cluster and modify them so that the cluster creates only the machines that it will use. You generate and customize the **install-config.yaml** file, Kubernetes manifests, and Ignition config files. You also have the option to first set up a separate **var** partition during the preparation phases of installation.

### 5.13.8.1. Optional: Creating a separate **/var** partition

It is recommended that disk partitioning for OpenShift Container Platform be left to the installer. However, there are cases where you might want to create separate partitions in a part of the filesystem that you expect to grow.

OpenShift Container Platform supports the addition of a single partition to attach storage to either the **/var** partition or a subdirectory of **/var**. For example:

- **/var/lib/containers**: Holds container-related content that can grow as more images and containers are added to a system.
- **/var/lib/etcd**: Holds data that you might want to keep separate for purposes such as performance optimization of etcd storage.
- **/var**: Holds data that you might want to keep separate for purposes such as auditing.

Storing the contents of a **/var** directory separately makes it easier to grow storage for those areas as needed and reinstall OpenShift Container Platform at a later date and keep that data intact. With this method, you will not have to pull all your containers again, nor will you have to copy massive log files when you update systems.

Because **/var** must be in place before a fresh installation of Red Hat Enterprise Linux CoreOS (RHCOS), the following procedure sets up the separate **/var** partition by creating a machine config manifest that is inserted during the **openshift-install** preparation phases of an OpenShift Container Platform installation.

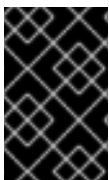

### IMPORTANT

If you follow the steps to create a separate **/var** partition in this procedure, it is not necessary to create the Kubernetes manifest and Ignition config files again as described later in this section.

## Procedure

1. Create a directory to hold the OpenShift Container Platform installation files:

```
$ mkdir $HOME/clusterconfig
```

2. Run **openshift-install** to create a set of files in the **manifest** and **openshift** subdirectories. Answer the system questions as you are prompted:

```
$ openshift-install create manifests --dir $HOME/clusterconfig
```

### Example output

```
? SSH Public Key ...
INFO Credentials loaded from the "myprofile" profile in file "/home/myuser/.aws/credentials"
INFO Consuming Install Config from target directory
INFO Manifests created in: $HOME/clusterconfig/manifests and
$HOME/clusterconfig/openshift
```

3. Optional: Confirm that the installation program created manifests in the **clusterconfig/openshift** directory:

```
$ ls $HOME/clusterconfig/openshift/
```

### Example output

```
99_kubeadmin-password-secret.yaml
99_openshift-cluster-api_master-machines-0.yaml
99_openshift-cluster-api_master-machines-1.yaml
99_openshift-cluster-api_master-machines-2.yaml
...
```

4. Create a Butane config that configures the additional partition. For example, name the file **\$HOME/clusterconfig/98-var-partition.bu**, change the disk device name to the name of the storage device on the **worker** systems, and set the storage size as appropriate. This example places the **/var** directory on a separate partition:

```
variant: openshift
version: 4.10.0
metadata:
  labels:
    machineconfiguration.openshift.io/role: worker
  name: 98-var-partition
storage:
  disks:
    - device: /dev/<device_name> ❶
      partitions:
        - label: var
          start_mib: <partition_start_offset> ❷
          size_mib: <partition_size> ❸
      filesystems:
        - device: /dev/disk/by-partlabel/var
          path: /var
```



```
format: xfs
mount_options: [defaults, prjquota] 4
with_mount_unit: true
```

- 1 The storage device name of the disk that you want to partition.
- 2 When adding a data partition to the boot disk, a minimum value of 25000 MiB (Mebibytes) is recommended. The root file system is automatically resized to fill all available space up to the specified offset. If no value is specified, or if the specified value is smaller than the recommended minimum, the resulting root file system will be too small, and future reinstalls of RHCOS might overwrite the beginning of the data partition.
- 3 The size of the data partition in mebibytes.
- 4 The **prjquota** mount option must be enabled for filesystems used for container storage.



#### NOTE

When creating a separate **/var** partition, you cannot use different instance types for worker nodes, if the different instance types do not have the same device name.

5. Create a manifest from the Butane config and save it to the **clusterconfig/openshift** directory. For example, run the following command:

```
$ butane $HOME/clusterconfig/98-var-partition.bu -o $HOME/clusterconfig/openshift/98-var-partition.yaml
```

6. Run **openshift-install** again to create Ignition configs from a set of files in the **manifest** and **openshift** subdirectories:

```
$ openshift-install create ignition-configs --dir $HOME/clusterconfig
$ ls $HOME/clusterconfig/
auth bootstrap.ign master.ign metadata.json worker.ign
```

Now you can use the Ignition config files as input to the installation procedures to install Red Hat Enterprise Linux CoreOS (RHCOS) systems.

### 5.13.8.2. Creating the installation configuration file

Generate and customize the installation configuration file that the installation program needs to deploy your cluster.

#### Prerequisites

- You obtained the OpenShift Container Platform installation program for user-provisioned infrastructure and the pull secret for your cluster.
- You checked that you are deploying your cluster to a region with an accompanying Red Hat Enterprise Linux CoreOS (RHCOS) AMI published by Red Hat. If you are deploying to a region that requires a custom AMI, such as an AWS GovCloud region, you must create the **install-config.yaml** file manually.

## Procedure

1. Create the **install-config.yaml** file.
  - a. Change to the directory that contains the installation program and run the following command:

```
$ ./openshift-install create install-config --dir <installation_directory> 1
```

- 1** For **<installation\_directory>**, specify the directory name to store the files that the installation program creates.



### IMPORTANT

Specify an empty directory. Some installation assets, like bootstrap X.509 certificates have short expiration intervals, so you must not reuse an installation directory. If you want to reuse individual files from another cluster installation, you can copy them into your directory. However, the file names for the installation assets might change between releases. Use caution when copying installation files from an earlier OpenShift Container Platform version.

- b. At the prompts, provide the configuration details for your cloud:
  - i. Optional: Select an SSH key to use to access your cluster machines.



### NOTE

For production OpenShift Container Platform clusters on which you want to perform installation debugging or disaster recovery, specify an SSH key that your **ssh-agent** process uses.

- ii. Select **aws** as the platform to target.
- iii. If you do not have an AWS profile stored on your computer, enter the AWS access key ID and secret access key for the user that you configured to run the installation program.



### NOTE

The AWS access key ID and secret access key are stored in **~/.aws/credentials** in the home directory of the current user on the installation host. You are prompted for the credentials by the installation program if the credentials for the exported profile are not present in the file. Any credentials that you provide to the installation program are stored in the file.

- iv. Select the AWS region to deploy the cluster to.
- v. Select the base domain for the Route 53 service that you configured for your cluster.
- vi. Enter a descriptive name for your cluster.
- vii. Paste the [pull secret from the Red Hat OpenShift Cluster Manager](#) .

- Optional: Back up the **install-config.yaml** file.

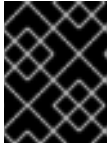

### IMPORTANT

The **install-config.yaml** file is consumed during the installation process. If you want to reuse the file, you must back it up now.

### Additional resources

- See [Configuration and credential file settings](#) in the AWS documentation for more information about AWS profile and credential configuration.

### 5.13.8.3. Configuring the cluster-wide proxy during installation

Production environments can deny direct access to the internet and instead have an HTTP or HTTPS proxy available. You can configure a new OpenShift Container Platform cluster to use a proxy by configuring the proxy settings in the **install-config.yaml** file.

### Prerequisites

- You have an existing **install-config.yaml** file.
- You reviewed the sites that your cluster requires access to and determined whether any of them need to bypass the proxy. By default, all cluster egress traffic is proxied, including calls to hosting cloud provider APIs. You added sites to the **Proxy** object's **spec.noProxy** field to bypass the proxy if necessary.



### NOTE

The **Proxy** object **status.noProxy** field is populated with the values of the **networking.machineNetwork[].cidr**, **networking.clusterNetwork[].cidr**, and **networking.serviceNetwork[]** fields from your installation configuration.

For installations on Amazon Web Services (AWS), Google Cloud Platform (GCP), Microsoft Azure, and Red Hat OpenStack Platform (RHOSP), the **Proxy** object **status.noProxy** field is also populated with the instance metadata endpoint (**169.254.169.254**).

- You have added the **ec2.<region>.amazonaws.com**, **elasticloadbalancing.<region>.amazonaws.com**, and **s3.<region>.amazonaws.com** endpoints to your VPC endpoint. These endpoints are required to complete requests from the nodes to the AWS EC2 API. Because the proxy works on the container level, not the node level, you must route these requests to the AWS EC2 API through the AWS private network. Adding the public IP address of the EC2 API to your allowlist in your proxy server is not sufficient.

### Procedure

- Edit your **install-config.yaml** file and add the proxy settings. For example:

```
apiVersion: v1
baseDomain: my.domain.com
proxy:
  httpProxy: http://<username>:<pswd>@<ip>:<port> 1
  httpsProxy: https://<username>:<pswd>@<ip>:<port> 2
```

```
noProxy: example.com 3
additionalTrustBundle: | 4
  -----BEGIN CERTIFICATE-----
  <MY_TRUSTED_CA_CERT>
  -----END CERTIFICATE-----
...

```

- 1 A proxy URL to use for creating HTTP connections outside the cluster. The URL scheme must be **http**.
- 2 A proxy URL to use for creating HTTPS connections outside the cluster.
- 3 A comma-separated list of destination domain names, IP addresses, or other network CIDRs to exclude from proxying. Preface a domain with **.** to match subdomains only. For example, **.y.com** matches **x.y.com**, but not **y.com**. Use **\*** to bypass the proxy for all destinations.
- 4 If provided, the installation program generates a config map that is named **user-ca-bundle** in the **openshift-config** namespace that contains one or more additional CA certificates that are required for proxying HTTPS connections. The Cluster Network Operator then creates a **trusted-ca-bundle** config map that merges these contents with the Red Hat Enterprise Linux CoreOS (RHCOS) trust bundle, and this config map is referenced in the **trustedCA** field of the **Proxy** object. The **additionalTrustBundle** field is required unless the proxy's identity certificate is signed by an authority from the RHCOS trust bundle.



#### NOTE

The installation program does not support the proxy **readinessEndpoints** field.



#### NOTE

If the installer times out, restart and then complete the deployment by using the **wait-for** command of the installer. For example:

```
$ ./openshift-install wait-for install-complete --log-level debug
```

2. Save the file and reference it when installing OpenShift Container Platform.

The installation program creates a cluster-wide proxy that is named **cluster** that uses the proxy settings in the provided **install-config.yaml** file. If no proxy settings are provided, a **cluster Proxy** object is still created, but it will have a nil **spec**.



#### NOTE

Only the **Proxy** object named **cluster** is supported, and no additional proxies can be created.

### 5.13.8.4. Creating the Kubernetes manifest and Ignition config files

Because you must modify some cluster definition files and manually start the cluster machines, you must generate the Kubernetes manifest and Ignition config files that the cluster needs to configure the machines.

The installation configuration file transforms into the Kubernetes manifests. The manifests wrap into the Ignition configuration files, which are later used to configure the cluster machines.

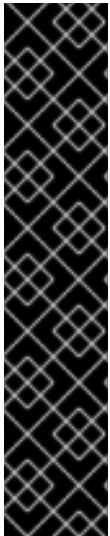

## IMPORTANT

- The Ignition config files that the OpenShift Container Platform installation program generates contain certificates that expire after 24 hours, which are then renewed at that time. If the cluster is shut down before renewing the certificates and the cluster is later restarted after the 24 hours have elapsed, the cluster automatically recovers the expired certificates. The exception is that you must manually approve the pending **node-bootstrapper** certificate signing requests (CSRs) to recover kubelet certificates. See the documentation for *Recovering from expired control plane certificates* for more information.
- It is recommended that you use Ignition config files within 12 hours after they are generated because the 24-hour certificate rotates from 16 to 22 hours after the cluster is installed. By using the Ignition config files within 12 hours, you can avoid installation failure if the certificate update runs during installation.

## Prerequisites

- You obtained the OpenShift Container Platform installation program.
- You created the **install-config.yaml** installation configuration file.

## Procedure

1. Change to the directory that contains the OpenShift Container Platform installation program and generate the Kubernetes manifests for the cluster:

```
$ ./openshift-install create manifests --dir <installation_directory> 1
```

- 1 For **<installation\_directory>**, specify the installation directory that contains the **install-config.yaml** file you created.

2. Remove the Kubernetes manifest files that define the control plane machines:

```
$ rm -f <installation_directory>/openshift/99_openshift-cluster-api_master-machines-*.yaml
```

By removing these files, you prevent the cluster from automatically generating control plane machines.

3. Remove the Kubernetes manifest files that define the worker machines:

```
$ rm -f <installation_directory>/openshift/99_openshift-cluster-api_worker-machineset-*.yaml
```

Because you create and manage the worker machines yourself, you do not need to initialize these machines.

4. Check that the **mastersSchedulable** parameter in the **<installation\_directory>/manifests/cluster-scheduler-02-config.yml** Kubernetes manifest file is set to **false**. This setting prevents pods from being scheduled on the control plane machines:

```
1. Open the <installation_directory>/manifests/cluster-scheduler-02-config.yml file
```

- a. Open the `<installation_directory>/manifests/cluster-scheduler-02-config.yml` file.
  - b. Locate the `mastersSchedulable` parameter and ensure that it is set to `false`.
  - c. Save and exit the file.
5. Optional: If you do not want [the Ingress Operator](#) to create DNS records on your behalf, remove the `privateZone` and `publicZone` sections from the `<installation_directory>/manifests/cluster-dns-02-config.yml` DNS configuration file:

```
apiVersion: config.openshift.io/v1
kind: DNS
metadata:
  creationTimestamp: null
  name: cluster
spec:
  baseDomain: example.openshift.com
  privateZone: ❶
    id: mycluster-100419-private-zone
  publicZone: ❷
    id: example.openshift.com
status: {}
```

- ❶ ❷ Remove this section completely.

If you do so, you must add ingress DNS records manually in a later step.

6. To create the Ignition configuration files, run the following command from the directory that contains the installation program:

```
$ ./openshift-install create ignition-configs --dir <installation_directory> ❶
```

- ❶ For `<installation_directory>`, specify the same installation directory.

Ignition config files are created for the bootstrap, control plane, and compute nodes in the installation directory. The `kubeadmin-password` and `kubeconfig` files are created in the `./<installation_directory>/auth` directory:

```
.
├── auth
│   ├── kubeadmin-password
│   └── kubeconfig
├── bootstrap.ign
├── master.ign
├── metadata.json
└── worker.ign
```

### 5.13.9. Extracting the infrastructure name

The Ignition config files contain a unique cluster identifier that you can use to uniquely identify your cluster in Amazon Web Services (AWS). The infrastructure name is also used to locate the appropriate AWS resources during an OpenShift Container Platform installation. The provided CloudFormation templates contain references to this infrastructure name, so you must extract it.

## Prerequisites

- You obtained the OpenShift Container Platform installation program and the pull secret for your cluster.
- You generated the Ignition config files for your cluster.
- You installed the **jq** package.

## Procedure

- To extract and view the infrastructure name from the Ignition config file metadata, run the following command:

```
$ jq -r .infraID <installation_directory>/metadata.json 1
```

- 1 For **<installation\_directory>**, specify the path to the directory that you stored the installation files in.

## Example output

```
openshift-vw9j6 1
```

- 1 The output of this command is your cluster name and a random string.

### 5.13.10. Creating a VPC in AWS

You must create a Virtual Private Cloud (VPC) in Amazon Web Services (AWS) for your OpenShift Container Platform cluster to use. You can customize the VPC to meet your requirements, including VPN and route tables.

You can use the provided CloudFormation template and a custom parameter file to create a stack of AWS resources that represent the VPC.



#### NOTE

If you do not use the provided CloudFormation template to create your AWS infrastructure, you must review the provided information and manually create the infrastructure. If your cluster does not initialize correctly, you might have to contact Red Hat support with your installation logs.

## Prerequisites

- You configured an AWS account.
- You added your AWS keys and region to your local AWS profile by running **aws configure**.
- You generated the Ignition config files for your cluster.

## Procedure

1. Create a JSON file that contains the parameter values that the template requires:

-

```
[
  {
    "ParameterKey": "VpcCidr", 1
    "ParameterValue": "10.0.0.0/16" 2
  },
  {
    "ParameterKey": "AvailabilityZoneCount", 3
    "ParameterValue": "1" 4
  },
  {
    "ParameterKey": "SubnetBits", 5
    "ParameterValue": "12" 6
  }
]
```

- 1** The CIDR block for the VPC.
  - 2** Specify a CIDR block in the format **x.x.x.x/16-24**.
  - 3** The number of availability zones to deploy the VPC in.
  - 4** Specify an integer between **1** and **3**.
  - 5** The size of each subnet in each availability zone.
  - 6** Specify an integer between **5** and **13**, where **5** is **/27** and **13** is **/19**.
2. Copy the template from the **CloudFormation template for the VPC** section of this topic and save it as a YAML file on your computer. This template describes the VPC that your cluster requires.
  3. Launch the CloudFormation template to create a stack of AWS resources that represent the VPC:

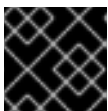

### IMPORTANT

You must enter the command on a single line.

```
$ aws cloudformation create-stack --stack-name <name> 1
  --template-body file://<template>.yaml 2
  --parameters file://<parameters>.json 3
```

- 1** **<name>** is the name for the CloudFormation stack, such as **cluster-vpc**. You need the name of this stack if you remove the cluster.
- 2** **<template>** is the relative path to and name of the CloudFormation template YAML file that you saved.
- 3** **<parameters>** is the relative path to and name of the CloudFormation parameters JSON file.

### Example output



```
arn:aws:cloudformation:us-east-1:269333783861:stack/cluster-vpc/dbedae40-2fd3-11eb-820e-12a48460849f
```

4. Confirm that the template components exist:

```
$ aws cloudformation describe-stacks --stack-name <name>
```

After the **StackStatus** displays **CREATE\_COMPLETE**, the output displays values for the following parameters. You must provide these parameter values to the other CloudFormation templates that you run to create your cluster:

<b>VpcId</b>	The ID of your VPC.
<b>PublicSubnetIds</b>	The IDs of the new public subnets.
<b>PrivateSubnetIds</b>	The IDs of the new private subnets.

### 5.13.10.1. CloudFormation template for the VPC

You can use the following CloudFormation template to deploy the VPC that you need for your OpenShift Container Platform cluster.

#### Example 5.44. CloudFormation template for the VPC

```
AWSTemplateFormatVersion: 2010-09-09
Description: Template for Best Practice VPC with 1-3 AZs

Parameters:
  VpcCidr:
    AllowedPattern: ^(([0-9]|[1-9][0-9]|1[0-9]{2}|2[0-4][0-9]|25[0-5])\.)\{3\}([0-9]|[1-9][0-9]|1[0-9]{2}|2[0-4][0-9]|25[0-5])(\/(1[6-9]|2[0-4]))$
    ConstraintDescription: CIDR block parameter must be in the form x.x.x.x/16-24.
    Default: 10.0.0.0/16
    Description: CIDR block for VPC.
    Type: String
  AvailabilityZoneCount:
    ConstraintDescription: "The number of availability zones. (Min: 1, Max: 3)"
    MinValue: 1
    MaxValue: 3
    Default: 1
    Description: "How many AZs to create VPC subnets for. (Min: 1, Max: 3)"
    Type: Number
  SubnetBits:
    ConstraintDescription: CIDR block parameter must be in the form x.x.x.x/19-27.
    MinValue: 5
    MaxValue: 13
    Default: 12
    Description: "Size of each subnet to create within the availability zones. (Min: 5 = /27, Max: 13 = /19)"
    Type: Number
```

## Metadata:

AWS::CloudFormation::Interface:

ParameterGroups:

- Label:

default: "Network Configuration"

Parameters:

- VpcCidr

- SubnetBits

- Label:

default: "Availability Zones"

Parameters:

- AvailabilityZoneCount

ParameterLabels:

AvailabilityZoneCount:

default: "Availability Zone Count"

VpcCidr:

default: "VPC CIDR"

SubnetBits:

default: "Bits Per Subnet"

## Conditions:

DoAz3: !Equals [3, !Ref AvailabilityZoneCount]

DoAz2: !Or [!Equals [2, !Ref AvailabilityZoneCount], Condition: DoAz3]

## Resources:

VPC:

Type: "AWS::EC2::VPC"

Properties:

EnableDnsSupport: "true"

EnableDnsHostnames: "true"

CidrBlock: !Ref VpcCidr

PublicSubnet:

Type: "AWS::EC2::Subnet"

Properties:

VpcId: !Ref VPC

CidrBlock: !Select [0, !Cidr [!Ref VpcCidr, 6, !Ref SubnetBits]]

AvailabilityZone: !Select

- 0

- Fn::GetAZs: !Ref "AWS::Region"

PublicSubnet2:

Type: "AWS::EC2::Subnet"

Condition: DoAz2

Properties:

VpcId: !Ref VPC

CidrBlock: !Select [1, !Cidr [!Ref VpcCidr, 6, !Ref SubnetBits]]

AvailabilityZone: !Select

- 1

- Fn::GetAZs: !Ref "AWS::Region"

PublicSubnet3:

Type: "AWS::EC2::Subnet"

Condition: DoAz3

Properties:

VpcId: !Ref VPC

CidrBlock: !Select [2, !Cidr [!Ref VpcCidr, 6, !Ref SubnetBits]]

AvailabilityZone: !Select

```

- 2
- Fn::GetAZs: !Ref "AWS::Region"
InternetGateway:
  Type: "AWS::EC2::InternetGateway"
GatewayToInternet:
  Type: "AWS::EC2::VPCEGatewayAttachment"
  Properties:
    VpId: !Ref VPC
    InternetGatewayId: !Ref InternetGateway
PublicRouteTable:
  Type: "AWS::EC2::RouteTable"
  Properties:
    VpId: !Ref VPC
PublicRoute:
  Type: "AWS::EC2::Route"
  DependsOn: GatewayToInternet
  Properties:
    RouteTableId: !Ref PublicRouteTable
    DestinationCidrBlock: 0.0.0.0/0
    GatewayId: !Ref InternetGateway
PublicSubnetRouteTableAssociation:
  Type: "AWS::EC2::SubnetRouteTableAssociation"
  Properties:
    SubnetId: !Ref PublicSubnet
    RouteTableId: !Ref PublicRouteTable
PublicSubnetRouteTableAssociation2:
  Type: "AWS::EC2::SubnetRouteTableAssociation"
  Condition: DoAz2
  Properties:
    SubnetId: !Ref PublicSubnet2
    RouteTableId: !Ref PublicRouteTable
PublicSubnetRouteTableAssociation3:
  Condition: DoAz3
  Type: "AWS::EC2::SubnetRouteTableAssociation"
  Properties:
    SubnetId: !Ref PublicSubnet3
    RouteTableId: !Ref PublicRouteTable
PrivateSubnet:
  Type: "AWS::EC2::Subnet"
  Properties:
    VpId: !Ref VPC
    CidrBlock: !Select [3, !Cidr [!Ref VpcCidr, 6, !Ref SubnetBits]]
    AvailabilityZone: !Select
- 0
- Fn::GetAZs: !Ref "AWS::Region"
PrivateRouteTable:
  Type: "AWS::EC2::RouteTable"
  Properties:
    VpId: !Ref VPC
PrivateSubnetRouteTableAssociation:
  Type: "AWS::EC2::SubnetRouteTableAssociation"
  Properties:
    SubnetId: !Ref PrivateSubnet
    RouteTableId: !Ref PrivateRouteTable
NAT:
  DependsOn:

```

```
- GatewayToInternet
Type: "AWS::EC2::NatGateway"
Properties:
  AllocationId:
    "Fn::GetAtt":
      - EIP
      - AllocationId
  SubnetId: !Ref PublicSubnet
EIP:
Type: "AWS::EC2::EIP"
Properties:
  Domain: vpc
Route:
Type: "AWS::EC2::Route"
Properties:
  RouteTableId:
    Ref: PrivateRouteTable
  DestinationCidrBlock: 0.0.0.0/0
  NatGatewayId:
    Ref: NAT
PrivateSubnet2:
Type: "AWS::EC2::Subnet"
Condition: DoAz2
Properties:
  VpcId: !Ref VPC
  CidrBlock: !Select [4, !Cidr [!Ref VpcCidr, 6, !Ref SubnetBits]]
  AvailabilityZone: !Select
    - 1
    - Fn::GetAZs: !Ref "AWS::Region"
PrivateRouteTable2:
Type: "AWS::EC2::RouteTable"
Condition: DoAz2
Properties:
  VpcId: !Ref VPC
PrivateSubnetRouteTableAssociation2:
Type: "AWS::EC2::SubnetRouteTableAssociation"
Condition: DoAz2
Properties:
  SubnetId: !Ref PrivateSubnet2
  RouteTableId: !Ref PrivateRouteTable2
NAT2:
DependsOn:
- GatewayToInternet
Type: "AWS::EC2::NatGateway"
Condition: DoAz2
Properties:
  AllocationId:
    "Fn::GetAtt":
      - EIP2
      - AllocationId
  SubnetId: !Ref PublicSubnet2
EIP2:
Type: "AWS::EC2::EIP"
Condition: DoAz2
Properties:
  Domain: vpc
```

```

Route2:
  Type: "AWS::EC2::Route"
  Condition: DoAz2
  Properties:
    RouteTableId:
      Ref: PrivateRouteTable2
    DestinationCidrBlock: 0.0.0.0/0
    NatGatewayId:
      Ref: NAT2
PrivateSubnet3:
  Type: "AWS::EC2::Subnet"
  Condition: DoAz3
  Properties:
    VpcId: !Ref VPC
    CidrBlock: !Select [5, !Cidr [!Ref VpcCidr, 6, !Ref SubnetBits]]
    AvailabilityZone: !Select
      - 2
      - Fn::GetAZs: !Ref "AWS::Region"
PrivateRouteTable3:
  Type: "AWS::EC2::RouteTable"
  Condition: DoAz3
  Properties:
    VpcId: !Ref VPC
PrivateSubnetRouteTableAssociation3:
  Type: "AWS::EC2::SubnetRouteTableAssociation"
  Condition: DoAz3
  Properties:
    SubnetId: !Ref PrivateSubnet3
    RouteTableId: !Ref PrivateRouteTable3
NAT3:
  DependsOn:
    - GatewayToInternet
  Type: "AWS::EC2::NatGateway"
  Condition: DoAz3
  Properties:
    AllocationId:
      "Fn::GetAtt":
        - EIP3
        - AllocationId
    SubnetId: !Ref PublicSubnet3
EIP3:
  Type: "AWS::EC2::EIP"
  Condition: DoAz3
  Properties:
    Domain: vpc
Route3:
  Type: "AWS::EC2::Route"
  Condition: DoAz3
  Properties:
    RouteTableId:
      Ref: PrivateRouteTable3
    DestinationCidrBlock: 0.0.0.0/0
    NatGatewayId:
      Ref: NAT3
S3Endpoint:
  Type: AWS::EC2::VPCEndpoint

```

```

Properties:
  PolicyDocument:
    Version: 2012-10-17
    Statement:
      - Effect: Allow
        Principal: '*'
        Action:
          - '*'
        Resource:
          - '*'

RouteTableIds:
- !Ref PublicRouteTable
- !Ref PrivateRouteTable
- !If [DoAz2, !Ref PrivateRouteTable2, !Ref "AWS::NoValue"]
- !If [DoAz3, !Ref PrivateRouteTable3, !Ref "AWS::NoValue"]
ServiceName: !Join
- "
- - com.amazonaws.
- !Ref 'AWS::Region'
- .s3
VpId: !Ref VPC

Outputs:
VpId:
  Description: ID of the new VPC.
  Value: !Ref VPC
PublicSubnetIds:
  Description: Subnet IDs of the public subnets.
  Value:
    !Join [
      ",",
      [!Ref PublicSubnet, !If [DoAz2, !Ref PublicSubnet2, !Ref "AWS::NoValue"], !If [DoAz3, !Ref
PublicSubnet3, !Ref "AWS::NoValue"]]
    ]
PrivateSubnetIds:
  Description: Subnet IDs of the private subnets.
  Value:
    !Join [
      ",",
      [!Ref PrivateSubnet, !If [DoAz2, !Ref PrivateSubnet2, !Ref "AWS::NoValue"], !If [DoAz3, !Ref
PrivateSubnet3, !Ref "AWS::NoValue"]]
    ]

```

### Additional resources

- You can view details about the CloudFormation stacks that you create by navigating to the [AWS CloudFormation console](#).

### 5.13.11. Creating networking and load balancing components in AWS

You must configure networking and classic or network load balancing in Amazon Web Services (AWS) that your OpenShift Container Platform cluster can use.

You can use the provided CloudFormation template and a custom parameter file to create a stack of

AWS resources. The stack represents the networking and load balancing components that your OpenShift Container Platform cluster requires. The template also creates a hosted zone and subnet tags.

You can run the template multiple times within a single Virtual Private Cloud (VPC).



## NOTE

If you do not use the provided CloudFormation template to create your AWS infrastructure, you must review the provided information and manually create the infrastructure. If your cluster does not initialize correctly, you might have to contact Red Hat support with your installation logs.

## Prerequisites

- You configured an AWS account.
- You added your AWS keys and region to your local AWS profile by running **aws configure**.
- You generated the Ignition config files for your cluster.
- You created and configured a VPC and associated subnets in AWS.

## Procedure

1. Obtain the hosted zone ID for the Route 53 base domain that you specified in the **install-config.yaml** file for your cluster. You can obtain details about your hosted zone by running the following command:

```
$ aws route53 list-hosted-zones-by-name --dns-name <route53_domain> 1
```

- 1** For the **<route53\_domain>**, specify the Route 53 base domain that you used when you generated the **install-config.yaml** file for the cluster.

## Example output

```
mycluster.example.com. False 100
HOSTEDZONES 65F8F38E-2268-B835-E15C-AB55336FCBFA
/hostedzone/Z21IXYZABCZ2A4 mycluster.example.com. 10
```

In the example output, the hosted zone ID is **Z21IXYZABCZ2A4**.

2. Create a JSON file that contains the parameter values that the template requires:

```
[
  {
    "ParameterKey": "ClusterName", 1
    "ParameterValue": "mycluster" 2
  },
  {
    "ParameterKey": "InfrastructureName", 3
    "ParameterValue": "mycluster-<random_string>" 4
  },
]
```

```

{
  "ParameterKey": "HostedZoneId", 5
  "ParameterValue": "<random_string>" 6
},
{
  "ParameterKey": "HostedZoneName", 7
  "ParameterValue": "example.com" 8
},
{
  "ParameterKey": "PublicSubnets", 9
  "ParameterValue": "subnet-<random_string>" 10
},
{
  "ParameterKey": "PrivateSubnets", 11
  "ParameterValue": "subnet-<random_string>" 12
},
{
  "ParameterKey": "VpcId", 13
  "ParameterValue": "vpc-<random_string>" 14
}
]

```

- 1 A short, representative cluster name to use for hostnames, etc.
- 2 Specify the cluster name that you used when you generated the **install-config.yaml** file for the cluster.
- 3 The name for your cluster infrastructure that is encoded in your Ignition config files for the cluster.
- 4 Specify the infrastructure name that you extracted from the Ignition config file metadata, which has the format **<cluster-name>-<random-string>**.
- 5 The Route 53 public zone ID to register the targets with.
- 6 Specify the Route 53 public zone ID, which as a format similar to **Z21IXYZABCZ2A4**. You can obtain this value from the AWS console.
- 7 The Route 53 zone to register the targets with.
- 8 Specify the Route 53 base domain that you used when you generated the **install-config.yaml** file for the cluster. Do not include the trailing period (.) that is displayed in the AWS console.
- 9 The public subnets that you created for your VPC.
- 10 Specify the **PublicSubnetIds** value from the output of the CloudFormation template for the VPC.
- 11 The private subnets that you created for your VPC.
- 12 Specify the **PrivateSubnetIds** value from the output of the CloudFormation template for the VPC.
- 13 The VPC that you created for the cluster.



- 14 Specify the **VpcId** value from the output of the CloudFormation template for the VPC.
3. Copy the template from the **CloudFormation template for the network and load balancers** section of this topic and save it as a YAML file on your computer. This template describes the networking and load balancing objects that your cluster requires.

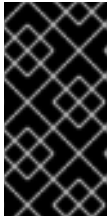

### IMPORTANT

If you are deploying your cluster to an AWS government or secret region, you must update the **InternalApiServerRecord** in the CloudFormation template to use **CNAME** records. Records of type **ALIAS** are not supported for AWS government regions.

4. Launch the CloudFormation template to create a stack of AWS resources that provide the networking and load balancing components:

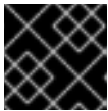

### IMPORTANT

You must enter the command on a single line.

```
$ aws cloudformation create-stack --stack-name <name> 1
  --template-body file://<template>.yaml 2
  --parameters file://<parameters>.json 3
  --capabilities CAPABILITY_NAMED_IAM 4
```

- 1 **<name>** is the name for the CloudFormation stack, such as **cluster-dns**. You need the name of this stack if you remove the cluster.
- 2 **<template>** is the relative path to and name of the CloudFormation template YAML file that you saved.
- 3 **<parameters>** is the relative path to and name of the CloudFormation parameters JSON file.
- 4 You must explicitly declare the **CAPABILITY\_NAMED\_IAM** capability because the provided template creates some **AWS::IAM::Role** resources.

### Example output

```
arn:aws:cloudformation:us-east-1:269333783861:stack/cluster-dns/cd3e5de0-2fd4-11eb-5cf0-12be5c33a183
```

5. Confirm that the template components exist:

```
$ aws cloudformation describe-stacks --stack-name <name>
```

After the **StackStatus** displays **CREATE\_COMPLETE**, the output displays values for the following parameters. You must provide these parameter values to the other CloudFormation templates that you run to create your cluster:

<b>PrivateHostedZoneId</b>	Hosted zone ID for the private DNS.
<b>ExternalApiLoadBalancerName</b>	Full name of the external API load balancer.
<b>InternalApiLoadBalancerName</b>	Full name of the internal API load balancer.
<b>ApiServerDnsName</b>	Full hostname of the API server.
<b>RegisterNLbpTargetsLambda</b>	Lambda ARN useful to help register/deregister IP targets for these load balancers.
<b>ExternalApiTargetGroupArn</b>	ARN of external API target group.
<b>InternalApiTargetGroupArn</b>	ARN of internal API target group.
<b>InternalServiceTargetGroupArn</b>	ARN of internal service target group.

### 5.13.11.1. CloudFormation template for the network and load balancers

You can use the following CloudFormation template to deploy the networking objects and load balancers that you need for your OpenShift Container Platform cluster.

#### Example 5.45. CloudFormation template for the network and load balancers

AWSTemplateFormatVersion: [2010-09-09](#)

Description: Template for OpenShift Cluster Network Elements (Route53 & LBs)

Parameters:

ClusterName:

AllowedPattern: `^[a-zA-Z][a-zA-Z0-9\-\]{0,26}$`

MaxLength: [27](#)

MinLength: [1](#)

ConstraintDescription: Cluster name must be alphanumeric, start with a letter, and have a maximum of [27](#) characters.

Description: A short, representative cluster name to use for host names and other identifying

names.

Type: String

InfrastructureName:

AllowedPattern: `^[a-zA-Z][a-zA-Z0-9\-\]{0,26}$`

MaxLength: 27

MinLength: 1

ConstraintDescription: Infrastructure name must be alphanumeric, start with a letter, and have a maximum of 27 characters.

Description: A short, unique cluster ID used to tag cloud resources and identify items owned or used by the cluster.

Type: String

HostedZoneld:

Description: The Route53 public zone ID to register the targets with, such as Z21IXYZABCZ2A4.

Type: String

HostedZoneName:

Description: The Route53 zone to register the targets with, such as example.com. Omit the trailing period.

Type: String

Default: "example.com"

PublicSubnets:

Description: The internet-facing subnets.

Type: List<AWS::EC2::Subnet::Id>

PrivateSubnets:

Description: The internal subnets.

Type: List<AWS::EC2::Subnet::Id>

VpcId:

Description: The VPC-scoped resources will belong to this VPC.

Type: AWS::EC2::VPC::Id

Metadata:

AWS::CloudFormation::Interface:

ParameterGroups:

- Label:

default: "Cluster Information"

Parameters:

- ClusterName

- InfrastructureName

- Label:

default: "Network Configuration"

Parameters:

- VpcId

- PublicSubnets

- PrivateSubnets

- Label:

default: "DNS"

Parameters:

- HostedZoneName

- HostedZoneld

ParameterLabels:

ClusterName:

default: "Cluster Name"

InfrastructureName:

default: "Infrastructure Name"

VpcId:

default: "VPC ID"

```

PublicSubnets:
  default: "Public Subnets"
PrivateSubnets:
  default: "Private Subnets"
HostedZoneName:
  default: "Public Hosted Zone Name"
HostedZoneId:
  default: "Public Hosted Zone ID"

```

## Resources:

```

ExtApiElb:
  Type: AWS::ElasticLoadBalancingV2::LoadBalancer
  Properties:
    Name: !Join ["-", [!Ref InfrastructureName, "ext"]]
    IpAddressType: ipv4
    Subnets: !Ref PublicSubnets
    Type: network

```

## IntApiElb:

```

Type: AWS::ElasticLoadBalancingV2::LoadBalancer
Properties:
  Name: !Join ["-", [!Ref InfrastructureName, "int"]]
  Scheme: internal
  IpAddressType: ipv4
  Subnets: !Ref PrivateSubnets
  Type: network

```

## IntDns:

```

Type: "AWS::Route53::HostedZone"
Properties:
  HostedZoneConfig:
    Comment: "Managed by CloudFormation"
  Name: !Join [".", [!Ref ClusterName, !Ref HostedZoneName]]
  HostedZoneTags:
    - Key: Name
      Value: !Join ["-", [!Ref InfrastructureName, "int"]]
    - Key: !Join [ "", ["kubernetes.io/cluster/", !Ref InfrastructureName]]
      Value: "owned"
  VPCs:
    - VPCId: !Ref Vpclid
      VPCRegion: !Ref "AWS::Region"

```

## ExternalApiServerRecord:

```

Type: AWS::Route53::RecordSetGroup
Properties:
  Comment: Alias record for the API server
  HostedZoneId: !Ref HostedZoneId
  RecordSets:
    - Name:
        !Join [
          ".",
          ["api", !Ref ClusterName, !Join [ "", [!Ref HostedZoneName, "."]]],
        ]
      Type: A
      AliasTarget:
        HostedZoneId: !GetAtt ExtApiElb.CanonicalHostedZoneID

```

DNSName: !GetAtt ExtApiElb.DNSName

InternalApiServerRecord:

Type: AWS::Route53::RecordSetGroup

Properties:

Comment: Alias record for the API server

HostedZoneId: !Ref IntDns

RecordSets:

- Name:

```
!Join [
  ":",
  ["api", !Ref ClusterName, !Join ["", [!Ref HostedZoneName, "."]]],
]
```

Type: A

AliasTarget:

HostedZoneId: !GetAtt IntApiElb.CanonicalHostedZoneID

DNSName: !GetAtt IntApiElb.DNSName

- Name:

```
!Join [
  ":",
  ["api-int", !Ref ClusterName, !Join ["", [!Ref HostedZoneName, "."]]],
]
```

Type: A

AliasTarget:

HostedZoneId: !GetAtt IntApiElb.CanonicalHostedZoneID

DNSName: !GetAtt IntApiElb.DNSName

ExternalApiListener:

Type: AWS::ElasticLoadBalancingV2::Listener

Properties:

DefaultActions:

- Type: forward

TargetGroupArn:

Ref: ExternalApiTargetGroup

LoadBalancerArn:

Ref: ExtApiElb

Port: 6443

Protocol: TCP

ExternalApiTargetGroup:

Type: AWS::ElasticLoadBalancingV2::TargetGroup

Properties:

HealthCheckIntervalSeconds: 10

HealthCheckPath: "/readyz"

HealthCheckPort: 6443

HealthCheckProtocol: HTTPS

HealthyThresholdCount: 2

UnhealthyThresholdCount: 2

Port: 6443

Protocol: TCP

TargetType: ip

VpcId:

Ref: VpcId

TargetGroupAttributes:

- Key: deregistration\_delay.timeout\_seconds

Value: 60

**InternalApiListener:**

Type: AWS::ElasticLoadBalancingV2::Listener

## Properties:

DefaultActions:

- Type: forward

TargetGroupArn:

Ref: InternalApiTargetGroup

LoadBalancerArn:

Ref: IntApiElb

Port: 6443

Protocol: TCP

**InternalApiTargetGroup:**

Type: AWS::ElasticLoadBalancingV2::TargetGroup

## Properties:

HealthCheckIntervalSeconds: 10

HealthCheckPath: "/readyz"

HealthCheckPort: 6443

HealthCheckProtocol: HTTPS

HealthyThresholdCount: 2

UnhealthyThresholdCount: 2

Port: 6443

Protocol: TCP

TargetType: ip

VpcId:

Ref: VpcId

TargetGroupAttributes:

- Key: deregistration\_delay.timeout\_seconds

Value: 60

**InternalServiceInternalListener:**

Type: AWS::ElasticLoadBalancingV2::Listener

## Properties:

DefaultActions:

- Type: forward

TargetGroupArn:

Ref: InternalServiceTargetGroup

LoadBalancerArn:

Ref: IntApiElb

Port: 22623

Protocol: TCP

**InternalServiceTargetGroup:**

Type: AWS::ElasticLoadBalancingV2::TargetGroup

## Properties:

HealthCheckIntervalSeconds: 10

HealthCheckPath: "/healthz"

HealthCheckPort: 22623

HealthCheckProtocol: HTTPS

HealthyThresholdCount: 2

UnhealthyThresholdCount: 2

Port: 22623

Protocol: TCP

TargetType: ip

VpcId:

Ref: VpcId  
 TargetGroupAttributes:  
 - Key: deregistration\_delay.timeout\_seconds  
 Value: 60

RegisterTargetLambdalamRole:  
 Type: AWS::IAM::Role  
 Properties:  
 RoleName: !Join ["-", [!Ref InfrastructureName, "nlb", "lambda", "role"]]  
 AssumeRolePolicyDocument:  
 Version: "2012-10-17"  
 Statement:  
 - Effect: "Allow"  
 Principal:  
 Service:  
 - "lambda.amazonaws.com"  
 Action:  
 - "sts:AssumeRole"  
 Path: "/"  
 Policies:  
 - PolicyName: !Join ["-", [!Ref InfrastructureName, "master", "policy"]]  
 PolicyDocument:  
 Version: "2012-10-17"  
 Statement:  
 - Effect: "Allow"  
 Action:  
 [
 "elasticloadbalancing:RegisterTargets",
 "elasticloadbalancing:DeregisterTargets",
 ]  
 Resource: !Ref InternalApiTargetGroup  
 - Effect: "Allow"  
 Action:  
 [
 "elasticloadbalancing:RegisterTargets",
 "elasticloadbalancing:DeregisterTargets",
 ]  
 Resource: !Ref InternalServiceTargetGroup  
 - Effect: "Allow"  
 Action:  
 [
 "elasticloadbalancing:RegisterTargets",
 "elasticloadbalancing:DeregisterTargets",
 ]  
 Resource: !Ref ExternalApiTargetGroup

RegisterNlbTargets:  
 Type: "AWS::Lambda::Function"  
 Properties:  
 Handler: "index.handler"  
 Role:  
 Fn::GetAtt:  
 - "RegisterTargetLambdalamRole"  
 - "Arn"  
 Code:  
 ZipFile: |

```

import json
import boto3
import cfnresponse
def handler(event, context):
    elb = boto3.client('elbv2')
    if event['RequestType'] == 'Delete':
        elb.deregister_targets(TargetGroupArn=event['ResourceProperties']
['TargetArn'],Targets=[{'Id': event['ResourceProperties']['TargetIp']})
    elif event['RequestType'] == 'Create':
        elb.register_targets(TargetGroupArn=event['ResourceProperties']['TargetArn'],Targets=
[{'Id': event['ResourceProperties']['TargetIp']})
    responseData = {}
    cfnresponse.send(event, context, cfnresponse.SUCCESS, responseData,
event['ResourceProperties']['TargetArn']+event['ResourceProperties']['TargetIp'])
    Runtime: "python3.7"
    Timeout: 120

```

RegisterSubnetTagsLambdaRole:

Type: AWS::IAM::Role

Properties:

RoleName: !Join ["-", [!Ref InfrastructureName, "subnet-tags-lambda-role"]]

AssumeRolePolicyDocument:

Version: "2012-10-17"

Statement:

- Effect: "Allow"

Principal:

Service:

- "lambda.amazonaws.com"

Action:

- "sts:AssumeRole"

Path: "/"

Policies:

- PolicyName: !Join ["-", [!Ref InfrastructureName, "subnet-tagging-policy"]]

PolicyDocument:

Version: "2012-10-17"

Statement:

- Effect: "Allow"

Action:

```

[
  "ec2:DeleteTags",
  "ec2:CreateTags"
]

```

Resource: "arn:aws:ec2:\*:\*:subnet/\*"

- Effect: "Allow"

Action:

```

[
  "ec2:DescribeSubnets",
  "ec2:DescribeTags"
]

```

Resource: ""

RegisterSubnetTags:

Type: "AWS::Lambda::Function"

Properties:

Handler: "index.handler"

Role:



```

Fn::GetAtt:
  - "RegisterSubnetTagsLambdalamRole"
  - "Arn"
Code:
  ZipFile: |
    import json
    import boto3
    import cfnresponse
    def handler(event, context):
        ec2_client = boto3.client('ec2')
        if event['RequestType'] == 'Delete':
            for subnet_id in event['ResourceProperties']['Subnets']:
                ec2_client.delete_tags(Resources=[subnet_id], Tags=[{'Key': 'kubernetes.io/cluster/' +
event['ResourceProperties']['InfrastructureName']}]);
            elif event['RequestType'] == 'Create':
                for subnet_id in event['ResourceProperties']['Subnets']:
                    ec2_client.create_tags(Resources=[subnet_id], Tags=[{'Key': 'kubernetes.io/cluster/' +
event['ResourceProperties']['InfrastructureName'], 'Value': 'shared'}]);
                responseData = {}
                cfnresponse.send(event, context, cfnresponse.SUCCESS, responseData,
event['ResourceProperties']['InfrastructureName']+event['ResourceProperties']['Subnets'][0])
    Runtime: "python3.7"
    Timeout: 120

```

```

RegisterPublicSubnetTags:
  Type: Custom::SubnetRegister
  Properties:
    ServiceToken: !GetAtt RegisterSubnetTags.Arn
    InfrastructureName: !Ref InfrastructureName
    Subnets: !Ref PublicSubnets

```

```

RegisterPrivateSubnetTags:
  Type: Custom::SubnetRegister
  Properties:
    ServiceToken: !GetAtt RegisterSubnetTags.Arn
    InfrastructureName: !Ref InfrastructureName
    Subnets: !Ref PrivateSubnets

```

```

Outputs:
  PrivateHostedZoneId:
    Description: Hosted zone ID for the private DNS, which is required for private records.
    Value: !Ref IntDns
  ExternalApiLoadBalancerName:
    Description: Full name of the external API load balancer.
    Value: !GetAtt ExtApiElb.LoadBalancerFullName
  InternalApiLoadBalancerName:
    Description: Full name of the internal API load balancer.
    Value: !GetAtt IntApiElb.LoadBalancerFullName
  ApiServerDnsName:
    Description: Full hostname of the API server, which is required for the Ignition config files.
    Value: !Join [".", ["api-int", !Ref ClusterName, !Ref HostedZoneName]]
  RegisterNlbIpTargetsLambda:
    Description: Lambda ARN useful to help register or deregister IP targets for these load
balancers.
    Value: !GetAtt RegisterNlbIpTargets.Arn
  ExternalApiTargetGroupArn:

```

Description: ARN of the external API target group.  
 Value: !Ref ExternalApiTargetGroup  
 InternalApiTargetGroupArn:  
 Description: ARN of the internal API target group.  
 Value: !Ref InternalApiTargetGroup  
 InternalServiceTargetGroupArn:  
 Description: ARN of the internal service target group.  
 Value: !Ref InternalServiceTargetGroup

## IMPORTANT

If you are deploying your cluster to an AWS government or secret region, you must update the **InternalApiServerRecord** to use **CNAME** records. Records of type **ALIAS** are not supported for AWS government regions. For example:

```
Type: CNAME
TTL: 10
ResourceRecords:
- !GetAtt IntApiElb.DNSName
```

## Additional resources

- You can view details about the CloudFormation stacks that you create by navigating to the [AWS CloudFormation console](#).
- You can view details about your hosted zones by navigating to the [AWS Route 53 console](#).
- See [Listing public hosted zones](#) in the AWS documentation for more information about listing public hosted zones.

## 5.13.12. Creating security group and roles in AWS

You must create security groups and roles in Amazon Web Services (AWS) for your OpenShift Container Platform cluster to use.

You can use the provided CloudFormation template and a custom parameter file to create a stack of AWS resources. The stack represents the security groups and roles that your OpenShift Container Platform cluster requires.

## NOTE

If you do not use the provided CloudFormation template to create your AWS infrastructure, you must review the provided information and manually create the infrastructure. If your cluster does not initialize correctly, you might have to contact Red Hat support with your installation logs.

## Prerequisites

- You configured an AWS account.
- You added your AWS keys and region to your local AWS profile by running **aws configure**.
- You generated the Ignition config files for your cluster.

- You created and configured a VPC and associated subnets in AWS.

## Procedure

- Create a JSON file that contains the parameter values that the template requires:

```
[
  {
    "ParameterKey": "InfrastructureName", 1
    "ParameterValue": "mycluster-<random_string>" 2
  },
  {
    "ParameterKey": "VpcCidr", 3
    "ParameterValue": "10.0.0.0/16" 4
  },
  {
    "ParameterKey": "PrivateSubnets", 5
    "ParameterValue": "subnet-<random_string>" 6
  },
  {
    "ParameterKey": "VpcId", 7
    "ParameterValue": "vpc-<random_string>" 8
  }
]
```

- 1** The name for your cluster infrastructure that is encoded in your Ignition config files for the cluster.
  - 2** Specify the infrastructure name that you extracted from the Ignition config file metadata, which has the format **<cluster-name>-<random-string>**.
  - 3** The CIDR block for the VPC.
  - 4** Specify the CIDR block parameter that you used for the VPC that you defined in the form **x.x.x.x/16-24**.
  - 5** The private subnets that you created for your VPC.
  - 6** Specify the **PrivateSubnetIds** value from the output of the CloudFormation template for the VPC.
  - 7** The VPC that you created for the cluster.
  - 8** Specify the **VpcId** value from the output of the CloudFormation template for the VPC.
- Copy the template from the **CloudFormation template for security objects** section of this topic and save it as a YAML file on your computer. This template describes the security groups and roles that your cluster requires.
  - Launch the CloudFormation template to create a stack of AWS resources that represent the security groups and roles:

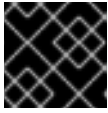
**IMPORTANT**

You must enter the command on a single line.

```
$ aws cloudformation create-stack --stack-name <name> 1
  --template-body file://<template>.yaml 2
  --parameters file://<parameters>.json 3
  --capabilities CAPABILITY_NAMED_IAM 4
```

- 1 **<name>** is the name for the CloudFormation stack, such as **cluster-sec**. You need the name of this stack if you remove the cluster.
- 2 **<template>** is the relative path to and name of the CloudFormation template YAML file that you saved.
- 3 **<parameters>** is the relative path to and name of the CloudFormation parameters JSON file.
- 4 You must explicitly declare the **CAPABILITY\_NAMED\_IAM** capability because the provided template creates some **AWS::IAM::Role** and **AWS::IAM::InstanceProfile** resources.

**Example output**

```
arn:aws:cloudformation:us-east-1:269333783861:stack/cluster-sec/03bd4210-2ed7-11eb-6d7a-13fc0b61e9db
```

4. Confirm that the template components exist:

```
$ aws cloudformation describe-stacks --stack-name <name>
```

After the **StackStatus** displays **CREATE\_COMPLETE**, the output displays values for the following parameters. You must provide these parameter values to the other CloudFormation templates that you run to create your cluster:

<b>MasterSecurityGroupID</b>	Master Security Group ID
<b>WorkerSecurityGroupID</b>	Worker Security Group ID
<b>MasterInstanceProfile</b>	Master IAM Instance Profile
<b>WorkerInstanceProfile</b>	Worker IAM Instance Profile

### 5.13.12.1. CloudFormation template for security objects

You can use the following CloudFormation template to deploy the security objects that you need for your OpenShift Container Platform cluster.

#### Example 5.46. CloudFormation template for security objects

```

AWSTemplateFormatVersion: 2010-09-09
Description: Template for OpenShift Cluster Security Elements (Security Groups & IAM)

Parameters:
  InfrastructureName:
    AllowedPattern: ^([a-zA-Z][a-zA-Z0-9\-\-]{0,26})$
    MaxLength: 27
    MinLength: 1
    ConstraintDescription: Infrastructure name must be alphanumeric, start with a letter, and have a
    maximum of 27 characters.
    Description: A short, unique cluster ID used to tag cloud resources and identify items owned or
    used by the cluster.
    Type: String
  VpcCidr:
    AllowedPattern: ^(((0-9)|1-9|0-9|10-9){2}|20-4|0-9|250-5))\.\.){3}((0-9)|1-9|0-9|10-9){2}|20-
    4|0-9|250-5)(\v(1[6-9]|20-4))$
    ConstraintDescription: CIDR block parameter must be in the form x.x.x.x/16-24.
    Default: 10.0.0.0/16
    Description: CIDR block for VPC.
    Type: String
  VpcId:
    Description: The VPC-scoped resources will belong to this VPC.
    Type: AWS::EC2::VPC::Id
  PrivateSubnets:
    Description: The internal subnets.
    Type: List<AWS::EC2::Subnet::Id>

Metadata:
  AWS::CloudFormation::Interface:
    ParameterGroups:
      - Label:
          default: "Cluster Information"
        Parameters:
          - InfrastructureName
      - Label:
          default: "Network Configuration"
        Parameters:
          - VpcId
          - VpcCidr
          - PrivateSubnets
    ParameterLabels:
      InfrastructureName:
        default: "Infrastructure Name"
      VpcId:
        default: "VPC ID"
      VpcCidr:
        default: "VPC CIDR"
      PrivateSubnets:
        default: "Private Subnets"

```

## Resources:

## MasterSecurityGroup:

Type: AWS::EC2::SecurityGroup

## Properties:

GroupDescription: Cluster Master Security Group

## SecurityGroupIngress:

- IpProtocol: icmp

FromPort: 0

ToPort: 0

CidrIp: !Ref VpcCidr

- IpProtocol: tcp

FromPort: 22

ToPort: 22

CidrIp: !Ref VpcCidr

- IpProtocol: tcp

ToPort: 6443

FromPort: 6443

CidrIp: !Ref VpcCidr

- IpProtocol: tcp

FromPort: 22623

ToPort: 22623

CidrIp: !Ref VpcCidr

VpcId: !Ref VpcId

## WorkerSecurityGroup:

Type: AWS::EC2::SecurityGroup

## Properties:

GroupDescription: Cluster Worker Security Group

## SecurityGroupIngress:

- IpProtocol: icmp

FromPort: 0

ToPort: 0

CidrIp: !Ref VpcCidr

- IpProtocol: tcp

FromPort: 22

ToPort: 22

CidrIp: !Ref VpcCidr

VpcId: !Ref VpcId

## MasterIngressEtcD:

Type: AWS::EC2::SecurityGroupIngress

## Properties:

GroupId: !GetAtt MasterSecurityGroup.GroupId

SourceSecurityGroupId: !GetAtt MasterSecurityGroup.GroupId

Description: etcd

FromPort: 2379

ToPort: 2380

IpProtocol: tcp

## MasterIngressVxlan:

Type: AWS::EC2::SecurityGroupIngress

## Properties:

GroupId: !GetAtt MasterSecurityGroup.GroupId

SourceSecurityGroupId: !GetAtt MasterSecurityGroup.GroupId

Description: Vxlan packets

FromPort: 4789

ToPort: 4789

IpProtocol: udp

MasterIngressWorkerVxlan:

Type: AWS::EC2::SecurityGroupIngress

Properties:

GroupId: !GetAtt MasterSecurityGroup.GroupId

SourceSecurityGroupId: !GetAtt WorkerSecurityGroup.GroupId

Description: Vxlan packets

FromPort: 4789

ToPort: 4789

IpProtocol: udp

MasterIngressGeneve:

Type: AWS::EC2::SecurityGroupIngress

Properties:

GroupId: !GetAtt MasterSecurityGroup.GroupId

SourceSecurityGroupId: !GetAtt MasterSecurityGroup.GroupId

Description: Geneve packets

FromPort: 6081

ToPort: 6081

IpProtocol: udp

MasterIngressWorkerGeneve:

Type: AWS::EC2::SecurityGroupIngress

Properties:

GroupId: !GetAtt MasterSecurityGroup.GroupId

SourceSecurityGroupId: !GetAtt WorkerSecurityGroup.GroupId

Description: Geneve packets

FromPort: 6081

ToPort: 6081

IpProtocol: udp

MasterIngressIpsecIke:

Type: AWS::EC2::SecurityGroupIngress

Properties:

GroupId: !GetAtt MasterSecurityGroup.GroupId

SourceSecurityGroupId: !GetAtt MasterSecurityGroup.GroupId

Description: IPsec IKE packets

FromPort: 500

ToPort: 500

IpProtocol: udp

MasterIngressIpsecNat:

Type: AWS::EC2::SecurityGroupIngress

Properties:

GroupId: !GetAtt MasterSecurityGroup.GroupId

SourceSecurityGroupId: !GetAtt MasterSecurityGroup.GroupId

Description: IPsec NAT-T packets

FromPort: 4500

ToPort: 4500

IpProtocol: udp

MasterIngressIpsecEsp:

Type: AWS::EC2::SecurityGroupIngress

## Properties:

GroupId: !GetAtt MasterSecurityGroup.GroupId  
SourceSecurityGroupId: !GetAtt MasterSecurityGroup.GroupId  
Description: IPsec ESP packets  
IpProtocol: 50

## MasterIngressWorkerIpsecIke:

Type: AWS::EC2::SecurityGroupIngress

## Properties:

GroupId: !GetAtt MasterSecurityGroup.GroupId  
SourceSecurityGroupId: !GetAtt WorkerSecurityGroup.GroupId  
Description: IPsec IKE packets  
FromPort: 500  
ToPort: 500  
IpProtocol: udp

## MasterIngressWorkerIpsecNat:

Type: AWS::EC2::SecurityGroupIngress

## Properties:

GroupId: !GetAtt MasterSecurityGroup.GroupId  
SourceSecurityGroupId: !GetAtt WorkerSecurityGroup.GroupId  
Description: IPsec NAT-T packets  
FromPort: 4500  
ToPort: 4500  
IpProtocol: udp

## MasterIngressWorkerIpsecEsp:

Type: AWS::EC2::SecurityGroupIngress

## Properties:

GroupId: !GetAtt MasterSecurityGroup.GroupId  
SourceSecurityGroupId: !GetAtt WorkerSecurityGroup.GroupId  
Description: IPsec ESP packets  
IpProtocol: 50

## MasterIngressInternal:

Type: AWS::EC2::SecurityGroupIngress

## Properties:

GroupId: !GetAtt MasterSecurityGroup.GroupId  
SourceSecurityGroupId: !GetAtt MasterSecurityGroup.GroupId  
Description: Internal cluster communication  
FromPort: 9000  
ToPort: 9999  
IpProtocol: tcp

## MasterIngressWorkerInternal:

Type: AWS::EC2::SecurityGroupIngress

## Properties:

GroupId: !GetAtt MasterSecurityGroup.GroupId  
SourceSecurityGroupId: !GetAtt WorkerSecurityGroup.GroupId  
Description: Internal cluster communication  
FromPort: 9000  
ToPort: 9999  
IpProtocol: tcp

## MasterIngressInternalUDP:

Type: AWS::EC2::SecurityGroupIngress



## Properties:

GroupId: !GetAtt MasterSecurityGroup.GroupId  
 SourceSecurityGroupId: !GetAtt MasterSecurityGroup.GroupId  
 Description: Internal cluster communication  
 FromPort: 9000  
 ToPort: 9999  
 IpProtocol: udp

## MasterIngressWorkerInternalUDP:

Type: AWS::EC2::SecurityGroupIngress  
 Properties:  
 GroupId: !GetAtt MasterSecurityGroup.GroupId  
 SourceSecurityGroupId: !GetAtt WorkerSecurityGroup.GroupId  
 Description: Internal cluster communication  
 FromPort: 9000  
 ToPort: 9999  
 IpProtocol: udp

## MasterIngressKube:

Type: AWS::EC2::SecurityGroupIngress  
 Properties:  
 GroupId: !GetAtt MasterSecurityGroup.GroupId  
 SourceSecurityGroupId: !GetAtt MasterSecurityGroup.GroupId  
 Description: Kubernetes kubelet, scheduler and controller manager  
 FromPort: 10250  
 ToPort: 10259  
 IpProtocol: tcp

## MasterIngressWorkerKube:

Type: AWS::EC2::SecurityGroupIngress  
 Properties:  
 GroupId: !GetAtt MasterSecurityGroup.GroupId  
 SourceSecurityGroupId: !GetAtt WorkerSecurityGroup.GroupId  
 Description: Kubernetes kubelet, scheduler and controller manager  
 FromPort: 10250  
 ToPort: 10259  
 IpProtocol: tcp

## MasterIngressIngressServices:

Type: AWS::EC2::SecurityGroupIngress  
 Properties:  
 GroupId: !GetAtt MasterSecurityGroup.GroupId  
 SourceSecurityGroupId: !GetAtt MasterSecurityGroup.GroupId  
 Description: Kubernetes ingress services  
 FromPort: 30000  
 ToPort: 32767  
 IpProtocol: tcp

## MasterIngressWorkerIngressServices:

Type: AWS::EC2::SecurityGroupIngress  
 Properties:  
 GroupId: !GetAtt MasterSecurityGroup.GroupId  
 SourceSecurityGroupId: !GetAtt WorkerSecurityGroup.GroupId  
 Description: Kubernetes ingress services  
 FromPort: 30000  
 ToPort: 32767

IpProtocol: tcp

MasterIngressIngressServicesUDP:

Type: AWS::EC2::SecurityGroupIngress

Properties:

GroupId: !GetAtt MasterSecurityGroup.GroupId

SourceSecurityGroupId: !GetAtt MasterSecurityGroup.GroupId

Description: Kubernetes ingress services

FromPort: 30000

ToPort: 32767

IpProtocol: udp

MasterIngressWorkerIngressServicesUDP:

Type: AWS::EC2::SecurityGroupIngress

Properties:

GroupId: !GetAtt MasterSecurityGroup.GroupId

SourceSecurityGroupId: !GetAtt WorkerSecurityGroup.GroupId

Description: Kubernetes ingress services

FromPort: 30000

ToPort: 32767

IpProtocol: udp

WorkerIngressVxlan:

Type: AWS::EC2::SecurityGroupIngress

Properties:

GroupId: !GetAtt WorkerSecurityGroup.GroupId

SourceSecurityGroupId: !GetAtt WorkerSecurityGroup.GroupId

Description: Vxlan packets

FromPort: 4789

ToPort: 4789

IpProtocol: udp

WorkerIngressMasterVxlan:

Type: AWS::EC2::SecurityGroupIngress

Properties:

GroupId: !GetAtt WorkerSecurityGroup.GroupId

SourceSecurityGroupId: !GetAtt MasterSecurityGroup.GroupId

Description: Vxlan packets

FromPort: 4789

ToPort: 4789

IpProtocol: udp

WorkerIngressGeneve:

Type: AWS::EC2::SecurityGroupIngress

Properties:

GroupId: !GetAtt WorkerSecurityGroup.GroupId

SourceSecurityGroupId: !GetAtt WorkerSecurityGroup.GroupId

Description: Geneve packets

FromPort: 6081

ToPort: 6081

IpProtocol: udp

WorkerIngressMasterGeneve:

Type: AWS::EC2::SecurityGroupIngress

Properties:

GroupId: !GetAtt WorkerSecurityGroup.GroupId

SourceSecurityGroupId: !GetAtt MasterSecurityGroup.GroupId  
Description: Geneve packets  
FromPort: 6081  
ToPort: 6081  
IpProtocol: udp

WorkerIngressIpsecIke:

Type: AWS::EC2::SecurityGroupIngress  
Properties:  
GroupId: !GetAtt WorkerSecurityGroup.GroupId  
SourceSecurityGroupId: !GetAtt WorkerSecurityGroup.GroupId  
Description: IPsec IKE packets  
FromPort: 500  
ToPort: 500  
IpProtocol: udp

WorkerIngressIpsecNat:

Type: AWS::EC2::SecurityGroupIngress  
Properties:  
GroupId: !GetAtt WorkerSecurityGroup.GroupId  
SourceSecurityGroupId: !GetAtt WorkerSecurityGroup.GroupId  
Description: IPsec NAT-T packets  
FromPort: 4500  
ToPort: 4500  
IpProtocol: udp

WorkerIngressIpsecEsp:

Type: AWS::EC2::SecurityGroupIngress  
Properties:  
GroupId: !GetAtt WorkerSecurityGroup.GroupId  
SourceSecurityGroupId: !GetAtt WorkerSecurityGroup.GroupId  
Description: IPsec ESP packets  
IpProtocol: 50

WorkerIngressMasterIpsecIke:

Type: AWS::EC2::SecurityGroupIngress  
Properties:  
GroupId: !GetAtt WorkerSecurityGroup.GroupId  
SourceSecurityGroupId: !GetAtt MasterSecurityGroup.GroupId  
Description: IPsec IKE packets  
FromPort: 500  
ToPort: 500  
IpProtocol: udp

WorkerIngressMasterIpsecNat:

Type: AWS::EC2::SecurityGroupIngress  
Properties:  
GroupId: !GetAtt WorkerSecurityGroup.GroupId  
SourceSecurityGroupId: !GetAtt MasterSecurityGroup.GroupId  
Description: IPsec NAT-T packets  
FromPort: 4500  
ToPort: 4500  
IpProtocol: udp

WorkerIngressMasterIpsecEsp:

Type: AWS::EC2::SecurityGroupIngress

## Properties:

GroupId: !GetAtt WorkerSecurityGroup.GroupId  
SourceSecurityGroupId: !GetAtt MasterSecurityGroup.GroupId  
Description: IPsec ESP packets  
IpProtocol: 50

## WorkerIngressInternal:

Type: AWS::EC2::SecurityGroupIngress

## Properties:

GroupId: !GetAtt WorkerSecurityGroup.GroupId  
SourceSecurityGroupId: !GetAtt WorkerSecurityGroup.GroupId  
Description: Internal cluster communication  
FromPort: 9000  
ToPort: 9999  
IpProtocol: tcp

## WorkerIngressMasterInternal:

Type: AWS::EC2::SecurityGroupIngress

## Properties:

GroupId: !GetAtt WorkerSecurityGroup.GroupId  
SourceSecurityGroupId: !GetAtt MasterSecurityGroup.GroupId  
Description: Internal cluster communication  
FromPort: 9000  
ToPort: 9999  
IpProtocol: tcp

## WorkerIngressInternalUDP:

Type: AWS::EC2::SecurityGroupIngress

## Properties:

GroupId: !GetAtt WorkerSecurityGroup.GroupId  
SourceSecurityGroupId: !GetAtt WorkerSecurityGroup.GroupId  
Description: Internal cluster communication  
FromPort: 9000  
ToPort: 9999  
IpProtocol: udp

## WorkerIngressMasterInternalUDP:

Type: AWS::EC2::SecurityGroupIngress

## Properties:

GroupId: !GetAtt WorkerSecurityGroup.GroupId  
SourceSecurityGroupId: !GetAtt MasterSecurityGroup.GroupId  
Description: Internal cluster communication  
FromPort: 9000  
ToPort: 9999  
IpProtocol: udp

## WorkerIngressKube:

Type: AWS::EC2::SecurityGroupIngress

## Properties:

GroupId: !GetAtt WorkerSecurityGroup.GroupId  
SourceSecurityGroupId: !GetAtt WorkerSecurityGroup.GroupId  
Description: Kubernetes secure kubelet port  
FromPort: 10250  
ToPort: 10250  
IpProtocol: tcp

**WorkerIngressWorkerKube:**

Type: AWS::EC2::SecurityGroupIngress

**Properties:**

GroupId: !GetAtt WorkerSecurityGroup.GroupId

SourceSecurityGroupId: !GetAtt MasterSecurityGroup.GroupId

Description: Internal Kubernetes communication

FromPort: 10250

ToPort: 10250

IpProtocol: tcp

**WorkerIngressIngressServices:**

Type: AWS::EC2::SecurityGroupIngress

**Properties:**

GroupId: !GetAtt WorkerSecurityGroup.GroupId

SourceSecurityGroupId: !GetAtt WorkerSecurityGroup.GroupId

Description: Kubernetes ingress services

FromPort: 30000

ToPort: 32767

IpProtocol: tcp

**WorkerIngressMasterIngressServices:**

Type: AWS::EC2::SecurityGroupIngress

**Properties:**

GroupId: !GetAtt WorkerSecurityGroup.GroupId

SourceSecurityGroupId: !GetAtt MasterSecurityGroup.GroupId

Description: Kubernetes ingress services

FromPort: 30000

ToPort: 32767

IpProtocol: tcp

**WorkerIngressIngressServicesUDP:**

Type: AWS::EC2::SecurityGroupIngress

**Properties:**

GroupId: !GetAtt WorkerSecurityGroup.GroupId

SourceSecurityGroupId: !GetAtt WorkerSecurityGroup.GroupId

Description: Kubernetes ingress services

FromPort: 30000

ToPort: 32767

IpProtocol: udp

**WorkerIngressMasterIngressServicesUDP:**

Type: AWS::EC2::SecurityGroupIngress

**Properties:**

GroupId: !GetAtt WorkerSecurityGroup.GroupId

SourceSecurityGroupId: !GetAtt MasterSecurityGroup.GroupId

Description: Kubernetes ingress services

FromPort: 30000

ToPort: 32767

IpProtocol: udp

**MasterIamRole:**

Type: AWS::IAM::Role

**Properties:**

AssumeRolePolicyDocument:

Version: "2012-10-17"

Statement:

```
- Effect: "Allow"
Principal:
  Service:
    - "ec2.amazonaws.com"
Action:
  - "sts:AssumeRole"
Policies:
- PolicyName: !Join ["-", [!Ref InfrastructureName, "master", "policy"]]
PolicyDocument:
  Version: "2012-10-17"
  Statement:
    - Effect: "Allow"
      Action:
        - "ec2:AttachVolume"
        - "ec2:AuthorizeSecurityGroupIngress"
        - "ec2:CreateSecurityGroup"
        - "ec2:CreateTags"
        - "ec2:CreateVolume"
        - "ec2>DeleteSecurityGroup"
        - "ec2>DeleteVolume"
        - "ec2:Describe*"
        - "ec2:DetachVolume"
        - "ec2:ModifyInstanceAttribute"
        - "ec2:ModifyVolume"
        - "ec2:RevokeSecurityGroupIngress"
        - "elasticloadbalancing:AddTags"
        - "elasticloadbalancing:AttachLoadBalancerToSubnets"
        - "elasticloadbalancing:ApplySecurityGroupsToLoadBalancer"
        - "elasticloadbalancing:CreateListener"
        - "elasticloadbalancing:CreateLoadBalancer"
        - "elasticloadbalancing:CreateLoadBalancerPolicy"
        - "elasticloadbalancing:CreateLoadBalancerListeners"
        - "elasticloadbalancing:CreateTargetGroup"
        - "elasticloadbalancing:ConfigureHealthCheck"
        - "elasticloadbalancing>DeleteListener"
        - "elasticloadbalancing>DeleteLoadBalancer"
        - "elasticloadbalancing>DeleteLoadBalancerListeners"
        - "elasticloadbalancing>DeleteTargetGroup"
        - "elasticloadbalancing:DeregisterInstancesFromLoadBalancer"
        - "elasticloadbalancing:DeregisterTargets"
        - "elasticloadbalancing:Describe*"
        - "elasticloadbalancing:DetachLoadBalancerFromSubnets"
        - "elasticloadbalancing:ModifyListener"
        - "elasticloadbalancing:ModifyLoadBalancerAttributes"
        - "elasticloadbalancing:ModifyTargetGroup"
        - "elasticloadbalancing:ModifyTargetGroupAttributes"
        - "elasticloadbalancing:RegisterInstancesWithLoadBalancer"
        - "elasticloadbalancing:RegisterTargets"
        - "elasticloadbalancing:SetLoadBalancerPoliciesForBackendServer"
        - "elasticloadbalancing:SetLoadBalancerPoliciesOfListener"
        - "kms:DescribeKey"
      Resource: ""
```

```
MasterInstanceProfile:
  Type: "AWS::IAM::InstanceProfile"
  Properties:
```

Roles:

- Ref: "MasterIamRole"

WorkerIamRole:

Type: AWS::IAM::Role

Properties:

AssumeRolePolicyDocument:

Version: "2012-10-17"

Statement:

- Effect: "Allow"

Principal:

Service:

- "ec2.amazonaws.com"

Action:

- "sts:AssumeRole"

Policies:

- PolicyName: !Join ["-", [!Ref InfrastructureName, "worker", "policy"]]

PolicyDocument:

Version: "2012-10-17"

Statement:

- Effect: "Allow"

Action:

- "ec2:DescribeInstances"

- "ec2:DescribeRegions"

Resource: "\*"

WorkerInstanceProfile:

Type: "AWS::IAM::InstanceProfile"

Properties:

Roles:

- Ref: "WorkerIamRole"

Outputs:

MasterSecurityGroupId:

Description: Master Security Group ID

Value: !GetAtt MasterSecurityGroup.GroupId

WorkerSecurityGroupId:

Description: Worker Security Group ID

Value: !GetAtt WorkerSecurityGroup.GroupId

MasterInstanceProfile:

Description: Master IAM Instance Profile

Value: !Ref MasterInstanceProfile

WorkerInstanceProfile:

Description: Worker IAM Instance Profile

Value: !Ref WorkerInstanceProfile

### Additional resources

- You can view details about the CloudFormation stacks that you create by navigating to the [AWS CloudFormation console](#).

### 5.13.13. Accessing RHCOS AMIs with stream metadata

In OpenShift Container Platform, *stream metadata* provides standardized metadata about RHCOS in the JSON format and injects the metadata into the cluster. Stream metadata is a stable format that supports multiple architectures and is intended to be self-documenting for maintaining automation.

You can use the **coreos print-stream-json** sub-command of **openshift-install** to access information about the boot images in the stream metadata format. This command provides a method for printing stream metadata in a scriptable, machine-readable format.

For user-provisioned installations, the **openshift-install** binary contains references to the version of RHCOS boot images that are tested for use with OpenShift Container Platform, such as the AWS AMI.

#### Procedure

To parse the stream metadata, use one of the following methods:

- From a Go program, use the official **stream-metadata-go** library at <https://github.com/coreos/stream-metadata-go>. You can also view example code in the library.
- From another programming language, such as Python or Ruby, use the JSON library of your preferred programming language.
- From a command-line utility that handles JSON data, such as **jq**:
  - Print the current **x86\_64** or **aarch64** AMI for an AWS region, such as **us-west-1**:

```
$ openshift-install coreos print-stream-json | jq -r
'.architectures.x86_64.images.aws.regions["us-west-1"].image'
```

#### Example output

```
ami-0d3e625f84626bbda
```

The output of this command is the AWS AMI ID for your designated architecture and the **us-west-1** region. The AMI must belong to the same region as the cluster.

### 5.13.14. RHCOS AMIs for the AWS infrastructure

Red Hat provides Red Hat Enterprise Linux CoreOS (RHCOS) AMIs that are valid for the various AWS regions and instance architectures that you can manually specify for your OpenShift Container Platform nodes.



#### NOTE

By importing your own AMI, you can also install to regions that do not have a published RHCOS AMI.

Table 5.48. x86\_64 RHCOS AMIs

AWS zone	AWS AMI
<b>af-south-1</b>	<b>ami-0f3804f5a2f913dcc</b>



AWS zone	AWS AMI
ap-east-1	ami-0de1febb30a83da66
ap-northeast-1	ami-0183df96a3e002687
ap-northeast-2	ami-06b8798cd60242798
ap-northeast-3	ami-00b16b33aa0951016
ap-south-1	ami-007243f8ff78e8294
ap-southeast-1	ami-079dfdacb5ab5a0d1
ap-southeast-2	ami-03882e39cb7785c32
ca-central-1	ami-05cba1f80cc8b1dbe
eu-central-1	ami-073c775bbe9cd434e
eu-north-1	ami-0763e6e75b681acc5
eu-south-1	ami-00d023f19775fb64b
eu-west-1	ami-0033e3f2331a530c4
eu-west-2	ami-00d8a741ebe74f0c4
eu-west-3	ami-09b04e7f60e3374a7
me-south-1	ami-0f8039330b6e54010
sa-east-1	ami-01af22f821b470ad1
us-east-1	ami-0c72f473496a7b1c2
us-east-2	ami-09e637fc5885c13cc
us-gov-east-1	ami-0c3b11bcccf6ec63c
us-gov-west-1	ami-084d95ff443d8bf99
us-west-1	ami-0fa0f6fce7e63dd26
us-west-2	ami-084fb1316cd1ed4cc

Table 5.49. aarch64 RHCOS AMIs

AWS zone	AWS AMI
<b>ap-east</b>	<b>ami-0f8195c36da4edbd7</b>
<b>ap-northeast-1</b>	<b>ami-000a86fa0a0b76144</b>
<b>ap-northeast-2</b>	<b>ami-0f772f5dc2347a954</b>
<b>ap-south-1</b>	<b>ami-02ab23e25b8e8af97</b>
<b>ap-southeast-1</b>	<b>ami-085ae5a7dcbfb056d</b>
<b>ap-southeast-2</b>	<b>ami-085ff9f4e8d4d66e0</b>
<b>ca-central-1</b>	<b>ami-0050cdf32f76ba82c</b>
<b>eu-central-1</b>	<b>ami-092527fcf7c21fe42</b>
<b>eu-north-1</b>	<b>ami-07d673450675ea033</b>
<b>eu-south-1</b>	<b>ami-0f165ac29cc9d27bf</b>
<b>eu-west-1</b>	<b>ami-0e0cd7d2eb949538d</b>
<b>eu-west-2</b>	<b>ami-0790ba70a444fe74d</b>
<b>eu-west-3</b>	<b>ami-0d16af5bd22cc5227</b>
<b>me-south-1</b>	<b>ami-05e1ba911ce321052</b>
<b>sa-east-1</b>	<b>ami-04b124534c7f05cd2</b>
<b>us-east-1</b>	<b>ami-09bbec91849ca85bc</b>
<b>us-east-2</b>	<b>ami-048ac599f7315a0bc</b>
<b>us-west-1</b>	<b>ami-0af1d3b7fa5be2131</b>
<b>us-west-2</b>	<b>ami-0bd3bf54ee678e2a6</b>

#### 5.13.14.1. AWS regions without a published RHCOS AMI

You can deploy an OpenShift Container Platform cluster to Amazon Web Services (AWS) regions without native support for a Red Hat Enterprise Linux CoreOS (RHCOS) Amazon Machine Image (AMI) or the AWS software development kit (SDK). If a published AMI is not available for an AWS region, you can upload a custom AMI prior to installing the cluster.

If you are deploying to a region not supported by the AWS SDK and you do not specify a custom AMI,

the installation program copies the **us-east-1** AMI to the user account automatically. Then the installation program creates the control plane machines with encrypted EBS volumes using the default or user-specified Key Management Service (KMS) key. This allows the AMI to follow the same process workflow as published RHCOS AMIs.

A region without native support for an RHCOS AMI is not available to select from the terminal during cluster creation because it is not published. However, you can install to this region by configuring the custom AMI in the **install-config.yaml** file.

### 5.13.14.2. Uploading a custom RHCOS AMI in AWS

If you are deploying to a custom Amazon Web Services (AWS) region, you must upload a custom Red Hat Enterprise Linux CoreOS (RHCOS) Amazon Machine Image (AMI) that belongs to that region.

#### Prerequisites

- You configured an AWS account.
- You created an Amazon S3 bucket with the required IAM [service role](#).
- You uploaded your RHCOS VMDK file to Amazon S3. The RHCOS VMDK file must be the highest version that is less than or equal to the OpenShift Container Platform version you are installing.
- You downloaded the AWS CLI and installed it on your computer. See [Install the AWS CLI Using the Bundled Installer](#).

#### Procedure

1. Export your AWS profile as an environment variable:

```
$ export AWS_PROFILE=<aws_profile> 1
```

2. Export the region to associate with your custom AMI as an environment variable:

```
$ export AWS_DEFAULT_REGION=<aws_region> 1
```

3. Export the version of RHCOS you uploaded to Amazon S3 as an environment variable:

```
$ export RHCOS_VERSION=<version> 1
```

1 1 1 The RHCOS VMDK version, like **4.10.0**.

4. Export the Amazon S3 bucket name as an environment variable:

```
$ export VMIMPORT_BUCKET_NAME=<s3_bucket_name>
```

5. Create the **containers.json** file and define your RHCOS VMDK file:

```
$ cat <<EOF > containers.json
{
  "Description": "rhcos-${RHCOS_VERSION}-x86_64-aws.x86_64",
  "Format": "vmdk",
```

```
"UserBucket": {
  "S3Bucket": "${VMIMPORT_BUCKET_NAME}",
  "S3Key": "rhcos-${RHCOS_VERSION}-x86_64-aws.x86_64.vmdk"
}
}
EOF
```

6. Import the RHCOS disk as an Amazon EBS snapshot:

```
$ aws ec2 import-snapshot --region ${AWS_DEFAULT_REGION} \
  --description "<description>" \ 1
  --disk-container "file://<file_path>/containers.json" 2
```

- 1** The description of your RHCOS disk being imported, like **rhcos-\${RHCOS\_VERSION}-x86\_64-aws.x86\_64**.
- 2** The file path to the JSON file describing your RHCOS disk. The JSON file should contain your Amazon S3 bucket name and key.

7. Check the status of the image import:

```
$ watch -n 5 aws ec2 describe-import-snapshot-tasks --region ${AWS_DEFAULT_REGION}
```

### Example output

```
{
  "ImportSnapshotTasks": [
    {
      "Description": "rhcos-4.7.0-x86_64-aws.x86_64",
      "ImportTaskId": "import-snap-fh6i8uil",
      "SnapshotTaskDetail": {
        "Description": "rhcos-4.7.0-x86_64-aws.x86_64",
        "DiskImageSize": 819056640.0,
        "Format": "VMDK",
        "SnapshotId": "snap-06331325870076318",
        "Status": "completed",
        "UserBucket": {
          "S3Bucket": "external-images",
          "S3Key": "rhcos-4.7.0-x86_64-aws.x86_64.vmdk"
        }
      }
    }
  ]
}
```

Copy the **SnapshotId** to register the image.

8. Create a custom RHCOS AMI from the RHCOS snapshot:

```
$ aws ec2 register-image \
  --region ${AWS_DEFAULT_REGION} \
  --architecture x86_64 \ 1
  --description "rhcos-${RHCOS_VERSION}-x86_64-aws.x86_64" \ 2
```

```

--ena-support \
--name "rhcos-${RHCOS_VERSION}-x86_64-aws.x86_64" \ ❸
--virtualization-type hvm \
--root-device-name '/dev/xvda' \
--block-device-mappings 'DeviceName=/dev/xvda,Ebs=
{DeleteOnTermination=true,SnapshotId=<snapshot_ID>}' ❹

```

- ❶ The RHCOS VMDK architecture type, like **x86\_64**, **s390x**, or **ppc64le**.
- ❷ The **Description** from the imported snapshot.
- ❸ The name of the RHCOS AMI.
- ❹ The **SnapshotID** from the imported snapshot.

To learn more about these APIs, see the AWS documentation for [importing snapshots](#) and [creating EBS-backed AMIs](#).

### 5.13.15. Creating the bootstrap node in AWS

You must create the bootstrap node in Amazon Web Services (AWS) to use during OpenShift Container Platform cluster initialization.

You can use the provided CloudFormation template and a custom parameter file to create a stack of AWS resources. The stack represents the bootstrap node that your OpenShift Container Platform installation requires.



#### NOTE

If you do not use the provided CloudFormation template to create your bootstrap node, you must review the provided information and manually create the infrastructure. If your cluster does not initialize correctly, you might have to contact Red Hat support with your installation logs.

#### Prerequisites

- You configured an AWS account.
- You added your AWS keys and region to your local AWS profile by running **aws configure**.
- You generated the Ignition config files for your cluster.
- You created and configured a VPC and associated subnets in AWS.
- You created and configured DNS, load balancers, and listeners in AWS.
- You created the security groups and roles required for your cluster in AWS.

#### Procedure

1. Provide a location to serve the **bootstrap.ign** Ignition config file to your cluster. This file is located in your installation directory. One way to do this is to create an S3 bucket in your cluster's region and upload the Ignition config file to it.

**IMPORTANT**

The provided CloudFormation Template assumes that the Ignition config files for your cluster are served from an S3 bucket. If you choose to serve the files from another location, you must modify the templates.

**IMPORTANT**

If you are deploying to a region that has endpoints that differ from the AWS SDK, or you are providing your own custom endpoints, you must use a presigned URL for your S3 bucket instead of the **s3://** schema.

**NOTE**

The bootstrap Ignition config file does contain secrets, like X.509 keys. The following steps provide basic security for the S3 bucket. To provide additional security, you can enable an S3 bucket policy to allow only certain users, such as the OpenShift IAM user, to access objects that the bucket contains. You can avoid S3 entirely and serve your bootstrap Ignition config file from any address that the bootstrap machine can reach.

- a. Create the bucket:

```
$ aws s3 mb s3://<cluster-name>-infra 1
```

- 1** **<cluster-name>-infra** is the bucket name. When creating the **install-config.yaml** file, replace **<cluster-name>** with the name specified for the cluster.

- b. Upload the **bootstrap.ign** Ignition config file to the bucket:

```
$ aws s3 cp <installation_directory>/bootstrap.ign s3://<cluster-name>-  
infra/bootstrap.ign 1
```

- 1** For **<installation\_directory>**, specify the path to the directory that you stored the installation files in.

- c. Verify that the file uploaded:

```
$ aws s3 ls s3://<cluster-name>-infra/
```

**Example output**

```
2019-04-03 16:15:16 314878 bootstrap.ign
```

2. Create a JSON file that contains the parameter values that the template requires:

```
[  
  {  
    "ParameterKey": "InfrastructureName", 1  
    "ParameterValue": "mycluster-<random_string>" 2  
  },  
]
```

```

{
  "ParameterKey": "RhcosAmi", 3
  "ParameterValue": "ami-<random_string>" 4
},
{
  "ParameterKey": "AllowedBootstrapSshCidr", 5
  "ParameterValue": "0.0.0.0/0" 6
},
{
  "ParameterKey": "PublicSubnet", 7
  "ParameterValue": "subnet-<random_string>" 8
},
{
  "ParameterKey": "MasterSecurityGroupIid", 9
  "ParameterValue": "sg-<random_string>" 10
},
{
  "ParameterKey": "VpcIid", 11
  "ParameterValue": "vpc-<random_string>" 12
},
{
  "ParameterKey": "BootstrapIgnitionLocation", 13
  "ParameterValue": "s3://<bucket_name>/bootstrap.ign" 14
},
{
  "ParameterKey": "AutoRegisterELB", 15
  "ParameterValue": "yes" 16
},
{
  "ParameterKey": "RegisterNlbPTargetsLambdaArn", 17
  "ParameterValue": "arn:aws:lambda:<region>:<account_number>:function:
<dns_stack_name>-RegisterNlbPTargets-<random_string>" 18
},
{
  "ParameterKey": "ExternalApiTargetGroupArn", 19
  "ParameterValue": "arn:aws:elasticloadbalancing:<region>:
<account_number>:targetgroup/<dns_stack_name>-Exter-<random_string>" 20
},
{
  "ParameterKey": "InternalApiTargetGroupArn", 21
  "ParameterValue": "arn:aws:elasticloadbalancing:<region>:
<account_number>:targetgroup/<dns_stack_name>-Inter-<random_string>" 22
},
{
  "ParameterKey": "InternalServiceTargetGroupArn", 23
  "ParameterValue": "arn:aws:elasticloadbalancing:<region>:
<account_number>:targetgroup/<dns_stack_name>-Inter-<random_string>" 24
}
]

```

- 1 The name for your cluster infrastructure that is encoded in your Ignition config files for the cluster.

- 2 Specify the infrastructure name that you extracted from the Ignition config file metadata, which has the format **<cluster-name>-<random-string>**.
- 3 Current Red Hat Enterprise Linux CoreOS (RHCOS) AMI to use for the bootstrap node.
- 4 Specify a valid **AWS::EC2::Image::Id** value.
- 5 CIDR block to allow SSH access to the bootstrap node.
- 6 Specify a CIDR block in the format **x.x.x.x/16-24**.
- 7 The public subnet that is associated with your VPC to launch the bootstrap node into.
- 8 Specify the **PublicSubnetIds** value from the output of the CloudFormation template for the VPC.
- 9 The master security group ID (for registering temporary rules)
- 10 Specify the **MasterSecurityGroupId** value from the output of the CloudFormation template for the security group and roles.
- 11 The VPC created resources will belong to.
- 12 Specify the **VpcId** value from the output of the CloudFormation template for the VPC.
- 13 Location to fetch bootstrap Ignition config file from.
- 14 Specify the S3 bucket and file name in the form **s3://<bucket\_name>/bootstrap.ign**.
- 15 Whether or not to register a network load balancer (NLB).
- 16 Specify **yes** or **no**. If you specify **yes**, you must provide a Lambda Amazon Resource Name (ARN) value.
- 17 The ARN for NLB IP target registration lambda group.
- 18 Specify the **RegisterNlbTargetsLambda** value from the output of the CloudFormation template for DNS and load balancing. Use **arn:aws-us-gov** if deploying the cluster to an AWS GovCloud region.
- 19 The ARN for external API load balancer target group.
- 20 Specify the **ExternalApiTargetGroupArn** value from the output of the CloudFormation template for DNS and load balancing. Use **arn:aws-us-gov** if deploying the cluster to an AWS GovCloud region.
- 21 The ARN for internal API load balancer target group.
- 22 Specify the **InternalApiTargetGroupArn** value from the output of the CloudFormation template for DNS and load balancing. Use **arn:aws-us-gov** if deploying the cluster to an AWS GovCloud region.
- 23 The ARN for internal service load balancer target group.
- 24 Specify the **InternalServiceTargetGroupArn** value from the output of the CloudFormation template for DNS and load balancing. Use **arn:aws-us-gov** if deploying the cluster to an AWS GovCloud region.



- Copy the template from the **CloudFormation template for the bootstrap machines** section of this topic and save it as a YAML file on your computer. This template describes the bootstrap machine that your cluster requires.
- Launch the CloudFormation template to create a stack of AWS resources that represent the bootstrap node:

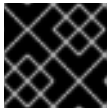

### IMPORTANT

You must enter the command on a single line.

```
$ aws cloudformation create-stack --stack-name <name> 1
  --template-body file://<template>.yaml 2
  --parameters file://<parameters>.json 3
  --capabilities CAPABILITY_NAMED_IAM 4
```

- <name>** is the name for the CloudFormation stack, such as **cluster-bootstrap**. You need the name of this stack if you remove the cluster.
- <template>** is the relative path to and name of the CloudFormation template YAML file that you saved.
- <parameters>** is the relative path to and name of the CloudFormation parameters JSON file.
- You must explicitly declare the **CAPABILITY\_NAMED\_IAM** capability because the provided template creates some **AWS::IAM::Role** and **AWS::IAM::InstanceProfile** resources.

### Example output

```
arn:aws:cloudformation:us-east-1:269333783861:stack/cluster-bootstrap/12944486-2add-11eb-9dee-12dace8e3a83
```

- Confirm that the template components exist:

```
$ aws cloudformation describe-stacks --stack-name <name>
```

After the **StackStatus** displays **CREATE\_COMPLETE**, the output displays values for the following parameters. You must provide these parameter values to the other CloudFormation templates that you run to create your cluster:

<b>Bootstrap InstanceId</b>	The bootstrap Instance ID.
<b>Bootstrap PublicIp</b>	The bootstrap node public IP address.
<b>Bootstrap PrivateIp</b>	The bootstrap node private IP address.

### 5.13.15.1. CloudFormation template for the bootstrap machine

You can use the following CloudFormation template to deploy the bootstrap machine that you need for your OpenShift Container Platform cluster.

#### Example 5.47. CloudFormation template for the bootstrap machine

```

AWSTemplateFormatVersion: 2010-09-09
Description: Template for OpenShift Cluster Bootstrap (EC2 Instance, Security Groups and IAM)

Parameters:
  InfrastructureName:
    AllowedPattern: ^([a-zA-Z][a-zA-Z0-9\-\_]{0,26})$
    MaxLength: 27
    MinLength: 1
    ConstraintDescription: Infrastructure name must be alphanumeric, start with a letter, and have a
    maximum of 27 characters.
    Description: A short, unique cluster ID used to tag cloud resources and identify items owned or
    used by the cluster.
    Type: String
  RhcosAmi:
    Description: Current Red Hat Enterprise Linux CoreOS AMI to use for bootstrap.
    Type: AWS::EC2::Image::Id
  AllowedBootstrapSshCidr:
    AllowedPattern: ^((([0-9]{1-9}[0-9]{1-9}|1[0-9]{2}|2[0-4][0-9]|25[0-5])\.)\.)\{3\}([0-9]{1-9}|1[0-9]{2}|2[0-
    4][0-9]|25[0-5])(\V([0-9]{1-9}|2[0-9]|3[0-2]))$
    ConstraintDescription: CIDR block parameter must be in the form x.x.x.x/0-32.
    Default: 0.0.0.0/0
    Description: CIDR block to allow SSH access to the bootstrap node.
    Type: String
  PublicSubnet:
    Description: The public subnet to launch the bootstrap node into.
    Type: AWS::EC2::Subnet::Id
  MasterSecurityGroupId:
    Description: The master security group ID for registering temporary rules.
    Type: AWS::EC2::SecurityGroup::Id
  VpcId:
    Description: The VPC-scoped resources will belong to this VPC.
    Type: AWS::EC2::VPC::Id
  BootstrapIgnitionLocation:
    Default: s3://my-s3-bucket/bootstrap.ign
    Description: Ignition config file location.
    Type: String
  AutoRegisterELB:
    Default: "yes"
    AllowedValues:
      - "yes"
      - "no"
    Description: Do you want to invoke NLB registration, which requires a Lambda ARN parameter?
    Type: String
  RegisterNlbTargetsLambdaArn:
    Description: ARN for NLB IP target registration lambda.
    Type: String
  ExternalApiTargetGroupArn:
    Description: ARN for external API load balancer target group.
    Type: String

```

InternalApiTargetGroupArn:  
 Description: ARN for internal API load balancer target group.  
 Type: String

InternalServiceTargetGroupArn:  
 Description: ARN for internal service load balancer target group.  
 Type: String

BootstrapInstanceType:  
 Description: Instance type for the bootstrap EC2 instance  
 Default: "i3.large"  
 Type: String

#### Metadata:

AWS::CloudFormation::Interface:

ParameterGroups:

- Label:

default: "Cluster Information"

Parameters:

- InfrastructureName

- Label:

default: "Host Information"

Parameters:

- RhcosAmi

- BootstrapIgnitionLocation

- MasterSecurityGroupId

- Label:

default: "Network Configuration"

Parameters:

- VpcId

- AllowedBootstrapSshCidr

- PublicSubnet

- Label:

default: "Load Balancer Automation"

Parameters:

- AutoRegisterELB

- RegisterNlbTargetsLambdaArn

- ExternalApiTargetGroupArn

- InternalApiTargetGroupArn

- InternalServiceTargetGroupArn

ParameterLabels:

InfrastructureName:

default: "Infrastructure Name"

VpcId:

default: "VPC ID"

AllowedBootstrapSshCidr:

default: "Allowed SSH Source"

PublicSubnet:

default: "Public Subnet"

RhcosAmi:

default: "Red Hat Enterprise Linux CoreOS AMI ID"

BootstrapIgnitionLocation:

default: "Bootstrap Ignition Source"

MasterSecurityGroupId:

default: "Master Security Group ID"

AutoRegisterELB:

default: "Use Provided ELB Automation"

## Conditions:

DoRegistration: !Equals ["yes", !Ref AutoRegisterELB]

## Resources:

## BootstrapIamRole:

Type: AWS::IAM::Role

## Properties:

## AssumeRolePolicyDocument:

Version: "2012-10-17"

## Statement:

- Effect: "Allow"

## Principal:

## Service:

- "ec2.amazonaws.com"

## Action:

- "sts:AssumeRole"

Path: "/"

## Policies:

- PolicyName: !Join ["-", [!Ref InfrastructureName, "bootstrap", "policy"]]

## PolicyDocument:

Version: "2012-10-17"

## Statement:

- Effect: "Allow"

Action: "ec2:Describe\*"

Resource: "\*"

- Effect: "Allow"

Action: "ec2:AttachVolume"

Resource: "\*"

- Effect: "Allow"

Action: "ec2:DetachVolume"

Resource: "\*"

- Effect: "Allow"

Action: "s3:GetObject"

Resource: "\*"

## BootstrapInstanceProfile:

Type: "AWS::IAM::InstanceProfile"

## Properties:

Path: "/"

## Roles:

- Ref: "BootstrapIamRole"

## BootstrapSecurityGroup:

Type: AWS::EC2::SecurityGroup

## Properties:

GroupDescription: Cluster Bootstrap Security Group

## SecurityGroupIngress:

- IpProtocol: tcp

FromPort: 22

ToPort: 22

CidrIp: !Ref AllowedBootstrapSshCidr

- IpProtocol: tcp

ToPort: 19531

FromPort: 19531

CidrIp: 0.0.0.0/0

VpcId: !Ref VpcId

```

BootstrapInstance:
  Type: AWS::EC2::Instance
  Properties:
    ImageId: !Ref RhcosAmi
    IamInstanceProfile: !Ref BootstrapInstanceProfile
    InstanceType: !Ref BootstrapInstanceType
    NetworkInterfaces:
      - AssociatePublicIpAddress: "true"
        DeviceIndex: "0"
        GroupSet:
          - !Ref "BootstrapSecurityGroup"
          - !Ref "MasterSecurityGroupId"
        SubnetId: !Ref "PublicSubnet"
    UserData:
      Fn::Base64: !Sub
        - '{"ignition":{"config":{"replace":{"source":"${S3Loc}"}},"version":"3.1.0"}}'
        - {
            S3Loc: !Ref BootstrapIgnitionLocation
          }

```

```

RegisterBootstrapApiTarget:
  Condition: DoRegistration
  Type: Custom::NLBRegister
  Properties:
    ServiceToken: !Ref RegisterNlbTargetsLambdaArn
    TargetArn: !Ref ExternalApiTargetGroupArn
    TargetIp: !GetAtt BootstrapInstance.PrivateIp

```

```

RegisterBootstrapInternalApiTarget:
  Condition: DoRegistration
  Type: Custom::NLBRegister
  Properties:
    ServiceToken: !Ref RegisterNlbTargetsLambdaArn
    TargetArn: !Ref InternalApiTargetGroupArn
    TargetIp: !GetAtt BootstrapInstance.PrivateIp

```

```

RegisterBootstrapInternalServiceTarget:
  Condition: DoRegistration
  Type: Custom::NLBRegister
  Properties:
    ServiceToken: !Ref RegisterNlbTargetsLambdaArn
    TargetArn: !Ref InternalServiceTargetGroupArn
    TargetIp: !GetAtt BootstrapInstance.PrivateIp

```

```

Outputs:
BootstrapInstanceid:
  Description: Bootstrap Instance ID.
  Value: !Ref BootstrapInstance

```

```

BootstrapPublicIp:
  Description: The bootstrap node public IP address.
  Value: !GetAtt BootstrapInstance.PublicIp

```

**BootstrapPrivatelP:**  
 Description: The bootstrap node private IP address.  
 Value: !GetAtt BootstrapInstance.PrivatelP

### Additional resources

- You can view details about the CloudFormation stacks that you create by navigating to the [AWS CloudFormation console](#).
- See [RHCOS AMIs for the AWS infrastructure](#) for details about the Red Hat Enterprise Linux CoreOS (RHCOS) AMIs for the AWS zones.

## 5.13.16. Creating the control plane machines in AWS

You must create the control plane machines in Amazon Web Services (AWS) that your cluster will use.

You can use the provided CloudFormation template and a custom parameter file to create a stack of AWS resources that represent the control plane nodes.



### IMPORTANT

The CloudFormation template creates a stack that represents three control plane nodes.



### NOTE

If you do not use the provided CloudFormation template to create your control plane nodes, you must review the provided information and manually create the infrastructure. If your cluster does not initialize correctly, you might have to contact Red Hat support with your installation logs.

### Prerequisites

- You configured an AWS account.
- You added your AWS keys and region to your local AWS profile by running **aws configure**.
- You generated the Ignition config files for your cluster.
- You created and configured a VPC and associated subnets in AWS.
- You created and configured DNS, load balancers, and listeners in AWS.
- You created the security groups and roles required for your cluster in AWS.
- You created the bootstrap machine.

### Procedure

1. Create a JSON file that contains the parameter values that the template requires:

```
[
  {
    "ParameterKey": "InfrastructureName", 1
```

```

    "ParameterValue": "mycluster-<random_string>" 2
  },
  {
    "ParameterKey": "RhcoshAmi", 3
    "ParameterValue": "ami-<random_string>" 4
  },
  {
    "ParameterKey": "AutoRegisterDNS", 5
    "ParameterValue": "yes" 6
  },
  {
    "ParameterKey": "PrivateHostedZoneId", 7
    "ParameterValue": "<random_string>" 8
  },
  {
    "ParameterKey": "PrivateHostedZoneName", 9
    "ParameterValue": "mycluster.example.com" 10
  },
  {
    "ParameterKey": "Master0Subnet", 11
    "ParameterValue": "subnet-<random_string>" 12
  },
  {
    "ParameterKey": "Master1Subnet", 13
    "ParameterValue": "subnet-<random_string>" 14
  },
  {
    "ParameterKey": "Master2Subnet", 15
    "ParameterValue": "subnet-<random_string>" 16
  },
  {
    "ParameterKey": "MasterSecurityGroupID", 17
    "ParameterValue": "sg-<random_string>" 18
  },
  {
    "ParameterKey": "IgnitionLocation", 19
    "ParameterValue": "https://api-int.<cluster_name>.<domain_name>:22623/config/master"
  } 20
  {
    "ParameterKey": "CertificateAuthorities", 21
    "ParameterValue": "data:text/plain;charset=utf-8;base64,ABC...xYz==" 22
  },
  {
    "ParameterKey": "MasterInstanceProfileName", 23
    "ParameterValue": "<roles_stack>-MasterInstanceProfile-<random_string>" 24
  },
  {
    "ParameterKey": "MasterInstanceType", 25
    "ParameterValue": "m6i.xlarge" 26
  },
  {
    "ParameterKey": "AutoRegisterELB", 27

```

```

    "ParameterValue": "yes" 28
  },
  {
    "ParameterKey": "RegisterNlbTargetsLambdaArn", 29
    "ParameterValue": "arn:aws:lambda:<region>:<account_number>:function:
<dns_stack_name>-RegisterNlbTargets-<random_string>" 30
  },
  {
    "ParameterKey": "ExternalApiTargetGroupArn", 31
    "ParameterValue": "arn:aws:elasticloadbalancing:<region>:
<account_number>:targetgroup/<dns_stack_name>-Exter-<random_string>" 32
  },
  {
    "ParameterKey": "InternalApiTargetGroupArn", 33
    "ParameterValue": "arn:aws:elasticloadbalancing:<region>:
<account_number>:targetgroup/<dns_stack_name>-Inter-<random_string>" 34
  },
  {
    "ParameterKey": "InternalServiceTargetGroupArn", 35
    "ParameterValue": "arn:aws:elasticloadbalancing:<region>:
<account_number>:targetgroup/<dns_stack_name>-Inter-<random_string>" 36
  }
]

```

- 1 The name for your cluster infrastructure that is encoded in your Ignition config files for the cluster.
- 2 Specify the infrastructure name that you extracted from the Ignition config file metadata, which has the format **<cluster-name>-<random-string>**.
- 3 Current Red Hat Enterprise Linux CoreOS (RHCOS) AMI to use for the control plane machines.
- 4 Specify an **AWS::EC2::Image::Id** value.
- 5 Whether or not to perform DNS etcd registration.
- 6 Specify **yes** or **no**. If you specify **yes**, you must provide hosted zone information.
- 7 The Route 53 private zone ID to register the etcd targets with.
- 8 Specify the **PrivateHostedZoneId** value from the output of the CloudFormation template for DNS and load balancing.
- 9 The Route 53 zone to register the targets with.
- 10 Specify **<cluster\_name>.<domain\_name>** where **<domain\_name>** is the Route 53 base domain that you used when you generated **install-config.yaml** file for the cluster. Do not include the trailing period (.) that is displayed in the AWS console.
- 11 13 15 A subnet, preferably private, to launch the control plane machines on.
- 12 14 16 Specify a subnet from the **PrivateSubnets** value from the output of the CloudFormation template for DNS and load balancing.



- 17 The master security group ID to associate with control plane nodes.
  - 18 Specify the **MasterSecurityGroupid** value from the output of the CloudFormation template for the security group and roles.
  - 19 The location to fetch control plane Ignition config file from.
  - 20 Specify the generated Ignition config file location, [https://api-int.<cluster\\_name>.<domain\\_name>:22623/config/master](https://api-int.<cluster_name>.<domain_name>:22623/config/master).
  - 21 The base64 encoded certificate authority string to use.
  - 22 Specify the value from the **master.ign** file that is in the installation directory. This value is the long string with the format **data:text/plain;charset=utf-8;base64,ABC...xYz==**.
  - 23 The IAM profile to associate with control plane nodes.
  - 24 Specify the **MasterInstanceProfile** parameter value from the output of the CloudFormation template for the security group and roles.
  - 25 The type of AWS instance to use for the control plane machines.
  - 26 The instance type value corresponds to the minimum resource requirements for control plane machines.
  - 27 Whether or not to register a network load balancer (NLB).
  - 28 Specify **yes** or **no**. If you specify **yes**, you must provide a Lambda Amazon Resource Name (ARN) value.
  - 29 The ARN for NLB IP target registration lambda group.
  - 30 Specify the **RegisterNlbTargetsLambda** value from the output of the CloudFormation template for DNS and load balancing. Use **arn:aws-us-gov** if deploying the cluster to an AWS GovCloud region.
  - 31 The ARN for external API load balancer target group.
  - 32 Specify the **ExternalApiTargetGroupArn** value from the output of the CloudFormation template for DNS and load balancing. Use **arn:aws-us-gov** if deploying the cluster to an AWS GovCloud region.
  - 33 The ARN for internal API load balancer target group.
  - 34 Specify the **InternalApiTargetGroupArn** value from the output of the CloudFormation template for DNS and load balancing. Use **arn:aws-us-gov** if deploying the cluster to an AWS GovCloud region.
  - 35 The ARN for internal service load balancer target group.
  - 36 Specify the **InternalServiceTargetGroupArn** value from the output of the CloudFormation template for DNS and load balancing. Use **arn:aws-us-gov** if deploying the cluster to an AWS GovCloud region.
2. Copy the template from the **CloudFormation template for control plane machines** section of this topic and save it as a YAML file on your computer. This template describes the control plane machines that your cluster requires.

- If you specified an **m5** instance type as the value for **MasterInstanceType**, add that instance type to the **MasterInstanceType.AllowedValues** parameter in the CloudFormation template.
- Launch the CloudFormation template to create a stack of AWS resources that represent the control plane nodes:

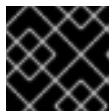

### IMPORTANT

You must enter the command on a single line.

```
$ aws cloudformation create-stack --stack-name <name> 1
  --template-body file://<template>.yaml 2
  --parameters file://<parameters>.json 3
```

- 1** **<name>** is the name for the CloudFormation stack, such as **cluster-control-plane**. You need the name of this stack if you remove the cluster.
- 2** **<template>** is the relative path to and name of the CloudFormation template YAML file that you saved.
- 3** **<parameters>** is the relative path to and name of the CloudFormation parameters JSON file.

### Example output

```
arn:aws:cloudformation:us-east-1:269333783861:stack/cluster-control-plane/21c7e2b0-2ee2-11eb-c6f6-0aa34627df4b
```



### NOTE

The CloudFormation template creates a stack that represents three control plane nodes.

- Confirm that the template components exist:

```
$ aws cloudformation describe-stacks --stack-name <name>
```

#### 5.13.16.1. CloudFormation template for control plane machines

You can use the following CloudFormation template to deploy the control plane machines that you need for your OpenShift Container Platform cluster.

##### Example 5.48. CloudFormation template for control plane machines

```
AWSTemplateFormatVersion: 2010-09-09
Description: Template for OpenShift Cluster Node Launch (EC2 master instances)

Parameters:
  InfrastructureName:
    AllowedPattern: ^([a-zA-Z][a-zA-Z0-9\-\_]{0,26})$
    MaxLength: 27
```

MinLength: 1

ConstraintDescription: Infrastructure name must be alphanumeric, start with a letter, and have a maximum of 27 characters.

Description: A short, unique cluster ID used to tag nodes for the kubelet cloud provider.

Type: String

RhcosAmi:

Description: Current Red Hat Enterprise Linux CoreOS AMI to use for bootstrap.

Type: AWS::EC2::Image::Id

AutoRegisterDNS:

Default: "yes"

AllowedValues:

- "yes"

- "no"

Description: Do you want to invoke DNS etcd registration, which requires Hosted Zone information?

Type: String

PrivateHostedZoneId:

Description: The Route53 private zone ID to register the etcd targets with, such as Z21IXYZABCZ2A4.

Type: String

PrivateHostedZoneName:

Description: The Route53 zone to register the targets with, such as cluster.example.com. Omit the trailing period.

Type: String

Master0Subnet:

Description: The subnets, recommend private, to launch the master nodes into.

Type: AWS::EC2::Subnet::Id

Master1Subnet:

Description: The subnets, recommend private, to launch the master nodes into.

Type: AWS::EC2::Subnet::Id

Master2Subnet:

Description: The subnets, recommend private, to launch the master nodes into.

Type: AWS::EC2::Subnet::Id

MasterSecurityGroupId:

Description: The master security group ID to associate with master nodes.

Type: AWS::EC2::SecurityGroup::Id

IgnitionLocation:

Default: [https://api-int.\\$CLUSTER\\_NAME.\\$DOMAIN:22623/config/master](https://api-int.$CLUSTER_NAME.$DOMAIN:22623/config/master)

Description: Ignition config file location.

Type: String

CertificateAuthorities:

Default: data:text/plain;charset=utf-8;base64,ABC...xYz==

Description: Base64 encoded certificate authority string to use.

Type: String

MasterInstanceProfileName:

Description: IAM profile to associate with master nodes.

Type: String

MasterInstanceType:

Default: m5.xlarge

Type: String

AutoRegisterELB:

Default: "yes"

AllowedValues:

- "yes"

- "no"

Description: Do you want to invoke NLB registration, which requires a Lambda ARN parameter?

Type: String

RegisterNlbTargetsLambdaArn:

Description: ARN for NLB IP target registration lambda. Supply the value from the cluster infrastructure or select "no" for AutoRegisterELB.

Type: String

ExternalApiTargetGroupArn:

Description: ARN for external API load balancer target group. Supply the value from the cluster infrastructure or select "no" for AutoRegisterELB.

Type: String

InternalApiTargetGroupArn:

Description: ARN for internal API load balancer target group. Supply the value from the cluster infrastructure or select "no" for AutoRegisterELB.

Type: String

InternalServiceTargetGroupArn:

Description: ARN for internal service load balancer target group. Supply the value from the cluster infrastructure or select "no" for AutoRegisterELB.

Type: String

Metadata:

AWS::CloudFormation::Interface:

ParameterGroups:

- Label:

default: "Cluster Information"

Parameters:

- InfrastructureName

- Label:

default: "Host Information"

Parameters:

- MasterInstanceType

- RhcosAmi

- IgnitionLocation

- CertificateAuthorities

- MasterSecurityGroupId

- MasterInstanceProfileName

- Label:

default: "Network Configuration"

Parameters:

- VpcId

- AllowedBootstrapSshCidr

- Master0Subnet

- Master1Subnet

- Master2Subnet

- Label:

default: "DNS"

Parameters:

- AutoRegisterDNS

- PrivateHostedZoneName

- PrivateHostedZoneId

- Label:

default: "Load Balancer Automation"

Parameters:

- AutoRegisterELB

- RegisterNlbTargetsLambdaArn

- ExternalApiTargetGroupArn

- InternalApiTargetGroupArn

```

- InternalServiceTargetGroupArn
ParameterLabels:
  InfrastructureName:
    default: "Infrastructure Name"
  VpcId:
    default: "VPC ID"
  Master0Subnet:
    default: "Master-0 Subnet"
  Master1Subnet:
    default: "Master-1 Subnet"
  Master2Subnet:
    default: "Master-2 Subnet"
  MasterInstanceType:
    default: "Master Instance Type"
  MasterInstanceProfileName:
    default: "Master Instance Profile Name"
  RhcosAmi:
    default: "Red Hat Enterprise Linux CoreOS AMI ID"
  BootstrapIgnitionLocation:
    default: "Master Ignition Source"
  CertificateAuthorities:
    default: "Ignition CA String"
  MasterSecurityGroupId:
    default: "Master Security Group ID"
  AutoRegisterDNS:
    default: "Use Provided DNS Automation"
  AutoRegisterELB:
    default: "Use Provided ELB Automation"
  PrivateHostedZoneName:
    default: "Private Hosted Zone Name"
  PrivateHostedZoneId:
    default: "Private Hosted Zone ID"

```

Conditions:

```

DoRegistration: !Equals ["yes", !Ref AutoRegisterELB]
DoDns: !Equals ["yes", !Ref AutoRegisterDNS]

```

Resources:

```

Master0:
  Type: AWS::EC2::Instance
  Properties:
    ImageId: !Ref RhcosAmi
    BlockDeviceMappings:
      - DeviceName: /dev/xvda
        Ebs:
          VolumeSize: "120"
          VolumeType: "gp2"
    IamInstanceProfile: !Ref MasterInstanceProfileName
    InstanceType: !Ref MasterInstanceType
    NetworkInterfaces:
      - AssociatePublicIpAddress: "false"
        DeviceIndex: "0"
        GroupSet:
          - !Ref "MasterSecurityGroupId"
        SubnetId: !Ref "Master0Subnet"
  UserData:

```

```

Fn::Base64: !Sub
- '{"ignition":{"config":{"merge":{"source":"${SOURCE}"},"security":{"tls":
{"certificateAuthorities":[{"source":"${CA_BUNDLE}"]}}},"version":"3.1.0"}}'
- {
  SOURCE: !Ref IgnitionLocation,
  CA_BUNDLE: !Ref CertificateAuthorities,
}
Tags:
- Key: !Join [ "", ["kubernetes.io/cluster/", !Ref InfrastructureName]]
  Value: "shared"

```

#### RegisterMaster0:

```

Condition: DoRegistration
Type: Custom::NLBRegister
Properties:
  ServiceToken: !Ref RegisterNlbTargetsLambdaArn
  TargetArn: !Ref ExternalApiTargetGroupArn
  TargetIp: !GetAtt Master0.PrivateIp

```

#### RegisterMaster0InternalApiTarget:

```

Condition: DoRegistration
Type: Custom::NLBRegister
Properties:
  ServiceToken: !Ref RegisterNlbTargetsLambdaArn
  TargetArn: !Ref InternalApiTargetGroupArn
  TargetIp: !GetAtt Master0.PrivateIp

```

#### RegisterMaster0InternalServiceTarget:

```

Condition: DoRegistration
Type: Custom::NLBRegister
Properties:
  ServiceToken: !Ref RegisterNlbTargetsLambdaArn
  TargetArn: !Ref InternalServiceTargetGroupArn
  TargetIp: !GetAtt Master0.PrivateIp

```

#### Master1:

```

Type: AWS::EC2::Instance
Properties:
  ImageId: !Ref RHCOSAmi
  BlockDeviceMappings:
  - DeviceName: /dev/xvda
    Ebs:
      VolumeSize: "120"
      VolumeType: "gp2"
  IamInstanceProfile: !Ref MasterInstanceProfileName
  InstanceType: !Ref MasterInstanceType
  NetworkInterfaces:
  - AssociatePublicIp: "false"
    DeviceIndex: "0"
    GroupSet:
    - !Ref "MasterSecurityGroupId"
    SubnetId: !Ref "Master1Subnet"
  UserData:
    Fn::Base64: !Sub
      - '{"ignition":{"config":{"merge":{"source":"${SOURCE}"},"security":{"tls":
{"certificateAuthorities":[{"source":"${CA_BUNDLE}"]}}},"version":"3.1.0"}}'

```

```

- {
  SOURCE: !Ref IgnitionLocation,
  CA_BUNDLE: !Ref CertificateAuthorities,
}
Tags:
- Key: !Join [ "", ["kubernetes.io/cluster/", !Ref InfrastructureName]]
  Value: "shared"

RegisterMaster1:
  Condition: DoRegistration
  Type: Custom::NLBRegister
  Properties:
    ServiceToken: !Ref RegisterNlbTargetsLambdaArn
    TargetArn: !Ref ExternalApiTargetGroupArn
    TargetIp: !GetAtt Master1.PrivateIp

RegisterMaster1InternalApiTarget:
  Condition: DoRegistration
  Type: Custom::NLBRegister
  Properties:
    ServiceToken: !Ref RegisterNlbTargetsLambdaArn
    TargetArn: !Ref InternalApiTargetGroupArn
    TargetIp: !GetAtt Master1.PrivateIp

RegisterMaster1InternalServiceTarget:
  Condition: DoRegistration
  Type: Custom::NLBRegister
  Properties:
    ServiceToken: !Ref RegisterNlbTargetsLambdaArn
    TargetArn: !Ref InternalServiceTargetGroupArn
    TargetIp: !GetAtt Master1.PrivateIp

Master2:
  Type: AWS::EC2::Instance
  Properties:
    ImageId: !Ref RhcosAmi
    BlockDeviceMappings:
    - DeviceName: /dev/xvda
      Ebs:
        VolumeSize: "120"
        VolumeType: "gp2"
    IamInstanceProfile: !Ref MasterInstanceProfileName
    InstanceType: !Ref MasterInstanceType
    NetworkInterfaces:
    - AssociatePublicIpAddress: "false"
      DeviceIndex: "0"
      GroupSet:
      - !Ref "MasterSecurityGroupId"
      SubnetId: !Ref "Master2Subnet"
    UserData:
      Fn::Base64: !Sub
      - '{"ignition":{"config":{"merge":[{"source":"${SOURCE}"}]},"security":{"tls":
{"certificateAuthorities":[{"source":"${CA_BUNDLE}"}]},"version":"3.1.0"}}'
      - {
        SOURCE: !Ref IgnitionLocation,
        CA_BUNDLE: !Ref CertificateAuthorities,

```

```

    }
    Tags:
    - Key: !Join [ "", ["kubernetes.io/cluster/", !Ref InfrastructureName]]
      Value: "shared"

RegisterMaster2:
  Condition: DoRegistration
  Type: Custom::NLBRegister
  Properties:
    ServiceToken: !Ref RegisterNlbTargetsLambdaArn
    TargetArn: !Ref ExternalApiTargetGroupArn
    TargetIp: !GetAtt Master2.PrivateIp

RegisterMaster2InternalApiTarget:
  Condition: DoRegistration
  Type: Custom::NLBRegister
  Properties:
    ServiceToken: !Ref RegisterNlbTargetsLambdaArn
    TargetArn: !Ref InternalApiTargetGroupArn
    TargetIp: !GetAtt Master2.PrivateIp

RegisterMaster2InternalServiceTarget:
  Condition: DoRegistration
  Type: Custom::NLBRegister
  Properties:
    ServiceToken: !Ref RegisterNlbTargetsLambdaArn
    TargetArn: !Ref InternalServiceTargetGroupArn
    TargetIp: !GetAtt Master2.PrivateIp

EtcDsrvRecords:
  Condition: DoDns
  Type: AWS::Route53::RecordSet
  Properties:
    HostedZoneId: !Ref PrivateHostedZoneId
    Name: !Join [ ".", ["_etcd-server-ssl._tcp", !Ref PrivateHostedZoneName]]
    ResourceRecords:
    - !Join [
      " ",
      ["0 10 2380", !Join [ ".", ["etcd-0", !Ref PrivateHostedZoneName]]],
    ]
    - !Join [
      " ",
      ["0 10 2380", !Join [ ".", ["etcd-1", !Ref PrivateHostedZoneName]]],
    ]
    - !Join [
      " ",
      ["0 10 2380", !Join [ ".", ["etcd-2", !Ref PrivateHostedZoneName]]],
    ]
    TTL: 60
    Type: SRV

EtcD0Record:
  Condition: DoDns
  Type: AWS::Route53::RecordSet
  Properties:
    HostedZoneId: !Ref PrivateHostedZoneId

```



```
Name: !Join [".", ["etcd-0", !Ref PrivateHostedZoneName]]
ResourceRecords:
- !GetAtt Master0.PrivateIp
TTL: 60
Type: A
```

```
Etcd1Record:
Condition: DoDns
Type: AWS::Route53::RecordSet
Properties:
HostedZoneId: !Ref PrivateHostedZoneId
Name: !Join [".", ["etcd-1", !Ref PrivateHostedZoneName]]
ResourceRecords:
- !GetAtt Master1.PrivateIp
TTL: 60
Type: A
```

```
Etcd2Record:
Condition: DoDns
Type: AWS::Route53::RecordSet
Properties:
HostedZoneId: !Ref PrivateHostedZoneId
Name: !Join [".", ["etcd-2", !Ref PrivateHostedZoneName]]
ResourceRecords:
- !GetAtt Master2.PrivateIp
TTL: 60
Type: A
```

```
Outputs:
PrivateIPs:
Description: The control-plane node private IP addresses.
Value:
!Join [
  ",",
  [!GetAtt Master0.PrivateIp, !GetAtt Master1.PrivateIp, !GetAtt Master2.PrivateIp]
]
```

### Additional resources

- You can view details about the CloudFormation stacks that you create by navigating to the [AWS CloudFormation console](#).

### 5.13.17. Creating the worker nodes in AWS

You can create worker nodes in Amazon Web Services (AWS) for your cluster to use.

You can use the provided CloudFormation template and a custom parameter file to create a stack of AWS resources that represent a worker node.

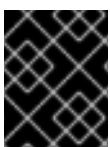

#### IMPORTANT

The CloudFormation template creates a stack that represents one worker node. You must create a stack for each worker node.



## NOTE

If you do not use the provided CloudFormation template to create your worker nodes, you must review the provided information and manually create the infrastructure. If your cluster does not initialize correctly, you might have to contact Red Hat support with your installation logs.

## Prerequisites

- You configured an AWS account.
- You added your AWS keys and region to your local AWS profile by running **aws configure**.
- You generated the Ignition config files for your cluster.
- You created and configured a VPC and associated subnets in AWS.
- You created and configured DNS, load balancers, and listeners in AWS.
- You created the security groups and roles required for your cluster in AWS.
- You created the bootstrap machine.
- You created the control plane machines.

## Procedure

1. Create a JSON file that contains the parameter values that the CloudFormation template requires:

```
[
  {
    "ParameterKey": "InfrastructureName", 1
    "ParameterValue": "mycluster-<random_string>" 2
  },
  {
    "ParameterKey": "RhcocAmi", 3
    "ParameterValue": "ami-<random_string>" 4
  },
  {
    "ParameterKey": "Subnet", 5
    "ParameterValue": "subnet-<random_string>" 6
  },
  {
    "ParameterKey": "WorkerSecurityGroupld", 7
    "ParameterValue": "sg-<random_string>" 8
  },
  {
    "ParameterKey": "IgnitionLocation", 9
    "ParameterValue": "https://api-int.<cluster_name>.<domain_name>:22623/config/worker"
  },
  {
    "ParameterKey": "CertificateAuthorities", 11
    "ParameterValue": "" 12
  }
]
```

```

    },
    {
      "ParameterKey": "WorkerInstanceProfileName", 13
      "ParameterValue": "" 14
    },
    {
      "ParameterKey": "WorkerInstanceType", 15
      "ParameterValue": "m6i.large" 16
    }
  ]

```

- 1 The name for your cluster infrastructure that is encoded in your Ignition config files for the cluster.
  - 2 Specify the infrastructure name that you extracted from the Ignition config file metadata, which has the format **<cluster-name>-<random-string>**.
  - 3 Current Red Hat Enterprise Linux CoreOS (RHCOS) AMI to use for the worker nodes.
  - 4 Specify an **AWS::EC2::Image::Id** value.
  - 5 A subnet, preferably private, to start the worker nodes on.
  - 6 Specify a subnet from the **PrivateSubnets** value from the output of the CloudFormation template for DNS and load balancing.
  - 7 The worker security group ID to associate with worker nodes.
  - 8 Specify the **WorkerSecurityGroupId** value from the output of the CloudFormation template for the security group and roles.
  - 9 The location to fetch the bootstrap Ignition config file from.
  - 10 Specify the generated Ignition config location, [https://api-int.<cluster\\_name>.<domain\\_name>:22623/config/worker](https://api-int.<cluster_name>.<domain_name>:22623/config/worker).
  - 11 Base64 encoded certificate authority string to use.
  - 12 Specify the value from the **worker.ign** file that is in the installation directory. This value is the long string with the format **data:text/plain;charset=utf-8;base64,ABC...xYz==**.
  - 13 The IAM profile to associate with worker nodes.
  - 14 Specify the **WorkerInstanceProfile** parameter value from the output of the CloudFormation template for the security group and roles.
  - 15 The type of AWS instance to use for the compute machines.
  - 16 The instance type value corresponds to the minimum resource requirements for compute machines.
2. Copy the template from the **CloudFormation template for worker machines** section of this topic and save it as a YAML file on your computer. This template describes the networking objects and load balancers that your cluster requires.

- Optional: If you specified an **m5** instance type as the value for **WorkerInstanceType**, add that instance type to the **WorkerInstanceType.AllowedValues** parameter in the CloudFormation template.
- Optional: If you are deploying with an AWS Marketplace image, update the **Worker0.type.properties.ImageID** parameter with the AMI ID that you obtained from your subscription.
- Use the CloudFormation template to create a stack of AWS resources that represent a worker node:

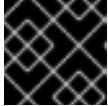
**IMPORTANT**

You must enter the command on a single line.

```
$ aws cloudformation create-stack --stack-name <name> 1
  --template-body file://<template>.yaml \ 2
  --parameters file://<parameters>.json 3
```

- 1** **<name>** is the name for the CloudFormation stack, such as **cluster-worker-1**. You need the name of this stack if you remove the cluster.
- 2** **<template>** is the relative path to and name of the CloudFormation template YAML file that you saved.
- 3** **<parameters>** is the relative path to and name of the CloudFormation parameters JSON file.

**Example output**

```
arn:aws:cloudformation:us-east-1:269333783861:stack/cluster-worker-1/729ee301-1c2a-11eb-348f-sd9888c65b59
```

**NOTE**

The CloudFormation template creates a stack that represents one worker node.

- Confirm that the template components exist:

```
$ aws cloudformation describe-stacks --stack-name <name>
```

- Continue to create worker stacks until you have created enough worker machines for your cluster. You can create additional worker stacks by referencing the same template and parameter files and specifying a different stack name.

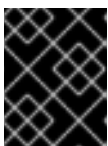
**IMPORTANT**

You must create at least two worker machines, so you must create at least two stacks that use this CloudFormation template.

**5.13.17.1. CloudFormation template for worker machines**

You can use the following CloudFormation template to deploy the worker machines that you need for your OpenShift Container Platform cluster.

#### Example 5.49. CloudFormation template for worker machines

```

AWSTemplateFormatVersion: 2010-09-09
Description: Template for OpenShift Cluster Node Launch (EC2 worker instance)

Parameters:
  InfrastructureName:
    AllowedPattern: ^([a-zA-Z][a-zA-Z0-9\-\]{0,26})$
    MaxLength: 27
    MinLength: 1
    ConstraintDescription: Infrastructure name must be alphanumeric, start with a letter, and have a
maximum of 27 characters.
    Description: A short, unique cluster ID used to tag nodes for the kubelet cloud provider.
    Type: String
  RhcosAmi:
    Description: Current Red Hat Enterprise Linux CoreOS AMI to use for bootstrap.
    Type: AWS::EC2::Image::Id
  Subnet:
    Description: The subnets, recommend private, to launch the master nodes into.
    Type: AWS::EC2::Subnet::Id
  WorkerSecurityGroupId:
    Description: The master security group ID to associate with master nodes.
    Type: AWS::EC2::SecurityGroup::Id
  IgnitionLocation:
    Default: https://api-int.$CLUSTER_NAME.$DOMAIN:22623/config/worker
    Description: Ignition config file location.
    Type: String
  CertificateAuthorities:
    Default: data:text/plain;charset=utf-8;base64,ABC...xYz==
    Description: Base64 encoded certificate authority string to use.
    Type: String
  WorkerInstanceProfileName:
    Description: IAM profile to associate with master nodes.
    Type: String
  WorkerInstanceType:
    Default: m5.large
    Type: String

Metadata:
  AWS::CloudFormation::Interface:
    ParameterGroups:
      - Label:
          default: "Cluster Information"
        Parameters:
          - InfrastructureName
      - Label:
          default: "Host Information"
        Parameters:
          - WorkerInstanceType
          - RhcosAmi
          - IgnitionLocation
          - CertificateAuthorities
          - WorkerSecurityGroupId
  
```

```

- WorkerInstanceProfileName
- Label:
  default: "Network Configuration"
Parameters:
- Subnet
ParameterLabels:
Subnet:
  default: "Subnet"
InfrastructureName:
  default: "Infrastructure Name"
WorkerInstanceType:
  default: "Worker Instance Type"
WorkerInstanceProfileName:
  default: "Worker Instance Profile Name"
RhcosAmi:
  default: "Red Hat Enterprise Linux CoreOS AMI ID"
IgnitionLocation:
  default: "Worker Ignition Source"
CertificateAuthorities:
  default: "Ignition CA String"
WorkerSecurityGroupId:
  default: "Worker Security Group ID"

Resources:
Worker0:
  Type: AWS::EC2::Instance
  Properties:
    ImageId: !Ref RhcosAmi
    BlockDeviceMappings:
      - DeviceName: /dev/xvda
        Ebs:
          VolumeSize: "120"
          VolumeType: "gp2"
    IamInstanceProfile: !Ref WorkerInstanceProfileName
    InstanceType: !Ref WorkerInstanceType
    NetworkInterfaces:
      - AssociatePublicIpAddress: "false"
        DeviceIndex: "0"
        GroupSet:
          - !Ref "WorkerSecurityGroupId"
        SubnetId: !Ref "Subnet"
    UserData:
      Fn::Base64: !Sub
        - {"ignition":{"config":{"merge":[{"source":"${SOURCE}"]},"security":{"tls":
{"certificateAuthorities":[{"source":"${CA_BUNDLE}"]},"version":"3.1.0"}}}
        - {
          SOURCE: !Ref IgnitionLocation,
          CA_BUNDLE: !Ref CertificateAuthorities,
        }
    Tags:
      - Key: !Join [ "", ["kubernetes.io/cluster/", !Ref InfrastructureName] ]
        Value: "shared"

Outputs:

```

PrivateIP:

Description: The compute node private IP address.

Value: !GetAtt Worker0.PrivateIp

### Additional resources

- You can view details about the CloudFormation stacks that you create by navigating to the [AWS CloudFormation console](#).

## 5.13.18. Initializing the bootstrap sequence on AWS with user-provisioned infrastructure

After you create all of the required infrastructure in Amazon Web Services (AWS), you can start the bootstrap sequence that initializes the OpenShift Container Platform control plane.

### Prerequisites

- You configured an AWS account.
- You added your AWS keys and region to your local AWS profile by running **aws configure**.
- You generated the Ignition config files for your cluster.
- You created and configured a VPC and associated subnets in AWS.
- You created and configured DNS, load balancers, and listeners in AWS.
- You created the security groups and roles required for your cluster in AWS.
- You created the bootstrap machine.
- You created the control plane machines.
- You created the worker nodes.

### Procedure

1. Change to the directory that contains the installation program and start the bootstrap process that initializes the OpenShift Container Platform control plane:

```
$ ./openshift-install wait-for bootstrap-complete --dir <installation_directory> \ 1
--log-level=info 2
```

- 1 For **<installation\_directory>**, specify the path to the directory that you stored the installation files in.

- 2 To view different installation details, specify **warn**, **debug**, or **error** instead of **info**.

### Example output

```
INFO Waiting up to 20m0s for the Kubernetes API at
https://api.mycluster.example.com:6443...
```

```
INFO API v1.23.0 up
INFO Waiting up to 30m0s for bootstrapping to complete...
INFO It is now safe to remove the bootstrap resources
INFO Time elapsed: 1s
```

If the command exits without a **FATAL** warning, your OpenShift Container Platform control plane has initialized.



#### NOTE

After the control plane initializes, it sets up the compute nodes and installs additional services in the form of Operators.

#### Additional resources

- See [Monitoring installation progress](#) for details about monitoring the installation, bootstrap, and control plane logs as an OpenShift Container Platform installation progresses.
- See [Gathering bootstrap node diagnostic data](#) for information about troubleshooting issues related to the bootstrap process.
- You can view details about the running instances that are created by using the [AWS EC2 console](#).

### 5.13.19. Installing the OpenShift CLI by downloading the binary

You can install the OpenShift CLI (**oc**) to interact with OpenShift Container Platform from a command-line interface. You can install **oc** on Linux, Windows, or macOS.



#### IMPORTANT

If you installed an earlier version of **oc**, you cannot use it to complete all of the commands in OpenShift Container Platform 4.10. Download and install the new version of **oc**.

#### Installing the OpenShift CLI on Linux

You can install the OpenShift CLI (**oc**) binary on Linux by using the following procedure.

#### Procedure

1. Navigate to the [OpenShift Container Platform downloads page](#) on the Red Hat Customer Portal.
2. Select the appropriate version in the **Version** drop-down menu.
3. Click **Download Now** next to the **OpenShift v4.10 Linux Client** entry and save the file.
4. Unpack the archive:

```
$ tar xvf <file>
```

5. Place the **oc** binary in a directory that is on your **PATH**.  
To check your **PATH**, execute the following command:

```
$ echo $PATH
```



■

After you install the OpenShift CLI, it is available using the **oc** command:

```
$ oc <command>
```

### Installing the OpenShift CLI on Windows

You can install the OpenShift CLI (**oc**) binary on Windows by using the following procedure.

#### Procedure

1. Navigate to the [OpenShift Container Platform downloads page](#) on the Red Hat Customer Portal.
2. Select the appropriate version in the **Version** drop-down menu.
3. Click **Download Now** next to the **OpenShift v4.10 Windows Client** entry and save the file.
4. Unzip the archive with a ZIP program.
5. Move the **oc** binary to a directory that is on your **PATH**.  
To check your **PATH**, open the command prompt and execute the following command:

```
C:\> path
```

After you install the OpenShift CLI, it is available using the **oc** command:

```
C:\> oc <command>
```

### Installing the OpenShift CLI on macOS

You can install the OpenShift CLI (**oc**) binary on macOS by using the following procedure.

#### Procedure

1. Navigate to the [OpenShift Container Platform downloads page](#) on the Red Hat Customer Portal.
2. Select the appropriate version in the **Version** drop-down menu.
3. Click **Download Now** next to the **OpenShift v4.10 MacOSX Client** entry and save the file.
4. Unpack and unzip the archive.
5. Move the **oc** binary to a directory on your **PATH**.  
To check your **PATH**, open a terminal and execute the following command:

```
$ echo $PATH
```

After you install the OpenShift CLI, it is available using the **oc** command:

```
$ oc <command>
```

## 5.13.20. Logging in to the cluster by using the CLI

You can log in to your cluster as a default system user by exporting the cluster **kubeconfig** file. The **kubeconfig** file contains information about the cluster that is used by the CLI to connect a client to the correct cluster and API server. The file is specific to a cluster and is created during OpenShift Container Platform installation.

### Prerequisites

- You deployed an OpenShift Container Platform cluster.
- You installed the **oc** CLI.

### Procedure

1. Export the **kubeadmin** credentials:

```
$ export KUBECONFIG=<installation_directory>/auth/kubeconfig 1
```

- 1** For **<installation\_directory>**, specify the path to the directory that you stored the installation files in.

2. Verify you can run **oc** commands successfully using the exported configuration:

```
$ oc whoami
```

#### Example output

```
system:admin
```

## 5.13.21. Approving the certificate signing requests for your machines

When you add machines to a cluster, two pending certificate signing requests (CSRs) are generated for each machine that you added. You must confirm that these CSRs are approved or, if necessary, approve them yourself. The client requests must be approved first, followed by the server requests.

### Prerequisites

- You added machines to your cluster.

### Procedure

1. Confirm that the cluster recognizes the machines:

```
$ oc get nodes
```

#### Example output

```
NAME      STATUS  ROLES  AGE  VERSION
master-0  Ready   master 63m  v1.23.0
master-1  Ready   master 63m  v1.23.0
master-2  Ready   master 64m  v1.23.0
```

The output lists all of the machines that you created.

**NOTE**

The preceding output might not include the compute nodes, also known as worker nodes, until some CSRs are approved.

- Review the pending CSRs and ensure that you see the client requests with the **Pending** or **Approved** status for each machine that you added to the cluster:

```
$ oc get csr
```

**Example output**

```
NAME      AGE      REQUESTOR                                     CONDITION
csr-8b2br 15m     system:serviceaccount:openshift-machine-config-operator:node-
bootstrapper Pending
csr-8vnps 15m     system:serviceaccount:openshift-machine-config-operator:node-
bootstrapper Pending
...
```

In this example, two machines are joining the cluster. You might see more approved CSRs in the list.

- If the CSRs were not approved, after all of the pending CSRs for the machines you added are in **Pending** status, approve the CSRs for your cluster machines:

**NOTE**

Because the CSRs rotate automatically, approve your CSRs within an hour of adding the machines to the cluster. If you do not approve them within an hour, the certificates will rotate, and more than two certificates will be present for each node. You must approve all of these certificates. After the client CSR is approved, the Kubelet creates a secondary CSR for the serving certificate, which requires manual approval. Then, subsequent serving certificate renewal requests are automatically approved by the **machine-approver** if the Kubelet requests a new certificate with identical parameters.

**NOTE**

For clusters running on platforms that are not machine API enabled, such as bare metal and other user-provisioned infrastructure, you must implement a method of automatically approving the kubelet serving certificate requests (CSRs). If a request is not approved, then the **oc exec**, **oc rsh**, and **oc logs** commands cannot succeed, because a serving certificate is required when the API server connects to the kubelet. Any operation that contacts the Kubelet endpoint requires this certificate approval to be in place. The method must watch for new CSRs, confirm that the CSR was submitted by the **node-bootstrapper** service account in the **system:node** or **system:admin** groups, and confirm the identity of the node.

- To approve them individually, run the following command for each valid CSR:

```
$ oc adm certificate approve <csr_name> 1
```

1 **<csr\_name>** is the name of a CSR from the list of current CSRs.

- To approve all pending CSRs, run the following command:

```
$ oc get csr -o go-template='{{range .items}}{{if not .status}}{{.metadata.name}}{\n"}\n' | xargs --no-run-if-empty oc adm certificate approve
```

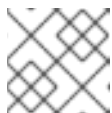

#### NOTE

Some Operators might not become available until some CSRs are approved.

- Now that your client requests are approved, you must review the server requests for each machine that you added to the cluster:

```
$ oc get csr
```

#### Example output

```
NAME      AGE   REQUESTOR                                     CONDITION
csr-bfd72 5m26s system:node:ip-10-0-50-126.us-east-2.compute.internal
Pending
csr-c57lv 5m26s system:node:ip-10-0-95-157.us-east-2.compute.internal
Pending
...
```

- If the remaining CSRs are not approved, and are in the **Pending** status, approve the CSRs for your cluster machines:

- To approve them individually, run the following command for each valid CSR:

```
$ oc adm certificate approve <csr_name> 1
```

1 **<csr\_name>** is the name of a CSR from the list of current CSRs.

- To approve all pending CSRs, run the following command:

```
$ oc get csr -o go-template='{{range .items}}{{if not .status}}{{.metadata.name}}{\n"}\n' | xargs oc adm certificate approve
```

- After all client and server CSRs have been approved, the machines have the **Ready** status. Verify this by running the following command:

```
$ oc get nodes
```

#### Example output

```
NAME      STATUS   ROLES    AGE   VERSION
master-0  Ready   master   73m   v1.23.0
master-1  Ready   master   73m   v1.23.0
```

```

master-2 Ready   master 74m v1.23.0
worker-0 Ready   worker 11m v1.23.0
worker-1 Ready   worker 11m v1.23.0

```



## NOTE

It can take a few minutes after approval of the server CSRs for the machines to transition to the **Ready** status.

### Additional information

- For more information on CSRs, see [Certificate Signing Requests](#).

### 5.13.22. Initial Operator configuration

After the control plane initializes, you must immediately configure some Operators so that they all become available.

#### Prerequisites

- Your control plane has initialized.

#### Procedure

1. Watch the cluster components come online:

```
$ watch -n5 oc get clusteroperators
```

#### Example output

NAME	VERSION	AVAILABLE	PROGRESSING	DEGRADED	SINCE
authentication	4.10.0	True	False	False	19m
baremetal	4.10.0	True	False	False	37m
cloud-credential	4.10.0	True	False	False	40m
cluster-autoscaler	4.10.0	True	False	False	37m
config-operator	4.10.0	True	False	False	38m
console	4.10.0	True	False	False	26m
csi-snapshot-controller	4.10.0	True	False	False	37m
dns	4.10.0	True	False	False	37m
etcd	4.10.0	True	False	False	36m
image-registry	4.10.0	True	False	False	31m
ingress	4.10.0	True	False	False	30m
insights	4.10.0	True	False	False	31m
kube-apiserver	4.10.0	True	False	False	26m
kube-controller-manager	4.10.0	True	False	False	36m
kube-scheduler	4.10.0	True	False	False	36m
kube-storage-version-migrator	4.10.0	True	False	False	37m
machine-api	4.10.0	True	False	False	29m
machine-approver	4.10.0	True	False	False	37m
machine-config	4.10.0	True	False	False	36m
marketplace	4.10.0	True	False	False	37m
monitoring	4.10.0	True	False	False	29m
network	4.10.0	True	False	False	38m

node-tuning	4.10.0	True	False	False	37m
openshift-apiserver	4.10.0	True	False	False	32m
openshift-controller-manager	4.10.0	True	False	False	30m
openshift-samples	4.10.0	True	False	False	32m
operator-lifecycle-manager	4.10.0	True	False	False	37m
operator-lifecycle-manager-catalog	4.10.0	True	False	False	37m
operator-lifecycle-manager-packageserver	4.10.0	True	False	False	32m
service-ca	4.10.0	True	False	False	38m
storage	4.10.0	True	False	False	37m

2. Configure the Operators that are not available.

### 5.13.22.1. Image registry storage configuration

Amazon Web Services provides default storage, which means the Image Registry Operator is available after installation. However, if the Registry Operator cannot create an S3 bucket and automatically configure storage, you must manually configure registry storage.

Instructions are shown for configuring a persistent volume, which is required for production clusters. Where applicable, instructions are shown for configuring an empty directory as the storage location, which is available for only non-production clusters.

Additional instructions are provided for allowing the image registry to use block storage types by using the **Recreate** rollout strategy during upgrades.

You can configure registry storage for user-provisioned infrastructure in AWS to deploy OpenShift Container Platform to hidden regions. See [Configuring the registry for AWS user-provisioned infrastructure](#) for more information.

#### 5.13.22.1.1. Configuring registry storage for AWS with user-provisioned infrastructure

During installation, your cloud credentials are sufficient to create an Amazon S3 bucket and the Registry Operator will automatically configure storage.

If the Registry Operator cannot create an S3 bucket and automatically configure storage, you can create an S3 bucket and configure storage with the following procedure.

#### Prerequisites

- You have a cluster on AWS with user-provisioned infrastructure.
- For Amazon S3 storage, the secret is expected to contain two keys:
  - **REGISTRY\_STORAGE\_S3\_ACCESSKEY**
  - **REGISTRY\_STORAGE\_S3\_SECRETKEY**

#### Procedure

Use the following procedure if the Registry Operator cannot create an S3 bucket and automatically configure storage.

1. Set up a [Bucket Lifecycle Policy](#) to abort incomplete multipart uploads that are one day old.
2. Fill in the storage configuration in **configs.imageregistry.operator.openshift.io/cluster**:

```
$ oc edit configs.imageregistry.operator.openshift.io/cluster
```

### Example configuration

```
storage:
  s3:
    bucket: <bucket-name>
    region: <region-name>
```



#### WARNING

To secure your registry images in AWS, [block public access](#) to the S3 bucket.

#### 5.13.22.1.2. Configuring storage for the image registry in non-production clusters

You must configure storage for the Image Registry Operator. For non-production clusters, you can set the image registry to an empty directory. If you do so, all images are lost if you restart the registry.

#### Procedure

- To set the image registry storage to an empty directory:

```
$ oc patch configs.imageregistry.operator.openshift.io cluster --type merge --patch '{"spec": {"storage":{"emptyDir":{}}}'
```



#### WARNING

Configure this option for only non-production clusters.

If you run this command before the Image Registry Operator initializes its components, the **oc patch** command fails with the following error:

```
Error from server (NotFound): configs.imageregistry.operator.openshift.io "cluster" not found
```

Wait a few minutes and run the command again.

#### 5.13.23. Deleting the bootstrap resources

After you complete the initial Operator configuration for the cluster, remove the bootstrap resources from Amazon Web Services (AWS).

#### Prerequisites

- You completed the initial Operator configuration for your cluster.

## Procedure

1. Delete the bootstrap resources. If you used the CloudFormation template, [delete its stack](#):

- Delete the stack by using the AWS CLI:

```
$ aws cloudformation delete-stack --stack-name <name> 1
```

- 1** **<name>** is the name of your bootstrap stack.

- Delete the stack by using the [AWS CloudFormation console](#).

## 5.13.24. Creating the Ingress DNS Records

If you removed the DNS Zone configuration, manually create DNS records that point to the Ingress load balancer. You can create either a wildcard record or specific records. While the following procedure uses A records, you can use other record types that you require, such as CNAME or alias.

### Prerequisites

- You deployed an OpenShift Container Platform cluster on Amazon Web Services (AWS) that uses infrastructure that you provisioned.
- You installed the OpenShift CLI (**oc**).
- You installed the **jq** package.
- You downloaded the AWS CLI and installed it on your computer. See [Install the AWS CLI Using the Bundled Installer \(Linux, macOS, or Unix\)](#).

### Procedure

1. Determine the routes to create.
  - To create a wildcard record, use **\*.apps.<cluster\_name>.<domain\_name>**, where **<cluster\_name>** is your cluster name, and **<domain\_name>** is the Route 53 base domain for your OpenShift Container Platform cluster.
  - To create specific records, you must create a record for each route that your cluster uses, as shown in the output of the following command:

```
$ oc get --all-namespaces -o jsonpath='{range .items[*]}{range .status.ingress[*]}{.host}\n'} routes
```

#### Example output

```
oauth-openshift.apps.<cluster_name>.<domain_name>  
console-openshift-console.apps.<cluster_name>.<domain_name>  
downloads-openshift-console.apps.<cluster_name>.<domain_name>  
alertmanager-main-openshift-monitoring.apps.<cluster_name>.<domain_name>  
grafana-openshift-monitoring.apps.<cluster_name>.<domain_name>  
prometheus-k8s-openshift-monitoring.apps.<cluster_name>.<domain_name>
```



- Retrieve the Ingress Operator load balancer status and note the value of the external IP address that it uses, which is shown in the **EXTERNAL-IP** column:

```
$ oc -n openshift-ingress get service router-default
```

### Example output

```
NAME          TYPE          CLUSTER-IP    EXTERNAL-IP          PORT(S)
AGE
router-default LoadBalancer 172.30.62.215  ab3...28.us-east-2.elb.amazonaws.com
80:31499/TCP,443:30693/TCP 5m
```

- Locate the hosted zone ID for the load balancer:

```
$ aws elb describe-load-balancers | jq -r '.LoadBalancerDescriptions[] | select(.DNSName == "<external_ip>").CanonicalHostedZoneNameID' 1
```

- For **<external\_ip>**, specify the value of the external IP address of the Ingress Operator load balancer that you obtained.

### Example output

```
Z3AADJGX6KTTL2
```

The output of this command is the load balancer hosted zone ID.

- Obtain the public hosted zone ID for your cluster's domain:

```
$ aws route53 list-hosted-zones-by-name \
  --dns-name "<domain_name>" 1
  --query 'HostedZones[? Config.PrivateZone != `true` && Name ==
  `<domain_name>.`].Id' 2
  --output text
```

- For **<domain\_name>**, specify the Route 53 base domain for your OpenShift Container Platform cluster.

### Example output

```
/hostedzone/Z3URY6TWQ91KVV
```

The public hosted zone ID for your domain is shown in the command output. In this example, it is **Z3URY6TWQ91KVV**.

- Add the alias records to your private zone:

```
$ aws route53 change-resource-record-sets --hosted-zone-id "<private_hosted_zone_id>" --
change-batch '{ 1
> "Changes": [
> {
```

```

>   "Action": "CREATE",
>   "ResourceRecordSet": {
>     "Name": "\\052.apps.<cluster_domain>", 2
>     "Type": "A",
>     "AliasTarget":{
>       "HostedZoneId": "<hosted_zone_id>", 3
>       "DNSName": "<external_ip>.", 4
>       "EvaluateTargetHealth": false
>     }
>   }
> }
> ]
> }'

```

- 1 For **<private\_hosted\_zone\_id>**, specify the value from the output of the CloudFormation template for DNS and load balancing.
- 2 For **<cluster\_domain>**, specify the domain or subdomain that you use with your OpenShift Container Platform cluster.
- 3 For **<hosted\_zone\_id>**, specify the public hosted zone ID for the load balancer that you obtained.
- 4 For **<external\_ip>**, specify the value of the external IP address of the Ingress Operator load balancer. Ensure that you include the trailing period (.) in this parameter value.

6. Add the records to your public zone:

```

$ aws route53 change-resource-record-sets --hosted-zone-id "<public_hosted_zone_id>" --
change-batch '{ 1
>   "Changes": [
>     {
>       "Action": "CREATE",
>       "ResourceRecordSet": {
>         "Name": "\\052.apps.<cluster_domain>", 2
>         "Type": "A",
>         "AliasTarget":{
>           "HostedZoneId": "<hosted_zone_id>", 3
>           "DNSName": "<external_ip>.", 4
>           "EvaluateTargetHealth": false
>         }
>       }
>     }
>   ]
> }'

```

- 1 For **<public\_hosted\_zone\_id>**, specify the public hosted zone for your domain.
- 2 For **<cluster\_domain>**, specify the domain or subdomain that you use with your OpenShift Container Platform cluster.
- 3 For **<hosted\_zone\_id>**, specify the public hosted zone ID for the load balancer that you obtained.

- 4 For **<external\_ip>**, specify the value of the external IP address of the Ingress Operator load balancer. Ensure that you include the trailing period (.) in this parameter value.

### 5.13.25. Completing an AWS installation on user-provisioned infrastructure

After you start the OpenShift Container Platform installation on Amazon Web Service (AWS) user-provisioned infrastructure, monitor the deployment to completion.

#### Prerequisites

- You removed the bootstrap node for an OpenShift Container Platform cluster on user-provisioned AWS infrastructure.
- You installed the **oc** CLI.

#### Procedure

- From the directory that contains the installation program, complete the cluster installation:

```
$ ./openshift-install --dir <installation_directory> wait-for install-complete 1
```

- 1 For **<installation\_directory>**, specify the path to the directory that you stored the installation files in.

#### Example output

```
INFO Waiting up to 40m0s for the cluster at https://api.mycluster.example.com:6443 to initialize...
INFO Waiting up to 10m0s for the openshift-console route to be created...
INFO Install complete!
INFO To access the cluster as the system:admin user when using 'oc', run 'export KUBECONFIG=/home/myuser/install_dir/auth/kubeconfig'
INFO Access the OpenShift web-console here: https://console-openshift-console.apps.mycluster.example.com
INFO Login to the console with user: "kubeadmin", and password: "password"
INFO Time elapsed: 1s
```



## IMPORTANT

- The Ignition config files that the installation program generates contain certificates that expire after 24 hours, which are then renewed at that time. If the cluster is shut down before renewing the certificates and the cluster is later restarted after the 24 hours have elapsed, the cluster automatically recovers the expired certificates. The exception is that you must manually approve the pending **node-bootstrapper** certificate signing requests (CSRs) to recover kubelet certificates. See the documentation for *Recovering from expired control plane certificates* for more information.
- It is recommended that you use Ignition config files within 12 hours after they are generated because the 24-hour certificate rotates from 16 to 22 hours after the cluster is installed. By using the Ignition config files within 12 hours, you can avoid installation failure if the certificate update runs during installation.

### 5.13.26. Logging in to the cluster by using the web console

The **kubeadmin** user exists by default after an OpenShift Container Platform installation. You can log in to your cluster as the **kubeadmin** user by using the OpenShift Container Platform web console.

#### Prerequisites

- You have access to the installation host.
- You completed a cluster installation and all cluster Operators are available.

#### Procedure

1. Obtain the password for the **kubeadmin** user from the **kubeadmin-password** file on the installation host:

```
$ cat <installation_directory>/auth/kubeadmin-password
```



#### NOTE

Alternatively, you can obtain the **kubeadmin** password from the **<installation\_directory>/openshift\_install.log** log file on the installation host.

2. List the OpenShift Container Platform web console route:

```
$ oc get routes -n openshift-console | grep 'console-openshift'
```



#### NOTE

Alternatively, you can obtain the OpenShift Container Platform route from the **<installation\_directory>/openshift\_install.log** log file on the installation host.

#### Example output

```
console console-openshift-console.apps.<cluster_name>.<base_domain> console
https reencrypt/Redirect None
```

- 
- 3. Navigate to the route detailed in the output of the preceding command in a web browser and log in as the **kubeadmin** user.

#### Additional resources

- See [Accessing the web console](#) for more details about accessing and understanding the OpenShift Container Platform web console.

### 5.13.27. Telemetry access for OpenShift Container Platform

In OpenShift Container Platform 4.10, the Telemetry service, which runs by default to provide metrics about cluster health and the success of updates, requires internet access. If your cluster is connected to the internet, Telemetry runs automatically, and your cluster is registered to [OpenShift Cluster Manager](#).

After you confirm that your [OpenShift Cluster Manager](#) inventory is correct, either maintained automatically by Telemetry or manually by using OpenShift Cluster Manager, [use subscription watch](#) to track your OpenShift Container Platform subscriptions at the account or multi-cluster level.

#### Additional resources

- See [About remote health monitoring](#) for more information about the Telemetry service.

### 5.13.28. Additional resources

- See [Working with stacks](#) in the AWS documentation for more information about AWS CloudFormation stacks.

### 5.13.29. Next steps

- [Validating an installation.](#)
- [Customize your cluster.](#)
- If necessary, you can [opt out of remote health reporting](#) .
- If necessary, you can [remove cloud provider credentials](#).

## 5.14. INSTALLING A CLUSTER ON AWS IN A RESTRICTED NETWORK WITH USER-PROVISIONED INFRASTRUCTURE

In OpenShift Container Platform version 4.10, you can install a cluster on Amazon Web Services (AWS) using infrastructure that you provide and an internal mirror of the installation release content.



#### IMPORTANT

While you can install an OpenShift Container Platform cluster by using mirrored installation release content, your cluster still requires internet access to use the AWS APIs.

One way to create this infrastructure is to use the provided CloudFormation templates. You can modify the templates to customize your infrastructure or use the information that they contain to create AWS objects according to your company's policies.



## IMPORTANT

The steps for performing a user-provisioned infrastructure installation are provided as an example only. Installing a cluster with infrastructure you provide requires knowledge of the cloud provider and the installation process of OpenShift Container Platform. Several CloudFormation templates are provided to assist in completing these steps or to help model your own. You are also free to create the required resources through other methods; the templates are just an example.

### 5.14.1. Prerequisites

- You reviewed details about the [OpenShift Container Platform installation and update](#) processes.
- You read the documentation on [selecting a cluster installation method and preparing it for users](#).
- You [created a mirror registry on your mirror host](#) and obtained the **imageContentSources** data for your version of OpenShift Container Platform.

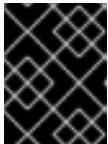

## IMPORTANT

Because the installation media is on the mirror host, you can use that computer to complete all installation steps.

- You [configured an AWS account](#) to host the cluster.



## IMPORTANT

If you have an AWS profile stored on your computer, it must not use a temporary session token that you generated while using a multi-factor authentication device. The cluster continues to use your current AWS credentials to create AWS resources for the entire life of the cluster, so you must use key-based, long-lived credentials. To generate appropriate keys, see [Managing Access Keys for IAM Users](#) in the AWS documentation. You can supply the keys when you run the installation program.

- You downloaded the AWS CLI and installed it on your computer. See [Install the AWS CLI Using the Bundled Installer \(Linux, macOS, or Unix\)](#) in the AWS documentation.
- If you use a firewall and plan to use the Telemetry service, you [configured the firewall to allow the sites](#) that your cluster requires access to.



## NOTE

Be sure to also review this site list if you are configuring a proxy.

- If the cloud identity and access management (IAM) APIs are not accessible in your environment, or if you do not want to store an administrator-level credential secret in the **kube-system** namespace, you can [manually create and maintain IAM credentials](#).

### 5.14.2. About installations in restricted networks

In OpenShift Container Platform 4.10, you can perform an installation that does not require an active connection to the internet to obtain software components. Restricted network installations can be completed using installer-provisioned infrastructure or user-provisioned infrastructure, depending on the cloud platform to which you are installing the cluster.

If you choose to perform a restricted network installation on a cloud platform, you still require access to its cloud APIs. Some cloud functions, like Amazon Web Service's Route 53 DNS and IAM services, require internet access. Depending on your network, you might require less internet access for an installation on bare metal hardware or on VMware vSphere.

To complete a restricted network installation, you must create a registry that mirrors the contents of the OpenShift image registry and contains the installation media. You can create this registry on a mirror host, which can access both the internet and your closed network, or by using other methods that meet your restrictions.



### IMPORTANT

Because of the complexity of the configuration for user-provisioned installations, consider completing a standard user-provisioned infrastructure installation before you attempt a restricted network installation using user-provisioned infrastructure. Completing this test installation might make it easier to isolate and troubleshoot any issues that might arise during your installation in a restricted network.

#### 5.14.2.1. Additional limits

Clusters in restricted networks have the following additional limitations and restrictions:

- The **ClusterVersion** status includes an **Unable to retrieve available updates** error.
- By default, you cannot use the contents of the Developer Catalog because you cannot access the required image stream tags.

#### 5.14.3. Internet access for OpenShift Container Platform

In OpenShift Container Platform 4.10, you require access to the internet to obtain the images that are necessary to install your cluster.

You must have internet access to:

- Access [OpenShift Cluster Manager](#) to download the installation program and perform subscription management. If the cluster has internet access and you do not disable Telemetry, that service automatically entitles your cluster.
- Access [Quay.io](#) to obtain the packages that are required to install your cluster.
- Obtain the packages that are required to perform cluster updates.



### IMPORTANT

If your cluster cannot have direct internet access, you can perform a restricted network installation on some types of infrastructure that you provision. During that process, you download the required content and use it to populate a mirror registry with the installation packages. With some installation types, the environment that you install your cluster in will not require internet access. Before you update the cluster, you update the content of the mirror registry.

### 5.14.4. Requirements for a cluster with user-provisioned infrastructure

For a cluster that contains user-provisioned infrastructure, you must deploy all of the required machines.

This section describes the requirements for deploying OpenShift Container Platform on user-provisioned infrastructure.

#### 5.14.4.1. Required machines for cluster installation

The smallest OpenShift Container Platform clusters require the following hosts:

**Table 5.50. Minimum required hosts**

Hosts	Description
One temporary bootstrap machine	The cluster requires the bootstrap machine to deploy the OpenShift Container Platform cluster on the three control plane machines. You can remove the bootstrap machine after you install the cluster.
Three control plane machines	The control plane machines run the Kubernetes and OpenShift Container Platform services that form the control plane.
At least two compute machines, which are also known as worker machines.	The workloads requested by OpenShift Container Platform users run on the compute machines.



#### IMPORTANT

To maintain high availability of your cluster, use separate physical hosts for these cluster machines.

The bootstrap and control plane machines must use Red Hat Enterprise Linux CoreOS (RHCOS) as the operating system. However, the compute machines can choose between Red Hat Enterprise Linux CoreOS (RHCOS), Red Hat Enterprise Linux (RHEL) 8.4, or RHEL 8.5.

Note that RHCOS is based on Red Hat Enterprise Linux (RHEL) 8 and inherits all of its hardware certifications and requirements. See [Red Hat Enterprise Linux technology capabilities and limits](#).

#### 5.14.4.2. Minimum resource requirements for cluster installation

Each cluster machine must meet the following minimum requirements:

**Table 5.51. Minimum resource requirements**

Machine	Operating System	vCPU [1]	Virtual RAM	Storage	IOPS [2]
Bootstrap	RHCOS	4	16 GB	100 GB	300
Control plane	RHCOS	4	16 GB	100 GB	300



Machine	Operating System	vCPU [1]	Virtual RAM	Storage	IOPS [2]
Compute	RHCOS, RHEL 8.4, or RHEL 8.5 <sup>[3]</sup>	2	8 GB	100 GB	300

1. One vCPU is equivalent to one physical core when simultaneous multithreading (SMT), or hyperthreading, is not enabled. When enabled, use the following formula to calculate the corresponding ratio: (threads per core × cores) × sockets = vCPUs.
2. OpenShift Container Platform and Kubernetes are sensitive to disk performance, and faster storage is recommended, particularly for etcd on the control plane nodes which require a 10 ms p99 fsync duration. Note that on many cloud platforms, storage size and IOPS scale together, so you might need to over-allocate storage volume to obtain sufficient performance.
3. As with all user-provisioned installations, if you choose to use RHEL compute machines in your cluster, you take responsibility for all operating system life cycle management and maintenance, including performing system updates, applying patches, and completing all other required tasks. Use of RHEL 7 compute machines is deprecated and has been removed in OpenShift Container Platform 4.10 and later.

If an instance type for your platform meets the minimum requirements for cluster machines, it is supported to use in OpenShift Container Platform.

#### 5.14.4.3. Tested instance types for AWS

The following Amazon Web Services (AWS) instance types have been tested with OpenShift Container Platform.

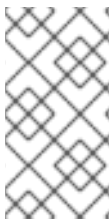

#### NOTE

Use the machine types included in the following charts for your AWS instances. If you use an instance type that is not listed in the chart, ensure that the instance size you use matches the minimum resource requirements that are listed in "Minimum resource requirements for cluster installation".

#### Example 5.50. Machine types based on 64-bit x86 architecture

- **c4.\***
- **c5.\***
- **c5a.\***
- **i3.\***
- **m4.\***
- **m5.\***
- **m5a.\***

- **m6i.\***
- **r4.\***
- **r5.\***
- **r5a.\***
- **r6i.\***
- **t3.\***
- **t3a.\***

#### 5.14.4.4. Tested instance types for AWS on 64-bit ARM infrastructures

The following Amazon Web Services (AWS) ARM64 instance types have been tested with OpenShift Container Platform.



#### NOTE

Use the machine types included in the following charts for your AWS ARM instances. If you use an instance type that is not listed in the chart, ensure that the instance size you use matches the minimum resource requirements that are listed in "Minimum resource requirements for cluster installation".

#### Example 5.51. Machine types based on 64-bit ARM architecture

- **c6g.\***
- **m6g.\***

#### 5.14.4.5. Certificate signing requests management

Because your cluster has limited access to automatic machine management when you use infrastructure that you provision, you must provide a mechanism for approving cluster certificate signing requests (CSRs) after installation. The **kube-controller-manager** only approves the kubelet client CSRs. The **machine-approver** cannot guarantee the validity of a serving certificate that is requested by using kubelet credentials because it cannot confirm that the correct machine issued the request. You must determine and implement a method of verifying the validity of the kubelet serving certificate requests and approving them.

#### 5.14.5. Required AWS infrastructure components

To install OpenShift Container Platform on user-provisioned infrastructure in Amazon Web Services (AWS), you must manually create both the machines and their supporting infrastructure.

For more information about the integration testing for different platforms, see the [OpenShift Container Platform 4.x Tested Integrations](#) page.

By using the provided CloudFormation templates, you can create stacks of AWS resources that represent the following components:

- An AWS Virtual Private Cloud (VPC)
- Networking and load balancing components
- Security groups and roles
- An OpenShift Container Platform bootstrap node
- OpenShift Container Platform control plane nodes
- An OpenShift Container Platform compute node

Alternatively, you can manually create the components or you can reuse existing infrastructure that meets the cluster requirements. Review the CloudFormation templates for more details about how the components interrelate.

#### 5.14.5.1. Other infrastructure components

- A VPC
- DNS entries
- Load balancers (classic or network) and listeners
- A public and a private Route 53 zone
- Security groups
- IAM roles
- S3 buckets

If you are working in a disconnected environment or use a proxy, you cannot reach the public IP addresses for EC2 and ELB endpoints. To reach these endpoints, you must create a VPC endpoint and attach it to the subnet that the clusters are using. Create the following endpoints:

- **ec2.<region>.amazonaws.com**
- **elasticloadbalancing.<region>.amazonaws.com**
- **s3.<region>.amazonaws.com**

#### Required VPC components

You must provide a suitable VPC and subnets that allow communication to your machines.

Component	AWS type	Description
VPC	<ul style="list-style-type: none"> <li>• <b>AWS::EC2::VPC</b></li> <li>• <b>AWS::EC2::VPCEndpoint</b></li> </ul>	You must provide a public VPC for the cluster to use. The VPC uses an endpoint that references the route tables for each subnet to improve communication with the registry that is hosted in S3.

Component	AWS type	Description												
Public subnets	<ul style="list-style-type: none"> <li>● <b>AWS::EC2::Subnet</b></li> <li>● <b>AWS::EC2::SubnetNetworkACLAssociation</b></li> </ul>	Your VPC must have public subnets for between 1 and 3 availability zones and associate them with appropriate Ingress rules.												
Internet gateway	<ul style="list-style-type: none"> <li>● <b>AWS::EC2::InternetGateway</b></li> <li>● <b>AWS::EC2::VPCElasticGatewayAttachment</b></li> <li>● <b>AWS::EC2::RouteTable</b></li> <li>● <b>AWS::EC2::Route</b></li> <li>● <b>AWS::EC2::SubnetRouteTableAssociation</b></li> <li>● <b>AWS::EC2::NATGateway</b></li> <li>● <b>AWS::EC2::EIP</b></li> </ul>	You must have a public internet gateway, with public routes, attached to the VPC. In the provided templates, each public subnet has a NAT gateway with an EIP address. These NAT gateways allow cluster resources, like private subnet instances, to reach the internet and are not required for some restricted network or proxy scenarios.												
Network access control	<ul style="list-style-type: none"> <li>● <b>AWS::EC2::NetworkACL</b></li> <li>● <b>AWS::EC2::NetworkACLEntry</b></li> </ul>	<p>You must allow the VPC to access the following ports:</p> <table border="1"> <thead> <tr> <th>Port</th> <th>Reason</th> </tr> </thead> <tbody> <tr> <td><b>80</b></td> <td>Inbound HTTP traffic</td> </tr> <tr> <td><b>443</b></td> <td>Inbound HTTPS traffic</td> </tr> <tr> <td><b>22</b></td> <td>Inbound SSH traffic</td> </tr> <tr> <td><b>1024 - 65535</b></td> <td>Inbound ephemeral traffic</td> </tr> <tr> <td><b>0 - 65535</b></td> <td>Outbound ephemeral traffic</td> </tr> </tbody> </table>	Port	Reason	<b>80</b>	Inbound HTTP traffic	<b>443</b>	Inbound HTTPS traffic	<b>22</b>	Inbound SSH traffic	<b>1024 - 65535</b>	Inbound ephemeral traffic	<b>0 - 65535</b>	Outbound ephemeral traffic
Port	Reason													
<b>80</b>	Inbound HTTP traffic													
<b>443</b>	Inbound HTTPS traffic													
<b>22</b>	Inbound SSH traffic													
<b>1024 - 65535</b>	Inbound ephemeral traffic													
<b>0 - 65535</b>	Outbound ephemeral traffic													

Component	AWS type	Description
Private subnets	<ul style="list-style-type: none"> <li>● <b>AWS::EC2::Subnet</b></li> <li>● <b>AWS::EC2::RouteTable</b></li> <li>● <b>AWS::EC2::SubnetRouteTableAssociation</b></li> </ul>	Your VPC can have private subnets. The provided CloudFormation templates can create private subnets for between 1 and 3 availability zones. If you use private subnets, you must provide appropriate routes and tables for them.

## Required DNS and load balancing components

Your DNS and load balancer configuration needs to use a public hosted zone and can use a private hosted zone similar to the one that the installation program uses if it provisions the cluster's infrastructure. You must create a DNS entry that resolves to your load balancer. An entry for **api.<cluster\_name>.<domain>** must point to the external load balancer, and an entry for **api-int.<cluster\_name>.<domain>** must point to the internal load balancer.

The cluster also requires load balancers and listeners for port 6443, which are required for the Kubernetes API and its extensions, and port 22623, which are required for the Ignition config files for new machines. The targets will be the control plane nodes. Port 6443 must be accessible to both clients external to the cluster and nodes within the cluster. Port 22623 must be accessible to nodes within the cluster.

Component	AWS type	Description
DNS	<b>AWS::Route53::HostedZone</b>	The hosted zone for your internal DNS.
etcd record sets	<b>AWS::Route53::RecordSet</b>	The registration records for etcd for your control plane machines.
Public load balancer	<b>AWS::ElasticLoadBalancingV2::LoadBalancer</b>	The load balancer for your public subnets.
External API server record	<b>AWS::Route53::RecordSetGroup</b>	Alias records for the external API server.
External listener	<b>AWS::ElasticLoadBalancingV2::Listener</b>	A listener on port 6443 for the external load balancer.

Component	AWS type	Description
External target group	<b>AWS::ElasticLoadBalancingV2::TargetGroup</b>	The target group for the external load balancer.
Private load balancer	<b>AWS::ElasticLoadBalancingV2::LoadBalancer</b>	The load balancer for your private subnets.
Internal API server record	<b>AWS::Route53::RecordSetGroup</b>	Alias records for the internal API server.
Internal listener	<b>AWS::ElasticLoadBalancingV2::Listener</b>	A listener on port 22623 for the internal load balancer.
Internal target group	<b>AWS::ElasticLoadBalancingV2::TargetGroup</b>	The target group for the internal load balancer.
Internal listener	<b>AWS::ElasticLoadBalancingV2::Listener</b>	A listener on port 6443 for the internal load balancer.
Internal target group	<b>AWS::ElasticLoadBalancingV2::TargetGroup</b>	The target group for the internal load balancer.

## Security groups

The control plane and worker machines require access to the following ports:

Group	Type	IP Protocol	Port range
<b>MasterSecurityGroup</b>	<b>AWS::EC2::SecurityGroup</b>	<b>icmp</b>	<b>0</b>
		<b>tcp</b>	<b>22</b>
		<b>tcp</b>	<b>6443</b>
		<b>tcp</b>	<b>22623</b>

Group	Type	IP Protocol	Port range
WorkerSecurityGroup	AWS::EC2::SecurityGroup	icmp	0
		tcp	22
BootstrapSecurityGroup	AWS::EC2::SecurityGroup	tcp	22
		tcp	19531

## Control plane Ingress

The control plane machines require the following Ingress groups. Each Ingress group is a **AWS::EC2::SecurityGroupIngress** resource.

Ingress group	Description	IP protocol	Port range
<b>MasterIngressEtcd</b>	etcd	tcp	2379- 2380
<b>MasterIngressVxlan</b>	Vxlan packets	udp	4789
<b>MasterIngressWorkerVxlan</b>	Vxlan packets	udp	4789
<b>MasterIngressInternal</b>	Internal cluster communication and Kubernetes proxy metrics	tcp	9000 - 9999
<b>MasterIngressWorkerInternal</b>	Internal cluster communication	tcp	9000 - 9999
<b>MasterIngressKube</b>	Kubernetes kubelet, scheduler and controller manager	tcp	10250 - 10259
<b>MasterIngressWorkerKube</b>	Kubernetes kubelet, scheduler and controller manager	tcp	10250 - 10259
<b>MasterIngressIngressServices</b>	Kubernetes Ingress services	tcp	30000 - 32767
<b>MasterIngressWorkerIngressServices</b>	Kubernetes Ingress services	tcp	30000 - 32767
<b>MasterIngressGeneve</b>	Geneve packets	udp	6081

Ingress group	Description	IP protocol	Port range
<b>MasterIngress WorkerGeneve</b>	Geneve packets	<b>udp</b>	<b>6081</b>
<b>MasterIngress IpsecIke</b>	IPsec IKE packets	<b>udp</b>	<b>500</b>
<b>MasterIngress WorkerIpsecIke</b>	IPsec IKE packets	<b>udp</b>	<b>500</b>
<b>MasterIngress IpsecNat</b>	IPsec NAT-T packets	<b>udp</b>	<b>4500</b>
<b>MasterIngress WorkerIpsecNat</b>	IPsec NAT-T packets	<b>udp</b>	<b>4500</b>
<b>MasterIngress IpsecEsp</b>	IPsec ESP packets	<b>50</b>	<b>All</b>
<b>MasterIngress WorkerIpsecEsp</b>	IPsec ESP packets	<b>50</b>	<b>All</b>
<b>MasterIngress InternalUDP</b>	Internal cluster communication	<b>udp</b>	<b>9000 - 9999</b>
<b>MasterIngress WorkerInternalUDP</b>	Internal cluster communication	<b>udp</b>	<b>9000 - 9999</b>
<b>MasterIngress IngressServicesUDP</b>	Kubernetes Ingress services	<b>udp</b>	<b>30000 - 32767</b>
<b>MasterIngress WorkerIngressServicesUDP</b>	Kubernetes Ingress services	<b>udp</b>	<b>30000 - 32767</b>

## Worker Ingress

The worker machines require the following Ingress groups. Each Ingress group is a **AWS::EC2::SecurityGroupIngress** resource.



Ingress group	Description	IP protocol	Port range
<b>WorkerIngress Vxlan</b>	Vxlan packets	<b>udp</b>	<b>4789</b>
<b>WorkerIngress WorkerVxlan</b>	Vxlan packets	<b>udp</b>	<b>4789</b>
<b>WorkerIngress Internal</b>	Internal cluster communication	<b>tcp</b>	<b>9000 - 9999</b>
<b>WorkerIngress WorkerInternal</b>	Internal cluster communication	<b>tcp</b>	<b>9000 - 9999</b>
<b>WorkerIngress Kube</b>	Kubernetes kubelet, scheduler, and controller manager	<b>tcp</b>	<b>10250</b>
<b>WorkerIngress WorkerKube</b>	Kubernetes kubelet, scheduler, and controller manager	<b>tcp</b>	<b>10250</b>
<b>WorkerIngress IngressServices</b>	Kubernetes Ingress services	<b>tcp</b>	<b>30000 - 32767</b>
<b>WorkerIngress WorkerIngressServices</b>	Kubernetes Ingress services	<b>tcp</b>	<b>30000 - 32767</b>
<b>WorkerIngress Geneve</b>	Geneve packets	<b>udp</b>	<b>6081</b>
<b>WorkerIngress MasterGeneve</b>	Geneve packets	<b>udp</b>	<b>6081</b>
<b>WorkerIngress IpsecIke</b>	IPsec IKE packets	<b>udp</b>	<b>500</b>
<b>WorkerIngress MasterIpsecIke</b>	IPsec IKE packets	<b>udp</b>	<b>500</b>
<b>WorkerIngress IpsecNat</b>	IPsec NAT-T packets	<b>udp</b>	<b>4500</b>
<b>WorkerIngress MasterIpsecNat</b>	IPsec NAT-T packets	<b>udp</b>	<b>4500</b>

Ingress group	Description	IP protocol	Port range
<b>WorkerIngress IpsecEsp</b>	IPsec ESP packets	<b>50</b>	<b>All</b>
<b>WorkerIngress MasterIpsecEsp</b>	IPsec ESP packets	<b>50</b>	<b>All</b>
<b>WorkerIngress InternalUDP</b>	Internal cluster communication	<b>udp</b>	<b>9000 - 9999</b>
<b>WorkerIngress MasterInternal UDP</b>	Internal cluster communication	<b>udp</b>	<b>9000 - 9999</b>
<b>WorkerIngress IngressServices UDP</b>	Kubernetes Ingress services	<b>udp</b>	<b>30000 - 32767</b>
<b>WorkerIngress MasterIngress ServicesUDP</b>	Kubernetes Ingress services	<b>udp</b>	<b>30000 - 32767</b>

## Roles and instance profiles

You must grant the machines permissions in AWS. The provided CloudFormation templates grant the machines **Allow** permissions for the following **AWS::IAM::Role** objects and provide a **AWS::IAM::InstanceProfile** for each set of roles. If you do not use the templates, you can grant the machines the following broad permissions or the following individual permissions.

Role	Effect	Action	Resource
Master	<b>Allow</b>	<b>ec2:*</b>	<b>*</b>
	<b>Allow</b>	<b>elasticloadbalancing :*</b>	<b>*</b>
	<b>Allow</b>	<b>iam:PassRole</b>	<b>*</b>
	<b>Allow</b>	<b>s3:GetObject</b>	<b>*</b>
Worker	<b>Allow</b>	<b>ec2:Describe*</b>	<b>*</b>
Bootstrap	<b>Allow</b>	<b>ec2:Describe*</b>	<b>*</b>

Role	Effect	Action	Resource
	<b>Allow</b>	<b>ec2:AttachVolume</b>	*
	<b>Allow</b>	<b>ec2:DetachVolume</b>	*

### 5.14.5.2. Cluster machines

You need **AWS::EC2::Instance** objects for the following machines:

- A bootstrap machine. This machine is required during installation, but you can remove it after your cluster deploys.
- Three control plane machines. The control plane machines are not governed by a machine set.
- Compute machines. You must create at least two compute machines, which are also known as worker machines, during installation. These machines are not governed by a machine set.

### 5.14.5.3. Required AWS permissions for the IAM user



#### NOTE

Your IAM user must have the permission **tag:GetResources** in the region **us-east-1** to delete the base cluster resources. As part of the AWS API requirement, the OpenShift Container Platform installation program performs various actions in this region.

When you attach the **AdministratorAccess** policy to the IAM user that you create in Amazon Web Services (AWS), you grant that user all of the required permissions. To deploy all components of an OpenShift Container Platform cluster, the IAM user requires the following permissions:

#### Example 5.52. Required EC2 permissions for installation

- **ec2:AuthorizeSecurityGroupEgress**
- **ec2:AuthorizeSecurityGroupIngress**
- **ec2:CopyImage**
- **ec2:CreateNetworkInterface**
- **ec2:AttachNetworkInterface**
- **ec2:CreateSecurityGroup**
- **ec2:CreateTags**
- **ec2:CreateVolume**
- **ec2>DeleteSecurityGroup**
- **ec2>DeleteSnapshot**
- **ec2>DeleteTags**

- **ec2:DeregisterImage**
- **ec2:DescribeAccountAttributes**
- **ec2:DescribeAddresses**
- **ec2:DescribeAvailabilityZones**
- **ec2:DescribeDhcpOptions**
- **ec2:DescribeImages**
- **ec2:DescribeInstanceAttribute**
- **ec2:DescribeInstanceCreditSpecifications**
- **ec2:DescribeInstances**
- **ec2:DescribeInstanceTypes**
- **ec2:DescribeInternetGateways**
- **ec2:DescribeKeyPairs**
- **ec2:DescribeNatGateways**
- **ec2:DescribeNetworkAcls**
- **ec2:DescribeNetworkInterfaces**
- **ec2:DescribePrefixLists**
- **ec2:DescribeRegions**
- **ec2:DescribeRouteTables**
- **ec2:DescribeSecurityGroups**
- **ec2:DescribeSubnets**
- **ec2:DescribeTags**
- **ec2:DescribeVolumes**
- **ec2:DescribeVpcAttribute**
- **ec2:DescribeVpcClassicLink**
- **ec2:DescribeVpcClassicLinkDnsSupport**
- **ec2:DescribeVpcEndpoints**
- **ec2:DescribeVpcs**
- **ec2:GetEbsDefaultKmsKeyId**
- **ec2:ModifyInstanceAttribute**

- **ec2:ModifyNetworkInterfaceAttribute**
- **ec2:RevokeSecurityGroupEgress**
- **ec2:RevokeSecurityGroupIngress**
- **ec2:RunInstances**
- **ec2:TerminateInstances**

Example 5.53. Required permissions for creating network resources during installation

- **ec2:AllocateAddress**
- **ec2:AssociateAddress**
- **ec2:AssociateDhcpOptions**
- **ec2:AssociateRouteTable**
- **ec2:AttachInternetGateway**
- **ec2:CreateDhcpOptions**
- **ec2:CreateInternetGateway**
- **ec2:CreateNatGateway**
- **ec2:CreateRoute**
- **ec2:CreateRouteTable**
- **ec2:CreateSubnet**
- **ec2:CreateVpc**
- **ec2:CreateVpcEndpoint**
- **ec2:ModifySubnetAttribute**
- **ec2:ModifyVpcAttribute**

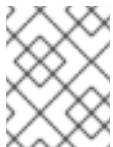

#### NOTE

If you use an existing VPC, your account does not require these permissions for creating network resources.

Example 5.54. Required Elastic Load Balancing permissions (ELB) for installation

- **elasticloadbalancing:AddTags**
- **elasticloadbalancing:ApplySecurityGroupsToLoadBalancer**
- **elasticloadbalancing:AttachLoadBalancerToSubnets**

- **elasticloadbalancing:ConfigureHealthCheck**
- **elasticloadbalancing>CreateLoadBalancer**
- **elasticloadbalancing>CreateLoadBalancerListeners**
- **elasticloadbalancing>DeleteLoadBalancer**
- **elasticloadbalancing:DeregisterInstancesFromLoadBalancer**
- **elasticloadbalancing:DescribeInstanceHealth**
- **elasticloadbalancing:DescribeLoadBalancerAttributes**
- **elasticloadbalancing:DescribeLoadBalancers**
- **elasticloadbalancing:DescribeTags**
- **elasticloadbalancing:ModifyLoadBalancerAttributes**
- **elasticloadbalancing:RegisterInstancesWithLoadBalancer**
- **elasticloadbalancing:SetLoadBalancerPoliciesOfListener**

Example 5.55. Required Elastic Load Balancing permissions (ELBv2) for installation

- **elasticloadbalancing:AddTags**
- **elasticloadbalancing>CreateListener**
- **elasticloadbalancing>CreateLoadBalancer**
- **elasticloadbalancing>CreateTargetGroup**
- **elasticloadbalancing>DeleteLoadBalancer**
- **elasticloadbalancing:DeregisterTargets**
- **elasticloadbalancing:DescribeListeners**
- **elasticloadbalancing:DescribeLoadBalancerAttributes**
- **elasticloadbalancing:DescribeLoadBalancers**
- **elasticloadbalancing:DescribeTargetGroupAttributes**
- **elasticloadbalancing:DescribeTargetHealth**
- **elasticloadbalancing:ModifyLoadBalancerAttributes**
- **elasticloadbalancing:ModifyTargetGroup**
- **elasticloadbalancing:ModifyTargetGroupAttributes**
- **elasticloadbalancing:RegisterTargets**

**Example 5.56. Required IAM permissions for installation**

- **iam:AddRoleToInstanceProfile**
- **iam:CreateInstanceProfile**
- **iam:CreateRole**
- **iam:DeleteInstanceProfile**
- **iam>DeleteRole**
- **iam>DeleteRolePolicy**
- **iam:GetInstanceProfile**
- **iam:GetRole**
- **iam:GetRolePolicy**
- **iam:GetUser**
- **iam:ListInstanceProfilesForRole**
- **iam:ListRoles**
- **iam:ListUsers**
- **iam:PassRole**
- **iam:PutRolePolicy**
- **iam:RemoveRoleFromInstanceProfile**
- **iam:SimulatePrincipalPolicy**
- **iam:TagRole**

**NOTE**

If you have not created an elastic load balancer (ELB) in your AWS account, the IAM user also requires the **iam:CreateServiceLinkedRole** permission.

**Example 5.57. Required Route 53 permissions for installation**

- **route53:ChangeResourceRecordSets**
- **route53:ChangeTagsForResource**
- **route53:CreateHostedZone**
- **route53>DeleteHostedZone**
- **route53:GetChange**

- **route53:GetHostedZone**
- **route53:ListHostedZones**
- **route53:ListHostedZonesByName**
- **route53:ListResourceRecordSets**
- **route53:ListTagsForResource**
- **route53:UpdateHostedZoneComment**

Example 5.58. Required S3 permissions for installation

- **s3:CreateBucket**
- **s3>DeleteBucket**
- **s3:GetAccelerateConfiguration**
- **s3:GetBucketAcl**
- **s3:GetBucketCors**
- **s3:GetBucketLocation**
- **s3:GetBucketLogging**
- **s3:GetBucketObjectLockConfiguration**
- **s3:GetBucketReplication**
- **s3:GetBucketRequestPayment**
- **s3:GetBucketTagging**
- **s3:GetBucketVersioning**
- **s3:GetBucketWebsite**
- **s3:GetEncryptionConfiguration**
- **s3:GetLifecycleConfiguration**
- **s3:GetReplicationConfiguration**
- **s3:ListBucket**
- **s3:PutBucketAcl**
- **s3:PutBucketTagging**
- **s3:PutEncryptionConfiguration**

Example 5.59. S3 permissions that cluster Operators require



- **s3:DeleteObject**
- **s3:GetObject**
- **s3:GetObjectAcl**
- **s3:GetObjectTagging**
- **s3:GetObjectVersion**
- **s3:PutObject**
- **s3:PutObjectAcl**
- **s3:PutObjectTagging**

Example 5.60. Required permissions to delete base cluster resources

- **autoscaling:DescribeAutoScalingGroups**
- **ec2:DeleteNetworkInterface**
- **ec2:DeleteVolume**
- **elasticloadbalancing:DeleteTargetGroup**
- **elasticloadbalancing:DescribeTargetGroups**
- **iam:DeleteAccessKey**
- **iam:DeleteUser**
- **iam>ListAttachedRolePolicies**
- **iam>ListInstanceProfiles**
- **iam>ListRolePolicies**
- **iam>ListUserPolicies**
- **s3:DeleteObject**
- **s3:ListBucketVersions**
- **tag:GetResources**

Example 5.61. Required permissions to delete network resources

- **ec2:DeleteDhcpOptions**
- **ec2:DeleteInternetGateway**
- **ec2:DeleteNatGateway**
- **ec2:DeleteRoute**

- **ec2:DeleteRouteTable**
- **ec2:DeleteSubnet**
- **ec2:DeleteVpc**
- **ec2:DeleteVpcEndpoints**
- **ec2:DetachInternetGateway**
- **ec2:DisassociateRouteTable**
- **ec2:ReleaseAddress**
- **ec2:ReplaceRouteTableAssociation**

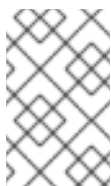

#### NOTE

If you use an existing VPC, your account does not require these permissions to delete network resources. Instead, your account only requires the **tag:UntagResources** permission to delete network resources.

#### Example 5.62. Required permissions to delete a cluster with shared instance roles

- **iam:UntagRole**

#### Example 5.63. Additional IAM and S3 permissions that are required to create manifests

- **iam:DeleteAccessKey**
- **iam:DeleteUser**
- **iam:DeleteUserPolicy**
- **iam:GetUserPolicy**
- **iam:ListAccessKeys**
- **iam:PutUserPolicy**
- **iam:TagUser**
- **s3:PutBucketPublicAccessBlock**
- **s3:GetBucketPublicAccessBlock**
- **s3:PutLifecycleConfiguration**
- **s3:HeadBucket**
- **s3:ListBucketMultipartUploads**
- **s3:AbortMultipartUpload**

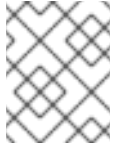
**NOTE**

If you are managing your cloud provider credentials with mint mode, the IAM user also requires the **iam:CreateAccessKey** and **iam:CreateUser** permissions.

**Example 5.64. Optional permissions for instance and quota checks for installation**

- **ec2:DescribeInstanceTypeOfferings**
- **servicequotas:ListAWSDefaultServiceQuotas**

**5.14.6. Generating a key pair for cluster node SSH access**

During an OpenShift Container Platform installation, you can provide an SSH public key to the installation program. The key is passed to the Red Hat Enterprise Linux CoreOS (RHCOS) nodes through their Ignition config files and is used to authenticate SSH access to the nodes. The key is added to the `~/.ssh/authorized_keys` list for the **core** user on each node, which enables password-less authentication.

After the key is passed to the nodes, you can use the key pair to SSH in to the RHCOS nodes as the user **core**. To access the nodes through SSH, the private key identity must be managed by SSH for your local user.

If you want to SSH in to your cluster nodes to perform installation debugging or disaster recovery, you must provide the SSH public key during the installation process. The `./openshift-install gather` command also requires the SSH public key to be in place on the cluster nodes.

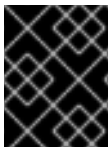
**IMPORTANT**

Do not skip this procedure in production environments, where disaster recovery and debugging is required.

**NOTE**

You must use a local key, not one that you configured with platform-specific approaches such as [AWS key pairs](#).

**Procedure**

1. If you do not have an existing SSH key pair on your local machine to use for authentication onto your cluster nodes, create one. For example, on a computer that uses a Linux operating system, run the following command:

```
$ ssh-keygen -t ed25519 -N "" -f <path>/<file_name> 1
```

- 1** Specify the path and file name, such as `~/.ssh/id_ed25519`, of the new SSH key. If you have an existing key pair, ensure your public key is in the your `~/.ssh` directory.

**NOTE**

If you plan to install an OpenShift Container Platform cluster that uses FIPS validated or Modules In Process cryptographic libraries on the **x86\_64** architecture, do not create a key that uses the **ed25519** algorithm. Instead, create a key that uses the **rsa** or **ecdsa** algorithm.

- View the public SSH key:

```
$ cat <path>/<file_name>.pub
```

For example, run the following to view the `~/.ssh/id_ed25519.pub` public key:

```
$ cat ~/.ssh/id_ed25519.pub
```

- Add the SSH private key identity to the SSH agent for your local user, if it has not already been added. SSH agent management of the key is required for password-less SSH authentication onto your cluster nodes, or if you want to use the `./openshift-install gather` command.

**NOTE**

On some distributions, default SSH private key identities such as `~/.ssh/id_rsa` and `~/.ssh/id_dsa` are managed automatically.

- If the **ssh-agent** process is not already running for your local user, start it as a background task:

```
$ eval "$(ssh-agent -s)"
```

**Example output**

```
Agent pid 31874
```

**NOTE**

If your cluster is in FIPS mode, only use FIPS-compliant algorithms to generate the SSH key. The key must be either RSA or ECDSA.

- Add your SSH private key to the **ssh-agent**:

```
$ ssh-add <path>/<file_name> 1
```

- 1** Specify the path and file name for your SSH private key, such as `~/.ssh/id_ed25519`

**Example output**

```
Identity added: /home/<you>/<path>/<file_name> (<computer_name>)
```

**Next steps**

- When you install OpenShift Container Platform, provide the SSH public key to the installation program. If you install a cluster on infrastructure that you provision, you must provide the key to the installation program.

### 5.14.7. Creating the installation files for AWS

To install OpenShift Container Platform on Amazon Web Services (AWS) using user-provisioned infrastructure, you must generate the files that the installation program needs to deploy your cluster and modify them so that the cluster creates only the machines that it will use. You generate and customize the **install-config.yaml** file, Kubernetes manifests, and Ignition config files. You also have the option to first set up a separate **var** partition during the preparation phases of installation.

#### 5.14.7.1. Optional: Creating a separate **/var** partition

It is recommended that disk partitioning for OpenShift Container Platform be left to the installer. However, there are cases where you might want to create separate partitions in a part of the filesystem that you expect to grow.

OpenShift Container Platform supports the addition of a single partition to attach storage to either the **/var** partition or a subdirectory of **/var**. For example:

- **/var/lib/containers**: Holds container-related content that can grow as more images and containers are added to a system.
- **/var/lib/etcd**: Holds data that you might want to keep separate for purposes such as performance optimization of etcd storage.
- **/var**: Holds data that you might want to keep separate for purposes such as auditing.

Storing the contents of a **/var** directory separately makes it easier to grow storage for those areas as needed and reinstall OpenShift Container Platform at a later date and keep that data intact. With this method, you will not have to pull all your containers again, nor will you have to copy massive log files when you update systems.

Because **/var** must be in place before a fresh installation of Red Hat Enterprise Linux CoreOS (RHCOS), the following procedure sets up the separate **/var** partition by creating a machine config manifest that is inserted during the **openshift-install** preparation phases of an OpenShift Container Platform installation.



#### IMPORTANT

If you follow the steps to create a separate **/var** partition in this procedure, it is not necessary to create the Kubernetes manifest and Ignition config files again as described later in this section.

#### Procedure

1. Create a directory to hold the OpenShift Container Platform installation files:

```
$ mkdir $HOME/clusterconfig
```

2. Run **openshift-install** to create a set of files in the **manifest** and **openshift** subdirectories. Answer the system questions as you are prompted:

```
$ openshift-install create manifests --dir $HOME/clusterconfig
```

## Example output

```
? SSH Public Key ...
INFO Credentials loaded from the "myprofile" profile in file "/home/myuser/.aws/credentials"
INFO Consuming Install Config from target directory
INFO Manifests created in: $HOME/clusterconfig/manifests and
$HOME/clusterconfig/openshift
```

- Optional: Confirm that the installation program created manifests in the **clusterconfig/openshift** directory:

```
$ ls $HOME/clusterconfig/openshift/
```

## Example output

```
99_kubeadmin-password-secret.yaml
99_openshift-cluster-api_master-machines-0.yaml
99_openshift-cluster-api_master-machines-1.yaml
99_openshift-cluster-api_master-machines-2.yaml
...
```

- Create a Butane config that configures the additional partition. For example, name the file **\$HOME/clusterconfig/98-var-partition.bu**, change the disk device name to the name of the storage device on the **worker** systems, and set the storage size as appropriate. This example places the **/var** directory on a separate partition:

```
variant: openshift
version: 4.10.0
metadata:
  labels:
    machineconfiguration.openshift.io/role: worker
  name: 98-var-partition
storage:
  disks:
    - device: /dev/<device_name> 1
    partitions:
      - label: var
        start_mib: <partition_start_offset> 2
        size_mib: <partition_size> 3
    filesystems:
      - device: /dev/disk/by-partlabel/var
        path: /var
        format: xfs
        mount_options: [defaults, prjquota] 4
        with_mount_unit: true
```

- 1 The storage device name of the disk that you want to partition.
- 2 When adding a data partition to the boot disk, a minimum value of 25000 MiB (Mebibytes) is recommended. The root file system is automatically resized to fill all available space up to the specified offset. If no value is specified, or if the specified value is smaller than the recommended minimum, the resulting root file system will be too small, and future reinstalls of RHCOS might overwrite the beginning of the data partition.

- 3 The size of the data partition in mebibytes.
- 4 The **prjquota** mount option must be enabled for filesystems used for container storage.

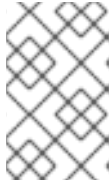

#### NOTE

When creating a separate **/var** partition, you cannot use different instance types for worker nodes, if the different instance types do not have the same device name.

5. Create a manifest from the Butane config and save it to the **clusterconfig/openshift** directory. For example, run the following command:

```
$ butane $HOME/clusterconfig/98-var-partition.bu -o $HOME/clusterconfig/openshift/98-var-partition.yaml
```

6. Run **openshift-install** again to create Ignition configs from a set of files in the **manifest** and **openshift** subdirectories:

```
$ openshift-install create ignition-configs --dir $HOME/clusterconfig
$ ls $HOME/clusterconfig/
auth bootstrap.ign master.ign metadata.json worker.ign
```

Now you can use the Ignition config files as input to the installation procedures to install Red Hat Enterprise Linux CoreOS (RHCOS) systems.

#### 5.14.7.2. Creating the installation configuration file

Generate and customize the installation configuration file that the installation program needs to deploy your cluster.

##### Prerequisites

- You obtained the OpenShift Container Platform installation program for user-provisioned infrastructure and the pull secret for your cluster. For a restricted network installation, these files are on your mirror host.
- You checked that you are deploying your cluster to a region with an accompanying Red Hat Enterprise Linux CoreOS (RHCOS) AMI published by Red Hat. If you are deploying to a region that requires a custom AMI, such as an AWS GovCloud region, you must create the **install-config.yaml** file manually.

##### Procedure

1. Create the **install-config.yaml** file.
  - a. Change to the directory that contains the installation program and run the following command:

```
$ ./openshift-install create install-config --dir <installation_directory> 1
```

- 1 For **<installation\_directory>**, specify the directory name to store the files that the installation program creates.



## IMPORTANT

Specify an empty directory. Some installation assets, like bootstrap X.509 certificates have short expiration intervals, so you must not reuse an installation directory. If you want to reuse individual files from another cluster installation, you can copy them into your directory. However, the file names for the installation assets might change between releases. Use caution when copying installation files from an earlier OpenShift Container Platform version.

- b. At the prompts, provide the configuration details for your cloud:
  - i. Optional: Select an SSH key to use to access your cluster machines.



## NOTE

For production OpenShift Container Platform clusters on which you want to perform installation debugging or disaster recovery, specify an SSH key that your **ssh-agent** process uses.

- ii. Select **aws** as the platform to target.
- iii. If you do not have an AWS profile stored on your computer, enter the AWS access key ID and secret access key for the user that you configured to run the installation program.



## NOTE

The AWS access key ID and secret access key are stored in `~/.aws/credentials` in the home directory of the current user on the installation host. You are prompted for the credentials by the installation program if the credentials for the exported profile are not present in the file. Any credentials that you provide to the installation program are stored in the file.

- iv. Select the AWS region to deploy the cluster to.
  - v. Select the base domain for the Route 53 service that you configured for your cluster.
  - vi. Enter a descriptive name for your cluster.
  - vii. Paste the [pull secret from the Red Hat OpenShift Cluster Manager](#) .
2. Edit the **install-config.yaml** file to give the additional information that is required for an installation in a restricted network.
    - a. Update the **pullSecret** value to contain the authentication information for your registry:

```
pullSecret: '{"auths":{"<local_registry>": {"auth": "<credentials>","email": "you@example.com"}}}'
```

For **<local\_registry>**, specify the registry domain name, and optionally the port, that your mirror registry uses to serve content. For example **registry.example.com** or **registry.example.com:5000**. For **<credentials>**, specify the base64-encoded user name and password for your mirror registry.



- b. Add the **additionalTrustBundle** parameter and value. The value must be the contents of the certificate file that you used for your mirror registry. The certificate file can be an existing, trusted certificate authority or the self-signed certificate that you generated for the mirror registry.

```
additionalTrustBundle: |
  -----BEGIN CERTIFICATE-----

  /-----END CERTIFICATE-----
```

- c. Add the image content resources:

```
imageContentSources:
- mirrors:
  - <local_registry>/<local_repository_name>/release
  source: quay.io/openshift-release-dev/ocp-release
- mirrors:
  - <local_registry>/<local_repository_name>/release
  source: quay.io/openshift-release-dev/ocp-v4.0-art-dev
```

Use the **imageContentSources** section from the output of the command to mirror the repository or the values that you used when you mirrored the content from the media that you brought into your restricted network.

- d. Optional: Set the publishing strategy to **Internal**:

```
publish: Internal
```

By setting this option, you create an internal Ingress Controller and a private load balancer.

3. Optional: Back up the **install-config.yaml** file.

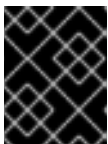

### IMPORTANT

The **install-config.yaml** file is consumed during the installation process. If you want to reuse the file, you must back it up now.

### Additional resources

- See [Configuration and credential file settings](#) in the AWS documentation for more information about AWS profile and credential configuration.

### 5.14.7.3. Configuring the cluster-wide proxy during installation

Production environments can deny direct access to the internet and instead have an HTTP or HTTPS proxy available. You can configure a new OpenShift Container Platform cluster to use a proxy by configuring the proxy settings in the **install-config.yaml** file.

### Prerequisites

- You have an existing **install-config.yaml** file.
- You reviewed the sites that your cluster requires access to and determined whether any of

them need to bypass the proxy. By default, all cluster egress traffic is proxied, including calls to hosting cloud provider APIs. You added sites to the **Proxy** object's **spec.noProxy** field to bypass the proxy if necessary.



## NOTE

The **Proxy** object **status.noProxy** field is populated with the values of the **networking.machineNetwork[].cidr**, **networking.clusterNetwork[].cidr**, and **networking.serviceNetwork[]** fields from your installation configuration.

For installations on Amazon Web Services (AWS), Google Cloud Platform (GCP), Microsoft Azure, and Red Hat OpenStack Platform (RHOSP), the **Proxy** object **status.noProxy** field is also populated with the instance metadata endpoint (**169.254.169.254**).

- You have added the **ec2.<region>.amazonaws.com**, **elasticloadbalancing.<region>.amazonaws.com**, and **s3.<region>.amazonaws.com** endpoints to your VPC endpoint. These endpoints are required to complete requests from the nodes to the AWS EC2 API. Because the proxy works on the container level, not the node level, you must route these requests to the AWS EC2 API through the AWS private network. Adding the public IP address of the EC2 API to your allowlist in your proxy server is not sufficient.

## Procedure

- Edit your **install-config.yaml** file and add the proxy settings. For example:

```
apiVersion: v1
baseDomain: my.domain.com
proxy:
  httpProxy: http://<username>:<pswd>@<ip>:<port> 1
  httpsProxy: https://<username>:<pswd>@<ip>:<port> 2
  noProxy: example.com 3
  additionalTrustBundle: | 4
    -----BEGIN CERTIFICATE-----
    <MY_TRUSTED_CA_CERT>
    -----END CERTIFICATE-----
  ...
```

- A proxy URL to use for creating HTTP connections outside the cluster. The URL scheme must be **http**.
- A proxy URL to use for creating HTTPS connections outside the cluster.
- A comma-separated list of destination domain names, IP addresses, or other network CIDRs to exclude from proxying. Preface a domain with **.** to match subdomains only. For example, **.y.com** matches **x.y.com**, but not **y.com**. Use **\*** to bypass the proxy for all destinations.
- If provided, the installation program generates a config map that is named **user-ca-bundle** in the **openshift-config** namespace that contains one or more additional CA certificates that are required for proxying HTTPS connections. The Cluster Network Operator then creates a **trusted-ca-bundle** config map that merges these contents with the Red Hat Enterprise Linux CoreOS (RHCOS) trust bundle, and this config map is referenced in the **trustedCA** field of the **Proxy** object. The **additionalTrustBundle** field is required unless the proxy's identity certificate is signed by an authority from the RHCOS trust bundle.

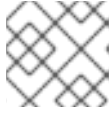
**NOTE**

The installation program does not support the proxy **readinessEndpoints** field.

**NOTE**

If the installer times out, restart and then complete the deployment by using the **wait-for** command of the installer. For example:

```
$ ./openshift-install wait-for install-complete --log-level debug
```

2. Save the file and reference it when installing OpenShift Container Platform.

The installation program creates a cluster-wide proxy that is named **cluster** that uses the proxy settings in the provided **install-config.yaml** file. If no proxy settings are provided, a **cluster Proxy** object is still created, but it will have a nil **spec**.

**NOTE**

Only the **Proxy** object named **cluster** is supported, and no additional proxies can be created.

#### 5.14.7.4. Creating the Kubernetes manifest and Ignition config files

Because you must modify some cluster definition files and manually start the cluster machines, you must generate the Kubernetes manifest and Ignition config files that the cluster needs to configure the machines.

The installation configuration file transforms into the Kubernetes manifests. The manifests wrap into the Ignition configuration files, which are later used to configure the cluster machines.

**IMPORTANT**

- The Ignition config files that the OpenShift Container Platform installation program generates contain certificates that expire after 24 hours, which are then renewed at that time. If the cluster is shut down before renewing the certificates and the cluster is later restarted after the 24 hours have elapsed, the cluster automatically recovers the expired certificates. The exception is that you must manually approve the pending **node-bootstrapper** certificate signing requests (CSRs) to recover kubelet certificates. See the documentation for *Recovering from expired control plane certificates* for more information.
- It is recommended that you use Ignition config files within 12 hours after they are generated because the 24-hour certificate rotates from 16 to 22 hours after the cluster is installed. By using the Ignition config files within 12 hours, you can avoid installation failure if the certificate update runs during installation.

#### Prerequisites

- You obtained the OpenShift Container Platform installation program. For a restricted network installation, these files are on your mirror host.
- You created the **install-config.yaml** installation configuration file.

## Procedure

1. Change to the directory that contains the OpenShift Container Platform installation program and generate the Kubernetes manifests for the cluster:

```
$ ./openshift-install create manifests --dir <installation_directory> 1
```

- 1** For **<installation\_directory>**, specify the installation directory that contains the **install-config.yaml** file you created.

2. Remove the Kubernetes manifest files that define the control plane machines:

```
$ rm -f <installation_directory>/openshift/99_openshift-cluster-api_master-machines-*.yaml
```

By removing these files, you prevent the cluster from automatically generating control plane machines.

3. Remove the Kubernetes manifest files that define the worker machines:

```
$ rm -f <installation_directory>/openshift/99_openshift-cluster-api_worker-machineset-*.yaml
```

Because you create and manage the worker machines yourself, you do not need to initialize these machines.

4. Check that the **mastersSchedulable** parameter in the **<installation\_directory>/manifests/cluster-scheduler-02-config.yaml** Kubernetes manifest file is set to **false**. This setting prevents pods from being scheduled on the control plane machines:

- a. Open the **<installation\_directory>/manifests/cluster-scheduler-02-config.yaml** file.
- b. Locate the **mastersSchedulable** parameter and ensure that it is set to **false**.
- c. Save and exit the file.

5. Optional: If you do not want [the Ingress Operator](#) to create DNS records on your behalf, remove the **privateZone** and **publicZone** sections from the **<installation\_directory>/manifests/cluster-dns-02-config.yaml** DNS configuration file:

```
apiVersion: config.openshift.io/v1
kind: DNS
metadata:
  creationTimestamp: null
  name: cluster
spec:
  baseDomain: example.openshift.com
  privateZone: 1
    id: mycluster-100419-private-zone
  publicZone: 2
    id: example.openshift.com
status: {}
```

- 1** **2** Remove this section completely.

If you do so, you must add ingress DNS records manually in a later step.

- To create the Ignition configuration files, run the following command from the directory that contains the installation program:

```
$ ./openshift-install create ignition-configs --dir <installation_directory> 1
```

- For **<installation\_directory>**, specify the same installation directory.

Ignition config files are created for the bootstrap, control plane, and compute nodes in the installation directory. The **kubeadmin-password** and **kubeconfig** files are created in the **./<installation\_directory>/auth** directory:

```
.
├── auth
│   ├── kubeadmin-password
│   └── kubeconfig
├── bootstrap.ign
├── master.ign
├── metadata.json
└── worker.ign
```

### 5.14.8. Extracting the infrastructure name

The Ignition config files contain a unique cluster identifier that you can use to uniquely identify your cluster in Amazon Web Services (AWS). The infrastructure name is also used to locate the appropriate AWS resources during an OpenShift Container Platform installation. The provided CloudFormation templates contain references to this infrastructure name, so you must extract it.

#### Prerequisites

- You obtained the OpenShift Container Platform installation program and the pull secret for your cluster.
- You generated the Ignition config files for your cluster.
- You installed the **jq** package.

#### Procedure

- To extract and view the infrastructure name from the Ignition config file metadata, run the following command:

```
$ jq -r .infraID <installation_directory>/metadata.json 1
```

- For **<installation\_directory>**, specify the path to the directory that you stored the installation files in.

#### Example output

```
openshift-vw9j6 1
```

- 1 The output of this command is your cluster name and a random string.

### 5.14.9. Creating a VPC in AWS

You must create a Virtual Private Cloud (VPC) in Amazon Web Services (AWS) for your OpenShift Container Platform cluster to use. You can customize the VPC to meet your requirements, including VPN and route tables.

You can use the provided CloudFormation template and a custom parameter file to create a stack of AWS resources that represent the VPC.



#### NOTE

If you do not use the provided CloudFormation template to create your AWS infrastructure, you must review the provided information and manually create the infrastructure. If your cluster does not initialize correctly, you might have to contact Red Hat support with your installation logs.

#### Prerequisites

- You configured an AWS account.
- You added your AWS keys and region to your local AWS profile by running **aws configure**.
- You generated the Ignition config files for your cluster.

#### Procedure

1. Create a JSON file that contains the parameter values that the template requires:

```
[
  {
    "ParameterKey": "VpcCidr", 1
    "ParameterValue": "10.0.0.0/16" 2
  },
  {
    "ParameterKey": "AvailabilityZoneCount", 3
    "ParameterValue": "1" 4
  },
  {
    "ParameterKey": "SubnetBits", 5
    "ParameterValue": "12" 6
  }
]
```

- 1 The CIDR block for the VPC.
- 2 Specify a CIDR block in the format **x.x.x.x/16-24**.
- 3 The number of availability zones to deploy the VPC in.
- 4 Specify an integer between **1** and **3**.

- 5 The size of each subnet in each availability zone.
  - 6 Specify an integer between **5** and **13**, where **5** is **/27** and **13** is **/19**.
2. Copy the template from the **CloudFormation template for the VPC** section of this topic and save it as a YAML file on your computer. This template describes the VPC that your cluster requires.
  3. Launch the CloudFormation template to create a stack of AWS resources that represent the VPC:



### IMPORTANT

You must enter the command on a single line.

```
$ aws cloudformation create-stack --stack-name <name> 1
  --template-body file://<template>.yaml 2
  --parameters file://<parameters>.json 3
```

- 1 **<name>** is the name for the CloudFormation stack, such as **cluster-vpc**. You need the name of this stack if you remove the cluster.
- 2 **<template>** is the relative path to and name of the CloudFormation template YAML file that you saved.
- 3 **<parameters>** is the relative path to and name of the CloudFormation parameters JSON file.

### Example output

```
arn:aws:cloudformation:us-east-1:269333783861:stack/cluster-vpc/dbedae40-2fd3-11eb-820e-12a48460849f
```

4. Confirm that the template components exist:

```
$ aws cloudformation describe-stacks --stack-name <name>
```

After the **StackStatus** displays **CREATE\_COMPLETE**, the output displays values for the following parameters. You must provide these parameter values to the other CloudFormation templates that you run to create your cluster:

<b>VpcId</b>	The ID of your VPC.
<b>PublicSubnetIds</b>	The IDs of the new public subnets.
<b>PrivateSubnetIds</b>	The IDs of the new private subnets.

### 5.14.9.1. CloudFormation template for the VPC

You can use the following CloudFormation template to deploy the VPC that you need for your OpenShift Container Platform cluster.

#### Example 5.65. CloudFormation template for the VPC

```

AWSTemplateFormatVersion: 2010-09-09
Description: Template for Best Practice VPC with 1-3 AZs

Parameters:
  VpcCidr:
    AllowedPattern: ^(([0-9]|[1-9][0-9]|1[0-9]{2}|2[0-4][0-9]|25[0-5]).){3}([0-9]|[1-9][0-9]|1[0-9]{2}|2[0-4][0-9]|25[0-5])(\.(1[6-9]|2[0-4]))$
    ConstraintDescription: CIDR block parameter must be in the form x.x.x.x/16-24.
    Default: 10.0.0.0/16
    Description: CIDR block for VPC.
    Type: String
  AvailabilityZoneCount:
    ConstraintDescription: "The number of availability zones. (Min: 1, Max: 3)"
    MinValue: 1
    MaxValue: 3
    Default: 1
    Description: "How many AZs to create VPC subnets for. (Min: 1, Max: 3)"
    Type: Number
  SubnetBits:
    ConstraintDescription: CIDR block parameter must be in the form x.x.x.x/19-27.
    MinValue: 5
    MaxValue: 13
    Default: 12
    Description: "Size of each subnet to create within the availability zones. (Min: 5 = /27, Max: 13 = /19)"
    Type: Number

Metadata:
  AWS::CloudFormation::Interface:
    ParameterGroups:
      - Label:
          default: "Network Configuration"
        Parameters:
          - VpcCidr
          - SubnetBits
      - Label:
          default: "Availability Zones"
        Parameters:
          - AvailabilityZoneCount
    ParameterLabels:
      AvailabilityZoneCount:
        default: "Availability Zone Count"
      VpcCidr:
        default: "VPC CIDR"
      SubnetBits:
        default: "Bits Per Subnet"

Conditions:
  DoAz3: !Equals [3, !Ref AvailabilityZoneCount]

```



DoAz2: !Or [!Equals [2, !Ref AvailabilityZoneCount], Condition: DoAz3]

Resources:

VPC:

Type: "AWS::EC2::VPC"

Properties:

EnableDnsSupport: "true"

EnableDnsHostnames: "true"

CidrBlock: !Ref VpcCidr

PublicSubnet:

Type: "AWS::EC2::Subnet"

Properties:

VpcId: !Ref VPC

CidrBlock: !Select [0, !Cidr [!Ref VpcCidr, 6, !Ref SubnetBits]]

AvailabilityZone: !Select

- 0

- Fn::GetAZs: !Ref "AWS::Region"

PublicSubnet2:

Type: "AWS::EC2::Subnet"

Condition: DoAz2

Properties:

VpcId: !Ref VPC

CidrBlock: !Select [1, !Cidr [!Ref VpcCidr, 6, !Ref SubnetBits]]

AvailabilityZone: !Select

- 1

- Fn::GetAZs: !Ref "AWS::Region"

PublicSubnet3:

Type: "AWS::EC2::Subnet"

Condition: DoAz3

Properties:

VpcId: !Ref VPC

CidrBlock: !Select [2, !Cidr [!Ref VpcCidr, 6, !Ref SubnetBits]]

AvailabilityZone: !Select

- 2

- Fn::GetAZs: !Ref "AWS::Region"

InternetGateway:

Type: "AWS::EC2::InternetGateway"

GatewayToInternet:

Type: "AWS::EC2::VPCEGatewayAttachment"

Properties:

VpcId: !Ref VPC

InternetGatewayId: !Ref InternetGateway

PublicRouteTable:

Type: "AWS::EC2::RouteTable"

Properties:

VpcId: !Ref VPC

PublicRoute:

Type: "AWS::EC2::Route"

DependsOn: GatewayToInternet

Properties:

RouteTableId: !Ref PublicRouteTable

DestinationCidrBlock: 0.0.0.0/0

GatewayId: !Ref InternetGateway

PublicSubnetRouteTableAssociation:

Type: "AWS::EC2::SubnetRouteTableAssociation"

Properties:

```
SubnetId: !Ref PublicSubnet
RouteTableId: !Ref PublicRouteTable
PublicSubnetRouteTableAssociation2:
  Type: "AWS::EC2::SubnetRouteTableAssociation"
  Condition: DoAz2
  Properties:
    SubnetId: !Ref PublicSubnet2
    RouteTableId: !Ref PublicRouteTable
PublicSubnetRouteTableAssociation3:
  Condition: DoAz3
  Type: "AWS::EC2::SubnetRouteTableAssociation"
  Properties:
    SubnetId: !Ref PublicSubnet3
    RouteTableId: !Ref PublicRouteTable
PrivateSubnet:
  Type: "AWS::EC2::Subnet"
  Properties:
    VpcId: !Ref VPC
    CidrBlock: !Select [3, !Cidr [!Ref VpcCidr, 6, !Ref SubnetBits]]
    AvailabilityZone: !Select
      - 0
      - Fn::GetAZs: !Ref "AWS::Region"
PrivateRouteTable:
  Type: "AWS::EC2::RouteTable"
  Properties:
    VpcId: !Ref VPC
PrivateSubnetRouteTableAssociation:
  Type: "AWS::EC2::SubnetRouteTableAssociation"
  Properties:
    SubnetId: !Ref PrivateSubnet
    RouteTableId: !Ref PrivateRouteTable
NAT:
  DependsOn:
    - GatewayToInternet
  Type: "AWS::EC2::NatGateway"
  Properties:
    AllocationId:
      "Fn::GetAtt":
        - EIP
        - AllocationId
    SubnetId: !Ref PublicSubnet
EIP:
  Type: "AWS::EC2::EIP"
  Properties:
    Domain: vpc
Route:
  Type: "AWS::EC2::Route"
  Properties:
    RouteTableId:
      Ref: PrivateRouteTable
    DestinationCidrBlock: 0.0.0.0/0
    NatGatewayId:
      Ref: NAT
PrivateSubnet2:
  Type: "AWS::EC2::Subnet"
  Condition: DoAz2
```

```

Properties:
  VpcId: !Ref VPC
  CidrBlock: !Select [4, !Cidr [!Ref VpcCidr, 6, !Ref SubnetBits]]
  AvailabilityZone: !Select
    - 1
    - Fn::GetAZs: !Ref "AWS::Region"
PrivateRouteTable2:
  Type: "AWS::EC2::RouteTable"
  Condition: DoAz2
  Properties:
    VpcId: !Ref VPC
PrivateSubnetRouteTableAssociation2:
  Type: "AWS::EC2::SubnetRouteTableAssociation"
  Condition: DoAz2
  Properties:
    SubnetId: !Ref PrivateSubnet2
    RouteTableId: !Ref PrivateRouteTable2
NAT2:
  DependsOn:
    - GatewayToInternet
  Type: "AWS::EC2::NatGateway"
  Condition: DoAz2
  Properties:
    AllocationId:
      "Fn::GetAtt":
        - EIP2
        - AllocationId
    SubnetId: !Ref PublicSubnet2
EIP2:
  Type: "AWS::EC2::EIP"
  Condition: DoAz2
  Properties:
    Domain: vpc
Route2:
  Type: "AWS::EC2::Route"
  Condition: DoAz2
  Properties:
    RouteTableId:
      Ref: PrivateRouteTable2
    DestinationCidrBlock: 0.0.0.0/0
    NatGatewayId:
      Ref: NAT2
PrivateSubnet3:
  Type: "AWS::EC2::Subnet"
  Condition: DoAz3
  Properties:
    VpcId: !Ref VPC
    CidrBlock: !Select [5, !Cidr [!Ref VpcCidr, 6, !Ref SubnetBits]]
    AvailabilityZone: !Select
      - 2
      - Fn::GetAZs: !Ref "AWS::Region"
PrivateRouteTable3:
  Type: "AWS::EC2::RouteTable"
  Condition: DoAz3
  Properties:
    VpcId: !Ref VPC

```

```

PrivateSubnetRouteTableAssociation3:
  Type: "AWS::EC2::SubnetRouteTableAssociation"
  Condition: DoAz3
  Properties:
    SubnetId: !Ref PrivateSubnet3
    RouteTableId: !Ref PrivateRouteTable3
NAT3:
  DependsOn:
  - GatewayToInternet
  Type: "AWS::EC2::NatGateway"
  Condition: DoAz3
  Properties:
    AllocationId:
      "Fn::GetAtt":
      - EIP3
      - AllocationId
    SubnetId: !Ref PublicSubnet3
EIP3:
  Type: "AWS::EC2::EIP"
  Condition: DoAz3
  Properties:
    Domain: vpc
Route3:
  Type: "AWS::EC2::Route"
  Condition: DoAz3
  Properties:
    RouteTableId:
      Ref: PrivateRouteTable3
    DestinationCidrBlock: 0.0.0.0/0
    NatGatewayId:
      Ref: NAT3
S3Endpoint:
  Type: AWS::EC2::VPCEndpoint
  Properties:
    PolicyDocument:
      Version: 2012-10-17
      Statement:
      - Effect: Allow
        Principal: '*'
        Action:
          - '*'
        Resource:
          - '*'
    RouteTableIds:
      - !Ref PublicRouteTable
      - !Ref PrivateRouteTable
      - !If [DoAz2, !Ref PrivateRouteTable2, !Ref "AWS::NoValue"]
      - !If [DoAz3, !Ref PrivateRouteTable3, !Ref "AWS::NoValue"]
    ServiceName: !Join
      - ""
      - - com.amazonaws.
        - !Ref 'AWS::Region'
        - .s3
    VpcId: !Ref VPC

```

```
Outputs:
```

```

VpcId:
  Description: ID of the new VPC.
  Value: !Ref VPC
PublicSubnetIds:
  Description: Subnet IDs of the public subnets.
  Value:
    !Join [
      ",",
      [!Ref PublicSubnet, !If [DoAz2, !Ref PublicSubnet2, !Ref "AWS::NoValue"], !If [DoAz3, !Ref
PublicSubnet3, !Ref "AWS::NoValue"]]
    ]
PrivateSubnetIds:
  Description: Subnet IDs of the private subnets.
  Value:
    !Join [
      ",",
      [!Ref PrivateSubnet, !If [DoAz2, !Ref PrivateSubnet2, !Ref "AWS::NoValue"], !If [DoAz3, !Ref
PrivateSubnet3, !Ref "AWS::NoValue"]]
    ]

```

### 5.14.10. Creating networking and load balancing components in AWS

You must configure networking and classic or network load balancing in Amazon Web Services (AWS) that your OpenShift Container Platform cluster can use.

You can use the provided CloudFormation template and a custom parameter file to create a stack of AWS resources. The stack represents the networking and load balancing components that your OpenShift Container Platform cluster requires. The template also creates a hosted zone and subnet tags.

You can run the template multiple times within a single Virtual Private Cloud (VPC).

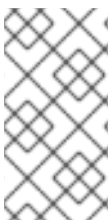

#### NOTE

If you do not use the provided CloudFormation template to create your AWS infrastructure, you must review the provided information and manually create the infrastructure. If your cluster does not initialize correctly, you might have to contact Red Hat support with your installation logs.

#### Prerequisites

- You configured an AWS account.
- You added your AWS keys and region to your local AWS profile by running **aws configure**.
- You generated the Ignition config files for your cluster.
- You created and configured a VPC and associated subnets in AWS.

#### Procedure

1. Obtain the hosted zone ID for the Route 53 base domain that you specified in the **install-config.yaml** file for your cluster. You can obtain details about your hosted zone by running the following command:

```
$ aws route53 list-hosted-zones-by-name --dns-name <route53_domain> 1
```

- 1** For the **<route53\_domain>**, specify the Route 53 base domain that you used when you generated the **install-config.yaml** file for the cluster.

### Example output

```
mycluster.example.com. False 100
HOSTEDZONES 65F8F38E-2268-B835-E15C-AB55336FCBFA
/hostedzone/Z21IXYZABCZ2A4 mycluster.example.com. 10
```

In the example output, the hosted zone ID is **Z21IXYZABCZ2A4**.

- Create a JSON file that contains the parameter values that the template requires:

```
[
  {
    "ParameterKey": "ClusterName", 1
    "ParameterValue": "mycluster" 2
  },
  {
    "ParameterKey": "InfrastructureName", 3
    "ParameterValue": "mycluster-<random_string>" 4
  },
  {
    "ParameterKey": "HostedZoneId", 5
    "ParameterValue": "<random_string>" 6
  },
  {
    "ParameterKey": "HostedZoneName", 7
    "ParameterValue": "example.com" 8
  },
  {
    "ParameterKey": "PublicSubnets", 9
    "ParameterValue": "subnet-<random_string>" 10
  },
  {
    "ParameterKey": "PrivateSubnets", 11
    "ParameterValue": "subnet-<random_string>" 12
  },
  {
    "ParameterKey": "VpcId", 13
    "ParameterValue": "vpc-<random_string>" 14
  }
]
```

- 1** A short, representative cluster name to use for hostnames, etc.
- 2** Specify the cluster name that you used when you generated the **install-config.yaml** file for the cluster.
- 3** The name for your cluster infrastructure that is encoded in your Ignition config files for the

- 4 Specify the infrastructure name that you extracted from the Ignition config file metadata, which has the format **<cluster-name>-<random-string>**.
  - 5 The Route 53 public zone ID to register the targets with.
  - 6 Specify the Route 53 public zone ID, which as a format similar to **Z21IXYZABCZ2A4**. You can obtain this value from the AWS console.
  - 7 The Route 53 zone to register the targets with.
  - 8 Specify the Route 53 base domain that you used when you generated the **install-config.yaml** file for the cluster. Do not include the trailing period (.) that is displayed in the AWS console.
  - 9 The public subnets that you created for your VPC.
  - 10 Specify the **PublicSubnetIds** value from the output of the CloudFormation template for the VPC.
  - 11 The private subnets that you created for your VPC.
  - 12 Specify the **PrivateSubnetIds** value from the output of the CloudFormation template for the VPC.
  - 13 The VPC that you created for the cluster.
  - 14 Specify the **VpcId** value from the output of the CloudFormation template for the VPC.
3. Copy the template from the **CloudFormation template for the network and load balancers** section of this topic and save it as a YAML file on your computer. This template describes the networking and load balancing objects that your cluster requires.



#### IMPORTANT

If you are deploying your cluster to an AWS government or secret region, you must update the **InternalApiServerRecord** in the CloudFormation template to use **CNAME** records. Records of type **ALIAS** are not supported for AWS government regions.

4. Launch the CloudFormation template to create a stack of AWS resources that provide the networking and load balancing components:

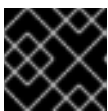

#### IMPORTANT

You must enter the command on a single line.

```
$ aws cloudformation create-stack --stack-name <name> 1
  --template-body file://<template>.yaml 2
  --parameters file://<parameters>.json 3
  --capabilities CAPABILITY_NAMED_IAM 4
```

- 1 **<name>** is the name for the CloudFormation stack, such as **cluster-dns**. You need the name of this stack if you remove the cluster.

- 2 **<template>** is the relative path to and name of the CloudFormation template YAML file that you saved.
- 3 **<parameters>** is the relative path to and name of the CloudFormation parameters JSON file.
- 4 You must explicitly declare the **CAPABILITY\_NAMED\_IAM** capability because the provided template creates some **AWS::IAM::Role** resources.

### Example output

```
arn:aws:cloudformation:us-east-1:269333783861:stack/cluster-dns/cd3e5de0-2fd4-11eb-5cf0-12be5c33a183
```

5. Confirm that the template components exist:

```
$ aws cloudformation describe-stacks --stack-name <name>
```

After the **StackStatus** displays **CREATE\_COMPLETE**, the output displays values for the following parameters. You must provide these parameter values to the other CloudFormation templates that you run to create your cluster:

<b>PrivateHostedZoneId</b>	Hosted zone ID for the private DNS.
<b>ExternalApiLoadBalancerName</b>	Full name of the external API load balancer.
<b>InternalApiLoadBalancerName</b>	Full name of the internal API load balancer.
<b>ApiServerDnsName</b>	Full hostname of the API server.
<b>RegisterNlbTargetGroupsLambda</b>	Lambda ARN useful to help register/deregister IP targets for these load balancers.
<b>ExternalApiTargetGroupArn</b>	ARN of external API target group.
<b>InternalApiTargetGroupArn</b>	ARN of internal API target group.



<b>InternalServiceTargetGroupArn</b>	ARN of internal service target group.
--------------------------------------	---------------------------------------

### 5.14.10.1. CloudFormation template for the network and load balancers

You can use the following CloudFormation template to deploy the networking objects and load balancers that you need for your OpenShift Container Platform cluster.

#### Example 5.66. CloudFormation template for the network and load balancers

```

AWSTemplateFormatVersion: 2010-09-09
Description: Template for OpenShift Cluster Network Elements (Route53 & LBs)

Parameters:
  ClusterName:
    AllowedPattern: ^([a-zA-Z][a-zA-Z0-9\-\-]{0,26})$
    MaxLength: 27
    MinLength: 1
    ConstraintDescription: Cluster name must be alphanumeric, start with a letter, and have a
    maximum of 27 characters.
    Description: A short, representative cluster name to use for host names and other identifying
    names.
    Type: String
  InfrastructureName:
    AllowedPattern: ^([a-zA-Z][a-zA-Z0-9\-\-]{0,26})$
    MaxLength: 27
    MinLength: 1
    ConstraintDescription: Infrastructure name must be alphanumeric, start with a letter, and have a
    maximum of 27 characters.
    Description: A short, unique cluster ID used to tag cloud resources and identify items owned or
    used by the cluster.
    Type: String
  HostedZoneId:
    Description: The Route53 public zone ID to register the targets with, such as
    Z21IXYZABCZ2A4.
    Type: String
  HostedZoneName:
    Description: The Route53 zone to register the targets with, such as example.com. Omit the
    trailing period.
    Type: String
    Default: "example.com"
  PublicSubnets:
    Description: The internet-facing subnets.
    Type: List<AWS::EC2::Subnet::Id>
  PrivateSubnets:
    Description: The internal subnets.
    Type: List<AWS::EC2::Subnet::Id>
  VpcId:
    Description: The VPC-scoped resources will belong to this VPC.
    Type: AWS::EC2::VPC::Id

Metadata:
```

```
AWS::CloudFormation::Interface:
  ParameterGroups:
  - Label:
    default: "Cluster Information"
    Parameters:
    - ClusterName
    - InfrastructureName
  - Label:
    default: "Network Configuration"
    Parameters:
    - VpcId
    - PublicSubnets
    - PrivateSubnets
  - Label:
    default: "DNS"
    Parameters:
    - HostedZoneName
    - HostedZoneId
  ParameterLabels:
  ClusterName:
    default: "Cluster Name"
  InfrastructureName:
    default: "Infrastructure Name"
  VpcId:
    default: "VPC ID"
  PublicSubnets:
    default: "Public Subnets"
  PrivateSubnets:
    default: "Private Subnets"
  HostedZoneName:
    default: "Public Hosted Zone Name"
  HostedZoneId:
    default: "Public Hosted Zone ID"

Resources:
  ExtApiElb:
    Type: AWS::ElasticLoadBalancingV2::LoadBalancer
    Properties:
      Name: !Join ["-", [!Ref InfrastructureName, "ext"]]
      IpAddressType: ipv4
      Subnets: !Ref PublicSubnets
      Type: network

  IntApiElb:
    Type: AWS::ElasticLoadBalancingV2::LoadBalancer
    Properties:
      Name: !Join ["-", [!Ref InfrastructureName, "int"]]
      Scheme: internal
      IpAddressType: ipv4
      Subnets: !Ref PrivateSubnets
      Type: network

  IntDns:
    Type: "AWS::Route53::HostedZone"
    Properties:
      HostedZoneConfig:
```

```

    Comment: "Managed by CloudFormation"
    Name: !Join [".", [!Ref ClusterName, !Ref HostedZoneName]]
    HostedZoneTags:
    - Key: Name
      Value: !Join [ "-", [!Ref InfrastructureName, "int"] ]
    - Key: !Join [ "", ["kubernetes.io/cluster/", !Ref InfrastructureName] ]
      Value: "owned"
    VPCs:
    - VPCId: !Ref Vpclid
      VPCRegion: !Ref "AWS::Region"

```

#### ExternalApiServerRecord:

```

Type: AWS::Route53::RecordSetGroup
Properties:
  Comment: Alias record for the API server
  HostedZoneId: !Ref HostedZoneId
  RecordSets:
  - Name:
    !Join [
      ".",
      ["api", !Ref ClusterName, !Join [ "", [!Ref HostedZoneName, "."] ]],
    ]
    Type: A
    AliasTarget:
      HostedZoneId: !GetAtt ExtApiElb.CanonicalHostedZoneID
      DNSName: !GetAtt ExtApiElb.DNSName

```

#### InternalApiServerRecord:

```

Type: AWS::Route53::RecordSetGroup
Properties:
  Comment: Alias record for the API server
  HostedZoneId: !Ref IntDns
  RecordSets:
  - Name:
    !Join [
      ".",
      ["api", !Ref ClusterName, !Join [ "", [!Ref HostedZoneName, "."] ]],
    ]
    Type: A
    AliasTarget:
      HostedZoneId: !GetAtt IntApiElb.CanonicalHostedZoneID
      DNSName: !GetAtt IntApiElb.DNSName
  - Name:
    !Join [
      ".",
      ["api-int", !Ref ClusterName, !Join [ "", [!Ref HostedZoneName, "."] ]],
    ]
    Type: A
    AliasTarget:
      HostedZoneId: !GetAtt IntApiElb.CanonicalHostedZoneID
      DNSName: !GetAtt IntApiElb.DNSName

```

#### ExternalApiListener:

```

Type: AWS::ElasticLoadBalancingV2::Listener
Properties:
  DefaultActions:

```

- Type: forward  
TargetGroupArn:  
Ref: ExternalApiTargetGroup  
LoadBalancerArn:  
Ref: ExtApiElb  
Port: 6443  
Protocol: TCP

ExternalApiTargetGroup:  
Type: AWS::ElasticLoadBalancingV2::TargetGroup  
Properties:  
HealthCheckIntervalSeconds: 10  
HealthCheckPath: "/readyz"  
HealthCheckPort: 6443  
HealthCheckProtocol: HTTPS  
HealthyThresholdCount: 2  
UnhealthyThresholdCount: 2  
Port: 6443  
Protocol: TCP  
TargetType: ip  
VpcId:  
Ref: VpcId  
TargetGroupAttributes:  
- Key: deregistration\_delay.timeout\_seconds  
Value: 60

InternalApiListener:  
Type: AWS::ElasticLoadBalancingV2::Listener  
Properties:  
DefaultActions:  
- Type: forward  
TargetGroupArn:  
Ref: InternalApiTargetGroup  
LoadBalancerArn:  
Ref: IntApiElb  
Port: 6443  
Protocol: TCP

InternalApiTargetGroup:  
Type: AWS::ElasticLoadBalancingV2::TargetGroup  
Properties:  
HealthCheckIntervalSeconds: 10  
HealthCheckPath: "/readyz"  
HealthCheckPort: 6443  
HealthCheckProtocol: HTTPS  
HealthyThresholdCount: 2  
UnhealthyThresholdCount: 2  
Port: 6443  
Protocol: TCP  
TargetType: ip  
VpcId:  
Ref: VpcId  
TargetGroupAttributes:  
- Key: deregistration\_delay.timeout\_seconds  
Value: 60

InternalServiceInternalListener:  
 Type: AWS::ElasticLoadBalancingV2::Listener  
 Properties:  
 DefaultActions:  
 - Type: forward  
 TargetGroupArn:  
 Ref: InternalServiceTargetGroup  
 LoadBalancerArn:  
 Ref: IntApiElb  
 Port: 22623  
 Protocol: TCP

InternalServiceTargetGroup:  
 Type: AWS::ElasticLoadBalancingV2::TargetGroup  
 Properties:  
 HealthCheckIntervalSeconds: 10  
 HealthCheckPath: "/healthz"  
 HealthCheckPort: 22623  
 HealthCheckProtocol: HTTPS  
 HealthyThresholdCount: 2  
 UnhealthyThresholdCount: 2  
 Port: 22623  
 Protocol: TCP  
 TargetType: ip  
 VpId:  
 Ref: VpId  
 TargetGroupAttributes:  
 - Key: deregistration\_delay.timeout\_seconds  
 Value: 60

RegisterTargetLambdalamRole:  
 Type: AWS::IAM::Role  
 Properties:  
 RoleName: !Join ["-", [!Ref InfrastructureName, "nlb", "lambda", "role"]]  
 AssumeRolePolicyDocument:  
 Version: "2012-10-17"  
 Statement:  
 - Effect: "Allow"  
 Principal:  
 Service:  
 - "lambda.amazonaws.com"  
 Action:  
 - "sts:AssumeRole"  
 Path: "/"  
 Policies:  
 - PolicyName: !Join ["-", [!Ref InfrastructureName, "master", "policy"]]  
 PolicyDocument:  
 Version: "2012-10-17"  
 Statement:  
 - Effect: "Allow"  
 Action:  
 [  
 "elasticloadbalancing:RegisterTargets",  
 "elasticloadbalancing:DeregisterTargets",  
 ]  
 Resource: !Ref InternalApiTargetGroup

```

- Effect: "Allow"
  Action:
  [
    "elasticloadbalancing:RegisterTargets",
    "elasticloadbalancing:DeregisterTargets",
  ]
  Resource: !Ref InternalServiceTargetGroup
- Effect: "Allow"
  Action:
  [
    "elasticloadbalancing:RegisterTargets",
    "elasticloadbalancing:DeregisterTargets",
  ]
  Resource: !Ref ExternalApiTargetGroup

```

#### RegisterNlbIpTargets:

```

Type: "AWS::Lambda::Function"
Properties:
  Handler: "index.handler"
  Role:
    Fn::GetAtt:
    - "RegisterTargetLambdalamRole"
    - "Arn"
  Code:
    ZipFile: |
      import json
      import boto3
      import cfnresponse
      def handler(event, context):
        elb = boto3.client('elbv2')
        if event['RequestType'] == 'Delete':
          elb.deregister_targets(TargetGroupArn=event['ResourceProperties']
[TargetArn],Targets=[{'Id': event['ResourceProperties']['TargetIp']})
          elif event['RequestType'] == 'Create':
            elb.register_targets(TargetGroupArn=event['ResourceProperties']['TargetArn'],Targets=
[{'Id': event['ResourceProperties']['TargetIp']})
            responseData = {}
            cfnresponse.send(event, context, cfnresponse.SUCCESS, responseData,
event['ResourceProperties']['TargetArn']+event['ResourceProperties']['TargetIp'])
  Runtime: "python3.7"
  Timeout: 120

```

#### RegisterSubnetTagsLambdalamRole:

```

Type: AWS::IAM::Role
Properties:
  RoleName: !Join ["-", [!Ref InfrastructureName, "subnet-tags-lambda-role"]]
  AssumeRolePolicyDocument:
    Version: "2012-10-17"
    Statement:
    - Effect: "Allow"
      Principal:
        Service:
        - "lambda.amazonaws.com"
      Action:
      - "sts:AssumeRole"
  Path: "/"

```

## Policies:

```
- PolicyName: !Join ["-", [!Ref InfrastructureName, "subnet-tagging-policy"]]
```

## PolicyDocument:

```
Version: "2012-10-17"
```

## Statement:

```
- Effect: "Allow"
```

## Action:

```
[
  "ec2:DeleteTags",
  "ec2:CreateTags"
]
```

```
Resource: "arn:aws:ec2:*:*:subnet/*"
```

```
- Effect: "Allow"
```

## Action:

```
[
  "ec2:DescribeSubnets",
  "ec2:DescribeTags"
]
```

```
Resource: ""
```

## RegisterSubnetTags:

```
Type: "AWS::Lambda::Function"
```

## Properties:

```
Handler: "index.handler"
```

## Role:

```
Fn::GetAtt:
```

```
- "RegisterSubnetTagsLambdalamRole"
```

```
- "Arn"
```

## Code:

```
ZipFile: |
```

```
import json
```

```
import boto3
```

```
import cfnresponse
```

```
def handler(event, context):
```

```
    ec2_client = boto3.client('ec2')
```

```
    if event['RequestType'] == 'Delete':
```

```
        for subnet_id in event['ResourceProperties']['Subnets']:
```

```
            ec2_client.delete_tags(Resources=[subnet_id], Tags=[{'Key': 'kubernetes.io/cluster/' +
```

```
event['ResourceProperties']['InfrastructureName']});
```

```
    elif event['RequestType'] == 'Create':
```

```
        for subnet_id in event['ResourceProperties']['Subnets']:
```

```
            ec2_client.create_tags(Resources=[subnet_id], Tags=[{'Key': 'kubernetes.io/cluster/' +
```

```
event['ResourceProperties']['InfrastructureName'], 'Value': 'shared'}]);
```

```
        responseData = {}
```

```
        cfnresponse.send(event, context, cfnresponse.SUCCESS, responseData,
```

```
event['ResourceProperties']['InfrastructureName']+event['ResourceProperties']['Subnets'][0])
```

```
Runtime: "python3.7"
```

```
Timeout: 120
```

## RegisterPublicSubnetTags:

```
Type: Custom::SubnetRegister
```

## Properties:

```
ServiceToken: !GetAtt RegisterSubnetTags.Arn
```

```
InfrastructureName: !Ref InfrastructureName
```

```
Subnets: !Ref PublicSubnets
```

RegisterPrivateSubnetTags:  
 Type: Custom::SubnetRegister  
 Properties:  
 ServiceToken: !GetAtt RegisterSubnetTags.Arn  
 InfrastructureName: !Ref InfrastructureName  
 Subnets: !Ref PrivateSubnets

#### Outputs:

PrivateHostedZoneId:  
 Description: Hosted zone ID for the private DNS, which is required for private records.  
 Value: !Ref IntDns

ExternalApiLoadBalancerName:  
 Description: Full name of the external API load balancer.  
 Value: !GetAtt ExtApiElb.LoadBalancerFullName

InternalApiLoadBalancerName:  
 Description: Full name of the internal API load balancer.  
 Value: !GetAtt IntApiElb.LoadBalancerFullName

ApiServerDnsName:  
 Description: Full hostname of the API server, which is required for the Ignition config files.  
 Value: !Join [".", ["api-int", !Ref ClusterName, !Ref HostedZoneName]]

RegisterNlbTargetsLambda:  
 Description: Lambda ARN useful to help register or deregister IP targets for these load balancers.  
 Value: !GetAtt RegisterNlbTargets.Arn

ExternalApiTargetGroupArn:  
 Description: ARN of the external API target group.  
 Value: !Ref ExternalApiTargetGroup

InternalApiTargetGroupArn:  
 Description: ARN of the internal API target group.  
 Value: !Ref InternalApiTargetGroup

InternalServiceTargetGroupArn:  
 Description: ARN of the internal service target group.  
 Value: !Ref InternalServiceTargetGroup

## IMPORTANT

If you are deploying your cluster to an AWS government or secret region, you must update the **InternalApiServerRecord** to use **CNAME** records. Records of type **ALIAS** are not supported for AWS government regions. For example:

```
Type: CNAME
TTL: 10
ResourceRecords:
- !GetAtt IntApiElb.DNSName
```

### Additional resources

- See [Listing public hosted zones](#) in the AWS documentation for more information about listing public hosted zones.

## 5.14.11. Creating security group and roles in AWS



You must create security groups and roles in Amazon Web Services (AWS) for your OpenShift Container Platform cluster to use.

You can use the provided CloudFormation template and a custom parameter file to create a stack of AWS resources. The stack represents the security groups and roles that your OpenShift Container Platform cluster requires.



## NOTE

If you do not use the provided CloudFormation template to create your AWS infrastructure, you must review the provided information and manually create the infrastructure. If your cluster does not initialize correctly, you might have to contact Red Hat support with your installation logs.

## Prerequisites

- You configured an AWS account.
- You added your AWS keys and region to your local AWS profile by running **aws configure**.
- You generated the Ignition config files for your cluster.
- You created and configured a VPC and associated subnets in AWS.

## Procedure

1. Create a JSON file that contains the parameter values that the template requires:

```
[
  {
    "ParameterKey": "InfrastructureName", 1
    "ParameterValue": "mycluster-<random_string>" 2
  },
  {
    "ParameterKey": "VpcCidr", 3
    "ParameterValue": "10.0.0.0/16" 4
  },
  {
    "ParameterKey": "PrivateSubnets", 5
    "ParameterValue": "subnet-<random_string>" 6
  },
  {
    "ParameterKey": "VpcId", 7
    "ParameterValue": "vpc-<random_string>" 8
  }
]
```

- 1 The name for your cluster infrastructure that is encoded in your Ignition config files for the cluster.
- 2 Specify the infrastructure name that you extracted from the Ignition config file metadata, which has the format **<cluster-name>-<random-string>**.
- 3 The CIDR block for the VPC.

- 4 Specify the CIDR block parameter that you used for the VPC that you defined in the form **x.x.x.x/16-24**.
  - 5 The private subnets that you created for your VPC.
  - 6 Specify the **PrivateSubnetIds** value from the output of the CloudFormation template for the VPC.
  - 7 The VPC that you created for the cluster.
  - 8 Specify the **VpcId** value from the output of the CloudFormation template for the VPC.
2. Copy the template from the **CloudFormation template for security objects** section of this topic and save it as a YAML file on your computer. This template describes the security groups and roles that your cluster requires.
  3. Launch the CloudFormation template to create a stack of AWS resources that represent the security groups and roles:



### IMPORTANT

You must enter the command on a single line.

```
$ aws cloudformation create-stack --stack-name <name> 1
  --template-body file://<template>.yaml 2
  --parameters file://<parameters>.json 3
  --capabilities CAPABILITY_NAMED_IAM 4
```

- 1 **<name>** is the name for the CloudFormation stack, such as **cluster-sec**. You need the name of this stack if you remove the cluster.
- 2 **<template>** is the relative path to and name of the CloudFormation template YAML file that you saved.
- 3 **<parameters>** is the relative path to and name of the CloudFormation parameters JSON file.
- 4 You must explicitly declare the **CAPABILITY\_NAMED\_IAM** capability because the provided template creates some **AWS::IAM::Role** and **AWS::IAM::InstanceProfile** resources.

### Example output

```
arn:aws:cloudformation:us-east-1:269333783861:stack/cluster-sec/03bd4210-2ed7-11eb-6d7a-13fc0b61e9db
```

4. Confirm that the template components exist:

```
$ aws cloudformation describe-stacks --stack-name <name>
```

After the **StackStatus** displays **CREATE\_COMPLETE**, the output displays values for the following parameters. You must provide these parameter values to the other CloudFormation templates that you run to create your cluster:

<b>MasterSecurityGroupID</b>	Master Security Group ID
<b>WorkerSecurityGroupID</b>	Worker Security Group ID
<b>MasterInstanceProfile</b>	Master IAM Instance Profile
<b>WorkerInstanceProfile</b>	Worker IAM Instance Profile

#### 5.14.11.1. CloudFormation template for security objects

You can use the following CloudFormation template to deploy the security objects that you need for your OpenShift Container Platform cluster.

##### Example 5.67. CloudFormation template for security objects

```
AWSTemplateFormatVersion: 2010-09-09
Description: Template for OpenShift Cluster Security Elements (Security Groups & IAM)

Parameters:
  InfrastructureName:
    AllowedPattern: ^([a-zA-Z][a-zA-Z0-9\-\_]{0,26})$
    MaxLength: 27
    MinLength: 1
    ConstraintDescription: Infrastructure name must be alphanumeric, start with a letter, and have a
    maximum of 27 characters.
    Description: A short, unique cluster ID used to tag cloud resources and identify items owned or
    used by the cluster.
    Type: String
  VpcCidr:
    AllowedPattern: ^((([0-9]{1,3}[0-9]{1,3}[0-9]{1,3}|2[0-4][0-9]{1,3}|25[0-5]).).){3}([0-9]{1,3}|2[0-
    4][0-9]{1,3}|25[0-5])(\V(1[6-9]|2[0-4]))$
    ConstraintDescription: CIDR block parameter must be in the form x.x.x.x/16-24.
    Default: 10.0.0.0/16
    Description: CIDR block for VPC.
    Type: String
  VpcId:
    Description: The VPC-scoped resources will belong to this VPC.
    Type: AWS::EC2::VPC::Id
  PrivateSubnets:
    Description: The internal subnets.
    Type: List<AWS::EC2::Subnet::Id>
```

## Metadata:

AWS::CloudFormation::Interface:

ParameterGroups:

- Label:

default: "Cluster Information"

Parameters:

- InfrastructureName

- Label:

default: "Network Configuration"

Parameters:

- VpcId

- VpcCidr

- PrivateSubnets

ParameterLabels:

InfrastructureName:

default: "Infrastructure Name"

VpcId:

default: "VPC ID"

VpcCidr:

default: "VPC CIDR"

PrivateSubnets:

default: "Private Subnets"

## Resources:

MasterSecurityGroup:

Type: AWS::EC2::SecurityGroup

Properties:

GroupDescription: Cluster Master Security Group

SecurityGroupIngress:

- IpProtocol: icmp

FromPort: 0

ToPort: 0

CidrIp: !Ref VpcCidr

- IpProtocol: tcp

FromPort: 22

ToPort: 22

CidrIp: !Ref VpcCidr

- IpProtocol: tcp

ToPort: 6443

FromPort: 6443

CidrIp: !Ref VpcCidr

- IpProtocol: tcp

FromPort: 22623

ToPort: 22623

CidrIp: !Ref VpcCidr

VpcId: !Ref VpcId

WorkerSecurityGroup:

Type: AWS::EC2::SecurityGroup

Properties:

GroupDescription: Cluster Worker Security Group

SecurityGroupIngress:

- IpProtocol: icmp

FromPort: 0

ToPort: 0

CidrIp: !Ref VpcCidr  
- IpProtocol: tcp  
FromPort: 22  
ToPort: 22  
CidrIp: !Ref VpcCidr  
VpcId: !Ref VpcId

#### MasterIngressEtcd:

Type: AWS::EC2::SecurityGroupIngress  
Properties:  
GroupId: !GetAtt MasterSecurityGroup.GroupId  
SourceSecurityGroupId: !GetAtt MasterSecurityGroup.GroupId  
Description: etcd  
FromPort: 2379  
ToPort: 2380  
IpProtocol: tcp

#### MasterIngressVxlan:

Type: AWS::EC2::SecurityGroupIngress  
Properties:  
GroupId: !GetAtt MasterSecurityGroup.GroupId  
SourceSecurityGroupId: !GetAtt MasterSecurityGroup.GroupId  
Description: Vxlan packets  
FromPort: 4789  
ToPort: 4789  
IpProtocol: udp

#### MasterIngressWorkerVxlan:

Type: AWS::EC2::SecurityGroupIngress  
Properties:  
GroupId: !GetAtt MasterSecurityGroup.GroupId  
SourceSecurityGroupId: !GetAtt WorkerSecurityGroup.GroupId  
Description: Vxlan packets  
FromPort: 4789  
ToPort: 4789  
IpProtocol: udp

#### MasterIngressGeneve:

Type: AWS::EC2::SecurityGroupIngress  
Properties:  
GroupId: !GetAtt MasterSecurityGroup.GroupId  
SourceSecurityGroupId: !GetAtt MasterSecurityGroup.GroupId  
Description: Geneve packets  
FromPort: 6081  
ToPort: 6081  
IpProtocol: udp

#### MasterIngressWorkerGeneve:

Type: AWS::EC2::SecurityGroupIngress  
Properties:  
GroupId: !GetAtt MasterSecurityGroup.GroupId  
SourceSecurityGroupId: !GetAtt WorkerSecurityGroup.GroupId  
Description: Geneve packets  
FromPort: 6081  
ToPort: 6081  
IpProtocol: udp

**MasterIngressIpsecIke:**

Type: AWS::EC2::SecurityGroupIngress

## Properties:

GroupId: !GetAtt MasterSecurityGroup.GroupId

SourceSecurityGroupId: !GetAtt MasterSecurityGroup.GroupId

Description: IPsec IKE packets

FromPort: 500

ToPort: 500

IpProtocol: udp

**MasterIngressIpsecNat:**

Type: AWS::EC2::SecurityGroupIngress

## Properties:

GroupId: !GetAtt MasterSecurityGroup.GroupId

SourceSecurityGroupId: !GetAtt MasterSecurityGroup.GroupId

Description: IPsec NAT-T packets

FromPort: 4500

ToPort: 4500

IpProtocol: udp

**MasterIngressIpsecEsp:**

Type: AWS::EC2::SecurityGroupIngress

## Properties:

GroupId: !GetAtt MasterSecurityGroup.GroupId

SourceSecurityGroupId: !GetAtt MasterSecurityGroup.GroupId

Description: IPsec ESP packets

IpProtocol: 50

**MasterIngressWorkerIpsecIke:**

Type: AWS::EC2::SecurityGroupIngress

## Properties:

GroupId: !GetAtt MasterSecurityGroup.GroupId

SourceSecurityGroupId: !GetAtt WorkerSecurityGroup.GroupId

Description: IPsec IKE packets

FromPort: 500

ToPort: 500

IpProtocol: udp

**MasterIngressWorkerIpsecNat:**

Type: AWS::EC2::SecurityGroupIngress

## Properties:

GroupId: !GetAtt MasterSecurityGroup.GroupId

SourceSecurityGroupId: !GetAtt WorkerSecurityGroup.GroupId

Description: IPsec NAT-T packets

FromPort: 4500

ToPort: 4500

IpProtocol: udp

**MasterIngressWorkerIpsecEsp:**

Type: AWS::EC2::SecurityGroupIngress

## Properties:

GroupId: !GetAtt MasterSecurityGroup.GroupId

SourceSecurityGroupId: !GetAtt WorkerSecurityGroup.GroupId

Description: IPsec ESP packets

IpProtocol: 50

**MasterIngressInternal:**

Type: AWS::EC2::SecurityGroupIngress

**Properties:**

GroupId: !GetAtt MasterSecurityGroup.GroupId

SourceSecurityGroupId: !GetAtt MasterSecurityGroup.GroupId

Description: Internal cluster communication

FromPort: 9000

ToPort: 9999

IpProtocol: tcp

**MasterIngressWorkerInternal:**

Type: AWS::EC2::SecurityGroupIngress

**Properties:**

GroupId: !GetAtt MasterSecurityGroup.GroupId

SourceSecurityGroupId: !GetAtt WorkerSecurityGroup.GroupId

Description: Internal cluster communication

FromPort: 9000

ToPort: 9999

IpProtocol: tcp

**MasterIngressInternalUDP:**

Type: AWS::EC2::SecurityGroupIngress

**Properties:**

GroupId: !GetAtt MasterSecurityGroup.GroupId

SourceSecurityGroupId: !GetAtt MasterSecurityGroup.GroupId

Description: Internal cluster communication

FromPort: 9000

ToPort: 9999

IpProtocol: udp

**MasterIngressWorkerInternalUDP:**

Type: AWS::EC2::SecurityGroupIngress

**Properties:**

GroupId: !GetAtt MasterSecurityGroup.GroupId

SourceSecurityGroupId: !GetAtt WorkerSecurityGroup.GroupId

Description: Internal cluster communication

FromPort: 9000

ToPort: 9999

IpProtocol: udp

**MasterIngressKube:**

Type: AWS::EC2::SecurityGroupIngress

**Properties:**

GroupId: !GetAtt MasterSecurityGroup.GroupId

SourceSecurityGroupId: !GetAtt MasterSecurityGroup.GroupId

Description: Kubernetes kubelet, scheduler and controller manager

FromPort: 10250

ToPort: 10259

IpProtocol: tcp

**MasterIngressWorkerKube:**

Type: AWS::EC2::SecurityGroupIngress

**Properties:**

GroupId: !GetAtt MasterSecurityGroup.GroupId

SourceSecurityGroupId: !GetAtt WorkerSecurityGroup.GroupId

Description: Kubernetes kubelet, scheduler and controller manager

FromPort: 10250

ToPort: 10259

IpProtocol: tcp

MasterIngressIngressServices:

Type: AWS::EC2::SecurityGroupIngress

Properties:

GroupId: !GetAtt MasterSecurityGroup.GroupId

SourceSecurityGroupId: !GetAtt MasterSecurityGroup.GroupId

Description: Kubernetes ingress services

FromPort: 30000

ToPort: 32767

IpProtocol: tcp

MasterIngressWorkerIngressServices:

Type: AWS::EC2::SecurityGroupIngress

Properties:

GroupId: !GetAtt MasterSecurityGroup.GroupId

SourceSecurityGroupId: !GetAtt WorkerSecurityGroup.GroupId

Description: Kubernetes ingress services

FromPort: 30000

ToPort: 32767

IpProtocol: tcp

MasterIngressIngressServicesUDP:

Type: AWS::EC2::SecurityGroupIngress

Properties:

GroupId: !GetAtt MasterSecurityGroup.GroupId

SourceSecurityGroupId: !GetAtt MasterSecurityGroup.GroupId

Description: Kubernetes ingress services

FromPort: 30000

ToPort: 32767

IpProtocol: udp

MasterIngressWorkerIngressServicesUDP:

Type: AWS::EC2::SecurityGroupIngress

Properties:

GroupId: !GetAtt MasterSecurityGroup.GroupId

SourceSecurityGroupId: !GetAtt WorkerSecurityGroup.GroupId

Description: Kubernetes ingress services

FromPort: 30000

ToPort: 32767

IpProtocol: udp

WorkerIngressVxlan:

Type: AWS::EC2::SecurityGroupIngress

Properties:

GroupId: !GetAtt WorkerSecurityGroup.GroupId

SourceSecurityGroupId: !GetAtt WorkerSecurityGroup.GroupId

Description: Vxlan packets

FromPort: 4789

ToPort: 4789

IpProtocol: udp

WorkerIngressMasterVxlan:



Type: AWS::EC2::SecurityGroupIngress

Properties:

GroupId: !GetAtt WorkerSecurityGroup.GroupId

SourceSecurityGroupId: !GetAtt MasterSecurityGroup.GroupId

Description: Vxlan packets

FromPort: 4789

ToPort: 4789

IpProtocol: udp

WorkerIngressGeneve:

Type: AWS::EC2::SecurityGroupIngress

Properties:

GroupId: !GetAtt WorkerSecurityGroup.GroupId

SourceSecurityGroupId: !GetAtt WorkerSecurityGroup.GroupId

Description: Geneve packets

FromPort: 6081

ToPort: 6081

IpProtocol: udp

WorkerIngressMasterGeneve:

Type: AWS::EC2::SecurityGroupIngress

Properties:

GroupId: !GetAtt WorkerSecurityGroup.GroupId

SourceSecurityGroupId: !GetAtt MasterSecurityGroup.GroupId

Description: Geneve packets

FromPort: 6081

ToPort: 6081

IpProtocol: udp

WorkerIngressIpsecIke:

Type: AWS::EC2::SecurityGroupIngress

Properties:

GroupId: !GetAtt WorkerSecurityGroup.GroupId

SourceSecurityGroupId: !GetAtt WorkerSecurityGroup.GroupId

Description: IPsec IKE packets

FromPort: 500

ToPort: 500

IpProtocol: udp

WorkerIngressIpsecNat:

Type: AWS::EC2::SecurityGroupIngress

Properties:

GroupId: !GetAtt WorkerSecurityGroup.GroupId

SourceSecurityGroupId: !GetAtt WorkerSecurityGroup.GroupId

Description: IPsec NAT-T packets

FromPort: 4500

ToPort: 4500

IpProtocol: udp

WorkerIngressIpsecEsp:

Type: AWS::EC2::SecurityGroupIngress

Properties:

GroupId: !GetAtt WorkerSecurityGroup.GroupId

SourceSecurityGroupId: !GetAtt WorkerSecurityGroup.GroupId

Description: IPsec ESP packets

IpProtocol: 50

**WorkerIngressMasterIpsecIke:**

Type: AWS::EC2::SecurityGroupIngress

## Properties:

GroupId: !GetAtt WorkerSecurityGroup.GroupId

SourceSecurityGroupId: !GetAtt MasterSecurityGroup.GroupId

Description: IPsec IKE packets

FromPort: 500

ToPort: 500

IpProtocol: udp

**WorkerIngressMasterIpsecNat:**

Type: AWS::EC2::SecurityGroupIngress

## Properties:

GroupId: !GetAtt WorkerSecurityGroup.GroupId

SourceSecurityGroupId: !GetAtt MasterSecurityGroup.GroupId

Description: IPsec NAT-T packets

FromPort: 4500

ToPort: 4500

IpProtocol: udp

**WorkerIngressMasterIpsecEsp:**

Type: AWS::EC2::SecurityGroupIngress

## Properties:

GroupId: !GetAtt WorkerSecurityGroup.GroupId

SourceSecurityGroupId: !GetAtt MasterSecurityGroup.GroupId

Description: IPsec ESP packets

IpProtocol: 50

**WorkerIngressInternal:**

Type: AWS::EC2::SecurityGroupIngress

## Properties:

GroupId: !GetAtt WorkerSecurityGroup.GroupId

SourceSecurityGroupId: !GetAtt WorkerSecurityGroup.GroupId

Description: Internal cluster communication

FromPort: 9000

ToPort: 9999

IpProtocol: tcp

**WorkerIngressMasterInternal:**

Type: AWS::EC2::SecurityGroupIngress

## Properties:

GroupId: !GetAtt WorkerSecurityGroup.GroupId

SourceSecurityGroupId: !GetAtt MasterSecurityGroup.GroupId

Description: Internal cluster communication

FromPort: 9000

ToPort: 9999

IpProtocol: tcp

**WorkerIngressInternalUDP:**

Type: AWS::EC2::SecurityGroupIngress

## Properties:

GroupId: !GetAtt WorkerSecurityGroup.GroupId

SourceSecurityGroupId: !GetAtt WorkerSecurityGroup.GroupId

Description: Internal cluster communication

FromPort: 9000

ToPort: 9999  
IpProtocol: udp

WorkerIngressMasterInternalUDP:

Type: AWS::EC2::SecurityGroupIngress  
Properties:  
GroupId: !GetAtt WorkerSecurityGroup.GroupId  
SourceSecurityGroupId: !GetAtt MasterSecurityGroup.GroupId  
Description: Internal cluster communication  
FromPort: 9000  
ToPort: 9999  
IpProtocol: udp

WorkerIngressKube:

Type: AWS::EC2::SecurityGroupIngress  
Properties:  
GroupId: !GetAtt WorkerSecurityGroup.GroupId  
SourceSecurityGroupId: !GetAtt WorkerSecurityGroup.GroupId  
Description: Kubernetes secure kubelet port  
FromPort: 10250  
ToPort: 10250  
IpProtocol: tcp

WorkerIngressWorkerKube:

Type: AWS::EC2::SecurityGroupIngress  
Properties:  
GroupId: !GetAtt WorkerSecurityGroup.GroupId  
SourceSecurityGroupId: !GetAtt MasterSecurityGroup.GroupId  
Description: Internal Kubernetes communication  
FromPort: 10250  
ToPort: 10250  
IpProtocol: tcp

WorkerIngressIngressServices:

Type: AWS::EC2::SecurityGroupIngress  
Properties:  
GroupId: !GetAtt WorkerSecurityGroup.GroupId  
SourceSecurityGroupId: !GetAtt WorkerSecurityGroup.GroupId  
Description: Kubernetes ingress services  
FromPort: 30000  
ToPort: 32767  
IpProtocol: tcp

WorkerIngressMasterIngressServices:

Type: AWS::EC2::SecurityGroupIngress  
Properties:  
GroupId: !GetAtt WorkerSecurityGroup.GroupId  
SourceSecurityGroupId: !GetAtt MasterSecurityGroup.GroupId  
Description: Kubernetes ingress services  
FromPort: 30000  
ToPort: 32767  
IpProtocol: tcp

WorkerIngressIngressServicesUDP:

Type: AWS::EC2::SecurityGroupIngress  
Properties:

GroupId: !GetAtt WorkerSecurityGroup.GroupId  
 SourceSecurityGroupId: !GetAtt WorkerSecurityGroup.GroupId  
 Description: Kubernetes ingress services  
 FromPort: 30000  
 ToPort: 32767  
 IpProtocol: udp

WorkerIngressMasterIngressServicesUDP:

Type: AWS::EC2::SecurityGroupIngress  
 Properties:  
 GroupId: !GetAtt WorkerSecurityGroup.GroupId  
 SourceSecurityGroupId: !GetAtt MasterSecurityGroup.GroupId  
 Description: Kubernetes ingress services  
 FromPort: 30000  
 ToPort: 32767  
 IpProtocol: udp

MasterIamRole:

Type: AWS::IAM::Role  
 Properties:

AssumeRolePolicyDocument:

Version: "2012-10-17"

Statement:

- Effect: "Allow"

Principal:

Service:

- "ec2.amazonaws.com"

Action:

- "sts:AssumeRole"

Policies:

- PolicyName: !Join ["-", [!Ref InfrastructureName, "master", "policy"]]

PolicyDocument:

Version: "2012-10-17"

Statement:

- Effect: "Allow"

Action:

- "ec2:AttachVolume"

- "ec2:AuthorizeSecurityGroupIngress"

- "ec2:CreateSecurityGroup"

- "ec2:CreateTags"

- "ec2:CreateVolume"

- "ec2>DeleteSecurityGroup"

- "ec2>DeleteVolume"

- "ec2:Describe\*"

- "ec2:DetachVolume"

- "ec2:ModifyInstanceAttribute"

- "ec2:ModifyVolume"

- "ec2:RevokeSecurityGroupIngress"

- "elasticloadbalancing:AddTags"

- "elasticloadbalancing:AttachLoadBalancerToSubnets"

- "elasticloadbalancing:ApplySecurityGroupsToLoadBalancer"

- "elasticloadbalancing:CreateListener"

- "elasticloadbalancing:CreateLoadBalancer"

- "elasticloadbalancing:CreateLoadBalancerPolicy"

- "elasticloadbalancing:CreateLoadBalancerListeners"

- "elasticloadbalancing:CreateTargetGroup"

- "elasticloadbalancing:ConfigureHealthCheck"
- "elasticloadbalancing>DeleteListener"
- "elasticloadbalancing>DeleteLoadBalancer"
- "elasticloadbalancing>DeleteLoadBalancerListeners"
- "elasticloadbalancing>DeleteTargetGroup"
- "elasticloadbalancing:DeregisterInstancesFromLoadBalancer"
- "elasticloadbalancing:DeregisterTargets"
- "elasticloadbalancing:Describe\*"
- "elasticloadbalancing:DetachLoadBalancerFromSubnets"
- "elasticloadbalancing:ModifyListener"
- "elasticloadbalancing:ModifyLoadBalancerAttributes"
- "elasticloadbalancing:ModifyTargetGroup"
- "elasticloadbalancing:ModifyTargetGroupAttributes"
- "elasticloadbalancing:RegisterInstancesWithLoadBalancer"
- "elasticloadbalancing:RegisterTargets"
- "elasticloadbalancing:SetLoadBalancerPoliciesForBackendServer"
- "elasticloadbalancing:SetLoadBalancerPoliciesOfListener"
- "kms:DescribeKey"

Resource: ""

#### MasterInstanceProfile:

Type: "AWS::IAM::InstanceProfile"  
 Properties:  
 Roles:  
 - Ref: "MasterIamRole"

#### WorkerIamRole:

Type: AWS::IAM::Role  
 Properties:  
 AssumeRolePolicyDocument:  
 Version: "2012-10-17"  
 Statement:  
 - Effect: "Allow"  
 Principal:  
 Service:  
 - "ec2.amazonaws.com"  
 Action:  
 - "sts:AssumeRole"  
 Policies:  
 - PolicyName: !Join ["-", [!Ref InfrastructureName, "worker", "policy"]]  
 PolicyDocument:  
 Version: "2012-10-17"  
 Statement:  
 - Effect: "Allow"  
 Action:  
 - "ec2:DescribeInstances"  
 - "ec2:DescribeRegions"  
 Resource: ""

#### WorkerInstanceProfile:

Type: "AWS::IAM::InstanceProfile"  
 Properties:  
 Roles:  
 - Ref: "WorkerIamRole"

Outputs:

```

MasterSecurityGroupId:
  Description: Master Security Group ID
  Value: !GetAtt MasterSecurityGroup.GroupId

WorkerSecurityGroupId:
  Description: Worker Security Group ID
  Value: !GetAtt WorkerSecurityGroup.GroupId

MasterInstanceProfile:
  Description: Master IAM Instance Profile
  Value: !Ref MasterInstanceProfile

WorkerInstanceProfile:
  Description: Worker IAM Instance Profile
  Value: !Ref WorkerInstanceProfile

```

### 5.14.12. Accessing RHCOS AMIs with stream metadata

In OpenShift Container Platform, *stream metadata* provides standardized metadata about RHCOS in the JSON format and injects the metadata into the cluster. Stream metadata is a stable format that supports multiple architectures and is intended to be self-documenting for maintaining automation.

You can use the **coreos print-stream-json** sub-command of **openshift-install** to access information about the boot images in the stream metadata format. This command provides a method for printing stream metadata in a scriptable, machine-readable format.

For user-provisioned installations, the **openshift-install** binary contains references to the version of RHCOS boot images that are tested for use with OpenShift Container Platform, such as the AWS AMI.

#### Procedure

To parse the stream metadata, use one of the following methods:

- From a Go program, use the official **stream-metadata-go** library at <https://github.com/coreos/stream-metadata-go>. You can also view example code in the library.
- From another programming language, such as Python or Ruby, use the JSON library of your preferred programming language.
- From a command-line utility that handles JSON data, such as **jq**:
  - Print the current **x86\_64** or **aarch64** AMI for an AWS region, such as **us-west-1**:

```
$ openshift-install coreos print-stream-json | jq -r
'.architectures.x86_64.images.aws.regions["us-west-1"].image'
```

#### Example output

```
ami-0d3e625f84626bbda
```

The output of this command is the AWS AMI ID for your designated architecture and the **us-west-1** region. The AMI must belong to the same region as the cluster.

### 5.14.13. RHCOS AMIs for the AWS infrastructure

Red Hat provides Red Hat Enterprise Linux CoreOS (RHCOS) AMIs that are valid for the various AWS regions and instance architectures that you can manually specify for your OpenShift Container Platform nodes.

**NOTE**

By importing your own AMI, you can also install to regions that do not have a published RHCOS AMI.

Table 5.52. x86\_64 RHCOS AMIs

AWS zone	AWS AMI
af-south-1	ami-0f3804f5a2f913dcc
ap-east-1	ami-0de1febb30a83da66
ap-northeast-1	ami-0183df96a3e002687
ap-northeast-2	ami-06b8798cd60242798
ap-northeast-3	ami-00b16b33aa0951016
ap-south-1	ami-007243f8ff78e8294
ap-southeast-1	ami-079dfdacb5ab5a0d1
ap-southeast-2	ami-03882e39cb7785c32
ca-central-1	ami-05cba1f80cc8b1dbe
eu-central-1	ami-073c775bbe9cd434e
eu-north-1	ami-0763e6e75b681acc5
eu-south-1	ami-00d023f19775fb64b
eu-west-1	ami-0033e3f2331a530c4
eu-west-2	ami-00d8a741ebe74f0c4
eu-west-3	ami-09b04e7f60e3374a7
me-south-1	ami-0f8039330b6e54010
sa-east-1	ami-01af22f821b470ad1
us-east-1	ami-0c72f473496a7b1c2

AWS zone	AWS AMI
<b>us-east-2</b>	<b>ami-09e637fc5885c13cc</b>
<b>us-gov-east-1</b>	<b>ami-0c3b11bcccf6ec63c</b>
<b>us-gov-west-1</b>	<b>ami-084d95ff443d8bf99</b>
<b>us-west-1</b>	<b>ami-0fa0f6fce7e63dd26</b>
<b>us-west-2</b>	<b>ami-084fb1316cd1ed4cc</b>

Table 5.53. aarch64 RHCOS AMIs

AWS zone	AWS AMI
<b>ap-east</b>	<b>ami-0f8195c36da4edbd7</b>
<b>ap-northeast-1</b>	<b>ami-000a86fa0a0b76144</b>
<b>ap-northeast-2</b>	<b>ami-0f772f5dc2347a954</b>
<b>ap-south-1</b>	<b>ami-02ab23e25b8e8af97</b>
<b>ap-southeast-1</b>	<b>ami-085ae5a7dcbfb056d</b>
<b>ap-southeast-2</b>	<b>ami-085ff9f4e8d4d66e0</b>
<b>ca-central-1</b>	<b>ami-0050cdf32f76ba82c</b>
<b>eu-central-1</b>	<b>ami-092527fcf7c21fe42</b>
<b>eu-north-1</b>	<b>ami-07d673450675ea033</b>
<b>eu-south-1</b>	<b>ami-0f165ac29cc9d27bf</b>
<b>eu-west-1</b>	<b>ami-0e0cd7d2eb949538d</b>
<b>eu-west-2</b>	<b>ami-0790ba70a444fe74d</b>
<b>eu-west-3</b>	<b>ami-0d16af5bd22cc5227</b>
<b>me-south-1</b>	<b>ami-05e1ba911ce321052</b>
<b>sa-east-1</b>	<b>ami-04b124534c7f05cd2</b>



AWS zone	AWS AMI
us-east-1	ami-09bbec91849ca85bc
us-east-2	ami-048ac599f7315a0bc
us-west-1	ami-0af1d3b7fa5be2131
us-west-2	ami-0bd3bf54ee678e2a6

#### 5.14.14. Creating the bootstrap node in AWS

You must create the bootstrap node in Amazon Web Services (AWS) to use during OpenShift Container Platform cluster initialization.

You can use the provided CloudFormation template and a custom parameter file to create a stack of AWS resources. The stack represents the bootstrap node that your OpenShift Container Platform installation requires.



#### NOTE

If you do not use the provided CloudFormation template to create your bootstrap node, you must review the provided information and manually create the infrastructure. If your cluster does not initialize correctly, you might have to contact Red Hat support with your installation logs.

#### Prerequisites

- You configured an AWS account.
- You added your AWS keys and region to your local AWS profile by running **aws configure**.
- You generated the Ignition config files for your cluster.
- You created and configured a VPC and associated subnets in AWS.
- You created and configured DNS, load balancers, and listeners in AWS.
- You created the security groups and roles required for your cluster in AWS.

#### Procedure

1. Provide a location to serve the **bootstrap.ign** Ignition config file to your cluster. This file is located in your installation directory. One way to do this is to create an S3 bucket in your cluster's region and upload the Ignition config file to it.

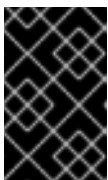

#### IMPORTANT

The provided CloudFormation Template assumes that the Ignition config files for your cluster are served from an S3 bucket. If you choose to serve the files from another location, you must modify the templates.



## IMPORTANT

If you are deploying to a region that has endpoints that differ from the AWS SDK, or you are providing your own custom endpoints, you must use a presigned URL for your S3 bucket instead of the **s3://** schema.



## NOTE

The bootstrap Ignition config file does contain secrets, like X.509 keys. The following steps provide basic security for the S3 bucket. To provide additional security, you can enable an S3 bucket policy to allow only certain users, such as the OpenShift IAM user, to access objects that the bucket contains. You can avoid S3 entirely and serve your bootstrap Ignition config file from any address that the bootstrap machine can reach.

- a. Create the bucket:

```
$ aws s3 mb s3://<cluster-name>-infra 1
```

- 1** **<cluster-name>-infra** is the bucket name. When creating the **install-config.yaml** file, replace **<cluster-name>** with the name specified for the cluster.

- b. Upload the **bootstrap.ign** Ignition config file to the bucket:

```
$ aws s3 cp <installation_directory>/bootstrap.ign s3://<cluster-name>-  
infra/bootstrap.ign 1
```

- 1** For **<installation\_directory>**, specify the path to the directory that you stored the installation files in.

- c. Verify that the file uploaded:

```
$ aws s3 ls s3://<cluster-name>-infra/
```

### Example output

```
2019-04-03 16:15:16 314878 bootstrap.ign
```

2. Create a JSON file that contains the parameter values that the template requires:

```
[  
  {  
    "ParameterKey": "InfrastructureName", 1  
    "ParameterValue": "mycluster-<random_string>" 2  
  },  
  {  
    "ParameterKey": "RhcOsAmi", 3  
    "ParameterValue": "ami-<random_string>" 4  
  },  
  {  
    "ParameterKey": "AllowedBootstrapSshCidr", 5
```

```

    "ParameterValue": "0.0.0.0/0" 6
  },
  {
    "ParameterKey": "PublicSubnet", 7
    "ParameterValue": "subnet-<random_string>" 8
  },
  {
    "ParameterKey": "MasterSecurityGroup", 9
    "ParameterValue": "sg-<random_string>" 10
  },
  {
    "ParameterKey": "VpcId", 11
    "ParameterValue": "vpc-<random_string>" 12
  },
  {
    "ParameterKey": "BootstrapIgnitionLocation", 13
    "ParameterValue": "s3://<bucket_name>/bootstrap.ign" 14
  },
  {
    "ParameterKey": "AutoRegisterELB", 15
    "ParameterValue": "yes" 16
  },
  {
    "ParameterKey": "RegisterNlbTargetsLambdaArn", 17
    "ParameterValue": "arn:aws:lambda:<region>:<account_number>:function:
<dns_stack_name>-RegisterNlbTargets-<random_string>" 18
  },
  {
    "ParameterKey": "ExternalApiTargetGroupArn", 19
    "ParameterValue": "arn:aws:elasticloadbalancing:<region>:
<account_number>:targetgroup/<dns_stack_name>-Exter-<random_string>" 20
  },
  {
    "ParameterKey": "InternalApiTargetGroupArn", 21
    "ParameterValue": "arn:aws:elasticloadbalancing:<region>:
<account_number>:targetgroup/<dns_stack_name>-Inter-<random_string>" 22
  },
  {
    "ParameterKey": "InternalServiceTargetGroupArn", 23
    "ParameterValue": "arn:aws:elasticloadbalancing:<region>:
<account_number>:targetgroup/<dns_stack_name>-Inter-<random_string>" 24
  }
]

```

- 1 The name for your cluster infrastructure that is encoded in your Ignition config files for the cluster.
- 2 Specify the infrastructure name that you extracted from the Ignition config file metadata, which has the format **<cluster-name>-<random-string>**.
- 3 Current Red Hat Enterprise Linux CoreOS (RHCOS) AMI to use for the bootstrap node.
- 4 Specify a valid **AWS::EC2::Image::Id** value.

- 5 CIDR block to allow SSH access to the bootstrap node.
  - 6 Specify a CIDR block in the format **x.x.x.x/16-24**.
  - 7 The public subnet that is associated with your VPC to launch the bootstrap node into.
  - 8 Specify the **PublicSubnetIds** value from the output of the CloudFormation template for the VPC.
  - 9 The master security group ID (for registering temporary rules)
  - 10 Specify the **MasterSecurityGroupId** value from the output of the CloudFormation template for the security group and roles.
  - 11 The VPC created resources will belong to.
  - 12 Specify the **VpcId** value from the output of the CloudFormation template for the VPC.
  - 13 Location to fetch bootstrap Ignition config file from.
  - 14 Specify the S3 bucket and file name in the form **s3://<bucket\_name>/bootstrap.ign**.
  - 15 Whether or not to register a network load balancer (NLB).
  - 16 Specify **yes** or **no**. If you specify **yes**, you must provide a Lambda Amazon Resource Name (ARN) value.
  - 17 The ARN for NLB IP target registration lambda group.
  - 18 Specify the **RegisterNlbTargetsLambda** value from the output of the CloudFormation template for DNS and load balancing. Use **arn:aws-us-gov** if deploying the cluster to an AWS GovCloud region.
  - 19 The ARN for external API load balancer target group.
  - 20 Specify the **ExternalApiTargetGroupArn** value from the output of the CloudFormation template for DNS and load balancing. Use **arn:aws-us-gov** if deploying the cluster to an AWS GovCloud region.
  - 21 The ARN for internal API load balancer target group.
  - 22 Specify the **InternalApiTargetGroupArn** value from the output of the CloudFormation template for DNS and load balancing. Use **arn:aws-us-gov** if deploying the cluster to an AWS GovCloud region.
  - 23 The ARN for internal service load balancer target group.
  - 24 Specify the **InternalServiceTargetGroupArn** value from the output of the CloudFormation template for DNS and load balancing. Use **arn:aws-us-gov** if deploying the cluster to an AWS GovCloud region.
3. Copy the template from the **CloudFormation template for the bootstrap machines** section of this topic and save it as a YAML file on your computer. This template describes the bootstrap machine that your cluster requires.
  4. Launch the CloudFormation template to create a stack of AWS resources that represent the bootstrap node:

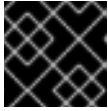

## IMPORTANT

You must enter the command on a single line.

```
$ aws cloudformation create-stack --stack-name <name> 1
  --template-body file://<template>.yaml 2
  --parameters file://<parameters>.json 3
  --capabilities CAPABILITY_NAMED_IAM 4
```

- 1** **<name>** is the name for the CloudFormation stack, such as **cluster-bootstrap**. You need the name of this stack if you remove the cluster.
- 2** **<template>** is the relative path to and name of the CloudFormation template YAML file that you saved.
- 3** **<parameters>** is the relative path to and name of the CloudFormation parameters JSON file.
- 4** You must explicitly declare the **CAPABILITY\_NAMED\_IAM** capability because the provided template creates some **AWS::IAM::Role** and **AWS::IAM::InstanceProfile** resources.

### Example output

```
arn:aws:cloudformation:us-east-1:269333783861:stack/cluster-bootstrap/12944486-2add-11eb-9dee-12dace8e3a83
```

5. Confirm that the template components exist:

```
$ aws cloudformation describe-stacks --stack-name <name>
```

After the **StackStatus** displays **CREATE\_COMPLETE**, the output displays values for the following parameters. You must provide these parameter values to the other CloudFormation templates that you run to create your cluster:

<b>Bootstrap Instanceld</b>	The bootstrap Instance ID.
<b>Bootstrap PublicIp</b>	The bootstrap node public IP address.
<b>Bootstrap PrivateIp</b>	The bootstrap node private IP address.

#### 5.14.14.1. CloudFormation template for the bootstrap machine

You can use the following CloudFormation template to deploy the bootstrap machine that you need for your OpenShift Container Platform cluster.

#### Example 5.68. CloudFormation template for the bootstrap machine

■

AWSTemplateFormatVersion: [2010-09-09](#)

Description: Template for OpenShift Cluster Bootstrap (EC2 Instance, Security Groups and IAM)

Parameters:

InfrastructureName:

AllowedPattern: `^[a-zA-Z][a-zA-Z0-9\-\]{0,26}$`

MaxLength: [27](#)

MinLength: [1](#)

ConstraintDescription: Infrastructure name must be alphanumeric, start with a letter, and have a maximum of [27](#) characters.

Description: A short, unique cluster ID used to tag cloud resources and identify items owned or used by the cluster.

Type: String

RhcosAmi:

Description: Current Red Hat Enterprise Linux CoreOS AMI to use for bootstrap.

Type: `AWS::EC2::Image::Id`

AllowedBootstrapSshCidr:

AllowedPattern: `^(((0-9){1-9}|0)|10|127|169|192|240|254|255)\.((0-9){1-3}|0)|255\.(0-9){1-3}|25[0-5]|4[0-9]|2[0-4]|25[0-5])\.((0-9){1-3}|0)|255\.(0-9){1-3}|25[0-5]|4[0-9]|2[0-4]|25[0-5])\.(0-9){1-3}|0)|255\.(0-9){1-3}|25[0-5]|4[0-9]|2[0-4]|25[0-5])$`

ConstraintDescription: CIDR block parameter must be in the form x.x.x.x/0-32.

Default: [0.0.0.0/0](#)

Description: CIDR block to allow SSH access to the bootstrap node.

Type: String

PublicSubnet:

Description: The public subnet to launch the bootstrap node into.

Type: `AWS::EC2::Subnet::Id`

MasterSecurityGroupId:

Description: The master security group ID for registering temporary rules.

Type: `AWS::EC2::SecurityGroup::Id`

VpcId:

Description: The VPC-scoped resources will belong to this VPC.

Type: `AWS::EC2::VPC::Id`

BootstrapIgnitionLocation:

Default: `s3://my-s3-bucket/bootstrap.ign`

Description: Ignition config file location.

Type: String

AutoRegisterELB:

Default: `"yes"`

AllowedValues:

- `"yes"`

- `"no"`

Description: Do you want to invoke NLB registration, which requires a Lambda ARN parameter?

Type: String

RegisterNlbTargetsLambdaArn:

Description: ARN for NLB IP target registration lambda.

Type: String

ExternalApiTargetGroupArn:

Description: ARN for external API load balancer target group.

Type: String

InternalApiTargetGroupArn:

Description: ARN for internal API load balancer target group.

Type: String

InternalServiceTargetGroupArn:

Description: ARN for internal service load balancer target group.

Type: String

BootstrapInstanceType:

Description: Instance type for the bootstrap EC2 instance

Default: "i3.large"

Type: String

Metadata:

AWS::CloudFormation::Interface:

ParameterGroups:

- Label:

default: "Cluster Information"

Parameters:

- InfrastructureName

- Label:

default: "Host Information"

Parameters:

- RhcosAmi

- BootstrapIgnitionLocation

- MasterSecurityGroupId

- Label:

default: "Network Configuration"

Parameters:

- VpcId

- AllowedBootstrapSshCidr

- PublicSubnet

- Label:

default: "Load Balancer Automation"

Parameters:

- AutoRegisterELB

- RegisterNLbpTargetsLambdaArn

- ExternalApiTargetGroupArn

- InternalApiTargetGroupArn

- InternalServiceTargetGroupArn

ParameterLabels:

InfrastructureName:

default: "Infrastructure Name"

VpcId:

default: "VPC ID"

AllowedBootstrapSshCidr:

default: "Allowed SSH Source"

PublicSubnet:

default: "Public Subnet"

RhcosAmi:

default: "Red Hat Enterprise Linux CoreOS AMI ID"

BootstrapIgnitionLocation:

default: "Bootstrap Ignition Source"

MasterSecurityGroupId:

default: "Master Security Group ID"

AutoRegisterELB:

default: "Use Provided ELB Automation"

Conditions:

DoRegistration: !Equals ["yes", !Ref AutoRegisterELB]

Resources:

BootstrapIamRole:

Type: AWS::IAM::Role

Properties:

## AssumeRolePolicyDocument:

Version: "2012-10-17"

Statement:

- Effect: "Allow"

Principal:

Service:

- "ec2.amazonaws.com"

Action:

- "sts:AssumeRole"

Path: "/"

Policies:

- PolicyName: !Join ["-", [!Ref InfrastructureName, "bootstrap", "policy"]]

PolicyDocument:

Version: "2012-10-17"

Statement:

- Effect: "Allow"

Action: "ec2:Describe\*\*"

Resource: "\*"

- Effect: "Allow"

Action: "ec2:AttachVolume"

Resource: "\*"

- Effect: "Allow"

Action: "ec2:DetachVolume"

Resource: "\*"

- Effect: "Allow"

Action: "s3:GetObject"

Resource: "\*"

## BootstrapInstanceProfile:

Type: "AWS::IAM::InstanceProfile"

Properties:

Path: "/"

Roles:

- Ref: "BootstrapIamRole"

## BootstrapSecurityGroup:

Type: AWS::EC2::SecurityGroup

Properties:

GroupDescription: Cluster Bootstrap Security Group

SecurityGroupIngress:

- IpProtocol: tcp

FromPort: 22

ToPort: 22

CidrIp: !Ref AllowedBootstrapSshCidr

- IpProtocol: tcp

ToPort: 19531

FromPort: 19531

CidrIp: 0.0.0.0/0

VpcId: !Ref VpcId

## BootstrapInstance:

Type: AWS::EC2::Instance

Properties:

ImageId: !Ref RhcosAmi

IamInstanceProfile: !Ref BootstrapInstanceProfile

InstanceType: !Ref BootstrapInstanceType



```

NetworkInterfaces:
- AssociatePublicIpAddress: "true"
  DeviceIndex: "0"
  GroupSet:
  - !Ref "BootstrapSecurityGroup"
  - !Ref "MasterSecurityGroupId"
  SubnetId: !Ref "PublicSubnet"
UserData:
  Fn::Base64: !Sub
  - '{"ignition":{"config":{"replace":{"source":"${S3Loc}"}},"version":"3.1.0"}}'
  - {
    S3Loc: !Ref BootstrapIgnitionLocation
  }

```

```

RegisterBootstrapApiTarget:
  Condition: DoRegistration
  Type: Custom::NLBRegister
  Properties:
    ServiceToken: !Ref RegisterNlbTargetsLambdaArn
    TargetArn: !Ref ExternalApiTargetGroupArn
    TargetIp: !GetAtt BootstrapInstance.PrivateIp

```

```

RegisterBootstrapInternalApiTarget:
  Condition: DoRegistration
  Type: Custom::NLBRegister
  Properties:
    ServiceToken: !Ref RegisterNlbTargetsLambdaArn
    TargetArn: !Ref InternalApiTargetGroupArn
    TargetIp: !GetAtt BootstrapInstance.PrivateIp

```

```

RegisterBootstrapInternalServiceTarget:
  Condition: DoRegistration
  Type: Custom::NLBRegister
  Properties:
    ServiceToken: !Ref RegisterNlbTargetsLambdaArn
    TargetArn: !Ref InternalServiceTargetGroupArn
    TargetIp: !GetAtt BootstrapInstance.PrivateIp

```

```

Outputs:
BootstrapInstanceId:
  Description: Bootstrap Instance ID.
  Value: !Ref BootstrapInstance

```

```

BootstrapPublicIp:
  Description: The bootstrap node public IP address.
  Value: !GetAtt BootstrapInstance.PublicIp

```

```

BootstrapPrivateIp:
  Description: The bootstrap node private IP address.
  Value: !GetAtt BootstrapInstance.PrivateIp

```

## Additional resources

- See [RHCOS AMIs for the AWS infrastructure](#) for details about the Red Hat Enterprise Linux CoreOS (RHCOS) AMIs for the AWS zones.

### 5.14.15. Creating the control plane machines in AWS

You must create the control plane machines in Amazon Web Services (AWS) that your cluster will use.

You can use the provided CloudFormation template and a custom parameter file to create a stack of AWS resources that represent the control plane nodes.



#### IMPORTANT

The CloudFormation template creates a stack that represents three control plane nodes.



#### NOTE

If you do not use the provided CloudFormation template to create your control plane nodes, you must review the provided information and manually create the infrastructure. If your cluster does not initialize correctly, you might have to contact Red Hat support with your installation logs.

#### Prerequisites

- You configured an AWS account.
- You added your AWS keys and region to your local AWS profile by running **aws configure**.
- You generated the Ignition config files for your cluster.
- You created and configured a VPC and associated subnets in AWS.
- You created and configured DNS, load balancers, and listeners in AWS.
- You created the security groups and roles required for your cluster in AWS.
- You created the bootstrap machine.

#### Procedure

1. Create a JSON file that contains the parameter values that the template requires:

```
[
  {
    "ParameterKey": "InfrastructureName", 1
    "ParameterValue": "mycluster-<random_string>" 2
  },
  {
    "ParameterKey": "RhcocAmi", 3
    "ParameterValue": "ami-<random_string>" 4
  },
  {
    "ParameterKey": "AutoRegisterDNS", 5
    "ParameterValue": "yes" 6
  },
]
```

```

{
  "ParameterKey": "PrivateHostedZoneId", 7
  "ParameterValue": "<random_string>" 8
},
{
  "ParameterKey": "PrivateHostedZoneName", 9
  "ParameterValue": "mycluster.example.com" 10
},
{
  "ParameterKey": "Master0Subnet", 11
  "ParameterValue": "subnet-<random_string>" 12
},
{
  "ParameterKey": "Master1Subnet", 13
  "ParameterValue": "subnet-<random_string>" 14
},
{
  "ParameterKey": "Master2Subnet", 15
  "ParameterValue": "subnet-<random_string>" 16
},
{
  "ParameterKey": "MasterSecurityGroupID", 17
  "ParameterValue": "sg-<random_string>" 18
},
{
  "ParameterKey": "IgnitionLocation", 19
  "ParameterValue": "https://api-int.<cluster_name>.<domain_name>:22623/config/master"
20
},
{
  "ParameterKey": "CertificateAuthorities", 21
  "ParameterValue": "data:text/plain;charset=utf-8;base64,ABC...xYz==" 22
},
{
  "ParameterKey": "MasterInstanceProfileName", 23
  "ParameterValue": "<roles_stack>-MasterInstanceProfile-<random_string>" 24
},
{
  "ParameterKey": "MasterInstanceType", 25
  "ParameterValue": "m6i.xlarge" 26
},
{
  "ParameterKey": "AutoRegisterELB", 27
  "ParameterValue": "yes" 28
},
{
  "ParameterKey": "RegisterNLBTargetsLambdaArn", 29
  "ParameterValue": "arn:aws:lambda:<region>:<account_number>:function:
<dns_stack_name>-RegisterNLBTargets-<random_string>" 30
},
{
  "ParameterKey": "ExternalApiTargetGroupArn", 31
  "ParameterValue": "arn:aws:elasticloadbalancing:<region>:

```

```

<account_number>:targetgroup/<dns_stack_name>-Exter-<random_string>" 32
  },
  {
    "ParameterKey": "InternalApiTargetGroupArn", 33
    "ParameterValue": "arn:aws:elasticloadbalancing:<region>:
<account_number>:targetgroup/<dns_stack_name>-Inter-<random_string>" 34
  },
  {
    "ParameterKey": "InternalServiceTargetGroupArn", 35
    "ParameterValue": "arn:aws:elasticloadbalancing:<region>:
<account_number>:targetgroup/<dns_stack_name>-Inter-<random_string>" 36
  }
]

```

- 1 The name for your cluster infrastructure that is encoded in your Ignition config files for the cluster.
- 2 Specify the infrastructure name that you extracted from the Ignition config file metadata, which has the format **<cluster-name>-<random-string>**.
- 3 Current Red Hat Enterprise Linux CoreOS (RHCOS) AMI to use for the control plane machines.
- 4 Specify an **AWS::EC2::Image::Id** value.
- 5 Whether or not to perform DNS etcd registration.
- 6 Specify **yes** or **no**. If you specify **yes**, you must provide hosted zone information.
- 7 The Route 53 private zone ID to register the etcd targets with.
- 8 Specify the **PrivateHostedZoneId** value from the output of the CloudFormation template for DNS and load balancing.
- 9 The Route 53 zone to register the targets with.
- 10 Specify **<cluster\_name>.<domain\_name>** where **<domain\_name>** is the Route 53 base domain that you used when you generated **install-config.yaml** file for the cluster. Do not include the trailing period (.) that is displayed in the AWS console.
- 11 13 15 A subnet, preferably private, to launch the control plane machines on.
- 12 14 16 Specify a subnet from the **PrivateSubnets** value from the output of the CloudFormation template for DNS and load balancing.
- 17 The master security group ID to associate with control plane nodes.
- 18 Specify the **MasterSecurityGroupId** value from the output of the CloudFormation template for the security group and roles.
- 19 The location to fetch control plane Ignition config file from.
- 20 Specify the generated Ignition config file location, [https://api-int.<cluster\\_name>.<domain\\_name>:22623/config/master](https://api-int.<cluster_name>.<domain_name>:22623/config/master).
- 21 The base64 encoded certificate authority string to use.

- 22 Specify the value from the **master.ign** file that is in the installation directory. This value is the long string with the format **data:text/plain;charset=utf-8;base64,ABC...xYz==**.
  - 23 The IAM profile to associate with control plane nodes.
  - 24 Specify the **MasterInstanceProfile** parameter value from the output of the CloudFormation template for the security group and roles.
  - 25 The type of AWS instance to use for the control plane machines.
  - 26 The instance type value corresponds to the minimum resource requirements for control plane machines.
  - 27 Whether or not to register a network load balancer (NLB).
  - 28 Specify **yes** or **no**. If you specify **yes**, you must provide a Lambda Amazon Resource Name (ARN) value.
  - 29 The ARN for NLB IP target registration lambda group.
  - 30 Specify the **RegisterNlbTargetsLambda** value from the output of the CloudFormation template for DNS and load balancing. Use **arn:aws-us-gov** if deploying the cluster to an AWS GovCloud region.
  - 31 The ARN for external API load balancer target group.
  - 32 Specify the **ExternalApiTargetGroupArn** value from the output of the CloudFormation template for DNS and load balancing. Use **arn:aws-us-gov** if deploying the cluster to an AWS GovCloud region.
  - 33 The ARN for internal API load balancer target group.
  - 34 Specify the **InternalApiTargetGroupArn** value from the output of the CloudFormation template for DNS and load balancing. Use **arn:aws-us-gov** if deploying the cluster to an AWS GovCloud region.
  - 35 The ARN for internal service load balancer target group.
  - 36 Specify the **InternalServiceTargetGroupArn** value from the output of the CloudFormation template for DNS and load balancing. Use **arn:aws-us-gov** if deploying the cluster to an AWS GovCloud region.
2. Copy the template from the **CloudFormation template for control plane machines** section of this topic and save it as a YAML file on your computer. This template describes the control plane machines that your cluster requires.
  3. If you specified an **m5** instance type as the value for **MasterInstanceType**, add that instance type to the **MasterInstanceType.AllowedValues** parameter in the CloudFormation template.
  4. Launch the CloudFormation template to create a stack of AWS resources that represent the control plane nodes:

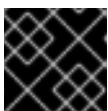

### IMPORTANT

You must enter the command on a single line.

-

```
$ aws cloudformation create-stack --stack-name <name> 1
  --template-body file://<template>.yaml 2
  --parameters file://<parameters>.json 3
```

- 1** **<name>** is the name for the CloudFormation stack, such as **cluster-control-plane**. You need the name of this stack if you remove the cluster.
- 2** **<template>** is the relative path to and name of the CloudFormation template YAML file that you saved.
- 3** **<parameters>** is the relative path to and name of the CloudFormation parameters JSON file.

### Example output

```
arn:aws:cloudformation:us-east-1:269333783861:stack/cluster-control-plane/21c7e2b0-2ee2-11eb-c6f6-0aa34627df4b
```

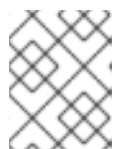

#### NOTE

The CloudFormation template creates a stack that represents three control plane nodes.

5. Confirm that the template components exist:

```
$ aws cloudformation describe-stacks --stack-name <name>
```

### 5.14.15.1. CloudFormation template for control plane machines

You can use the following CloudFormation template to deploy the control plane machines that you need for your OpenShift Container Platform cluster.

#### Example 5.69. CloudFormation template for control plane machines

```
AWSTemplateFormatVersion: 2010-09-09
Description: Template for OpenShift Cluster Node Launch (EC2 master instances)

Parameters:
  InfrastructureName:
    AllowedPattern: ^([a-zA-Z][a-zA-Z0-9\-\_]{0,26})$
    MaxLength: 27
    MinLength: 1
    ConstraintDescription: Infrastructure name must be alphanumeric, start with a letter, and have a maximum of 27 characters.
    Description: A short, unique cluster ID used to tag nodes for the kubelet cloud provider.
    Type: String
  RhcosAmi:
    Description: Current Red Hat Enterprise Linux CoreOS AMI to use for bootstrap.
    Type: AWS::EC2::Image::Id
  AutoRegisterDNS:
    Default: "yes"
    AllowedValues:
```

- "yes"

- "no"

Description: Do you want to invoke DNS etcd registration, which requires Hosted Zone information?

Type: String

PrivateHostedZoneId:

Description: The Route53 private zone ID to register the etcd targets with, such as Z21IXYZABCZ2A4.

Type: String

PrivateHostedZoneName:

Description: The Route53 zone to register the targets with, such as cluster.example.com. Omit the trailing period.

Type: String

Master0Subnet:

Description: The subnets, recommend private, to launch the master nodes into.

Type: AWS::EC2::Subnet::Id

Master1Subnet:

Description: The subnets, recommend private, to launch the master nodes into.

Type: AWS::EC2::Subnet::Id

Master2Subnet:

Description: The subnets, recommend private, to launch the master nodes into.

Type: AWS::EC2::Subnet::Id

MasterSecurityGroupId:

Description: The master security group ID to associate with master nodes.

Type: AWS::EC2::SecurityGroup::Id

IgnitionLocation:

Default: [https://api-int.\\$CLUSTER\\_NAME.\\$DOMAIN:22623/config/master](https://api-int.$CLUSTER_NAME.$DOMAIN:22623/config/master)

Description: Ignition config file location.

Type: String

CertificateAuthorities:

Default: data:text/plain;charset=utf-8;base64,ABC...xYz==

Description: Base64 encoded certificate authority string to use.

Type: String

MasterInstanceProfileName:

Description: IAM profile to associate with master nodes.

Type: String

MasterInstanceType:

Default: m5.xlarge

Type: String

AutoRegisterELB:

Default: "yes"

AllowedValues:

- "yes"

- "no"

Description: Do you want to invoke NLB registration, which requires a Lambda ARN parameter?

Type: String

RegisterNLBIPTargetsLambdaArn:

Description: ARN for NLB IP target registration lambda. Supply the value from the cluster infrastructure or select "no" for AutoRegisterELB.

Type: String

ExternalApiTargetGroupArn:

Description: ARN for external API load balancer target group. Supply the value from the cluster infrastructure or select "no" for AutoRegisterELB.

Type: String

InternalApiTargetGroupArn:

Description: ARN for internal API load balancer target group. Supply the value from the cluster infrastructure or select "no" for AutoRegisterELB.

Type: String

InternalServiceTargetGroupArn:

Description: ARN for internal service load balancer target group. Supply the value from the cluster infrastructure or select "no" for AutoRegisterELB.

Type: String

Metadata:

AWS::CloudFormation::Interface:

ParameterGroups:

- Label:

default: "Cluster Information"

Parameters:

- InfrastructureName

- Label:

default: "Host Information"

Parameters:

- MasterInstanceType

- RhcosAmi

- IgnitionLocation

- CertificateAuthorities

- MasterSecurityGroupId

- MasterInstanceProfileName

- Label:

default: "Network Configuration"

Parameters:

- VpcId

- AllowedBootstrapSshCidr

- Master0Subnet

- Master1Subnet

- Master2Subnet

- Label:

default: "DNS"

Parameters:

- AutoRegisterDNS

- PrivateHostedZoneName

- PrivateHostedZoneId

- Label:

default: "Load Balancer Automation"

Parameters:

- AutoRegisterELB

- RegisterNlbTargetsLambdaArn

- ExternalApiTargetGroupArn

- InternalApiTargetGroupArn

- InternalServiceTargetGroupArn

ParameterLabels:

InfrastructureName:

default: "Infrastructure Name"

VpcId:

default: "VPC ID"

Master0Subnet:

default: "Master-0 Subnet"

Master1Subnet:

default: "Master-1 Subnet"

Master2Subnet:



```

    default: "Master-2 Subnet"
MasterInstanceType:
    default: "Master Instance Type"
MasterInstanceProfileName:
    default: "Master Instance Profile Name"
RhcOsAmi:
    default: "Red Hat Enterprise Linux CoreOS AMI ID"
BootstrapIgnitionLocation:
    default: "Master Ignition Source"
CertificateAuthorities:
    default: "Ignition CA String"
MasterSecurityGroupId:
    default: "Master Security Group ID"
AutoRegisterDNS:
    default: "Use Provided DNS Automation"
AutoRegisterELB:
    default: "Use Provided ELB Automation"
PrivateHostedZoneName:
    default: "Private Hosted Zone Name"
PrivateHostedZoneId:
    default: "Private Hosted Zone ID"

```

Conditions:

```

DoRegistration: !Equals ["yes", !Ref AutoRegisterELB]
DoDns: !Equals ["yes", !Ref AutoRegisterDNS]

```

Resources:

Master0:

Type: AWS::EC2::Instance

Properties:

ImageId: !Ref RhcOsAmi

BlockDeviceMappings:

- DeviceName: /dev/xvda

Ebs:

VolumeSize: "120"

VolumeType: "gp2"

IamInstanceProfile: !Ref MasterInstanceProfileName

InstanceType: !Ref MasterInstanceType

NetworkInterfaces:

- AssociatePublicIp: "false"

DeviceIndex: "0"

GroupSet:

- !Ref "MasterSecurityGroupId"

SubnetId: !Ref "Master0Subnet"

UserData:

Fn::Base64: !Sub

```

- '{"ignition":{"config":{"merge":[{"source":"${SOURCE}"}]},"security":{"tls":
{"certificateAuthorities":[{"source":"${CA_BUNDLE}"}]},"version":"3.1.0"}}'

```

- {

SOURCE: !Ref IgnitionLocation,

CA\_BUNDLE: !Ref CertificateAuthorities,

}

Tags:

- Key: !Join ["", ["kubernetes.io/cluster/", !Ref InfrastructureName]]

Value: "shared"

```

RegisterMaster0:
  Condition: DoRegistration
  Type: Custom::NLBRegister
  Properties:
    ServiceToken: !Ref RegisterNlbTargetsLambdaArn
    TargetArn: !Ref ExternalApiTargetGroupArn
    TargetIp: !GetAtt Master0.PrivateIp

```

```

RegisterMaster0InternalApiTarget:
  Condition: DoRegistration
  Type: Custom::NLBRegister
  Properties:
    ServiceToken: !Ref RegisterNlbTargetsLambdaArn
    TargetArn: !Ref InternalApiTargetGroupArn
    TargetIp: !GetAtt Master0.PrivateIp

```

```

RegisterMaster0InternalServiceTarget:
  Condition: DoRegistration
  Type: Custom::NLBRegister
  Properties:
    ServiceToken: !Ref RegisterNlbTargetsLambdaArn
    TargetArn: !Ref InternalServiceTargetGroupArn
    TargetIp: !GetAtt Master0.PrivateIp

```

```

Master1:
  Type: AWS::EC2::Instance
  Properties:
    ImageId: !Ref RhcosAmi
    BlockDeviceMappings:
      - DeviceName: /dev/xvda
        Ebs:
          VolumeSize: "120"
          VolumeType: "gp2"
    IamInstanceProfile: !Ref MasterInstanceProfileName
    InstanceType: !Ref MasterInstanceType
    NetworkInterfaces:
      - AssociatePublicIpAddress: "false"
        DeviceIndex: "0"
        GroupSet:
          - !Ref "MasterSecurityGroupId"
        SubnetId: !Ref "Master1Subnet"
    UserData:
      Fn::Base64: !Sub
        - '{"ignition":{"config":{"merge":[{"source":"${SOURCE}"}]},"security":{"tls":
{"certificateAuthorities":[{"source":"${CA_BUNDLE}"}]},"version":"3.1.0"}}'
        - {
          SOURCE: !Ref IgnitionLocation,
          CA_BUNDLE: !Ref CertificateAuthorities,
        }
    Tags:
      - Key: !Join [ "", ["kubernetes.io/cluster/", !Ref InfrastructureName] ]
        Value: "shared"

```

```

RegisterMaster1:
  Condition: DoRegistration
  Type: Custom::NLBRegister

```

## Properties:

ServiceToken: !Ref RegisterNlbTargetsLambdaArn  
 TargetArn: !Ref ExternalApiTargetGroupArn  
 TargetIp: !GetAtt Master1.PrivateIp

## RegisterMaster1InternalApiTarget:

Condition: DoRegistration  
 Type: Custom::NLBRegister  
 Properties:  
 ServiceToken: !Ref RegisterNlbTargetsLambdaArn  
 TargetArn: !Ref InternalApiTargetGroupArn  
 TargetIp: !GetAtt Master1.PrivateIp

## RegisterMaster1InternalServiceTarget:

Condition: DoRegistration  
 Type: Custom::NLBRegister  
 Properties:  
 ServiceToken: !Ref RegisterNlbTargetsLambdaArn  
 TargetArn: !Ref InternalServiceTargetGroupArn  
 TargetIp: !GetAtt Master1.PrivateIp

## Master2:

Type: AWS::EC2::Instance  
 Properties:  
 ImageId: !Ref RhcosAmi  
 BlockDeviceMappings:  
 - DeviceName: /dev/xvda  
 Ebs:  
 VolumeSize: "120"  
 VolumeType: "gp2"  
 IamInstanceProfile: !Ref MasterInstanceProfileName  
 InstanceType: !Ref MasterInstanceType  
 NetworkInterfaces:  
 - AssociatePublicIpAddress: "false"  
 DeviceIndex: "0"  
 GroupSet:  
 - !Ref "MasterSecurityGroupId"  
 SubnetId: !Ref "Master2Subnet"  
 UserData:  
 Fn::Base64: !Sub  
 - '{"ignition":{"config":{"merge":{"source":"\${SOURCE}"},"security":{"tls":{"certificateAuthorities":[{"source":"\${CA\_BUNDLE}"}]},"version":"3.1.0"}}}'  
 - {  
 SOURCE: !Ref IgnitionLocation,  
 CA\_BUNDLE: !Ref CertificateAuthorities,  
 }  
 Tags:  
 - Key: !Join [ "", ["kubernetes.io/cluster/", !Ref InfrastructureName] ]  
 Value: "shared"

## RegisterMaster2:

Condition: DoRegistration  
 Type: Custom::NLBRegister  
 Properties:  
 ServiceToken: !Ref RegisterNlbTargetsLambdaArn  
 TargetArn: !Ref ExternalApiTargetGroupArn

TargetIp: !GetAtt Master2.PrivateIp

RegisterMaster2InternalApiTarget:

Condition: DoRegistration

Type: Custom::NLBRegister

Properties:

ServiceToken: !Ref RegisterNlbTargetsLambdaArn

TargetArn: !Ref InternalApiTargetGroupArn

TargetIp: !GetAtt Master2.PrivateIp

RegisterMaster2InternalServiceTarget:

Condition: DoRegistration

Type: Custom::NLBRegister

Properties:

ServiceToken: !Ref RegisterNlbTargetsLambdaArn

TargetArn: !Ref InternalServiceTargetGroupArn

TargetIp: !GetAtt Master2.PrivateIp

EtcdSrvRecords:

Condition: DoDns

Type: AWS::Route53::RecordSet

Properties:

HostedZoneId: !Ref PrivateHostedZoneId

Name: !Join [".", ["\_etcd-server-ssl.\_tcp", !Ref PrivateHostedZoneName]]

ResourceRecords:

```
- !Join [
  " ",
  ["0 10 2380", !Join [".", ["etcd-0", !Ref PrivateHostedZoneName]]],
]
- !Join [
  " ",
  ["0 10 2380", !Join [".", ["etcd-1", !Ref PrivateHostedZoneName]]],
]
- !Join [
  " ",
  ["0 10 2380", !Join [".", ["etcd-2", !Ref PrivateHostedZoneName]]],
]
```

TTL: 60

Type: SRV

Etcd0Record:

Condition: DoDns

Type: AWS::Route53::RecordSet

Properties:

HostedZoneId: !Ref PrivateHostedZoneId

Name: !Join [".", ["etcd-0", !Ref PrivateHostedZoneName]]

ResourceRecords:

```
- !GetAtt Master0.PrivateIp
```

TTL: 60

Type: A

Etcd1Record:

Condition: DoDns

Type: AWS::Route53::RecordSet

Properties:

HostedZoneId: !Ref PrivateHostedZoneId

```
Name: !Join [".", ["etcd-1", !Ref PrivateHostedZoneName]]
ResourceRecords:
- !GetAtt Master1.PrivateIp
TTL: 60
Type: A
```

```
Etcd2Record:
Condition: DoDns
Type: AWS::Route53::RecordSet
Properties:
HostedZoneId: !Ref PrivateHostedZoneId
Name: !Join [".", ["etcd-2", !Ref PrivateHostedZoneName]]
ResourceRecords:
- !GetAtt Master2.PrivateIp
TTL: 60
Type: A
```

```
Outputs:
PrivateIPs:
Description: The control-plane node private IP addresses.
Value:
!Join [
  ",",
  [!GetAtt Master0.PrivateIp, !GetAtt Master1.PrivateIp, !GetAtt Master2.PrivateIp]
]
```

### 5.14.16. Creating the worker nodes in AWS

You can create worker nodes in Amazon Web Services (AWS) for your cluster to use.

You can use the provided CloudFormation template and a custom parameter file to create a stack of AWS resources that represent a worker node.

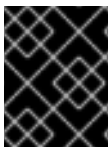

#### IMPORTANT

The CloudFormation template creates a stack that represents one worker node. You must create a stack for each worker node.

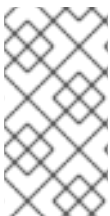

#### NOTE

If you do not use the provided CloudFormation template to create your worker nodes, you must review the provided information and manually create the infrastructure. If your cluster does not initialize correctly, you might have to contact Red Hat support with your installation logs.

#### Prerequisites

- You configured an AWS account.
- You added your AWS keys and region to your local AWS profile by running **aws configure**.
- You generated the Ignition config files for your cluster.
- You created and configured a VPC and associated subnets in AWS.

- You created and configured DNS, load balancers, and listeners in AWS.
- You created the security groups and roles required for your cluster in AWS.
- You created the bootstrap machine.
- You created the control plane machines.

## Procedure

1. Create a JSON file that contains the parameter values that the CloudFormation template requires:

```
[
  {
    "ParameterKey": "InfrastructureName", 1
    "ParameterValue": "mycluster-<random_string>" 2
  },
  {
    "ParameterKey": "RhcOsAmi", 3
    "ParameterValue": "ami-<random_string>" 4
  },
  {
    "ParameterKey": "Subnet", 5
    "ParameterValue": "subnet-<random_string>" 6
  },
  {
    "ParameterKey": "WorkerSecurityGroupId", 7
    "ParameterValue": "sg-<random_string>" 8
  },
  {
    "ParameterKey": "IgnitionLocation", 9
    "ParameterValue": "https://api-int.<cluster_name>.<domain_name>:22623/config/worker"
    10
  },
  {
    "ParameterKey": "CertificateAuthorities", 11
    "ParameterValue": "" 12
  },
  {
    "ParameterKey": "WorkerInstanceProfileName", 13
    "ParameterValue": "" 14
  },
  {
    "ParameterKey": "WorkerInstanceType", 15
    "ParameterValue": "m6i.large" 16
  }
]
```

- 1 The name for your cluster infrastructure that is encoded in your Ignition config files for the cluster.
- 2 Specify the infrastructure name that you extracted from the Ignition config file metadata, which has the format **<cluster-name>-<random-string>**.

- 3 Current Red Hat Enterprise Linux CoreOS (RHCOS) AMI to use for the worker nodes.
  - 4 Specify an **AWS::EC2::Image::Id** value.
  - 5 A subnet, preferably private, to start the worker nodes on.
  - 6 Specify a subnet from the **PrivateSubnets** value from the output of the CloudFormation template for DNS and load balancing.
  - 7 The worker security group ID to associate with worker nodes.
  - 8 Specify the **WorkerSecurityGroupID** value from the output of the CloudFormation template for the security group and roles.
  - 9 The location to fetch the bootstrap Ignition config file from.
  - 10 Specify the generated Ignition config location, [https://api-int.<cluster\\_name>.<domain\\_name>:22623/config/worker](https://api-int.<cluster_name>.<domain_name>:22623/config/worker).
  - 11 Base64 encoded certificate authority string to use.
  - 12 Specify the value from the **worker.ign** file that is in the installation directory. This value is the long string with the format **data:text/plain;charset=utf-8;base64,ABC...xYz==**.
  - 13 The IAM profile to associate with worker nodes.
  - 14 Specify the **WorkerInstanceProfile** parameter value from the output of the CloudFormation template for the security group and roles.
  - 15 The type of AWS instance to use for the compute machines.
  - 16 The instance type value corresponds to the minimum resource requirements for compute machines.
2. Copy the template from the **CloudFormation template for worker machines** section of this topic and save it as a YAML file on your computer. This template describes the networking objects and load balancers that your cluster requires.
  3. Optional: If you specified an **m5** instance type as the value for **WorkerInstanceType**, add that instance type to the **WorkerInstanceType.AllowedValues** parameter in the CloudFormation template.
  4. Optional: If you are deploying with an AWS Marketplace image, update the **Worker0.type.properties.ImageID** parameter with the AMI ID that you obtained from your subscription.
  5. Use the CloudFormation template to create a stack of AWS resources that represent a worker node:

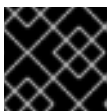

### IMPORTANT

You must enter the command on a single line.

```
$ aws cloudformation create-stack --stack-name <name> 1
  --template-body file://<template>.yaml \ 2
  --parameters file://<parameters>.json 3
```

- 1** **<name>** is the name for the CloudFormation stack, such as **cluster-worker-1**. You need the name of this stack if you remove the cluster.
- 2** **<template>** is the relative path to and name of the CloudFormation template YAML file that you saved.
- 3** **<parameters>** is the relative path to and name of the CloudFormation parameters JSON file.

### Example output

```
arn:aws:cloudformation:us-east-1:269333783861:stack/cluster-worker-1/729ee301-1c2a-11eb-348f-sd9888c65b59
```



#### NOTE

The CloudFormation template creates a stack that represents one worker node.

6. Confirm that the template components exist:

```
$ aws cloudformation describe-stacks --stack-name <name>
```

7. Continue to create worker stacks until you have created enough worker machines for your cluster. You can create additional worker stacks by referencing the same template and parameter files and specifying a different stack name.



#### IMPORTANT

You must create at least two worker machines, so you must create at least two stacks that use this CloudFormation template.

### 5.14.16.1. CloudFormation template for worker machines

You can use the following CloudFormation template to deploy the worker machines that you need for your OpenShift Container Platform cluster.

#### Example 5.70. CloudFormation template for worker machines

```
AWSTemplateFormatVersion: 2010-09-09
Description: Template for OpenShift Cluster Node Launch (EC2 worker instance)

Parameters:
  InfrastructureName:
    AllowedPattern: ^([a-zA-Z][a-zA-Z0-9-]{0,26})$
    MaxLength: 27
    MinLength: 1
    ConstraintDescription: Infrastructure name must be alphanumeric, start with a letter, and have a maximum of 27 characters.
```



Description: A short, unique cluster ID used to tag nodes for the kubelet cloud provider.

Type: String

RhcosAmi:

Description: Current Red Hat Enterprise Linux CoreOS AMI to use for bootstrap.

Type: AWS::EC2::Image::Id

Subnet:

Description: The subnets, recommend private, to launch the master nodes into.

Type: AWS::EC2::Subnet::Id

WorkerSecurityGroupId:

Description: The master security group ID to associate with master nodes.

Type: AWS::EC2::SecurityGroup::Id

IgnitionLocation:

Default: [https://api-int.\\$CLUSTER\\_NAME.\\$DOMAIN:22623/config/worker](https://api-int.$CLUSTER_NAME.$DOMAIN:22623/config/worker)

Description: Ignition config file location.

Type: String

CertificateAuthorities:

Default: `data:text/plain;charset=utf-8;base64,ABC...xYz==`

Description: Base64 encoded certificate authority string to use.

Type: String

WorkerInstanceProfileName:

Description: IAM profile to associate with master nodes.

Type: String

WorkerInstanceType:

Default: m5.large

Type: String

Metadata:

AWS::CloudFormation::Interface:

ParameterGroups:

- Label:

default: "Cluster Information"

Parameters:

- InfrastructureName

- Label:

default: "Host Information"

Parameters:

- WorkerInstanceType

- RhcosAmi

- IgnitionLocation

- CertificateAuthorities

- WorkerSecurityGroupId

- WorkerInstanceProfileName

- Label:

default: "Network Configuration"

Parameters:

- Subnet

ParameterLabels:

Subnet:

default: "Subnet"

InfrastructureName:

default: "Infrastructure Name"

WorkerInstanceType:

default: "Worker Instance Type"

WorkerInstanceProfileName:

default: "Worker Instance Profile Name"

RhcosAmi:

```

    default: "Red Hat Enterprise Linux CoreOS AMI ID"
  IgnitionLocation:
    default: "Worker Ignition Source"
  CertificateAuthorities:
    default: "Ignition CA String"
  WorkerSecurityGroupId:
    default: "Worker Security Group ID"

Resources:
  Worker0:
    Type: AWS::EC2::Instance
    Properties:
      ImageId: !Ref RhcosAmi
      BlockDeviceMappings:
        - DeviceName: /dev/xvda
          Ebs:
            VolumeSize: "120"
            VolumeType: "gp2"
      IamInstanceProfile: !Ref WorkerInstanceProfileName
      InstanceType: !Ref WorkerInstanceType
      NetworkInterfaces:
        - AssociatePublicIp: "false"
          DeviceIndex: "0"
          GroupSet:
            - !Ref "WorkerSecurityGroupId"
          SubnetId: !Ref "Subnet"
      UserData:
        Fn::Base64: !Sub
          - '{"ignition":{"config":{"merge":[{"source":"${SOURCE}"}]},"security":{"tls":
{"certificateAuthorities":[{"source":"${CA_BUNDLE}"}]},"version":"3.1.0"}}'
          - {
              SOURCE: !Ref IgnitionLocation,
              CA_BUNDLE: !Ref CertificateAuthorities,
            }
      Tags:
        - Key: !Join ["", ["kubernetes.io/cluster/", !Ref InfrastructureName]]
          Value: "shared"

Outputs:
  PrivateIP:
    Description: The compute node private IP address.
    Value: !GetAtt Worker0.PrivateIp

```

### 5.14.17. Initializing the bootstrap sequence on AWS with user-provisioned infrastructure

After you create all of the required infrastructure in Amazon Web Services (AWS), you can start the bootstrap sequence that initializes the OpenShift Container Platform control plane.

#### Prerequisites

- You configured an AWS account.
- You added your AWS keys and region to your local AWS profile by running **aws configure**.

- You generated the Ignition config files for your cluster.
- You created and configured a VPC and associated subnets in AWS.
- You created and configured DNS, load balancers, and listeners in AWS.
- You created the security groups and roles required for your cluster in AWS.
- You created the bootstrap machine.
- You created the control plane machines.
- You created the worker nodes.

## Procedure

1. Change to the directory that contains the installation program and start the bootstrap process that initializes the OpenShift Container Platform control plane:

```
$ ./openshift-install wait-for bootstrap-complete --dir <installation_directory> \ 1
--log-level=info 2
```

- 1** For **<installation\_directory>**, specify the path to the directory that you stored the installation files in.
- 2** To view different installation details, specify **warn**, **debug**, or **error** instead of **info**.

## Example output

```
INFO Waiting up to 20m0s for the Kubernetes API at
https://api.mycluster.example.com:6443...
INFO API v1.23.0 up
INFO Waiting up to 30m0s for bootstrapping to complete...
INFO It is now safe to remove the bootstrap resources
INFO Time elapsed: 1s
```

If the command exits without a **FATAL** warning, your OpenShift Container Platform control plane has initialized.



### NOTE

After the control plane initializes, it sets up the compute nodes and installs additional services in the form of Operators.

## Additional resources

- See [Monitoring installation progress](#) for details about monitoring the installation, bootstrap, and control plane logs as an OpenShift Container Platform installation progresses.
- See [Gathering bootstrap node diagnostic data](#) for information about troubleshooting issues related to the bootstrap process.

## 5.14.18. Logging in to the cluster by using the CLI

You can log in to your cluster as a default system user by exporting the cluster **kubeconfig** file. The **kubeconfig** file contains information about the cluster that is used by the CLI to connect a client to the correct cluster and API server. The file is specific to a cluster and is created during OpenShift Container Platform installation.

### Prerequisites

- You deployed an OpenShift Container Platform cluster.
- You installed the **oc** CLI.

### Procedure

1. Export the **kubeadmin** credentials:

```
$ export KUBECONFIG=<installation_directory>/auth/kubeconfig 1
```

- 1** For **<installation\_directory>**, specify the path to the directory that you stored the installation files in.

2. Verify you can run **oc** commands successfully using the exported configuration:

```
$ oc whoami
```

#### Example output

```
system:admin
```

## 5.14.19. Approving the certificate signing requests for your machines

When you add machines to a cluster, two pending certificate signing requests (CSRs) are generated for each machine that you added. You must confirm that these CSRs are approved or, if necessary, approve them yourself. The client requests must be approved first, followed by the server requests.

### Prerequisites

- You added machines to your cluster.

### Procedure

1. Confirm that the cluster recognizes the machines:

```
$ oc get nodes
```

#### Example output

```
NAME      STATUS    ROLES    AGE   VERSION
master-0  Ready    master   63m   v1.23.0
master-1  Ready    master   63m   v1.23.0
master-2  Ready    master   64m   v1.23.0
```

The output lists all of the machines that you created.

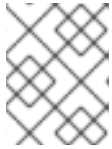

### NOTE

The preceding output might not include the compute nodes, also known as worker nodes, until some CSRs are approved.

- Review the pending CSRs and ensure that you see the client requests with the **Pending** or **Approved** status for each machine that you added to the cluster:

```
$ oc get csr
```

### Example output

```
NAME      AGE   REQUESTOR                                     CONDITION
csr-8b2br 15m   system:serviceaccount:openshift-machine-config-operator:node-
bootstrapper Pending
csr-8vnps 15m   system:serviceaccount:openshift-machine-config-operator:node-
bootstrapper Pending
...
```

In this example, two machines are joining the cluster. You might see more approved CSRs in the list.

- If the CSRs were not approved, after all of the pending CSRs for the machines you added are in **Pending** status, approve the CSRs for your cluster machines:



### NOTE

Because the CSRs rotate automatically, approve your CSRs within an hour of adding the machines to the cluster. If you do not approve them within an hour, the certificates will rotate, and more than two certificates will be present for each node. You must approve all of these certificates. After the client CSR is approved, the Kubelet creates a secondary CSR for the serving certificate, which requires manual approval. Then, subsequent serving certificate renewal requests are automatically approved by the **machine-approver** if the Kubelet requests a new certificate with identical parameters.

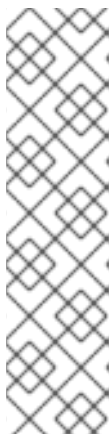

### NOTE

For clusters running on platforms that are not machine API enabled, such as bare metal and other user-provisioned infrastructure, you must implement a method of automatically approving the kubelet serving certificate requests (CSRs). If a request is not approved, then the **oc exec**, **oc rsh**, and **oc logs** commands cannot succeed, because a serving certificate is required when the API server connects to the kubelet. Any operation that contacts the Kubelet endpoint requires this certificate approval to be in place. The method must watch for new CSRs, confirm that the CSR was submitted by the **node-bootstrapper** service account in the **system:node** or **system:admin** groups, and confirm the identity of the node.

- To approve them individually, run the following command for each valid CSR:

```
$ oc adm certificate approve <csr_name> 1
```

**1** **<csr\_name>** is the name of a CSR from the list of current CSRs.

- To approve all pending CSRs, run the following command:

```
$ oc get csr -o go-template='{{range .items}}{{if not .status}}{{.metadata.name}}{\n"}\n{{end}}' | xargs --no-run-if-empty oc adm certificate approve
```



#### NOTE

Some Operators might not become available until some CSRs are approved.

- Now that your client requests are approved, you must review the server requests for each machine that you added to the cluster:

```
$ oc get csr
```

#### Example output

```
NAME      AGE   REQUESTOR                                     CONDITION
csr-bfd72 5m26s system:node:ip-10-0-50-126.us-east-2.compute.internal
Pending
csr-c57lv 5m26s system:node:ip-10-0-95-157.us-east-2.compute.internal
Pending
...
```

- If the remaining CSRs are not approved, and are in the **Pending** status, approve the CSRs for your cluster machines:

- To approve them individually, run the following command for each valid CSR:

```
$ oc adm certificate approve <csr_name> 1
```

**1** **<csr\_name>** is the name of a CSR from the list of current CSRs.

- To approve all pending CSRs, run the following command:

```
$ oc get csr -o go-template='{{range .items}}{{if not .status}}{{.metadata.name}}{\n"}\n{{end}}' | xargs oc adm certificate approve
```

- After all client and server CSRs have been approved, the machines have the **Ready** status. Verify this by running the following command:

```
$ oc get nodes
```

#### Example output

```
NAME      STATUS   ROLES    AGE   VERSION
master-0 Ready    master   73m   v1.23.0
```

```

master-1 Ready   master 73m v1.23.0
master-2 Ready   master 74m v1.23.0
worker-0 Ready   worker 11m v1.23.0
worker-1 Ready   worker 11m v1.23.0

```



## NOTE

It can take a few minutes after approval of the server CSRs for the machines to transition to the **Ready** status.

### Additional information

- For more information on CSRs, see [Certificate Signing Requests](#).

### 5.14.20. Initial Operator configuration

After the control plane initializes, you must immediately configure some Operators so that they all become available.

#### Prerequisites

- Your control plane has initialized.

#### Procedure

1. Watch the cluster components come online:

```
$ watch -n5 oc get clusteroperators
```

#### Example output

NAME	VERSION	AVAILABLE	PROGRESSING	DEGRADED	SINCE
authentication	4.10.0	True	False	False	19m
baremetal	4.10.0	True	False	False	37m
cloud-credential	4.10.0	True	False	False	40m
cluster-autoscaler	4.10.0	True	False	False	37m
config-operator	4.10.0	True	False	False	38m
console	4.10.0	True	False	False	26m
csi-snapshot-controller	4.10.0	True	False	False	37m
dns	4.10.0	True	False	False	37m
etcd	4.10.0	True	False	False	36m
image-registry	4.10.0	True	False	False	31m
ingress	4.10.0	True	False	False	30m
insights	4.10.0	True	False	False	31m
kube-apiserver	4.10.0	True	False	False	26m
kube-controller-manager	4.10.0	True	False	False	36m
kube-scheduler	4.10.0	True	False	False	36m
kube-storage-version-migrator	4.10.0	True	False	False	37m
machine-api	4.10.0	True	False	False	29m
machine-approver	4.10.0	True	False	False	37m
machine-config	4.10.0	True	False	False	36m
marketplace	4.10.0	True	False	False	37m
monitoring	4.10.0	True	False	False	29m

network	4.10.0	True	False	False	38m
node-tuning	4.10.0	True	False	False	37m
openshift-apiserver	4.10.0	True	False	False	32m
openshift-controller-manager	4.10.0	True	False	False	30m
openshift-samples	4.10.0	True	False	False	32m
operator-lifecycle-manager	4.10.0	True	False	False	37m
operator-lifecycle-manager-catalog	4.10.0	True	False	False	37m
operator-lifecycle-manager-packageserver	4.10.0	True	False	False	32m
service-ca	4.10.0	True	False	False	38m
storage	4.10.0	True	False	False	37m

2. Configure the Operators that are not available.

### 5.14.20.1. Disabling the default OperatorHub sources

Operator catalogs that source content provided by Red Hat and community projects are configured for OperatorHub by default during an OpenShift Container Platform installation. In a restricted network environment, you must disable the default catalogs as a cluster administrator.

#### Procedure

- Disable the sources for the default catalogs by adding **disableAllDefaultSources: true** to the **OperatorHub** object:

```
$ oc patch OperatorHub cluster --type json \
  -p [{"op": "add", "path": "/spec/disableAllDefaultSources", "value": true}]
```

#### TIP

Alternatively, you can use the web console to manage catalog sources. From the **Administration** → **Cluster Settings** → **Configuration** → **OperatorHub** page, click the **Sources** tab, where you can create, delete, disable, and enable individual sources.

### 5.14.20.2. Image registry storage configuration

Amazon Web Services provides default storage, which means the Image Registry Operator is available after installation. However, if the Registry Operator cannot create an S3 bucket and automatically configure storage, you must manually configure registry storage.

Instructions are shown for configuring a persistent volume, which is required for production clusters. Where applicable, instructions are shown for configuring an empty directory as the storage location, which is available for only non-production clusters.

Additional instructions are provided for allowing the image registry to use block storage types by using the **Recreate** rollout strategy during upgrades.

#### 5.14.20.2.1. Configuring registry storage for AWS with user-provisioned infrastructure

During installation, your cloud credentials are sufficient to create an Amazon S3 bucket and the Registry Operator will automatically configure storage.

If the Registry Operator cannot create an S3 bucket and automatically configure storage, you can create an S3 bucket and configure storage with the following procedure.



## Prerequisites

- You have a cluster on AWS with user-provisioned infrastructure.
- For Amazon S3 storage, the secret is expected to contain two keys:
  - **REGISTRY\_STORAGE\_S3\_ACCESSKEY**
  - **REGISTRY\_STORAGE\_S3\_SECRETKEY**

## Procedure

Use the following procedure if the Registry Operator cannot create an S3 bucket and automatically configure storage.

1. Set up a [Bucket Lifecycle Policy](#) to abort incomplete multipart uploads that are one day old.
2. Fill in the storage configuration in **configs.imageregistry.operator.openshift.io/cluster**:

```
$ oc edit configs.imageregistry.operator.openshift.io/cluster
```

### Example configuration

```
storage:
  s3:
    bucket: <bucket-name>
    region: <region-name>
```



### WARNING

To secure your registry images in AWS, [block public access](#) to the S3 bucket.

#### 5.14.20.2.2. Configuring storage for the image registry in non-production clusters

You must configure storage for the Image Registry Operator. For non-production clusters, you can set the image registry to an empty directory. If you do so, all images are lost if you restart the registry.

## Procedure

- To set the image registry storage to an empty directory:

```
$ oc patch configs.imageregistry.operator.openshift.io cluster --type merge --patch '{"spec": {"storage":{"emptyDir":{}}}'
```

**WARNING**

Configure this option for only non-production clusters.

If you run this command before the Image Registry Operator initializes its components, the **oc patch** command fails with the following error:

```
Error from server (NotFound): configs.imageregistry.operator.openshift.io "cluster" not found
```

Wait a few minutes and run the command again.

### 5.14.21. Deleting the bootstrap resources

After you complete the initial Operator configuration for the cluster, remove the bootstrap resources from Amazon Web Services (AWS).

#### Prerequisites

- You completed the initial Operator configuration for your cluster.

#### Procedure

- Delete the bootstrap resources. If you used the CloudFormation template, [delete its stack](#):

- Delete the stack by using the AWS CLI:

```
$ aws cloudformation delete-stack --stack-name <name> 1
```

**1** **<name>** is the name of your bootstrap stack.

- Delete the stack by using the [AWS CloudFormation console](#).

### 5.14.22. Creating the Ingress DNS Records

If you removed the DNS Zone configuration, manually create DNS records that point to the Ingress load balancer. You can create either a wildcard record or specific records. While the following procedure uses A records, you can use other record types that you require, such as CNAME or alias.

#### Prerequisites

- You deployed an OpenShift Container Platform cluster on Amazon Web Services (AWS) that uses infrastructure that you provisioned.
- You installed the OpenShift CLI (**oc**).
- You installed the **jq** package.
- You downloaded the AWS CLI and installed it on your computer. See [Install the AWS CLI Using the Bundled Installer \(Linux, macOS, or Unix\)](#).

## Procedure

1. Determine the routes to create.

- To create a wildcard record, use `*.apps.<cluster_name>.<domain_name>`, where `<cluster_name>` is your cluster name, and `<domain_name>` is the Route 53 base domain for your OpenShift Container Platform cluster.
- To create specific records, you must create a record for each route that your cluster uses, as shown in the output of the following command:

```
$ oc get --all-namespaces -o jsonpath='{range .items[*]}{range .status.ingress[*]}{.host}
{"\n"}{end}{end}' routes
```

### Example output

```
oauth-openshift.apps.<cluster_name>.<domain_name>
console-openshift-console.apps.<cluster_name>.<domain_name>
downloads-openshift-console.apps.<cluster_name>.<domain_name>
alertmanager-main-openshift-monitoring.apps.<cluster_name>.<domain_name>
grafana-openshift-monitoring.apps.<cluster_name>.<domain_name>
prometheus-k8s-openshift-monitoring.apps.<cluster_name>.<domain_name>
```

2. Retrieve the Ingress Operator load balancer status and note the value of the external IP address that it uses, which is shown in the **EXTERNAL-IP** column:

```
$ oc -n openshift-ingress get service router-default
```

### Example output

NAME	TYPE	CLUSTER-IP	EXTERNAL-IP	PORT(S)
router-default	LoadBalancer	172.30.62.215	ab3...28.us-east-2.elb.amazonaws.com	80:31499/TCP,443:30693/TCP
		5m		

3. Locate the hosted zone ID for the load balancer:

```
$ aws elb describe-load-balancers | jq -r '.LoadBalancerDescriptions[] | select(.DNSName ==
"<external_ip>").CanonicalHostedZoneNameID' 1
```

- 1** For `<external_ip>`, specify the value of the external IP address of the Ingress Operator load balancer that you obtained.

### Example output

```
Z3AADJGX6KTTL2
```

The output of this command is the load balancer hosted zone ID.

4. Obtain the public hosted zone ID for your cluster's domain:

```
$ aws route53 list-hosted-zones-by-name \
```

```

--dns-name "<domain_name>" \ 1
--query 'HostedZones[? Config.PrivateZone != `true` && Name ==
`<domain_name>.`].Id' 2
--output text

```

- 1 For **<domain\_name>**, specify the Route 53 base domain for your OpenShift Container Platform cluster.

### Example output

```
/hostedzone/Z3URY6TWQ91KVV
```

The public hosted zone ID for your domain is shown in the command output. In this example, it is **Z3URY6TWQ91KVV**.

5. Add the alias records to your private zone:

```

$ aws route53 change-resource-record-sets --hosted-zone-id "<private_hosted_zone_id>" --
change-batch '{ 1
> "Changes": [
> {
>   "Action": "CREATE",
>   "ResourceRecordSet": {
>     "Name": "\\052.apps.<cluster_domain>", 2
>     "Type": "A",
>     "AliasTarget":{
>       "HostedZoneId": "<hosted_zone_id>", 3
>       "DNSName": "<external_ip>.", 4
>       "EvaluateTargetHealth": false
>     }
>   }
> }
> ]
> }'

```

- 1 For **<private\_hosted\_zone\_id>**, specify the value from the output of the CloudFormation template for DNS and load balancing.
- 2 For **<cluster\_domain>**, specify the domain or subdomain that you use with your OpenShift Container Platform cluster.
- 3 For **<hosted\_zone\_id>**, specify the public hosted zone ID for the load balancer that you obtained.
- 4 For **<external\_ip>**, specify the value of the external IP address of the Ingress Operator load balancer. Ensure that you include the trailing period (.) in this parameter value.

6. Add the records to your public zone:

```

$ aws route53 change-resource-record-sets --hosted-zone-id "<public_hosted_zone_id>" --
change-batch '{ 1
> "Changes": [
> {

```

```

>   "Action": "CREATE",
>   "ResourceRecordSet": {
>     "Name": "\\052.apps.<cluster_domain>", ❷
>     "Type": "A",
>     "AliasTarget":{
>       "HostedZoneId": "<hosted_zone_id>", ❸
>       "DNSName": "<external_ip>.", ❹
>       "EvaluateTargetHealth": false
>     }
>   }
> }
> ]
> }'

```

- ❶ For **<public\_hosted\_zone\_id>**, specify the public hosted zone for your domain.
- ❷ For **<cluster\_domain>**, specify the domain or subdomain that you use with your OpenShift Container Platform cluster.
- ❸ For **<hosted\_zone\_id>**, specify the public hosted zone ID for the load balancer that you obtained.
- ❹ For **<external\_ip>**, specify the value of the external IP address of the Ingress Operator load balancer. Ensure that you include the trailing period (.) in this parameter value.

### 5.14.23. Completing an AWS installation on user-provisioned infrastructure

After you start the OpenShift Container Platform installation on Amazon Web Service (AWS) user-provisioned infrastructure, monitor the deployment to completion.

#### Prerequisites

- You removed the bootstrap node for an OpenShift Container Platform cluster on user-provisioned AWS infrastructure.
- You installed the **oc** CLI.

#### Procedure

1. From the directory that contains the installation program, complete the cluster installation:

```
$ ./openshift-install --dir <installation_directory> wait-for install-complete ❶
```

- ❶ For **<installation\_directory>**, specify the path to the directory that you stored the installation files in.

#### Example output

```

INFO Waiting up to 40m0s for the cluster at https://api.mycluster.example.com:6443 to
initialize...
INFO Waiting up to 10m0s for the openshift-console route to be created...
INFO Install complete!
INFO To access the cluster as the system:admin user when using 'oc', run 'export

```

```
KUBECONFIG=/home/myuser/install_dir/auth/kubeconfig'
INFO Access the OpenShift web-console here: https://console-openshift-
console.apps.mycluster.example.com
INFO Login to the console with user: "kubeadmin", and password: "password"
INFO Time elapsed: 1s
```



## IMPORTANT

- The Ignition config files that the installation program generates contain certificates that expire after 24 hours, which are then renewed at that time. If the cluster is shut down before renewing the certificates and the cluster is later restarted after the 24 hours have elapsed, the cluster automatically recovers the expired certificates. The exception is that you must manually approve the pending **node-bootstrapper** certificate signing requests (CSRs) to recover kubelet certificates. See the documentation for *Recovering from expired control plane certificates* for more information.
- It is recommended that you use Ignition config files within 12 hours after they are generated because the 24-hour certificate rotates from 16 to 22 hours after the cluster is installed. By using the Ignition config files within 12 hours, you can avoid installation failure if the certificate update runs during installation.

2. Register your cluster on the [Cluster registration](#) page.

### 5.14.24. Logging in to the cluster by using the web console

The **kubeadmin** user exists by default after an OpenShift Container Platform installation. You can log in to your cluster as the **kubeadmin** user by using the OpenShift Container Platform web console.

#### Prerequisites

- You have access to the installation host.
- You completed a cluster installation and all cluster Operators are available.

#### Procedure

1. Obtain the password for the **kubeadmin** user from the **kubeadmin-password** file on the installation host:

```
$ cat <installation_directory>/auth/kubeadmin-password
```



## NOTE

Alternatively, you can obtain the **kubeadmin** password from the **<installation\_directory>/openshift\_install.log** log file on the installation host.

2. List the OpenShift Container Platform web console route:

```
$ oc get routes -n openshift-console | grep 'console-openshift'
```

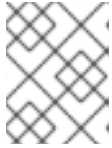
**NOTE**

Alternatively, you can obtain the OpenShift Container Platform route from the `<installation_directory>/openshift_install.log` log file on the installation host.

**Example output**

```
console console-openshift-console.apps.<cluster_name>.<base_domain> console
https reencrypt/Redirect None
```

3. Navigate to the route detailed in the output of the preceding command in a web browser and log in as the **kubeadmin** user.

**Additional resources**

- See [Accessing the web console](#) for more details about accessing and understanding the OpenShift Container Platform web console.

**5.14.25. Telemetry access for OpenShift Container Platform**

In OpenShift Container Platform 4.10, the Telemetry service, which runs by default to provide metrics about cluster health and the success of updates, requires internet access. If your cluster is connected to the internet, Telemetry runs automatically, and your cluster is registered to [OpenShift Cluster Manager](#).

After you confirm that your [OpenShift Cluster Manager](#) inventory is correct, either maintained automatically by Telemetry or manually by using OpenShift Cluster Manager, [use subscription watch](#) to track your OpenShift Container Platform subscriptions at the account or multi-cluster level.

**Additional resources**

- See [About remote health monitoring](#) for more information about the Telemetry service

**5.14.26. Additional resources**

- See [Working with stacks](#) in the AWS documentation for more information about AWS CloudFormation stacks.

**5.14.27. Next steps**

- [Validate an installation.](#)
- [Customize your cluster.](#)
- [Configure image streams](#) for the Cluster Samples Operator and the **must-gather** tool.
- Learn how to [use Operator Lifecycle Manager \(OLM\) on restricted networks](#) .
- If the mirror registry that you used to install your cluster has a trusted CA, add it to the cluster by [configuring additional trust stores](#).
- If necessary, you can [opt out of remote health reporting](#) .
- If necessary, see [Registering your disconnected cluster](#)

- If necessary, you can [remove cloud provider credentials](#).

## 5.15. UNINSTALLING A CLUSTER ON AWS

You can remove a cluster that you deployed to Amazon Web Services (AWS).

### 5.15.1. Removing a cluster that uses installer-provisioned infrastructure

You can remove a cluster that uses installer-provisioned infrastructure from your cloud.



#### NOTE

After uninstallation, check your cloud provider for any resources not removed properly, especially with User Provisioned Infrastructure (UPI) clusters. There might be resources that the installer did not create or that the installer is unable to access.

#### Prerequisites

- Have a copy of the installation program that you used to deploy the cluster.
- Have the files that the installation program generated when you created your cluster.

#### Procedure

1. From the directory that contains the installation program on the computer that you used to install the cluster, run the following command:

```

$ ./openshift-install destroy cluster \
--dir <installation_directory> --log-level info 1 2

```

- 1** For **<installation\_directory>**, specify the path to the directory that you stored the installation files in.
- 2** To view different details, specify **warn**, **debug**, or **error** instead of **info**.



#### NOTE

You must specify the directory that contains the cluster definition files for your cluster. The installation program requires the **metadata.json** file in this directory to delete the cluster.

1. Optional: Delete the **<installation\_directory>** directory and the OpenShift Container Platform installation program.

### 5.15.2. Deleting AWS resources with the Cloud Credential Operator utility

To clean up resources after uninstalling an OpenShift Container Platform cluster with the Cloud Credential Operator (CCO) in manual mode with STS, you can use the CCO utility (**ccoctl**) to remove the AWS resources that **ccoctl** created during installation.

#### Prerequisites



- Extract and prepare the **ccoctl** binary.
- Install an OpenShift Container Platform cluster with the CCO in manual mode with STS.

## Procedure

- Delete the AWS resources that **ccoctl** created:

```
$ ccoctl aws delete \
  --name=<name> \ 1
  --region=<aws_region> 2
```

**1** **<name>** matches the name that was originally used to create and tag the cloud resources.

**2** **<aws\_region>** is the AWS region in which to delete cloud resources.

## Example output:

```
2021/04/08 17:50:41 Identity Provider object .well-known/openid-configuration deleted from
the bucket <name>-oidc
2021/04/08 17:50:42 Identity Provider object keys.json deleted from the bucket <name>-oidc
2021/04/08 17:50:43 Identity Provider bucket <name>-oidc deleted
2021/04/08 17:51:05 Policy <name>-openshift-cloud-credential-operator-cloud-credential-o
associated with IAM Role <name>-openshift-cloud-credential-operator-cloud-credential-o
deleted
2021/04/08 17:51:05 IAM Role <name>-openshift-cloud-credential-operator-cloud-credential-
o deleted
2021/04/08 17:51:07 Policy <name>-openshift-cluster-csi-drivers-ebs-cloud-credentials
associated with IAM Role <name>-openshift-cluster-csi-drivers-ebs-cloud-credentials deleted
2021/04/08 17:51:07 IAM Role <name>-openshift-cluster-csi-drivers-ebs-cloud-credentials
deleted
2021/04/08 17:51:08 Policy <name>-openshift-image-registry-installer-cloud-credentials
associated with IAM Role <name>-openshift-image-registry-installer-cloud-credentials
deleted
2021/04/08 17:51:08 IAM Role <name>-openshift-image-registry-installer-cloud-credentials
deleted
2021/04/08 17:51:09 Policy <name>-openshift-ingress-operator-cloud-credentials associated
with IAM Role <name>-openshift-ingress-operator-cloud-credentials deleted
2021/04/08 17:51:10 IAM Role <name>-openshift-ingress-operator-cloud-credentials deleted
2021/04/08 17:51:11 Policy <name>-openshift-machine-api-aws-cloud-credentials associated
with IAM Role <name>-openshift-machine-api-aws-cloud-credentials deleted
2021/04/08 17:51:11 IAM Role <name>-openshift-machine-api-aws-cloud-credentials deleted
2021/04/08 17:51:39 Identity Provider with ARN arn:aws:iam::<aws_account_id>:oidc-
provider/<name>-oidc.s3.<aws_region>.amazonaws.com deleted
```

## Verification

- To verify that the resources are deleted, query AWS. For more information, refer to AWS documentation.

## CHAPTER 6. INSTALLING ON AZURE

### 6.1. PREPARING TO INSTALL ON AZURE

#### 6.1.1. Prerequisites

- You reviewed details about the [OpenShift Container Platform installation and update](#) processes.
- You read the documentation on [selecting a cluster installation method and preparing it for users](#).

#### 6.1.2. Requirements for installing OpenShift Container Platform on Azure

Before installing OpenShift Container Platform on Microsoft Azure, you must configure an Azure account. See [Configuring an Azure account](#) for details about account configuration, account limits, public DNS zone configuration, required roles, creating service principals, and supported Azure regions.

If the cloud identity and access management (IAM) APIs are not accessible in your environment, or if you do not want to store an administrator-level credential secret in the **kube-system** namespace, see [Manually creating IAM for Azure](#) for other options.

#### 6.1.3. Choosing a method to install OpenShift Container Platform on Azure

You can install OpenShift Container Platform on installer-provisioned or user-provisioned infrastructure. The default installation type uses installer-provisioned infrastructure, where the installation program provisions the underlying infrastructure for the cluster. You can also install OpenShift Container Platform on infrastructure that you provision. If you do not use infrastructure that the installation program provisions, you must manage and maintain the cluster resources yourself.

See [Installation process](#) for more information about installer-provisioned and user-provisioned installation processes.

##### 6.1.3.1. Installing a cluster on installer-provisioned infrastructure

You can install a cluster on Azure infrastructure that is provisioned by the OpenShift Container Platform installation program, by using one of the following methods:

- **Installing a cluster quickly on Azure** You can install OpenShift Container Platform on Azure infrastructure that is provisioned by the OpenShift Container Platform installation program. You can install a cluster quickly by using the default configuration options.
- **Installing a customized cluster on Azure** You can install a customized cluster on Azure infrastructure that the installation program provisions. The installation program allows for some customization to be applied at the installation stage. Many other customization options are available [post-installation](#).
- **Installing a cluster on Azure with network customizations** You can customize your OpenShift Container Platform network configuration during installation, so that your cluster can coexist with your existing IP address allocations and adhere to your network requirements.
- **Installing a cluster on Azure into an existing VNet** You can install OpenShift Container Platform on an existing Azure Virtual Network (VNet) on Azure. You can use this installation method if you have constraints set by the guidelines of your company, such as limits when

creating new accounts or infrastructure.

- **Installing a private cluster on Azure** You can install a private cluster into an existing Azure Virtual Network (VNet) on Azure. You can use this method to deploy OpenShift Container Platform on an internal network that is not visible to the internet.
- **Installing a cluster on Azure into a government region** OpenShift Container Platform can be deployed into Microsoft Azure Government (MAG) regions that are specifically designed for US government agencies at the federal, state, and local level, as well as contractors, educational institutions, and other US customers that must run sensitive workloads on Azure.

### 6.1.3.2. Installing a cluster on user-provisioned infrastructure

You can install a cluster on Azure infrastructure that you provision, by using the following method:

- **Installing a cluster on Azure using ARM templates** You can install OpenShift Container Platform on Azure by using infrastructure that you provide. You can use the provided Azure Resource Manager (ARM) templates to assist with an installation.

### 6.1.4. Next steps

- [Configuring an Azure account](#)

## 6.2. CONFIGURING AN AZURE ACCOUNT

Before you can install OpenShift Container Platform, you must configure a Microsoft Azure account.



### IMPORTANT

All Azure resources that are available through public endpoints are subject to resource name restrictions, and you cannot create resources that use certain terms. For a list of terms that Azure restricts, see [Resolve reserved resource name errors](#) in the Azure documentation.

### 6.2.1. Azure account limits

The OpenShift Container Platform cluster uses a number of Microsoft Azure components, and the default [Azure subscription and service limits, quotas, and constraints](#) affect your ability to install OpenShift Container Platform clusters.

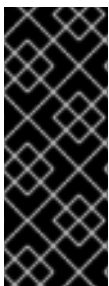

### IMPORTANT

Default limits vary by offer category types, such as Free Trial and Pay-As-You-Go, and by series, such as Dv2, F, and G. For example, the default for Enterprise Agreement subscriptions is 350 cores.

Check the limits for your subscription type and if necessary, increase quota limits for your account before you install a default cluster on Azure.

The following table summarizes the Azure components whose limits can impact your ability to install and run OpenShift Container Platform clusters.

Component	Number of components required by default	Default Azure limit	Description
vCPU	40	20 per region	<p>A default cluster requires 40 vCPUs, so you must increase the account limit.</p> <p>By default, each cluster creates the following instances:</p> <ul style="list-style-type: none"> <li>• One bootstrap machine, which is removed after installation</li> <li>• Three control plane machines</li> <li>• Three compute machines</li> </ul> <p>Because the bootstrap machine uses <b>Standard_D4s_v3</b> machines, which use 4 vCPUs, the control plane machines use <b>Standard_D8s_v3</b> virtual machines, which use 8 vCPUs, and the worker machines use <b>Standard_D4s_v3</b> virtual machines, which use 4 vCPUs, a default cluster requires 40 vCPUs. The bootstrap node VM, which uses 4 vCPUs, is used only during installation.</p> <p>To deploy more worker nodes, enable autoscaling, deploy large workloads, or use a different instance type, you must further increase the vCPU limit for your account to ensure that your cluster can deploy the machines that you require.</p>
OS Disk	7		<p>Each cluster machine must have a minimum of 100 GB of storage and 300 IOPS. While these are the minimum supported values, faster storage is recommended for production clusters and clusters with intensive workloads. For more information about optimizing storage for performance, see the page titled "Optimizing storage" in the "Scalability and performance" section.</p>
VNet	1	1000 per region	<p>Each default cluster requires one Virtual Network (VNet), which contains two subnets.</p>
Network interfaces	7	65,536 per region	<p>Each default cluster requires seven network interfaces. If you create more machines or your deployed workloads create load balancers, your cluster uses more network interfaces.</p>

Component	Number of components required by default	Default Azure limit	Description						
Network security groups	2	5000	<p>Each cluster creates network security groups for each subnet in the VNet. The default cluster creates network security groups for the control plane and for the compute node subnets:</p> <table border="1"> <tr> <td><b>control plane</b></td> <td>Allows the control plane machines to be reached on port 6443 from anywhere</td> </tr> <tr> <td><b>node</b></td> <td>Allows worker nodes to be reached from the internet on ports 80 and 443</td> </tr> </table>	<b>control plane</b>	Allows the control plane machines to be reached on port 6443 from anywhere	<b>node</b>	Allows worker nodes to be reached from the internet on ports 80 and 443		
<b>control plane</b>	Allows the control plane machines to be reached on port 6443 from anywhere								
<b>node</b>	Allows worker nodes to be reached from the internet on ports 80 and 443								
Network load balancers	3	1000 per region	<p>Each cluster creates the following <a href="#">load balancers</a>:</p> <table border="1"> <tr> <td><b>default</b></td> <td>Public IP address that load balances requests to ports 80 and 443 across worker machines</td> </tr> <tr> <td><b>internal</b></td> <td>Private IP address that load balances requests to ports 6443 and 22623 across control plane machines</td> </tr> <tr> <td><b>external</b></td> <td>Public IP address that load balances requests to port 6443 across control plane machines</td> </tr> </table> <p>If your applications create more Kubernetes <b>LoadBalancer</b> service objects, your cluster uses more load balancers.</p>	<b>default</b>	Public IP address that load balances requests to ports 80 and 443 across worker machines	<b>internal</b>	Private IP address that load balances requests to ports 6443 and 22623 across control plane machines	<b>external</b>	Public IP address that load balances requests to port 6443 across control plane machines
<b>default</b>	Public IP address that load balances requests to ports 80 and 443 across worker machines								
<b>internal</b>	Private IP address that load balances requests to ports 6443 and 22623 across control plane machines								
<b>external</b>	Public IP address that load balances requests to port 6443 across control plane machines								
Public IP addresses	3		Each of the two public load balancers uses a public IP address. The bootstrap machine also uses a public IP address so that you can SSH into the machine to troubleshoot issues during installation. The IP address for the bootstrap node is used only during installation.						
Private IP addresses	7		The internal load balancer, each of the three control plane machines, and each of the three worker machines each use a private IP address.						

Component	Number of components required by default	Default Azure limit	Description
Spot VM vCPUs (optional)	0 If you configure spot VMs, your cluster must have two spot VM vCPUs for every compute node.	20 per region	<p>This is an optional component. To use spot VMs, you must increase the Azure default limit to at least twice the number of compute nodes in your cluster.</p> <div style="display: flex; align-items: center;">  <div> <p><b>NOTE</b></p> <p>Using spot VMs for control plane nodes is not recommended.</p> </div> </div>

### Additional resources

- [Optimizing storage](#).

## 6.2.2. Configuring a public DNS zone in Azure

To install OpenShift Container Platform, the Microsoft Azure account you use must have a dedicated public hosted DNS zone in your account. This zone must be authoritative for the domain. This service provides cluster DNS resolution and name lookup for external connections to the cluster.

### Procedure

1. Identify your domain, or subdomain, and registrar. You can transfer an existing domain and registrar or obtain a new one through Azure or another source.



#### NOTE

For more information about purchasing domains through Azure, see [Buy a custom domain name for Azure App Service](#) in the Azure documentation.

2. If you are using an existing domain and registrar, migrate its DNS to Azure. See [Migrate an active DNS name to Azure App Service](#) in the Azure documentation.
3. Configure DNS for your domain. Follow the steps in the [Tutorial: Host your domain in Azure DNS](#) in the Azure documentation to create a public hosted zone for your domain or subdomain, extract the new authoritative name servers, and update the registrar records for the name servers that your domain uses.  
Use an appropriate root domain, such as **openshiftcorp.com**, or subdomain, such as **clusters.openshiftcorp.com**.
4. If you use a subdomain, follow your company's procedures to add its delegation records to the parent domain.

## 6.2.3. Increasing Azure account limits

To increase an account limit, file a support request on the Azure portal.

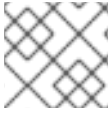
**NOTE**

You can increase only one type of quota per support request.

**Procedure**

1. From the Azure portal, click **Help + support** in the lower left corner.
2. Click **New support request** and then select the required values:
  - a. From the **Issue type** list, select **Service and subscription limits (quotas)**
  - b. From the **Subscription** list, select the subscription to modify.
  - c. From the **Quota type** list, select the quota to increase. For example, select **Compute-VM (cores-vCPUs) subscription limit increases** to increase the number of vCPUs, which is required to install a cluster.
  - d. Click **Next: Solutions**.
3. On the **Problem Details** page, provide the required information for your quota increase:
  - a. Click **Provide details** and provide the required details in the **Quota details** window.
  - b. In the **SUPPORT METHOD** and **CONTACT INFO** sections, provide the issue severity and your contact details.
4. Click **Next: Review + create** and then click **Create**.

**6.2.4. Required Azure roles**

OpenShift Container Platform needs a service principal so it can manage Microsoft Azure resources. Before you can create a service principal, review the following information:

Your Azure account subscription must have the following roles:

- **User Access Administrator**
- **Contributor**

Your Azure Active Directory (AD) must have the following permission:

- **"microsoft.directory/servicePrincipals/createAsOwner"**

To set roles on the Azure portal, see the [Manage access to Azure resources using RBAC and the Azure portal](#) in the Azure documentation.

**6.2.5. Creating a service principal**

Because OpenShift Container Platform and its installation program create Microsoft Azure resources by using the Azure Resource Manager, you must create a service principal to represent it.

**Prerequisites**

- Install or update the [Azure CLI](#).
- Your Azure account has the required roles for the subscription that you use.

## Procedure

1. Log in to the Azure CLI:

```
$ az login
```

2. If your Azure account uses subscriptions, ensure that you are using the right subscription:
  - a. View the list of available accounts and record the **tenantId** value for the subscription you want to use for your cluster:

```
$ az account list --refresh
```

### Example output

```
[
  {
    "cloudName": "AzureCloud",
    "id": "9bab1460-96d5-40b3-a78e-17b15e978a80",
    "isDefault": true,
    "name": "Subscription Name",
    "state": "Enabled",
    "tenantId": "6057c7e9-b3ae-489d-a54e-de3f6bf6a8ee",
    "user": {
      "name": "you@example.com",
      "type": "user"
    }
  }
]
```

- b. View your active account details and confirm that the **tenantId** value matches the subscription you want to use:

```
$ az account show
```

### Example output

```
{
  "environmentName": "AzureCloud",
  "id": "9bab1460-96d5-40b3-a78e-17b15e978a80",
  "isDefault": true,
  "name": "Subscription Name",
  "state": "Enabled",
  "tenantId": "6057c7e9-b3ae-489d-a54e-de3f6bf6a8ee", 1
  "user": {
    "name": "you@example.com",
    "type": "user"
  }
}
```

- 1** Ensure that the value of the **tenantId** parameter is the correct subscription ID.

- c. If you are not using the right subscription, change the active subscription:



```
$ az account set -s <subscription_id> ❶
```

- ❶ Specify the subscription ID.

d. Verify the subscription ID update:

```
$ az account show
```

### Example output

```
{
  "environmentName": "AzureCloud",
  "id": "33212d16-bdf6-45cb-b038-f6565b61edda",
  "isDefault": true,
  "name": "Subscription Name",
  "state": "Enabled",
  "tenantId": "8049c7e9-c3de-762d-a54e-dc3f6be6a7ee",
  "user": {
    "name": "you@example.com",
    "type": "user"
  }
}
```

3. Record the **tenantId** and **id** parameter values from the output. You need these values during the OpenShift Container Platform installation.
4. Create the service principal for your account:

```
$ az ad sp create-for-rbac --role Contributor --name <service_principal> \ ❶
--scopes /subscriptions/<subscription_id> ❷
--years <years> ❸
```

- ❶ Specify the service principal name.
- ❷ Specify the subscription ID.
- ❸ Specify the number of years. By default, a service principal expires in one year. By using the **--years** option you can extend the validity of your service principal.

### Example output

```
Creating 'Contributor' role assignment under scope '/subscriptions/<subscription_id>'
The output includes credentials that you must protect. Be sure that you do not
include these credentials in your code or check the credentials into your source
control. For more information, see https://aka.ms/azadsp-cli
{
  "appId": "ac461d78-bf4b-4387-ad16-7e32e328aec6",
  "displayName": <service_principal>,
  "password": "00000000-0000-0000-0000-000000000000",
  "tenantId": "8049c7e9-c3de-762d-a54e-dc3f6be6a7ee"
}
```

- Record the values of the **appld** and **password** parameters from the previous output. You need these values during OpenShift Container Platform installation.
- Assign the **User Access Administrator** role by running the following command:

```
$ az role assignment create --role "User Access Administrator" \  
--assignee-object-id $(az ad sp show --id <appld> --query id -o tsv) 1
```

- Specify the **appld** parameter value for your service principal.

### Additional resources

- For more information about CCO modes, see [About the Cloud Credential Operator](#).

## 6.2.6. Supported Azure Marketplace regions

Installing a cluster by using the Azure Marketplace image is available to customers who purchase the offer in North America and EMEA.

While the offer must be purchased in North America or EMEA, you can deploy the cluster to any of the Azure public partitions that OpenShift Container Platform supports.



### NOTE

Deploying a cluster by using the Azure Marketplace image is not supported for the Azure Government regions.

## 6.2.7. Supported Azure regions

The installation program dynamically generates the list of available Microsoft Azure regions based on your subscription.

### Supported Azure public regions

- australiacentral** (Australia Central)
- australiaeast** (Australia East)
- australiasoutheast** (Australia South East)
- brazilsouth** (Brazil South)
- canadacentral** (Canada Central)
- canadaeast** (Canada East)
- centralindia** (Central India)
- centralus** (Central US)
- eastasia** (East Asia)
- eastus** (East US)
- eastus2** (East US 2)

- **francecentral** (France Central)
- **germanywestcentral** (Germany West Central)
- **japaneast** (Japan East)
- **japanwest** (Japan West)
- **koreacentral** (Korea Central)
- **koreasouth** (Korea South)
- **northcentralus** (North Central US)
- **northeurope** (North Europe)
- **norwayeast** (Norway East)
- **qatarcentral** (Qatar Central)
- **southafricanorth** (South Africa North)
- **southcentralus** (South Central US)
- **southeastasia** (Southeast Asia)
- **southindia** (South India)
- **swedencentral** (Sweden Central)
- **switzerlandnorth** (Switzerland North)
- **uaenorth** (UAE North)
- **uksouth** (UK South)
- **ukwest** (UK West)
- **westcentralus** (West Central US)
- **westeurope** (West Europe)
- **westindia** (West India)
- **westus** (West US)
- **westus2** (West US 2)
- **westus3** (West US 3)

#### Supported Azure Government regions

Support for the following Microsoft Azure Government (MAG) regions was added in OpenShift Container Platform version 4.6:

- **usgovtexas** (US Gov Texas)
- **usgovvirginia** (US Gov Virginia)

You can reference all available MAG regions in the [Azure documentation](#). Other provided MAG regions are expected to work with OpenShift Container Platform, but have not been tested.

### 6.2.8. Next steps

- Install an OpenShift Container Platform cluster on Azure. You can [install a customized cluster](#) or [quickly install a cluster](#) with default options.

## 6.3. MANUALLY CREATING IAM FOR AZURE

In environments where the cloud identity and access management (IAM) APIs are not reachable, or the administrator prefers not to store an administrator-level credential secret in the cluster **kube-system** namespace, you can put the Cloud Credential Operator (CCO) into manual mode before you install the cluster.

### 6.3.1. Alternatives to storing administrator-level secrets in the kube-system project

The Cloud Credential Operator (CCO) manages cloud provider credentials as Kubernetes custom resource definitions (CRDs). You can configure the CCO to suit the security requirements of your organization by setting different values for the **credentialsMode** parameter in the **install-config.yaml** file.

If you prefer not to store an administrator-level credential secret in the cluster **kube-system** project, you can set the **credentialsMode** parameter for the CCO to **Manual** when installing OpenShift Container Platform and manage your cloud credentials manually.

Using manual mode allows each cluster component to have only the permissions it requires, without storing an administrator-level credential in the cluster. You can also use this mode if your environment does not have connectivity to the cloud provider public IAM endpoint. However, you must manually reconcile permissions with new release images for every upgrade. You must also manually supply credentials for every component that requests them.

#### Additional resources

- For a detailed description of all available CCO credential modes and their supported platforms, see [About the Cloud Credential Operator](#).

### 6.3.2. Manually create IAM

The Cloud Credential Operator (CCO) can be put into manual mode prior to installation in environments where the cloud identity and access management (IAM) APIs are not reachable, or the administrator prefers not to store an administrator-level credential secret in the cluster **kube-system** namespace.

#### Procedure

1. Change to the directory that contains the installation program and create the **install-config.yaml** file by running the following command:

```
$ openshift-install create install-config --dir <installation_directory>
```

where **<installation\_directory>** is the directory in which the installation program creates files.

2. Edit the **install-config.yaml** configuration file so that it contains the **credentialsMode** parameter set to **Manual**.

### Example install-config.yaml configuration file

```
apiVersion: v1
baseDomain: cluster1.example.com
credentialsMode: Manual 1
compute:
- architecture: amd64
  hyperthreading: Enabled
...
```

- 1** This line is added to set the **credentialsMode** parameter to **Manual**.

3. Generate the manifests by running the following command from the directory that contains the installation program:

```
$ openshift-install create manifests --dir <installation_directory>
```

where **<installation\_directory>** is the directory in which the installation program creates files.

4. From the directory that contains the installation program, obtain details of the OpenShift Container Platform release image that your **openshift-install** binary is built to use by running the following command:

```
$ openshift-install version
```

### Example output

```
release image quay.io/openshift-release-dev/ocp-release:4.y.z-x86_64
```

5. Locate all **CredentialsRequest** objects in this release image that target the cloud you are deploying on by running the following command:

```
$ oc adm release extract quay.io/openshift-release-dev/ocp-release:4.y.z-x86_64 \
  --credentials-requests \
  --cloud=azure
```

This command creates a YAML file for each **CredentialsRequest** object.

### Sample CredentialsRequest object

```
apiVersion: cloudcredential.openshift.io/v1
kind: CredentialsRequest
metadata:
  name: <component-credentials-request>
  namespace: openshift-cloud-credential-operator
...
spec:
  providerSpec:
    apiVersion: cloudcredential.openshift.io/v1
    kind: AzureProviderSpec
```

```

roleBindings:
- role: Contributor
...

```

6. Create YAML files for secrets in the **openshift-install** manifests directory that you generated previously. The secrets must be stored using the namespace and secret name defined in the **spec.secretRef** for each **CredentialsRequest** object.

### Sample CredentialsRequest object with secrets

```

apiVersion: cloudcredential.openshift.io/v1
kind: CredentialsRequest
metadata:
  name: <component-credentials-request>
  namespace: openshift-cloud-credential-operator
...
spec:
  providerSpec:
    apiVersion: cloudcredential.openshift.io/v1
    kind: AzureProviderSpec
    roleBindings:
      - role: Contributor
      ...
    secretRef:
      name: <component-secret>
      namespace: <component-namespace>
    ...

```

### Sample Secret object

```

apiVersion: v1
kind: Secret
metadata:
  name: <component-secret>
  namespace: <component-namespace>
data:
  azure_subscription_id: <base64_encoded_azure_subscription_id>
  azure_client_id: <base64_encoded_azure_client_id>
  azure_client_secret: <base64_encoded_azure_client_secret>
  azure_tenant_id: <base64_encoded_azure_tenant_id>
  azure_resource_prefix: <base64_encoded_azure_resource_prefix>
  azure_resourcegroup: <base64_encoded_azure_resourcegroup>
  azure_region: <base64_encoded_azure_region>

```



## IMPORTANT

The release image includes **CredentialsRequest** objects for Technology Preview features that are enabled by the **TechPreviewNoUpgrade** feature set. You can identify these objects by their use of the **release.openshift.io/feature-gate: TechPreviewNoUpgrade** annotation.

- If you are not using any of these features, do not create secrets for these objects. Creating secrets for Technology Preview features that you are not using can cause the installation to fail.
- If you are using any of these features, you must create secrets for the corresponding objects.

- To find **CredentialsRequest** objects with the **TechPreviewNoUpgrade** annotation, run the following command:

```
$ grep "release.openshift.io/feature-gate" *
```

### Example output

```
0000_30_capi-operator_00_credentials-request.yaml: release.openshift.io/feature-gate:
TechPreviewNoUpgrade
```

7. From the directory that contains the installation program, proceed with your cluster creation:

```
$ openshift-install create cluster --dir <installation_directory>
```

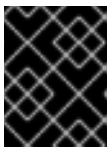

## IMPORTANT

Before upgrading a cluster that uses manually maintained credentials, you must ensure that the CCO is in an upgradeable state.

### Additional resources

- [Updating a cluster using the web console](#)
- [Updating a cluster using the CLI](#)

### 6.3.3. Next steps

- Install an OpenShift Container Platform cluster:
  - [Installing a cluster quickly on Azure](#) with default options on installer-provisioned infrastructure
  - [Install a cluster with cloud customizations on installer-provisioned infrastructure](#)
  - [Install a cluster with network customizations on installer-provisioned infrastructure](#)

## 6.4. INSTALLING A CLUSTER QUICKLY ON AZURE

In OpenShift Container Platform version 4.10, you can install a cluster on Microsoft Azure that uses the default configuration options.

### 6.4.1. Prerequisites

- You reviewed details about the [OpenShift Container Platform installation and update](#) processes.
- You read the documentation on [selecting a cluster installation method and preparing it for users](#).
- You [configured an Azure account](#) to host the cluster and determined the tested and validated region to deploy the cluster to.
- If you use a firewall, you [configured it to allow the sites](#) that your cluster requires access to.
- If the cloud identity and access management (IAM) APIs are not accessible in your environment, or if you do not want to store an administrator-level credential secret in the **kube-system** namespace, you can [manually create and maintain IAM credentials](#).

### 6.4.2. Internet access for OpenShift Container Platform

In OpenShift Container Platform 4.10, you require access to the internet to install your cluster.

You must have internet access to:

- Access [OpenShift Cluster Manager](#) to download the installation program and perform subscription management. If the cluster has internet access and you do not disable Telemetry, that service automatically entitles your cluster.
- Access [Quay.io](#) to obtain the packages that are required to install your cluster.
- Obtain the packages that are required to perform cluster updates.

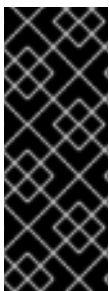

#### IMPORTANT

If your cluster cannot have direct internet access, you can perform a restricted network installation on some types of infrastructure that you provision. During that process, you download the required content and use it to populate a mirror registry with the installation packages. With some installation types, the environment that you install your cluster in will not require internet access. Before you update the cluster, you update the content of the mirror registry.

### 6.4.3. Generating a key pair for cluster node SSH access

During an OpenShift Container Platform installation, you can provide an SSH public key to the installation program. The key is passed to the Red Hat Enterprise Linux CoreOS (RHCOS) nodes through their Ignition config files and is used to authenticate SSH access to the nodes. The key is added to the `~/.ssh/authorized_keys` list for the **core** user on each node, which enables password-less authentication.

After the key is passed to the nodes, you can use the key pair to SSH in to the RHCOS nodes as the user **core**. To access the nodes through SSH, the private key identity must be managed by SSH for your local user.



If you want to SSH in to your cluster nodes to perform installation debugging or disaster recovery, you must provide the SSH public key during the installation process. The `./openshift-install gather` command also requires the SSH public key to be in place on the cluster nodes.



### IMPORTANT

Do not skip this procedure in production environments, where disaster recovery and debugging is required.



### NOTE

You must use a local key, not one that you configured with platform-specific approaches such as [AWS key pairs](#).

## Procedure

1. If you do not have an existing SSH key pair on your local machine to use for authentication onto your cluster nodes, create one. For example, on a computer that uses a Linux operating system, run the following command:

```
$ ssh-keygen -t ed25519 -N "" -f <path>/<file_name> 1
```

- 1 Specify the path and file name, such as `~/.ssh/id_ed25519`, of the new SSH key. If you have an existing key pair, ensure your public key is in the your `~/.ssh` directory.



### NOTE

If you plan to install an OpenShift Container Platform cluster that uses FIPS validated or Modules In Process cryptographic libraries on the **x86\_64** architecture, do not create a key that uses the **ed25519** algorithm. Instead, create a key that uses the **rsa** or **ecdsa** algorithm.

2. View the public SSH key:

```
$ cat <path>/<file_name>.pub
```

For example, run the following to view the `~/.ssh/id_ed25519.pub` public key:

```
$ cat ~/.ssh/id_ed25519.pub
```

3. Add the SSH private key identity to the SSH agent for your local user, if it has not already been added. SSH agent management of the key is required for password-less SSH authentication onto your cluster nodes, or if you want to use the `./openshift-install gather` command.



### NOTE

On some distributions, default SSH private key identities such as `~/.ssh/id_rsa` and `~/.ssh/id_dsa` are managed automatically.

- a. If the **ssh-agent** process is not already running for your local user, start it as a background task:

■

```
$ eval "$(ssh-agent -s)"
```

### Example output

```
Agent pid 31874
```



### NOTE

If your cluster is in FIPS mode, only use FIPS-compliant algorithms to generate the SSH key. The key must be either RSA or ECDSA.

4. Add your SSH private key to the **ssh-agent**:

```
$ ssh-add <path>/<file_name> 1
```

- 1** Specify the path and file name for your SSH private key, such as `~/.ssh/id_ed25519`

### Example output

```
Identity added: /home/<you>/<path>/<file_name> (<computer_name>)
```

### Next steps

- When you install OpenShift Container Platform, provide the SSH public key to the installation program.

## 6.4.4. Obtaining the installation program

Before you install OpenShift Container Platform, download the installation file on a local computer.

### Prerequisites

- You have a computer that runs Linux or macOS, with 500 MB of local disk space

### Procedure

1. Access the [Infrastructure Provider](#) page on the OpenShift Cluster Manager site. If you have a Red Hat account, log in with your credentials. If you do not, create an account.
2. Select your infrastructure provider.
3. Navigate to the page for your installation type, download the installation program that corresponds with your host operating system and architecture, and place the file in the directory where you will store the installation configuration files.

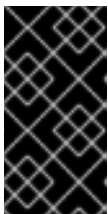

### IMPORTANT

The installation program creates several files on the computer that you use to install your cluster. You must keep the installation program and the files that the installation program creates after you finish installing the cluster. Both files are required to delete the cluster.



## IMPORTANT

Deleting the files created by the installation program does not remove your cluster, even if the cluster failed during installation. To remove your cluster, complete the OpenShift Container Platform uninstallation procedures for your specific cloud provider.

4. Extract the installation program. For example, on a computer that uses a Linux operating system, run the following command:

```
$ tar -xvf openshift-install-linux.tar.gz
```

5. Download your installation [pull secret from the Red Hat OpenShift Cluster Manager](#). This pull secret allows you to authenticate with the services that are provided by the included authorities, including Quay.io, which serves the container images for OpenShift Container Platform components.

### 6.4.5. Deploying the cluster

You can install OpenShift Container Platform on a compatible cloud platform.

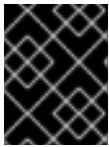

## IMPORTANT

You can run the **create cluster** command of the installation program only once, during initial installation.

### Prerequisites

- Configure an account with the cloud platform that hosts your cluster.
- Obtain the OpenShift Container Platform installation program and the pull secret for your cluster.

### Procedure

1. Change to the directory that contains the installation program and initialize the cluster deployment:

```
$ ./openshift-install create cluster --dir <installation_directory> \ 1  
--log-level=info 2
```

- 1** For **<installation\_directory>**, specify the directory name to store the files that the installation program creates.

- 2** To view different installation details, specify **warn**, **debug**, or **error** instead of **info**.

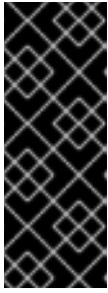

## IMPORTANT

Specify an empty directory. Some installation assets, like bootstrap X.509 certificates have short expiration intervals, so you must not reuse an installation directory. If you want to reuse individual files from another cluster installation, you can copy them into your directory. However, the file names for the installation assets might change between releases. Use caution when copying installation files from an earlier OpenShift Container Platform version.

Provide values at the prompts:

- a. Optional: Select an SSH key to use to access your cluster machines.



## NOTE

For production OpenShift Container Platform clusters on which you want to perform installation debugging or disaster recovery, specify an SSH key that your **ssh-agent** process uses.

- b. Select **azure** as the platform to target.
- c. If the installation program cannot locate the **osServicePrincipal.json** configuration file, which contains Microsoft Azure profile information, in the **~/.azure/** directory on your computer, the installer prompts you to specify the following Azure parameter values for your subscription and service principal.
  - **azure subscription id** The subscription ID to use for the cluster. Specify the **id** value in your account output.
  - **azure tenant id** The tenant ID. Specify the **tenantid** value in your account output.
  - **azure service principal client id** The value of the **appid** parameter for the service principal.
  - **azure service principal client secret** The value of the **password** parameter for the service principal.



## IMPORTANT

After you enter values for the previously listed parameters, the installation program creates a **osServicePrincipal.json** configuration file and stores this file in the **~/.azure/** directory on your computer. These actions ensure that the installation program can load the profile when it is creating an OpenShift Container Platform cluster on the target platform.

- d. Select the region to deploy the cluster to.
- e. Select the base domain to deploy the cluster to. The base domain corresponds to the Azure DNS Zone that you created for your cluster.
- f. Enter a descriptive name for your cluster.



### IMPORTANT

All Azure resources that are available through public endpoints are subject to resource name restrictions, and you cannot create resources that use certain terms. For a list of terms that Azure restricts, see [Resolve reserved resource name errors](#) in the Azure documentation.

- g. Paste the [pull secret from the Red Hat OpenShift Cluster Manager](#) .



### NOTE

If the cloud provider account that you configured on your host does not have sufficient permissions to deploy the cluster, the installation process stops, and the missing permissions are displayed.

When the cluster deployment completes, directions for accessing your cluster, including a link to its web console and credentials for the **kubeadmin** user, display in your terminal.

### Example output

```
...
INFO Install complete!
INFO To access the cluster as the system:admin user when using 'oc', run 'export
KUBECONFIG=/home/myuser/install_dir/auth/kubeconfig'
INFO Access the OpenShift web-console here: https://console-openshift-
console.apps.mycluster.example.com
INFO Login to the console with user: "kubeadmin", and password: "4vYBz-Ee6gm-ymBZj-
Wt5AL"
INFO Time elapsed: 36m22s
```



### NOTE

The cluster access and credential information also outputs to **<installation\_directory>/openshift\_install.log** when an installation succeeds.



### IMPORTANT

- The Ignition config files that the installation program generates contain certificates that expire after 24 hours, which are then renewed at that time. If the cluster is shut down before renewing the certificates and the cluster is later restarted after the 24 hours have elapsed, the cluster automatically recovers the expired certificates. The exception is that you must manually approve the pending **node-bootstrapper** certificate signing requests (CSRs) to recover kubelet certificates. See the documentation for *Recovering from expired control plane certificates* for more information.
- It is recommended that you use Ignition config files within 12 hours after they are generated because the 24-hour certificate rotates from 16 to 22 hours after the cluster is installed. By using the Ignition config files within 12 hours, you can avoid installation failure if the certificate update runs during installation.

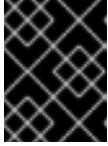
**IMPORTANT**

You must not delete the installation program or the files that the installation program creates. Both are required to delete the cluster.

### 6.4.6. Installing the OpenShift CLI by downloading the binary

You can install the OpenShift CLI (**oc**) to interact with OpenShift Container Platform from a command-line interface. You can install **oc** on Linux, Windows, or macOS.

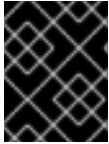
**IMPORTANT**

If you installed an earlier version of **oc**, you cannot use it to complete all of the commands in OpenShift Container Platform 4.10. Download and install the new version of **oc**.

#### Installing the OpenShift CLI on Linux

You can install the OpenShift CLI (**oc**) binary on Linux by using the following procedure.

##### Procedure

1. Navigate to the [OpenShift Container Platform downloads page](#) on the Red Hat Customer Portal.
2. Select the appropriate version in the **Version** drop-down menu.
3. Click **Download Now** next to the **OpenShift v4.10 Linux Client** entry and save the file.
4. Unpack the archive:

```
$ tar xvf <file>
```

5. Place the **oc** binary in a directory that is on your **PATH**.  
To check your **PATH**, execute the following command:

```
$ echo $PATH
```

After you install the OpenShift CLI, it is available using the **oc** command:

```
$ oc <command>
```

#### Installing the OpenShift CLI on Windows

You can install the OpenShift CLI (**oc**) binary on Windows by using the following procedure.

##### Procedure

1. Navigate to the [OpenShift Container Platform downloads page](#) on the Red Hat Customer Portal.
2. Select the appropriate version in the **Version** drop-down menu.
3. Click **Download Now** next to the **OpenShift v4.10 Windows Client** entry and save the file.
4. Unzip the archive with a ZIP program.

5. Move the **oc** binary to a directory that is on your **PATH**.  
To check your **PATH**, open the command prompt and execute the following command:

```
C:\> path
```

After you install the OpenShift CLI, it is available using the **oc** command:

```
C:\> oc <command>
```

### Installing the OpenShift CLI on macOS

You can install the OpenShift CLI (**oc**) binary on macOS by using the following procedure.

#### Procedure

1. Navigate to the [OpenShift Container Platform downloads page](#) on the Red Hat Customer Portal.
2. Select the appropriate version in the **Version** drop-down menu.
3. Click **Download Now** next to the **OpenShift v4.10 MacOSX Client** entry and save the file.
4. Unpack and unzip the archive.
5. Move the **oc** binary to a directory on your PATH.  
To check your **PATH**, open a terminal and execute the following command:

```
$ echo $PATH
```

After you install the OpenShift CLI, it is available using the **oc** command:

```
$ oc <command>
```

### 6.4.7. Logging in to the cluster by using the CLI

You can log in to your cluster as a default system user by exporting the cluster **kubeconfig** file. The **kubeconfig** file contains information about the cluster that is used by the CLI to connect a client to the correct cluster and API server. The file is specific to a cluster and is created during OpenShift Container Platform installation.

#### Prerequisites

- You deployed an OpenShift Container Platform cluster.
- You installed the **oc** CLI.

#### Procedure

1. Export the **kubeadmin** credentials:

```
$ export KUBECONFIG=<installation_directory>/auth/kubeconfig 1
```

- 1** For **<installation\_directory>**, specify the path to the directory that you stored the installation files in.

2. Verify you can run **oc** commands successfully using the exported configuration:

```
$ oc whoami
```

#### Example output

```
system:admin
```

#### Additional resources

- See [Accessing the web console](#) for more details about accessing and understanding the OpenShift Container Platform web console.

### 6.4.8. Telemetry access for OpenShift Container Platform

In OpenShift Container Platform 4.10, the Telemetry service, which runs by default to provide metrics about cluster health and the success of updates, requires internet access. If your cluster is connected to the internet, Telemetry runs automatically, and your cluster is registered to [OpenShift Cluster Manager](#).

After you confirm that your [OpenShift Cluster Manager](#) inventory is correct, either maintained automatically by Telemetry or manually by using OpenShift Cluster Manager, [use subscription watch](#) to track your OpenShift Container Platform subscriptions at the account or multi-cluster level.

#### Additional resources

- See [About remote health monitoring](#) for more information about the Telemetry service

### 6.4.9. Next steps

- [Customize your cluster](#).
- If necessary, you can [opt out of remote health reporting](#).

## 6.5. INSTALLING A CLUSTER ON AZURE WITH CUSTOMIZATIONS

In OpenShift Container Platform version 4.10, you can install a customized cluster on infrastructure that the installation program provisions on Microsoft Azure. To customize the installation, you modify parameters in the **install-config.yaml** file before you install the cluster.

### 6.5.1. Prerequisites

- You reviewed details about the [OpenShift Container Platform installation and update](#) processes.
- You read the documentation on [selecting a cluster installation method and preparing it for users](#).
- You [configured an Azure account](#) to host the cluster and determined the tested and validated region to deploy the cluster to.
- If you use a firewall, you [configured it to allow the sites](#) that your cluster requires access to.



- If the cloud identity and access management (IAM) APIs are not accessible in your environment, or if you do not want to store an administrator-level credential secret in the **kube-system** namespace, you can [manually create and maintain IAM credentials](#).

### 6.5.2. Internet access for OpenShift Container Platform

In OpenShift Container Platform 4.10, you require access to the internet to install your cluster.

You must have internet access to:

- Access [OpenShift Cluster Manager](#) to download the installation program and perform subscription management. If the cluster has internet access and you do not disable Telemetry, that service automatically entitles your cluster.
- Access [Quay.io](#) to obtain the packages that are required to install your cluster.
- Obtain the packages that are required to perform cluster updates.



#### IMPORTANT

If your cluster cannot have direct internet access, you can perform a restricted network installation on some types of infrastructure that you provision. During that process, you download the required content and use it to populate a mirror registry with the installation packages. With some installation types, the environment that you install your cluster in will not require internet access. Before you update the cluster, you update the content of the mirror registry.

### 6.5.3. Generating a key pair for cluster node SSH access

During an OpenShift Container Platform installation, you can provide an SSH public key to the installation program. The key is passed to the Red Hat Enterprise Linux CoreOS (RHCOS) nodes through their Ignition config files and is used to authenticate SSH access to the nodes. The key is added to the `~/.ssh/authorized_keys` list for the **core** user on each node, which enables password-less authentication.

After the key is passed to the nodes, you can use the key pair to SSH in to the RHCOS nodes as the user **core**. To access the nodes through SSH, the private key identity must be managed by SSH for your local user.

If you want to SSH in to your cluster nodes to perform installation debugging or disaster recovery, you must provide the SSH public key during the installation process. The `./openshift-install gather` command also requires the SSH public key to be in place on the cluster nodes.

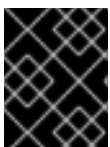

#### IMPORTANT

Do not skip this procedure in production environments, where disaster recovery and debugging is required.



#### NOTE

You must use a local key, not one that you configured with platform-specific approaches such as [AWS key pairs](#).

#### Procedure

1. If you do not have an existing SSH key pair on your local machine to use for authentication onto your cluster nodes, create one. For example, on a computer that uses a Linux operating system, run the following command:

```
$ ssh-keygen -t ed25519 -N "" -f <path>/<file_name> 1
```

- 1 Specify the path and file name, such as `~/.ssh/id_ed25519`, of the new SSH key. If you have an existing key pair, ensure your public key is in the your `~/.ssh` directory.



#### NOTE

If you plan to install an OpenShift Container Platform cluster that uses FIPS validated or Modules In Process cryptographic libraries on the **x86\_64** architecture, do not create a key that uses the **ed25519** algorithm. Instead, create a key that uses the **rsa** or **ecdsa** algorithm.

2. View the public SSH key:

```
$ cat <path>/<file_name>.pub
```

For example, run the following to view the `~/.ssh/id_ed25519.pub` public key:

```
$ cat ~/.ssh/id_ed25519.pub
```

3. Add the SSH private key identity to the SSH agent for your local user, if it has not already been added. SSH agent management of the key is required for password-less SSH authentication onto your cluster nodes, or if you want to use the `./openshift-install gather` command.



#### NOTE

On some distributions, default SSH private key identities such as `~/.ssh/id_rsa` and `~/.ssh/id_dsa` are managed automatically.

- a. If the **ssh-agent** process is not already running for your local user, start it as a background task:

```
$ eval "$(ssh-agent -s)"
```

#### Example output

```
Agent pid 31874
```



#### NOTE

If your cluster is in FIPS mode, only use FIPS-compliant algorithms to generate the SSH key. The key must be either RSA or ECDSA.

4. Add your SSH private key to the **ssh-agent**:

```
$ ssh-add <path>/<file_name> 1
```

- 1 Specify the path and file name for your SSH private key, such as `~/.ssh/id_ed25519`

### Example output

```
Identity added: /home/<you>/<path>/<file_name> (<computer_name>)
```

### Next steps

- When you install OpenShift Container Platform, provide the SSH public key to the installation program.

## 6.5.4. Selecting an Azure Marketplace image

If you are deploying an OpenShift Container Platform cluster using the Azure Marketplace offering, you must first obtain the Azure Marketplace image. The installation program uses this image to deploy worker nodes. When obtaining your image, consider the following:

- While the images are the same, the Azure Marketplace publisher is different depending on your region. If you are located in North America, specify **redhat** as the publisher. If you are located in EMEA, specify **redhat-limited** as the publisher.
- The offer includes a **rh-ocp-worker** SKU and a **rh-ocp-worker-gen1** SKU. The **rh-ocp-worker** SKU represents a Hyper-V generation version 2 VM image. The default instance types used in OpenShift Container Platform are version 2 compatible. If you are going to use an instance type that is only version 1 compatible, use the image associated with the **rh-ocp-worker-gen1** SKU. The **rh-ocp-worker-gen1** SKU represents a Hyper-V version 1 VM image.

### Prerequisites

- You have installed the Azure CLI client (**az**).
- Your Azure account is entitled for the offer and you have logged into this account with the Azure CLI client.

### Procedure

1. Display all of the available OpenShift Container Platform images by running one of the following commands:

- North America:

```
$ az vm image list --all --offer rh-ocp-worker --publisher redhat -o table
```

### Example output

Offer	Publisher	Sku	Urn	Version
rh-ocp-worker-ocpworker:4.8.2021122100	RedHat	rh-ocp-worker	RedHat:rh-ocp-worker:rh-ocp-worker:4.8.2021122100	
rh-ocp-worker-gen1:4.8.2021122100	RedHat	rh-ocp-worker-gen1	RedHat:rh-ocp-worker:rh-ocp-worker-gen1:4.8.2021122100	

- EMEA:

```
$ az vm image list --all --offer rh-ocp-worker --publisher redhat-limited -o table
```

### Example output

Offer	Publisher	Sku	Urn	Version
rh-ocp-worker	redhat-limited	rh-ocp-worker	redhat-limited:rh-ocp-worker:rh-ocp-worker:4.8.2021122100	4.8.2021122100
rh-ocp-worker-gen1	redhat-limited	rh-ocp-worker-gen1	redhat-limited:rh-ocp-worker:rh-ocp-worker-gen1:4.8.2021122100	4.8.2021122100



### NOTE

Regardless of the version of OpenShift Container Platform you are installing, the correct version of the Azure Marketplace image to use is 4.8.x. If required, as part of the installation process, your VMs are automatically upgraded.

2. Inspect the image for your offer by running one of the following commands:

- North America:

```
$ az vm image show --urn redhat:rh-ocp-worker:rh-ocp-worker:<version>
```

- EMEA:

```
$ az vm image show --urn redhat-limited:rh-ocp-worker:rh-ocp-worker:<version>
```

3. Review the terms of the offer by running one of the following commands:

- North America:

```
$ az vm image terms show --urn redhat:rh-ocp-worker:rh-ocp-worker:<version>
```

- EMEA:

```
$ az vm image terms show --urn redhat-limited:rh-ocp-worker:rh-ocp-worker:<version>
```

4. Accept the terms of the offering by running one of the following commands:

- North America:

```
$ az vm image terms accept --urn redhat:rh-ocp-worker:rh-ocp-worker:<version>
```

- EMEA:

```
$ az vm image terms accept --urn redhat-limited:rh-ocp-worker:rh-ocp-worker:<version>
```

- Record the image details of your offer. You must update the **99\_openshift-cluster-api\_worker-machineset-[0-2].yaml** files in the section titled "Updating Manifests for Marketplace Installation" before completing the installation.

### 6.5.5. Obtaining the installation program

Before you install OpenShift Container Platform, download the installation file on a local computer.

#### Prerequisites

- You have a computer that runs Linux or macOS, with 500 MB of local disk space

#### Procedure

- Access the [Infrastructure Provider](#) page on the OpenShift Cluster Manager site. If you have a Red Hat account, log in with your credentials. If you do not, create an account.
- Select your infrastructure provider.
- Navigate to the page for your installation type, download the installation program that corresponds with your host operating system and architecture, and place the file in the directory where you will store the installation configuration files.

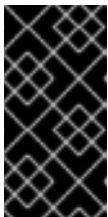

#### IMPORTANT

The installation program creates several files on the computer that you use to install your cluster. You must keep the installation program and the files that the installation program creates after you finish installing the cluster. Both files are required to delete the cluster.



#### IMPORTANT

Deleting the files created by the installation program does not remove your cluster, even if the cluster failed during installation. To remove your cluster, complete the OpenShift Container Platform uninstallation procedures for your specific cloud provider.

- Extract the installation program. For example, on a computer that uses a Linux operating system, run the following command:

```
$ tar -xvf openshift-install-linux.tar.gz
```

- Download your installation [pull secret from the Red Hat OpenShift Cluster Manager](#) . This pull secret allows you to authenticate with the services that are provided by the included authorities, including Quay.io, which serves the container images for OpenShift Container Platform components.

### 6.5.6. Creating the installation configuration file

You can customize the OpenShift Container Platform cluster you install on Microsoft Azure.

#### Prerequisites

- Obtain the OpenShift Container Platform installation program and the pull secret for your cluster.
- Obtain service principal permissions at the subscription level.

## Procedure

1. Create the **install-config.yaml** file.
  - a. Change to the directory that contains the installation program and run the following command:

```
$ ./openshift-install create install-config --dir <installation_directory> 1
```

- 1** For **<installation\_directory>**, specify the directory name to store the files that the installation program creates.



### IMPORTANT

Specify an empty directory. Some installation assets, like bootstrap X.509 certificates have short expiration intervals, so you must not reuse an installation directory. If you want to reuse individual files from another cluster installation, you can copy them into your directory. However, the file names for the installation assets might change between releases. Use caution when copying installation files from an earlier OpenShift Container Platform version.

- b. At the prompts, provide the configuration details for your cloud:
  - i. Optional: Select an SSH key to use to access your cluster machines.



### NOTE

For production OpenShift Container Platform clusters on which you want to perform installation debugging or disaster recovery, specify an SSH key that your **ssh-agent** process uses.

- ii. Select **azure** as the platform to target.
- iii. If you do not have a Microsoft Azure profile stored on your computer, specify the following Azure parameter values for your subscription and service principal:
  - **azure subscription id** The subscription ID to use for the cluster. Specify the **id** value in your account output.
  - **azure tenant id** The tenant ID. Specify the **tenantId** value in your account output.
  - **azure service principal client id** The value of the **appId** parameter for the service principal.
  - **azure service principal client secret** The value of the **password** parameter for the service principal.
- iv. Select the region to deploy the cluster to.

- v. Select the base domain to deploy the cluster to. The base domain corresponds to the Azure DNS Zone that you created for your cluster.
- vi. Enter a descriptive name for your cluster.



### IMPORTANT

All Azure resources that are available through public endpoints are subject to resource name restrictions, and you cannot create resources that use certain terms. For a list of terms that Azure restricts, see [Resolve reserved resource name errors](#) in the Azure documentation.

- vii. Paste the [pull secret from the Red Hat OpenShift Cluster Manager](#) .
2. Modify the **install-config.yaml** file. You can find more information about the available parameters in the "Installation configuration parameters" section.
  3. Back up the **install-config.yaml** file so that you can use it to install multiple clusters.



### IMPORTANT

The **install-config.yaml** file is consumed during the installation process. If you want to reuse the file, you must back it up now.

#### 6.5.6.1. Installation configuration parameters

Before you deploy an OpenShift Container Platform cluster, you provide parameter values to describe your account on the cloud platform that hosts your cluster and optionally customize your cluster's platform. When you create the **install-config.yaml** installation configuration file, you provide values for the required parameters through the command line. If you customize your cluster, you can modify the **install-config.yaml** file to provide more details about the platform.



### NOTE

After installation, you cannot modify these parameters in the **install-config.yaml** file.

##### 6.5.6.1.1. Required configuration parameters

Required installation configuration parameters are described in the following table:

**Table 6.1. Required parameters**

Parameter	Description	Values
<b>apiVersion</b>	The API version for the <b>install-config.yaml</b> content. The current version is <b>v1</b> . The installer may also support older API versions.	String

Parameter	Description	Values
<b>baseDomain</b>	The base domain of your cloud provider. The base domain is used to create routes to your OpenShift Container Platform cluster components. The full DNS name for your cluster is a combination of the <b>baseDomain</b> and <b>metadata.name</b> parameter values that uses the <b>&lt;metadata.name&gt;.&lt;baseDomain&gt;</b> format.	A fully-qualified domain or subdomain name, such as <b>example.com</b> .
<b>metadata</b>	Kubernetes resource <b>ObjectMeta</b> , from which only the <b>name</b> parameter is consumed.	Object
<b>metadata.name</b>	The name of the cluster. DNS records for the cluster are all subdomains of <b>{{.metadata.name}}</b> . <b>{{.baseDomain}}</b> .	String of lowercase letters, hyphens (-), and periods (.), such as <b>dev</b> .
<b>platform</b>	The configuration for the specific platform upon which to perform the installation: <b>alibabacloud</b> , <b>aws</b> , <b>baremetal</b> , <b>azure</b> , <b>gcp</b> , <b>ibmcloud</b> , <b>openstack</b> , <b>ovirt</b> , <b>vsphere</b> , or <b>{}</b> . For additional information about <b>platform.&lt;platform&gt;</b> parameters, consult the table for your specific platform that follows.	Object
<b>pullSecret</b>	Get a <a href="#">pull secret from the Red Hat OpenShift Cluster Manager</a> to authenticate downloading container images for OpenShift Container Platform components from services such as Quay.io.	<pre>{   "auths":{     "cloud.openshift.com":{       "auth":"b3Blb=",       "email":"you@example.com"     },     "quay.io":{       "auth":"b3Blb=",       "email":"you@example.com"     }   } }</pre>



Parameter	Description	Values
-----------	-------------	--------

### 6.5.6.1.2. Network configuration parameters

You can customize your installation configuration based on the requirements of your existing network infrastructure. For example, you can expand the IP address block for the cluster network or provide different IP address blocks than the defaults.

Only IPv4 addresses are supported.

Table 6.2. Network parameters

Parameter	Description	Values
<b>networking</b>	The configuration for the cluster network.	Object  <b>NOTE</b> You cannot modify parameters specified by the <b>networking</b> object after installation.
<b>networking.network Type</b>	The cluster network provider Container Network Interface (CNI) plugin to install.	Either <b>OpenShiftSDN</b> or <b>OVNKubernetes</b> . <b>OpenShiftSDN</b> is a CNI provider for all-Linux networks. <b>OVNKubernetes</b> is a CNI provider for Linux networks and hybrid networks that contain both Linux and Windows servers. The default value is <b>OpenShiftSDN</b> .

Parameter	Description	Values
<b>networking.clusterNetwork</b>	<p>The IP address blocks for pods.</p> <p>The default value is <b>10.128.0.0/14</b> with a host prefix of <b>/23</b>.</p> <p>If you specify multiple IP address blocks, the blocks must not overlap.</p>	<p>An array of objects. For example:</p> <pre>networking:   clusterNetwork:     - cidr: 10.128.0.0/14       hostPrefix: 23</pre>
<b>networking.clusterNetwork.cidr</b>	<p>Required if you use <b>networking.clusterNetwork</b>. An IP address block.</p> <p>An IPv4 network.</p>	<p>An IP address block in Classless Inter-Domain Routing (CIDR) notation. The prefix length for an IPv4 block is between <b>0</b> and <b>32</b>.</p>
<b>networking.clusterNetwork.hostPrefix</b>	<p>The subnet prefix length to assign to each individual node. For example, if <b>hostPrefix</b> is set to <b>23</b> then each node is assigned a <b>/23</b> subnet out of the given <b>cidr</b>. A <b>hostPrefix</b> value of <b>23</b> provides 510 (<math>2^{(32 - 23)} - 2</math>) pod IP addresses.</p>	<p>A subnet prefix.</p> <p>The default value is <b>23</b>.</p>
<b>networking.serviceNetwork</b>	<p>The IP address block for services. The default value is <b>172.30.0.0/16</b>.</p> <p>The OpenShift SDN and OVN-Kubernetes network providers support only a single IP address block for the service network.</p>	<p>An array with an IP address block in CIDR format. For example:</p> <pre>networking:   serviceNetwork:     - 172.30.0.0/16</pre>
<b>networking.machineNetwork</b>	<p>The IP address blocks for machines.</p> <p>If you specify multiple IP address blocks, the blocks must not overlap.</p>	<p>An array of objects. For example:</p> <pre>networking:   machineNetwork:     - cidr: 10.0.0.0/16</pre>
<b>networking.machineNetwork.cidr</b>	<p>Required if you use <b>networking.machineNetwork</b>. An IP address block. The default value is <b>10.0.0.0/16</b> for all platforms other than libvirt. For libvirt, the default value is <b>192.168.126.0/24</b>.</p>	<p>An IP network block in CIDR notation.</p> <p>For example, <b>10.0.0.0/16</b>.</p> <div style="display: flex; align-items: flex-start;">  <div> <p><b>NOTE</b></p> <p>Set the <b>networking.machineNetwork</b> to match the CIDR that the preferred NIC resides in.</p> </div> </div>



## 6.5.6.1.3. Optional configuration parameters

Optional installation configuration parameters are described in the following table:

Table 6.3. Optional parameters

Parameter	Description	Values
<b>additionalTrustBundle</b>	A PEM-encoded X.509 certificate bundle that is added to the nodes' trusted certificate store. This trust bundle may also be used when a proxy has been configured.	String
<b>cgroupsV2</b>	Enables <a href="#">Linux control groups version 2</a> (cgroups v2) on specific nodes in your cluster. The OpenShift Container Platform process for enabling cgroups v2 disables all cgroup version 1 controllers and hierarchies. The OpenShift Container Platform cgroups version 2 feature is in Developer Preview and is not supported by Red Hat at this time.	<b>true</b>
<b>compute</b>	The configuration for the machines that comprise the compute nodes.	Array of <b>MachinePool</b> objects.
<b>compute.architecture</b>	Determines the instruction set architecture of the machines in the pool. Currently, clusters with varied architectures are not supported. All pools must specify the same architecture. Valid values are <b>amd64</b> (the default).	String
<b>compute.hyperthreading</b>	Whether to enable or disable simultaneous multithreading, or <b>hyperthreading</b> , on compute machines. By default, simultaneous multithreading is enabled to increase the performance of your machines' cores.	<b>Enabled</b> or <b>Disabled</b>
	 <p><b>IMPORTANT</b></p> <p>If you disable simultaneous multithreading, ensure that your capacity planning accounts for the dramatically decreased machine performance.</p>	

Parameter	Description	Values
<b>compute.name</b>	Required if you use <b>compute</b> . The name of the machine pool.	<b>worker</b>
<b>compute.platform</b>	Required if you use <b>compute</b> . Use this parameter to specify the cloud provider to host the worker machines. This parameter value must match the <b>controlPlane.platform</b> parameter value.	<b>alibabacloud, aws, azure, gcp, ibmcloud, openstack, ovirt, vsphere</b> , or <b>{}</b>
<b>compute.replicas</b>	The number of compute machines, which are also known as worker machines, to provision.	A positive integer greater than or equal to <b>2</b> . The default value is <b>3</b> .
<b>controlPlane</b>	The configuration for the machines that comprise the control plane.	Array of <b>MachinePool</b> objects.
<b>controlPlane.architecture</b>	Determines the instruction set architecture of the machines in the pool. Currently, clusters with varied architectures are not supported. All pools must specify the same architecture. Valid values are <b>amd64</b> (the default).	String
<b>controlPlane.hyperthreading</b>	<p>Whether to enable or disable simultaneous multithreading, or <b>hyperthreading</b>, on control plane machines. By default, simultaneous multithreading is enabled to increase the performance of your machines' cores.</p> <div style="display: flex; align-items: flex-start;"> <div style="background-color: black; width: 40px; height: 40px; margin-right: 10px;"></div> <div> <p><b>IMPORTANT</b></p> <p>If you disable simultaneous multithreading, ensure that your capacity planning accounts for the dramatically decreased machine performance.</p> </div> </div>	<b>Enabled</b> or <b>Disabled</b>
<b>controlPlane.name</b>	Required if you use <b>controlPlane</b> . The name of the machine pool.	<b>master</b>

Parameter	Description	Values
<b>controlPlane.platform</b>	Required if you use <b>controlPlane</b> . Use this parameter to specify the cloud provider that hosts the control plane machines. This parameter value must match the <b>compute.platform</b> parameter value.	<b>alibabacloud, aws, azure, gcp, ibmcloud, openstack, ovirt, vsphere</b> , or {}
<b>controlPlane.replicas</b>	The number of control plane machines to provision.	The only supported value is <b>3</b> , which is the default value.
<b>credentialsMode</b>	<p>The Cloud Credential Operator (CCO) mode. If no mode is specified, the CCO dynamically tries to determine the capabilities of the provided credentials, with a preference for mint mode on the platforms where multiple modes are supported.</p> <div style="display: flex; align-items: flex-start;"> <div style="flex: 1;">  </div> <div style="flex: 2;"> <p><b>NOTE</b></p> <p>Not all CCO modes are supported for all cloud providers. For more information on CCO modes, see the <i>Cloud Credential Operator</i> entry in the <i>Cluster Operators reference</i> content.</p> </div> </div> <div style="display: flex; align-items: flex-start; margin-top: 10px;"> <div style="flex: 1;">  </div> <div style="flex: 2;"> <p><b>NOTE</b></p> <p>If your AWS account has service control policies (SCP) enabled, you must configure the <b>credentialsMode</b> parameter to <b>Mint, Passthrough</b> or <b>Manual</b>.</p> </div> </div>	<b>Mint, Passthrough, Manual</b> or an empty string ("").

Parameter	Description	Values
<b>fips</b>	<p>Enable or disable FIPS mode. The default is <b>false</b> (disabled). If FIPS mode is enabled, the Red Hat Enterprise Linux CoreOS (RHCOS) machines that OpenShift Container Platform runs on bypass the default Kubernetes cryptography suite and use the cryptography modules that are provided with RHCOS instead.</p> <div data-bbox="486 584 592 1361" style="background-color: black; color: white; padding: 5px; margin-bottom: 10px;"> <p><b>IMPORTANT</b></p> <p>To enable FIPS mode for your cluster, you must run the installation program from a Red Hat Enterprise Linux (RHEL) computer configured to operate in FIPS mode. For more information about configuring FIPS mode on RHEL, see <a href="#">Installing the system in FIPS mode</a>. The use of FIPS validated or Modules In Process cryptographic libraries is only supported on OpenShift Container Platform deployments on the <b>x86_64</b> architecture.</p> </div> <div data-bbox="486 1406 592 1608" style="background-color: #f0f0f0; padding: 5px;"> <p><b>NOTE</b></p> <p>If you are using Azure File storage, you cannot enable FIPS mode.</p> </div>	<b>false</b> or <b>true</b>

Parameter	Description	Values
<b>imageContentSources</b>	Sources and repositories for the release-image content.	Array of objects. Includes a <b>source</b> and, optionally, <b>mirrors</b> , as described in the following rows of this table.
<b>imageContentSources.source</b>	Required if you use <b>imageContentSources</b> . Specify the repository that users refer to, for example, in image pull specifications.	String
<b>imageContentSources.mirrors</b>	Specify one or more repositories that may also contain the same images.	Array of strings
<b>publish</b>	How to publish or expose the user-facing endpoints of your cluster, such as the Kubernetes API, OpenShift routes.	<b>Internal</b> or <b>External</b> . To deploy a private cluster, which cannot be accessed from the internet, set <b>publish</b> to <b>Internal</b> . The default value is <b>External</b> .
<b>sshKey</b>	<p>The SSH key or keys to authenticate access your cluster machines.</p>  <p><b>NOTE</b></p> <p>For production OpenShift Container Platform clusters on which you want to perform installation debugging or disaster recovery, specify an SSH key that your <b>ssh-agent</b> process uses.</p>	<p>One or more keys. For example:</p> <pre>sshKey:   &lt;key1&gt;   &lt;key2&gt;   &lt;key3&gt;</pre>

#### 6.5.6.1.4. Additional Azure configuration parameters

Additional Azure configuration parameters are described in the following table.



#### NOTE

By default, if you specify availability zones in the **install-config.yaml** file, the installation program distributes the control plane machines and the compute machines across [these availability zones](#) within [a region](#). To ensure high availability for your cluster, select a region with at least three availability zones. If your region contains fewer than three availability zones, the installation program places more than one control plane machine in the available zones.

Table 6.4. Additional Azure parameters

Parameter	Description	Values
<b>compute.platform.azure.osDisk.diskSizeGB</b>	The Azure disk size for the VM.	Integer that represents the size of the disk in GB. The default is <b>128</b> .
<b>compute.platform.azure.osDisk.diskType</b>	Defines the type of disk.	<b>standard_LRS</b> , <b>premium_LRS</b> , or <b>standardSSD_LRS</b> . The default is <b>premium_LRS</b> .
<b>controlPlane.platform.azure.osDisk.diskSizeGB</b>	The Azure disk size for the VM.	Integer that represents the size of the disk in GB. The default is <b>1024</b> .
<b>controlPlane.platform.azure.osDisk.diskType</b>	Defines the type of disk.	<b>premium_LRS</b> or <b>standardSSD_LRS</b> . The default is <b>premium_LRS</b> .
<b>platform.azure.baseDomainResourceGroupName</b>	The name of the resource group that contains the DNS zone for your base domain.	String, for example <b>production_cluster</b> .
<b>platform.azure.resourceGroupName</b>	The name of an already existing resource group to install your cluster to. This resource group must be empty and only used for this specific cluster; the cluster components assume ownership of all resources in the resource group. If you limit the service principal scope of the installation program to this resource group, you must ensure all other resources used by the installation program in your environment have the necessary permissions, such as the public DNS zone and virtual network. Destroying the cluster by using the installation program deletes this resource group.	String, for example <b>existing_resource_group</b> .
<b>platform.azure.outboundType</b>	The outbound routing strategy used to connect your cluster to the internet. If you are using user-defined routing, you must have pre-existing networking available where the outbound routing has already been configured prior to installing a cluster. The installation program is not responsible for configuring user-defined routing.	<b>LoadBalancer</b> or <b>UserDefinedRouting</b> . The default is <b>LoadBalancer</b> .
<b>platform.azure.region</b>	The name of the Azure region that hosts your cluster.	Any valid region name, such as <b>centralus</b> .



Parameter	Description	Values
<b>platform.azure.zone</b>	List of availability zones to place machines in. For high availability, specify at least two zones.	List of zones, for example ["1", "2", "3"].
<b>platform.azure.networkResourceGroupName</b>	The name of the resource group that contains the existing VNet that you want to deploy your cluster to. This name cannot be the same as the <b>platform.azure.baseDomainResourceGroupName</b> .	String.
<b>platform.azure.virtualNetwork</b>	The name of the existing VNet that you want to deploy your cluster to.	String.
<b>platform.azure.controlPlaneSubnet</b>	The name of the existing subnet in your VNet that you want to deploy your control plane machines to.	Valid CIDR, for example <b>10.0.0.0/16</b> .
<b>platform.azure.computeSubnet</b>	The name of the existing subnet in your VNet that you want to deploy your compute machines to.	Valid CIDR, for example <b>10.0.0.0/16</b> .
<b>platform.azure.cloudName</b>	The name of the Azure cloud environment that is used to configure the Azure SDK with the appropriate Azure API endpoints. If empty, the default value <b>AzurePublicCloud</b> is used.	Any valid cloud environment, such as <b>AzurePublicCloud</b> or <b>AzureUSGovernmentCloud</b> .

**NOTE**

You cannot customize [Azure Availability Zones](#) or [Use tags to organize your Azure resources](#) with an Azure cluster.

### 6.5.6.2. Minimum resource requirements for cluster installation

Each cluster machine must meet the following minimum requirements:

**Table 6.5. Minimum resource requirements**

Machine	Operating System	vCPU [1]	Virtual RAM	Storage	IOPS [2]
Bootstrap	RHCOS	4	16 GB	100 GB	300
Control plane	RHCOS	4	16 GB	100 GB	300

Machine	Operating System	vCPU [1]	Virtual RAM	Storage	IOPS [2]
Compute	RHCOS, RHEL 8.4, or RHEL 8.5 <sup>[3]</sup>	2	8 GB	100 GB	300

1. One vCPU is equivalent to one physical core when simultaneous multithreading (SMT), or hyperthreading, is not enabled. When enabled, use the following formula to calculate the corresponding ratio: (threads per core × cores) × sockets = vCPUs.
2. OpenShift Container Platform and Kubernetes are sensitive to disk performance, and faster storage is recommended, particularly for etcd on the control plane nodes which require a 10 ms p99 fsync duration. Note that on many cloud platforms, storage size and IOPS scale together, so you might need to over-allocate storage volume to obtain sufficient performance.
3. As with all user-provisioned installations, if you choose to use RHEL compute machines in your cluster, you take responsibility for all operating system life cycle management and maintenance, including performing system updates, applying patches, and completing all other required tasks. Use of RHEL 7 compute machines is deprecated and has been removed in OpenShift Container Platform 4.10 and later.



### IMPORTANT

You are required to use Azure virtual machines with **premiumIO** set to **true**. The machines must also have the **hyperVGeneration** property contain **V1**.

If an instance type for your platform meets the minimum requirements for cluster machines, it is supported to use in OpenShift Container Platform.

#### 6.5.6.3. Tested instance types for Azure

The following Microsoft Azure instance types have been tested with OpenShift Container Platform.

##### Example 6.1. Machine types

- **c4.\***
- **c5.\***
- **c5a.\***
- **i3.\***
- **m4.\***
- **m5.\***
- **m5a.\***
- **m6i.\***

- r4.\*
- r5.\*
- r5a.\*
- r6i.\*
- t3.\*
- t3a.\*

#### 6.5.6.4. Sample customized install-config.yaml file for Azure

You can customize the **install-config.yaml** file to specify more details about your OpenShift Container Platform cluster's platform or modify the values of the required parameters.



#### IMPORTANT

This sample YAML file is provided for reference only. You must obtain your **install-config.yaml** file by using the installation program and modify it.

```

apiVersion: v1
baseDomain: example.com 1
controlPlane: 2
  hyperthreading: Enabled 3 4
  name: master
  platform:
    azure:
      osDisk:
        diskSizeGB: 1024 5
        diskType: Premium_LRS
        type: Standard_D8s_v3
      replicas: 3
compute: 6
- hyperthreading: Enabled 7
  name: worker
  platform:
    azure:
      type: Standard_D2s_v3
      osDisk:
        diskSizeGB: 512 8
        diskType: Standard_LRS
      zones: 9
      - "1"
      - "2"
      - "3"
    replicas: 5
metadata:
  name: test-cluster 10
networking:
  clusterNetwork:

```

```

- cidr: 10.128.0.0/14
  hostPrefix: 23
machineNetwork:
- cidr: 10.0.0.0/16
networkType: OpenShiftSDN
serviceNetwork:
- 172.30.0.0/16
platform:
  azure:
    baseDomainResourceGroupName: resource_group 11
    region: centralus 12
    resourceGroupName: existing_resource_group 13
    outboundType: Loadbalancer
    cloudName: AzurePublicCloud
pullSecret: '{"auths": ...}' 14
fips: false 15
sshKey: ssh-ed25519 AAAA... 16

```

- 1 10 12 14 Required. The installation program prompts you for this value.
- 2 6 If you do not provide these parameters and values, the installation program provides the default value.
- 3 7 The **controlPlane** section is a single mapping, but the **compute** section is a sequence of mappings. To meet the requirements of the different data structures, the first line of the **compute** section must begin with a hyphen, -, and the first line of the **controlPlane** section must not. Only one control plane pool is used.
- 4 Whether to enable or disable simultaneous multithreading, or **hypertreading**. By default, simultaneous multithreading is enabled to increase the performance of your machines' cores. You can disable it by setting the parameter value to **Disabled**. If you disable simultaneous multithreading in some cluster machines, you must disable it in all cluster machines.



### IMPORTANT

If you disable simultaneous multithreading, ensure that your capacity planning accounts for the dramatically decreased machine performance. Use larger virtual machine types, such as **Standard\_D8s\_v3**, for your machines if you disable simultaneous multithreading.

- 5 8 You can specify the size of the disk to use in GB. Minimum recommendation for control plane nodes is 1024 GB.
- 9 Specify a list of zones to deploy your machines to. For high availability, specify at least two zones.
- 11 Specify the name of the resource group that contains the DNS zone for your base domain.
- 13 Specify the name of an already existing resource group to install your cluster to. If undefined, a new resource group is created for the cluster.
- 15 Whether to enable or disable FIPS mode. By default, FIPS mode is not enabled. If FIPS mode is enabled, the Red Hat Enterprise Linux CoreOS (RHCOS) machines that OpenShift Container Platform runs on bypass the default Kubernetes cryptography suite and use the cryptography modules that are provided with RHCOS instead.



## IMPORTANT

To enable FIPS mode for your cluster, you must run the installation program from a Red Hat Enterprise Linux (RHEL) computer configured to operate in FIPS mode. For more information about configuring FIPS mode on RHEL, see [Installing the system in FIPS mode](#). The use of FIPS validated or Modules In Process cryptographic libraries is only supported on OpenShift Container Platform deployments on the **x86\_64** architecture.

16

You can optionally provide the **sshKey** value that you use to access the machines in your cluster.



## NOTE

For production OpenShift Container Platform clusters on which you want to perform installation debugging or disaster recovery, specify an SSH key that your **ssh-agent** process uses.

### 6.5.6.5. Configuring the cluster-wide proxy during installation

Production environments can deny direct access to the internet and instead have an HTTP or HTTPS proxy available. You can configure a new OpenShift Container Platform cluster to use a proxy by configuring the proxy settings in the **install-config.yaml** file.

#### Prerequisites

- You have an existing **install-config.yaml** file.
- You reviewed the sites that your cluster requires access to and determined whether any of them need to bypass the proxy. By default, all cluster egress traffic is proxied, including calls to hosting cloud provider APIs. You added sites to the **Proxy** object's **spec.noProxy** field to bypass the proxy if necessary.

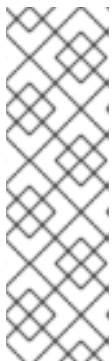

## NOTE

The **Proxy** object **status.noProxy** field is populated with the values of the **networking.machineNetwork[].cidr**, **networking.clusterNetwork[].cidr**, and **networking.serviceNetwork[]** fields from your installation configuration.

For installations on Amazon Web Services (AWS), Google Cloud Platform (GCP), Microsoft Azure, and Red Hat OpenStack Platform (RHOSP), the **Proxy** object **status.noProxy** field is also populated with the instance metadata endpoint (**169.254.169.254**).

#### Procedure

1. Edit your **install-config.yaml** file and add the proxy settings. For example:

```
apiVersion: v1
baseDomain: my.domain.com
proxy:
  httpProxy: http://<username>:<pswd>@<ip>:<port> 1
  httpsProxy: https://<username>:<pswd>@<ip>:<port> 2
  noProxy: example.com 3
```

```
additionalTrustBundle: | 4
-----BEGIN CERTIFICATE-----
<MY_TRUSTED_CA_CERT>
-----END CERTIFICATE-----
...
```

- 1 A proxy URL to use for creating HTTP connections outside the cluster. The URL scheme must be **http**.
- 2 A proxy URL to use for creating HTTPS connections outside the cluster.
- 3 A comma-separated list of destination domain names, IP addresses, or other network CIDRs to exclude from proxying. Preface a domain with **.** to match subdomains only. For example, **.y.com** matches **x.y.com**, but not **y.com**. Use **\*** to bypass the proxy for all destinations.
- 4 If provided, the installation program generates a config map that is named **user-ca-bundle** in the **openshift-config** namespace that contains one or more additional CA certificates that are required for proxying HTTPS connections. The Cluster Network Operator then creates a **trusted-ca-bundle** config map that merges these contents with the Red Hat Enterprise Linux CoreOS (RHCOS) trust bundle, and this config map is referenced in the **trustedCA** field of the **Proxy** object. The **additionalTrustBundle** field is required unless the proxy's identity certificate is signed by an authority from the RHCOS trust bundle.

**NOTE**

The installation program does not support the proxy **readinessEndpoints** field.

**NOTE**

If the installer times out, restart and then complete the deployment by using the **wait-for** command of the installer. For example:

```
$ ./openshift-install wait-for install-complete --log-level debug
```

2. Save the file and reference it when installing OpenShift Container Platform.

The installation program creates a cluster-wide proxy that is named **cluster** that uses the proxy settings in the provided **install-config.yaml** file. If no proxy settings are provided, a **cluster Proxy** object is still created, but it will have a nil **spec**.

**NOTE**

Only the **Proxy** object named **cluster** is supported, and no additional proxies can be created.

### 6.5.7. Enabling Accelerated Networking during installation

You can enable Accelerated Networking on Microsoft Azure by adding **acceleratedNetworking** to your machine set YAML file before you install the cluster.

#### Prerequisites

- You have created the **install-config.yaml** file and completed any modifications to it.

## Procedure

- Change to the directory that contains the installation program and create the manifests:

```
$ ./openshift-install create manifests --dir <installation_directory> 1
```

- 1** **<installation\_directory>** specifies the name of the directory that contains the **install-config.yaml** file for your cluster.

## Example output

```
INFO Credentials loaded from the "myprofile" profile in file "/home/myuser/.azure/credentials"
INFO Consuming Install Config from target directory
INFO Manifests created in: installation_directory/manifests and
installation_directory/openshift
```

- Change to the **openshift** directory within the directory that contains the installation program. The **openshift** directory contains the Kubernetes manifest files that define the worker machines. These are the three default machine set files for an Azure cluster:

## Machine set files in openshift directory listing

```
99_openshift-cluster-api_worker-machineset-0.yaml
99_openshift-cluster-api_worker-machineset-1.yaml
99_openshift-cluster-api_worker-machineset-2.yaml
```

- Add the following to the **providerSpec** field in each machine set file:

```
providerSpec:
  value:
    ...
    acceleratedNetworking: true 1
    ...
    vmSize: <azure-vm-size> 2
    ...
```

- 1** This line enables Accelerated Networking.
- 2** Specify an Azure VM size that includes at least four vCPUs. For information about VM sizes, see [Microsoft Azure documentation](#).

## Additional resources

- For more details about Accelerated Networking, see [Accelerated Networking for Microsoft Azure VMs](#).

## 6.5.8. Updating manifests for Marketplace installation

If you selected a Marketplace image for installation, you must create and modify the manifests to use the Marketplace image.

## Prerequisites

- You have created the **install-config.yaml** file and completed any modifications to it.

## Procedure

1. Change to the directory that contains the installation program and create the manifests by running the following command:

```
$ openshift-install create manifests --dir <installation_dir>
```

2. Edit the **.spec.template.spec.providerSpec.value.image** property of the compute machine set definitions, replacing the **offer**, **publisher**, **sku**, and **version** values with the details gathered in the section titled "Selecting an Azure Marketplace image". These are the three files that must be updated:

- **<installation\_dir>/openshift/99\_openshift-cluster-api\_worker-machineset-0.yaml**
- **<installation\_dir>/openshift/99\_openshift-cluster-api\_worker-machineset-1.yaml**
- **<installation\_dir>/openshift/99\_openshift-cluster-api\_worker-machineset-2.yaml**

3. In each file, replace the value of the **.spec.template.spec.providerSpec.value.image.resourceID** property with an empty value (**""**).
4. In each file, set the **type** property to **MarketplaceWithPlan**.
5. Using the first machine set file as an example, the **.spec.template.spec.providerSpec.value.image** section must look like the following example:

```
image:
  offer: rh-ocp-worker
  publisher: redhat
  resourceID: ""
  sku: rh-ocp-worker
  version: 4.8.2021122100
  type: MarketplaceWithPlan
```

## 6.5.9. Deploying the cluster

You can install OpenShift Container Platform on a compatible cloud platform.



### IMPORTANT

You can run the **create cluster** command of the installation program only once, during initial installation.

## Prerequisites

- Configure an account with the cloud platform that hosts your cluster.



- Obtain the OpenShift Container Platform installation program and the pull secret for your cluster.

## Procedure

1. Change to the directory that contains the installation program and initialize the cluster deployment:

```
$ ./openshift-install create cluster --dir <installation_directory> \ ❶
--log-level=info ❷
```

- ❶ For **<installation\_directory>**, specify the location of your customized **./install-config.yaml** file.
- ❷ To view different installation details, specify **warn**, **debug**, or **error** instead of **info**.

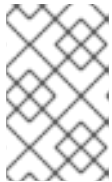

### NOTE

If the cloud provider account that you configured on your host does not have sufficient permissions to deploy the cluster, the installation process stops, and the missing permissions are displayed.

When the cluster deployment completes, directions for accessing your cluster, including a link to its web console and credentials for the **kubeadmin** user, display in your terminal.

## Example output

```
...
INFO Install complete!
INFO To access the cluster as the system:admin user when using 'oc', run 'export
KUBECONFIG=/home/myuser/install_dir/auth/kubeconfig'
INFO Access the OpenShift web-console here: https://console-openshift-
console.apps.mycluster.example.com
INFO Login to the console with user: "kubeadmin", and password: "4vYBz-Ee6gm-ymBZj-
Wt5AL"
INFO Time elapsed: 36m22s
```

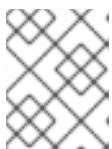

### NOTE

The cluster access and credential information also outputs to **<installation\_directory>/./openshift\_install.log** when an installation succeeds.

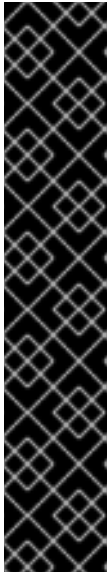
**IMPORTANT**

- The Ignition config files that the installation program generates contain certificates that expire after 24 hours, which are then renewed at that time. If the cluster is shut down before renewing the certificates and the cluster is later restarted after the 24 hours have elapsed, the cluster automatically recovers the expired certificates. The exception is that you must manually approve the pending **node-bootstrapper** certificate signing requests (CSRs) to recover kubelet certificates. See the documentation for *Recovering from expired control plane certificates* for more information.
- It is recommended that you use Ignition config files within 12 hours after they are generated because the 24-hour certificate rotates from 16 to 22 hours after the cluster is installed. By using the Ignition config files within 12 hours, you can avoid installation failure if the certificate update runs during installation.

**IMPORTANT**

You must not delete the installation program or the files that the installation program creates. Both are required to delete the cluster.

**6.5.10. Installing the OpenShift CLI by downloading the binary**

You can install the OpenShift CLI (**oc**) to interact with OpenShift Container Platform from a command-line interface. You can install **oc** on Linux, Windows, or macOS.

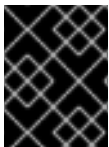
**IMPORTANT**

If you installed an earlier version of **oc**, you cannot use it to complete all of the commands in OpenShift Container Platform 4.10. Download and install the new version of **oc**.

**Installing the OpenShift CLI on Linux**

You can install the OpenShift CLI (**oc**) binary on Linux by using the following procedure.

**Procedure**

1. Navigate to the [OpenShift Container Platform downloads page](#) on the Red Hat Customer Portal.
2. Select the appropriate version in the **Version** drop-down menu.
3. Click **Download Now** next to the **OpenShift v4.10 Linux Client** entry and save the file.
4. Unpack the archive:

```
$ tar xvf <file>
```

5. Place the **oc** binary in a directory that is on your **PATH**. To check your **PATH**, execute the following command:

```
$ echo $PATH
```

After you install the OpenShift CLI, it is available using the **oc** command:

```
$ oc <command>
```

### Installing the OpenShift CLI on Windows

You can install the OpenShift CLI (**oc**) binary on Windows by using the following procedure.

#### Procedure

1. Navigate to the [OpenShift Container Platform downloads page](#) on the Red Hat Customer Portal.
2. Select the appropriate version in the **Version** drop-down menu.
3. Click **Download Now** next to the **OpenShift v4.10 Windows Client** entry and save the file.
4. Unzip the archive with a ZIP program.
5. Move the **oc** binary to a directory that is on your **PATH**.  
To check your **PATH**, open the command prompt and execute the following command:

```
C:\> path
```

After you install the OpenShift CLI, it is available using the **oc** command:

```
C:\> oc <command>
```

### Installing the OpenShift CLI on macOS

You can install the OpenShift CLI (**oc**) binary on macOS by using the following procedure.

#### Procedure

1. Navigate to the [OpenShift Container Platform downloads page](#) on the Red Hat Customer Portal.
2. Select the appropriate version in the **Version** drop-down menu.
3. Click **Download Now** next to the **OpenShift v4.10 MacOSX Client** entry and save the file.
4. Unpack and unzip the archive.
5. Move the **oc** binary to a directory on your **PATH**.  
To check your **PATH**, open a terminal and execute the following command:

```
$ echo $PATH
```

After you install the OpenShift CLI, it is available using the **oc** command:

```
$ oc <command>
```

### 6.5.11. Logging in to the cluster by using the CLI

You can log in to your cluster as a default system user by exporting the cluster **kubeconfig** file. The **kubeconfig** file contains information about the cluster that is used by the CLI to connect a client to the correct cluster and API server. The file is specific to a cluster and is created during OpenShift Container

Platform installation.

### Prerequisites

- You deployed an OpenShift Container Platform cluster.
- You installed the **oc** CLI.

### Procedure

1. Export the **kubeadmin** credentials:

```
$ export KUBECONFIG=<installation_directory>/auth/kubeconfig 1
```

- 1** For **<installation\_directory>**, specify the path to the directory that you stored the installation files in.

2. Verify you can run **oc** commands successfully using the exported configuration:

```
$ oc whoami
```

#### Example output

```
system:admin
```

### Additional resources

- See [Accessing the web console](#) for more details about accessing and understanding the OpenShift Container Platform web console.

## 6.5.12. Telemetry access for OpenShift Container Platform

In OpenShift Container Platform 4.10, the Telemetry service, which runs by default to provide metrics about cluster health and the success of updates, requires internet access. If your cluster is connected to the internet, Telemetry runs automatically, and your cluster is registered to [OpenShift Cluster Manager](#).

After you confirm that your [OpenShift Cluster Manager](#) inventory is correct, either maintained automatically by Telemetry or manually by using OpenShift Cluster Manager, [use subscription watch](#) to track your OpenShift Container Platform subscriptions at the account or multi-cluster level.

### Additional resources

- See [About remote health monitoring](#) for more information about the Telemetry service

## 6.5.13. Next steps

- [Customize your cluster](#).
- If necessary, you can [opt out of remote health reporting](#) .

## 6.6. INSTALLING A CLUSTER ON AZURE WITH NETWORK CUSTOMIZATIONS

In OpenShift Container Platform version 4.10, you can install a cluster with a customized network configuration on infrastructure that the installation program provisions on Microsoft Azure. By customizing your network configuration, your cluster can coexist with existing IP address allocations in your environment and integrate with existing MTU and VXLAN configurations.

You must set most of the network configuration parameters during installation, and you can modify only **kubeProxy** configuration parameters in a running cluster.

### 6.6.1. Prerequisites

- You reviewed details about the [OpenShift Container Platform installation and update](#) processes.
- You read the documentation on [selecting a cluster installation method and preparing it for users](#).
- You [configured an Azure account](#) to host the cluster and determined the tested and validated region to deploy the cluster to.
- If you use a firewall, you [configured it to allow the sites](#) that your cluster requires access to.
- If the cloud identity and access management (IAM) APIs are not accessible in your environment, or if you do not want to store an administrator-level credential secret in the **kube-system** namespace, you can [manually create and maintain IAM credentials](#). Manual mode can also be used in environments where the cloud IAM APIs are not reachable.

### 6.6.2. Internet access for OpenShift Container Platform

In OpenShift Container Platform 4.10, you require access to the internet to install your cluster.

You must have internet access to:

- Access [OpenShift Cluster Manager](#) to download the installation program and perform subscription management. If the cluster has internet access and you do not disable Telemetry, that service automatically entitles your cluster.
- Access [Quay.io](#) to obtain the packages that are required to install your cluster.
- Obtain the packages that are required to perform cluster updates.



#### IMPORTANT

If your cluster cannot have direct internet access, you can perform a restricted network installation on some types of infrastructure that you provision. During that process, you download the required content and use it to populate a mirror registry with the installation packages. With some installation types, the environment that you install your cluster in will not require internet access. Before you update the cluster, you update the content of the mirror registry.

### 6.6.3. Generating a key pair for cluster node SSH access

During an OpenShift Container Platform installation, you can provide an SSH public key to the

installation program. The key is passed to the Red Hat Enterprise Linux CoreOS (RHCOS) nodes through their Ignition config files and is used to authenticate SSH access to the nodes. The key is added to the `~/.ssh/authorized_keys` list for the **core** user on each node, which enables password-less authentication.

After the key is passed to the nodes, you can use the key pair to SSH in to the RHCOS nodes as the user **core**. To access the nodes through SSH, the private key identity must be managed by SSH for your local user.

If you want to SSH in to your cluster nodes to perform installation debugging or disaster recovery, you must provide the SSH public key during the installation process. The `./openshift-install gather` command also requires the SSH public key to be in place on the cluster nodes.



### IMPORTANT

Do not skip this procedure in production environments, where disaster recovery and debugging is required.



### NOTE

You must use a local key, not one that you configured with platform-specific approaches such as [AWS key pairs](#).

## Procedure

1. If you do not have an existing SSH key pair on your local machine to use for authentication onto your cluster nodes, create one. For example, on a computer that uses a Linux operating system, run the following command:

```
$ ssh-keygen -t ed25519 -N "" -f <path>/<file_name> 1
```

- 1 Specify the path and file name, such as `~/.ssh/id_ed25519`, of the new SSH key. If you have an existing key pair, ensure your public key is in the your `~/.ssh` directory.



### NOTE

If you plan to install an OpenShift Container Platform cluster that uses FIPS validated or Modules In Process cryptographic libraries on the **x86\_64** architecture, do not create a key that uses the **ed25519** algorithm. Instead, create a key that uses the **rsa** or **ecdsa** algorithm.

2. View the public SSH key:

```
$ cat <path>/<file_name>.pub
```

For example, run the following to view the `~/.ssh/id_ed25519.pub` public key:

```
$ cat ~/.ssh/id_ed25519.pub
```

3. Add the SSH private key identity to the SSH agent for your local user, if it has not already been added. SSH agent management of the key is required for password-less SSH authentication onto your cluster nodes, or if you want to use the `./openshift-install gather` command.

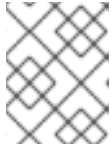
**NOTE**

On some distributions, default SSH private key identities such as `~/.ssh/id_rsa` and `~/.ssh/id_dsa` are managed automatically.

- a. If the **ssh-agent** process is not already running for your local user, start it as a background task:

```
$ eval "$(ssh-agent -s)"
```

**Example output**

```
Agent pid 31874
```

**NOTE**

If your cluster is in FIPS mode, only use FIPS-compliant algorithms to generate the SSH key. The key must be either RSA or ECDSA.

4. Add your SSH private key to the **ssh-agent**:

```
$ ssh-add <path>/<file_name> 1
```

- 1** Specify the path and file name for your SSH private key, such as `~/.ssh/id_ed25519`

**Example output**

```
Identity added: /home/<you>/<path>/<file_name> (<computer_name>)
```

**Next steps**

- When you install OpenShift Container Platform, provide the SSH public key to the installation program.

**6.6.4. Obtaining the installation program**

Before you install OpenShift Container Platform, download the installation file on a local computer.

**Prerequisites**

- You have a computer that runs Linux or macOS, with 500 MB of local disk space

**Procedure**

1. Access the [Infrastructure Provider](#) page on the OpenShift Cluster Manager site. If you have a Red Hat account, log in with your credentials. If you do not, create an account.
2. Select your infrastructure provider.

3. Navigate to the page for your installation type, download the installation program that corresponds with your host operating system and architecture, and place the file in the directory where you will store the installation configuration files.



### IMPORTANT

The installation program creates several files on the computer that you use to install your cluster. You must keep the installation program and the files that the installation program creates after you finish installing the cluster. Both files are required to delete the cluster.



### IMPORTANT

Deleting the files created by the installation program does not remove your cluster, even if the cluster failed during installation. To remove your cluster, complete the OpenShift Container Platform uninstallation procedures for your specific cloud provider.

4. Extract the installation program. For example, on a computer that uses a Linux operating system, run the following command:

```
$ tar -xvf openshift-install-linux.tar.gz
```

5. Download your installation [pull secret from the Red Hat OpenShift Cluster Manager](#). This pull secret allows you to authenticate with the services that are provided by the included authorities, including Quay.io, which serves the container images for OpenShift Container Platform components.

## 6.6.5. Creating the installation configuration file

You can customize the OpenShift Container Platform cluster you install on Microsoft Azure.

### Prerequisites

- Obtain the OpenShift Container Platform installation program and the pull secret for your cluster.
- Obtain service principal permissions at the subscription level.

### Procedure

1. Create the **install-config.yaml** file.
  - a. Change to the directory that contains the installation program and run the following command:

```
$ ./openshift-install create install-config --dir <installation_directory> 1
```

- 1** For **<installation\_directory>**, specify the directory name to store the files that the installation program creates.





### IMPORTANT

Specify an empty directory. Some installation assets, like bootstrap X.509 certificates have short expiration intervals, so you must not reuse an installation directory. If you want to reuse individual files from another cluster installation, you can copy them into your directory. However, the file names for the installation assets might change between releases. Use caution when copying installation files from an earlier OpenShift Container Platform version.

- b. At the prompts, provide the configuration details for your cloud:
  - i. Optional: Select an SSH key to use to access your cluster machines.



### NOTE

For production OpenShift Container Platform clusters on which you want to perform installation debugging or disaster recovery, specify an SSH key that your **ssh-agent** process uses.

- ii. Select **azure** as the platform to target.
- iii. If you do not have a Microsoft Azure profile stored on your computer, specify the following Azure parameter values for your subscription and service principal:
  - **azure subscription id** The subscription ID to use for the cluster. Specify the **id** value in your account output.
  - **azure tenant id** The tenant ID. Specify the **tenantId** value in your account output.
  - **azure service principal client id** The value of the **appId** parameter for the service principal.
  - **azure service principal client secret** The value of the **password** parameter for the service principal.
- iv. Select the region to deploy the cluster to.
- v. Select the base domain to deploy the cluster to. The base domain corresponds to the Azure DNS Zone that you created for your cluster.
- vi. Enter a descriptive name for your cluster.



### IMPORTANT

All Azure resources that are available through public endpoints are subject to resource name restrictions, and you cannot create resources that use certain terms. For a list of terms that Azure restricts, see [Resolve reserved resource name errors](#) in the Azure documentation.

- vii. Paste the [pull secret from the Red Hat OpenShift Cluster Manager](#) .
2. Modify the **install-config.yaml** file. You can find more information about the available parameters in the "Installation configuration parameters" section.

3. Back up the **install-config.yaml** file so that you can use it to install multiple clusters.



### IMPORTANT

The **install-config.yaml** file is consumed during the installation process. If you want to reuse the file, you must back it up now.

#### 6.6.5.1. Installation configuration parameters

Before you deploy an OpenShift Container Platform cluster, you provide parameter values to describe your account on the cloud platform that hosts your cluster and optionally customize your cluster's platform. When you create the **install-config.yaml** installation configuration file, you provide values for the required parameters through the command line. If you customize your cluster, you can modify the **install-config.yaml** file to provide more details about the platform.



### NOTE

After installation, you cannot modify these parameters in the **install-config.yaml** file.

##### 6.6.5.1.1. Required configuration parameters

Required installation configuration parameters are described in the following table:

Table 6.6. Required parameters

Parameter	Description	Values
<b>apiVersion</b>	The API version for the <b>install-config.yaml</b> content. The current version is <b>v1</b> . The installer may also support older API versions.	String
<b>baseDomain</b>	The base domain of your cloud provider. The base domain is used to create routes to your OpenShift Container Platform cluster components. The full DNS name for your cluster is a combination of the <b>baseDomain</b> and <b>metadata.name</b> parameter values that uses the <b>&lt;metadata.name&gt;</b> . <b>&lt;baseDomain&gt;</b> format.	A fully-qualified domain or subdomain name, such as <b>example.com</b> .
<b>metadata</b>	Kubernetes resource <b>ObjectMeta</b> , from which only the <b>name</b> parameter is consumed.	Object

Parameter	Description	Values
<b>metadata.name</b>	The name of the cluster. DNS records for the cluster are all subdomains of <b>{{.metadata.name}}.{{.baseDomain}}</b> .	String of lowercase letters, hyphens (-), and periods (.), such as <b>dev</b> .
<b>platform</b>	The configuration for the specific platform upon which to perform the installation: <b>alibabacloud, aws, baremetal, azure, gcp, ibmcloud, openstack, ovirt, vsphere</b> , or <b>{}</b> . For additional information about <b>platform.&lt;platform&gt;</b> parameters, consult the table for your specific platform that follows.	Object
<b>pullSecret</b>	Get a <a href="#">pull secret from the Red Hat OpenShift Cluster Manager</a> to authenticate downloading container images for OpenShift Container Platform components from services such as Quay.io.	<pre>{   "auths":{     "cloud.openshift.com":{       "auth":"b3Blb=",       "email":"you@example.com"     },     "quay.io":{       "auth":"b3Blb=",       "email":"you@example.com"     }   } }</pre>

#### 6.6.5.1.2. Network configuration parameters

You can customize your installation configuration based on the requirements of your existing network infrastructure. For example, you can expand the IP address block for the cluster network or provide different IP address blocks than the defaults.

Only IPv4 addresses are supported.

**Table 6.7. Network parameters**

Parameter	Description	Values
-----------	-------------	--------

Parameter	Description	Values
<b>networking</b>	The configuration for the cluster network.	Object  <b>NOTE</b> You cannot modify parameters specified by the <b>networking</b> object after installation.
<b>networking.networkType</b>	The cluster network provider Container Network Interface (CNI) plugin to install.	Either <b>OpenShiftSDN</b> or <b>OVNKubernetes</b> . <b>OpenShiftSDN</b> is a CNI provider for all-Linux networks. <b>OVNKubernetes</b> is a CNI provider for Linux networks and hybrid networks that contain both Linux and Windows servers. The default value is <b>OpenShiftSDN</b> .
<b>networking.clusterNetwork</b>	The IP address blocks for pods.  The default value is <b>10.128.0.0/14</b> with a host prefix of <b>/23</b> .  If you specify multiple IP address blocks, the blocks must not overlap.	An array of objects. For example:  <pre>networking:   clusterNetwork:     - cidr: 10.128.0.0/14       hostPrefix: 23</pre>
<b>networking.clusterNetwork.cidr</b>	Required if you use <b>networking.clusterNetwork</b> . An IP address block.  An IPv4 network.	An IP address block in Classless Inter-Domain Routing (CIDR) notation. The prefix length for an IPv4 block is between <b>0</b> and <b>32</b> .
<b>networking.clusterNetwork.hostPrefix</b>	The subnet prefix length to assign to each individual node. For example, if <b>hostPrefix</b> is set to <b>23</b> then each node is assigned a <b>/23</b> subnet out of the given <b>cidr</b> . A <b>hostPrefix</b> value of <b>23</b> provides 510 ( $2^{(32 - 23)} - 2$ ) pod IP addresses.	A subnet prefix.  The default value is <b>23</b> .
<b>networking.serviceNetwork</b>	The IP address block for services. The default value is <b>172.30.0.0/16</b> .  The OpenShift SDN and OVN-Kubernetes network providers support only a single IP address block for the service network.	An array with an IP address block in CIDR format. For example:  <pre>networking:   serviceNetwork:     - 172.30.0.0/16</pre>

Parameter	Description	Values
<b>networking.machineNetwork</b>	The IP address blocks for machines.  If you specify multiple IP address blocks, the blocks must not overlap.	An array of objects. For example:  <pre>networking:   machineNetwork:   - cidr: 10.0.0.0/16</pre>
<b>networking.machineNetwork.cidr</b>	Required if you use <b>networking.machineNetwork</b> . An IP address block. The default value is <b>10.0.0.0/16</b> for all platforms other than libvirt. For libvirt, the default value is <b>192.168.126.0/24</b> .	An IP network block in CIDR notation.  For example, <b>10.0.0.0/16</b> .   <p><b>NOTE</b></p> <p>Set the <b>networking.machineNetwork</b> to match the CIDR that the preferred NIC resides in.</p>

### 6.6.5.1.3. Optional configuration parameters



Optional installation configuration parameters are described in the following table:

**Table 6.8. Optional parameters**

Parameter	Description	Values
<b>additionalTrustBundle</b>	A PEM-encoded X.509 certificate bundle that is added to the nodes' trusted certificate store. This trust bundle may also be used when a proxy has been configured.	String
<b>cgroupsV2</b>	Enables <a href="#">Linux control groups version 2</a> (cgroups v2) on specific nodes in your cluster. The OpenShift Container Platform process for enabling cgroups v2 disables all cgroup version 1 controllers and hierarchies. The OpenShift Container Platform cgroups version 2 feature is in Developer Preview and is not supported by Red Hat at this time.	<b>true</b>
<b>compute</b>	The configuration for the machines that comprise the compute nodes.	Array of <b>MachinePool</b> objects.

Parameter	Description	Values
<b>compute.architecture</b>	Determines the instruction set architecture of the machines in the pool. Currently, clusters with varied architectures are not supported. All pools must specify the same architecture. Valid values are <b>amd64</b> (the default).	String
<b>compute.hyperthreading</b>	Whether to enable or disable simultaneous multithreading, or <b>hyperthreading</b> , on compute machines. By default, simultaneous multithreading is enabled to increase the performance of your machines' cores.   <b>IMPORTANT</b> If you disable simultaneous multithreading, ensure that your capacity planning accounts for the dramatically decreased machine performance.	<b>Enabled</b> or <b>Disabled</b>
<b>compute.name</b>	Required if you use <b>compute</b> . The name of the machine pool.	<b>worker</b>
<b>compute.platform</b>	Required if you use <b>compute</b> . Use this parameter to specify the cloud provider to host the worker machines. This parameter value must match the <b>controlPlane.platform</b> parameter value.	<b>alibabacloud, aws, azure, gcp, ibmcloud, openstack, ovirt, vsphere, or {}</b>
<b>compute.replicas</b>	The number of compute machines, which are also known as worker machines, to provision.	A positive integer greater than or equal to <b>2</b> . The default value is <b>3</b> .
<b>controlPlane</b>	The configuration for the machines that comprise the control plane.	Array of <b>MachinePool</b> objects.

Parameter	Description	Values
<b>controlPlane.architecture</b>	Determines the instruction set architecture of the machines in the pool. Currently, clusters with varied architectures are not supported. All pools must specify the same architecture. Valid values are <b>amd64</b> (the default).	String
<b>controlPlane.hyperthreading</b>	Whether to enable or disable simultaneous multithreading, or <b>hyperthreading</b> , on control plane machines. By default, simultaneous multithreading is enabled to increase the performance of your machines' cores.   <b>IMPORTANT</b> If you disable simultaneous multithreading, ensure that your capacity planning accounts for the dramatically decreased machine performance.	<b>Enabled</b> or <b>Disabled</b>
<b>controlPlane.name</b>	Required if you use <b>controlPlane</b> . The name of the machine pool.	<b>master</b>
<b>controlPlane.platform</b>	Required if you use <b>controlPlane</b> . Use this parameter to specify the cloud provider that hosts the control plane machines. This parameter value must match the <b>compute.platform</b> parameter value.	<b>alibabacloud, aws, azure, gcp, ibmcloud, openstack, ovirt, vsphere, or {}</b>
<b>controlPlane.replicas</b>	The number of control plane machines to provision.	The only supported value is <b>3</b> , which is the default value.

Parameter	Description	Values
<b>credentialsMode</b>	<p>The Cloud Credential Operator (CCO) mode. If no mode is specified, the CCO dynamically tries to determine the capabilities of the provided credentials, with a preference for mint mode on the platforms where multiple modes are supported.</p> <p> <b>NOTE</b></p> <p>Not all CCO modes are supported for all cloud providers. For more information on CCO modes, see the <i>Cloud Credential Operator</i> entry in the <i>Cluster Operators reference content</i>.</p> <p> <b>NOTE</b></p> <p>If your AWS account has service control policies (SCP) enabled, you must configure the <b>credentialsMode</b> parameter to <b>Mint</b>, <b>Passthrough</b> or <b>Manual</b>.</p>	<b>Mint, Passthrough, Manual</b> or an empty string ("").



Parameter	Description	Values
<b>fips</b>	<p>Enable or disable FIPS mode. The default is <b>false</b> (disabled). If FIPS mode is enabled, the Red Hat Enterprise Linux CoreOS (RHCOS) machines that OpenShift Container Platform runs on bypass the default Kubernetes cryptography suite and use the cryptography modules that are provided with RHCOS instead.</p> <div style="display: flex; align-items: flex-start;"> <div style="width: 60px; height: 100px; background: repeating-linear-gradient(45deg, transparent, transparent 2px, black 2px, black 4px); margin-right: 10px;"></div> <div> <p><b>IMPORTANT</b></p> <p>To enable FIPS mode for your cluster, you must run the installation program from a Red Hat Enterprise Linux (RHEL) computer configured to operate in FIPS mode. For more information about configuring FIPS mode on RHEL, see <a href="#">Installing the system in FIPS mode</a>. The use of FIPS validated or Modules In Process cryptographic libraries is only supported on OpenShift Container Platform deployments on the <b>x86_64</b> architecture.</p> </div> </div> <div style="display: flex; align-items: flex-start; margin-top: 10px;"> <div style="width: 60px; height: 60px; background: repeating-linear-gradient(45deg, transparent, transparent 2px, black 2px, black 4px); margin-right: 10px;"></div> <div> <p><b>NOTE</b></p> <p>If you are using Azure File storage, you cannot enable FIPS mode.</p> </div> </div>	<b>false</b> or <b>true</b>
<b>imageContentSources</b>	Sources and repositories for the release-image content.	Array of objects. Includes a <b>source</b> and, optionally, <b>mirrors</b> , as described in the following rows of this table.
<b>imageContentSources.source</b>	Required if you use <b>imageContentSources</b> . Specify the repository that users refer to, for example, in image pull specifications.	String
<b>imageContentSources.mirrors</b>	Specify one or more repositories that may also contain the same images.	Array of strings

Parameter	Description	Values
<b>publish</b>	How to publish or expose the user-facing endpoints of your cluster, such as the Kubernetes API, OpenShift routes.	<b>Internal</b> or <b>External</b> . To deploy a private cluster, which cannot be accessed from the internet, set <b>publish</b> to <b>Internal</b> . The default value is <b>External</b> .
<b>sshKey</b>	<p>The SSH key or keys to authenticate access your cluster machines.</p>  <p><b>NOTE</b></p> <p>For production OpenShift Container Platform clusters on which you want to perform installation debugging or disaster recovery, specify an SSH key that your <b>ssh-agent</b> process uses.</p>	<p>One or more keys. For example:</p> <pre>sshKey:   &lt;key1&gt;   &lt;key2&gt;   &lt;key3&gt;</pre>

#### 6.6.5.1.4. Additional Azure configuration parameters

Additional Azure configuration parameters are described in the following table.



#### NOTE

By default, if you specify availability zones in the **install-config.yaml** file, the installation program distributes the control plane machines and the compute machines across [these availability zones](#) within [a region](#). To ensure high availability for your cluster, select a region with at least three availability zones. If your region contains fewer than three availability zones, the installation program places more than one control plane machine in the available zones.

Table 6.9. Additional Azure parameters

Parameter	Description	Values
<b>compute.platform.azure.osDisk.diskSize GB</b>	The Azure disk size for the VM.	Integer that represents the size of the disk in GB. The default is <b>128</b> .
<b>compute.platform.azure.osDisk.diskType</b>	Defines the type of disk.	<b>standard_LRS</b> , <b>premium_LRS</b> , or <b>standardSSD_LRS</b> . The default is <b>premium_LRS</b> .

Parameter	Description	Values
<b>controlPlane.platform.azure.osDisk.diskSizeGB</b>	The Azure disk size for the VM.	Integer that represents the size of the disk in GB. The default is <b>1024</b> .
<b>controlPlane.platform.azure.osDisk.diskType</b>	Defines the type of disk.	<b>premium_LRS</b> or <b>standardSSD_LRS</b> . The default is <b>premium_LRS</b> .
<b>platform.azure.baseDomainResourceGroupName</b>	The name of the resource group that contains the DNS zone for your base domain.	String, for example <b>production_cluster</b> .
<b>platform.azure.resourceGroupName</b>	The name of an already existing resource group to install your cluster to. This resource group must be empty and only used for this specific cluster; the cluster components assume ownership of all resources in the resource group. If you limit the service principal scope of the installation program to this resource group, you must ensure all other resources used by the installation program in your environment have the necessary permissions, such as the public DNS zone and virtual network. Destroying the cluster by using the installation program deletes this resource group.	String, for example <b>existing_resource_group</b> .
<b>platform.azure.outboundType</b>	The outbound routing strategy used to connect your cluster to the internet. If you are using user-defined routing, you must have pre-existing networking available where the outbound routing has already been configured prior to installing a cluster. The installation program is not responsible for configuring user-defined routing.	<b>LoadBalancer</b> or <b>UserDefinedRouting</b> . The default is <b>LoadBalancer</b> .
<b>platform.azure.region</b>	The name of the Azure region that hosts your cluster.	Any valid region name, such as <b>centralus</b> .
<b>platform.azure.zone</b>	List of availability zones to place machines in. For high availability, specify at least two zones.	List of zones, for example <b>["1", "2", "3"]</b> .

Parameter	Description	Values
<b>platform.azure.networkResourceGroupName</b>	The name of the resource group that contains the existing VNet that you want to deploy your cluster to. This name cannot be the same as the <b>platform.azure.baseDomainResourceGroupName</b> .	String.
<b>platform.azure.virtualNetwork</b>	The name of the existing VNet that you want to deploy your cluster to.	String.
<b>platform.azure.controlPlaneSubnet</b>	The name of the existing subnet in your VNet that you want to deploy your control plane machines to.	Valid CIDR, for example <b>10.0.0.0/16</b> .
<b>platform.azure.computeSubnet</b>	The name of the existing subnet in your VNet that you want to deploy your compute machines to.	Valid CIDR, for example <b>10.0.0.0/16</b> .
<b>platform.azure.cloudName</b>	The name of the Azure cloud environment that is used to configure the Azure SDK with the appropriate Azure API endpoints. If empty, the default value <b>AzurePublicCloud</b> is used.	Any valid cloud environment, such as <b>AzurePublicCloud</b> or <b>AzureUSGovernmentCloud</b> .

**NOTE**

You cannot customize [Azure Availability Zones](#) or [Use tags to organize your Azure resources](#) with an Azure cluster.

### 6.6.5.2. Minimum resource requirements for cluster installation

Each cluster machine must meet the following minimum requirements:

**Table 6.10. Minimum resource requirements**

Machine	Operating System	vCPU [1]	Virtual RAM	Storage	IOPS [2]
Bootstrap	RHCOS	4	16 GB	100 GB	300
Control plane	RHCOS	4	16 GB	100 GB	300
Compute	RHCOS, RHEL 8.4, or RHEL 8.5 [3]	2	8 GB	100 GB	300

1. One vCPU is equivalent to one physical core when simultaneous multithreading (SMT), or hyperthreading, is not enabled. When enabled, use the following formula to calculate the corresponding ratio:  $(\text{threads per core} \times \text{cores}) \times \text{sockets} = \text{vCPUs}$ .
2. OpenShift Container Platform and Kubernetes are sensitive to disk performance, and faster storage is recommended, particularly for etcd on the control plane nodes which require a 10 ms p99 fsync duration. Note that on many cloud platforms, storage size and IOPS scale together, so you might need to over-allocate storage volume to obtain sufficient performance.
3. As with all user-provisioned installations, if you choose to use RHEL compute machines in your cluster, you take responsibility for all operating system life cycle management and maintenance, including performing system updates, applying patches, and completing all other required tasks. Use of RHEL 7 compute machines is deprecated and has been removed in OpenShift Container Platform 4.10 and later.



### IMPORTANT

You are required to use Azure virtual machines with **premiumIO** set to **true**. The machines must also have the **hyperVGeneration** property contain **V1**.

If an instance type for your platform meets the minimum requirements for cluster machines, it is supported to use in OpenShift Container Platform.

#### 6.6.5.3. Tested instance types for Azure

The following Microsoft Azure instance types have been tested with OpenShift Container Platform.

##### Example 6.2. Machine types

- **c4.\***
- **c5.\***
- **c5a.\***
- **i3.\***
- **m4.\***
- **m5.\***
- **m5a.\***
- **m6i.\***
- **r4.\***
- **r5.\***
- **r5a.\***
- **r6i.\***
- **t3.\***
- **t3a.\***

#### 6.6.5.4. Sample customized install-config.yaml file for Azure

You can customize the **install-config.yaml** file to specify more details about your OpenShift Container Platform cluster's platform or modify the values of the required parameters.



#### IMPORTANT

This sample YAML file is provided for reference only. You must obtain your **install-config.yaml** file by using the installation program and modify it.

```

apiVersion: v1
baseDomain: example.com 1
controlPlane: 2
  hyperthreading: Enabled 3 4
  name: master
  platform:
    azure:
      osDisk:
        diskSizeGB: 1024 5
        diskType: Premium_LRS
        type: Standard_D8s_v3
      replicas: 3
compute: 6
- hyperthreading: Enabled 7
  name: worker
  platform:
    azure:
      type: Standard_D2s_v3
      osDisk:
        diskSizeGB: 512 8
        diskType: Standard_LRS
      zones: 9
      - "1"
      - "2"
      - "3"
    replicas: 5
metadata:
  name: test-cluster 10
networking: 11
  clusterNetwork:
  - cidr: 10.128.0.0/14
    hostPrefix: 23
  machineNetwork:
  - cidr: 10.0.0.0/16
  networkType: OpenShiftSDN
  serviceNetwork:
  - 172.30.0.0/16
platform:
  azure:
    baseDomainResourceGroupName: resource_group 12
    region: centralus 13

```

```
resourceGroupName: existing_resource_group 14
outboundType: Loadbalancer
cloudName: AzurePublicCloud
pullSecret: '{"auths": ...}' 15
fips: false 16
sshKey: ssh-ed25519 AAAA... 17
```

- 1 10 13 15 Required. The installation program prompts you for this value.
- 2 6 11 If you do not provide these parameters and values, the installation program provides the default value.
- 3 7 The **controlPlane** section is a single mapping, but the **compute** section is a sequence of mappings. To meet the requirements of the different data structures, the first line of the **compute** section must begin with a hyphen, -, and the first line of the **controlPlane** section must not. Only one control plane pool is used.
- 4 Whether to enable or disable simultaneous multithreading, or **hyperthreading**. By default, simultaneous multithreading is enabled to increase the performance of your machines' cores. You can disable it by setting the parameter value to **Disabled**. If you disable simultaneous multithreading in some cluster machines, you must disable it in all cluster machines.



### IMPORTANT

If you disable simultaneous multithreading, ensure that your capacity planning accounts for the dramatically decreased machine performance. Use larger virtual machine types, such as **Standard\_D8s\_v3**, for your machines if you disable simultaneous multithreading.

- 5 8 You can specify the size of the disk to use in GB. Minimum recommendation for control plane nodes is 1024 GB.
- 9 Specify a list of zones to deploy your machines to. For high availability, specify at least two zones.
- 12 Specify the name of the resource group that contains the DNS zone for your base domain.
- 14 Specify the name of an already existing resource group to install your cluster to. If undefined, a new resource group is created for the cluster.
- 16 Whether to enable or disable FIPS mode. By default, FIPS mode is not enabled. If FIPS mode is enabled, the Red Hat Enterprise Linux CoreOS (RHCOS) machines that OpenShift Container Platform runs on bypass the default Kubernetes cryptography suite and use the cryptography modules that are provided with RHCOS instead.



### IMPORTANT

To enable FIPS mode for your cluster, you must run the installation program from a Red Hat Enterprise Linux (RHEL) computer configured to operate in FIPS mode. For more information about configuring FIPS mode on RHEL, see [Installing the system in FIPS mode](#). The use of FIPS validated or Modules In Process cryptographic libraries is only supported on OpenShift Container Platform deployments on the **x86\_64** architecture.

- 17 You can optionally provide the **sshKey** value that you use to access the machines in your cluster.

**NOTE**

For production OpenShift Container Platform clusters on which you want to perform installation debugging or disaster recovery, specify an SSH key that your **ssh-agent** process uses.

**6.6.5.5. Configuring the cluster-wide proxy during installation**

Production environments can deny direct access to the internet and instead have an HTTP or HTTPS proxy available. You can configure a new OpenShift Container Platform cluster to use a proxy by configuring the proxy settings in the **install-config.yaml** file.

**Prerequisites**

- You have an existing **install-config.yaml** file.
- You reviewed the sites that your cluster requires access to and determined whether any of them need to bypass the proxy. By default, all cluster egress traffic is proxied, including calls to hosting cloud provider APIs. You added sites to the **Proxy** object's **spec.noProxy** field to bypass the proxy if necessary.

**NOTE**

The **Proxy** object **status.noProxy** field is populated with the values of the **networking.machineNetwork[].cidr**, **networking.clusterNetwork[].cidr**, and **networking.serviceNetwork[]** fields from your installation configuration.

For installations on Amazon Web Services (AWS), Google Cloud Platform (GCP), Microsoft Azure, and Red Hat OpenStack Platform (RHOSP), the **Proxy** object **status.noProxy** field is also populated with the instance metadata endpoint (**169.254.169.254**).

**Procedure**

1. Edit your **install-config.yaml** file and add the proxy settings. For example:

```
apiVersion: v1
baseDomain: my.domain.com
proxy:
  httpProxy: http://<username>:<pswd>@<ip>:<port> 1
  httpsProxy: https://<username>:<pswd>@<ip>:<port> 2
  noProxy: example.com 3
additionalTrustBundle: | 4
  -----BEGIN CERTIFICATE-----
  <MY_TRUSTED_CA_CERT>
  -----END CERTIFICATE-----
...
```

**1** A proxy URL to use for creating HTTP connections outside the cluster. The URL scheme must be **http**.

**2** A proxy URL to use for creating HTTPS connections outside the cluster.

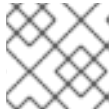

- 3 A comma-separated list of destination domain names, IP addresses, or other network CIDRs to exclude from proxying. Preface a domain with `.` to match subdomains only. For
- 4 If provided, the installation program generates a config map that is named **user-ca-bundle** in the **openshift-config** namespace that contains one or more additional CA certificates that are required for proxying HTTPS connections. The Cluster Network Operator then creates a **trusted-ca-bundle** config map that merges these contents with the Red Hat Enterprise Linux CoreOS (RHCOS) trust bundle, and this config map is referenced in the **trustedCA** field of the **Proxy** object. The **additionalTrustBundle** field is required unless the proxy's identity certificate is signed by an authority from the RHCOS trust bundle.

**NOTE**

The installation program does not support the proxy **readinessEndpoints** field.

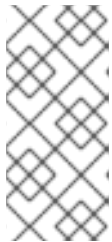
**NOTE**

If the installer times out, restart and then complete the deployment by using the **wait-for** command of the installer. For example:

```
$ ./openshift-install wait-for install-complete --log-level debug
```

2. Save the file and reference it when installing OpenShift Container Platform.

The installation program creates a cluster-wide proxy that is named **cluster** that uses the proxy settings in the provided **install-config.yaml** file. If no proxy settings are provided, a **cluster Proxy** object is still created, but it will have a nil **spec**.

**NOTE**

Only the **Proxy** object named **cluster** is supported, and no additional proxies can be created.

### 6.6.6. Network configuration phases

There are two phases prior to OpenShift Container Platform installation where you can customize the network configuration.

#### Phase 1

You can customize the following network-related fields in the **install-config.yaml** file before you create the manifest files:

- **networking.networkType**
- **networking.clusterNetwork**
- **networking.serviceNetwork**
- **networking.machineNetwork**

For more information on these fields, refer to *Installation configuration parameters*.

**NOTE**

Set the **networking.machineNetwork** to match the CIDR that the preferred NIC resides in.

**IMPORTANT**

The CIDR range **172.17.0.0/16** is reserved by libVirt. You cannot use this range or any range that overlaps with this range for any networks in your cluster.

**Phase 2**

After creating the manifest files by running **openshift-install create manifests**, you can define a customized Cluster Network Operator manifest with only the fields you want to modify. You can use the manifest to specify advanced network configuration.

You cannot override the values specified in phase 1 in the **install-config.yaml** file during phase 2. However, you can further customize the cluster network provider during phase 2.

**6.6.7. Specifying advanced network configuration**

You can use advanced network configuration for your cluster network provider to integrate your cluster into your existing network environment. You can specify advanced network configuration only before you install the cluster.

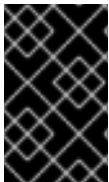
**IMPORTANT**

Customizing your network configuration by modifying the OpenShift Container Platform manifest files created by the installation program is not supported. Applying a manifest file that you create, as in the following procedure, is supported.

**Prerequisites**

- You have created the **install-config.yaml** file and completed any modifications to it.

**Procedure**

1. Change to the directory that contains the installation program and create the manifests:

```
$ ./openshift-install create manifests --dir <installation_directory> 1
```

- 1 **<installation\_directory>** specifies the name of the directory that contains the **install-config.yaml** file for your cluster.

2. Create a stub manifest file for the advanced network configuration that is named **cluster-network-03-config.yml** in the **<installation\_directory>/manifests/** directory:

```
apiVersion: operator.openshift.io/v1
kind: Network
metadata:
  name: cluster
spec:
```

- Specify the advanced network configuration for your cluster in the **cluster-network-03-config.yml** file, such as in the following examples:

### Specify a different VXLAN port for the OpenShift SDN network provider

```
apiVersion: operator.openshift.io/v1
kind: Network
metadata:
  name: cluster
spec:
  defaultNetwork:
    openshiftSDNConfig:
      vxlanPort: 4800
```

### Enable IPsec for the OVN-Kubernetes network provider

```
apiVersion: operator.openshift.io/v1
kind: Network
metadata:
  name: cluster
spec:
  defaultNetwork:
    ovnKubernetesConfig:
      ipsecConfig: {}
```

- Optional: Back up the **manifests/cluster-network-03-config.yml** file. The installation program consumes the **manifests/** directory when you create the Ignition config files.

## 6.6.8. Cluster Network Operator configuration

The configuration for the cluster network is specified as part of the Cluster Network Operator (CNO) configuration and stored in a custom resource (CR) object that is named **cluster**. The CR specifies the fields for the **Network** API in the **operator.openshift.io** API group.

The CNO configuration inherits the following fields during cluster installation from the **Network** API in the **Network.config.openshift.io** API group and these fields cannot be changed:

### **clusterNetwork**

IP address pools from which pod IP addresses are allocated.

### **serviceNetwork**

IP address pool for services.

### **defaultNetwork.type**

Cluster network provider, such as OpenShift SDN or OVN-Kubernetes.

You can specify the cluster network provider configuration for your cluster by setting the fields for the **defaultNetwork** object in the CNO object named **cluster**.

### 6.6.8.1. Cluster Network Operator configuration object

The fields for the Cluster Network Operator (CNO) are described in the following table:

**Table 6.11. Cluster Network Operator configuration object**

Field	Type	Description
<b>metadata.name</b>	<b>string</b>	The name of the CNO object. This name is always <b>cluster</b> .
<b>spec.clusterNetwork</b>	<b>array</b>	<p>A list specifying the blocks of IP addresses from which pod IP addresses are allocated and the subnet prefix length assigned to each individual node in the cluster. For example:</p> <pre>spec:   clusterNetwork:   - cidr: 10.128.0.0/19     hostPrefix: 23   - cidr: 10.128.32.0/19     hostPrefix: 23</pre> <p>You can customize this field only in the <b>install-config.yaml</b> file before you create the manifests. The value is read-only in the manifest file.</p>
<b>spec.serviceNetwork</b>	<b>array</b>	<p>A block of IP addresses for services. The OpenShift SDN and OVN-Kubernetes Container Network Interface (CNI) network providers support only a single IP address block for the service network. For example:</p> <pre>spec:   serviceNetwork:   - 172.30.0.0/14</pre> <p>You can customize this field only in the <b>install-config.yaml</b> file before you create the manifests. The value is read-only in the manifest file.</p>
<b>spec.defaultNetwork</b>	<b>object</b>	Configures the Container Network Interface (CNI) cluster network provider for the cluster network.
<b>spec.kubeProxy</b> <b>Config</b>	<b>object</b>	The fields for this object specify the kube-proxy configuration. If you are using the OVN-Kubernetes cluster network provider, the kube-proxy configuration has no effect.

### defaultNetwork object configuration

The values for the **defaultNetwork** object are defined in the following table:

Table 6.12. **defaultNetwork** object

Field	Type	Description
-------	------	-------------

Field	Type	Description
<b>type</b>	<b>string</b>	<p>Either <b>OpenShiftSDN</b> or <b>OVNKubernetes</b>. The cluster network provider is selected during installation. This value cannot be changed after cluster installation.</p> <div style="display: flex; align-items: flex-start;">  <div> <p><b>NOTE</b></p> <p>OpenShift Container Platform uses the OpenShift SDN Container Network Interface (CNI) cluster network provider by default.</p> </div> </div>
<b>openshiftSDNConfig</b>	<b>object</b>	This object is only valid for the OpenShift SDN cluster network provider.
<b>ovnKubernetesConfig</b>	<b>object</b>	This object is only valid for the OVN-Kubernetes cluster network provider.

#### Configuration for the OpenShift SDN CNI cluster network provider

The following table describes the configuration fields for the OpenShift SDN Container Network Interface (CNI) cluster network provider.

**Table 6.13. openshiftSDNConfig object**

Field	Type	Description
<b>mode</b>	<b>string</b>	<p>Configures the network isolation mode for OpenShift SDN. The default value is <b>NetworkPolicy</b>.</p> <p>The values <b>Multitenant</b> and <b>Subnet</b> are available for backwards compatibility with OpenShift Container Platform 3.x but are not recommended. This value cannot be changed after cluster installation.</p>

Field	Type	Description
<b>mtu</b>	<b>integer</b>	<p>The maximum transmission unit (MTU) for the VXLAN overlay network. This is detected automatically based on the MTU of the primary network interface. You do not normally need to override the detected MTU.</p> <p>If the auto-detected value is not what you expect it to be, confirm that the MTU on the primary network interface on your nodes is correct. You cannot use this option to change the MTU value of the primary network interface on the nodes.</p> <p>If your cluster requires different MTU values for different nodes, you must set this value to <b>50</b> less than the lowest MTU value in your cluster. For example, if some nodes in your cluster have an MTU of <b>9001</b>, and some have an MTU of <b>1500</b>, you must set this value to <b>1450</b>.</p> <p>This value cannot be changed after cluster installation.</p>
<b>vxlanPort</b>	<b>integer</b>	<p>The port to use for all VXLAN packets. The default value is <b>4789</b>. This value cannot be changed after cluster installation.</p> <p>If you are running in a virtualized environment with existing nodes that are part of another VXLAN network, then you might be required to change this. For example, when running an OpenShift SDN overlay on top of VMware NSX-T, you must select an alternate port for the VXLAN, because both SDNs use the same default VXLAN port number.</p> <p>On Amazon Web Services (AWS), you can select an alternate port for the VXLAN between port <b>9000</b> and port <b>9999</b>.</p>

### Example OpenShift SDN configuration

```
defaultNetwork:
  type: OpenShiftSDN
  openshiftSDNConfig:
    mode: NetworkPolicy
    mtu: 1450
    vxlanPort: 4789
```

### Configuration for the OVN-Kubernetes CNI cluster network provider

The following table describes the configuration fields for the OVN-Kubernetes CNI cluster network provider.

Table 6.14. `ovnKubernetesConfig` object

Field	Type	Description
-------	------	-------------

Field	Type	Description
<b>mtu</b>	<b>integer</b>	<p>The maximum transmission unit (MTU) for the Geneve (Generic Network Virtualization Encapsulation) overlay network. This is detected automatically based on the MTU of the primary network interface. You do not normally need to override the detected MTU.</p> <p>If the auto-detected value is not what you expect it to be, confirm that the MTU on the primary network interface on your nodes is correct. You cannot use this option to change the MTU value of the primary network interface on the nodes.</p> <p>If your cluster requires different MTU values for different nodes, you must set this value to <b>100</b> less than the lowest MTU value in your cluster. For example, if some nodes in your cluster have an MTU of <b>9001</b>, and some have an MTU of <b>1500</b>, you must set this value to <b>1400</b>.</p>
<b>genevePort</b>	<b>integer</b>	The port to use for all Geneve packets. The default value is <b>6081</b> . This value cannot be changed after cluster installation.
<b>ipsecConfig</b>	<b>object</b>	Specify an empty object to enable IPsec encryption. This value cannot be changed after cluster installation.
<b>policyAuditConfig</b>	<b>object</b>	Specify a configuration object for customizing network policy audit logging. If unset, the defaults audit log settings are used.
<b>gatewayConfig</b>	<b>object</b>	<p>Optional: Specify a configuration object for customizing how egress traffic is sent to the node gateway.</p> <div style="display: flex; align-items: flex-start;">  <div> <p><b>NOTE</b></p> <p>While migrating egress traffic, you can expect some disruption to workloads and service traffic until the Cluster Network Operator (CNO) successfully rolls out the changes.</p> </div> </div>

Table 6.15. **policyAuditConfig** object

Field	Type	Description
<b>rateLimit</b>	integer	The maximum number of messages to generate every second per node. The default value is <b>20</b> messages per second.
<b>maxFileSize</b>	integer	The maximum size for the audit log in bytes. The default value is <b>50000000</b> or 50 MB.

Field	Type	Description
<b>destination</b>	string	<p>One of the following additional audit log targets:</p> <p><b>libc</b> The libc <b>syslog()</b> function of the journald process on the host.</p> <p><b>udp:&lt;host&gt;:&lt;port&gt;</b> A syslog server. Replace <b>&lt;host&gt;:&lt;port&gt;</b> with the host and port of the syslog server.</p> <p><b>unix:&lt;file&gt;</b> A Unix Domain Socket file specified by <b>&lt;file&gt;</b>.</p> <p><b>null</b> Do not send the audit logs to any additional target.</p>
<b>syslogFacility</b>	string	The syslog facility, such as <b>kern</b> , as defined by RFC5424. The default value is <b>local0</b> .

Table 6.16. gatewayConfig object

Field	Type	Description
<b>routingViaHost</b>	<b>boolean</b>	<p>Set this field to <b>true</b> to send egress traffic from pods to the host networking stack. For highly-specialized installations and applications that rely on manually configured routes in the kernel routing table, you might want to route egress traffic to the host networking stack. By default, egress traffic is processed in OVN to exit the cluster and is not affected by specialized routes in the kernel routing table. The default value is <b>false</b>.</p> <p>This field has an interaction with the Open vSwitch hardware offloading feature. If you set this field to <b>true</b>, you do not receive the performance benefits of the offloading because egress traffic is processed by the host networking stack.</p>

### Example OVN-Kubernetes configuration with IPsec enabled

```

defaultNetwork:
  type: OVNKubernetes
  ovnKubernetesConfig:
    mtu: 1400
    genevePort: 6081
    ipsecConfig: {}

```

### kubeProxyConfig object configuration

The values for the **kubeProxyConfig** object are defined in the following table:

Table 6.17. kubeProxyConfig object



Field	Type	Description
<b>iptablesSyncPeriod</b>	<b>string</b>	<p>The refresh period for <b>iptables</b> rules. The default value is <b>30s</b>. Valid suffixes include <b>s</b>, <b>m</b>, and <b>h</b> and are described in the <a href="#">Go time package</a> documentation.</p> <div style="display: flex; align-items: flex-start;">  <div> <p><b>NOTE</b></p> <p>Because of performance improvements introduced in OpenShift Container Platform 4.3 and greater, adjusting the <b>iptablesSyncPeriod</b> parameter is no longer necessary.</p> </div> </div>
<b>proxyArguments.iptables-min-sync-period</b>	<b>array</b>	<p>The minimum duration before refreshing <b>iptables</b> rules. This field ensures that the refresh does not happen too frequently. Valid suffixes include <b>s</b>, <b>m</b>, and <b>h</b> and are described in the <a href="#">Go time package</a>. The default value is:</p> <pre>kubeProxyConfig:   proxyArguments:     iptables-min-sync-period:       - 0s</pre>

### 6.6.9. Configuring hybrid networking with OVN-Kubernetes

You can configure your cluster to use hybrid networking with OVN-Kubernetes. This allows a hybrid cluster that supports different node networking configurations. For example, this is necessary to run both Linux and Windows nodes in a cluster.

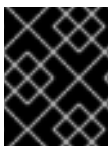

#### IMPORTANT

You must configure hybrid networking with OVN-Kubernetes during the installation of your cluster. You cannot switch to hybrid networking after the installation process.

#### Prerequisites

- You defined **OVNKubernetes** for the **networking.networkType** parameter in the **install-config.yaml** file. See the installation documentation for configuring OpenShift Container Platform network customizations on your chosen cloud provider for more information.

#### Procedure

- Change to the directory that contains the installation program and create the manifests:

```
$ ./openshift-install create manifests --dir <installation_directory>
```

where:

**<installation\_directory>**

Specifies the name of the directory that contains the **install-config.yaml** file for your cluster.

2. Create a stub manifest file for the advanced network configuration that is named **cluster-network-03-config.yml** in the **<installation\_directory>/manifests/** directory:

```
$ cat <<EOF > <installation_directory>/manifests/cluster-network-03-config.yml
apiVersion: operator.openshift.io/v1
kind: Network
metadata:
  name: cluster
spec:
  EOF
```

where:

**<installation\_directory>**

Specifies the directory name that contains the **manifests/** directory for your cluster.

3. Open the **cluster-network-03-config.yml** file in an editor and configure OVN-Kubernetes with hybrid networking, such as in the following example:

**Specify a hybrid networking configuration**

```
apiVersion: operator.openshift.io/v1
kind: Network
metadata:
  name: cluster
spec:
  defaultNetwork:
    ovnKubernetesConfig:
      hybridOverlayConfig:
        hybridClusterNetwork: 1
        - cidr: 10.132.0.0/14
        hostPrefix: 23
        hybridOverlayVXLANPort: 9898 2
```

- 1 Specify the CIDR configuration used for nodes on the additional overlay network. The **hybridClusterNetwork** CIDR cannot overlap with the **clusterNetwork** CIDR.
- 2 Specify a custom VXLAN port for the additional overlay network. This is required for running Windows nodes in a cluster installed on vSphere, and must not be configured for any other cloud provider. The custom port can be any open port excluding the default **4789** port. For more information on this requirement, see the Microsoft documentation on [Pod-to-pod connectivity between hosts is broken](#).

**NOTE**

Windows Server Long-Term Servicing Channel (LTSC): Windows Server 2019 is not supported on clusters with a custom **hybridOverlayVXLANPort** value because this Windows server version does not support selecting a custom VXLAN port.

4. Save the **cluster-network-03-config.yml** file and quit the text editor.
5. Optional: Back up the **manifests/cluster-network-03-config.yml** file. The installation program deletes the **manifests/** directory when creating the cluster.



## NOTE

For more information on using Linux and Windows nodes in the same cluster, see [Understanding Windows container workloads](#).

### 6.6.10. Enabling Accelerated Networking during installation

You can enable Accelerated Networking on Microsoft Azure by adding **acceleratedNetworking** to your machine set YAML file before you install the cluster.

#### Prerequisites

- You have created the **install-config.yaml** file and completed any modifications to it.
- You have created the manifests for your cluster.

#### Procedure

1. Change to the **openshift** directory within the directory that contains the installation program. The **openshift** directory contains the Kubernetes manifest files that define the worker machines. These are the three default machine set files for an Azure cluster:

#### Machine set files in **openshift** directory listing

```
99_openshift-cluster-api_worker-machineset-0.yaml
99_openshift-cluster-api_worker-machineset-1.yaml
99_openshift-cluster-api_worker-machineset-2.yaml
```

2. Add the following to the **providerSpec** field in each machine set file:

```
providerSpec:
  value:
    ...
    acceleratedNetworking: true 1
    ...
    vmSize: <azure-vm-size> 2
    ...
```

- 1 This line enables Accelerated Networking.
- 2 Specify an Azure VM size that includes at least four vCPUs. For information about VM sizes, see [Microsoft Azure documentation](#).

#### Additional resources

- For more details about Accelerated Networking, see [Accelerated Networking for Microsoft Azure VMs](#).

## 6.6.11. Deploying the cluster

You can install OpenShift Container Platform on a compatible cloud platform.



### IMPORTANT

You can run the **create cluster** command of the installation program only once, during initial installation.

### Prerequisites

- Configure an account with the cloud platform that hosts your cluster.
- Obtain the OpenShift Container Platform installation program and the pull secret for your cluster.

### Procedure

1. Change to the directory that contains the installation program and initialize the cluster deployment:

```
$ ./openshift-install create cluster --dir <installation_directory> \ 1
--log-level=info 2
```

- 1 For **<installation\_directory>**, specify the location of your customized **./install-config.yaml** file.
- 2 To view different installation details, specify **warn**, **debug**, or **error** instead of **info**.



### NOTE

If the cloud provider account that you configured on your host does not have sufficient permissions to deploy the cluster, the installation process stops, and the missing permissions are displayed.

When the cluster deployment completes, directions for accessing your cluster, including a link to its web console and credentials for the **kubeadmin** user, display in your terminal.

### Example output

```
...
INFO Install complete!
INFO To access the cluster as the system:admin user when using 'oc', run 'export
KUBECONFIG=/home/myuser/install_dir/auth/kubeconfig'
INFO Access the OpenShift web-console here: https://console-openshift-
console.apps.mycluster.example.com
INFO Login to the console with user: "kubeadmin", and password: "4vYBz-Ee6gm-ymBZj-
Wt5AL"
INFO Time elapsed: 36m22s
```

**NOTE**

The cluster access and credential information also outputs to `<installation_directory>/openshift_install.log` when an installation succeeds.

**IMPORTANT**

- The Ignition config files that the installation program generates contain certificates that expire after 24 hours, which are then renewed at that time. If the cluster is shut down before renewing the certificates and the cluster is later restarted after the 24 hours have elapsed, the cluster automatically recovers the expired certificates. The exception is that you must manually approve the pending **node-bootstrapper** certificate signing requests (CSRs) to recover kubelet certificates. See the documentation for *Recovering from expired control plane certificates* for more information.
- It is recommended that you use Ignition config files within 12 hours after they are generated because the 24-hour certificate rotates from 16 to 22 hours after the cluster is installed. By using the Ignition config files within 12 hours, you can avoid installation failure if the certificate update runs during installation.

**IMPORTANT**

You must not delete the installation program or the files that the installation program creates. Both are required to delete the cluster.

### 6.6.12. Installing the OpenShift CLI by downloading the binary

You can install the OpenShift CLI (**oc**) to interact with OpenShift Container Platform from a command-line interface. You can install **oc** on Linux, Windows, or macOS.

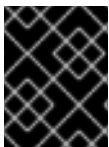
**IMPORTANT**

If you installed an earlier version of **oc**, you cannot use it to complete all of the commands in OpenShift Container Platform 4.10. Download and install the new version of **oc**.

#### Installing the OpenShift CLI on Linux

You can install the OpenShift CLI (**oc**) binary on Linux by using the following procedure.

#### Procedure

1. Navigate to the [OpenShift Container Platform downloads page](#) on the Red Hat Customer Portal.
2. Select the appropriate version in the **Version** drop-down menu.
3. Click **Download Now** next to the **OpenShift v4.10 Linux Client** entry and save the file.
4. Unpack the archive:

```
$ tar xvf <file>
```

5. Place the **oc** binary in a directory that is on your **PATH**.

To check your **PATH**, execute the following command:

```
$ echo $PATH
```

After you install the OpenShift CLI, it is available using the **oc** command:

```
$ oc <command>
```

### Installing the OpenShift CLI on Windows

You can install the OpenShift CLI (**oc**) binary on Windows by using the following procedure.

#### Procedure

1. Navigate to the [OpenShift Container Platform downloads page](#) on the Red Hat Customer Portal.
2. Select the appropriate version in the **Version** drop-down menu.
3. Click **Download Now** next to the **OpenShift v4.10 Windows Client** entry and save the file.
4. Unzip the archive with a ZIP program.
5. Move the **oc** binary to a directory that is on your **PATH**.

To check your **PATH**, open the command prompt and execute the following command:

```
C:\> path
```

After you install the OpenShift CLI, it is available using the **oc** command:

```
C:\> oc <command>
```

### Installing the OpenShift CLI on macOS

You can install the OpenShift CLI (**oc**) binary on macOS by using the following procedure.

#### Procedure

1. Navigate to the [OpenShift Container Platform downloads page](#) on the Red Hat Customer Portal.
2. Select the appropriate version in the **Version** drop-down menu.
3. Click **Download Now** next to the **OpenShift v4.10 MacOSX Client** entry and save the file.
4. Unpack and unzip the archive.
5. Move the **oc** binary to a directory on your PATH.

To check your **PATH**, open a terminal and execute the following command:

```
$ echo $PATH
```

After you install the OpenShift CLI, it is available using the **oc** command:

```
$ oc <command>
```

### 6.6.13. Logging in to the cluster by using the CLI

You can log in to your cluster as a default system user by exporting the cluster **kubeconfig** file. The **kubeconfig** file contains information about the cluster that is used by the CLI to connect a client to the correct cluster and API server. The file is specific to a cluster and is created during OpenShift Container Platform installation.

#### Prerequisites

- You deployed an OpenShift Container Platform cluster.
- You installed the **oc** CLI.

#### Procedure

1. Export the **kubeadmin** credentials:

```
$ export KUBECONFIG=<installation_directory>/auth/kubeconfig 1
```

- 1** For **<installation\_directory>**, specify the path to the directory that you stored the installation files in.

2. Verify you can run **oc** commands successfully using the exported configuration:

```
$ oc whoami
```

#### Example output

```
system:admin
```

#### Additional resources

- See [Accessing the web console](#) for more details about accessing and understanding the OpenShift Container Platform web console.

### 6.6.14. Telemetry access for OpenShift Container Platform

In OpenShift Container Platform 4.10, the Telemetry service, which runs by default to provide metrics about cluster health and the success of updates, requires internet access. If your cluster is connected to the internet, Telemetry runs automatically, and your cluster is registered to [OpenShift Cluster Manager](#).

After you confirm that your [OpenShift Cluster Manager](#) inventory is correct, either maintained automatically by Telemetry or manually by using OpenShift Cluster Manager, [use subscription watch](#) to track your OpenShift Container Platform subscriptions at the account or multi-cluster level.

#### Additional resources

- See [About remote health monitoring](#) for more information about the Telemetry service

### 6.6.15. Next steps

- [Customize your cluster](#).

- If necessary, you can [opt out of remote health reporting](#) .

## 6.7. INSTALLING A CLUSTER ON AZURE INTO AN EXISTING VNET

In OpenShift Container Platform version 4.10, you can install a cluster into an existing Azure Virtual Network (VNet) on Microsoft Azure. The installation program provisions the rest of the required infrastructure, which you can further customize. To customize the installation, you modify parameters in the **install-config.yaml** file before you install the cluster.

### 6.7.1. Prerequisites

- You reviewed details about the [OpenShift Container Platform installation and update](#) processes.
- You read the documentation on [selecting a cluster installation method and preparing it for users](#).
- You [configured an Azure account](#) to host the cluster and determined the tested and validated region to deploy the cluster to.
- If you use a firewall, you [configured it to allow the sites](#) that your cluster requires access to.
- If the cloud identity and access management (IAM) APIs are not accessible in your environment, or if you do not want to store an administrator-level credential secret in the **kube-system** namespace, you can [manually create and maintain IAM credentials](#) .

### 6.7.2. About reusing a VNet for your OpenShift Container Platform cluster

In OpenShift Container Platform 4.10, you can deploy a cluster into an existing Azure Virtual Network (VNet) in Microsoft Azure. If you do, you must also use existing subnets within the VNet and routing rules.

By deploying OpenShift Container Platform into an existing Azure VNet, you might be able to avoid service limit constraints in new accounts or more easily abide by the operational constraints that your company's guidelines set. This is a good option to use if you cannot obtain the infrastructure creation permissions that are required to create the VNet.

#### 6.7.2.1. Requirements for using your VNet

When you deploy a cluster by using an existing VNet, you must perform additional network configuration before you install the cluster. In installer-provisioned infrastructure clusters, the installer usually creates the following components, but it does not create them when you install into an existing VNet:

- Subnets
- Route tables
- VNets
- Network Security Groups



#### NOTE

The installation program requires that you use the cloud-provided DNS server. Using a custom DNS server is not supported and causes the installation to fail.



If you use a custom VNet, you must correctly configure it and its subnets for the installation program and the cluster to use. The installation program cannot subdivide network ranges for the cluster to use, set route tables for the subnets, or set VNet options like DHCP, so you must do so before you install the cluster.

The cluster must be able to access the resource group that contains the existing VNet and subnets. While all of the resources that the cluster creates are placed in a separate resource group that it creates, some network resources are used from a separate group. Some cluster Operators must be able to access resources in both resource groups. For example, the Machine API controller attaches NICS for the virtual machines that it creates to subnets from the networking resource group.

Your VNet must meet the following characteristics:

- The VNet's CIDR block must contain the **Networking.MachineCIDR** range, which is the IP address pool for cluster machines.
- The VNet and its subnets must belong to the same resource group, and the subnets must be configured to use Azure-assigned DHCP IP addresses instead of static IP addresses.

You must provide two subnets within your VNet, one for the control plane machines and one for the compute machines. Because Azure distributes machines in different availability zones within the region that you specify, your cluster will have high availability by default.



#### NOTE

By default, if you specify availability zones in the **install-config.yaml** file, the installation program distributes the control plane machines and the compute machines across [these availability zones](#) within a region. To ensure high availability for your cluster, select a region with at least three availability zones. If your region contains fewer than three availability zones, the installation program places more than one control plane machine in the available zones.

To ensure that the subnets that you provide are suitable, the installation program confirms the following data:

- All the specified subnets exist.
- There are two private subnets, one for the control plane machines and one for the compute machines.
- The subnet CIDRs belong to the machine CIDR that you specified. Machines are not provisioned in availability zones that you do not provide private subnets for. If required, the installation program creates public load balancers that manage the control plane and worker nodes, and Azure allocates a public IP address to them.



#### NOTE

If you destroy a cluster that uses an existing VNet, the VNet is not deleted.

#### 6.7.2.1.1. Network security group requirements

The network security groups for the subnets that host the compute and control plane machines require specific access to ensure that the cluster communication is correct. You must create rules to allow access to the required cluster communication ports.

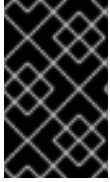

## IMPORTANT

The network security group rules must be in place before you install the cluster. If you attempt to install a cluster without the required access, the installation program cannot reach the Azure APIs, and installation fails.

Table 6.18. Required ports

Port	Description	Control plane	Compute
80	Allows HTTP traffic		x
443	Allows HTTPS traffic		x
6443	Allows communication to the control plane machines	x	
22623	Allows internal communication to the machine config server for provisioning machines	x	



## IMPORTANT

Currently, there is no supported way to block or restrict the machine config server endpoint. The machine config server must be exposed to the network so that newly-provisioned machines, which have no existing configuration or state, are able to fetch their configuration. In this model, the root of trust is the certificate signing requests (CSR) endpoint, which is where the kubelet sends its certificate signing request for approval to join the cluster. Because of this, machine configs should not be used to distribute sensitive information, such as secrets and certificates.

To ensure that the machine config server endpoints, ports 22623 and 22624, are secured in bare metal scenarios, customers must configure proper network policies.

Because cluster components do not modify the user-provided network security groups, which the Kubernetes controllers update, a pseudo-network security group is created for the Kubernetes controller to modify without impacting the rest of the environment.

### Additional resources

- [About the OpenShift SDN network plugin](#)

### 6.7.2.2. Division of permissions

Starting with OpenShift Container Platform 4.3, you do not need all of the permissions that are required for an installation program-provisioned infrastructure cluster to deploy a cluster. This change mimics the division of permissions that you might have at your company: some individuals can create different resources in your clouds than others. For example, you might be able to create application-specific items, like instances, storage, and load balancers, but not networking-related components such as VNets, subnet, or ingress rules.

The Azure credentials that you use when you create your cluster do not need the networking permissions that are required to make VNets and core networking components within the VNet, such as subnets, routing tables, internet gateways, NAT, and VPN. You still need permission to make the application

resources that the machines within the cluster require, such as load balancers, security groups, storage accounts, and nodes.

### 6.7.2.3. Isolation between clusters

Because the cluster is unable to modify network security groups in an existing subnet, there is no way to isolate clusters from each other on the VNet.

## 6.7.3. Internet access for OpenShift Container Platform

In OpenShift Container Platform 4.10, you require access to the internet to install your cluster.

You must have internet access to:

- Access [OpenShift Cluster Manager](#) to download the installation program and perform subscription management. If the cluster has internet access and you do not disable Telemetry, that service automatically entitles your cluster.
- Access [Quay.io](#) to obtain the packages that are required to install your cluster.
- Obtain the packages that are required to perform cluster updates.



### IMPORTANT

If your cluster cannot have direct internet access, you can perform a restricted network installation on some types of infrastructure that you provision. During that process, you download the required content and use it to populate a mirror registry with the installation packages. With some installation types, the environment that you install your cluster in will not require internet access. Before you update the cluster, you update the content of the mirror registry.

## 6.7.4. Generating a key pair for cluster node SSH access

During an OpenShift Container Platform installation, you can provide an SSH public key to the installation program. The key is passed to the Red Hat Enterprise Linux CoreOS (RHCOS) nodes through their Ignition config files and is used to authenticate SSH access to the nodes. The key is added to the `~/.ssh/authorized_keys` list for the **core** user on each node, which enables password-less authentication.

After the key is passed to the nodes, you can use the key pair to SSH in to the RHCOS nodes as the user **core**. To access the nodes through SSH, the private key identity must be managed by SSH for your local user.

If you want to SSH in to your cluster nodes to perform installation debugging or disaster recovery, you must provide the SSH public key during the installation process. The `./openshift-install gather` command also requires the SSH public key to be in place on the cluster nodes.

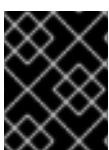

### IMPORTANT

Do not skip this procedure in production environments, where disaster recovery and debugging is required.

**NOTE**

You must use a local key, not one that you configured with platform-specific approaches such as [AWS key pairs](#).

**Procedure**

1. If you do not have an existing SSH key pair on your local machine to use for authentication onto your cluster nodes, create one. For example, on a computer that uses a Linux operating system, run the following command:

```
$ ssh-keygen -t ed25519 -N "" -f <path>/<file_name> 1
```

- 1** Specify the path and file name, such as `~/.ssh/id_ed25519`, of the new SSH key. If you have an existing key pair, ensure your public key is in the your `~/.ssh` directory.

**NOTE**

If you plan to install an OpenShift Container Platform cluster that uses FIPS validated or Modules In Process cryptographic libraries on the **x86\_64** architecture, do not create a key that uses the **ed25519** algorithm. Instead, create a key that uses the **rsa** or **ecdsa** algorithm.

2. View the public SSH key:

```
$ cat <path>/<file_name>.pub
```

For example, run the following to view the `~/.ssh/id_ed25519.pub` public key:

```
$ cat ~/.ssh/id_ed25519.pub
```

3. Add the SSH private key identity to the SSH agent for your local user, if it has not already been added. SSH agent management of the key is required for password-less SSH authentication onto your cluster nodes, or if you want to use the `./openshift-install gather` command.

**NOTE**

On some distributions, default SSH private key identities such as `~/.ssh/id_rsa` and `~/.ssh/id_dsa` are managed automatically.

- a. If the **ssh-agent** process is not already running for your local user, start it as a background task:

```
$ eval "$(ssh-agent -s)"
```

**Example output**

```
Agent pid 31874
```

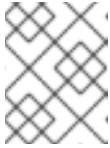
**NOTE**

If your cluster is in FIPS mode, only use FIPS-compliant algorithms to generate the SSH key. The key must be either RSA or ECDSA.

4. Add your SSH private key to the **ssh-agent**:

```
$ ssh-add <path>/<file_name> 1
```

- 1** Specify the path and file name for your SSH private key, such as `~/.ssh/id_ed25519`

**Example output**

```
Identity added: /home/<you>/<path>/<file_name> (<computer_name>)
```

**Next steps**

- When you install OpenShift Container Platform, provide the SSH public key to the installation program.

**6.7.5. Obtaining the installation program**

Before you install OpenShift Container Platform, download the installation file on a local computer.

**Prerequisites**

- You have a computer that runs Linux or macOS, with 500 MB of local disk space

**Procedure**

1. Access the [Infrastructure Provider](#) page on the OpenShift Cluster Manager site. If you have a Red Hat account, log in with your credentials. If you do not, create an account.
2. Select your infrastructure provider.
3. Navigate to the page for your installation type, download the installation program that corresponds with your host operating system and architecture, and place the file in the directory where you will store the installation configuration files.

**IMPORTANT**

The installation program creates several files on the computer that you use to install your cluster. You must keep the installation program and the files that the installation program creates after you finish installing the cluster. Both files are required to delete the cluster.

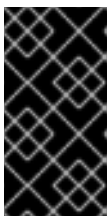
**IMPORTANT**

Deleting the files created by the installation program does not remove your cluster, even if the cluster failed during installation. To remove your cluster, complete the OpenShift Container Platform uninstallation procedures for your specific cloud provider.

4. Extract the installation program. For example, on a computer that uses a Linux operating system, run the following command:

```
$ tar -xvf openshift-install-linux.tar.gz
```

5. Download your installation [pull secret from the Red Hat OpenShift Cluster Manager](#). This pull secret allows you to authenticate with the services that are provided by the included authorities, including Quay.io, which serves the container images for OpenShift Container Platform components.

### 6.7.6. Creating the installation configuration file

You can customize the OpenShift Container Platform cluster you install on Microsoft Azure.

#### Prerequisites

- Obtain the OpenShift Container Platform installation program and the pull secret for your cluster.
- Obtain service principal permissions at the subscription level.

#### Procedure

1. Create the **install-config.yaml** file.
  - a. Change to the directory that contains the installation program and run the following command:

```
./openshift-install create install-config --dir <installation_directory> 1
```

- 1** For **<installation\_directory>**, specify the directory name to store the files that the installation program creates.



#### IMPORTANT

Specify an empty directory. Some installation assets, like bootstrap X.509 certificates have short expiration intervals, so you must not reuse an installation directory. If you want to reuse individual files from another cluster installation, you can copy them into your directory. However, the file names for the installation assets might change between releases. Use caution when copying installation files from an earlier OpenShift Container Platform version.

- b. At the prompts, provide the configuration details for your cloud:
  - i. Optional: Select an SSH key to use to access your cluster machines.



#### NOTE

For production OpenShift Container Platform clusters on which you want to perform installation debugging or disaster recovery, specify an SSH key that your **ssh-agent** process uses.

- ii. Select **azure** as the platform to target.
- iii. If you do not have a Microsoft Azure profile stored on your computer, specify the following Azure parameter values for your subscription and service principal:
  - **azure subscription id** The subscription ID to use for the cluster. Specify the **id** value in your account output.
  - **azure tenant id** The tenant ID. Specify the **tenantId** value in your account output.
  - **azure service principal client id** The value of the **appId** parameter for the service principal.
  - **azure service principal client secret** The value of the **password** parameter for the service principal.
- iv. Select the region to deploy the cluster to.
- v. Select the base domain to deploy the cluster to. The base domain corresponds to the Azure DNS Zone that you created for your cluster.
- vi. Enter a descriptive name for your cluster.



#### IMPORTANT

All Azure resources that are available through public endpoints are subject to resource name restrictions, and you cannot create resources that use certain terms. For a list of terms that Azure restricts, see [Resolve reserved resource name errors](#) in the Azure documentation.

- vii. Paste the [pull secret from the Red Hat OpenShift Cluster Manager](#) .
2. Modify the **install-config.yaml** file. You can find more information about the available parameters in the "Installation configuration parameters" section.
3. Back up the **install-config.yaml** file so that you can use it to install multiple clusters.



#### IMPORTANT

The **install-config.yaml** file is consumed during the installation process. If you want to reuse the file, you must back it up now.

### 6.7.6.1. Installation configuration parameters

Before you deploy an OpenShift Container Platform cluster, you provide parameter values to describe your account on the cloud platform that hosts your cluster and optionally customize your cluster's platform. When you create the **install-config.yaml** installation configuration file, you provide values for the required parameters through the command line. If you customize your cluster, you can modify the **install-config.yaml** file to provide more details about the platform.



#### NOTE

After installation, you cannot modify these parameters in the **install-config.yaml** file.

#### 6.7.6.1.1. Required configuration parameters

Required installation configuration parameters are described in the following table:

**Table 6.19. Required parameters**

Parameter	Description	Values
<b>apiVersion</b>	The API version for the <b>install-config.yaml</b> content. The current version is <b>v1</b> . The installer may also support older API versions.	String
<b>baseDomain</b>	The base domain of your cloud provider. The base domain is used to create routes to your OpenShift Container Platform cluster components. The full DNS name for your cluster is a combination of the <b>baseDomain</b> and <b>metadata.name</b> parameter values that uses the <b>&lt;metadata.name&gt;</b> . <b>&lt;baseDomain&gt;</b> format.	A fully-qualified domain or subdomain name, such as <b>example.com</b> .
<b>metadata</b>	Kubernetes resource <b>ObjectMeta</b> , from which only the <b>name</b> parameter is consumed.	Object
<b>metadata.name</b>	The name of the cluster. DNS records for the cluster are all subdomains of <b>{{.metadata.name}}</b> . <b>{{.baseDomain}}</b> .	String of lowercase letters, hyphens (-), and periods (.), such as <b>dev</b> .
<b>platform</b>	The configuration for the specific platform upon which to perform the installation: <b>alibabacloud</b> , <b>aws</b> , <b>baremetal</b> , <b>azure</b> , <b>gcp</b> , <b>ibmcloud</b> , <b>openstack</b> , <b>ovirt</b> , <b>vsphere</b> , or <b>{}</b> . For additional information about <b>platform.&lt;platform&gt;</b> parameters, consult the table for your specific platform that follows.	Object



Parameter	Description	Values
<b>pullSecret</b>	Get a <a href="#">pull secret from the Red Hat OpenShift Cluster Manager</a> to authenticate downloading container images for OpenShift Container Platform components from services such as Quay.io.	<pre>{   "auths":{     "cloud.openshift.com":{       "auth":"b3Blb=",       "email":"you@example.com"     },     "quay.io":{       "auth":"b3Blb=",       "email":"you@example.com"     }   } }</pre>

### 6.7.6.1.2. Network configuration parameters

You can customize your installation configuration based on the requirements of your existing network infrastructure. For example, you can expand the IP address block for the cluster network or provide different IP address blocks than the defaults.

Only IPv4 addresses are supported.

**Table 6.20. Network parameters**

Parameter	Description	Values
<b>networking</b>	The configuration for the cluster network.	Object <div style="display: flex; align-items: center; margin-top: 10px;">  <div> <p><b>NOTE</b></p> <p>You cannot modify parameters specified by the <b>networking</b> object after installation.</p> </div> </div>
<b>networking.network Type</b>	The cluster network provider Container Network Interface (CNI) plugin to install.	Either <b>OpenShiftSDN</b> or <b>OVNKubernetes</b> . <b>OpenShiftSDN</b> is a CNI provider for all-Linux networks. <b>OVNKubernetes</b> is a CNI provider for Linux networks and hybrid networks that contain both Linux and Windows servers. The default value is <b>OpenShiftSDN</b> .

Parameter	Description	Values
<b>networking.clusterNetwork</b>	<p>The IP address blocks for pods.</p> <p>The default value is <b>10.128.0.0/14</b> with a host prefix of <b>/23</b>.</p> <p>If you specify multiple IP address blocks, the blocks must not overlap.</p>	<p>An array of objects. For example:</p> <pre>networking:   clusterNetwork:     - cidr: 10.128.0.0/14       hostPrefix: 23</pre>
<b>networking.clusterNetwork.cidr</b>	<p>Required if you use <b>networking.clusterNetwork</b>. An IP address block.</p> <p>An IPv4 network.</p>	<p>An IP address block in Classless Inter-Domain Routing (CIDR) notation. The prefix length for an IPv4 block is between <b>0</b> and <b>32</b>.</p>
<b>networking.clusterNetwork.hostPrefix</b>	<p>The subnet prefix length to assign to each individual node. For example, if <b>hostPrefix</b> is set to <b>23</b> then each node is assigned a <b>/23</b> subnet out of the given <b>cidr</b>. A <b>hostPrefix</b> value of <b>23</b> provides 510 (<math>2^{(32 - 23)} - 2</math>) pod IP addresses.</p>	<p>A subnet prefix.</p> <p>The default value is <b>23</b>.</p>
<b>networking.serviceNetwork</b>	<p>The IP address block for services. The default value is <b>172.30.0.0/16</b>.</p> <p>The OpenShift SDN and OVN-Kubernetes network providers support only a single IP address block for the service network.</p>	<p>An array with an IP address block in CIDR format. For example:</p> <pre>networking:   serviceNetwork:     - 172.30.0.0/16</pre>
<b>networking.machineNetwork</b>	<p>The IP address blocks for machines.</p> <p>If you specify multiple IP address blocks, the blocks must not overlap.</p>	<p>An array of objects. For example:</p> <pre>networking:   machineNetwork:     - cidr: 10.0.0.0/16</pre>
<b>networking.machineNetwork.cidr</b>	<p>Required if you use <b>networking.machineNetwork</b>. An IP address block. The default value is <b>10.0.0.0/16</b> for all platforms other than libvirt. For libvirt, the default value is <b>192.168.126.0/24</b>.</p>	<p>An IP network block in CIDR notation.</p> <p>For example, <b>10.0.0.0/16</b>.</p> <div style="display: flex; align-items: flex-start;">  <div> <p><b>NOTE</b></p> <p>Set the <b>networking.machineNetwork</b> to match the CIDR that the preferred NIC resides in.</p> </div> </div>



## 6.7.6.1.3. Optional configuration parameters

Optional installation configuration parameters are described in the following table:

Table 6.21. Optional parameters

Parameter	Description	Values
<b>additionalTrustBundle</b>	A PEM-encoded X.509 certificate bundle that is added to the nodes' trusted certificate store. This trust bundle may also be used when a proxy has been configured.	String
<b>cgroupsV2</b>	Enables <a href="#">Linux control groups version 2</a> (cgroups v2) on specific nodes in your cluster. The OpenShift Container Platform process for enabling cgroups v2 disables all cgroup version 1 controllers and hierarchies. The OpenShift Container Platform cgroups version 2 feature is in Developer Preview and is not supported by Red Hat at this time.	<b>true</b>
<b>compute</b>	The configuration for the machines that comprise the compute nodes.	Array of <b>MachinePool</b> objects.
<b>compute.architecture</b>	Determines the instruction set architecture of the machines in the pool. Currently, clusters with varied architectures are not supported. All pools must specify the same architecture. Valid values are <b>amd64</b> (the default).	String
<b>compute.hyperthreading</b>	Whether to enable or disable simultaneous multithreading, or <b>hyperthreading</b> , on compute machines. By default, simultaneous multithreading is enabled to increase the performance of your machines' cores.	<b>Enabled</b> or <b>Disabled</b>
	 <p><b>IMPORTANT</b></p> <p>If you disable simultaneous multithreading, ensure that your capacity planning accounts for the dramatically decreased machine performance.</p>	

Parameter	Description	Values
<b>compute.name</b>	Required if you use <b>compute</b> . The name of the machine pool.	<b>worker</b>
<b>compute.platform</b>	Required if you use <b>compute</b> . Use this parameter to specify the cloud provider to host the worker machines. This parameter value must match the <b>controlPlane.platform</b> parameter value.	<b>alibabacloud, aws, azure, gcp, ibmcloud, openstack, ovirt, vsphere, or {}</b>
<b>compute.replicas</b>	The number of compute machines, which are also known as worker machines, to provision.	A positive integer greater than or equal to <b>2</b> . The default value is <b>3</b> .
<b>controlPlane</b>	The configuration for the machines that comprise the control plane.	Array of <b>MachinePool</b> objects.
<b>controlPlane.architecture</b>	Determines the instruction set architecture of the machines in the pool. Currently, clusters with varied architectures are not supported. All pools must specify the same architecture. Valid values are <b>amd64</b> (the default).	String
<b>controlPlane.hyperthreading</b>	<p>Whether to enable or disable simultaneous multithreading, or <b>hyperthreading</b>, on control plane machines. By default, simultaneous multithreading is enabled to increase the performance of your machines' cores.</p> <div style="display: flex; align-items: flex-start;"> <div style="width: 30px; height: 40px; background: repeating-linear-gradient(45deg, transparent, transparent 2px, black 2px, black 4px); margin-right: 10px;"></div> <div> <p><b>IMPORTANT</b></p> <p>If you disable simultaneous multithreading, ensure that your capacity planning accounts for the dramatically decreased machine performance.</p> </div> </div>	<b>Enabled</b> or <b>Disabled</b>
<b>controlPlane.name</b>	Required if you use <b>controlPlane</b> . The name of the machine pool.	<b>master</b>

Parameter	Description	Values
<b>controlPlane.platform</b>	Required if you use <b>controlPlane</b> . Use this parameter to specify the cloud provider that hosts the control plane machines. This parameter value must match the <b>compute.platform</b> parameter value.	<b>alibabacloud, aws, azure, gcp, ibmcloud, openstack, ovirt, vsphere</b> , or {}
<b>controlPlane.replicas</b>	The number of control plane machines to provision.	The only supported value is <b>3</b> , which is the default value.
<b>credentialsMode</b>	<p>The Cloud Credential Operator (CCO) mode. If no mode is specified, the CCO dynamically tries to determine the capabilities of the provided credentials, with a preference for mint mode on the platforms where multiple modes are supported.</p> <div style="display: flex; align-items: flex-start;"> <div style="flex: 1;">  </div> <div style="flex: 2;"> <p><b>NOTE</b></p> <p>Not all CCO modes are supported for all cloud providers. For more information on CCO modes, see the <i>Cloud Credential Operator</i> entry in the <i>Cluster Operators reference</i> content.</p> </div> </div> <div style="display: flex; align-items: flex-start; margin-top: 10px;"> <div style="flex: 1;">  </div> <div style="flex: 2;"> <p><b>NOTE</b></p> <p>If your AWS account has service control policies (SCP) enabled, you must configure the <b>credentialsMode</b> parameter to <b>Mint, Passthrough</b> or <b>Manual</b>.</p> </div> </div>	<b>Mint, Passthrough, Manual</b> or an empty string ("").

Parameter	Description	Values
<b>fips</b>	<p>Enable or disable FIPS mode. The default is <b>false</b> (disabled). If FIPS mode is enabled, the Red Hat Enterprise Linux CoreOS (RHCOS) machines that OpenShift Container Platform runs on bypass the default Kubernetes cryptography suite and use the cryptography modules that are provided with RHCOS instead.</p> <div data-bbox="486 584 593 1361" style="background-color: black; color: white; padding: 5px; margin-bottom: 10px;"> <p><b>IMPORTANT</b></p> <p>To enable FIPS mode for your cluster, you must run the installation program from a Red Hat Enterprise Linux (RHEL) computer configured to operate in FIPS mode. For more information about configuring FIPS mode on RHEL, see <a href="#">Installing the system in FIPS mode</a>. The use of FIPS validated or Modules In Process cryptographic libraries is only supported on OpenShift Container Platform deployments on the <b>x86_64</b> architecture.</p> </div> <div data-bbox="486 1406 593 1608" style="background-color: black; color: white; padding: 5px;"> <p><b>NOTE</b></p> <p>If you are using Azure File storage, you cannot enable FIPS mode.</p> </div>	<b>false</b> or <b>true</b>

Parameter	Description	Values
<b>imageContentSources</b>	Sources and repositories for the release-image content.	Array of objects. Includes a <b>source</b> and, optionally, <b>mirrors</b> , as described in the following rows of this table.
<b>imageContentSources.source</b>	Required if you use <b>imageContentSources</b> . Specify the repository that users refer to, for example, in image pull specifications.	String
<b>imageContentSources.mirrors</b>	Specify one or more repositories that may also contain the same images.	Array of strings
<b>publish</b>	How to publish or expose the user-facing endpoints of your cluster, such as the Kubernetes API, OpenShift routes.	<b>Internal</b> or <b>External</b> . To deploy a private cluster, which cannot be accessed from the internet, set <b>publish</b> to <b>Internal</b> . The default value is <b>External</b> .
<b>sshKey</b>	The SSH key or keys to authenticate access your cluster machines.   <p><b>NOTE</b></p> <p>For production OpenShift Container Platform clusters on which you want to perform installation debugging or disaster recovery, specify an SSH key that your <b>ssh-agent</b> process uses.</p>	One or more keys. For example:  <pre>sshKey:   &lt;key1&gt;   &lt;key2&gt;   &lt;key3&gt;</pre>

#### 6.7.6.1.4. Additional Azure configuration parameters

Additional Azure configuration parameters are described in the following table.



#### NOTE

By default, if you specify availability zones in the **install-config.yaml** file, the installation program distributes the control plane machines and the compute machines across [these availability zones](#) within [a region](#). To ensure high availability for your cluster, select a region with at least three availability zones. If your region contains fewer than three availability zones, the installation program places more than one control plane machine in the available zones.

Table 6.22. Additional Azure parameters

Parameter	Description	Values
<b>compute.platform.azure.osDisk.diskSizeGB</b>	The Azure disk size for the VM.	Integer that represents the size of the disk in GB. The default is <b>128</b> .
<b>compute.platform.azure.osDisk.diskType</b>	Defines the type of disk.	<b>standard_LRS</b> , <b>premium_LRS</b> , or <b>standardSSD_LRS</b> . The default is <b>premium_LRS</b> .
<b>controlPlane.platform.azure.osDisk.diskSizeGB</b>	The Azure disk size for the VM.	Integer that represents the size of the disk in GB. The default is <b>1024</b> .
<b>controlPlane.platform.azure.osDisk.diskType</b>	Defines the type of disk.	<b>premium_LRS</b> or <b>standardSSD_LRS</b> . The default is <b>premium_LRS</b> .
<b>platform.azure.baseDomainResourceGroupName</b>	The name of the resource group that contains the DNS zone for your base domain.	String, for example <b>production_cluster</b> .
<b>platform.azure.resourceGroupName</b>	The name of an already existing resource group to install your cluster to. This resource group must be empty and only used for this specific cluster; the cluster components assume ownership of all resources in the resource group. If you limit the service principal scope of the installation program to this resource group, you must ensure all other resources used by the installation program in your environment have the necessary permissions, such as the public DNS zone and virtual network. Destroying the cluster by using the installation program deletes this resource group.	String, for example <b>existing_resource_group</b> .
<b>platform.azure.outboundType</b>	The outbound routing strategy used to connect your cluster to the internet. If you are using user-defined routing, you must have pre-existing networking available where the outbound routing has already been configured prior to installing a cluster. The installation program is not responsible for configuring user-defined routing.	<b>LoadBalancer</b> or <b>UserDefinedRouting</b> . The default is <b>LoadBalancer</b> .
<b>platform.azure.region</b>	The name of the Azure region that hosts your cluster.	Any valid region name, such as <b>centralus</b> .



Parameter	Description	Values
<b>platform.azure.zone</b>	List of availability zones to place machines in. For high availability, specify at least two zones.	List of zones, for example ["1", "2", "3"].
<b>platform.azure.networkResourceGroupName</b>	The name of the resource group that contains the existing VNet that you want to deploy your cluster to. This name cannot be the same as the <b>platform.azure.baseDomainResourceGroupName</b> .	String.
<b>platform.azure.virtualNetwork</b>	The name of the existing VNet that you want to deploy your cluster to.	String.
<b>platform.azure.controlPlaneSubnet</b>	The name of the existing subnet in your VNet that you want to deploy your control plane machines to.	Valid CIDR, for example <b>10.0.0.0/16</b> .
<b>platform.azure.computeSubnet</b>	The name of the existing subnet in your VNet that you want to deploy your compute machines to.	Valid CIDR, for example <b>10.0.0.0/16</b> .
<b>platform.azure.cloudName</b>	The name of the Azure cloud environment that is used to configure the Azure SDK with the appropriate Azure API endpoints. If empty, the default value <b>AzurePublicCloud</b> is used.	Any valid cloud environment, such as <b>AzurePublicCloud</b> or <b>AzureUSGovernmentCloud</b> .

**NOTE**

You cannot customize [Azure Availability Zones](#) or [Use tags to organize your Azure resources](#) with an Azure cluster.

### 6.7.6.2. Minimum resource requirements for cluster installation

Each cluster machine must meet the following minimum requirements:

**Table 6.23. Minimum resource requirements**

Machine	Operating System	vCPU [1]	Virtual RAM	Storage	IOPS [2]
Bootstrap	RHCOS	4	16 GB	100 GB	300
Control plane	RHCOS	4	16 GB	100 GB	300

Machine	Operating System	vCPU [1]	Virtual RAM	Storage	IOPS [2]
Compute	RHCOS, RHEL 8.4, or RHEL 8.5 [3]	2	8 GB	100 GB	300

1. One vCPU is equivalent to one physical core when simultaneous multithreading (SMT), or hyperthreading, is not enabled. When enabled, use the following formula to calculate the corresponding ratio: (threads per core × cores) × sockets = vCPUs.
2. OpenShift Container Platform and Kubernetes are sensitive to disk performance, and faster storage is recommended, particularly for etcd on the control plane nodes which require a 10 ms p99 fsync duration. Note that on many cloud platforms, storage size and IOPS scale together, so you might need to over-allocate storage volume to obtain sufficient performance.
3. As with all user-provisioned installations, if you choose to use RHEL compute machines in your cluster, you take responsibility for all operating system life cycle management and maintenance, including performing system updates, applying patches, and completing all other required tasks. Use of RHEL 7 compute machines is deprecated and has been removed in OpenShift Container Platform 4.10 and later.

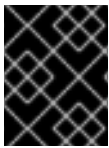

### IMPORTANT

You are required to use Azure virtual machines with **premiumIO** set to **true**. The machines must also have the **hyperVGeneration** property contain **V1**.

If an instance type for your platform meets the minimum requirements for cluster machines, it is supported to use in OpenShift Container Platform.

#### 6.7.6.3. Tested instance types for Azure

The following Microsoft Azure instance types have been tested with OpenShift Container Platform.

##### Example 6.3. Machine types

- **c4.\***
- **c5.\***
- **c5a.\***
- **i3.\***
- **m4.\***
- **m5.\***
- **m5a.\***
- **m6i.\***

- r4.\*
- r5.\*
- r5a.\*
- r6i.\*
- t3.\*
- t3a.\*

#### 6.7.6.4. Sample customized install-config.yaml file for Azure

You can customize the **install-config.yaml** file to specify more details about your OpenShift Container Platform cluster's platform or modify the values of the required parameters.

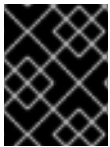

#### IMPORTANT

This sample YAML file is provided for reference only. You must obtain your **install-config.yaml** file by using the installation program and modify it.

```

apiVersion: v1
baseDomain: example.com 1
controlPlane: 2
  hyperthreading: Enabled 3 4
  name: master
  platform:
    azure:
      osDisk:
        diskSizeGB: 1024 5
        diskType: Premium_LRS
        type: Standard_D8s_v3
      replicas: 3
compute: 6
- hyperthreading: Enabled 7
  name: worker
  platform:
    azure:
      type: Standard_D2s_v3
      osDisk:
        diskSizeGB: 512 8
        diskType: Standard_LRS
      zones: 9
      - "1"
      - "2"
      - "3"
    replicas: 5
metadata:
  name: test-cluster 10
networking:
  clusterNetwork:

```

```

- cidr: 10.128.0.0/14
  hostPrefix: 23
machineNetwork:
- cidr: 10.0.0.0/16
networkType: OpenShiftSDN
serviceNetwork:
- 172.30.0.0/16
platform:
  azure:
    baseDomainResourceGroupName: resource_group 11
    region: centralus 12
    resourceGroupName: existing_resource_group 13
    networkResourceGroupName: vnet_resource_group 14
    virtualNetwork: vnet 15
    controlPlaneSubnet: control_plane_subnet 16
    computeSubnet: compute_subnet 17
    outboundType: Loadbalancer
    cloudName: AzurePublicCloud
  pullSecret: '{"auths": ...}' 18
  fips: false 19
  sshKey: ssh-ed25519 AAAA... 20

```

1 10 12 18 Required. The installation program prompts you for this value.

2 6 If you do not provide these parameters and values, the installation program provides the default value.

3 7 The **controlPlane** section is a single mapping, but the **compute** section is a sequence of mappings. To meet the requirements of the different data structures, the first line of the **compute** section must begin with a hyphen, -, and the first line of the **controlPlane** section must not. Only one control plane pool is used.

4 Whether to enable or disable simultaneous multithreading, or **hypertreading**. By default, simultaneous multithreading is enabled to increase the performance of your machines' cores. You can disable it by setting the parameter value to **Disabled**. If you disable simultaneous multithreading in some cluster machines, you must disable it in all cluster machines.



### IMPORTANT

If you disable simultaneous multithreading, ensure that your capacity planning accounts for the dramatically decreased machine performance. Use larger virtual machine types, such as **Standard\_D8s\_v3**, for your machines if you disable simultaneous multithreading.

5 8 You can specify the size of the disk to use in GB. Minimum recommendation for control plane nodes is 1024 GB.

9 Specify a list of zones to deploy your machines to. For high availability, specify at least two zones.

11 Specify the name of the resource group that contains the DNS zone for your base domain.

13 Specify the name of an already existing resource group to install your cluster to. If undefined, a new resource group is created for the cluster.

- 14 If you use an existing VNet, specify the name of the resource group that contains it.
- 15 If you use an existing VNet, specify its name.
- 16 If you use an existing VNet, specify the name of the subnet to host the control plane machines.
- 17 If you use an existing VNet, specify the name of the subnet to host the compute machines.
- 19 Whether to enable or disable FIPS mode. By default, FIPS mode is not enabled. If FIPS mode is enabled, the Red Hat Enterprise Linux CoreOS (RHCOS) machines that OpenShift Container Platform runs on bypass the default Kubernetes cryptography suite and use the cryptography modules that are provided with RHCOS instead.



### IMPORTANT

To enable FIPS mode for your cluster, you must run the installation program from a Red Hat Enterprise Linux (RHEL) computer configured to operate in FIPS mode. For more information about configuring FIPS mode on RHEL, see [Installing the system in FIPS mode](#). The use of FIPS validated or Modules In Process cryptographic libraries is only supported on OpenShift Container Platform deployments on the **x86\_64** architecture.

- 20 You can optionally provide the **sshKey** value that you use to access the machines in your cluster.



### NOTE

For production OpenShift Container Platform clusters on which you want to perform installation debugging or disaster recovery, specify an SSH key that your **ssh-agent** process uses.

#### 6.7.6.5. Configuring the cluster-wide proxy during installation

Production environments can deny direct access to the internet and instead have an HTTP or HTTPS proxy available. You can configure a new OpenShift Container Platform cluster to use a proxy by configuring the proxy settings in the **install-config.yaml** file.

#### Prerequisites

- You have an existing **install-config.yaml** file.
- You reviewed the sites that your cluster requires access to and determined whether any of them need to bypass the proxy. By default, all cluster egress traffic is proxied, including calls to hosting cloud provider APIs. You added sites to the **Proxy** object's **spec.noProxy** field to bypass the proxy if necessary.



## NOTE

The **Proxy** object **status.noProxy** field is populated with the values of the **networking.machineNetwork[].cidr**, **networking.clusterNetwork[].cidr**, and **networking.serviceNetwork[]** fields from your installation configuration.

For installations on Amazon Web Services (AWS), Google Cloud Platform (GCP), Microsoft Azure, and Red Hat OpenStack Platform (RHOSP), the **Proxy** object **status.noProxy** field is also populated with the instance metadata endpoint (**169.254.169.254**).

## Procedure

1. Edit your **install-config.yaml** file and add the proxy settings. For example:

```
apiVersion: v1
baseDomain: my.domain.com
proxy:
  httpProxy: http://<username>:<pswd>@<ip>:<port> 1
  httpsProxy: https://<username>:<pswd>@<ip>:<port> 2
  noProxy: example.com 3
  additionalTrustBundle: | 4
    -----BEGIN CERTIFICATE-----
    <MY_TRUSTED_CA_CERT>
    -----END CERTIFICATE-----
  ...
```

- 1 A proxy URL to use for creating HTTP connections outside the cluster. The URL scheme must be **http**.
- 2 A proxy URL to use for creating HTTPS connections outside the cluster.
- 3 A comma-separated list of destination domain names, IP addresses, or other network CIDRs to exclude from proxying. Preface a domain with **.** to match subdomains only. For example, **.y.com** matches **x.y.com**, but not **y.com**. Use **\*** to bypass the proxy for all destinations.
- 4 If provided, the installation program generates a config map that is named **user-ca-bundle** in the **openshift-config** namespace that contains one or more additional CA certificates that are required for proxying HTTPS connections. The Cluster Network Operator then creates a **trusted-ca-bundle** config map that merges these contents with the Red Hat Enterprise Linux CoreOS (RHCOS) trust bundle, and this config map is referenced in the **trustedCA** field of the **Proxy** object. The **additionalTrustBundle** field is required unless the proxy's identity certificate is signed by an authority from the RHCOS trust bundle.



## NOTE

The installation program does not support the proxy **readinessEndpoints** field.

**NOTE**

If the installer times out, restart and then complete the deployment by using the **wait-for** command of the installer. For example:

```
$ ./openshift-install wait-for install-complete --log-level debug
```

2. Save the file and reference it when installing OpenShift Container Platform.

The installation program creates a cluster-wide proxy that is named **cluster** that uses the proxy settings in the provided **install-config.yaml** file. If no proxy settings are provided, a **cluster Proxy** object is still created, but it will have a nil **spec**.

**NOTE**

Only the **Proxy** object named **cluster** is supported, and no additional proxies can be created.

### 6.7.7. Enabling Accelerated Networking during installation

You can enable Accelerated Networking on Microsoft Azure by adding **acceleratedNetworking** to your machine set YAML file before you install the cluster.

#### Prerequisites

- You have created the **install-config.yaml** file and completed any modifications to it.
- You have created the manifests for your cluster.

#### Procedure

1. Change to the **openshift** directory within the directory that contains the installation program. The **openshift** directory contains the Kubernetes manifest files that define the worker machines. These are the three default machine set files for an Azure cluster:

#### Machine set files in **openshift** directory listing

```
99_openshift-cluster-api_worker-machineset-0.yaml
99_openshift-cluster-api_worker-machineset-1.yaml
99_openshift-cluster-api_worker-machineset-2.yaml
```

2. Add the following to the **providerSpec** field in each machine set file:

```
providerSpec:
  value:
    ...
    acceleratedNetworking: true 1
    ...
    vmSize: <azure-vm-size> 2
    ...
```

- 1** This line enables Accelerated Networking.

- 2 Specify an Azure VM size that includes at least four vCPUs. For information about VM sizes, see [Microsoft Azure documentation](#).

### Additional resources

- For more details about Accelerated Networking, see [Accelerated Networking for Microsoft Azure VMs](#).

## 6.7.8. Deploying the cluster

You can install OpenShift Container Platform on a compatible cloud platform.

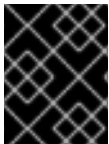

### IMPORTANT

You can run the **create cluster** command of the installation program only once, during initial installation.

### Prerequisites

- Configure an account with the cloud platform that hosts your cluster.
- Obtain the OpenShift Container Platform installation program and the pull secret for your cluster.

### Procedure

1. Change to the directory that contains the installation program and initialize the cluster deployment:

```
$ ./openshift-install create cluster --dir <installation_directory> \ 1
--log-level=info 2
```

- 1 For **<installation\_directory>**, specify the location of your customized **./install-config.yaml** file.
- 2 To view different installation details, specify **warn**, **debug**, or **error** instead of **info**.



### NOTE

If the cloud provider account that you configured on your host does not have sufficient permissions to deploy the cluster, the installation process stops, and the missing permissions are displayed.

When the cluster deployment completes, directions for accessing your cluster, including a link to its web console and credentials for the **kubeadmin** user, display in your terminal.

### Example output

```
...
INFO Install complete!
INFO To access the cluster as the system:admin user when using 'oc', run 'export
```



```

KUBECONFIG=/home/myuser/install_dir/auth/kubeconfig'
INFO Access the OpenShift web-console here: https://console-openshift-
console.apps.mycluster.example.com
INFO Login to the console with user: "kubeadmin", and password: "4vYBz-Ee6gm-ymBZj-
Wt5AL"
INFO Time elapsed: 36m22s

```



## NOTE

The cluster access and credential information also outputs to `<installation_directory>/openshift_install.log` when an installation succeeds.

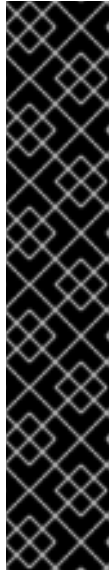

## IMPORTANT

- The Ignition config files that the installation program generates contain certificates that expire after 24 hours, which are then renewed at that time. If the cluster is shut down before renewing the certificates and the cluster is later restarted after the 24 hours have elapsed, the cluster automatically recovers the expired certificates. The exception is that you must manually approve the pending **node-bootstrapper** certificate signing requests (CSRs) to recover kubelet certificates. See the documentation for *Recovering from expired control plane certificates* for more information.
- It is recommended that you use Ignition config files within 12 hours after they are generated because the 24-hour certificate rotates from 16 to 22 hours after the cluster is installed. By using the Ignition config files within 12 hours, you can avoid installation failure if the certificate update runs during installation.

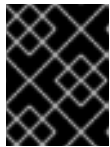

## IMPORTANT

You must not delete the installation program or the files that the installation program creates. Both are required to delete the cluster.

### 6.7.9. Installing the OpenShift CLI by downloading the binary

You can install the OpenShift CLI (**oc**) to interact with OpenShift Container Platform from a command-line interface. You can install **oc** on Linux, Windows, or macOS.

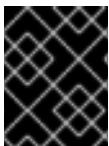

## IMPORTANT

If you installed an earlier version of **oc**, you cannot use it to complete all of the commands in OpenShift Container Platform 4.10. Download and install the new version of **oc**.

#### Installing the OpenShift CLI on Linux

You can install the OpenShift CLI (**oc**) binary on Linux by using the following procedure.

#### Procedure

1. Navigate to the [OpenShift Container Platform downloads page](#) on the Red Hat Customer Portal.
2. Select the appropriate version in the **Version** drop-down menu.

3. Click **Download Now** next to the **OpenShift v4.10 Linux Client** entry and save the file.
4. Unpack the archive:

```
$ tar xvf <file>
```

5. Place the **oc** binary in a directory that is on your **PATH**.  
To check your **PATH**, execute the following command:

```
$ echo $PATH
```

After you install the OpenShift CLI, it is available using the **oc** command:

```
$ oc <command>
```

### Installing the OpenShift CLI on Windows

You can install the OpenShift CLI (**oc**) binary on Windows by using the following procedure.

#### Procedure

1. Navigate to the [OpenShift Container Platform downloads page](#) on the Red Hat Customer Portal.
2. Select the appropriate version in the **Version** drop-down menu.
3. Click **Download Now** next to the **OpenShift v4.10 Windows Client** entry and save the file.
4. Unzip the archive with a ZIP program.
5. Move the **oc** binary to a directory that is on your **PATH**.  
To check your **PATH**, open the command prompt and execute the following command:

```
C:\> path
```

After you install the OpenShift CLI, it is available using the **oc** command:

```
C:\> oc <command>
```

### Installing the OpenShift CLI on macOS

You can install the OpenShift CLI (**oc**) binary on macOS by using the following procedure.

#### Procedure

1. Navigate to the [OpenShift Container Platform downloads page](#) on the Red Hat Customer Portal.
2. Select the appropriate version in the **Version** drop-down menu.
3. Click **Download Now** next to the **OpenShift v4.10 MacOSX Client** entry and save the file.
4. Unpack and unzip the archive.
5. Move the **oc** binary to a directory on your **PATH**.  
To check your **PATH**, open a terminal and execute the following command:

```
$ echo $PATH
```

After you install the OpenShift CLI, it is available using the **oc** command:

```
$ oc <command>
```

### 6.7.10. Logging in to the cluster by using the CLI

You can log in to your cluster as a default system user by exporting the cluster **kubeconfig** file. The **kubeconfig** file contains information about the cluster that is used by the CLI to connect a client to the correct cluster and API server. The file is specific to a cluster and is created during OpenShift Container Platform installation.

#### Prerequisites

- You deployed an OpenShift Container Platform cluster.
- You installed the **oc** CLI.

#### Procedure

1. Export the **kubeadmin** credentials:

```
$ export KUBECONFIG=<installation_directory>/auth/kubeconfig 1
```

- 1** For **<installation\_directory>**, specify the path to the directory that you stored the installation files in.

2. Verify you can run **oc** commands successfully using the exported configuration:

```
$ oc whoami
```

#### Example output

```
system:admin
```

#### Additional resources

- See [Accessing the web console](#) for more details about accessing and understanding the OpenShift Container Platform web console.

### 6.7.11. Telemetry access for OpenShift Container Platform

In OpenShift Container Platform 4.10, the Telemetry service, which runs by default to provide metrics about cluster health and the success of updates, requires internet access. If your cluster is connected to the internet, Telemetry runs automatically, and your cluster is registered to [OpenShift Cluster Manager](#).

After you confirm that your [OpenShift Cluster Manager](#) inventory is correct, either maintained automatically by Telemetry or manually by using OpenShift Cluster Manager, [use subscription watch](#) to track your OpenShift Container Platform subscriptions at the account or multi-cluster level.

## Additional resources

- See [About remote health monitoring](#) for more information about the Telemetry service

## 6.7.12. Next steps

- [Customize your cluster.](#)
- If necessary, you can [opt out of remote health reporting](#) .

## 6.8. INSTALLING A PRIVATE CLUSTER ON AZURE

In OpenShift Container Platform version 4.10, you can install a private cluster into an existing Azure Virtual Network (VNet) on Microsoft Azure. The installation program provisions the rest of the required infrastructure, which you can further customize. To customize the installation, you modify parameters in the **install-config.yaml** file before you install the cluster.

### 6.8.1. Prerequisites

- You reviewed details about the [OpenShift Container Platform installation and update](#) processes.
- You read the documentation on [selecting a cluster installation method and preparing it for users](#).
- You [configured an Azure account](#) to host the cluster and determined the tested and validated region to deploy the cluster to.
- If you use a firewall, you [configured it to allow the sites](#) that your cluster requires access to.
- If the cloud identity and access management (IAM) APIs are not accessible in your environment, or if you do not want to store an administrator-level credential secret in the **kube-system** namespace, you can [manually create and maintain IAM credentials](#) .

### 6.8.2. Private clusters

You can deploy a private OpenShift Container Platform cluster that does not expose external endpoints. Private clusters are accessible from only an internal network and are not visible to the internet.

By default, OpenShift Container Platform is provisioned to use publicly-accessible DNS and endpoints. A private cluster sets the DNS, Ingress Controller, and API server to private when you deploy your cluster. This means that the cluster resources are only accessible from your internal network and are not visible to the internet.



#### IMPORTANT

If the cluster has any public subnets, load balancer services created by administrators might be publicly accessible. To ensure cluster security, verify that these services are explicitly annotated as private.

To deploy a private cluster, you must:

- Use existing networking that meets your requirements. Your cluster resources might be shared between other clusters on the network.

- Deploy from a machine that has access to:
  - The API services for the cloud to which you provision.
  - The hosts on the network that you provision.
  - The internet to obtain installation media.

You can use any machine that meets these access requirements and follows your company's guidelines. For example, this machine can be a bastion host on your cloud network or a machine that has access to the network through a VPN.

### 6.8.2.1. Private clusters in Azure

To create a private cluster on Microsoft Azure, you must provide an existing private VNet and subnets to host the cluster. The installation program must also be able to resolve the DNS records that the cluster requires. The installation program configures the Ingress Operator and API server for only internal traffic.

Depending how your network connects to the private VNET, you might need to use a DNS forwarder to resolve the cluster's private DNS records. The cluster's machines use **168.63.129.16** internally for DNS resolution. For more information, see [What is Azure Private DNS?](#) and [What is IP address 168.63.129.16?](#) in the Azure documentation.

The cluster still requires access to internet to access the Azure APIs.

The following items are not required or created when you install a private cluster:

- A **BaseDomainResourceGroup**, since the cluster does not create public records
- Public IP addresses
- Public DNS records
- Public endpoints

The cluster is configured so that the Operators do not create public records for the cluster and all cluster machines are placed in the private subnets that you specify.

#### 6.8.2.1.1. Limitations

Private clusters on Azure are subject to only the limitations that are associated with the use of an existing VNet.

### 6.8.2.2. User-defined outbound routing

In OpenShift Container Platform, you can choose your own outbound routing for a cluster to connect to the internet. This allows you to skip the creation of public IP addresses and the public load balancer.

You can configure user-defined routing by modifying parameters in the **install-config.yaml** file before installing your cluster. A pre-existing VNet is required to use outbound routing when installing a cluster; the installation program is not responsible for configuring this.

When configuring a cluster to use user-defined routing, the installation program does not create the following resources:

- Outbound rules for access to the internet.
- Public IPs for the public load balancer.
- Kubernetes Service object to add the cluster machines to the public load balancer for outbound requests.

You must ensure the following items are available before setting user-defined routing:

- Egress to the internet is possible to pull container images, unless using an OpenShift image registry mirror.
- The cluster can access Azure APIs.
- Various allowlist endpoints are configured. You can reference these endpoints in the *Configuring your firewall* section.

There are several pre-existing networking setups that are supported for internet access using user-defined routing.

#### **Private cluster with network address translation**

You can use [Azure VNET network address translation \(NAT\)](#) to provide outbound internet access for the subnets in your cluster. You can reference [Create a NAT gateway using Azure CLI](#) in the Azure documentation for configuration instructions.

When using a VNet setup with Azure NAT and user-defined routing configured, you can create a private cluster with no public endpoints.

#### **Private cluster with Azure Firewall**

You can use Azure Firewall to provide outbound routing for the VNet used to install the cluster. You can learn more about [providing user-defined routing with Azure Firewall](#) in the Azure documentation.

When using a VNet setup with Azure Firewall and user-defined routing configured, you can create a private cluster with no public endpoints.

#### **Private cluster with a proxy configuration**

You can use a proxy with user-defined routing to allow egress to the internet. You must ensure that cluster Operators do not access Azure APIs using a proxy; Operators must have access to Azure APIs outside of the proxy.

When using the default route table for subnets, with **0.0.0.0/0** populated automatically by Azure, all Azure API requests are routed over Azure's internal network even though the IP addresses are public. As long as the Network Security Group rules allow egress to Azure API endpoints, proxies with user-defined routing configured allow you to create private clusters with no public endpoints.

#### **Private cluster with no internet access**

You can install a private network that restricts all access to the internet, except the Azure API. This is accomplished by mirroring the release image registry locally. Your cluster must have access to the following:

- An OpenShift image registry mirror that allows for pulling container images
- Access to Azure APIs

With these requirements available, you can use user-defined routing to create private clusters with no public endpoints.

### 6.8.3. About reusing a VNet for your OpenShift Container Platform cluster

In OpenShift Container Platform 4.10, you can deploy a cluster into an existing Azure Virtual Network (VNet) in Microsoft Azure. If you do, you must also use existing subnets within the VNet and routing rules.

By deploying OpenShift Container Platform into an existing Azure VNet, you might be able to avoid service limit constraints in new accounts or more easily abide by the operational constraints that your company's guidelines set. This is a good option to use if you cannot obtain the infrastructure creation permissions that are required to create the VNet.

#### 6.8.3.1. Requirements for using your VNet

When you deploy a cluster by using an existing VNet, you must perform additional network configuration before you install the cluster. In installer-provisioned infrastructure clusters, the installer usually creates the following components, but it does not create them when you install into an existing VNet:

- Subnets
- Route tables
- VNets
- Network Security Groups

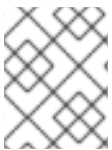

#### NOTE

The installation program requires that you use the cloud-provided DNS server. Using a custom DNS server is not supported and causes the installation to fail.

If you use a custom VNet, you must correctly configure it and its subnets for the installation program and the cluster to use. The installation program cannot subdivide network ranges for the cluster to use, set route tables for the subnets, or set VNet options like DHCP, so you must do so before you install the cluster.

The cluster must be able to access the resource group that contains the existing VNet and subnets. While all of the resources that the cluster creates are placed in a separate resource group that it creates, some network resources are used from a separate group. Some cluster Operators must be able to access resources in both resource groups. For example, the Machine API controller attaches NICs for the virtual machines that it creates to subnets from the networking resource group.

Your VNet must meet the following characteristics:

- The VNet's CIDR block must contain the **Networking.MachineCIDR** range, which is the IP address pool for cluster machines.
- The VNet and its subnets must belong to the same resource group, and the subnets must be configured to use Azure-assigned DHCP IP addresses instead of static IP addresses.

You must provide two subnets within your VNet, one for the control plane machines and one for the compute machines. Because Azure distributes machines in different availability zones within the region that you specify, your cluster will have high availability by default.

**NOTE**

By default, if you specify availability zones in the **install-config.yaml** file, the installation program distributes the control plane machines and the compute machines across [these availability zones](#) within [a region](#). To ensure high availability for your cluster, select a region with at least three availability zones. If your region contains fewer than three availability zones, the installation program places more than one control plane machine in the available zones.

To ensure that the subnets that you provide are suitable, the installation program confirms the following data:

- All the specified subnets exist.
- There are two private subnets, one for the control plane machines and one for the compute machines.
- The subnet CIDRs belong to the machine CIDR that you specified. Machines are not provisioned in availability zones that you do not provide private subnets for.

**NOTE**

If you destroy a cluster that uses an existing VNet, the VNet is not deleted.

**6.8.3.1.1. Network security group requirements**

The network security groups for the subnets that host the compute and control plane machines require specific access to ensure that the cluster communication is correct. You must create rules to allow access to the required cluster communication ports.

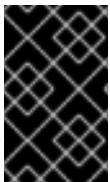
**IMPORTANT**

The network security group rules must be in place before you install the cluster. If you attempt to install a cluster without the required access, the installation program cannot reach the Azure APIs, and installation fails.

**Table 6.24. Required ports**

Port	Description	Control plane	Compute
<b>80</b>	Allows HTTP traffic		x
<b>443</b>	Allows HTTPS traffic		x
<b>6443</b>	Allows communication to the control plane machines	x	
<b>22623</b>	Allows internal communication to the machine config server for provisioning machines	x	



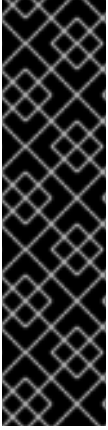

## IMPORTANT

Currently, there is no supported way to block or restrict the machine config server endpoint. The machine config server must be exposed to the network so that newly-provisioned machines, which have no existing configuration or state, are able to fetch their configuration. In this model, the root of trust is the certificate signing requests (CSR) endpoint, which is where the kubelet sends its certificate signing request for approval to join the cluster. Because of this, machine configs should not be used to distribute sensitive information, such as secrets and certificates.

To ensure that the machine config server endpoints, ports 22623 and 22624, are secured in bare metal scenarios, customers must configure proper network policies.

Because cluster components do not modify the user-provided network security groups, which the Kubernetes controllers update, a pseudo-network security group is created for the Kubernetes controller to modify without impacting the rest of the environment.

### Additional resources

- [About the OpenShift SDN network plugin](#)

### 6.8.3.2. Division of permissions

Starting with OpenShift Container Platform 4.3, you do not need all of the permissions that are required for an installation program-provisioned infrastructure cluster to deploy a cluster. This change mimics the division of permissions that you might have at your company: some individuals can create different resources in your clouds than others. For example, you might be able to create application-specific items, like instances, storage, and load balancers, but not networking-related components such as VNets, subnet, or ingress rules.

The Azure credentials that you use when you create your cluster do not need the networking permissions that are required to make VNets and core networking components within the VNet, such as subnets, routing tables, internet gateways, NAT, and VPN. You still need permission to make the application resources that the machines within the cluster require, such as load balancers, security groups, storage accounts, and nodes.

### 6.8.3.3. Isolation between clusters

Because the cluster is unable to modify network security groups in an existing subnet, there is no way to isolate clusters from each other on the VNet.

### 6.8.4. Internet access for OpenShift Container Platform

In OpenShift Container Platform 4.10, you require access to the internet to install your cluster.

You must have internet access to:

- Access [OpenShift Cluster Manager](#) to download the installation program and perform subscription management. If the cluster has internet access and you do not disable Telemetry, that service automatically entitles your cluster.
- Access [Quay.io](#) to obtain the packages that are required to install your cluster.
- Obtain the packages that are required to perform cluster updates.

**IMPORTANT**

If your cluster cannot have direct internet access, you can perform a restricted network installation on some types of infrastructure that you provision. During that process, you download the required content and use it to populate a mirror registry with the installation packages. With some installation types, the environment that you install your cluster in will not require internet access. Before you update the cluster, you update the content of the mirror registry.

**6.8.5. Generating a key pair for cluster node SSH access**

During an OpenShift Container Platform installation, you can provide an SSH public key to the installation program. The key is passed to the Red Hat Enterprise Linux CoreOS (RHCOS) nodes through their Ignition config files and is used to authenticate SSH access to the nodes. The key is added to the `~/.ssh/authorized_keys` list for the **core** user on each node, which enables password-less authentication.

After the key is passed to the nodes, you can use the key pair to SSH in to the RHCOS nodes as the user **core**. To access the nodes through SSH, the private key identity must be managed by SSH for your local user.

If you want to SSH in to your cluster nodes to perform installation debugging or disaster recovery, you must provide the SSH public key during the installation process. The `./openshift-install gather` command also requires the SSH public key to be in place on the cluster nodes.

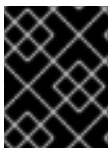
**IMPORTANT**

Do not skip this procedure in production environments, where disaster recovery and debugging is required.

**NOTE**

You must use a local key, not one that you configured with platform-specific approaches such as [AWS key pairs](#).

**Procedure**

1. If you do not have an existing SSH key pair on your local machine to use for authentication onto your cluster nodes, create one. For example, on a computer that uses a Linux operating system, run the following command:

```
$ ssh-keygen -t ed25519 -N "" -f <path>/<file_name> 1
```

- 1 Specify the path and file name, such as `~/.ssh/id_ed25519`, of the new SSH key. If you have an existing key pair, ensure your public key is in the your `~/.ssh` directory.

**NOTE**

If you plan to install an OpenShift Container Platform cluster that uses FIPS validated or Modules In Progress cryptographic libraries on the **x86\_64** architecture, do not create a key that uses the **ed25519** algorithm. Instead, create a key that uses the **rsa** or **ecdsa** algorithm.

- View the public SSH key:

```
$ cat <path>/<file_name>.pub
```

For example, run the following to view the `~/.ssh/id_ed25519.pub` public key:

```
$ cat ~/.ssh/id_ed25519.pub
```

- Add the SSH private key identity to the SSH agent for your local user, if it has not already been added. SSH agent management of the key is required for password-less SSH authentication onto your cluster nodes, or if you want to use the `./openshift-install gather` command.



#### NOTE

On some distributions, default SSH private key identities such as `~/.ssh/id_rsa` and `~/.ssh/id_dsa` are managed automatically.

- If the `ssh-agent` process is not already running for your local user, start it as a background task:

```
$ eval "$(ssh-agent -s)"
```

#### Example output

```
Agent pid 31874
```



#### NOTE

If your cluster is in FIPS mode, only use FIPS-compliant algorithms to generate the SSH key. The key must be either RSA or ECDSA.

- Add your SSH private key to the `ssh-agent`:

```
$ ssh-add <path>/<file_name> 1
```

- 1** Specify the path and file name for your SSH private key, such as `~/.ssh/id_ed25519`

#### Example output

```
Identity added: /home/<you>/<path>/<file_name> (<computer_name>)
```

#### Next steps

- When you install OpenShift Container Platform, provide the SSH public key to the installation program.

### 6.8.6. Obtaining the installation program

Before you install OpenShift Container Platform, download the installation file on a local computer.

## Prerequisites

- You have a computer that runs Linux or macOS, with 500 MB of local disk space

## Procedure

1. Access the [Infrastructure Provider](#) page on the OpenShift Cluster Manager site. If you have a Red Hat account, log in with your credentials. If you do not, create an account.
2. Select your infrastructure provider.
3. Navigate to the page for your installation type, download the installation program that corresponds with your host operating system and architecture, and place the file in the directory where you will store the installation configuration files.

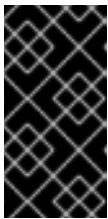

### IMPORTANT

The installation program creates several files on the computer that you use to install your cluster. You must keep the installation program and the files that the installation program creates after you finish installing the cluster. Both files are required to delete the cluster.



### IMPORTANT

Deleting the files created by the installation program does not remove your cluster, even if the cluster failed during installation. To remove your cluster, complete the OpenShift Container Platform uninstallation procedures for your specific cloud provider.

4. Extract the installation program. For example, on a computer that uses a Linux operating system, run the following command:

```
$ tar -xvf openshift-install-linux.tar.gz
```

5. Download your installation [pull secret from the Red Hat OpenShift Cluster Manager](#) . This pull secret allows you to authenticate with the services that are provided by the included authorities, including Quay.io, which serves the container images for OpenShift Container Platform components.

## 6.8.7. Manually creating the installation configuration file

For installations of a private OpenShift Container Platform cluster that are only accessible from an internal network and are not visible to the internet, you must manually generate your installation configuration file.

## Prerequisites

- You have an SSH public key on your local machine to provide to the installation program. The key will be used for SSH authentication onto your cluster nodes for debugging and disaster recovery.
- You have obtained the OpenShift Container Platform installation program and the pull secret for your cluster.

## Procedure

**Procedure**

1. Create an installation directory to store your required installation assets in:

```
$ mkdir <installation_directory>
```

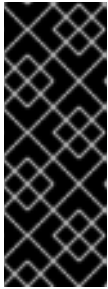
**IMPORTANT**

You must create a directory. Some installation assets, like bootstrap X.509 certificates have short expiration intervals, so you must not reuse an installation directory. If you want to reuse individual files from another cluster installation, you can copy them into your directory. However, the file names for the installation assets might change between releases. Use caution when copying installation files from an earlier OpenShift Container Platform version.

2. Customize the sample **install-config.yaml** file template that is provided and save it in the **<installation\_directory>**.

**NOTE**

You must name this configuration file **install-config.yaml**.

**NOTE**

For some platform types, you can alternatively run **./openshift-install create install-config --dir <installation\_directory>** to generate an **install-config.yaml** file. You can provide details about your cluster configuration at the prompts.

3. Back up the **install-config.yaml** file so that you can use it to install multiple clusters.

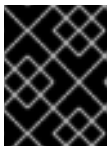
**IMPORTANT**

The **install-config.yaml** file is consumed during the next step of the installation process. You must back it up now.

**6.8.7.1. Installation configuration parameters**

Before you deploy an OpenShift Container Platform cluster, you provide parameter values to describe your account on the cloud platform that hosts your cluster and optionally customize your cluster's platform. When you create the **install-config.yaml** installation configuration file, you provide values for the required parameters through the command line. If you customize your cluster, you can modify the **install-config.yaml** file to provide more details about the platform.

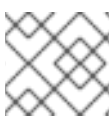
**NOTE**

After installation, you cannot modify these parameters in the **install-config.yaml** file.

**6.8.7.1.1. Required configuration parameters**

Required installation configuration parameters are described in the following table:

**Table 6.25. Required parameters**

Parameter	Description	Values
<b>apiVersion</b>	The API version for the <b>install-config.yaml</b> content. The current version is <b>v1</b> . The installer may also support older API versions.	String
<b>baseDomain</b>	The base domain of your cloud provider. The base domain is used to create routes to your OpenShift Container Platform cluster components. The full DNS name for your cluster is a combination of the <b>baseDomain</b> and <b>metadata.name</b> parameter values that uses the <b>&lt;metadata.name&gt;.&lt;baseDomain&gt;</b> format.	A fully-qualified domain or subdomain name, such as <b>example.com</b> .
<b>metadata</b>	Kubernetes resource <b>ObjectMeta</b> , from which only the <b>name</b> parameter is consumed.	Object
<b>metadata.name</b>	The name of the cluster. DNS records for the cluster are all subdomains of <b>{{.metadata.name}}</b> . <b>{{.baseDomain}}</b> .	String of lowercase letters, hyphens (-), and periods (.), such as <b>dev</b> .
<b>platform</b>	The configuration for the specific platform upon which to perform the installation: <b>alibabacloud</b> , <b>aws</b> , <b>baremetal</b> , <b>azure</b> , <b>gcp</b> , <b>ibmcloud</b> , <b>openstack</b> , <b>ovirt</b> , <b>vsphere</b> , or <b>{}</b> . For additional information about <b>platform.&lt;platform&gt;</b> parameters, consult the table for your specific platform that follows.	Object

Parameter	Description	Values
<b>pullSecret</b>	Get a <a href="#">pull secret from the Red Hat OpenShift Cluster Manager</a> to authenticate downloading container images for OpenShift Container Platform components from services such as Quay.io.	<pre>{   "auths":{     "cloud.openshift.com":{       "auth":"b3Blb=",       "email":"you@example.com"     },     "quay.io":{       "auth":"b3Blb=",       "email":"you@example.com"     }   } }</pre>

#### 6.8.7.1.2. Network configuration parameters

You can customize your installation configuration based on the requirements of your existing network infrastructure. For example, you can expand the IP address block for the cluster network or provide different IP address blocks than the defaults.

Only IPv4 addresses are supported.

**Table 6.26. Network parameters**

Parameter	Description	Values
<b>networking</b>	The configuration for the cluster network.	Object <div style="display: flex; align-items: center; margin-top: 10px;">  <div> <p><b>NOTE</b></p> <p>You cannot modify parameters specified by the <b>networking</b> object after installation.</p> </div> </div>
<b>networking.networkType</b>	The cluster network provider Container Network Interface (CNI) plugin to install.	Either <b>OpenShiftSDN</b> or <b>OVNKubernetes</b> . <b>OpenShiftSDN</b> is a CNI provider for all-Linux networks. <b>OVNKubernetes</b> is a CNI provider for Linux networks and hybrid networks that contain both Linux and Windows servers. The default value is <b>OpenShiftSDN</b> .

Parameter	Description	Values
<b>networking.clusterNetwork</b>	<p>The IP address blocks for pods.</p> <p>The default value is <b>10.128.0.0/14</b> with a host prefix of <b>/23</b>.</p> <p>If you specify multiple IP address blocks, the blocks must not overlap.</p>	<p>An array of objects. For example:</p> <pre>networking:   clusterNetwork:     - cidr: 10.128.0.0/14       hostPrefix: 23</pre>
<b>networking.clusterNetwork.cidr</b>	<p>Required if you use <b>networking.clusterNetwork</b>. An IP address block.</p> <p>An IPv4 network.</p>	<p>An IP address block in Classless Inter-Domain Routing (CIDR) notation. The prefix length for an IPv4 block is between <b>0</b> and <b>32</b>.</p>
<b>networking.clusterNetwork.hostPrefix</b>	<p>The subnet prefix length to assign to each individual node. For example, if <b>hostPrefix</b> is set to <b>23</b> then each node is assigned a <b>/23</b> subnet out of the given <b>cidr</b>. A <b>hostPrefix</b> value of <b>23</b> provides 510 (<math>2^{(32 - 23)} - 2</math>) pod IP addresses.</p>	<p>A subnet prefix.</p> <p>The default value is <b>23</b>.</p>
<b>networking.serviceNetwork</b>	<p>The IP address block for services. The default value is <b>172.30.0.0/16</b>.</p> <p>The OpenShift SDN and OVN-Kubernetes network providers support only a single IP address block for the service network.</p>	<p>An array with an IP address block in CIDR format. For example:</p> <pre>networking:   serviceNetwork:     - 172.30.0.0/16</pre>
<b>networking.machineNetwork</b>	<p>The IP address blocks for machines.</p> <p>If you specify multiple IP address blocks, the blocks must not overlap.</p>	<p>An array of objects. For example:</p> <pre>networking:   machineNetwork:     - cidr: 10.0.0.0/16</pre>
<b>networking.machineNetwork.cidr</b>	<p>Required if you use <b>networking.machineNetwork</b>. An IP address block. The default value is <b>10.0.0.0/16</b> for all platforms other than libvirt. For libvirt, the default value is <b>192.168.126.0/24</b>.</p>	<p>An IP network block in CIDR notation.</p> <p>For example, <b>10.0.0.0/16</b>.</p> <div style="display: flex; align-items: flex-start;">  <div> <p><b>NOTE</b></p> <p>Set the <b>networking.machineNetwork</b> to match the CIDR that the preferred NIC resides in.</p> </div> </div>





## 6.8.7.1.3. Optional configuration parameters

Optional installation configuration parameters are described in the following table:

Table 6.27. Optional parameters

Parameter	Description	Values
<b>additionalTrustBundle</b>	A PEM-encoded X.509 certificate bundle that is added to the nodes' trusted certificate store. This trust bundle may also be used when a proxy has been configured.	String
<b>cgroupsV2</b>	Enables <a href="#">Linux control groups version 2</a> (cgroups v2) on specific nodes in your cluster. The OpenShift Container Platform process for enabling cgroups v2 disables all cgroup version 1 controllers and hierarchies. The OpenShift Container Platform cgroups version 2 feature is in Developer Preview and is not supported by Red Hat at this time.	<b>true</b>
<b>compute</b>	The configuration for the machines that comprise the compute nodes.	Array of <b>MachinePool</b> objects.
<b>compute.architecture</b>	Determines the instruction set architecture of the machines in the pool. Currently, clusters with varied architectures are not supported. All pools must specify the same architecture. Valid values are <b>amd64</b> (the default).	String
<b>compute.hyperthreading</b>	Whether to enable or disable simultaneous multithreading, or <b>hyperthreading</b> , on compute machines. By default, simultaneous multithreading is enabled to increase the performance of your machines' cores.	<b>Enabled</b> or <b>Disabled</b>
	 <p><b>IMPORTANT</b></p> <p>If you disable simultaneous multithreading, ensure that your capacity planning accounts for the dramatically decreased machine performance.</p>	

Parameter	Description	Values
<b>compute.name</b>	Required if you use <b>compute</b> . The name of the machine pool.	<b>worker</b>
<b>compute.platform</b>	Required if you use <b>compute</b> . Use this parameter to specify the cloud provider to host the worker machines. This parameter value must match the <b>controlPlane.platform</b> parameter value.	<b>alibabacloud, aws, azure, gcp, ibmcloud, openstack, ovirt, vsphere, or {}</b>
<b>compute.replicas</b>	The number of compute machines, which are also known as worker machines, to provision.	A positive integer greater than or equal to <b>2</b> . The default value is <b>3</b> .
<b>controlPlane</b>	The configuration for the machines that comprise the control plane.	Array of <b>MachinePool</b> objects.
<b>controlPlane.architecture</b>	Determines the instruction set architecture of the machines in the pool. Currently, clusters with varied architectures are not supported. All pools must specify the same architecture. Valid values are <b>amd64</b> (the default).	String
<b>controlPlane.hyperthreading</b>	<p>Whether to enable or disable simultaneous multithreading, or <b>hyperthreading</b>, on control plane machines. By default, simultaneous multithreading is enabled to increase the performance of your machines' cores.</p> <div style="display: flex; align-items: center;">  <div> <p><b>IMPORTANT</b></p> <p>If you disable simultaneous multithreading, ensure that your capacity planning accounts for the dramatically decreased machine performance.</p> </div> </div>	<b>Enabled</b> or <b>Disabled</b>
<b>controlPlane.name</b>	Required if you use <b>controlPlane</b> . The name of the machine pool.	<b>master</b>

Parameter	Description	Values
<b>controlPlane.platform</b>	Required if you use <b>controlPlane</b> . Use this parameter to specify the cloud provider that hosts the control plane machines. This parameter value must match the <b>compute.platform</b> parameter value.	<b>alibabacloud, aws, azure, gcp, ibmcloud, openstack, ovirt, vsphere</b> , or <b>{}</b>
<b>controlPlane.replicas</b>	The number of control plane machines to provision.	The only supported value is <b>3</b> , which is the default value.
<b>credentialsMode</b>	<p>The Cloud Credential Operator (CCO) mode. If no mode is specified, the CCO dynamically tries to determine the capabilities of the provided credentials, with a preference for mint mode on the platforms where multiple modes are supported.</p> <div style="display: flex; align-items: flex-start;"> <div style="flex: 1;">  </div> <div style="flex: 2;"> <p><b>NOTE</b></p> <p>Not all CCO modes are supported for all cloud providers. For more information on CCO modes, see the <i>Cloud Credential Operator</i> entry in the <i>Cluster Operators reference</i> content.</p> </div> </div> <div style="display: flex; align-items: flex-start; margin-top: 10px;"> <div style="flex: 1;">  </div> <div style="flex: 2;"> <p><b>NOTE</b></p> <p>If your AWS account has service control policies (SCP) enabled, you must configure the <b>credentialsMode</b> parameter to <b>Mint</b>, <b>Passthrough</b> or <b>Manual</b>.</p> </div> </div>	<b>Mint, Passthrough, Manual</b> or an empty string ( <b>""</b> ).

Parameter	Description	Values
<b>fips</b>	<p>Enable or disable FIPS mode. The default is <b>false</b> (disabled). If FIPS mode is enabled, the Red Hat Enterprise Linux CoreOS (RHCOS) machines that OpenShift Container Platform runs on bypass the default Kubernetes cryptography suite and use the cryptography modules that are provided with RHCOS instead.</p> <div data-bbox="486 584 592 1361" style="background-color: black; color: white; padding: 5px; margin-bottom: 10px;"> <p><b>IMPORTANT</b></p> <p>To enable FIPS mode for your cluster, you must run the installation program from a Red Hat Enterprise Linux (RHEL) computer configured to operate in FIPS mode. For more information about configuring FIPS mode on RHEL, see <a href="#">Installing the system in FIPS mode</a>. The use of FIPS validated or Modules In Process cryptographic libraries is only supported on OpenShift Container Platform deployments on the <b>x86_64</b> architecture.</p> </div> <div data-bbox="486 1406 592 1608" style="background-color: black; color: white; padding: 5px;"> <p><b>NOTE</b></p> <p>If you are using Azure File storage, you cannot enable FIPS mode.</p> </div>	<b>false</b> or <b>true</b>

Parameter	Description	Values
<b>imageContentSources</b>	Sources and repositories for the release-image content.	Array of objects. Includes a <b>source</b> and, optionally, <b>mirrors</b> , as described in the following rows of this table.
<b>imageContentSources.source</b>	Required if you use <b>imageContentSources</b> . Specify the repository that users refer to, for example, in image pull specifications.	String
<b>imageContentSources.mirrors</b>	Specify one or more repositories that may also contain the same images.	Array of strings
<b>publish</b>	How to publish or expose the user-facing endpoints of your cluster, such as the Kubernetes API, OpenShift routes.	<b>Internal</b> or <b>External</b> . To deploy a private cluster, which cannot be accessed from the internet, set <b>publish</b> to <b>Internal</b> . The default value is <b>External</b> .
<b>sshKey</b>	<p>The SSH key or keys to authenticate access your cluster machines.</p>  <p><b>NOTE</b></p> <p>For production OpenShift Container Platform clusters on which you want to perform installation debugging or disaster recovery, specify an SSH key that your <b>ssh-agent</b> process uses.</p>	<p>One or more keys. For example:</p> <pre>sshKey:   &lt;key1&gt;   &lt;key2&gt;   &lt;key3&gt;</pre>

#### 6.8.7.1.4. Additional Azure configuration parameters

Additional Azure configuration parameters are described in the following table.



#### NOTE

By default, if you specify availability zones in the **install-config.yaml** file, the installation program distributes the control plane machines and the compute machines across [these availability zones](#) within [a region](#). To ensure high availability for your cluster, select a region with at least three availability zones. If your region contains fewer than three availability zones, the installation program places more than one control plane machine in the available zones.

Table 6.28. Additional Azure parameters

Parameter	Description	Values
<b>compute.platform.azure.osDisk.diskSizeGB</b>	The Azure disk size for the VM.	Integer that represents the size of the disk in GB. The default is <b>128</b> .
<b>compute.platform.azure.osDisk.diskType</b>	Defines the type of disk.	<b>standard_LRS</b> , <b>premium_LRS</b> , or <b>standardSSD_LRS</b> . The default is <b>premium_LRS</b> .
<b>controlPlane.platform.azure.osDisk.diskSizeGB</b>	The Azure disk size for the VM.	Integer that represents the size of the disk in GB. The default is <b>1024</b> .
<b>controlPlane.platform.azure.osDisk.diskType</b>	Defines the type of disk.	<b>premium_LRS</b> or <b>standardSSD_LRS</b> . The default is <b>premium_LRS</b> .
<b>platform.azure.baseDomainResourceGroupName</b>	The name of the resource group that contains the DNS zone for your base domain.	String, for example <b>production_cluster</b> .
<b>platform.azure.resourceGroupName</b>	The name of an already existing resource group to install your cluster to. This resource group must be empty and only used for this specific cluster; the cluster components assume ownership of all resources in the resource group. If you limit the service principal scope of the installation program to this resource group, you must ensure all other resources used by the installation program in your environment have the necessary permissions, such as the public DNS zone and virtual network. Destroying the cluster by using the installation program deletes this resource group.	String, for example <b>existing_resource_group</b> .
<b>platform.azure.outboundType</b>	The outbound routing strategy used to connect your cluster to the internet. If you are using user-defined routing, you must have pre-existing networking available where the outbound routing has already been configured prior to installing a cluster. The installation program is not responsible for configuring user-defined routing.	<b>LoadBalancer</b> or <b>UserDefinedRouting</b> . The default is <b>LoadBalancer</b> .
<b>platform.azure.region</b>	The name of the Azure region that hosts your cluster.	Any valid region name, such as <b>centralus</b> .

Parameter	Description	Values
<b>platform.azure.zone</b>	List of availability zones to place machines in. For high availability, specify at least two zones.	List of zones, for example ["1", "2", "3"].
<b>platform.azure.networkResourceGroupName</b>	The name of the resource group that contains the existing VNet that you want to deploy your cluster to. This name cannot be the same as the <b>platform.azure.baseDomainResourceGroupName</b> .	String.
<b>platform.azure.virtualNetwork</b>	The name of the existing VNet that you want to deploy your cluster to.	String.
<b>platform.azure.controlPlaneSubnet</b>	The name of the existing subnet in your VNet that you want to deploy your control plane machines to.	Valid CIDR, for example <b>10.0.0.0/16</b> .
<b>platform.azure.computeSubnet</b>	The name of the existing subnet in your VNet that you want to deploy your compute machines to.	Valid CIDR, for example <b>10.0.0.0/16</b> .
<b>platform.azure.cloudName</b>	The name of the Azure cloud environment that is used to configure the Azure SDK with the appropriate Azure API endpoints. If empty, the default value <b>AzurePublicCloud</b> is used.	Any valid cloud environment, such as <b>AzurePublicCloud</b> or <b>AzureUSGovernmentCloud</b> .

**NOTE**

You cannot customize [Azure Availability Zones](#) or [Use tags to organize your Azure resources](#) with an Azure cluster.

### 6.8.7.2. Minimum resource requirements for cluster installation

Each cluster machine must meet the following minimum requirements:

**Table 6.29. Minimum resource requirements**

Machine	Operating System	vCPU [1]	Virtual RAM	Storage	IOPS [2]
Bootstrap	RHCOS	4	16 GB	100 GB	300
Control plane	RHCOS	4	16 GB	100 GB	300

Machine	Operating System	vCPU [1]	Virtual RAM	Storage	IOPS [2]
Compute	RHCOS, RHEL 8.4, or RHEL 8.5 [3]	2	8 GB	100 GB	300

1. One vCPU is equivalent to one physical core when simultaneous multithreading (SMT), or hyperthreading, is not enabled. When enabled, use the following formula to calculate the corresponding ratio: (threads per core × cores) × sockets = vCPUs.
2. OpenShift Container Platform and Kubernetes are sensitive to disk performance, and faster storage is recommended, particularly for etcd on the control plane nodes which require a 10 ms p99 fsync duration. Note that on many cloud platforms, storage size and IOPS scale together, so you might need to over-allocate storage volume to obtain sufficient performance.
3. As with all user-provisioned installations, if you choose to use RHEL compute machines in your cluster, you take responsibility for all operating system life cycle management and maintenance, including performing system updates, applying patches, and completing all other required tasks. Use of RHEL 7 compute machines is deprecated and has been removed in OpenShift Container Platform 4.10 and later.

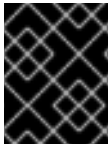

### IMPORTANT

You are required to use Azure virtual machines with **premiumIO** set to **true**. The machines must also have the **hyperVGeneration** property contain **V1**.

If an instance type for your platform meets the minimum requirements for cluster machines, it is supported to use in OpenShift Container Platform.

#### 6.8.7.3. Tested instance types for Azure

The following Microsoft Azure instance types have been tested with OpenShift Container Platform.

##### Example 6.4. Machine types

- **c4.\***
- **c5.\***
- **c5a.\***
- **i3.\***
- **m4.\***
- **m5.\***
- **m5a.\***
- **m6i.\***



- r4.\*
- r5.\*
- r5a.\*
- r6i.\*
- t3.\*
- t3a.\*

#### 6.8.7.4. Sample customized install-config.yaml file for Azure

You can customize the **install-config.yaml** file to specify more details about your OpenShift Container Platform cluster's platform or modify the values of the required parameters.

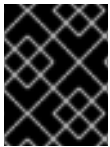

#### IMPORTANT

This sample YAML file is provided for reference only. You must obtain your **install-config.yaml** file by using the installation program and modify it.

```

apiVersion: v1
baseDomain: example.com 1
controlPlane: 2
  hyperthreading: Enabled 3 4
  name: master
  platform:
    azure:
      osDisk:
        diskSizeGB: 1024 5
        diskType: Premium_LRS
        type: Standard_D8s_v3
      replicas: 3
compute: 6
- hyperthreading: Enabled 7
  name: worker
  platform:
    azure:
      type: Standard_D2s_v3
      osDisk:
        diskSizeGB: 512 8
        diskType: Standard_LRS
      zones: 9
      - "1"
      - "2"
      - "3"
    replicas: 5
metadata:
  name: test-cluster 10
networking:
  clusterNetwork:

```

```

- cidr: 10.128.0.0/14
  hostPrefix: 23
machineNetwork:
- cidr: 10.0.0.0/16
networkType: OpenShiftSDN
serviceNetwork:
- 172.30.0.0/16
platform:
  azure:
    baseDomainResourceGroupName: resource_group 11
    region: centralus 12
    resourceGroupName: existing_resource_group 13
    networkResourceGroupName: vnet_resource_group 14
    virtualNetwork: vnet 15
    controlPlaneSubnet: control_plane_subnet 16
    computeSubnet: compute_subnet 17
    outboundType: UserDefinedRouting 18
    cloudName: AzurePublicCloud
  pullSecret: '{"auths": ...}' 19
  fips: false 20
  sshKey: ssh-ed25519 AAAA... 21
  publish: Internal 22

```

1 10 12 19 Required. The installation program prompts you for this value.

2 6 If you do not provide these parameters and values, the installation program provides the default value.

3 7 The **controlPlane** section is a single mapping, but the **compute** section is a sequence of mappings. To meet the requirements of the different data structures, the first line of the **compute** section must begin with a hyphen, -, and the first line of the **controlPlane** section must not. Only one control plane pool is used.

4 Whether to enable or disable simultaneous multithreading, or **hyperthreading**. By default, simultaneous multithreading is enabled to increase the performance of your machines' cores. You can disable it by setting the parameter value to **Disabled**. If you disable simultaneous multithreading in some cluster machines, you must disable it in all cluster machines.



### IMPORTANT

If you disable simultaneous multithreading, ensure that your capacity planning accounts for the dramatically decreased machine performance. Use larger virtual machine types, such as **Standard\_D8s\_v3**, for your machines if you disable simultaneous multithreading.

5 8 You can specify the size of the disk to use in GB. Minimum recommendation for control plane nodes is 1024 GB.

9 Specify a list of zones to deploy your machines to. For high availability, specify at least two zones.

11 Specify the name of the resource group that contains the DNS zone for your base domain.

13 Specify the name of an already existing resource group to install your cluster to. If undefined, a new resource group is created for the cluster.

- 14 If you use an existing VNet, specify the name of the resource group that contains it.
- 15 If you use an existing VNet, specify its name.
- 16 If you use an existing VNet, specify the name of the subnet to host the control plane machines.
- 17 If you use an existing VNet, specify the name of the subnet to host the compute machines.
- 18 You can customize your own outbound routing. Configuring user-defined routing prevents exposing external endpoints in your cluster. User-defined routing for egress requires deploying your cluster to an existing VNet.
- 20 Whether to enable or disable FIPS mode. By default, FIPS mode is not enabled. If FIPS mode is enabled, the Red Hat Enterprise Linux CoreOS (RHCOS) machines that OpenShift Container Platform runs on bypass the default Kubernetes cryptography suite and use the cryptography modules that are provided with RHCOS instead.



### IMPORTANT

To enable FIPS mode for your cluster, you must run the installation program from a Red Hat Enterprise Linux (RHEL) computer configured to operate in FIPS mode. For more information about configuring FIPS mode on RHEL, see [Installing the system in FIPS mode](#). The use of FIPS validated or Modules In Process cryptographic libraries is only supported on OpenShift Container Platform deployments on the **x86\_64** architecture.

- 21 You can optionally provide the **sshKey** value that you use to access the machines in your cluster.



### NOTE

For production OpenShift Container Platform clusters on which you want to perform installation debugging or disaster recovery, specify an SSH key that your **ssh-agent** process uses.

- 22 How to publish the user-facing endpoints of your cluster. Set **publish** to **Internal** to deploy a private cluster, which cannot be accessed from the internet. The default value is **External**.

#### 6.8.7.5. Configuring the cluster-wide proxy during installation

Production environments can deny direct access to the internet and instead have an HTTP or HTTPS proxy available. You can configure a new OpenShift Container Platform cluster to use a proxy by configuring the proxy settings in the **install-config.yaml** file.

#### Prerequisites

- You have an existing **install-config.yaml** file.
- You reviewed the sites that your cluster requires access to and determined whether any of them need to bypass the proxy. By default, all cluster egress traffic is proxied, including calls to hosting cloud provider APIs. You added sites to the **Proxy** object's **spec.noProxy** field to bypass the proxy if necessary.



## NOTE

The **Proxy** object **status.noProxy** field is populated with the values of the **networking.machineNetwork[].cidr**, **networking.clusterNetwork[].cidr**, and **networking.serviceNetwork[]** fields from your installation configuration.

For installations on Amazon Web Services (AWS), Google Cloud Platform (GCP), Microsoft Azure, and Red Hat OpenStack Platform (RHOSP), the **Proxy** object **status.noProxy** field is also populated with the instance metadata endpoint (**169.254.169.254**).

## Procedure

1. Edit your **install-config.yaml** file and add the proxy settings. For example:

```
apiVersion: v1
baseDomain: my.domain.com
proxy:
  httpProxy: http://<username>:<pswd>@<ip>:<port> 1
  httpsProxy: https://<username>:<pswd>@<ip>:<port> 2
  noProxy: example.com 3
  additionalTrustBundle: | 4
    -----BEGIN CERTIFICATE-----
    <MY_TRUSTED_CA_CERT>
    -----END CERTIFICATE-----
  ...
```

- 1 A proxy URL to use for creating HTTP connections outside the cluster. The URL scheme must be **http**.
- 2 A proxy URL to use for creating HTTPS connections outside the cluster.
- 3 A comma-separated list of destination domain names, IP addresses, or other network CIDRs to exclude from proxying. Preface a domain with **.** to match subdomains only. For example, **.y.com** matches **x.y.com**, but not **y.com**. Use **\*** to bypass the proxy for all destinations.
- 4 If provided, the installation program generates a config map that is named **user-ca-bundle** in the **openshift-config** namespace that contains one or more additional CA certificates that are required for proxying HTTPS connections. The Cluster Network Operator then creates a **trusted-ca-bundle** config map that merges these contents with the Red Hat Enterprise Linux CoreOS (RHCOS) trust bundle, and this config map is referenced in the **trustedCA** field of the **Proxy** object. The **additionalTrustBundle** field is required unless the proxy's identity certificate is signed by an authority from the RHCOS trust bundle.



## NOTE

The installation program does not support the proxy **readinessEndpoints** field.

**NOTE**

If the installer times out, restart and then complete the deployment by using the **wait-for** command of the installer. For example:

```
$ ./openshift-install wait-for install-complete --log-level debug
```

2. Save the file and reference it when installing OpenShift Container Platform.

The installation program creates a cluster-wide proxy that is named **cluster** that uses the proxy settings in the provided **install-config.yaml** file. If no proxy settings are provided, a **cluster Proxy** object is still created, but it will have a nil **spec**.

**NOTE**

Only the **Proxy** object named **cluster** is supported, and no additional proxies can be created.

### 6.8.8. Enabling Accelerated Networking during installation

You can enable Accelerated Networking on Microsoft Azure by adding **acceleratedNetworking** to your machine set YAML file before you install the cluster.

#### Prerequisites

- You have created the **install-config.yaml** file and completed any modifications to it.
- You have created the manifests for your cluster.

#### Procedure

1. Change to the **openshift** directory within the directory that contains the installation program. The **openshift** directory contains the Kubernetes manifest files that define the worker machines. These are the three default machine set files for an Azure cluster:

#### Machine set files in **openshift** directory listing

```
99_openshift-cluster-api_worker-machineset-0.yaml
99_openshift-cluster-api_worker-machineset-1.yaml
99_openshift-cluster-api_worker-machineset-2.yaml
```

2. Add the following to the **providerSpec** field in each machine set file:

```
providerSpec:
  value:
    ...
    acceleratedNetworking: true 1
    ...
    vmSize: <azure-vm-size> 2
    ...
```

- 1** This line enables Accelerated Networking.

- 2 Specify an Azure VM size that includes at least four vCPUs. For information about VM sizes, see [Microsoft Azure documentation](#).

### Additional resources

- For more details about Accelerated Networking, see [Accelerated Networking for Microsoft Azure VMs](#).

## 6.8.9. Deploying the cluster

You can install OpenShift Container Platform on a compatible cloud platform.

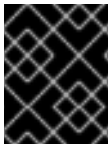

### IMPORTANT

You can run the **create cluster** command of the installation program only once, during initial installation.

### Prerequisites

- Configure an account with the cloud platform that hosts your cluster.
- Obtain the OpenShift Container Platform installation program and the pull secret for your cluster.

### Procedure

1. Change to the directory that contains the installation program and initialize the cluster deployment:

```

$ ./openshift-install create cluster --dir <installation_directory> \ 1
--log-level=info 2

```

1 For **<installation\_directory>**, specify the

2 To view different installation details, specify **warn**, **debug**, or **error** instead of **info**.



### NOTE

If the cloud provider account that you configured on your host does not have sufficient permissions to deploy the cluster, the installation process stops, and the missing permissions are displayed.

When the cluster deployment completes, directions for accessing your cluster, including a link to its web console and credentials for the **kubeadmin** user, display in your terminal.

### Example output

```

...
INFO Install complete!
INFO To access the cluster as the system:admin user when using 'oc', run 'export
KUBECONFIG=/home/myuser/install_dir/auth/kubeconfig'

```

INFO Access the OpenShift web-console here: <https://console-openshift-console.apps.mycluster.example.com>  
 INFO Login to the console with user: "kubeadmin", and password: "4vYBz-Ee6gm-ymBZj-Wt5AL"  
 INFO Time elapsed: 36m22s



## NOTE

The cluster access and credential information also outputs to `<installation_directory>/openshift_install.log` when an installation succeeds.



## IMPORTANT

- The Ignition config files that the installation program generates contain certificates that expire after 24 hours, which are then renewed at that time. If the cluster is shut down before renewing the certificates and the cluster is later restarted after the 24 hours have elapsed, the cluster automatically recovers the expired certificates. The exception is that you must manually approve the pending **node-bootstrapper** certificate signing requests (CSRs) to recover kubelet certificates. See the documentation for *Recovering from expired control plane certificates* for more information.
- It is recommended that you use Ignition config files within 12 hours after they are generated because the 24-hour certificate rotates from 16 to 22 hours after the cluster is installed. By using the Ignition config files within 12 hours, you can avoid installation failure if the certificate update runs during installation.



## IMPORTANT

You must not delete the installation program or the files that the installation program creates. Both are required to delete the cluster.

### 6.8.10. Installing the OpenShift CLI by downloading the binary

You can install the OpenShift CLI (**oc**) to interact with OpenShift Container Platform from a command-line interface. You can install **oc** on Linux, Windows, or macOS.

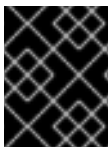

## IMPORTANT

If you installed an earlier version of **oc**, you cannot use it to complete all of the commands in OpenShift Container Platform 4.10. Download and install the new version of **oc**.

#### Installing the OpenShift CLI on Linux

You can install the OpenShift CLI (**oc**) binary on Linux by using the following procedure.

#### Procedure

1. Navigate to the [OpenShift Container Platform downloads page](#) on the Red Hat Customer Portal.
2. Select the appropriate version in the **Version** drop-down menu.
3. Click **Download Now** next to the **OpenShift v4.10 Linux Client** entry and save the file.

4. Unpack the archive:

```
$ tar xvf <file>
```

5. Place the **oc** binary in a directory that is on your **PATH**.  
To check your **PATH**, execute the following command:

```
$ echo $PATH
```

After you install the OpenShift CLI, it is available using the **oc** command:

```
$ oc <command>
```

### Installing the OpenShift CLI on Windows

You can install the OpenShift CLI (**oc**) binary on Windows by using the following procedure.

#### Procedure

1. Navigate to the [OpenShift Container Platform downloads page](#) on the Red Hat Customer Portal.
2. Select the appropriate version in the **Version** drop-down menu.
3. Click **Download Now** next to the **OpenShift v4.10 Windows Client** entry and save the file.
4. Unzip the archive with a ZIP program.
5. Move the **oc** binary to a directory that is on your **PATH**.  
To check your **PATH**, open the command prompt and execute the following command:

```
C:\> path
```

After you install the OpenShift CLI, it is available using the **oc** command:

```
C:\> oc <command>
```

### Installing the OpenShift CLI on macOS

You can install the OpenShift CLI (**oc**) binary on macOS by using the following procedure.

#### Procedure

1. Navigate to the [OpenShift Container Platform downloads page](#) on the Red Hat Customer Portal.
2. Select the appropriate version in the **Version** drop-down menu.
3. Click **Download Now** next to the **OpenShift v4.10 MacOSX Client** entry and save the file.
4. Unpack and unzip the archive.
5. Move the **oc** binary to a directory on your **PATH**.  
To check your **PATH**, open a terminal and execute the following command:



```
$ echo $PATH
```

After you install the OpenShift CLI, it is available using the **oc** command:

```
$ oc <command>
```

### 6.8.11. Logging in to the cluster by using the CLI

You can log in to your cluster as a default system user by exporting the cluster **kubeconfig** file. The **kubeconfig** file contains information about the cluster that is used by the CLI to connect a client to the correct cluster and API server. The file is specific to a cluster and is created during OpenShift Container Platform installation.

#### Prerequisites

- You deployed an OpenShift Container Platform cluster.
- You installed the **oc** CLI.

#### Procedure

1. Export the **kubeadmin** credentials:

```
$ export KUBECONFIG=<installation_directory>/auth/kubeconfig 1
```

- 1** For **<installation\_directory>**, specify the path to the directory that you stored the installation files in.

2. Verify you can run **oc** commands successfully using the exported configuration:

```
$ oc whoami
```

#### Example output

```
system:admin
```

#### Additional resources

- See [Accessing the web console](#) for more details about accessing and understanding the OpenShift Container Platform web console.

### 6.8.12. Telemetry access for OpenShift Container Platform

In OpenShift Container Platform 4.10, the Telemetry service, which runs by default to provide metrics about cluster health and the success of updates, requires internet access. If your cluster is connected to the internet, Telemetry runs automatically, and your cluster is registered to [OpenShift Cluster Manager](#).

After you confirm that your [OpenShift Cluster Manager](#) inventory is correct, either maintained automatically by Telemetry or manually by using OpenShift Cluster Manager, [use subscription watch](#) to track your OpenShift Container Platform subscriptions at the account or multi-cluster level.

## Additional resources

- See [About remote health monitoring](#) for more information about the Telemetry service

### 6.8.13. Next steps

- [Customize your cluster.](#)
- If necessary, you can [opt out of remote health reporting](#) .

## 6.9. INSTALLING A CLUSTER ON AZURE INTO A GOVERNMENT REGION

In OpenShift Container Platform version 4.10, you can install a cluster on Microsoft Azure into a government region. To configure the government region, you modify parameters in the **install-config.yaml** file before you install the cluster.

### 6.9.1. Prerequisites

- You reviewed details about the [OpenShift Container Platform installation and update](#) processes.
- You read the documentation on [selecting a cluster installation method and preparing it for users](#).
- You [configured an Azure account](#) to host the cluster and determined the tested and validated government region to deploy the cluster to.
- If you use a firewall, you [configured it to allow the sites](#) that your cluster requires access to.
- If the cloud identity and access management (IAM) APIs are not accessible in your environment, or if you do not want to store an administrator-level credential secret in the **kube-system** namespace, you can [manually create and maintain IAM credentials](#) .

### 6.9.2. Azure government regions

OpenShift Container Platform supports deploying a cluster to [Microsoft Azure Government \(MAG\)](#) regions. MAG is specifically designed for US government agencies at the federal, state, and local level, as well as contractors, educational institutions, and other US customers that must run sensitive workloads on Azure. MAG is composed of government-only data center regions, all granted an [Impact Level 5 Provisional Authorization](#).

Installing to a MAG region requires manually configuring the Azure Government dedicated cloud instance and region in the **install-config.yaml** file. You must also update your service principal to reference the appropriate government environment.

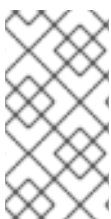

#### NOTE

The Azure government region cannot be selected using the guided terminal prompts from the installation program. You must define the region manually in the **install-config.yaml** file. Remember to also set the dedicated cloud instance, like **AzureUSGovernmentCloud**, based on the region specified.

### 6.9.3. Private clusters

You can deploy a private OpenShift Container Platform cluster that does not expose external endpoints. Private clusters are accessible from only an internal network and are not visible to the internet.

By default, OpenShift Container Platform is provisioned to use publicly-accessible DNS and endpoints. A private cluster sets the DNS, Ingress Controller, and API server to private when you deploy your cluster. This means that the cluster resources are only accessible from your internal network and are not visible to the internet.



### IMPORTANT

If the cluster has any public subnets, load balancer services created by administrators might be publicly accessible. To ensure cluster security, verify that these services are explicitly annotated as private.

To deploy a private cluster, you must:

- Use existing networking that meets your requirements. Your cluster resources might be shared between other clusters on the network.
- Deploy from a machine that has access to:
  - The API services for the cloud to which you provision.
  - The hosts on the network that you provision.
  - The internet to obtain installation media.

You can use any machine that meets these access requirements and follows your company's guidelines. For example, this machine can be a bastion host on your cloud network or a machine that has access to the network through a VPN.

#### 6.9.3.1. Private clusters in Azure

To create a private cluster on Microsoft Azure, you must provide an existing private VNet and subnets to host the cluster. The installation program must also be able to resolve the DNS records that the cluster requires. The installation program configures the Ingress Operator and API server for only internal traffic.

Depending how your network connects to the private VNET, you might need to use a DNS forwarder to resolve the cluster's private DNS records. The cluster's machines use **168.63.129.16** internally for DNS resolution. For more information, see [What is Azure Private DNS?](#) and [What is IP address 168.63.129.16?](#) in the Azure documentation.

The cluster still requires access to internet to access the Azure APIs.

The following items are not required or created when you install a private cluster:

- A **BaseDomainResourceGroup**, since the cluster does not create public records
- Public IP addresses
- Public DNS records
- Public endpoints

The cluster is configured so that the Operators do not create public records for the cluster and all cluster machines are placed in the private subnets that you specify.

#### 6.9.3.1.1. Limitations

Private clusters on Azure are subject to only the limitations that are associated with the use of an existing VNet.

#### 6.9.3.2. User-defined outbound routing

In OpenShift Container Platform, you can choose your own outbound routing for a cluster to connect to the internet. This allows you to skip the creation of public IP addresses and the public load balancer.

You can configure user-defined routing by modifying parameters in the **install-config.yaml** file before installing your cluster. A pre-existing VNet is required to use outbound routing when installing a cluster; the installation program is not responsible for configuring this.

When configuring a cluster to use user-defined routing, the installation program does not create the following resources:

- Outbound rules for access to the internet.
- Public IPs for the public load balancer.
- Kubernetes Service object to add the cluster machines to the public load balancer for outbound requests.

You must ensure the following items are available before setting user-defined routing:

- Egress to the internet is possible to pull container images, unless using an OpenShift image registry mirror.
- The cluster can access Azure APIs.
- Various allowlist endpoints are configured. You can reference these endpoints in the *Configuring your firewall* section.

There are several pre-existing networking setups that are supported for internet access using user-defined routing.

##### Private cluster with network address translation

You can use [Azure VNET network address translation \(NAT\)](#) to provide outbound internet access for the subnets in your cluster. You can reference [Create a NAT gateway using Azure CLI](#) in the Azure documentation for configuration instructions.

When using a VNet setup with Azure NAT and user-defined routing configured, you can create a private cluster with no public endpoints.

##### Private cluster with Azure Firewall

You can use Azure Firewall to provide outbound routing for the VNet used to install the cluster. You can learn more about [providing user-defined routing with Azure Firewall](#) in the Azure documentation.

When using a VNet setup with Azure Firewall and user-defined routing configured, you can create a private cluster with no public endpoints.

##### Private cluster with a proxy configuration

You can use a proxy with user-defined routing to allow egress to the internet. You must ensure that cluster Operators do not access Azure APIs using a proxy; Operators must have access to Azure APIs outside of the proxy.

When using the default route table for subnets, with **0.0.0.0/0** populated automatically by Azure, all Azure API requests are routed over Azure's internal network even though the IP addresses are public. As long as the Network Security Group rules allow egress to Azure API endpoints, proxies with user-defined routing configured allow you to create private clusters with no public endpoints.

#### Private cluster with no internet access

You can install a private network that restricts all access to the internet, except the Azure API. This is accomplished by mirroring the release image registry locally. Your cluster must have access to the following:

- An OpenShift image registry mirror that allows for pulling container images
- Access to Azure APIs

With these requirements available, you can use user-defined routing to create private clusters with no public endpoints.

### 6.9.4. About reusing a VNet for your OpenShift Container Platform cluster

In OpenShift Container Platform 4.10, you can deploy a cluster into an existing Azure Virtual Network (VNet) in Microsoft Azure. If you do, you must also use existing subnets within the VNet and routing rules.

By deploying OpenShift Container Platform into an existing Azure VNet, you might be able to avoid service limit constraints in new accounts or more easily abide by the operational constraints that your company's guidelines set. This is a good option to use if you cannot obtain the infrastructure creation permissions that are required to create the VNet.

#### 6.9.4.1. Requirements for using your VNet

When you deploy a cluster by using an existing VNet, you must perform additional network configuration before you install the cluster. In installer-provisioned infrastructure clusters, the installer usually creates the following components, but it does not create them when you install into an existing VNet:

- Subnets
- Route tables
- VNets
- Network Security Groups



#### NOTE

The installation program requires that you use the cloud-provided DNS server. Using a custom DNS server is not supported and causes the installation to fail.

If you use a custom VNet, you must correctly configure it and its subnets for the installation program and the cluster to use. The installation program cannot subdivide network ranges for the cluster to use, set route tables for the subnets, or set VNet options like DHCP, so you must do so before you install the cluster.

The cluster must be able to access the resource group that contains the existing VNet and subnets. While all of the resources that the cluster creates are placed in a separate resource group that it creates, some network resources are used from a separate group. Some cluster Operators must be able to access resources in both resource groups. For example, the Machine API controller attaches NICs for the virtual machines that it creates to subnets from the networking resource group.

Your VNet must meet the following characteristics:

- The VNet's CIDR block must contain the **Networking.MachineCIDR** range, which is the IP address pool for cluster machines.
- The VNet and its subnets must belong to the same resource group, and the subnets must be configured to use Azure-assigned DHCP IP addresses instead of static IP addresses.

You must provide two subnets within your VNet, one for the control plane machines and one for the compute machines. Because Azure distributes machines in different availability zones within the region that you specify, your cluster will have high availability by default.



#### NOTE

By default, if you specify availability zones in the **install-config.yaml** file, the installation program distributes the control plane machines and the compute machines across [these availability zones](#) within [a region](#). To ensure high availability for your cluster, select a region with at least three availability zones. If your region contains fewer than three availability zones, the installation program places more than one control plane machine in the available zones.

To ensure that the subnets that you provide are suitable, the installation program confirms the following data:

- All the specified subnets exist.
- There are two private subnets, one for the control plane machines and one for the compute machines.
- The subnet CIDRs belong to the machine CIDR that you specified. Machines are not provisioned in availability zones that you do not provide private subnets for. If required, the installation program creates public load balancers that manage the control plane and worker nodes, and Azure allocates a public IP address to them.

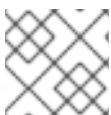

#### NOTE

If you destroy a cluster that uses an existing VNet, the VNet is not deleted.

#### 6.9.4.1.1. Network security group requirements

The network security groups for the subnets that host the compute and control plane machines require specific access to ensure that the cluster communication is correct. You must create rules to allow access to the required cluster communication ports.



#### IMPORTANT

The network security group rules must be in place before you install the cluster. If you attempt to install a cluster without the required access, the installation program cannot reach the Azure APIs, and installation fails.

Table 6.30. Required ports

Port	Description	Control plane	Compute
80	Allows HTTP traffic		x
443	Allows HTTPS traffic		x
6443	Allows communication to the control plane machines	x	
22623	Allows internal communication to the machine config server for provisioning machines	x	



### IMPORTANT

Currently, there is no supported way to block or restrict the machine config server endpoint. The machine config server must be exposed to the network so that newly-provisioned machines, which have no existing configuration or state, are able to fetch their configuration. In this model, the root of trust is the certificate signing requests (CSR) endpoint, which is where the kubelet sends its certificate signing request for approval to join the cluster. Because of this, machine configs should not be used to distribute sensitive information, such as secrets and certificates.

To ensure that the machine config server endpoints, ports 22623 and 22624, are secured in bare metal scenarios, customers must configure proper network policies.

Because cluster components do not modify the user-provided network security groups, which the Kubernetes controllers update, a pseudo-network security group is created for the Kubernetes controller to modify without impacting the rest of the environment.

#### Additional resources

- [About the OpenShift SDN network plugin](#)

#### 6.9.4.2. Division of permissions

Starting with OpenShift Container Platform 4.3, you do not need all of the permissions that are required for an installation program-provisioned infrastructure cluster to deploy a cluster. This change mimics the division of permissions that you might have at your company: some individuals can create different resources in your clouds than others. For example, you might be able to create application-specific items, like instances, storage, and load balancers, but not networking-related components such as VNets, subnet, or ingress rules.

The Azure credentials that you use when you create your cluster do not need the networking permissions that are required to make VNets and core networking components within the VNet, such as subnets, routing tables, internet gateways, NAT, and VPN. You still need permission to make the application resources that the machines within the cluster require, such as load balancers, security groups, storage accounts, and nodes.

#### 6.9.4.3. Isolation between clusters

Because the cluster is unable to modify network security groups in an existing subnet, there is no way to isolate clusters from each other on the VNet.

### 6.9.5. Internet access for OpenShift Container Platform

In OpenShift Container Platform 4.10, you require access to the internet to install your cluster.

You must have internet access to:

- Access [OpenShift Cluster Manager](#) to download the installation program and perform subscription management. If the cluster has internet access and you do not disable Telemetry, that service automatically entitles your cluster.
- Access [Quay.io](#) to obtain the packages that are required to install your cluster.
- Obtain the packages that are required to perform cluster updates.



#### IMPORTANT

If your cluster cannot have direct internet access, you can perform a restricted network installation on some types of infrastructure that you provision. During that process, you download the required content and use it to populate a mirror registry with the installation packages. With some installation types, the environment that you install your cluster in will not require internet access. Before you update the cluster, you update the content of the mirror registry.

### 6.9.6. Generating a key pair for cluster node SSH access

During an OpenShift Container Platform installation, you can provide an SSH public key to the installation program. The key is passed to the Red Hat Enterprise Linux CoreOS (RHCOS) nodes through their Ignition config files and is used to authenticate SSH access to the nodes. The key is added to the `~/.ssh/authorized_keys` list for the **core** user on each node, which enables password-less authentication.

After the key is passed to the nodes, you can use the key pair to SSH in to the RHCOS nodes as the user **core**. To access the nodes through SSH, the private key identity must be managed by SSH for your local user.

If you want to SSH in to your cluster nodes to perform installation debugging or disaster recovery, you must provide the SSH public key during the installation process. The `./openshift-install gather` command also requires the SSH public key to be in place on the cluster nodes.



#### IMPORTANT

Do not skip this procedure in production environments, where disaster recovery and debugging is required.



#### NOTE

You must use a local key, not one that you configured with platform-specific approaches such as [AWS key pairs](#).

#### Procedure



1. If you do not have an existing SSH key pair on your local machine to use for authentication onto your cluster nodes, create one. For example, on a computer that uses a Linux operating system, run the following command:

```
$ ssh-keygen -t ed25519 -N "" -f <path>/<file_name> 1
```

- 1 Specify the path and file name, such as `~/.ssh/id_ed25519`, of the new SSH key. If you have an existing key pair, ensure your public key is in the your `~/.ssh` directory.



#### NOTE

If you plan to install an OpenShift Container Platform cluster that uses FIPS validated or Modules In Process cryptographic libraries on the **x86\_64** architecture, do not create a key that uses the **ed25519** algorithm. Instead, create a key that uses the **rsa** or **ecdsa** algorithm.

2. View the public SSH key:

```
$ cat <path>/<file_name>.pub
```

For example, run the following to view the `~/.ssh/id_ed25519.pub` public key:

```
$ cat ~/.ssh/id_ed25519.pub
```

3. Add the SSH private key identity to the SSH agent for your local user, if it has not already been added. SSH agent management of the key is required for password-less SSH authentication onto your cluster nodes, or if you want to use the `./openshift-install gather` command.

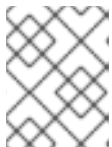

#### NOTE

On some distributions, default SSH private key identities such as `~/.ssh/id_rsa` and `~/.ssh/id_dsa` are managed automatically.

- a. If the **ssh-agent** process is not already running for your local user, start it as a background task:

```
$ eval "$(ssh-agent -s)"
```

#### Example output

```
Agent pid 31874
```



#### NOTE

If your cluster is in FIPS mode, only use FIPS-compliant algorithms to generate the SSH key. The key must be either RSA or ECDSA.

4. Add your SSH private key to the **ssh-agent**:

```
$ ssh-add <path>/<file_name> 1
```

- 1 Specify the path and file name for your SSH private key, such as `~/.ssh/id_ed25519`

### Example output

```
Identity added: /home/<you>/<path>/<file_name> (<computer_name>)
```

### Next steps

- When you install OpenShift Container Platform, provide the SSH public key to the installation program.

## 6.9.7. Obtaining the installation program

Before you install OpenShift Container Platform, download the installation file on a local computer.

### Prerequisites

- You have a computer that runs Linux or macOS, with 500 MB of local disk space

### Procedure

1. Access the [Infrastructure Provider](#) page on the OpenShift Cluster Manager site. If you have a Red Hat account, log in with your credentials. If you do not, create an account.
2. Select your infrastructure provider.
3. Navigate to the page for your installation type, download the installation program that corresponds with your host operating system and architecture, and place the file in the directory where you will store the installation configuration files.

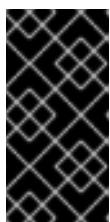

### IMPORTANT

The installation program creates several files on the computer that you use to install your cluster. You must keep the installation program and the files that the installation program creates after you finish installing the cluster. Both files are required to delete the cluster.



### IMPORTANT

Deleting the files created by the installation program does not remove your cluster, even if the cluster failed during installation. To remove your cluster, complete the OpenShift Container Platform uninstallation procedures for your specific cloud provider.

4. Extract the installation program. For example, on a computer that uses a Linux operating system, run the following command:

```
$ tar -xvf openshift-install-linux.tar.gz
```

5. Download your installation [pull secret from the Red Hat OpenShift Cluster Manager](#) . This pull secret allows you to authenticate with the services that are provided by the included authorities, including Quay.io, which serves the container images for OpenShift Container Platform

components.

### 6.9.8. Manually creating the installation configuration file

When installing OpenShift Container Platform on Microsoft Azure into a government region, you must manually generate your installation configuration file.

#### Prerequisites

- You have an SSH public key on your local machine to provide to the installation program. The key will be used for SSH authentication onto your cluster nodes for debugging and disaster recovery.
- You have obtained the OpenShift Container Platform installation program and the pull secret for your cluster.

#### Procedure

1. Create an installation directory to store your required installation assets in:

```
$ mkdir <installation_directory>
```



#### IMPORTANT

You must create a directory. Some installation assets, like bootstrap X.509 certificates have short expiration intervals, so you must not reuse an installation directory. If you want to reuse individual files from another cluster installation, you can copy them into your directory. However, the file names for the installation assets might change between releases. Use caution when copying installation files from an earlier OpenShift Container Platform version.

2. Customize the sample **install-config.yaml** file template that is provided and save it in the **<installation\_directory>**.



#### NOTE

You must name this configuration file **install-config.yaml**.

3. Back up the **install-config.yaml** file so that you can use it to install multiple clusters.

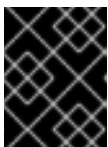

#### IMPORTANT

The **install-config.yaml** file is consumed during the next step of the installation process. You must back it up now.

#### 6.9.8.1. Installation configuration parameters

Before you deploy an OpenShift Container Platform cluster, you provide parameter values to describe your account on the cloud platform that hosts your cluster and optionally customize your cluster's platform. When you create the **install-config.yaml** installation configuration file, you provide values for the required parameters through the command line. If you customize your cluster, you can modify the **install-config.yaml** file to provide more details about the platform.

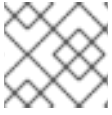
**NOTE**

After installation, you cannot modify these parameters in the **install-config.yaml** file.

**6.9.8.1.1. Required configuration parameters**

Required installation configuration parameters are described in the following table:

**Table 6.31. Required parameters**

Parameter	Description	Values
<b>apiVersion</b>	The API version for the <b>install-config.yaml</b> content. The current version is <b>v1</b> . The installer may also support older API versions.	String
<b>baseDomain</b>	The base domain of your cloud provider. The base domain is used to create routes to your OpenShift Container Platform cluster components. The full DNS name for your cluster is a combination of the <b>baseDomain</b> and <b>metadata.name</b> parameter values that uses the <b>&lt;metadata.name&gt;. &lt;baseDomain&gt;</b> format.	A fully-qualified domain or subdomain name, such as <b>example.com</b> .
<b>metadata</b>	Kubernetes resource <b>ObjectMeta</b> , from which only the <b>name</b> parameter is consumed.	Object
<b>metadata.name</b>	The name of the cluster. DNS records for the cluster are all subdomains of <b>{{.metadata.name}}</b> . <b>{{.baseDomain}}</b> .	String of lowercase letters, hyphens (-), and periods (.), such as <b>dev</b> .

Parameter	Description	Values
<b>platform</b>	The configuration for the specific platform upon which to perform the installation: <b>alibabacloud</b> , <b>aws</b> , <b>baremetal</b> , <b>azure</b> , <b>gcp</b> , <b>ibmcloud</b> , <b>openstack</b> , <b>ovirt</b> , <b>vsphere</b> , or <b>{}</b> . For additional information about <b>platform.&lt;platform&gt;</b> parameters, consult the table for your specific platform that follows.	Object
<b>pullSecret</b>	Get a <a href="#">pull secret from the Red Hat OpenShift Cluster Manager</a> to authenticate downloading container images for OpenShift Container Platform components from services such as Quay.io.	<pre>{   "auths":{     "cloud.openshift.com":{       "auth":"b3Blb=",       "email":"you@example.com"     },     "quay.io":{       "auth":"b3Blb=",       "email":"you@example.com"     }   } }</pre>

### 6.9.8.1.2. Network configuration parameters

You can customize your installation configuration based on the requirements of your existing network infrastructure. For example, you can expand the IP address block for the cluster network or provide different IP address blocks than the defaults.

Only IPv4 addresses are supported.

**Table 6.32. Network parameters**

Parameter	Description	Values
-----------	-------------	--------

Parameter	Description	Values
<b>networking</b>	The configuration for the cluster network.	Object  <b>NOTE</b> You cannot modify parameters specified by the <b>networking</b> object after installation.
<b>networking.networkType</b>	The cluster network provider Container Network Interface (CNI) plugin to install.	Either <b>OpenShiftSDN</b> or <b>OVNKubernetes</b> . <b>OpenShiftSDN</b> is a CNI provider for all-Linux networks. <b>OVNKubernetes</b> is a CNI provider for Linux networks and hybrid networks that contain both Linux and Windows servers. The default value is <b>OpenShiftSDN</b> .
<b>networking.clusterNetwork</b>	The IP address blocks for pods.  The default value is <b>10.128.0.0/14</b> with a host prefix of <b>/23</b> .  If you specify multiple IP address blocks, the blocks must not overlap.	An array of objects. For example:  <pre>networking:   clusterNetwork:   - cidr: 10.128.0.0/14     hostPrefix: 23</pre>
<b>networking.clusterNetwork.cidr</b>	Required if you use <b>networking.clusterNetwork</b> . An IP address block.  An IPv4 network.	An IP address block in Classless Inter-Domain Routing (CIDR) notation. The prefix length for an IPv4 block is between <b>0</b> and <b>32</b> .
<b>networking.clusterNetwork.hostPrefix</b>	The subnet prefix length to assign to each individual node. For example, if <b>hostPrefix</b> is set to <b>23</b> then each node is assigned a <b>/23</b> subnet out of the given <b>cidr</b> . A <b>hostPrefix</b> value of <b>23</b> provides 510 ( $2^{(32 - 23)} - 2$ ) pod IP addresses.	A subnet prefix.  The default value is <b>23</b> .
<b>networking.serviceNetwork</b>	The IP address block for services. The default value is <b>172.30.0.0/16</b> .  The OpenShift SDN and OVN-Kubernetes network providers support only a single IP address block for the service network.	An array with an IP address block in CIDR format. For example:  <pre>networking:   serviceNetwork:   - 172.30.0.0/16</pre>

Parameter	Description	Values
<b>networking.machineNetwork</b>	The IP address blocks for machines.  If you specify multiple IP address blocks, the blocks must not overlap.	An array of objects. For example:  <pre>networking:   machineNetwork:   - cidr: 10.0.0/16</pre>
<b>networking.machineNetwork.cidr</b>	Required if you use <b>networking.machineNetwork</b> . An IP address block. The default value is <b>10.0.0.0/16</b> for all platforms other than libvirt. For libvirt, the default value is <b>192.168.126.0/24</b> .	An IP network block in CIDR notation.  For example, <b>10.0.0.0/16</b> .   <p><b>NOTE</b></p> <p>Set the <b>networking.machineNetwork</b> to match the CIDR that the preferred NIC resides in.</p>

### 6.9.8.1.3. Optional configuration parameters

Optional installation configuration parameters are described in the following table:



Table 6.33. Optional parameters

Parameter	Description	Values
<b>additionalTrustBundle</b>	A PEM-encoded X.509 certificate bundle that is added to the nodes' trusted certificate store. This trust bundle may also be used when a proxy has been configured.	String
<b>cgroupsV2</b>	Enables <a href="#">Linux control groups version 2</a> (cgroups v2) on specific nodes in your cluster. The OpenShift Container Platform process for enabling cgroups v2 disables all cgroup version 1 controllers and hierarchies. The OpenShift Container Platform cgroups version 2 feature is in Developer Preview and is not supported by Red Hat at this time.	<b>true</b>

Parameter	Description	Values
<b>compute</b>	The configuration for the machines that comprise the compute nodes.	Array of <b>MachinePool</b> objects.
<b>compute.architecture</b>	Determines the instruction set architecture of the machines in the pool. Currently, clusters with varied architectures are not supported. All pools must specify the same architecture. Valid values are <b>amd64</b> (the default).	String
<b>compute.hyperthreading</b>	<p>Whether to enable or disable simultaneous multithreading, or <b>hyperthreading</b>, on compute machines. By default, simultaneous multithreading is enabled to increase the performance of your machines' cores.</p> <div style="display: flex; align-items: center;">  <div> <p><b>IMPORTANT</b></p> <p>If you disable simultaneous multithreading, ensure that your capacity planning accounts for the dramatically decreased machine performance.</p> </div> </div>	<b>Enabled</b> or <b>Disabled</b>
<b>compute.name</b>	Required if you use <b>compute</b> . The name of the machine pool.	<b>worker</b>
<b>compute.platform</b>	Required if you use <b>compute</b> . Use this parameter to specify the cloud provider to host the worker machines. This parameter value must match the <b>controlPlane.platform</b> parameter value.	<b>alibabacloud, aws, azure, gcp, ibmcloud, openstack, ovirt, vsphere</b> , or <b>{}</b>
<b>compute.replicas</b>	The number of compute machines, which are also known as worker machines, to provision.	A positive integer greater than or equal to <b>2</b> . The default value is <b>3</b> .
<b>controlPlane</b>	The configuration for the machines that comprise the control plane.	Array of <b>MachinePool</b> objects.



Parameter	Description	Values
<b>controlPlane.architecture</b>	Determines the instruction set architecture of the machines in the pool. Currently, clusters with varied architectures are not supported. All pools must specify the same architecture. Valid values are <b>amd64</b> (the default).	String
<b>controlPlane.hyperthreading</b>	Whether to enable or disable simultaneous multithreading, or <b>hyperthreading</b> , on control plane machines. By default, simultaneous multithreading is enabled to increase the performance of your machines' cores.   <b>IMPORTANT</b>  If you disable simultaneous multithreading, ensure that your capacity planning accounts for the dramatically decreased machine performance.	<b>Enabled</b> or <b>Disabled</b>
<b>controlPlane.name</b>	Required if you use <b>controlPlane</b> . The name of the machine pool.	<b>master</b>
<b>controlPlane.platform</b>	Required if you use <b>controlPlane</b> . Use this parameter to specify the cloud provider that hosts the control plane machines. This parameter value must match the <b>compute.platform</b> parameter value.	<b>alibabacloud, aws, azure, gcp, ibmcloud, openstack, ovirt, vsphere, or {}</b>
<b>controlPlane.replicas</b>	The number of control plane machines to provision.	The only supported value is <b>3</b> , which is the default value.

Parameter	Description	Values
<b>credentialsMode</b>	<p>The Cloud Credential Operator (CCO) mode. If no mode is specified, the CCO dynamically tries to determine the capabilities of the provided credentials, with a preference for mint mode on the platforms where multiple modes are supported.</p> <p> <b>NOTE</b></p> <p>Not all CCO modes are supported for all cloud providers. For more information on CCO modes, see the <i>Cloud Credential Operator</i> entry in the <i>Cluster Operators reference content</i>.</p> <p> <b>NOTE</b></p> <p>If your AWS account has service control policies (SCP) enabled, you must configure the <b>credentialsMode</b> parameter to <b>Mint</b>, <b>Passthrough</b> or <b>Manual</b>.</p>	<b>Mint, Passthrough, Manual</b> or an empty string ("").

Parameter	Description	Values
<b>fips</b>	<p>Enable or disable FIPS mode. The default is <b>false</b> (disabled). If FIPS mode is enabled, the Red Hat Enterprise Linux CoreOS (RHCOS) machines that OpenShift Container Platform runs on bypass the default Kubernetes cryptography suite and use the cryptography modules that are provided with RHCOS instead.</p> <div style="display: flex; align-items: flex-start;"> <div style="width: 20px; height: 100px; background: repeating-linear-gradient(45deg, transparent, transparent 2px, black 2px, black 4px); margin-right: 10px;"></div> <div> <p><b>IMPORTANT</b></p> <p>To enable FIPS mode for your cluster, you must run the installation program from a Red Hat Enterprise Linux (RHEL) computer configured to operate in FIPS mode. For more information about configuring FIPS mode on RHEL, see <a href="#">Installing the system in FIPS mode</a>. The use of FIPS validated or Modules In Process cryptographic libraries is only supported on OpenShift Container Platform deployments on the <b>x86_64</b> architecture.</p> </div> </div> <div style="display: flex; align-items: flex-start; margin-top: 10px;"> <div style="width: 20px; height: 100px; background: repeating-linear-gradient(45deg, transparent, transparent 2px, black 2px, black 4px); margin-right: 10px;"></div> <div> <p><b>NOTE</b></p> <p>If you are using Azure File storage, you cannot enable FIPS mode.</p> </div> </div>	<b>false</b> or <b>true</b>
<b>imageContentSources</b>	Sources and repositories for the release-image content.	Array of objects. Includes a <b>source</b> and, optionally, <b>mirrors</b> , as described in the following rows of this table.
<b>imageContentSources.source</b>	Required if you use <b>imageContentSources</b> . Specify the repository that users refer to, for example, in image pull specifications.	String
<b>imageContentSources.mirrors</b>	Specify one or more repositories that may also contain the same images.	Array of strings

Parameter	Description	Values
<b>publish</b>	How to publish or expose the user-facing endpoints of your cluster, such as the Kubernetes API, OpenShift routes.	<b>Internal</b> or <b>External</b> . To deploy a private cluster, which cannot be accessed from the internet, set <b>publish</b> to <b>Internal</b> . The default value is <b>External</b> .
<b>sshKey</b>	<p>The SSH key or keys to authenticate access your cluster machines.</p>  <p><b>NOTE</b></p> <p>For production OpenShift Container Platform clusters on which you want to perform installation debugging or disaster recovery, specify an SSH key that your <b>ssh-agent</b> process uses.</p>	<p>One or more keys. For example:</p> <pre>sshKey:   &lt;key1&gt;   &lt;key2&gt;   &lt;key3&gt;</pre>

#### 6.9.8.1.4. Additional Azure configuration parameters

Additional Azure configuration parameters are described in the following table.



#### NOTE

By default, if you specify availability zones in the **install-config.yaml** file, the installation program distributes the control plane machines and the compute machines across [these availability zones](#) within [a region](#). To ensure high availability for your cluster, select a region with at least three availability zones. If your region contains fewer than three availability zones, the installation program places more than one control plane machine in the available zones.

Table 6.34. Additional Azure parameters

Parameter	Description	Values
<b>compute.platform.azure.osDisk.diskSize GB</b>	The Azure disk size for the VM.	Integer that represents the size of the disk in GB. The default is <b>128</b> .
<b>compute.platform.azure.osDisk.diskType</b>	Defines the type of disk.	<b>standard_LRS</b> , <b>premium_LRS</b> , or <b>standardSSD_LRS</b> . The default is <b>premium_LRS</b> .

Parameter	Description	Values
<b>controlPlane.platform.azure.osDisk.diskSizeGB</b>	The Azure disk size for the VM.	Integer that represents the size of the disk in GB. The default is <b>1024</b> .
<b>controlPlane.platform.azure.osDisk.diskType</b>	Defines the type of disk.	<b>premium_LRS</b> or <b>standardSSD_LRS</b> . The default is <b>premium_LRS</b> .
<b>platform.azure.baseDomainResourceGroupName</b>	The name of the resource group that contains the DNS zone for your base domain.	String, for example <b>production_cluster</b> .
<b>platform.azure.resourceGroupName</b>	The name of an already existing resource group to install your cluster to. This resource group must be empty and only used for this specific cluster; the cluster components assume ownership of all resources in the resource group. If you limit the service principal scope of the installation program to this resource group, you must ensure all other resources used by the installation program in your environment have the necessary permissions, such as the public DNS zone and virtual network. Destroying the cluster by using the installation program deletes this resource group.	String, for example <b>existing_resource_group</b> .
<b>platform.azure.outboundType</b>	The outbound routing strategy used to connect your cluster to the internet. If you are using user-defined routing, you must have pre-existing networking available where the outbound routing has already been configured prior to installing a cluster. The installation program is not responsible for configuring user-defined routing.	<b>LoadBalancer</b> or <b>UserDefinedRouting</b> . The default is <b>LoadBalancer</b> .
<b>platform.azure.region</b>	The name of the Azure region that hosts your cluster.	Any valid region name, such as <b>centralus</b> .
<b>platform.azure.zones</b>	List of availability zones to place machines in. For high availability, specify at least two zones.	List of zones, for example <b>["1", "2", "3"]</b> .

Parameter	Description	Values
<b>platform.azure.networkResourceGroupName</b>	The name of the resource group that contains the existing VNet that you want to deploy your cluster to. This name cannot be the same as the <b>platform.azure.baseDomainResourceGroupName</b> .	String.
<b>platform.azure.virtualNetwork</b>	The name of the existing VNet that you want to deploy your cluster to.	String.
<b>platform.azure.controlPlaneSubnet</b>	The name of the existing subnet in your VNet that you want to deploy your control plane machines to.	Valid CIDR, for example <b>10.0.0.0/16</b> .
<b>platform.azure.computeSubnet</b>	The name of the existing subnet in your VNet that you want to deploy your compute machines to.	Valid CIDR, for example <b>10.0.0.0/16</b> .
<b>platform.azure.cloudName</b>	The name of the Azure cloud environment that is used to configure the Azure SDK with the appropriate Azure API endpoints. If empty, the default value <b>AzurePublicCloud</b> is used.	Any valid cloud environment, such as <b>AzurePublicCloud</b> or <b>AzureUSGovernmentCloud</b> .

**NOTE**

You cannot customize [Azure Availability Zones](#) or [Use tags to organize your Azure resources](#) with an Azure cluster.

### 6.9.8.2. Minimum resource requirements for cluster installation

Each cluster machine must meet the following minimum requirements:

Table 6.35. Minimum resource requirements

Machine	Operating System	vCPU [1]	Virtual RAM	Storage	IOPS [2]
Bootstrap	RHCOS	4	16 GB	100 GB	300
Control plane	RHCOS	4	16 GB	100 GB	300
Compute	RHCOS, RHEL 8.4, or RHEL 8.5 [3]	2	8 GB	100 GB	300

1. One vCPU is equivalent to one physical core when simultaneous multithreading (SMT), or hyperthreading, is not enabled. When enabled, use the following formula to calculate the corresponding ratio:  $(\text{threads per core} \times \text{cores}) \times \text{sockets} = \text{vCPUs}$ .
2. OpenShift Container Platform and Kubernetes are sensitive to disk performance, and faster storage is recommended, particularly for etcd on the control plane nodes which require a 10 ms p99 fsync duration. Note that on many cloud platforms, storage size and IOPS scale together, so you might need to over-allocate storage volume to obtain sufficient performance.
3. As with all user-provisioned installations, if you choose to use RHEL compute machines in your cluster, you take responsibility for all operating system life cycle management and maintenance, including performing system updates, applying patches, and completing all other required tasks. Use of RHEL 7 compute machines is deprecated and has been removed in OpenShift Container Platform 4.10 and later.

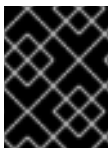

### IMPORTANT

You are required to use Azure virtual machines with **premiumIO** set to **true**. The machines must also have the **hyperVGeneration** property contain **V1**.

If an instance type for your platform meets the minimum requirements for cluster machines, it is supported to use in OpenShift Container Platform.

#### 6.9.8.3. Tested instance types for Azure

The following Microsoft Azure instance types have been tested with OpenShift Container Platform.

##### Example 6.5. Machine types

- **c4.\***
- **c5.\***
- **c5a.\***
- **i3.\***
- **m4.\***
- **m5.\***
- **m5a.\***
- **m6i.\***
- **r4.\***
- **r5.\***
- **r5a.\***
- **r6i.\***
- **t3.\***
- **t3a.\***

#### 6.9.8.4. Sample customized install-config.yaml file for Azure

You can customize the **install-config.yaml** file to specify more details about your OpenShift Container Platform cluster's platform or modify the values of the required parameters.

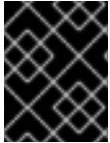

#### IMPORTANT

This sample YAML file is provided for reference only. You must obtain your **install-config.yaml** file by using the installation program and modify it.

```

apiVersion: v1
baseDomain: example.com 1
controlPlane: 2
  hyperthreading: Enabled 3 4
  name: master
  platform:
    azure:
      osDisk:
        diskSizeGB: 1024 5
        diskType: Premium_LRS
        type: Standard_D8s_v3
      replicas: 3
compute: 6
- hyperthreading: Enabled 7
  name: worker
  platform:
    azure:
      type: Standard_D2s_v3
      osDisk:
        diskSizeGB: 512 8
        diskType: Standard_LRS
      zones: 9
      - "1"
      - "2"
      - "3"
    replicas: 5
metadata:
  name: test-cluster 10
networking:
  clusterNetwork:
  - cidr: 10.128.0.0/14
    hostPrefix: 23
  machineNetwork:
  - cidr: 10.0.0.0/16
  networkType: OpenShiftSDN
  serviceNetwork:
  - 172.30.0.0/16
platform:
  azure:
    baseDomainResourceGroupName: resource_group 11
    region: usgovvirginia
    resourceGroupName: existing_resource_group 12

```



```

networkResourceGroupName: vnet_resource_group 13
virtualNetwork: vnet 14
controlPlaneSubnet: control_plane_subnet 15
computeSubnet: compute_subnet 16
outboundType: UserDefinedRouting 17
cloudName: AzureUSGovernmentCloud 18
pullSecret: '{"auths": ...}' 19
fips: false 20
sshKey: ssh-ed25519 AAAA... 21
publish: Internal 22

```

- 1 10 19 Required.
- 2 6 If you do not provide these parameters and values, the installation program provides the default value.
- 3 7 The **controlPlane** section is a single mapping, but the **compute** section is a sequence of mappings. To meet the requirements of the different data structures, the first line of the **compute** section must begin with a hyphen, -, and the first line of the **controlPlane** section must not. Only one control plane pool is used.
- 4 Whether to enable or disable simultaneous multithreading, or **hypertreading**. By default, simultaneous multithreading is enabled to increase the performance of your machines' cores. You can disable it by setting the parameter value to **Disabled**. If you disable simultaneous multithreading in some cluster machines, you must disable it in all cluster machines.



### IMPORTANT

If you disable simultaneous multithreading, ensure that your capacity planning accounts for the dramatically decreased machine performance. Use larger virtual machine types, such as **Standard\_D8s\_v3**, for your machines if you disable simultaneous multithreading.

- 5 8 You can specify the size of the disk to use in GB. Minimum recommendation for control plane nodes is 1024 GB.
- 9 Specify a list of zones to deploy your machines to. For high availability, specify at least two zones.
- 11 Specify the name of the resource group that contains the DNS zone for your base domain.
- 12 Specify the name of an already existing resource group to install your cluster to. If undefined, a new resource group is created for the cluster.
- 13 If you use an existing VNet, specify the name of the resource group that contains it.
- 14 If you use an existing VNet, specify its name.
- 15 If you use an existing VNet, specify the name of the subnet to host the control plane machines.
- 16 If you use an existing VNet, specify the name of the subnet to host the compute machines.
- 17 You can customize your own outbound routing. Configuring user-defined routing prevents exposing external endpoints in your cluster. User-defined routing for egress requires deploying your cluster to an existing VNet.

- 18 Specify the name of the Azure cloud environment to deploy your cluster to. Set **AzureUSGovernmentCloud** to deploy to a Microsoft Azure Government (MAG) region. The
- 20 Whether to enable or disable FIPS mode. By default, FIPS mode is not enabled. If FIPS mode is enabled, the Red Hat Enterprise Linux CoreOS (RHCOS) machines that OpenShift Container Platform runs on bypass the default Kubernetes cryptography suite and use the cryptography modules that are provided with RHCOS instead.



### IMPORTANT

To enable FIPS mode for your cluster, you must run the installation program from a Red Hat Enterprise Linux (RHEL) computer configured to operate in FIPS mode. For more information about configuring FIPS mode on RHEL, see [Installing the system in FIPS mode](#). The use of FIPS validated or Modules In Process cryptographic libraries is only supported on OpenShift Container Platform deployments on the **x86\_64** architecture.

- 21 You can optionally provide the **sshKey** value that you use to access the machines in your cluster.



### NOTE

For production OpenShift Container Platform clusters on which you want to perform installation debugging or disaster recovery, specify an SSH key that your **ssh-agent** process uses.

- 22 How to publish the user-facing endpoints of your cluster. Set **publish** to **Internal** to deploy a private cluster, which cannot be accessed from the internet. The default value is **External**.

#### 6.9.8.5. Configuring the cluster-wide proxy during installation

Production environments can deny direct access to the internet and instead have an HTTP or HTTPS proxy available. You can configure a new OpenShift Container Platform cluster to use a proxy by configuring the proxy settings in the **install-config.yaml** file.

#### Prerequisites

- You have an existing **install-config.yaml** file.
- You reviewed the sites that your cluster requires access to and determined whether any of them need to bypass the proxy. By default, all cluster egress traffic is proxied, including calls to hosting cloud provider APIs. You added sites to the **Proxy** object's **spec.noProxy** field to bypass the proxy if necessary.



### NOTE

The **Proxy** object **status.noProxy** field is populated with the values of the **networking.machineNetwork[].cidr**, **networking.clusterNetwork[].cidr**, and **networking.serviceNetwork[]** fields from your installation configuration.

For installations on Amazon Web Services (AWS), Google Cloud Platform (GCP), Microsoft Azure, and Red Hat OpenStack Platform (RHOSP), the **Proxy** object **status.noProxy** field is also populated with the instance metadata endpoint (**169.254.169.254**).

## Procedure

1. Edit your **install-config.yaml** file and add the proxy settings. For example:

```

apiVersion: v1
baseDomain: my.domain.com
proxy:
  httpProxy: http://<username>:<pswd>@<ip>:<port> 1
  httpsProxy: https://<username>:<pswd>@<ip>:<port> 2
  noProxy: example.com 3
  additionalTrustBundle: | 4
    -----BEGIN CERTIFICATE-----
    <MY_TRUSTED_CA_CERT>
    -----END CERTIFICATE-----
...

```

- 1 A proxy URL to use for creating HTTP connections outside the cluster. The URL scheme must be **http**.
- 2 A proxy URL to use for creating HTTPS connections outside the cluster.
- 3 A comma-separated list of destination domain names, IP addresses, or other network CIDRs to exclude from proxying. Preface a domain with **.** to match subdomains only. For example, **.y.com** matches **x.y.com**, but not **y.com**. Use **\*** to bypass the proxy for all destinations.
- 4 If provided, the installation program generates a config map that is named **user-ca-bundle** in the **openshift-config** namespace that contains one or more additional CA certificates that are required for proxying HTTPS connections. The Cluster Network Operator then creates a **trusted-ca-bundle** config map that merges these contents with the Red Hat Enterprise Linux CoreOS (RHCOS) trust bundle, and this config map is referenced in the **trustedCA** field of the **Proxy** object. The **additionalTrustBundle** field is required unless the proxy's identity certificate is signed by an authority from the RHCOS trust bundle.

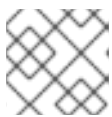

### NOTE

The installation program does not support the proxy **readinessEndpoints** field.



### NOTE

If the installer times out, restart and then complete the deployment by using the **wait-for** command of the installer. For example:

```
$ ./openshift-install wait-for install-complete --log-level debug
```

2. Save the file and reference it when installing OpenShift Container Platform.

The installation program creates a cluster-wide proxy that is named **cluster** that uses the proxy settings in the provided **install-config.yaml** file. If no proxy settings are provided, a **cluster Proxy** object is still created, but it will have a nil **spec**.

**NOTE**

Only the **Proxy** object named **cluster** is supported, and no additional proxies can be created.

### 6.9.9. Enabling Accelerated Networking during installation

You can enable Accelerated Networking on Microsoft Azure by adding **acceleratedNetworking** to your machine set YAML file before you install the cluster.

#### Prerequisites

- You have created the **install-config.yaml** file and completed any modifications to it.
- You have created the manifests for your cluster.

#### Procedure

1. Change to the **openshift** directory within the directory that contains the installation program. The **openshift** directory contains the Kubernetes manifest files that define the worker machines. These are the three default machine set files for an Azure cluster:

#### Machine set files in **openshift** directory listing

```
99_openshift-cluster-api_worker-machineset-0.yaml
99_openshift-cluster-api_worker-machineset-1.yaml
99_openshift-cluster-api_worker-machineset-2.yaml
```

2. Add the following to the **providerSpec** field in each machine set file:

```
providerSpec:
  value:
    ...
    acceleratedNetworking: true 1
    ...
    vmSize: <azure-vm-size> 2
    ...
```

- 1** This line enables Accelerated Networking.
- 2** Specify an Azure VM size that includes at least four vCPUs. For information about VM sizes, see [Microsoft Azure documentation](#).

#### Additional resources

- For more details about Accelerated Networking, see [Accelerated Networking for Microsoft Azure VMs](#).

### 6.9.10. Deploying the cluster

You can install OpenShift Container Platform on a compatible cloud platform.

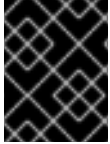

## IMPORTANT

You can run the **create cluster** command of the installation program only once, during initial installation.

### Prerequisites

- Configure an account with the cloud platform that hosts your cluster.
- Obtain the OpenShift Container Platform installation program and the pull secret for your cluster.

### Procedure

1. Change to the directory that contains the installation program and initialize the cluster deployment:

```
$ ./openshift-install create cluster --dir <installation_directory> \ ❶
--log-level=info ❷
```

- ❶ For **<installation\_directory>**, specify the location of your customized **./install-config.yaml** file.
- ❷ To view different installation details, specify **warn**, **debug**, or **error** instead of **info**.



## NOTE

If the cloud provider account that you configured on your host does not have sufficient permissions to deploy the cluster, the installation process stops, and the missing permissions are displayed.

When the cluster deployment completes, directions for accessing your cluster, including a link to its web console and credentials for the **kubeadmin** user, display in your terminal.

### Example output

```
...
INFO Install complete!
INFO To access the cluster as the system:admin user when using 'oc', run 'export
KUBECONFIG=/home/myuser/install_dir/auth/kubeconfig'
INFO Access the OpenShift web-console here: https://console-openshift-
console.apps.mycluster.example.com
INFO Login to the console with user: "kubeadmin", and password: "4vYBz-Ee6gm-ymBZj-
Wt5AL"
INFO Time elapsed: 36m22s
```

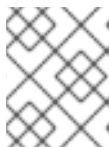

## NOTE

The cluster access and credential information also outputs to **<installation\_directory>/openshift\_install.log** when an installation succeeds.

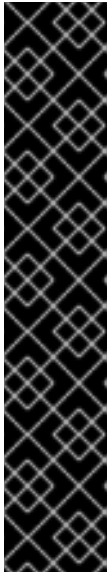
**IMPORTANT**

- The Ignition config files that the installation program generates contain certificates that expire after 24 hours, which are then renewed at that time. If the cluster is shut down before renewing the certificates and the cluster is later restarted after the 24 hours have elapsed, the cluster automatically recovers the expired certificates. The exception is that you must manually approve the pending **node-bootstrapper** certificate signing requests (CSRs) to recover kubelet certificates. See the documentation for *Recovering from expired control plane certificates* for more information.
- It is recommended that you use Ignition config files within 12 hours after they are generated because the 24-hour certificate rotates from 16 to 22 hours after the cluster is installed. By using the Ignition config files within 12 hours, you can avoid installation failure if the certificate update runs during installation.

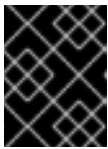
**IMPORTANT**

You must not delete the installation program or the files that the installation program creates. Both are required to delete the cluster.

**6.9.11. Installing the OpenShift CLI by downloading the binary**

You can install the OpenShift CLI (**oc**) to interact with OpenShift Container Platform from a command-line interface. You can install **oc** on Linux, Windows, or macOS.

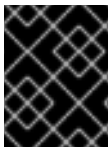
**IMPORTANT**

If you installed an earlier version of **oc**, you cannot use it to complete all of the commands in OpenShift Container Platform 4.10. Download and install the new version of **oc**.

**Installing the OpenShift CLI on Linux**

You can install the OpenShift CLI (**oc**) binary on Linux by using the following procedure.

**Procedure**

1. Navigate to the [OpenShift Container Platform downloads page](#) on the Red Hat Customer Portal.
2. Select the appropriate version in the **Version** drop-down menu.
3. Click **Download Now** next to the **OpenShift v4.10 Linux Client** entry and save the file.
4. Unpack the archive:

```
$ tar xvf <file>
```

5. Place the **oc** binary in a directory that is on your **PATH**.  
To check your **PATH**, execute the following command:

```
$ echo $PATH
```

After you install the OpenShift CLI, it is available using the **oc** command:

```
$ oc <command>
```

### Installing the OpenShift CLI on Windows

You can install the OpenShift CLI (**oc**) binary on Windows by using the following procedure.

#### Procedure

1. Navigate to the [OpenShift Container Platform downloads page](#) on the Red Hat Customer Portal.
2. Select the appropriate version in the **Version** drop-down menu.
3. Click **Download Now** next to the **OpenShift v4.10 Windows Client** entry and save the file.
4. Unzip the archive with a ZIP program.
5. Move the **oc** binary to a directory that is on your **PATH**.  
To check your **PATH**, open the command prompt and execute the following command:

```
C:\> path
```

After you install the OpenShift CLI, it is available using the **oc** command:

```
C:\> oc <command>
```

### Installing the OpenShift CLI on macOS

You can install the OpenShift CLI (**oc**) binary on macOS by using the following procedure.

#### Procedure

1. Navigate to the [OpenShift Container Platform downloads page](#) on the Red Hat Customer Portal.
2. Select the appropriate version in the **Version** drop-down menu.
3. Click **Download Now** next to the **OpenShift v4.10 MacOSX Client** entry and save the file.
4. Unpack and unzip the archive.
5. Move the **oc** binary to a directory on your **PATH**.  
To check your **PATH**, open a terminal and execute the following command:

```
$ echo $PATH
```

After you install the OpenShift CLI, it is available using the **oc** command:

```
$ oc <command>
```

### 6.9.12. Logging in to the cluster by using the CLI

You can log in to your cluster as a default system user by exporting the cluster **kubeconfig** file. The **kubeconfig** file contains information about the cluster that is used by the CLI to connect a client to the correct cluster and API server. The file is specific to a cluster and is created during OpenShift Container

Platform installation.

### Prerequisites

- You deployed an OpenShift Container Platform cluster.
- You installed the **oc** CLI.

### Procedure

1. Export the **kubeadmin** credentials:

```
$ export KUBECONFIG=<installation_directory>/auth/kubeconfig 1
```

- 1** For **<installation\_directory>**, specify the path to the directory that you stored the installation files in.

2. Verify you can run **oc** commands successfully using the exported configuration:

```
$ oc whoami
```

#### Example output

```
system:admin
```

### Additional resources

- See [Accessing the web console](#) for more details about accessing and understanding the OpenShift Container Platform web console.

## 6.9.13. Telemetry access for OpenShift Container Platform

In OpenShift Container Platform 4.10, the Telemetry service, which runs by default to provide metrics about cluster health and the success of updates, requires internet access. If your cluster is connected to the internet, Telemetry runs automatically, and your cluster is registered to [OpenShift Cluster Manager](#).

After you confirm that your [OpenShift Cluster Manager](#) inventory is correct, either maintained automatically by Telemetry or manually by using OpenShift Cluster Manager, [use subscription watch](#) to track your OpenShift Container Platform subscriptions at the account or multi-cluster level.

### Additional resources

- See [About remote health monitoring](#) for more information about the Telemetry service

## 6.9.14. Next steps

- [Customize your cluster](#).
- If necessary, you can [opt out of remote health reporting](#) .

## 6.10. INSTALLING A CLUSTER ON AZURE USING ARM TEMPLATES



In OpenShift Container Platform version 4.10, you can install a cluster on Microsoft Azure by using infrastructure that you provide.

Several [Azure Resource Manager \(ARM\)](#) templates are provided to assist in completing these steps or to help model your own.

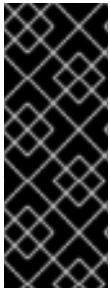

### IMPORTANT

The steps for performing a user-provisioned infrastructure installation are provided as an example only. Installing a cluster with infrastructure you provide requires knowledge of the cloud provider and the installation process of OpenShift Container Platform. Several ARM templates are provided to assist in completing these steps or to help model your own. You are also free to create the required resources through other methods; the templates are just an example.

#### 6.10.1. Prerequisites

- You reviewed details about the [OpenShift Container Platform installation and update](#) processes.
- You read the documentation on [selecting a cluster installation method and preparing it for users](#).
- You [configured an Azure account](#) to host the cluster.
- You downloaded the Azure CLI and installed it on your computer. See [Install the Azure CLI](#) in the Azure documentation. The documentation below was last tested using version **2.38.0** of the Azure CLI. Azure CLI commands might perform differently based on the version you use.
- If you use a firewall and plan to use the Telemetry service, you [configured the firewall to allow the sites](#) that your cluster requires access to.
- If the cloud identity and access management (IAM) APIs are not accessible in your environment, or if you do not want to store an administrator-level credential secret in the **kube-system** namespace, you can [manually create and maintain IAM credentials](#).



### NOTE

Be sure to also review this site list if you are configuring a proxy.

#### 6.10.2. Internet access for OpenShift Container Platform

In OpenShift Container Platform 4.10, you require access to the internet to install your cluster.

You must have internet access to:

- Access [OpenShift Cluster Manager](#) to download the installation program and perform subscription management. If the cluster has internet access and you do not disable Telemetry, that service automatically entitles your cluster.
- Access [Quay.io](#) to obtain the packages that are required to install your cluster.
- Obtain the packages that are required to perform cluster updates.

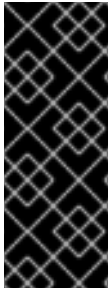
**IMPORTANT**

If your cluster cannot have direct internet access, you can perform a restricted network installation on some types of infrastructure that you provision. During that process, you download the required content and use it to populate a mirror registry with the installation packages. With some installation types, the environment that you install your cluster in will not require internet access. Before you update the cluster, you update the content of the mirror registry.

**6.10.3. Configuring your Azure project**

Before you can install OpenShift Container Platform, you must configure an Azure project to host it.

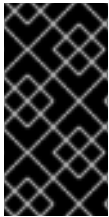
**IMPORTANT**

All Azure resources that are available through public endpoints are subject to resource name restrictions, and you cannot create resources that use certain terms. For a list of terms that Azure restricts, see [Resolve reserved resource name errors](#) in the Azure documentation.

**6.10.3.1. Azure account limits**

The OpenShift Container Platform cluster uses a number of Microsoft Azure components, and the default [Azure subscription and service limits, quotas, and constraints](#) affect your ability to install OpenShift Container Platform clusters.

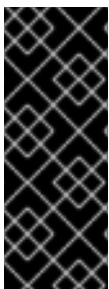
**IMPORTANT**

Default limits vary by offer category types, such as Free Trial and Pay-As-You-Go, and by series, such as Dv2, F, and G. For example, the default for Enterprise Agreement subscriptions is 350 cores.

Check the limits for your subscription type and if necessary, increase quota limits for your account before you install a default cluster on Azure.

The following table summarizes the Azure components whose limits can impact your ability to install and run OpenShift Container Platform clusters.

Component	Number of components required by default	Default Azure limit	Description

Component	Number of components required by default	Default Azure limit	Description
vCPU	40	20 per region	<p>A default cluster requires 40 vCPUs, so you must increase the account limit.</p> <p>By default, each cluster creates the following instances:</p> <ul style="list-style-type: none"> <li>• One bootstrap machine, which is removed after installation</li> <li>• Three control plane machines</li> <li>• Three compute machines</li> </ul> <p>Because the bootstrap machine uses <b>Standard_D4s_v3</b> machines, which use 4 vCPUs, the control plane machines use <b>Standard_D8s_v3</b> virtual machines, which use 8 vCPUs, and the worker machines use <b>Standard_D4s_v3</b> virtual machines, which use 4 vCPUs, a default cluster requires 40 vCPUs. The bootstrap node VM, which uses 4 vCPUs, is used only during installation.</p> <p>To deploy more worker nodes, enable autoscaling, deploy large workloads, or use a different instance type, you must further increase the vCPU limit for your account to ensure that your cluster can deploy the machines that you require.</p>
OS Disk	7		<p>Each cluster machine must have a minimum of 100 GB of storage and 300 IOPS. While these are the minimum supported values, faster storage is recommended for production clusters and clusters with intensive workloads. For more information about optimizing storage for performance, see the page titled "Optimizing storage" in the "Scalability and performance" section.</p>
VNet	1	1000 per region	<p>Each default cluster requires one Virtual Network (VNet), which contains two subnets.</p>
Network interfaces	7	65,536 per region	<p>Each default cluster requires seven network interfaces. If you create more machines or your deployed workloads create load balancers, your cluster uses more network interfaces.</p>

Component	Number of components required by default	Default Azure limit	Description						
Network security groups	2	5000	<p>Each cluster creates network security groups for each subnet in the VNet. The default cluster creates network security groups for the control plane and for the compute node subnets:</p> <table border="1"> <tr> <td><b>control plane</b></td> <td>Allows the control plane machines to be reached on port 6443 from anywhere</td> </tr> <tr> <td><b>node</b></td> <td>Allows worker nodes to be reached from the internet on ports 80 and 443</td> </tr> </table>	<b>control plane</b>	Allows the control plane machines to be reached on port 6443 from anywhere	<b>node</b>	Allows worker nodes to be reached from the internet on ports 80 and 443		
<b>control plane</b>	Allows the control plane machines to be reached on port 6443 from anywhere								
<b>node</b>	Allows worker nodes to be reached from the internet on ports 80 and 443								
Network load balancers	3	1000 per region	<p>Each cluster creates the following <a href="#">load balancers</a>:</p> <table border="1"> <tr> <td><b>default</b></td> <td>Public IP address that load balances requests to ports 80 and 443 across worker machines</td> </tr> <tr> <td><b>internal</b></td> <td>Private IP address that load balances requests to ports 6443 and 22623 across control plane machines</td> </tr> <tr> <td><b>external</b></td> <td>Public IP address that load balances requests to port 6443 across control plane machines</td> </tr> </table> <p>If your applications create more Kubernetes <b>LoadBalancer</b> service objects, your cluster uses more load balancers.</p>	<b>default</b>	Public IP address that load balances requests to ports 80 and 443 across worker machines	<b>internal</b>	Private IP address that load balances requests to ports 6443 and 22623 across control plane machines	<b>external</b>	Public IP address that load balances requests to port 6443 across control plane machines
<b>default</b>	Public IP address that load balances requests to ports 80 and 443 across worker machines								
<b>internal</b>	Private IP address that load balances requests to ports 6443 and 22623 across control plane machines								
<b>external</b>	Public IP address that load balances requests to port 6443 across control plane machines								
Public IP addresses	3		Each of the two public load balancers uses a public IP address. The bootstrap machine also uses a public IP address so that you can SSH into the machine to troubleshoot issues during installation. The IP address for the bootstrap node is used only during installation.						
Private IP addresses	7		The internal load balancer, each of the three control plane machines, and each of the three worker machines each use a private IP address.						

Component	Number of components required by default	Default Azure limit	Description
Spot VM vCPUs (optional)	0 If you configure spot VMs, your cluster must have two spot VM vCPUs for every compute node.	20 per region	<p>This is an optional component. To use spot VMs, you must increase the Azure default limit to at least twice the number of compute nodes in your cluster.</p> <div style="display: flex; align-items: center;">  <div> <p><b>NOTE</b></p> <p>Using spot VMs for control plane nodes is not recommended.</p> </div> </div>

### Additional resources

- [Optimizing storage](#).

### 6.10.3.2. Configuring a public DNS zone in Azure

To install OpenShift Container Platform, the Microsoft Azure account you use must have a dedicated public hosted DNS zone in your account. This zone must be authoritative for the domain. This service provides cluster DNS resolution and name lookup for external connections to the cluster.

#### Procedure

1. Identify your domain, or subdomain, and registrar. You can transfer an existing domain and registrar or obtain a new one through Azure or another source.

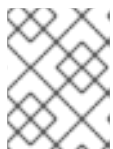

#### NOTE

For more information about purchasing domains through Azure, see [Buy a custom domain name for Azure App Service](#) in the Azure documentation.

2. If you are using an existing domain and registrar, migrate its DNS to Azure. See [Migrate an active DNS name to Azure App Service](#) in the Azure documentation.
3. Configure DNS for your domain. Follow the steps in the [Tutorial: Host your domain in Azure DNS](#) in the Azure documentation to create a public hosted zone for your domain or subdomain, extract the new authoritative name servers, and update the registrar records for the name servers that your domain uses.  
Use an appropriate root domain, such as **openshiftcorp.com**, or subdomain, such as **clusters.openshiftcorp.com**.
4. If you use a subdomain, follow your company's procedures to add its delegation records to the parent domain.

You can view Azure's DNS solution by visiting this [example for creating DNS zones](#).

### 6.10.3.3. Increasing Azure account limits

To increase an account limit, file a support request on the Azure portal.

**NOTE**

You can increase only one type of quota per support request.

**Procedure**

1. From the Azure portal, click **Help + support** in the lower left corner.
2. Click **New support request** and then select the required values:
  - a. From the **Issue type** list, select **Service and subscription limits (quotas)**
  - b. From the **Subscription** list, select the subscription to modify.
  - c. From the **Quota type** list, select the quota to increase. For example, select **Compute-VM (cores-vCPUs) subscription limit increases** to increase the number of vCPUs, which is required to install a cluster.
  - d. Click **Next: Solutions**.
3. On the **Problem Details** page, provide the required information for your quota increase:
  - a. Click **Provide details** and provide the required details in the **Quota details** window.
  - b. In the SUPPORT METHOD and CONTACT INFO sections, provide the issue severity and your contact details.
4. Click **Next: Review + create** and then click **Create**.

#### 6.10.3.4. Certificate signing requests management

Because your cluster has limited access to automatic machine management when you use infrastructure that you provision, you must provide a mechanism for approving cluster certificate signing requests (CSRs) after installation. The **kube-controller-manager** only approves the kubelet client CSRs. The **machine-approver** cannot guarantee the validity of a serving certificate that is requested by using kubelet credentials because it cannot confirm that the correct machine issued the request. You must determine and implement a method of verifying the validity of the kubelet serving certificate requests and approving them.

#### 6.10.3.5. Required Azure roles

OpenShift Container Platform needs a service principal so it can manage Microsoft Azure resources. Before you can create a service principal, review the following information:

Your Azure account subscription must have the following roles:

- **User Access Administrator**
- **Contributor**

Your Azure Active Directory (AD) must have the following permission:

- **"microsoft.directory/servicePrincipals/createAsOwner"**

To set roles on the Azure portal, see the [Manage access to Azure resources using RBAC and the Azure portal](#) in the Azure documentation.

### 6.10.3.6. Creating a service principal

Because OpenShift Container Platform and its installation program create Microsoft Azure resources by using the Azure Resource Manager, you must create a service principal to represent it.

#### Prerequisites

- Install or update the [Azure CLI](#).
- Your Azure account has the required roles for the subscription that you use.

#### Procedure

1. Log in to the Azure CLI:

```
$ az login
```

2. If your Azure account uses subscriptions, ensure that you are using the right subscription:

- a. View the list of available accounts and record the **tenantId** value for the subscription you want to use for your cluster:

```
$ az account list --refresh
```

#### Example output

```
[
  {
    "cloudName": "AzureCloud",
    "id": "9bab1460-96d5-40b3-a78e-17b15e978a80",
    "isDefault": true,
    "name": "Subscription Name",
    "state": "Enabled",
    "tenantId": "6057c7e9-b3ae-489d-a54e-de3f6bf6a8ee",
    "user": {
      "name": "you@example.com",
      "type": "user"
    }
  }
]
```

- b. View your active account details and confirm that the **tenantId** value matches the subscription you want to use:

```
$ az account show
```

#### Example output

```
{
  "environmentName": "AzureCloud",
  "id": "9bab1460-96d5-40b3-a78e-17b15e978a80",
  "isDefault": true,
  "name": "Subscription Name",
  "state": "Enabled",
```

```
"tenantId": "6057c7e9-b3ae-489d-a54e-de3f6bf6a8ee", 1
"user": {
  "name": "you@example.com",
  "type": "user"
}
}
```

- 1** Ensure that the value of the **tenantId** parameter is the correct subscription ID.

- c. If you are not using the right subscription, change the active subscription:

```
$ az account set -s <subscription_id> 1
```

- 1** Specify the subscription ID.

- d. Verify the subscription ID update:

```
$ az account show
```

#### Example output

```
{
  "environmentName": "AzureCloud",
  "id": "33212d16-bdf6-45cb-b038-f6565b61edda",
  "isDefault": true,
  "name": "Subscription Name",
  "state": "Enabled",
  "tenantId": "8049c7e9-c3de-762d-a54e-dc3f6be6a7ee",
  "user": {
    "name": "you@example.com",
    "type": "user"
  }
}
```

3. Record the **tenantId** and **id** parameter values from the output. You need these values during the OpenShift Container Platform installation.
4. Create the service principal for your account:

```
$ az ad sp create-for-rbac --role Contributor --name <service_principal> \ 1
--scopes /subscriptions/<subscription_id> 2
--years <years> 3
```

- 1** Specify the service principal name.

- 2** Specify the subscription ID.

- 3** Specify the number of years. By default, a service principal expires in one year. By using the **--years** option you can extend the validity of your service principal.

#### Example output



Creating 'Contributor' role assignment under scope '/subscriptions/<subscription\_id>' The output includes credentials that you must protect. Be sure that you do not include these credentials in your code or check the credentials into your source control. For more information, see <https://aka.ms/azadsp-cli>

```
{
  "appld": "ac461d78-bf4b-4387-ad16-7e32e328aec6",
  "displayName": <service_principal>,
  "password": "00000000-0000-0000-0000-000000000000",
  "tenantId": "8049c7e9-c3de-762d-a54e-dc3f6be6a7ee"
}
```

- Record the values of the **appld** and **password** parameters from the previous output. You need these values during OpenShift Container Platform installation.
- Assign the **User Access Administrator** role by running the following command:

```
$ az role assignment create --role "User Access Administrator" \
  --assignee-object-id $(az ad sp show --id <appld> --query id -o tsv) 1
```

- Specify the **appld** parameter value for your service principal.

#### Additional resources

- For more information about CCO modes, see [About the Cloud Credential Operator](#).

#### 6.10.3.7. Supported Azure regions

The installation program dynamically generates the list of available Microsoft Azure regions based on your subscription.

##### Supported Azure public regions

- **australiacentral** (Australia Central)
- **australiaeast** (Australia East)
- **australiasoutheast** (Australia South East)
- **brazilsouth** (Brazil South)
- **canadacentral** (Canada Central)
- **canadaeast** (Canada East)
- **centralindia** (Central India)
- **centralus** (Central US)
- **eastasia** (East Asia)
- **eastus** (East US)
- **eastus2** (East US 2)
- **francecentral** (France Central)

- **germanywestcentral** (Germany West Central)
- **japaneast** (Japan East)
- **japanwest** (Japan West)
- **koreacentral** (Korea Central)
- **koreasouth** (Korea South)
- **northcentralus** (North Central US)
- **northeurope** (North Europe)
- **norwayeast** (Norway East)
- **qatarcentral** (Qatar Central)
- **southafricanorth** (South Africa North)
- **southcentralus** (South Central US)
- **southeastasia** (Southeast Asia)
- **southindia** (South India)
- **swedencentral** (Sweden Central)
- **switzerlandnorth** (Switzerland North)
- **uaenorth** (UAE North)
- **uksouth** (UK South)
- **ukwest** (UK West)
- **westcentralus** (West Central US)
- **westeurope** (West Europe)
- **westindia** (West India)
- **westus** (West US)
- **westus2** (West US 2)
- **westus3** (West US 3)

#### Supported Azure Government regions

Support for the following Microsoft Azure Government (MAG) regions was added in OpenShift Container Platform version 4.6:

- **usgovtexas** (US Gov Texas)
- **usgovvirginia** (US Gov Virginia)

You can reference all available MAG regions in the [Azure documentation](#). Other provided MAG regions are expected to work with OpenShift Container Platform, but have not been tested.

## 6.10.4. Requirements for a cluster with user-provisioned infrastructure

For a cluster that contains user-provisioned infrastructure, you must deploy all of the required machines.

This section describes the requirements for deploying OpenShift Container Platform on user-provisioned infrastructure.

### 6.10.4.1. Required machines for cluster installation

The smallest OpenShift Container Platform clusters require the following hosts:

**Table 6.36. Minimum required hosts**

Hosts	Description
One temporary bootstrap machine	The cluster requires the bootstrap machine to deploy the OpenShift Container Platform cluster on the three control plane machines. You can remove the bootstrap machine after you install the cluster.
Three control plane machines	The control plane machines run the Kubernetes and OpenShift Container Platform services that form the control plane.
At least two compute machines, which are also known as worker machines.	The workloads requested by OpenShift Container Platform users run on the compute machines.

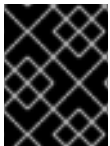

#### IMPORTANT

To maintain high availability of your cluster, use separate physical hosts for these cluster machines.

The bootstrap and control plane machines must use Red Hat Enterprise Linux CoreOS (RHCOS) as the operating system. However, the compute machines can choose between Red Hat Enterprise Linux CoreOS (RHCOS), Red Hat Enterprise Linux (RHEL) 8.4, or RHEL 8.5.

Note that RHCOS is based on Red Hat Enterprise Linux (RHEL) 8 and inherits all of its hardware certifications and requirements. See [Red Hat Enterprise Linux technology capabilities and limits](#).

### 6.10.4.2. Minimum resource requirements for cluster installation

Each cluster machine must meet the following minimum requirements:

**Table 6.37. Minimum resource requirements**

Machine	Operating System	vCPU [1]	Virtual RAM	Storage	IOPS [2]
Bootstrap	RHCOS	4	16 GB	100 GB	300
Control plane	RHCOS	4	16 GB	100 GB	300

Machine	Operating System	vCPU [1]	Virtual RAM	Storage	IOPS [2]
Compute	RHCOS, RHEL 8.4, or RHEL 8.5 <sup>[3]</sup>	2	8 GB	100 GB	300

1. One vCPU is equivalent to one physical core when simultaneous multithreading (SMT), or hyperthreading, is not enabled. When enabled, use the following formula to calculate the corresponding ratio: (threads per core × cores) × sockets = vCPUs.
2. OpenShift Container Platform and Kubernetes are sensitive to disk performance, and faster storage is recommended, particularly for etcd on the control plane nodes which require a 10 ms p99 fsync duration. Note that on many cloud platforms, storage size and IOPS scale together, so you might need to over-allocate storage volume to obtain sufficient performance.
3. As with all user-provisioned installations, if you choose to use RHEL compute machines in your cluster, you take responsibility for all operating system life cycle management and maintenance, including performing system updates, applying patches, and completing all other required tasks. Use of RHEL 7 compute machines is deprecated and has been removed in OpenShift Container Platform 4.10 and later.



### IMPORTANT

You are required to use Azure virtual machines with **premiumIO** set to **true**. The machines must also have the **hyperVGeneration** property contain **V1**.

If an instance type for your platform meets the minimum requirements for cluster machines, it is supported to use in OpenShift Container Platform.

#### 6.10.4.3. Tested instance types for Azure

The following Microsoft Azure instance types have been tested with OpenShift Container Platform.

##### Example 6.6. Machine types

- c4.\*
- c5.\*
- c5a.\*
- i3.\*
- m4.\*
- m5.\*
- m5a.\*
- m6i.\*
- r4.\*

- **r5.\***
- **r5a.\***
- **r6i.\***
- **t3.\***
- **t3a.\***

### 6.10.5. Selecting an Azure Marketplace image

If you are deploying an OpenShift Container Platform cluster using the Azure Marketplace offering, you must first obtain the Azure Marketplace image. The installation program uses this image to deploy worker nodes. When obtaining your image, consider the following:

- While the images are the same, the Azure Marketplace publisher is different depending on your region. If you are located in North America, specify **redhat** as the publisher. If you are located in EMEA, specify **redhat-limited** as the publisher.
- The offer includes a **rh-ocp-worker** SKU and a **rh-ocp-worker-gen1** SKU. The **rh-ocp-worker** SKU represents a Hyper-V generation version 2 VM image. The default instance types used in OpenShift Container Platform are version 2 compatible. If you are going to use an instance type that is only version 1 compatible, use the image associated with the **rh-ocp-worker-gen1** SKU. The **rh-ocp-worker-gen1** SKU represents a Hyper-V version 1 VM image.

#### Prerequisites

- You have installed the Azure CLI client (**az**).
- Your Azure account is entitled for the offer and you have logged into this account with the Azure CLI client.

#### Procedure

1. Display all of the available OpenShift Container Platform images by running one of the following commands:

- North America:

```
$ az vm image list --all --offer rh-ocp-worker --publisher redhat -o table
```

#### Example output

Offer	Publisher	SKU	Urn	Version
rh-ocp-worker-ocpworker:4.8.2021122100	RedHat	rh-ocp-worker	RedHat:rh-ocp-worker:rh-ocp-worker:4.8.2021122100	
rh-ocp-worker-gen1:4.8.2021122100	RedHat	rh-ocp-worker-gen1	RedHat:rh-ocp-worker:rh-ocp-worker-gen1:4.8.2021122100	

- EMEA:

```
$ az vm image list --all --offer rh-ocp-worker --publisher redhat-limited -o table
```

### Example output

```
Offer          Publisher      Sku              Urn                                                       Version
-----
rh-ocp-worker redhat-limited rh-ocp-worker    redhat-limited:rh-ocp-worker:rh-ocp-                    4.8.2021122100
worker:4.8.2021122100 4.8.2021122100
rh-ocp-worker redhat-limited rh-ocp-worker-gen1 redhat-limited:rh-ocp-worker:rh-ocp-                    4.8.2021122100
worker-gen1:4.8.2021122100 4.8.2021122100
```



### NOTE

Regardless of the version of OpenShift Container Platform you are installing, the correct version of the Azure Marketplace image to use is 4.8.x. If required, as part of the installation process, your VMs are automatically upgraded.

2. Inspect the image for your offer by running one of the following commands:

- North America:

```
$ az vm image show --urn redhat:rh-ocp-worker:rh-ocp-worker:<version>
```

- EMEA:

```
$ az vm image show --urn redhat-limited:rh-ocp-worker:rh-ocp-worker:<version>
```

3. Review the terms of the offer by running one of the following commands:

- North America:

```
$ az vm image terms show --urn redhat:rh-ocp-worker:rh-ocp-worker:<version>
```

- EMEA:

```
$ az vm image terms show --urn redhat-limited:rh-ocp-worker:rh-ocp-worker:<version>
```

4. Accept the terms of the offering by running one of the following commands:

- North America:

```
$ az vm image terms accept --urn redhat:rh-ocp-worker:rh-ocp-worker:<version>
```

- EMEA:

```
$ az vm image terms accept --urn redhat-limited:rh-ocp-worker:rh-ocp-worker:<version>
```

5. Record the image details of your offer and use them to update the **06\_workers.json** Azure Resource Manager (ARM) template.

- Update the **storageProfile.imageReference** field by deleting the **id** parameter and adding the **offer**, **publisher**, **sku**, and **version** parameters by using the values from your offer. You can find a sample template in the "Creating additional worker machines in Azure" section.

### 6.10.6. Obtaining the installation program

Before you install OpenShift Container Platform, download the installation file on a local computer.

#### Prerequisites

- You have a computer that runs Linux or macOS, with 500 MB of local disk space

#### Procedure

- Access the [Infrastructure Provider](#) page on the OpenShift Cluster Manager site. If you have a Red Hat account, log in with your credentials. If you do not, create an account.
- Select your infrastructure provider.
- Navigate to the page for your installation type, download the installation program that corresponds with your host operating system and architecture, and place the file in the directory where you will store the installation configuration files.

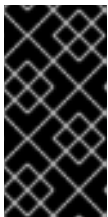

#### IMPORTANT

The installation program creates several files on the computer that you use to install your cluster. You must keep the installation program and the files that the installation program creates after you finish installing the cluster. Both files are required to delete the cluster.

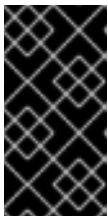

#### IMPORTANT

Deleting the files created by the installation program does not remove your cluster, even if the cluster failed during installation. To remove your cluster, complete the OpenShift Container Platform uninstallation procedures for your specific cloud provider.

- Extract the installation program. For example, on a computer that uses a Linux operating system, run the following command:

```
$ tar -xvf openshift-install-linux.tar.gz
```

- Download your installation [pull secret from the Red Hat OpenShift Cluster Manager](#). This pull secret allows you to authenticate with the services that are provided by the included authorities, including Quay.io, which serves the container images for OpenShift Container Platform components.

### 6.10.7. Generating a key pair for cluster node SSH access

During an OpenShift Container Platform installation, you can provide an SSH public key to the installation program. The key is passed to the Red Hat Enterprise Linux CoreOS (RHCOS) nodes through their Ignition config files and is used to authenticate SSH access to the nodes. The key is added to the `~/.ssh/authorized_keys` list for the **core** user on each node, which enables password-less authentication.

After the key is passed to the nodes, you can use the key pair to SSH in to the RHCOS nodes as the user **core**. To access the nodes through SSH, the private key identity must be managed by SSH for your local user.

If you want to SSH in to your cluster nodes to perform installation debugging or disaster recovery, you must provide the SSH public key during the installation process. The **./openshift-install gather** command also requires the SSH public key to be in place on the cluster nodes.



### IMPORTANT

Do not skip this procedure in production environments, where disaster recovery and debugging is required.



### NOTE

You must use a local key, not one that you configured with platform-specific approaches such as [AWS key pairs](#).

## Procedure

1. If you do not have an existing SSH key pair on your local machine to use for authentication onto your cluster nodes, create one. For example, on a computer that uses a Linux operating system, run the following command:

```
$ ssh-keygen -t ed25519 -N "" -f <path>/<file_name> 1
```

- 1 Specify the path and file name, such as `~/.ssh/id_ed25519`, of the new SSH key. If you have an existing key pair, ensure your public key is in the your `~/.ssh` directory.



### NOTE

If you plan to install an OpenShift Container Platform cluster that uses FIPS validated or Modules In Process cryptographic libraries on the **x86\_64** architecture, do not create a key that uses the **ed25519** algorithm. Instead, create a key that uses the **rsa** or **ecdsa** algorithm.

2. View the public SSH key:

```
$ cat <path>/<file_name>.pub
```

For example, run the following to view the `~/.ssh/id_ed25519.pub` public key:

```
$ cat ~/.ssh/id_ed25519.pub
```

3. Add the SSH private key identity to the SSH agent for your local user, if it has not already been added. SSH agent management of the key is required for password-less SSH authentication onto your cluster nodes, or if you want to use the **./openshift-install gather** command.



### NOTE

On some distributions, default SSH private key identities such as `~/.ssh/id_rsa` and `~/.ssh/id_dsa` are managed automatically.



- a. If the **ssh-agent** process is not already running for your local user, start it as a background task:

```
$ eval "$(ssh-agent -s)"
```

#### Example output

```
Agent pid 31874
```



#### NOTE

If your cluster is in FIPS mode, only use FIPS-compliant algorithms to generate the SSH key. The key must be either RSA or ECDSA.

4. Add your SSH private key to the **ssh-agent**:

```
$ ssh-add <path>/<file_name> 1
```

- 1 Specify the path and file name for your SSH private key, such as `~/.ssh/id_ed25519`

#### Example output

```
Identity added: /home/<you>/<path>/<file_name> (<computer_name>)
```

#### Next steps

- When you install OpenShift Container Platform, provide the SSH public key to the installation program. If you install a cluster on infrastructure that you provision, you must provide the key to the installation program.

### 6.10.8. Creating the installation files for Azure

To install OpenShift Container Platform on Microsoft Azure using user-provisioned infrastructure, you must generate the files that the installation program needs to deploy your cluster and modify them so that the cluster creates only the machines that it will use. You generate and customize the **install-config.yaml** file, Kubernetes manifests, and Ignition config files. You also have the option to first set up a separate **var** partition during the preparation phases of installation.

#### 6.10.8.1. Optional: Creating a separate **/var** partition

It is recommended that disk partitioning for OpenShift Container Platform be left to the installer. However, there are cases where you might want to create separate partitions in a part of the filesystem that you expect to grow.

OpenShift Container Platform supports the addition of a single partition to attach storage to either the **/var** partition or a subdirectory of **/var**. For example:

- **/var/lib/containers**: Holds container-related content that can grow as more images and containers are added to a system.

- **/var/lib/etcd**: Holds data that you might want to keep separate for purposes such as performance optimization of etcd storage.
- **/var**: Holds data that you might want to keep separate for purposes such as auditing.

Storing the contents of a **/var** directory separately makes it easier to grow storage for those areas as needed and reinstall OpenShift Container Platform at a later date and keep that data intact. With this method, you will not have to pull all your containers again, nor will you have to copy massive log files when you update systems.

Because **/var** must be in place before a fresh installation of Red Hat Enterprise Linux CoreOS (RHCOS), the following procedure sets up the separate **/var** partition by creating a machine config manifest that is inserted during the **openshift-install** preparation phases of an OpenShift Container Platform installation.



### IMPORTANT

If you follow the steps to create a separate **/var** partition in this procedure, it is not necessary to create the Kubernetes manifest and Ignition config files again as described later in this section.

### Procedure

1. Create a directory to hold the OpenShift Container Platform installation files:

```
$ mkdir $HOME/clusterconfig
```

2. Run **openshift-install** to create a set of files in the **manifest** and **openshift** subdirectories. Answer the system questions as you are prompted:

```
$ openshift-install create manifests --dir $HOME/clusterconfig
```

### Example output

```
? SSH Public Key ...
INFO Credentials loaded from the "myprofile" profile in file "/home/myuser/.aws/credentials"
INFO Consuming Install Config from target directory
INFO Manifests created in: $HOME/clusterconfig/manifests and
$HOME/clusterconfig/openshift
```

3. Optional: Confirm that the installation program created manifests in the **clusterconfig/openshift** directory:

```
$ ls $HOME/clusterconfig/openshift/
```

### Example output

```
99_kubeadmin-password-secret.yaml
99_openshift-cluster-api_master-machines-0.yaml
99_openshift-cluster-api_master-machines-1.yaml
99_openshift-cluster-api_master-machines-2.yaml
...
```

4. Create a Butane config that configures the additional partition. For example, name the file **\$HOME/clusterconfig/98-var-partition.bu**, change the disk device name to the name of the storage device on the **worker** systems, and set the storage size as appropriate. This example places the **/var** directory on a separate partition:

```
variant: openshift
version: 4.10.0
metadata:
  labels:
    machineconfiguration.openshift.io/role: worker
  name: 98-var-partition
storage:
  disks:
    - device: /dev/<device_name> 1
      partitions:
        - label: var
          start_mib: <partition_start_offset> 2
          size_mib: <partition_size> 3
      filesystems:
        - device: /dev/disk/by-partlabel/var
          path: /var
          format: xfs
          mount_options: [defaults, prjquota] 4
          with_mount_unit: true
```

- 1 The storage device name of the disk that you want to partition.
- 2 When adding a data partition to the boot disk, a minimum value of 25000 MiB (Mebibytes) is recommended. The root file system is automatically resized to fill all available space up to the specified offset. If no value is specified, or if the specified value is smaller than the recommended minimum, the resulting root file system will be too small, and future reinstalls of RHCOS might overwrite the beginning of the data partition.
- 3 The size of the data partition in mebibytes.
- 4 The **prjquota** mount option must be enabled for filesystems used for container storage.

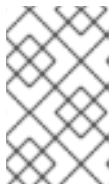

#### NOTE

When creating a separate **/var** partition, you cannot use different instance types for worker nodes, if the different instance types do not have the same device name.

5. Create a manifest from the Butane config and save it to the **clusterconfig/openshift** directory. For example, run the following command:

```
$ butane $HOME/clusterconfig/98-var-partition.bu -o $HOME/clusterconfig/openshift/98-var-partition.yaml
```

6. Run **openshift-install** again to create Ignition configs from a set of files in the **manifest** and **openshift** subdirectories:

```
$ openshift-install create ignition-configs --dir $HOME/clusterconfig
$ ls $HOME/clusterconfig/
auth bootstrap.ign master.ign metadata.json worker.ign
```

Now you can use the Ignition config files as input to the installation procedures to install Red Hat Enterprise Linux CoreOS (RHCOS) systems.

### 6.10.8.2. Creating the installation configuration file

You can customize the OpenShift Container Platform cluster you install on Microsoft Azure.

#### Prerequisites

- Obtain the OpenShift Container Platform installation program and the pull secret for your cluster.
- Obtain service principal permissions at the subscription level.

#### Procedure

1. Create the **install-config.yaml** file.
  - a. Change to the directory that contains the installation program and run the following command:

```
$ ./openshift-install create install-config --dir <installation_directory> 1
```

- 1** For **<installation\_directory>**, specify the directory name to store the files that the installation program creates.



#### IMPORTANT

Specify an empty directory. Some installation assets, like bootstrap X.509 certificates have short expiration intervals, so you must not reuse an installation directory. If you want to reuse individual files from another cluster installation, you can copy them into your directory. However, the file names for the installation assets might change between releases. Use caution when copying installation files from an earlier OpenShift Container Platform version.

- b. At the prompts, provide the configuration details for your cloud:
  - i. Optional: Select an SSH key to use to access your cluster machines.



#### NOTE

For production OpenShift Container Platform clusters on which you want to perform installation debugging or disaster recovery, specify an SSH key that your **ssh-agent** process uses.

- ii. Select **azure** as the platform to target.

- iii. If you do not have a Microsoft Azure profile stored on your computer, specify the following Azure parameter values for your subscription and service principal:
  - **azure subscription id** The subscription ID to use for the cluster. Specify the **id** value in your account output.
  - **azure tenant id** The tenant ID. Specify the **tenantId** value in your account output.
  - **azure service principal client id** The value of the **appId** parameter for the service principal.
  - **azure service principal client secret** The value of the **password** parameter for the service principal.
- iv. Select the region to deploy the cluster to.
- v. Select the base domain to deploy the cluster to. The base domain corresponds to the Azure DNS Zone that you created for your cluster.
- vi. Enter a descriptive name for your cluster.



### IMPORTANT

All Azure resources that are available through public endpoints are subject to resource name restrictions, and you cannot create resources that use certain terms. For a list of terms that Azure restricts, see [Resolve reserved resource name errors](#) in the Azure documentation.

- vii. Paste the [pull secret from the Red Hat OpenShift Cluster Manager](#) .
- c. Optional: If you do not want the cluster to provision compute machines, empty the compute pool by editing the resulting **install-config.yaml** file to set **replicas** to **0** for the **compute** pool:

```
compute:
- hyperthreading: Enabled
  name: worker
  platform: {}
  replicas: 0 1
```

**1** Set to **0**.

2. Modify the **install-config.yaml** file. You can find more information about the available parameters in the "Installation configuration parameters" section.
3. Back up the **install-config.yaml** file so that you can use it to install multiple clusters.

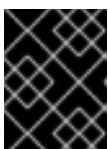

### IMPORTANT

The **install-config.yaml** file is consumed during the installation process. If you want to reuse the file, you must back it up now.

#### 6.10.8.3. Configuring the cluster-wide proxy during installation

Production environments can deny direct access to the internet and instead have an HTTP or HTTPS proxy available. You can configure a new OpenShift Container Platform cluster to use a proxy by configuring the proxy settings in the **install-config.yaml** file.

## Prerequisites

- You have an existing **install-config.yaml** file.
- You reviewed the sites that your cluster requires access to and determined whether any of them need to bypass the proxy. By default, all cluster egress traffic is proxied, including calls to hosting cloud provider APIs. You added sites to the **Proxy** object's **spec.noProxy** field to bypass the proxy if necessary.



### NOTE

The **Proxy** object **status.noProxy** field is populated with the values of the **networking.machineNetwork[].cidr**, **networking.clusterNetwork[].cidr**, and **networking.serviceNetwork[]** fields from your installation configuration.

For installations on Amazon Web Services (AWS), Google Cloud Platform (GCP), Microsoft Azure, and Red Hat OpenStack Platform (RHOSP), the **Proxy** object **status.noProxy** field is also populated with the instance metadata endpoint (**169.254.169.254**).

## Procedure

1. Edit your **install-config.yaml** file and add the proxy settings. For example:

```
apiVersion: v1
baseDomain: my.domain.com
proxy:
  httpProxy: http://<username>:<pswd>@<ip>:<port> 1
  httpsProxy: https://<username>:<pswd>@<ip>:<port> 2
  noProxy: example.com 3
  additionalTrustBundle: | 4
    -----BEGIN CERTIFICATE-----
    <MY_TRUSTED_CA_CERT>
    -----END CERTIFICATE-----
  ...
```

- 1 A proxy URL to use for creating HTTP connections outside the cluster. The URL scheme must be **http**.
- 2 A proxy URL to use for creating HTTPS connections outside the cluster.
- 3 A comma-separated list of destination domain names, IP addresses, or other network CIDRs to exclude from proxying. Preface a domain with **.** to match subdomains only. For example, **.y.com** matches **x.y.com**, but not **y.com**. Use **\*** to bypass the proxy for all destinations.
- 4 If provided, the installation program generates a config map that is named **user-ca-bundle** in the **openshift-config** namespace that contains one or more additional CA certificates that are required for proxying HTTPS connections. The Cluster Network Operator then creates a **trusted-ca-bundle** config map that merges these contents with the Red Hat Enterprise Linux CoreOS (RHCOS) trust bundle, and this config map is referenced in the

**trustedCA** field of the **Proxy** object. The **additionalTrustBundle** field is required unless the proxy's identity certificate is signed by an authority from the RHCOS trust bundle.



#### NOTE

The installation program does not support the proxy **readinessEndpoints** field.

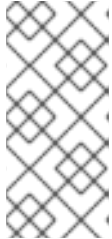

#### NOTE

If the installer times out, restart and then complete the deployment by using the **wait-for** command of the installer. For example:

```
$ ./openshift-install wait-for install-complete --log-level debug
```

2. Save the file and reference it when installing OpenShift Container Platform.

The installation program creates a cluster-wide proxy that is named **cluster** that uses the proxy settings in the provided **install-config.yaml** file. If no proxy settings are provided, a **cluster Proxy** object is still created, but it will have a nil **spec**.

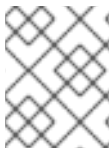

#### NOTE

Only the **Proxy** object named **cluster** is supported, and no additional proxies can be created.

### 6.10.8.4. Exporting common variables for ARM templates

You must export a common set of variables that are used with the provided Azure Resource Manager (ARM) templates used to assist in completing a user-provided infrastructure install on Microsoft Azure.



#### NOTE

Specific ARM templates can also require additional exported variables, which are detailed in their related procedures.

#### Prerequisites

- Obtain the OpenShift Container Platform installation program and the pull secret for your cluster.

#### Procedure

1. Export common variables found in the **install-config.yaml** to be used by the provided ARM templates:

```
$ export CLUSTER_NAME=<cluster_name> 1
$ export AZURE_REGION=<azure_region> 2
$ export SSH_KEY=<ssh_key> 3
$ export BASE_DOMAIN=<base_domain> 4
$ export BASE_DOMAIN_RESOURCE_GROUP=<base_domain_resource_group> 5
```

- 1 The value of the **.metadata.name** attribute from the **install-config.yaml** file.
- 2 The region to deploy the cluster into, for example **centralus**. This is the value of the **.platform.azure.region** attribute from the **install-config.yaml** file.
- 3 The SSH RSA public key file as a string. You must enclose the SSH key in quotes since it contains spaces. This is the value of the **.sshKey** attribute from the **install-config.yaml** file.
- 4 The base domain to deploy the cluster to. The base domain corresponds to the public DNS zone that you created for your cluster. This is the value of the **.baseDomain** attribute from the **install-config.yaml** file.
- 5 The resource group where the public DNS zone exists. This is the value of the **.platform.azure.baseDomainResourceGroupName** attribute from the **install-config.yaml** file.

For example:

```
$ export CLUSTER_NAME=test-cluster
$ export AZURE_REGION=centralus
$ export SSH_KEY="ssh-rsa xxx/xxx/xxx= user@email.com"
$ export BASE_DOMAIN=example.com
$ export BASE_DOMAIN_RESOURCE_GROUP=ocp-cluster
```

2. Export the kubeadmin credentials:

```
$ export KUBECONFIG=<installation_directory>/auth/kubeconfig 1
```

- 1 For **<installation\_directory>**, specify the path to the directory that you stored the installation files in.

### 6.10.8.5. Creating the Kubernetes manifest and Ignition config files

Because you must modify some cluster definition files and manually start the cluster machines, you must generate the Kubernetes manifest and Ignition config files that the cluster needs to configure the machines.

The installation configuration file transforms into the Kubernetes manifests. The manifests wrap into the Ignition configuration files, which are later used to configure the cluster machines.





## IMPORTANT

- The Ignition config files that the OpenShift Container Platform installation program generates contain certificates that expire after 24 hours, which are then renewed at that time. If the cluster is shut down before renewing the certificates and the cluster is later restarted after the 24 hours have elapsed, the cluster automatically recovers the expired certificates. The exception is that you must manually approve the pending **node-bootstrapper** certificate signing requests (CSRs) to recover kubelet certificates. See the documentation for *Recovering from expired control plane certificates* for more information.
- It is recommended that you use Ignition config files within 12 hours after they are generated because the 24-hour certificate rotates from 16 to 22 hours after the cluster is installed. By using the Ignition config files within 12 hours, you can avoid installation failure if the certificate update runs during installation.

## Prerequisites

- You obtained the OpenShift Container Platform installation program.
- You created the **install-config.yaml** installation configuration file.

## Procedure

1. Change to the directory that contains the OpenShift Container Platform installation program and generate the Kubernetes manifests for the cluster:

```
$ ./openshift-install create manifests --dir <installation_directory> 1
```

- 1 For **<installation\_directory>**, specify the installation directory that contains the **install-config.yaml** file you created.

2. Remove the Kubernetes manifest files that define the control plane machines:

```
$ rm -f <installation_directory>/openshift/99_openshift-cluster-api_master-machines-*.yaml
```

By removing these files, you prevent the cluster from automatically generating control plane machines.

3. Remove the Kubernetes manifest files that define the worker machines:

```
$ rm -f <installation_directory>/openshift/99_openshift-cluster-api_worker-machineset-*.yaml
```

Because you create and manage the worker machines yourself, you do not need to initialize these machines.

4. Check that the **mastersSchedulable** parameter in the **<installation\_directory>/manifests/cluster-scheduler-02-config.yml** Kubernetes manifest file is set to **false**. This setting prevents pods from being scheduled on the control plane machines:

- a. Open the **<installation\_directory>/manifests/cluster-scheduler-02-config.yml** file.
- b. Locate the **mastersSchedulable** parameter and ensure that it is set to **false**.

- c. Save and exit the file.
5. Optional: If you do not want [the Ingress Operator](#) to create DNS records on your behalf, remove the **privateZone** and **publicZone** sections from the `<installation_directory>/manifests/cluster-dns-02-config.yml` DNS configuration file:

```
apiVersion: config.openshift.io/v1
kind: DNS
metadata:
  creationTimestamp: null
  name: cluster
spec:
  baseDomain: example.openshift.com
  privateZone: 1
    id: mycluster-100419-private-zone
  publicZone: 2
    id: example.openshift.com
status: {}
```

- 1 2 Remove this section completely.

If you do so, you must add ingress DNS records manually in a later step.

6. When configuring Azure on user-provisioned infrastructure, you must export some common variables defined in the manifest files to use later in the Azure Resource Manager (ARM) templates:
  - a. Export the infrastructure ID by using the following command:

```
$ export INFRA_ID=<infra_id> 1
```

- 1 The OpenShift Container Platform cluster has been assigned an identifier (**INFRA\_ID**) in the form of `<cluster_name>-<random_string>`. This will be used as the base name for most resources created using the provided ARM templates. This is the value of the **.status.infrastructureName** attribute from the `manifests/cluster-infrastructure-02-config.yml` file.

- b. Export the resource group by using the following command:

```
$ export RESOURCE_GROUP=<resource_group> 1
```

- 1 All resources created in this Azure deployment exists as part of a [resource group](#). The resource group name is also based on the **INFRA\_ID**, in the form of `<cluster_name>-<random_string>-rg`. This is the value of the **.status.platformStatus.azure.resourceGroupName** attribute from the `manifests/cluster-infrastructure-02-config.yml` file.

7. To create the Ignition configuration files, run the following command from the directory that contains the installation program:

```
$. /openshift-install create ignition-configs --dir <installation_directory> 1
```

- 1 For `<installation_directory>`, specify the same installation directory.

Ignition config files are created for the bootstrap, control plane, and compute nodes in the installation directory. The **kubeadmin-password** and **kubeconfig** files are created in the `./<installation_directory>/auth` directory:

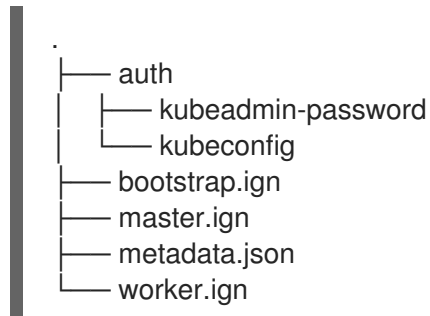

### 6.10.9. Creating the Azure resource group

You must create a Microsoft Azure [resource group](#) and an identity for that resource group. These are both used during the installation of your OpenShift Container Platform cluster on Azure.

#### Prerequisites

- Configure an Azure account.
- Generate the Ignition config files for your cluster.

#### Procedure

1. Create the resource group in a supported Azure region:

```
$ az group create --name ${RESOURCE_GROUP} --location ${AZURE_REGION}
```

2. Create an Azure identity for the resource group:

```
$ az identity create -g ${RESOURCE_GROUP} -n ${INFRA_ID}-identity
```

This is used to grant the required access to Operators in your cluster. For example, this allows the Ingress Operator to create a public IP and its load balancer. You must assign the Azure identity to a role.

3. Grant the Contributor role to the Azure identity:

- a. Export the following variables required by the Azure role assignment:

```
$ export PRINCIPAL_ID=`az identity show -g ${RESOURCE_GROUP} -n ${INFRA_ID}-identity --query principalId --out tsv`
```

```
$ export RESOURCE_GROUP_ID=`az group show -g ${RESOURCE_GROUP} --query id --out tsv`
```

- b. Assign the Contributor role to the identity:

```
$ az role assignment create --assignee "${PRINCIPAL_ID}" --role 'Contributor' --scope "${RESOURCE_GROUP_ID}"
```

### 6.10.10. Uploading the RHCOS cluster image and bootstrap Ignition config file

The Azure client does not support deployments based on files existing locally. You must copy and store the RHCOS virtual hard disk (VHD) cluster image and bootstrap Ignition config file in a storage container so they are accessible during deployment.

#### Prerequisites

- Configure an Azure account.
- Generate the Ignition config files for your cluster.

#### Procedure

1. Create an Azure storage account to store the VHD cluster image:

```
$ az storage account create -g ${RESOURCE_GROUP} --location ${AZURE_REGION} --name ${CLUSTER_NAME}sa --kind Storage --sku Standard_LRS
```



#### WARNING

The Azure storage account name must be between 3 and 24 characters in length and use numbers and lower-case letters only. If your **CLUSTER\_NAME** variable does not follow these restrictions, you must manually define the Azure storage account name. For more information on Azure storage account name restrictions, see [Resolve errors for storage account names](#) in the Azure documentation.

2. Export the storage account key as an environment variable:

```
$ export ACCOUNT_KEY=`az storage account keys list -g ${RESOURCE_GROUP} --account-name ${CLUSTER_NAME}sa --query "[0].value" -o tsv`
```

3. Export the URL of the RHCOS VHD to an environment variable:

```
$ export VHD_URL=`openshift-install coreos print-stream-json | jq -r '.architectures.x86_64."rhel-coreos-extensions"."azure-disk".url`
```



#### IMPORTANT

The RHCOS images might not change with every release of OpenShift Container Platform. You must specify an image with the highest version that is less than or equal to the OpenShift Container Platform version that you install. Use the image version that matches your OpenShift Container Platform version if it is available.

4. Create the storage container for the VHD:

```
$ az storage container create --name vhd --account-name ${CLUSTER_NAME}sa --account-key ${ACCOUNT_KEY}
```

5. Copy the local VHD to a blob:

```
$ az storage blob copy start --account-name ${CLUSTER_NAME}sa --account-key ${ACCOUNT_KEY} --destination-blob "rhcos.vhd" --destination-container vhd --source-uri "${VHD_URL}"
```

6. Create a blob storage container and upload the generated **bootstrap.ign** file:

```
$ az storage container create --name files --account-name ${CLUSTER_NAME}sa --account-key ${ACCOUNT_KEY}
```

```
$ az storage blob upload --account-name ${CLUSTER_NAME}sa --account-key ${ACCOUNT_KEY} -c "files" -f "<installation_directory>/bootstrap.ign" -n "bootstrap.ign"
```

### 6.10.11. Example for creating DNS zones

DNS records are required for clusters that use user-provisioned infrastructure. You should choose the DNS strategy that fits your scenario.

For this example, [Azure's DNS solution](#) is used, so you will create a new public DNS zone for external (internet) visibility and a private DNS zone for internal cluster resolution.



#### NOTE

The public DNS zone is not required to exist in the same resource group as the cluster deployment and might already exist in your organization for the desired base domain. If that is the case, you can skip creating the public DNS zone; be sure the installation config you generated earlier reflects that scenario.

#### Prerequisites

- Configure an Azure account.
- Generate the Ignition config files for your cluster.

#### Procedure

1. Create the new public DNS zone in the resource group exported in the **BASE\_DOMAIN\_RESOURCE\_GROUP** environment variable:

```
$ az network dns zone create -g ${BASE_DOMAIN_RESOURCE_GROUP} -n ${CLUSTER_NAME}.${BASE_DOMAIN}
```

You can skip this step if you are using a public DNS zone that already exists.

2. Create the private DNS zone in the same resource group as the rest of this deployment:

```
$ az network private-dns zone create -g ${RESOURCE_GROUP} -n
${CLUSTER_NAME}.${BASE_DOMAIN}
```

You can learn more about [configuring a public DNS zone in Azure](#) by visiting that section.

## 6.10.12. Creating a VNet in Azure

You must create a virtual network (VNet) in Microsoft Azure for your OpenShift Container Platform cluster to use. You can customize the VNet to meet your requirements. One way to create the VNet is to modify the provided Azure Resource Manager (ARM) template.



### NOTE

If you do not use the provided ARM template to create your Azure infrastructure, you must review the provided information and manually create the infrastructure. If your cluster does not initialize correctly, you might have to contact Red Hat support with your installation logs.

### Prerequisites

- Configure an Azure account.
- Generate the Ignition config files for your cluster.

### Procedure

1. Copy the template from the **ARM template for the VNet** section of this topic and save it as **01\_vnet.json** in your cluster's installation directory. This template describes the VNet that your cluster requires.
2. Create the deployment by using the **az** CLI:

```
$ az deployment group create -g ${RESOURCE_GROUP} \
--template-file "<installation_directory>/01_vnet.json" \
--parameters baseName="${INFRA_ID}" 1
```

- 1** The base name to be used in resource names; this is usually the cluster's infrastructure ID.

3. Link the VNet template to the private DNS zone:

```
$ az network private-dns link vnet create -g ${RESOURCE_GROUP} -z
${CLUSTER_NAME}.${BASE_DOMAIN} -n ${INFRA_ID}-network-link -v "${INFRA_ID}-vnet"
-e false
```

### 6.10.12.1. ARM template for the VNet

You can use the following Azure Resource Manager (ARM) template to deploy the VNet that you need for your OpenShift Container Platform cluster:

#### Example 6.7. 01\_vnet.json ARM template

```
{
```

```

"$schema" : "https://schema.management.azure.com/schemas/2015-01-01/deploymentTemplate.json#",
"contentVersion" : "1.0.0.0",
"parameters" : {
  "baseName" : {
    "type" : "string",
    "minLength" : 1,
    "metadata" : {
      "description" : "Base name to be used in resource names (usually the cluster's Infra ID)"
    }
  }
},
"variables" : {
  "location" : "[resourceGroup().location]",
  "virtualNetworkName" : "[concat(parameters('baseName'), '-vnet')]",
  "addressPrefix" : "10.0.0.0/16",
  "masterSubnetName" : "[concat(parameters('baseName'), '-master-subnet')]",
  "masterSubnetPrefix" : "10.0.0.0/24",
  "nodeSubnetName" : "[concat(parameters('baseName'), '-worker-subnet')]",
  "nodeSubnetPrefix" : "10.0.1.0/24",
  "clusterNsgName" : "[concat(parameters('baseName'), '-nsg')]"
},
"resources" : [
  {
    "apiVersion" : "2018-12-01",
    "type" : "Microsoft.Network/virtualNetworks",
    "name" : "[variables('virtualNetworkName')]",
    "location" : "[variables('location')]",
    "dependsOn" : [
      "[concat('Microsoft.Network/networkSecurityGroups/', variables('clusterNsgName'))]"
    ],
    "properties" : {
      "addressSpace" : {
        "addressPrefixes" : [
          "[variables('addressPrefix')]"
        ]
      },
      "subnets" : [
        {
          "name" : "[variables('masterSubnetName')]",
          "properties" : {
            "addressPrefix" : "[variables('masterSubnetPrefix')]",
            "serviceEndpoints": [],
            "networkSecurityGroup" : {
              "id" : "[resourceId('Microsoft.Network/networkSecurityGroups',
variables('clusterNsgName'))]"
            }
          }
        },
        {
          "name" : "[variables('nodeSubnetName')]",
          "properties" : {
            "addressPrefix" : "[variables('nodeSubnetPrefix')]",
            "serviceEndpoints": [],
            "networkSecurityGroup" : {
              "id" : "[resourceId('Microsoft.Network/networkSecurityGroups',

```

```

variables('clusterNsgName'))]"
    }
  }
}
]
}
},
{
  "type" : "Microsoft.Network/networkSecurityGroups",
  "name" : "[variables('clusterNsgName')]",
  "apiVersion" : "2018-10-01",
  "location" : "[variables('location')]",
  "properties" : {
    "securityRules" : [
      {
        "name" : "apiserver_in",
        "properties" : {
          "protocol" : "Tcp",
          "sourcePortRange" : "*",
          "destinationPortRange" : "6443",
          "sourceAddressPrefix" : "*",
          "destinationAddressPrefix" : "*",
          "access" : "Allow",
          "priority" : 101,
          "direction" : "Inbound"
        }
      }
    ]
  }
}
]
}
]
}
}

```

### 6.10.13. Deploying the RHCOS cluster image for the Azure infrastructure

You must use a valid Red Hat Enterprise Linux CoreOS (RHCOS) image for Microsoft Azure for your OpenShift Container Platform nodes.

#### Prerequisites

- Configure an Azure account.
- Generate the Ignition config files for your cluster.
- Store the RHCOS virtual hard disk (VHD) cluster image in an Azure storage container.
- Store the bootstrap Ignition config file in an Azure storage container.

#### Procedure

1. Copy the template from the **ARM template for image storage** section of this topic and save it as **02\_storage.json** in your cluster's installation directory. This template describes the image storage that your cluster requires.



- Export the RHCOS VHD blob URL as a variable:

```
$ export VHD_BLOB_URL=`az storage blob url --account-name ${CLUSTER_NAME}sa --
account-key ${ACCOUNT_KEY} -c vhd -n "rhcos.vhd" -o tsv`
```

- Deploy the cluster image:

```
$ az deployment group create -g ${RESOURCE_GROUP} \
--template-file "<installation_directory>/02_storage.json" \
--parameters vhdBlobURL="${VHD_BLOB_URL}" \ 1 \
--parameters baseName="${INFRA_ID}" 2
```

- The blob URL of the RHCOS VHD to be used to create master and worker machines.
- The base name to be used in resource names; this is usually the cluster's infrastructure ID.

### 6.10.13.1. ARM template for image storage

You can use the following Azure Resource Manager (ARM) template to deploy the stored Red Hat Enterprise Linux CoreOS (RHCOS) image that you need for your OpenShift Container Platform cluster:

#### Example 6.8. 02\_storage.json ARM template

```
{
  "$schema" : "https://schema.management.azure.com/schemas/2015-01-01/
deploymentTemplate.json#",
  "contentVersion" : "1.0.0.0",
  "parameters" : {
    "baseName" : {
      "type" : "string",
      "minLength" : 1,
      "metadata" : {
        "description" : "Base name to be used in resource names (usually the
cluster's Infra ID)"
      }
    },
    "vhdBlobURL" : {
      "type" : "string",
      "metadata" : {
        "description" : "URL pointing to the blob where the VHD to be used
to create master and worker machines is located"
      }
    }
  },
  "variables" : {
    "location" : "[resourceGroup().location]",
    "imageName" : "[concat(parameters('baseName'), '-image')]"
  },
  "resources" : [
    {
      "apiVersion" : "2018-06-01",
      "type" : "Microsoft.Compute/images",
      "name" : "[variables('imageName')]",
      "location" : "[variables('location')]",
      "properties" : {
```

```

"storageProfile": {
  "osDisk": {
    "osType": "Linux",
    "osState": "Generalized",
    "blobUri": "[parameters('vhdBlobURL')]",
    "storageAccountType": "Standard_LRS"
  }
}
}
}
]
}

```

## 6.10.14. Networking requirements for user-provisioned infrastructure

All the Red Hat Enterprise Linux CoreOS (RHCOS) machines require networking to be configured in **initramfs** during boot to fetch their Ignition config files.

### 6.10.14.1. Network connectivity requirements

You must configure the network connectivity between machines to allow OpenShift Container Platform cluster components to communicate. Each machine must be able to resolve the hostnames of all other machines in the cluster.

This section provides details about the ports that are required.



#### IMPORTANT

In connected OpenShift Container Platform environments, all nodes are required to have internet access to pull images for platform containers and provide telemetry data to Red Hat.

Table 6.38. Ports used for all-machine to all-machine communications

Protocol	Port	Description
ICMP	N/A	Network reachability tests
TCP	<b>1936</b>	Metrics
	<b>9000-9999</b>	Host level services, including the node exporter on ports <b>9100-9101</b> and the Cluster Version Operator on port <b>9099</b> .
	<b>10250-10259</b>	The default ports that Kubernetes reserves
	<b>10256</b>	openshift-sdn
UDP	<b>4789</b>	VXLAN
	<b>6081</b>	Geneve

Protocol	Port	Description
	<b>9000-9999</b>	Host level services, including the node exporter on ports <b>9100-9101</b> .
	<b>500</b>	IPsec IKE packets
	<b>4500</b>	IPsec NAT-T packets
TCP/UDP	<b>30000-32767</b>	Kubernetes node port
ESP	N/A	IPsec Encapsulating Security Payload (ESP)

Table 6.39. Ports used for all-machine to control plane communications

Protocol	Port	Description
TCP	<b>6443</b>	Kubernetes API

Table 6.40. Ports used for control plane machine to control plane machine communications

Protocol	Port	Description
TCP	<b>2379-2380</b>	etcd server and peer ports

### 6.10.15. Creating networking and load balancing components in Azure

You must configure networking and load balancing in Microsoft Azure for your OpenShift Container Platform cluster to use. One way to create these components is to modify the provided Azure Resource Manager (ARM) template.



#### NOTE

If you do not use the provided ARM template to create your Azure infrastructure, you must review the provided information and manually create the infrastructure. If your cluster does not initialize correctly, you might have to contact Red Hat support with your installation logs.

#### Prerequisites

- Configure an Azure account.
- Generate the Ignition config files for your cluster.
- Create and configure a VNet and associated subnets in Azure.

#### Procedure

1. Copy the template from the **ARM template for the network and load balancers** section of this topic and save it as **03\_infra.json** in your cluster's installation directory. This template describes the networking and load balancing objects that your cluster requires.
2. Create the deployment by using the **az** CLI:

```
$ az deployment group create -g ${RESOURCE_GROUP} \
  --template-file "<installation_directory>/03_infra.json" \
  --parameters privateDNSZoneName="${CLUSTER_NAME}.${BASE_DOMAIN}" 1 \
  --parameters baseName="${INFRA_ID}" 2
```

**1** The name of the private DNS zone.

**2** The base name to be used in resource names; this is usually the cluster's infrastructure ID.

3. Create an **api** DNS record in the public zone for the API public load balancer. The **\${BASE\_DOMAIN\_RESOURCE\_GROUP}** variable must point to the resource group where the public DNS zone exists.

- a. Export the following variable:

```
$ export PUBLIC_IP=`az network public-ip list -g ${RESOURCE_GROUP} --query "[?
name=='${INFRA_ID}-master-pip'] | [0].ipAddress" -o tsv`
```

- b. Create the **api** DNS record in a new public zone:

```
$ az network dns record-set a add-record -g ${BASE_DOMAIN_RESOURCE_GROUP} -
z ${CLUSTER_NAME}.${BASE_DOMAIN} -n api -a ${PUBLIC_IP} --ttl 60
```

If you are adding the cluster to an existing public zone, you can create the **api** DNS record in it instead:

```
$ az network dns record-set a add-record -g ${BASE_DOMAIN_RESOURCE_GROUP} -
z ${BASE_DOMAIN} -n api.${CLUSTER_NAME} -a ${PUBLIC_IP} --ttl 60
```

### 6.10.15.1. ARM template for the network and load balancers

You can use the following Azure Resource Manager (ARM) template to deploy the networking objects and load balancers that you need for your OpenShift Container Platform cluster:

#### Example 6.9. 03\_infra.json ARM template

```
{
  "$schema" : "https://schema.management.azure.com/schemas/2015-01-
01/deploymentTemplate.json#",
  "contentVersion" : "1.0.0.0",
  "parameters" : {
    "baseName" : {
      "type" : "string",
      "minLength" : 1,
      "metadata" : {
        "description" : "Base name to be used in resource names (usually the cluster's Infra ID)"
      }
    }
  }
}
```

```

},
"vnetBaseName": {
  "type": "string",
  "defaultValue": "",
  "metadata": {
    "description": "The specific customer vnet's base name (optional)"
  }
},
"privateDNSZoneName": {
  "type": "string",
  "metadata": {
    "description": "Name of the private DNS zone"
  }
}
},
"variables": {
  "location": "[resourceGroup().location]",
  "virtualNetworkName": "[concat(if(not(empty(parameters('vnetBaseName'))),
parameters('vnetBaseName'), parameters('baseName')), '-vnet')]",
  "virtualNetworkID": "[resourceId('Microsoft.Network/virtualNetworks',
variables('virtualNetworkName'))]",
  "masterSubnetName": "[concat(if(not(empty(parameters('vnetBaseName'))),
parameters('vnetBaseName'), parameters('baseName')), '-master-subnet')]",
  "masterSubnetRef": "[concat(variables('virtualNetworkID'), '/subnets/',
variables('masterSubnetName'))]",
  "masterPublicIpAddressName": "[concat(parameters('baseName'), '-master-pip')]",
  "masterPublicIpAddressID": "[resourceId('Microsoft.Network/publicIPAddresses',
variables('masterPublicIpAddressName'))]",
  "masterLoadBalancerName": "[concat(parameters('baseName'), '-public-lb')]",
  "masterLoadBalancerID": "[resourceId('Microsoft.Network/loadBalancers',
variables('masterLoadBalancerName'))]",
  "internalLoadBalancerName": "[concat(parameters('baseName'), '-internal-lb')]",
  "internalLoadBalancerID": "[resourceId('Microsoft.Network/loadBalancers',
variables('internalLoadBalancerName'))]",
  "skuName": "Standard"
},
"resources": [
{
  "apiVersion": "2018-12-01",
  "type": "Microsoft.Network/publicIPAddresses",
  "name": "[variables('masterPublicIpAddressName')]",
  "location": "[variables('location')]",
  "sku": {
    "name": "[variables('skuName')]"
  },
  "properties": {
    "publicIPAllocationMethod": "Static",
    "dnsSettings": {
      "domainNameLabel": "[variables('masterPublicIpAddressName')]"
    }
  }
},
{
  "apiVersion": "2018-12-01",
  "type": "Microsoft.Network/loadBalancers",
  "name": "[variables('masterLoadBalancerName')]",

```

```

"location" : "[variables('location')]",
"sku": {
  "name": "[variables('skuName')]"
},
"dependsOn" : [
  "[concat('Microsoft.Network/publicIPAddresses/', variables('masterPublicIpAddressName'))]"
],
"properties" : {
  "frontendIPConfigurations" : [
    {
      "name" : "public-lb-ip",
      "properties" : {
        "publicIPAddress" : {
          "id" : "[variables('masterPublicIpAddressID')]"
        }
      }
    }
  ],
  "backendAddressPools" : [
    {
      "name" : "public-lb-backend"
    }
  ],
  "loadBalancingRules" : [
    {
      "name" : "api-internal",
      "properties" : {
        "frontendIPConfiguration" : {
          "id" : "[concat(variables('masterLoadBalancerID'), '/frontendIPConfigurations/public-lb-
ip')]"
        },
        "backendAddressPool" : {
          "id" : "[concat(variables('masterLoadBalancerID'), '/backendAddressPools/public-lb-
backend')]"
        },
        "protocol" : "Tcp",
        "loadDistribution" : "Default",
        "idleTimeoutInMinutes" : 30,
        "frontendPort" : 6443,
        "backendPort" : 6443,
        "probe" : {
          "id" : "[concat(variables('masterLoadBalancerID'), '/probes/api-internal-probe')]"
        }
      }
    }
  ],
  "probes" : [
    {
      "name" : "api-internal-probe",
      "properties" : {
        "protocol" : "Https",
        "port" : 6443,
        "requestPath" : "/readyz",
        "intervalInSeconds" : 10,
        "numberOfProbes" : 3
      }
    }
  ]
}

```

```

    }
  ]
}
},
{
  "apiVersion" : "2018-12-01",
  "type" : "Microsoft.Network/loadBalancers",
  "name" : "[variables('internalLoadBalancerName')]",
  "location" : "[variables('location')]",
  "sku": {
    "name": "[variables('skuName')]"
  },
  "properties" : {
    "frontendIPConfigurations" : [
      {
        "name" : "internal-lb-ip",
        "properties" : {
          "privateIPAllocationMethod" : "Dynamic",
          "subnet" : {
            "id" : "[variables('masterSubnetRef')]"
          },
          "privateIPAddressVersion" : "IPv4"
        }
      }
    ],
    "backendAddressPools" : [
      {
        "name" : "internal-lb-backend"
      }
    ],
    "loadBalancingRules" : [
      {
        "name" : "api-internal",
        "properties" : {
          "frontendIPConfiguration" : {
            "id" : "[concat(variables('internalLoadBalancerID'), '/frontendIPConfigurations/internal-lb-
ip')]"
          },
          "frontendPort" : 6443,
          "backendPort" : 6443,
          "enableFloatingIP" : false,
          "idleTimeoutInMinutes" : 30,
          "protocol" : "Tcp",
          "enableTcpReset" : false,
          "loadDistribution" : "Default",
          "backendAddressPool" : {
            "id" : "[concat(variables('internalLoadBalancerID'), '/backendAddressPools/internal-lb-
backend')]"
          },
          "probe" : {
            "id" : "[concat(variables('internalLoadBalancerID'), '/probes/api-internal-probe')]"
          }
        }
      }
    ],
    {
      "name" : "sint",

```

```

    "properties" : {
      "frontendIPConfiguration" : {
        "id" : "[concat(variables('internalLoadBalancerID'), '/frontendIPConfigurations/internal-lb-
ip)']"
      },
      "frontendPort" : 22623,
      "backendPort" : 22623,
      "enableFloatingIP" : false,
      "idleTimeoutInMinutes" : 30,
      "protocol" : "Tcp",
      "enableTcpReset" : false,
      "loadDistribution" : "Default",
      "backendAddressPool" : {
        "id" : "[concat(variables('internalLoadBalancerID'), '/backendAddressPools/internal-lb-
backend)']"
      },
      "probe" : {
        "id" : "[concat(variables('internalLoadBalancerID'), '/probes/sint-probe)']"
      }
    }
  ],
  "probes" : [
    {
      "name" : "api-internal-probe",
      "properties" : {
        "protocol" : "Https",
        "port" : 6443,
        "requestPath" : "/readyz",
        "intervalInSeconds" : 10,
        "numberOfProbes" : 3
      }
    },
    {
      "name" : "sint-probe",
      "properties" : {
        "protocol" : "Https",
        "port" : 22623,
        "requestPath" : "/healthz",
        "intervalInSeconds" : 10,
        "numberOfProbes" : 3
      }
    }
  ]
},
{
  "apiVersion": "2018-09-01",
  "type": "Microsoft.Network/privateDnsZones/A",
  "name": "[concat(parameters('privateDNSZoneName'), '/api')]",
  "location": "[variables('location')]",
  "dependsOn" : [
    "[concat('Microsoft.Network/loadBalancers/', variables('internalLoadBalancerName'))]"
  ],
  "properties": {
    "ttl": 60,

```



```

    "aRecords": [
      {
        "ipv4Address": "[reference(variables('internalLoadBalancerName')).frontendIPConfigurations[0].properties.privateIP
Address]"
      }
    ]
  },
  {
    "apiVersion": "2018-09-01",
    "type": "Microsoft.Network/privateDnsZones/A",
    "name": "[concat(parameters('privateDNSZoneName'), '/api-int')]",
    "location": "[variables('location')]",
    "dependsOn": [
      "[concat('Microsoft.Network/loadBalancers/', variables('internalLoadBalancerName'))]"
    ],
    "properties": {
      "ttl": 60,
      "aRecords": [
        {
          "ipv4Address": "[reference(variables('internalLoadBalancerName')).frontendIPConfigurations[0].properties.privateIP
Address]"
        }
      ]
    }
  }
]
}

```

### 6.10.16. Creating the bootstrap machine in Azure

You must create the bootstrap machine in Microsoft Azure to use during OpenShift Container Platform cluster initialization. One way to create this machine is to modify the provided Azure Resource Manager (ARM) template.

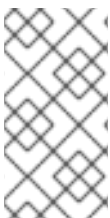

#### NOTE

If you do not use the provided ARM template to create your bootstrap machine, you must review the provided information and manually create the infrastructure. If your cluster does not initialize correctly, you might have to contact Red Hat support with your installation logs.

#### Prerequisites

- Configure an Azure account.
- Generate the Ignition config files for your cluster.
- Create and configure a VNet and associated subnets in Azure.
- Create and configure networking and load balancers in Azure.

- Create control plane and compute roles.

## Procedure

1. Copy the template from the **ARM template for the bootstrap machine** section of this topic and save it as **04\_bootstrap.json** in your cluster's installation directory. This template describes the bootstrap machine that your cluster requires.
2. Export the bootstrap URL variable:

```
$ bootstrap_url_expiry=`date -u -d "10 hours" '+%Y-%m-%dT%H:%MZ`
```

```
$ export BOOTSTRAP_URL=`az storage blob generate-sas -c 'files' -n 'bootstrap.ign' --https-only --full-uri --permissions r --expiry $bootstrap_url_expiry --account-name ${CLUSTER_NAME}sa --account-key ${ACCOUNT_KEY} -o tsv`
```

3. Export the bootstrap ignition variable:

```
$ export BOOTSTRAP_IGNITION=`jq -rcnM --arg v "3.2.0" --arg url ${BOOTSTRAP_URL} '{ignition:{version:$v,config:{replace:{source:$url}}}}' | base64 | tr -d '\n`
```

4. Create the deployment by using the **az** CLI:

```
$ az deployment group create -g ${RESOURCE_GROUP} \
  --template-file "<installation_directory>/04_bootstrap.json" \
  --parameters bootstrapIgnition="${BOOTSTRAP_IGNITION}" \ 1
  --parameters baseName="${INFRA_ID}" 2
```

**1** The bootstrap Ignition content for the bootstrap cluster.

**2** The base name to be used in resource names; this is usually the cluster's infrastructure ID.

### 6.10.16.1. ARM template for the bootstrap machine

You can use the following Azure Resource Manager (ARM) template to deploy the bootstrap machine that you need for your OpenShift Container Platform cluster:

#### Example 6.10. 04\_bootstrap.json ARM template

```
{
  "$schema" : "https://schema.management.azure.com/schemas/2015-01-01/deploymentTemplate.json#",
  "contentVersion" : "1.0.0.0",
  "parameters" : {
    "baseName" : {
      "type" : "string",
      "minLength" : 1,
      "metadata" : {
        "description" : "Base name to be used in resource names (usually the cluster's Infra ID)"
      }
    },
    "vnetBaseName": {
```

```

    "type": "string",
    "defaultValue": "",
    "metadata": {
      "description": "The specific customer vnet's base name (optional)"
    }
  },
  "bootstrapIgnition": {
    "type": "string",
    "minLength": 1,
    "metadata": {
      "description": "Bootstrap ignition content for the bootstrap cluster"
    }
  },
  "sshKeyData": {
    "type": "securestring",
    "defaultValue": "Unused",
    "metadata": {
      "description": "Unused"
    }
  },
  "bootstrapVMSize": {
    "type": "string",
    "defaultValue": "Standard_D4s_v3",
    "metadata": {
      "description": "The size of the Bootstrap Virtual Machine"
    }
  }
},
"variables": {
  "location": "[resourceGroup().location]",
  "virtualNetworkName": "[concat(if(not(empty(parameters('vnetBaseName'))),
parameters('vnetBaseName'), parameters('baseName')), '-vnet')]",
  "virtualNetworkID": "[resourceId('Microsoft.Network/virtualNetworks',
variables('virtualNetworkName'))]",
  "masterSubnetName": "[concat(if(not(empty(parameters('vnetBaseName'))),
parameters('vnetBaseName'), parameters('baseName')), '-master-subnet')]",
  "masterSubnetRef": "[concat(variables('virtualNetworkID'), '/subnets/',
variables('masterSubnetName'))]",
  "masterLoadBalancerName": "[concat(parameters('baseName'), '-public-lb')]",
  "internalLoadBalancerName": "[concat(parameters('baseName'), '-internal-lb')]",
  "sshKeyPath": "/home/core/.ssh/authorized_keys",
  "identityName": "[concat(parameters('baseName'), '-identity')]",
  "vmName": "[concat(parameters('baseName'), '-bootstrap')]",
  "nicName": "[concat(variables('vmName'), '-nic')]",
  "imageName": "[concat(parameters('baseName'), '-image')]",
  "clusterNsgName": "[concat(if(not(empty(parameters('vnetBaseName'))),
parameters('vnetBaseName'), parameters('baseName')), '-nsg')]",
  "sshPublicIpAddressName": "[concat(variables('vmName'), '-ssh-pip')]"
},
"resources": [
  {
    "apiVersion": "2018-12-01",
    "type": "Microsoft.Network/publicIPAddresses",
    "name": "[variables('sshPublicIpAddressName')]",
    "location": "[variables('location')]",
    "sku": {

```

```

    "name": "Standard"
  },
  "properties" : {
    "publicIPAllocationMethod" : "Static",
    "dnsSettings" : {
      "domainNameLabel" : "[variables('sshPublicIpAddressName')]"
    }
  }
},
{
  "apiVersion" : "2018-06-01",
  "type" : "Microsoft.Network/networkInterfaces",
  "name" : "[variables('nicName')]",
  "location" : "[variables('location')]",
  "dependsOn" : [
    "[resourceId('Microsoft.Network/publicIPAddresses', variables('sshPublicIpAddressName'))]"
  ],
  "properties" : {
    "ipConfigurations" : [
      {
        "name" : "pipConfig",
        "properties" : {
          "privateIPAllocationMethod" : "Dynamic",
          "publicIPAddress": {
            "id": "[resourceId('Microsoft.Network/publicIPAddresses',
variables('sshPublicIpAddressName'))]"
          },
          "subnet" : {
            "id" : "[variables('masterSubnetRef')]"
          },
          "loadBalancerBackendAddressPools" : [
            {
              "id" : "[concat('/subscriptions/', subscription().subscriptionId, '/resourceGroups/',
resourceGroup().name, '/providers/Microsoft.Network/loadBalancers/',
variables('masterLoadBalancerName'), '/backendAddressPools/public-lb-backend')]"
            },
            {
              "id" : "[concat('/subscriptions/', subscription().subscriptionId, '/resourceGroups/',
resourceGroup().name, '/providers/Microsoft.Network/loadBalancers/',
variables('internalLoadBalancerName'), '/backendAddressPools/internal-lb-backend')]"
            }
          ]
        }
      }
    ]
  }
},
{
  "apiVersion" : "2018-06-01",
  "type" : "Microsoft.Compute/virtualMachines",
  "name" : "[variables('vmName')]",
  "location" : "[variables('location')]",
  "identity" : {
    "type" : "userAssigned",
    "userAssignedIdentities" : {
      "[resourceID('Microsoft.ManagedIdentity/userAssignedIdentities/',

```

```

variables('identityName'))" : {}
    }
  },
  "dependsOn" : [
    "[concat('Microsoft.Network/networkInterfaces/', variables('nicName'))]"
  ],
  "properties" : {
    "hardwareProfile" : {
      "vmSize" : "[parameters('bootstrapVMSize')]"
    },
    "osProfile" : {
      "computerName" : "[variables('vmName')]",
      "adminUsername" : "core",
      "adminPassword" : "NotActuallyApplied!",
      "customData" : "[parameters('bootstrapIgnition')]",
      "linuxConfiguration" : {
        "disablePasswordAuthentication" : false
      }
    },
    "storageProfile" : {
      "imageReference" : {
        "id" : "[resourceId('Microsoft.Compute/images', variables('imageName'))]"
      },
      "osDisk" : {
        "name" : "[concat(variables('vmName'),'_OSDisk')]",
        "osType" : "Linux",
        "createOption" : "FromImage",
        "managedDisk" : {
          "storageAccountType" : "Premium_LRS"
        },
        "diskSizeGB" : 100
      }
    },
    "networkProfile" : {
      "networkInterfaces" : [
        {
          "id" : "[resourceId('Microsoft.Network/networkInterfaces', variables('nicName'))]"
        }
      ]
    }
  }
},
{
  "apiVersion" : "2018-06-01",
  "type" : "Microsoft.Network/networkSecurityGroups/securityRules",
  "name" : "[concat(variables('clusterNsgName'), '/bootstrap_ssh_in')]",
  "location" : "[variables('location')]",
  "dependsOn" : [
    "[resourceId('Microsoft.Compute/virtualMachines', variables('vmName'))]"
  ],
  "properties" : {
    "protocol" : "Tcp",
    "sourcePortRange" : "*",
    "destinationPortRange" : "22",
    "sourceAddressPrefix" : "*",
    "destinationAddressPrefix" : "*"
  }
}

```

```

"access" : "Allow",
"priority" : 100,
"direction" : "Inbound"
}
}
]
}

```

### 6.10.17. Creating the control plane machines in Azure

You must create the control plane machines in Microsoft Azure for your cluster to use. One way to create these machines is to modify the provided Azure Resource Manager (ARM) template.



#### NOTE

By default, Microsoft Azure places control plane machines and compute machines in a pre-set availability zone. You can manually set an availability zone for a compute node or control plane node. To do this, modify a vendor's Azure Resource Manager (ARM) template by specifying each of your availability zones in the **zones** parameter of the virtual machine resource.

If you do not use the provided ARM template to create your control plane machines, you must review the provided information and manually create the infrastructure. If your cluster does not initialize correctly, consider contacting Red Hat support with your installation logs.

#### Prerequisites

- Configure an Azure account.
- Generate the Ignition config files for your cluster.
- Create and configure a VNet and associated subnets in Azure.
- Create and configure networking and load balancers in Azure.
- Create control plane and compute roles.
- Create the bootstrap machine.

#### Procedure

1. Copy the template from the **ARM template for control plane machines** section of this topic and save it as **05\_masters.json** in your cluster's installation directory. This template describes the control plane machines that your cluster requires.
2. Export the following variable needed by the control plane machine deployment:

```
$ export MASTER_IGNITION=`cat <installation_directory>/master.ign | base64 | tr -d "\n`
```

3. Create the deployment by using the **az** CLI:

```
$ az deployment group create -g ${RESOURCE_GROUP} \
  --template-file "<installation_directory>/05_masters.json" \
```

```
--parameters masterIgnition="${MASTER_IGNITION}" \ 1
--parameters baseName="${INFRA_ID}" 2
```

- 1** The Ignition content for the control plane nodes.
- 2** The base name to be used in resource names; this is usually the cluster's infrastructure ID.

### 6.10.17.1. ARM template for control plane machines

You can use the following Azure Resource Manager (ARM) template to deploy the control plane machines that you need for your OpenShift Container Platform cluster:

#### Example 6.11. 05\_masters.json ARM template

```
{
  "$schema" : "https://schema.management.azure.com/schemas/2015-01-01/deploymentTemplate.json#",
  "contentVersion" : "1.0.0.0",
  "parameters" : {
    "baseName" : {
      "type" : "string",
      "minLength" : 1,
      "metadata" : {
        "description" : "Base name to be used in resource names (usually the cluster's Infra ID)"
      }
    },
    "vnetBaseName" : {
      "type" : "string",
      "defaultValue" : "",
      "metadata" : {
        "description" : "The specific customer vnet's base name (optional)"
      }
    },
    "masterIgnition" : {
      "type" : "string",
      "metadata" : {
        "description" : "Ignition content for the master nodes"
      }
    },
    "numberOfMasters" : {
      "type" : "int",
      "defaultValue" : 3,
      "minValue" : 2,
      "maxValue" : 30,
      "metadata" : {
        "description" : "Number of OpenShift masters to deploy"
      }
    },
    "sshKeyData" : {
      "type" : "securestring",
      "defaultValue" : "Unused",
      "metadata" : {
        "description" : "Unused"
      }
    }
  }
}
```

```

},
"privateDNSZoneName" : {
  "type" : "string",
  "defaultValue" : "",
  "metadata" : {
    "description" : "unused"
  }
},
"masterVMSize" : {
  "type" : "string",
  "defaultValue" : "Standard_D8s_v3",
  "metadata" : {
    "description" : "The size of the Master Virtual Machines"
  }
},
"diskSizeGB" : {
  "type" : "int",
  "defaultValue" : 1024,
  "metadata" : {
    "description" : "Size of the Master VM OS disk, in GB"
  }
},
"variables" : {
  "location" : "[resourceGroup().location]",
  "virtualNetworkName" : "[concat(if(not(empty(parameters('vnetBaseName'))),
parameters('vnetBaseName'), parameters('baseName')), '-vnet')]",
  "virtualNetworkID" : "[resourceId('Microsoft.Network/virtualNetworks',
variables('virtualNetworkName'))]",
  "masterSubnetName" : "[concat(if(not(empty(parameters('vnetBaseName'))),
parameters('vnetBaseName'), parameters('baseName')), '-master-subnet')]",
  "masterSubnetRef" : "[concat(variables('virtualNetworkID'), '/subnets/',
variables('masterSubnetName'))]",
  "masterLoadBalancerName" : "[concat(parameters('baseName'), '-public-lb')]",
  "internalLoadBalancerName" : "[concat(parameters('baseName'), '-internal-lb')]",
  "sshKeyPath" : "/home/core/.ssh/authorized_keys",
  "identityName" : "[concat(parameters('baseName'), '-identity')]",
  "imageName" : "[concat(parameters('baseName'), '-image')]",
  "copy" : [
    {
      "name" : "vmNames",
      "count" : "[parameters('numberOfMasters')]",
      "input" : "[concat(parameters('baseName'), '-master-', copyIndex('vmNames'))]"
    }
  ]
},
"resources" : [
{
  "apiVersion" : "2018-06-01",
  "type" : "Microsoft.Network/networkInterfaces",
  "copy" : {
    "name" : "nicCopy",
    "count" : "[length(variables('vmNames'))]"
  },
  "name" : "[concat(variables('vmNames')[copyIndex()], '-nic')]",
  "location" : "[variables('location')]",

```



```

"properties" : {
  "ipConfigurations" : [
    {
      "name" : "pipConfig",
      "properties" : {
        "privateIPAllocationMethod" : "Dynamic",
        "subnet" : {
          "id" : "[variables('masterSubnetRef')]"
        },
        "loadBalancerBackendAddressPools" : [
          {
            "id" : "[concat('/subscriptions/', subscription().subscriptionId, '/resourceGroups/',
resourceGroup().name, '/providers/Microsoft.Network/loadBalancers/',
variables('masterLoadBalancerName'), '/backendAddressPools/public-lb-backend')]"
          },
          {
            "id" : "[concat('/subscriptions/', subscription().subscriptionId, '/resourceGroups/',
resourceGroup().name, '/providers/Microsoft.Network/loadBalancers/',
variables('internalLoadBalancerName'), '/backendAddressPools/internal-lb-backend')]"
          }
        ]
      }
    }
  ]
},
{
  "apiVersion" : "2018-06-01",
  "type" : "Microsoft.Compute/virtualMachines",
  "copy" : {
    "name" : "vmCopy",
    "count" : "[length(variables('vmNames'))]"
  },
  "name" : "[variables('vmNames')[copyIndex()]]",
  "location" : "[variables('location')]",
  "identity" : {
    "type" : "userAssigned",
    "userAssignedIdentities" : {
      "[resourceID('Microsoft.ManagedIdentity/userAssignedIdentities/',
variables('identityName'))]" : {}
    }
  },
  "dependsOn" : [
    "[concat('Microsoft.Network/networkInterfaces/', concat(variables('vmNames')[copyIndex()], '-
nic'))]"
  ],
  "properties" : {
    "hardwareProfile" : {
      "vmSize" : "[parameters('masterVMSize')]"
    },
    "osProfile" : {
      "computerName" : "[variables('vmNames')[copyIndex()]]",
      "adminUsername" : "core",
      "adminPassword" : "NotActuallyApplied!",
      "customData" : "[parameters('masterIgnition')]",
      "linuxConfiguration" : {

```

```

        "disablePasswordAuthentication" : false
      }
    },
    "storageProfile" : {
      "imageReference": {
        "id": "[resourceId('Microsoft.Compute/images', variables('imageName'))]"
      },
      "osDisk" : {
        "name": "[concat(variables('vmNames')[copyIndex()], '_OSDisk')]",
        "osType" : "Linux",
        "createOption" : "FromImage",
        "caching": "ReadOnly",
        "writeAcceleratorEnabled": false,
        "managedDisk": {
          "storageAccountType": "Premium_LRS"
        },
        "diskSizeGB" : "[parameters('diskSizeGB')]"
      }
    },
    "networkProfile" : {
      "networkInterfaces" : [
        {
          "id" : "[resourceId('Microsoft.Network/networkInterfaces', concat(variables('vmNames')
[copyIndex()], '-nic'))]",
          "properties": {
            "primary": false
          }
        }
      ]
    }
  }
]
}

```

### 6.10.18. Wait for bootstrap completion and remove bootstrap resources in Azure

After you create all of the required infrastructure in Microsoft Azure, wait for the bootstrap process to complete on the machines that you provisioned by using the Ignition config files that you generated with the installation program.

#### Prerequisites

- Configure an Azure account.
- Generate the Ignition config files for your cluster.
- Create and configure a VNet and associated subnets in Azure.
- Create and configure networking and load balancers in Azure.
- Create control plane and compute roles.
- Create the bootstrap machine.

- Create the control plane machines.

## Procedure

1. Change to the directory that contains the installation program and run the following command:

```
$ ./openshift-install wait-for bootstrap-complete --dir <installation_directory> \ ❶
--log-level info ❷
```

- ❶ For **<installation\_directory>**, specify the path to the directory that you stored the installation files in.

- ❷ To view different installation details, specify **warn**, **debug**, or **error** instead of **info**.

If the command exits without a **FATAL** warning, your production control plane has initialized.

2. Delete the bootstrap resources:

```
$ az network nsg rule delete -g ${RESOURCE_GROUP} --nsg-name ${INFRA_ID}-nsg --
name bootstrap_ssh_in
$ az vm stop -g ${RESOURCE_GROUP} --name ${INFRA_ID}-bootstrap
$ az vm deallocate -g ${RESOURCE_GROUP} --name ${INFRA_ID}-bootstrap
$ az vm delete -g ${RESOURCE_GROUP} --name ${INFRA_ID}-bootstrap --yes
$ az disk delete -g ${RESOURCE_GROUP} --name ${INFRA_ID}-bootstrap OSDisk --no-
wait --yes
$ az network nic delete -g ${RESOURCE_GROUP} --name ${INFRA_ID}-bootstrap-nic --no-
wait
$ az storage blob delete --account-key ${ACCOUNT_KEY} --account-name
${CLUSTER_NAME}sa --container-name files --name bootstrap.ign
$ az network public-ip delete -g ${RESOURCE_GROUP} --name ${INFRA_ID}-bootstrap-
ssh-pip
```



### NOTE

If you do not delete the bootstrap server, installation may not succeed due to API traffic being routed to the bootstrap server.

## 6.10.19. Creating additional worker machines in Azure

You can create worker machines in Microsoft Azure for your cluster to use by launching individual instances discretely or by automated processes outside the cluster, such as auto scaling groups. You can also take advantage of the built-in cluster scaling mechanisms and the machine API in OpenShift Container Platform.

In this example, you manually launch one instance by using the Azure Resource Manager (ARM) template. Additional instances can be launched by including additional resources of type **06\_workers.json** in the file.

**NOTE**

By default, Microsoft Azure places control plane machines and compute machines in a pre-set availability zone. You can manually set an availability zone for a compute node or control plane node. To do this, modify a vendor's ARM template by specifying each of your availability zones in the **zones** parameter of the virtual machine resource.

If you do not use the provided ARM template to create your control plane machines, you must review the provided information and manually create the infrastructure. If your cluster does not initialize correctly, consider contacting Red Hat support with your installation logs.

**Prerequisites**

- Configure an Azure account.
- Generate the Ignition config files for your cluster.
- Create and configure a VNet and associated subnets in Azure.
- Create and configure networking and load balancers in Azure.
- Create control plane and compute roles.
- Create the bootstrap machine.
- Create the control plane machines.

**Procedure**

1. Copy the template from the **ARM template for worker machines** section of this topic and save it as **06\_workers.json** in your cluster's installation directory. This template describes the worker machines that your cluster requires.
2. Export the following variable needed by the worker machine deployment:

```
$ export WORKER_IGNITION=`cat <installation_directory>/worker.ign | base64 | tr -d '\n'`
```

3. Create the deployment by using the **az** CLI:

```
$ az deployment group create -g ${RESOURCE_GROUP} \
  --template-file "<installation_directory>/06_workers.json" \
  --parameters workerIgnition="${WORKER_IGNITION}" \ 1
  --parameters baseName="${INFRA_ID}" 2
```

- 1** The Ignition content for the worker nodes.
- 2** The base name to be used in resource names; this is usually the cluster's infrastructure ID.

**6.10.19.1. ARM template for worker machines**

You can use the following Azure Resource Manager (ARM) template to deploy the worker machines that you need for your OpenShift Container Platform cluster:

## Example 6.12. 06\_workers.json ARM template

```

{
  "$schema" : "https://schema.management.azure.com/schemas/2015-01-01/deploymentTemplate.json#",
  "contentVersion" : "1.0.0.0",
  "parameters" : {
    "baseName" : {
      "type" : "string",
      "minLength" : 1,
      "metadata" : {
        "description" : "Base name to be used in resource names (usually the cluster's Infra ID)"
      }
    },
    "vnetBaseName": {
      "type": "string",
      "defaultValue": "",
      "metadata" : {
        "description" : "The specific customer vnet's base name (optional)"
      }
    },
    "workerIgnition" : {
      "type" : "string",
      "metadata" : {
        "description" : "Ignition content for the worker nodes"
      }
    },
    "numberOfNodes" : {
      "type" : "int",
      "defaultValue" : 3,
      "minValue" : 2,
      "maxValue" : 30,
      "metadata" : {
        "description" : "Number of OpenShift compute nodes to deploy"
      }
    },
    "sshKeyData" : {
      "type" : "securestring",
      "defaultValue" : "Unused",
      "metadata" : {
        "description" : "Unused"
      }
    },
    "nodeVMSize" : {
      "type" : "string",
      "defaultValue" : "Standard_D4s_v3",
      "metadata" : {
        "description" : "The size of the each Node Virtual Machine"
      }
    }
  },
  "variables" : {
    "location" : "[resourceGroup().location]",
    "virtualNetworkName" : "[concat(if(not(empty(parameters('vnetBaseName'))),
parameters('vnetBaseName'), parameters('baseName')), '-vnet')]",
    "virtualNetworkID" : "[resourceId('Microsoft.Network/virtualNetworks',

```

```

variables('virtualNetworkName'))]",
  "nodeSubnetName" : "[concat(if(not(empty(parameters('vnetBaseName'))),
parameters('vnetBaseName'), parameters('baseName')), '-worker-subnet')]",
  "nodeSubnetRef" : "[concat(variables('virtualNetworkID'), '/subnets/',
variables('nodeSubnetName'))]",
  "infraLoadBalancerName" : "[parameters('baseName')]",
  "sshKeyPath" : "/home/capi/.ssh/authorized_keys",
  "identityName" : "[concat(parameters('baseName'), '-identity')]",
  "imageName" : "[concat(parameters('baseName'), '-image')]",
  "copy" : [
    {
      "name" : "vmNames",
      "count" : "[parameters('numberOfNodes')]",
      "input" : "[concat(parameters('baseName'), '-worker-', variables('location'), '-',
copyIndex('vmNames', 1))]"
    }
  ],
},
"resources" : [
{
  "apiVersion" : "2019-05-01",
  "name" : "[concat('node', copyIndex())]",
  "type" : "Microsoft.Resources/deployments",
  "copy" : {
    "name" : "nodeCopy",
    "count" : "[length(variables('vmNames'))]"
  },
  "properties" : {
    "mode" : "Incremental",
    "template" : {
      "$schema" : "http://schema.management.azure.com/schemas/2015-01-
01/deploymentTemplate.json#",
      "contentVersion" : "1.0.0.0",
      "resources" : [
        {
          "apiVersion" : "2018-06-01",
          "type" : "Microsoft.Network/networkInterfaces",
          "name" : "[concat(variables('vmNames')[copyIndex()], '-nic')]",
          "location" : "[variables('location')]",
          "properties" : {
            "ipConfigurations" : [
              {
                "name" : "pipConfig",
                "properties" : {
                  "privateIPAllocationMethod" : "Dynamic",
                  "subnet" : {
                    "id" : "[variables('nodeSubnetRef')]"
                  }
                }
              }
            ]
          }
        }
      ]
    }
  },
{
  "apiVersion" : "2018-06-01",
  "type" : "Microsoft.Compute/virtualMachines",

```

```

"name" : "[variables('vmNames')[copyIndex()]]",
"location" : "[variables('location')]",
"tags" : {
  "kubernetes.io-cluster-ffranzupi": "owned"
},
"identity" : {
  "type" : "userAssigned",
  "userAssignedIdentities" : {
    "[resourceID('Microsoft.ManagedIdentity/userAssignedIdentities/',
variables('identityName'))]" : {}
  }
},
"dependsOn" : [
  "[concat('Microsoft.Network/networkInterfaces/', concat(variables('vmNames')
[copyIndex()], '-nic'))]"
],
"properties" : {
  "hardwareProfile" : {
    "vmSize" : "[parameters('nodeVMSize')]"
  },
  "osProfile" : {
    "computerName" : "[variables('vmNames')[copyIndex()]]",
    "adminUsername" : "capi",
    "adminPassword" : "NotActuallyApplied!",
    "customData" : "[parameters('workerIgnition')]",
    "linuxConfiguration" : {
      "disablePasswordAuthentication" : false
    }
  },
  "storageProfile" : {
    "imageReference": {
      "id": "[resourceId('Microsoft.Compute/images', variables('imageName'))]"
    },
    "osDisk" : {
      "name": "[concat(variables('vmNames')[copyIndex()], '_OSDisk')]",
      "osType" : "Linux",
      "createOption" : "FromImage",
      "managedDisk": {
        "storageAccountType": "Premium_LRS"
      },
      "diskSizeGB": 128
    }
  },
  "networkProfile" : {
    "networkInterfaces" : [
      {
        "id" : "[resourceId('Microsoft.Network/networkInterfaces',
concat(variables('vmNames')[copyIndex()], '-nic'))]",
        "properties": {
          "primary": true
        }
      }
    ]
  }
}
}
}

```



### 6.10.20. Installing the OpenShift CLI by downloading the binary

You can install the OpenShift CLI (**oc**) to interact with OpenShift Container Platform from a command-line interface. You can install **oc** on Linux, Windows, or macOS.

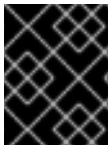

#### IMPORTANT

If you installed an earlier version of **oc**, you cannot use it to complete all of the commands in OpenShift Container Platform 4.10. Download and install the new version of **oc**.

#### Installing the OpenShift CLI on Linux

You can install the OpenShift CLI (**oc**) binary on Linux by using the following procedure.

##### Procedure

1. Navigate to the [OpenShift Container Platform downloads page](#) on the Red Hat Customer Portal.
2. Select the appropriate version in the **Version** drop-down menu.
3. Click **Download Now** next to the **OpenShift v4.10 Linux Client** entry and save the file.
4. Unpack the archive:

```
$ tar xvf <file>
```

5. Place the **oc** binary in a directory that is on your **PATH**.  
To check your **PATH**, execute the following command:

```
$ echo $PATH
```

After you install the OpenShift CLI, it is available using the **oc** command:

```
$ oc <command>
```

#### Installing the OpenShift CLI on Windows

You can install the OpenShift CLI (**oc**) binary on Windows by using the following procedure.

##### Procedure

1. Navigate to the [OpenShift Container Platform downloads page](#) on the Red Hat Customer Portal.
2. Select the appropriate version in the **Version** drop-down menu.



3. Click **Download Now** next to the **OpenShift v4.10 Windows Client** entry and save the file.
4. Unzip the archive with a ZIP program.
5. Move the **oc** binary to a directory that is on your **PATH**.  
To check your **PATH**, open the command prompt and execute the following command:

```
C:\> path
```

After you install the OpenShift CLI, it is available using the **oc** command:

```
C:\> oc <command>
```

### Installing the OpenShift CLI on macOS

You can install the OpenShift CLI (**oc**) binary on macOS by using the following procedure.

#### Procedure

1. Navigate to the [OpenShift Container Platform downloads page](#) on the Red Hat Customer Portal.
2. Select the appropriate version in the **Version** drop-down menu.
3. Click **Download Now** next to the **OpenShift v4.10 MacOSX Client** entry and save the file.
4. Unpack and unzip the archive.
5. Move the **oc** binary to a directory on your PATH.  
To check your **PATH**, open a terminal and execute the following command:

```
$ echo $PATH
```

After you install the OpenShift CLI, it is available using the **oc** command:

```
$ oc <command>
```

### 6.10.21. Logging in to the cluster by using the CLI

You can log in to your cluster as a default system user by exporting the cluster **kubeconfig** file. The **kubeconfig** file contains information about the cluster that is used by the CLI to connect a client to the correct cluster and API server. The file is specific to a cluster and is created during OpenShift Container Platform installation.

#### Prerequisites

- You deployed an OpenShift Container Platform cluster.
- You installed the **oc** CLI.

#### Procedure

1. Export the **kubeadmin** credentials:

```
$ export KUBECONFIG=<installation_directory>/auth/kubeconfig 1
```

- 1** For **<installation\_directory>**, specify the path to the directory that you stored the installation files in.

2. Verify you can run **oc** commands successfully using the exported configuration:

```
$ oc whoami
```

### Example output

```
system:admin
```

## 6.10.22. Approving the certificate signing requests for your machines

When you add machines to a cluster, two pending certificate signing requests (CSRs) are generated for each machine that you added. You must confirm that these CSRs are approved or, if necessary, approve them yourself. The client requests must be approved first, followed by the server requests.

### Prerequisites

- You added machines to your cluster.

### Procedure

1. Confirm that the cluster recognizes the machines:

```
$ oc get nodes
```

### Example output

```
NAME      STATUS  ROLES  AGE  VERSION
master-0  Ready   master 63m  v1.23.0
master-1  Ready   master 63m  v1.23.0
master-2  Ready   master 64m  v1.23.0
```

The output lists all of the machines that you created.



### NOTE

The preceding output might not include the compute nodes, also known as worker nodes, until some CSRs are approved.

2. Review the pending CSRs and ensure that you see the client requests with the **Pending** or **Approved** status for each machine that you added to the cluster:

```
$ oc get csr
```

### Example output

NAME	AGE	REQUESTOR	CONDITION
csr-8b2br	15m	system:serviceaccount:openshift-machine-config-operator:node-bootstrapper	Pending
csr-8vnps	15m	system:serviceaccount:openshift-machine-config-operator:node-bootstrapper	Pending
...			

In this example, two machines are joining the cluster. You might see more approved CSRs in the list.

- If the CSRs were not approved, after all of the pending CSRs for the machines you added are in **Pending** status, approve the CSRs for your cluster machines:



#### NOTE

Because the CSRs rotate automatically, approve your CSRs within an hour of adding the machines to the cluster. If you do not approve them within an hour, the certificates will rotate, and more than two certificates will be present for each node. You must approve all of these certificates. After the client CSR is approved, the Kubelet creates a secondary CSR for the serving certificate, which requires manual approval. Then, subsequent serving certificate renewal requests are automatically approved by the **machine-approver** if the Kubelet requests a new certificate with identical parameters.



#### NOTE

For clusters running on platforms that are not machine API enabled, such as bare metal and other user-provisioned infrastructure, you must implement a method of automatically approving the kubelet serving certificate requests (CSRs). If a request is not approved, then the **oc exec**, **oc rsh**, and **oc logs** commands cannot succeed, because a serving certificate is required when the API server connects to the kubelet. Any operation that contacts the Kubelet endpoint requires this certificate approval to be in place. The method must watch for new CSRs, confirm that the CSR was submitted by the **node-bootstrapper** service account in the **system:node** or **system:admin** groups, and confirm the identity of the node.

- To approve them individually, run the following command for each valid CSR:

```
$ oc adm certificate approve <csr_name> 1
```

- 1** **<csr\_name>** is the name of a CSR from the list of current CSRs.

- To approve all pending CSRs, run the following command:

```
$ oc get csr -o go-template='{{range .items}}{{if not .status}}{{.metadata.name}}{"\n"}\n{{end}}{{end}}' | xargs --no-run-if-empty oc adm certificate approve
```



#### NOTE

Some Operators might not become available until some CSRs are approved.

- Now that your client requests are approved, you must review the server requests for each machine that you added to the cluster:

```
$ oc get csr
```

### Example output

```
NAME      AGE   REQUESTOR                                     CONDITION
csr-bfd72 5m26s system:node:ip-10-0-50-126.us-east-2.compute.internal
Pending
csr-c57lv 5m26s system:node:ip-10-0-95-157.us-east-2.compute.internal
Pending
...
```

- If the remaining CSRs are not approved, and are in the **Pending** status, approve the CSRs for your cluster machines:

- To approve them individually, run the following command for each valid CSR:

```
$ oc adm certificate approve <csr_name> 1
```

- 1** **<csr\_name>** is the name of a CSR from the list of current CSRs.

- To approve all pending CSRs, run the following command:

```
$ oc get csr -o go-template='{{range .items}}{{if not .status}}{{.metadata.name}}{\n"}\n{{end}}' | xargs oc adm certificate approve
```

- After all client and server CSRs have been approved, the machines have the **Ready** status. Verify this by running the following command:

```
$ oc get nodes
```

### Example output

```
NAME      STATUS  ROLES  AGE  VERSION
master-0  Ready   master 73m  v1.23.0
master-1  Ready   master 73m  v1.23.0
master-2  Ready   master 74m  v1.23.0
worker-0  Ready   worker 11m  v1.23.0
worker-1  Ready   worker 11m  v1.23.0
```



### NOTE

It can take a few minutes after approval of the server CSRs for the machines to transition to the **Ready** status.

### Additional information

- For more information on CSRs, see [Certificate Signing Requests](#).

### 6.10.23. Adding the Ingress DNS records

If you removed the DNS Zone configuration when creating Kubernetes manifests and generating Ignition configs, you must manually create DNS records that point at the Ingress load balancer. You can create either a wildcard **\*.apps.{baseDomain}**, or specific records. You can use A, CNAME, and other records per your requirements.

#### Prerequisites

- You deployed an OpenShift Container Platform cluster on Microsoft Azure by using infrastructure that you provisioned.
- Install the OpenShift CLI (**oc**).
- Install or update the [Azure CLI](#).

#### Procedure

1. Confirm the Ingress router has created a load balancer and populated the **EXTERNAL-IP** field:

```
$ oc -n openshift-ingress get service router-default
```

#### Example output

```
NAME          TYPE          CLUSTER-IP    EXTERNAL-IP    PORT(S)          AGE
router-default LoadBalancer  172.30.20.10  35.130.120.110 80:32288/TCP,443:31215/TCP 20
```

2. Export the Ingress router IP as a variable:

```
$ export PUBLIC_IP_ROUTER=`oc -n openshift-ingress get service router-default --no-headers | awk '{print $4}'`
```

3. Add a **\*.apps** record to the public DNS zone.

- a. If you are adding this cluster to a new public zone, run:

```
$ az network dns record-set a add-record -g ${BASE_DOMAIN_RESOURCE_GROUP} -z ${CLUSTER_NAME}.${BASE_DOMAIN} -n *.apps -a ${PUBLIC_IP_ROUTER} --ttl 300
```

- b. If you are adding this cluster to an already existing public zone, run:

```
$ az network dns record-set a add-record -g ${BASE_DOMAIN_RESOURCE_GROUP} -z ${BASE_DOMAIN} -n *.apps.${CLUSTER_NAME} -a ${PUBLIC_IP_ROUTER} --ttl 300
```

4. Add a **\*.apps** record to the private DNS zone:

- a. Create a **\*.apps** record by using the following command:

```
$ az network private-dns record-set a create -g ${RESOURCE_GROUP} -z ${CLUSTER_NAME}.${BASE_DOMAIN} -n *.apps --ttl 300
```

- b. Add the **\*.apps** record to the private DNS zone by using the following command:

■

```
$ az network private-dns record-set a add-record -g ${RESOURCE_GROUP} -z
${CLUSTER_NAME}.${BASE_DOMAIN} -n *.apps -a ${PUBLIC_IP_ROUTER}
```

If you prefer to add explicit domains instead of using a wildcard, you can create entries for each of the cluster's current routes:

```
$ oc get --all-namespaces -o jsonpath='{range .items[*]}{range .status.ingress[*]}{.host}{"\n"}{end}
{end}' routes
```

### Example output

```
oauth-openshift.apps.cluster.basedomain.com
console-openshift-console.apps.cluster.basedomain.com
downloads-openshift-console.apps.cluster.basedomain.com
alertmanager-main-openshift-monitoring.apps.cluster.basedomain.com
grafana-openshift-monitoring.apps.cluster.basedomain.com
prometheus-k8s-openshift-monitoring.apps.cluster.basedomain.com
```

## 6.10.24. Completing an Azure installation on user-provisioned infrastructure

After you start the OpenShift Container Platform installation on Microsoft Azure user-provisioned infrastructure, you can monitor the cluster events until the cluster is ready.

### Prerequisites

- Deploy the bootstrap machine for an OpenShift Container Platform cluster on user-provisioned Azure infrastructure.
- Install the **oc** CLI and log in.

### Procedure

- Complete the cluster installation:

```
$ ./openshift-install --dir <installation_directory> wait-for install-complete 1
```

### Example output

```
INFO Waiting up to 30m0s for the cluster to initialize...
```

- 1** For **<installation\_directory>**, specify the path to the directory that you stored the installation files in.



## IMPORTANT

- The Ignition config files that the installation program generates contain certificates that expire after 24 hours, which are then renewed at that time. If the cluster is shut down before renewing the certificates and the cluster is later restarted after the 24 hours have elapsed, the cluster automatically recovers the expired certificates. The exception is that you must manually approve the pending **node-bootstrapper** certificate signing requests (CSRs) to recover kubelet certificates. See the documentation for *Recovering from expired control plane certificates* for more information.
- It is recommended that you use Ignition config files within 12 hours after they are generated because the 24-hour certificate rotates from 16 to 22 hours after the cluster is installed. By using the Ignition config files within 12 hours, you can avoid installation failure if the certificate update runs during installation.

### 6.10.25. Telemetry access for OpenShift Container Platform

In OpenShift Container Platform 4.10, the Telemetry service, which runs by default to provide metrics about cluster health and the success of updates, requires internet access. If your cluster is connected to the internet, Telemetry runs automatically, and your cluster is registered to [OpenShift Cluster Manager](#).

After you confirm that your [OpenShift Cluster Manager](#) inventory is correct, either maintained automatically by Telemetry or manually by using OpenShift Cluster Manager, [use subscription watch](#) to track your OpenShift Container Platform subscriptions at the account or multi-cluster level.

#### Additional resources

- See [About remote health monitoring](#) for more information about the Telemetry service

## 6.11. UNINSTALLING A CLUSTER ON AZURE

You can remove a cluster that you deployed to Microsoft Azure.

### 6.11.1. Removing a cluster that uses installer-provisioned infrastructure

You can remove a cluster that uses installer-provisioned infrastructure from your cloud.



## NOTE

After uninstallation, check your cloud provider for any resources not removed properly, especially with User Provisioned Infrastructure (UPI) clusters. There might be resources that the installer did not create or that the installer is unable to access.

#### Prerequisites

- Have a copy of the installation program that you used to deploy the cluster.
- Have the files that the installation program generated when you created your cluster.

While you can uninstall the cluster using the copy of the installation program that was used to deploy it, using OpenShift Container Platform version 4.13 or later is recommended.

The removal of service principals is dependent on the Microsoft Azure AD Graph API. Using version 4.13 or later of the installation program ensures that service principals are removed without the need for manual intervention, if and when Microsoft decides to [retire](#) the Azure AD Graph API.

## Procedure

1. From the directory that contains the installation program on the computer that you used to install the cluster, run the following command:

```
$. /openshift-install destroy cluster \  
--dir <installation_directory> --log-level info 1 2
```

- 1** For **<installation\_directory>**, specify the path to the directory that you stored the installation files in.
- 2** To view different details, specify **warn**, **debug**, or **error** instead of **info**.



### NOTE

You must specify the directory that contains the cluster definition files for your cluster. The installation program requires the **metadata.json** file in this directory to delete the cluster.

1. Optional: Delete the **<installation\_directory>** directory and the OpenShift Container Platform installation program.



## CHAPTER 7. INSTALLING ON AZURE STACK HUB

### 7.1. PREPARING TO INSTALL ON AZURE STACK HUB

#### 7.1.1. Prerequisites

- You reviewed details about the [OpenShift Container Platform installation and update](#) processes.
- You read the documentation on [selecting a cluster installation method and preparing it for users](#).
- You have installed Azure Stack Hub version 2008 or later.

#### 7.1.2. Requirements for installing OpenShift Container Platform on Azure Stack Hub

Before installing OpenShift Container Platform on Microsoft Azure Stack Hub, you must configure an Azure account.

See [Configuring an Azure Stack Hub account](#) for details about account configuration, account limits, DNS zone configuration, required roles, and creating service principals.

#### 7.1.3. Choosing a method to install OpenShift Container Platform on Azure Stack Hub

You can install OpenShift Container Platform on installer-provisioned or user-provisioned infrastructure. The default installation type uses installer-provisioned infrastructure, where the installation program provisions the underlying infrastructure for the cluster. You can also install OpenShift Container Platform on infrastructure that you provision. If you do not use infrastructure that the installation program provisions, you must manage and maintain the cluster resources yourself.

See [Installation process](#) for more information about installer-provisioned and user-provisioned installation processes.

##### 7.1.3.1. Installing a cluster on installer-provisioned infrastructure

You can install a cluster on Azure Stack Hub infrastructure that is provisioned by the OpenShift Container Platform installation program, by using the following method:

- [Installing a cluster on Azure Stack Hub with an installer-provisioned infrastructure](#) You can install OpenShift Container Platform on Azure Stack Hub infrastructure that is provisioned by the OpenShift Container Platform installation program.

##### 7.1.3.2. Installing a cluster on user-provisioned infrastructure

You can install a cluster on Azure Stack Hub infrastructure that you provision, by using the following method:

- [Installing a cluster on Azure Stack Hub using ARM templates](#) You can install OpenShift Container Platform on Azure Stack Hub by using infrastructure that you provide. You can use the provided Azure Resource Manager (ARM) templates to assist with an installation.

#### 7.1.4. Next steps

- [Configuring an Azure Stack Hub account](#)

## 7.2. CONFIGURING AN AZURE STACK HUB ACCOUNT

Before you can install OpenShift Container Platform, you must configure a Microsoft Azure account.

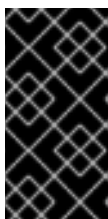

### IMPORTANT

All Azure resources that are available through public endpoints are subject to resource name restrictions, and you cannot create resources that use certain terms. For a list of terms that Azure restricts, see [Resolve reserved resource name errors](#) in the Azure documentation.

### 7.2.1. Azure Stack Hub account limits

The OpenShift Container Platform cluster uses a number of Microsoft Azure Stack Hub components, and the default [Quota types in Azure Stack Hub](#) affect your ability to install OpenShift Container Platform clusters.

The following table summarizes the Azure Stack Hub components whose limits can impact your ability to install and run OpenShift Container Platform clusters.

Component	Number of components required by default	Description
vCPU	56	<p>A default cluster requires 56 vCPUs, so you must increase the account limit.</p> <p>By default, each cluster creates the following instances:</p> <ul style="list-style-type: none"> <li>• One bootstrap machine, which is removed after installation</li> <li>• Three control plane machines</li> <li>• Three compute machines</li> </ul> <p>Because the bootstrap, control plane, and worker machines use <b>Standard_DS4_v2</b> virtual machines, which use 8 vCPUs, a default cluster requires 56 vCPUs. The bootstrap node VM is used only during installation.</p> <p>To deploy more worker nodes, enable autoscaling, deploy large workloads, or use a different instance type, you must further increase the vCPU limit for your account to ensure that your cluster can deploy the machines that you require.</p>
VNet	1	Each default cluster requires one Virtual Network (VNet), which contains two subnets.
Network interfaces	7	Each default cluster requires seven network interfaces. If you create more machines or your deployed workloads create load balancers, your cluster uses more network interfaces.

Component	Number of components required by default	Description						
Network security groups	2	<p>Each cluster creates network security groups for each subnet in the VNet. The default cluster creates network security groups for the control plane and for the compute node subnets:</p> <table border="1"> <tr> <td><b>control plane</b></td> <td>Allows the control plane machines to be reached on port 6443 from anywhere</td> </tr> <tr> <td><b>node</b></td> <td>Allows worker nodes to be reached from the internet on ports 80 and 443</td> </tr> </table>	<b>control plane</b>	Allows the control plane machines to be reached on port 6443 from anywhere	<b>node</b>	Allows worker nodes to be reached from the internet on ports 80 and 443		
<b>control plane</b>	Allows the control plane machines to be reached on port 6443 from anywhere							
<b>node</b>	Allows worker nodes to be reached from the internet on ports 80 and 443							
Network load balancers	3	<p>Each cluster creates the following <a href="#">load balancers</a>:</p> <table border="1"> <tr> <td><b>default</b></td> <td>Public IP address that load balances requests to ports 80 and 443 across worker machines</td> </tr> <tr> <td><b>internal</b></td> <td>Private IP address that load balances requests to ports 6443 and 22623 across control plane machines</td> </tr> <tr> <td><b>external</b></td> <td>Public IP address that load balances requests to port 6443 across control plane machines</td> </tr> </table> <p>If your applications create more Kubernetes <b>LoadBalancer</b> service objects, your cluster uses more load balancers.</p>	<b>default</b>	Public IP address that load balances requests to ports 80 and 443 across worker machines	<b>internal</b>	Private IP address that load balances requests to ports 6443 and 22623 across control plane machines	<b>external</b>	Public IP address that load balances requests to port 6443 across control plane machines
<b>default</b>	Public IP address that load balances requests to ports 80 and 443 across worker machines							
<b>internal</b>	Private IP address that load balances requests to ports 6443 and 22623 across control plane machines							
<b>external</b>	Public IP address that load balances requests to port 6443 across control plane machines							
Public IP addresses	2	The public load balancer uses a public IP address. The bootstrap machine also uses a public IP address so that you can SSH into the machine to troubleshoot issues during installation. The IP address for the bootstrap node is used only during installation.						
Private IP addresses	7	The internal load balancer, each of the three control plane machines, and each of the three worker machines each use a private IP address.						

### Additional resources

- [Optimizing storage](#).

## 7.2.2. Configuring a DNS zone in Azure Stack Hub

To successfully install OpenShift Container Platform on Azure Stack Hub, you must create DNS records in an Azure Stack Hub DNS zone. The DNS zone must be authoritative for the domain. To delegate a registrar's DNS zone to Azure Stack Hub, see Microsoft's documentation for [Azure Stack Hub datacenter DNS integration](#).

### 7.2.3. Required Azure Stack Hub roles

Your Microsoft Azure Stack Hub account must have the following roles for the subscription that you use:

- **Owner**

To set roles on the Azure portal, see the [Manage access to resources in Azure Stack Hub with role-based access control](#) in the Microsoft documentation.

### 7.2.4. Creating a service principal

Because OpenShift Container Platform and its installation program create Microsoft Azure resources by using the Azure Resource Manager, you must create a service principal to represent it.

#### Prerequisites

- Install or update the [Azure CLI](#).
- Your Azure account has the required roles for the subscription that you use.

#### Procedure

1. Register your environment:

```
$ az cloud register -n AzureStackCloud --endpoint-resource-manager <endpoint> 1
```

- 1 Specify the Azure Resource Manager endpoint, ``https://management.<region>.<fqdn>/``.

See the [Microsoft documentation](#) for details.

2. Set the active environment:

```
$ az cloud set -n AzureStackCloud
```

3. Update your environment configuration to use the specific API version for Azure Stack Hub:

```
$ az cloud update --profile 2019-03-01-hybrid
```

4. Log in to the Azure CLI:

```
$ az login
```

If you are in a multitenant environment, you must also supply the tenant ID.

5. If your Azure account uses subscriptions, ensure that you are using the right subscription:

- a. View the list of available accounts and record the **tenantId** value for the subscription you want to use for your cluster:

```
$ az account list --refresh
```

#### Example output

```
[
  {
    "cloudName": AzureStackCloud",
    "id": "9bab1460-96d5-40b3-a78e-17b15e978a80",
    "isDefault": true,
    "name": "Subscription Name",
    "state": "Enabled",
    "tenantId": "6057c7e9-b3ae-489d-a54e-de3f6bf6a8ee",
    "user": {
      "name": "you@example.com",
      "type": "user"
    }
  }
]
```

- b. View your active account details and confirm that the **tenantId** value matches the subscription you want to use:

```
$ az account show
```

### Example output

```
{
  "environmentName": AzureStackCloud",
  "id": "9bab1460-96d5-40b3-a78e-17b15e978a80",
  "isDefault": true,
  "name": "Subscription Name",
  "state": "Enabled",
  "tenantId": "6057c7e9-b3ae-489d-a54e-de3f6bf6a8ee", 1
  "user": {
    "name": "you@example.com",
    "type": "user"
  }
}
```

- 1** Ensure that the value of the **tenantId** parameter is the correct subscription ID.

- c. If you are not using the right subscription, change the active subscription:

```
$ az account set -s <subscription_id> 1
```

- 1** Specify the subscription ID.

- d. Verify the subscription ID update:

```
$ az account show
```

### Example output

```
{
  "environmentName": AzureStackCloud",
```

```

    "id": "33212d16-bdf6-45cb-b038-f6565b61edda",
    "isDefault": true,
    "name": "Subscription Name",
    "state": "Enabled",
    "tenantId": "8049c7e9-c3de-762d-a54e-dc3f6be6a7ee",
    "user": {
      "name": "you@example.com",
      "type": "user"
    }
  }
}

```

- Record the **tenantId** and **id** parameter values from the output. You need these values during the OpenShift Container Platform installation.
- Create the service principal for your account:

```

$ az ad sp create-for-rbac --role Contributor --name <service_principal> \ 1
--scopes /subscriptions/<subscription_id> 2
--years <years> 3

```

- Specify the service principal name.
- Specify the subscription ID.
- Specify the number of years. By default, a service principal expires in one year. By using the **--years** option you can extend the validity of your service principal.

### Example output

```

Creating 'Contributor' role assignment under scope '/subscriptions/<subscription_id>'
The output includes credentials that you must protect. Be sure that you do not
include these credentials in your code or check the credentials into your source
control. For more information, see https://aka.ms/azadsp-cli
{
  "appId": "ac461d78-bf4b-4387-ad16-7e32e328aec6",
  "displayName": <service_principal>,
  "password": "00000000-0000-0000-0000-000000000000",
  "tenantId": "8049c7e9-c3de-762d-a54e-dc3f6be6a7ee"
}

```

- Record the values of the **appId** and **password** parameters from the previous output. You need these values during OpenShift Container Platform installation.

### Additional resources

- For more information about CCO modes, see [About the Cloud Credential Operator](#).

### 7.2.5. Next steps

- Install an OpenShift Container Platform cluster:
  - [Installing a cluster quickly on Azure Stack Hub](#) .

- Install an OpenShift Container Platform cluster on Azure Stack Hub with user-provisioned infrastructure by following [Installing a cluster on Azure Stack Hub using ARM templates](#) .

## 7.3. INSTALLING A CLUSTER ON AZURE STACK HUB WITH AN INSTALLER-PROVISIONED INFRASTRUCTURE

In OpenShift Container Platform version 4.10, you can install a cluster on Microsoft Azure Stack Hub with an installer-provisioned infrastructure. However, you must manually configure the **install-config.yaml** file to specify values that are specific to Azure Stack Hub.



### NOTE

While you can select **azure** when using the installation program to deploy a cluster using installer-provisioned infrastructure, this option is only supported for the Azure Public Cloud.

### 7.3.1. Prerequisites

- You reviewed details about the [OpenShift Container Platform installation and update](#) processes.
- You read the documentation on [selecting a cluster installation method and preparing it for users](#).
- You [configured an Azure Stack Hub account](#) to host the cluster.
- If you use a firewall, you [configured it to allow the sites](#) that your cluster requires access to.
- You verified that you have approximately 16 GB of local disk space. Installing the cluster requires that you download the RHCOS virtual hard disk (VHD) cluster image and upload it to your Azure Stack Hub environment so that it is accessible during deployment. Decompressing the VHD files requires this amount of local disk space.

### 7.3.2. Internet access for OpenShift Container Platform

In OpenShift Container Platform 4.10, you require access to the internet to install your cluster.

You must have internet access to:

- Access [OpenShift Cluster Manager](#) to download the installation program and perform subscription management. If the cluster has internet access and you do not disable Telemetry, that service automatically entitles your cluster.
- Access [Quay.io](#) to obtain the packages that are required to install your cluster.
- Obtain the packages that are required to perform cluster updates.



### IMPORTANT

If your cluster cannot have direct internet access, you can perform a restricted network installation on some types of infrastructure that you provision. During that process, you download the required content and use it to populate a mirror registry with the installation packages. With some installation types, the environment that you install your cluster in will not require internet access. Before you update the cluster, you update the content of the mirror registry.

### 7.3.3. Generating a key pair for cluster node SSH access

During an OpenShift Container Platform installation, you can provide an SSH public key to the installation program. The key is passed to the Red Hat Enterprise Linux CoreOS (RHCOS) nodes through their Ignition config files and is used to authenticate SSH access to the nodes. The key is added to the `~/.ssh/authorized_keys` list for the **core** user on each node, which enables password-less authentication.

After the key is passed to the nodes, you can use the key pair to SSH in to the RHCOS nodes as the user **core**. To access the nodes through SSH, the private key identity must be managed by SSH for your local user.

If you want to SSH in to your cluster nodes to perform installation debugging or disaster recovery, you must provide the SSH public key during the installation process. The `./openshift-install gather` command also requires the SSH public key to be in place on the cluster nodes.



#### IMPORTANT

Do not skip this procedure in production environments, where disaster recovery and debugging is required.



#### NOTE

You must use a local key, not one that you configured with platform-specific approaches such as [AWS key pairs](#).

#### Procedure

1. If you do not have an existing SSH key pair on your local machine to use for authentication onto your cluster nodes, create one. For example, on a computer that uses a Linux operating system, run the following command:

```
$ ssh-keygen -t ed25519 -N "" -f <path>/<file_name> 1
```

- 1 Specify the path and file name, such as `~/.ssh/id_ed25519`, of the new SSH key. If you have an existing key pair, ensure your public key is in the your `~/.ssh` directory.



#### NOTE

If you plan to install an OpenShift Container Platform cluster that uses FIPS validated or Modules In Process cryptographic libraries on the **x86\_64** architecture, do not create a key that uses the **ed25519** algorithm. Instead, create a key that uses the **rsa** or **ecdsa** algorithm.

2. View the public SSH key:

```
$ cat <path>/<file_name>.pub
```

For example, run the following to view the `~/.ssh/id_ed25519.pub` public key:

```
$ cat ~/.ssh/id_ed25519.pub
```



3. Add the SSH private key identity to the SSH agent for your local user, if it has not already been added. SSH agent management of the key is required for password-less SSH authentication onto your cluster nodes, or if you want to use the **./openshift-install gather** command.

**NOTE**

On some distributions, default SSH private key identities such as `~/.ssh/id_rsa` and `~/.ssh/id_dsa` are managed automatically.

- a. If the **ssh-agent** process is not already running for your local user, start it as a background task:

```
$ eval "$(ssh-agent -s)"
```

**Example output**

```
Agent pid 31874
```

**NOTE**

If your cluster is in FIPS mode, only use FIPS-compliant algorithms to generate the SSH key. The key must be either RSA or ECDSA.

4. Add your SSH private key to the **ssh-agent**:

```
$ ssh-add <path>/<file_name> 1
```

- 1** Specify the path and file name for your SSH private key, such as `~/.ssh/id_ed25519`

**Example output**

```
Identity added: /home/<you>/<path>/<file_name> (<computer_name>)
```

**Next steps**

- When you install OpenShift Container Platform, provide the SSH public key to the installation program.

**7.3.4. Uploading the RHCOS cluster image**

You must download the RHCOS virtual hard disk (VHD) cluster image and upload it to your Azure Stack Hub environment so that it is accessible during deployment.

**Prerequisites**

- Configure an Azure account.

**Procedure**

1. Obtain the RHCOS VHD cluster image:

- a. Export the URL of the RHCOS VHD to an environment variable.

```
$ export COMPRESSED_VHD_URL=$(openshift-install coreos print-stream-json | jq -r
'.architectures.x86_64.artifacts.azurestack.formats."vhd.gz".disk.location')
```

- b. Download the compressed RHCOS VHD file locally.

```
$ curl -O -L ${COMPRESSED_VHD_URL}
```

2. Decompress the VHD file.



#### NOTE

The decompressed VHD file is approximately 16 GB, so be sure that your host system has 16 GB of free space available. The VHD file can be deleted once you have uploaded it.

3. Upload the local VHD to the Azure Stack Hub environment, making sure that the blob is publicly available. For example, you can upload the VHD to a blob using the **az** cli or the web portal.

### 7.3.5. Obtaining the installation program

Before you install OpenShift Container Platform, download the installation file on a local computer.

#### Prerequisites

- You have a computer that runs Linux or macOS, with 500 MB of local disk space

#### Procedure

1. Access the [Infrastructure Provider](#) page on the OpenShift Cluster Manager site. If you have a Red Hat account, log in with your credentials. If you do not, create an account.
2. Select **Azure** as the cloud provider.
3. Navigate to the page for your installation type, download the installation program that corresponds with your host operating system and architecture, and place the file in the directory where you will store the installation configuration files.



#### IMPORTANT

The installation program creates several files on the computer that you use to install your cluster. You must keep the installation program and the files that the installation program creates after you finish installing the cluster. Both files are required to delete the cluster.



#### IMPORTANT

Deleting the files created by the installation program does not remove your cluster, even if the cluster failed during installation. To remove your cluster, complete the OpenShift Container Platform uninstallation procedures for your specific cloud provider.

4. Extract the installation program. For example, on a computer that uses a Linux operating system, run the following command:

```
$ tar -xvf openshift-install-linux.tar.gz
```

5. Download your installation [pull secret from the Red Hat OpenShift Cluster Manager](#). This pull secret allows you to authenticate with the services that are provided by the included authorities, including Quay.io, which serves the container images for OpenShift Container Platform components.

### 7.3.6. Manually creating the installation configuration file

When installing OpenShift Container Platform on Microsoft Azure Stack Hub, you must manually create your installation configuration file.

#### Prerequisites

- You have an SSH public key on your local machine to provide to the installation program. The key will be used for SSH authentication onto your cluster nodes for debugging and disaster recovery.
- You have obtained the OpenShift Container Platform installation program and the pull secret for your cluster.

#### Procedure

1. Create an installation directory to store your required installation assets in:

```
$ mkdir <installation_directory>
```



#### IMPORTANT

You must create a directory. Some installation assets, like bootstrap X.509 certificates have short expiration intervals, so you must not reuse an installation directory. If you want to reuse individual files from another cluster installation, you can copy them into your directory. However, the file names for the installation assets might change between releases. Use caution when copying installation files from an earlier OpenShift Container Platform version.

2. Customize the sample **install-config.yaml** file template that is provided and save it in the **<installation\_directory>**.

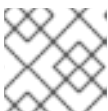

#### NOTE

You must name this configuration file **install-config.yaml**.

Make the following modifications:

- a. Specify the required installation parameters.
- b. Update the **platform.azure** section to specify the parameters that are specific to Azure Stack Hub.

- c. Optional: Update one or more of the default configuration parameters to customize the installation.  
For more information about the parameters, see "Installation configuration parameters".
3. Back up the **install-config.yaml** file so that you can use it to install multiple clusters.

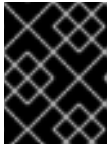

### IMPORTANT

The **install-config.yaml** file is consumed during the next step of the installation process. You must back it up now.

#### 7.3.6.1. Installation configuration parameters

Before you deploy an OpenShift Container Platform cluster, you provide a customized **install-config.yaml** installation configuration file that describes the details for your environment.

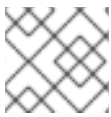

### NOTE

After installation, you cannot modify these parameters in the **install-config.yaml** file.

##### 7.3.6.1.1. Required configuration parameters

Required installation configuration parameters are described in the following table:

Table 7.1. Required parameters

Parameter	Description	Values
<b>apiVersion</b>	The API version for the <b>install-config.yaml</b> content. The current version is <b>v1</b> . The installer may also support older API versions.	String
<b>baseDomain</b>	The base domain of your cloud provider. The base domain is used to create routes to your OpenShift Container Platform cluster components. The full DNS name for your cluster is a combination of the <b>baseDomain</b> and <b>metadata.name</b> parameter values that uses the <b>&lt;metadata.name&gt;</b> . <b>&lt;baseDomain&gt;</b> format.	A fully-qualified domain or subdomain name, such as <b>example.com</b> .
<b>metadata</b>	Kubernetes resource <b>ObjectMeta</b> , from which only the <b>name</b> parameter is consumed.	Object

Parameter	Description	Values
<b>metadata.name</b>	The name of the cluster. DNS records for the cluster are all subdomains of <b>{{.metadata.name}}.{{.baseDomain}}</b> .	String of lowercase letters, hyphens (-), and periods (.), such as <b>dev</b> .
<b>platform</b>	The configuration for the specific platform upon which to perform the installation: <b>alibabacloud, aws, baremetal, azure, gcp, ibmcloud, openstack, ovirt, vsphere</b> , or <b>{}</b> . For additional information about <b>platform.&lt;platform&gt;</b> parameters, consult the table for your specific platform that follows.	Object
<b>pullSecret</b>	Get a <a href="#">pull secret from the Red Hat OpenShift Cluster Manager</a> to authenticate downloading container images for OpenShift Container Platform components from services such as Quay.io.	<pre>{   "auths":{     "cloud.openshift.com":{       "auth":"b3Blb=",       "email":"you@example.com"     },     "quay.io":{       "auth":"b3Blb=",       "email":"you@example.com"     }   } }</pre>



### 7.3.6.1.2. Network configuration parameters

You can customize your installation configuration based on the requirements of your existing network infrastructure. For example, you can expand the IP address block for the cluster network or provide different IP address blocks than the defaults.

Only IPv4 addresses are supported.

Table 7.2. Network parameters

Parameter	Description	Values
-----------	-------------	--------

Parameter	Description	Values
<b>networking</b>	The configuration for the cluster network.	Object  <b>NOTE</b> You cannot modify parameters specified by the <b>networking</b> object after installation.
<b>networking.networkType</b>	The cluster network provider Container Network Interface (CNI) plugin to install.	Either <b>OpenShiftSDN</b> or <b>OVNKubernetes</b> . <b>OpenShiftSDN</b> is a CNI provider for all-Linux networks. <b>OVNKubernetes</b> is a CNI provider for Linux networks and hybrid networks that contain both Linux and Windows servers. The default value is <b>OpenShiftSDN</b> .
<b>networking.clusterNetwork</b>	The IP address blocks for pods.  The default value is <b>10.128.0.0/14</b> with a host prefix of <b>/23</b> .  If you specify multiple IP address blocks, the blocks must not overlap.	An array of objects. For example:   <pre>networking:   clusterNetwork:     - cidr: 10.128.0.0/14       hostPrefix: 23</pre>
<b>networking.clusterNetwork.cidr</b>	Required if you use <b>networking.clusterNetwork</b> . An IP address block.  An IPv4 network.	An IP address block in Classless Inter-Domain Routing (CIDR) notation. The prefix length for an IPv4 block is between <b>0</b> and <b>32</b> .
<b>networking.clusterNetwork.hostPrefix</b>	The subnet prefix length to assign to each individual node. For example, if <b>hostPrefix</b> is set to <b>23</b> then each node is assigned a <b>/23</b> subnet out of the given <b>cidr</b> . A <b>hostPrefix</b> value of <b>23</b> provides 510 ( $2^{(32 - 23)} - 2$ ) pod IP addresses.	A subnet prefix.  The default value is <b>23</b> .

Parameter	Description	Values
<b>networking.serviceNetwork</b>	<p>The IP address block for services. The default value is <b>172.30.0.0/16</b>.</p> <p>The OpenShift SDN and OVN-Kubernetes network providers support only a single IP address block for the service network.</p>	<p>An array with an IP address block in CIDR format. For example:</p> <pre>networking:   serviceNetwork:     - 172.30.0.0/16</pre>
<b>networking.machineNetwork</b>	<p>The IP address blocks for machines.</p> <p>If you specify multiple IP address blocks, the blocks must not overlap.</p>	<p>An array of objects. For example:</p> <pre>networking:   machineNetwork:     - cidr: 10.0.0.0/16</pre>
<b>networking.machineNetwork.cidr</b>	<p>Required if you use <b>networking.machineNetwork</b>. An IP address block. The default value is <b>10.0.0.0/16</b> for all platforms other than libvirt. For libvirt, the default value is <b>192.168.126.0/24</b>.</p>	<p>An IP network block in CIDR notation.</p> <p>For example, <b>10.0.0.0/16</b>.</p> <div style="display: flex; align-items: flex-start;">  <div> <p><b>NOTE</b></p> <p>Set the <b>networking.machineNetwork</b> to match the CIDR that the preferred NIC resides in.</p> </div> </div>

### 7.3.6.1.3. Optional configuration parameters

Optional installation configuration parameters are described in the following table:

**Table 7.3. Optional parameters**

Parameter	Description	Values
<b>additionalTrustBundle</b>	<p>A PEM-encoded X.509 certificate bundle that is added to the nodes' trusted certificate store. This trust bundle may also be used when a proxy has been configured.</p>	String



Parameter	Description	Values
<b>cgroupsV2</b>	Enables <a href="#">Linux control groups version 2</a> (cgroups v2) on specific nodes in your cluster. The OpenShift Container Platform process for enabling cgroups v2 disables all cgroup version 1 controllers and hierarchies. The OpenShift Container Platform cgroups version 2 feature is in Developer Preview and is not supported by Red Hat at this time.	<b>true</b>
<b>compute</b>	The configuration for the machines that comprise the compute nodes.	Array of <b>MachinePool</b> objects.
<b>compute.architecture</b>	Determines the instruction set architecture of the machines in the pool. Currently, clusters with varied architectures are not supported. All pools must specify the same architecture. Valid values are <b>amd64</b> (the default).	String
<b>compute.hyperthreading</b>	<p>Whether to enable or disable simultaneous multithreading, or <b>hyperthreading</b>, on compute machines. By default, simultaneous multithreading is enabled to increase the performance of your machines' cores.</p> <div style="display: flex; align-items: flex-start;"> <div style="flex: 1;">  </div> <div style="flex: 2;"> <p><b>IMPORTANT</b></p> <p>If you disable simultaneous multithreading, ensure that your capacity planning accounts for the dramatically decreased machine performance.</p> </div> </div>	<b>Enabled</b> or <b>Disabled</b>
<b>compute.name</b>	Required if you use <b>compute</b> . The name of the machine pool.	<b>worker</b>



Parameter	Description	Values
<b>compute.platform</b>	Required if you use <b>compute</b> . Use this parameter to specify the cloud provider to host the worker machines. This parameter value must match the <b>controlPlane.platform</b> parameter value.	<b>alibabacloud, aws, azure, gcp, ibmcloud, openstack, ovirt, vsphere</b> , or <b>{}</b>
<b>compute.replicas</b>	The number of compute machines, which are also known as worker machines, to provision.	A positive integer greater than or equal to <b>2</b> . The default value is <b>3</b> .
<b>controlPlane</b>	The configuration for the machines that comprise the control plane.	Array of <b>MachinePool</b> objects.
<b>controlPlane.architecture</b>	Determines the instruction set architecture of the machines in the pool. Currently, clusters with varied architectures are not supported. All pools must specify the same architecture. Valid values are <b>amd64</b> (the default).	String
<b>controlPlane.hyperthreading</b>	<p>Whether to enable or disable simultaneous multithreading, or <b>hyperthreading</b>, on control plane machines. By default, simultaneous multithreading is enabled to increase the performance of your machines' cores.</p> <div data-bbox="486 1377 593 1697" style="background-color: black; width: 67px; height: 143px; margin-bottom: 10px;"></div> <p><b>IMPORTANT</b></p> <p>If you disable simultaneous multithreading, ensure that your capacity planning accounts for the dramatically decreased machine performance.</p>	<b>Enabled</b> or <b>Disabled</b>
<b>controlPlane.name</b>	Required if you use <b>controlPlane</b> . The name of the machine pool.	<b>master</b>
<b>controlPlane.platform</b>	Required if you use <b>controlPlane</b> . Use this parameter to specify the cloud provider that hosts the control plane machines. This parameter value must match the <b>compute.platform</b> parameter value.	<b>alibabacloud, aws, azure, gcp, ibmcloud, openstack, ovirt, vsphere</b> , or <b>{}</b>

Parameter	Description	Values
<b>controlPlane.replicas</b>	The number of control plane machines to provision.	The only supported value is <b>3</b> , which is the default value.
<b>credentialsMode</b>	<p>The Cloud Credential Operator (CCO) mode. If no mode is specified, the CCO dynamically tries to determine the capabilities of the provided credentials, with a preference for mint mode on the platforms where multiple modes are supported.</p> <div data-bbox="485 898 595 1245" style="border: 1px solid black; padding: 5px; margin-bottom: 10px;"> <p><b>NOTE</b></p> <p>Not all CCO modes are supported for all cloud providers. For more information on CCO modes, see the <i>Cloud Credential Operator</i> entry in the <i>Cluster Operators reference</i> content.</p> </div> <div data-bbox="485 1294 595 1641" style="border: 1px solid black; padding: 5px;"> <p><b>NOTE</b></p> <p>If your AWS account has service control policies (SCP) enabled, you must configure the <b>credentialsMode</b> parameter to <b>Mint</b>, <b>Passthrough</b> or <b>Manual</b>.</p> </div>	<b>Mint</b> , <b>Passthrough</b> , <b>Manual</b> or an empty string ("").

Parameter	Description	Values
<b>fips</b>	<p>Enable or disable FIPS mode. The default is <b>false</b> (disabled). If FIPS mode is enabled, the Red Hat Enterprise Linux CoreOS (RHCOS) machines that OpenShift Container Platform runs on bypass the default Kubernetes cryptography suite and use the cryptography modules that are provided with RHCOS instead.</p> <div style="display: flex; align-items: flex-start;"> <div style="width: 20px; height: 100px; background: repeating-linear-gradient(45deg, transparent, transparent 2px, black 2px, black 4px); margin-right: 10px;"></div> <div> <p><b>IMPORTANT</b></p> <p>To enable FIPS mode for your cluster, you must run the installation program from a Red Hat Enterprise Linux (RHEL) computer configured to operate in FIPS mode. For more information about configuring FIPS mode on RHEL, see <a href="#">Installing the system in FIPS mode</a>. The use of FIPS validated or Modules In Process cryptographic libraries is only supported on OpenShift Container Platform deployments on the <b>x86_64</b> architecture.</p> </div> </div> <div style="display: flex; align-items: flex-start; margin-top: 10px;"> <div style="width: 20px; height: 50px; background: repeating-linear-gradient(45deg, transparent, transparent 2px, black 2px, black 4px); margin-right: 10px;"></div> <div> <p><b>NOTE</b></p> <p>If you are using Azure File storage, you cannot enable FIPS mode.</p> </div> </div>	<b>false</b> or <b>true</b>
<b>imageContentSources</b>	Sources and repositories for the release-image content.	Array of objects. Includes a <b>source</b> and, optionally, <b>mirrors</b> , as described in the following rows of this table.
<b>imageContentSources.source</b>	Required if you use <b>imageContentSources</b> . Specify the repository that users refer to, for example, in image pull specifications.	String
<b>imageContentSources.mirrors</b>	Specify one or more repositories that may also contain the same images.	Array of strings

Parameter	Description	Values
<b>publish</b>	How to publish or expose the user-facing endpoints of your cluster, such as the Kubernetes API, OpenShift routes.	<p><b>Internal</b> or <b>External</b>. The default value is <b>External</b>.</p> <p>Setting this field to <b>Internal</b> is not supported on non-cloud platforms and IBM Cloud VPC.</p> <div style="display: flex; align-items: flex-start;">  <div> <p><b>IMPORTANT</b></p> <p>If the value of the field is set to <b>Internal</b>, the cluster will become non-functional. For more information, refer to <a href="#">BZ#1953035</a>.</p> </div> </div>
<b>sshKey</b>	<p>The SSH key or keys to authenticate access your cluster machines.</p> <div style="display: flex; align-items: flex-start;">  <div> <p><b>NOTE</b></p> <p>For production OpenShift Container Platform clusters on which you want to perform installation debugging or disaster recovery, specify an SSH key that your <b>ssh-agent</b> process uses.</p> </div> </div>	<p>One or more keys. For example:</p> <pre>sshKey:   &lt;key1&gt;   &lt;key2&gt;   &lt;key3&gt;</pre>

#### 7.3.6.1.4. Additional Azure Stack Hub configuration parameters

Additional Azure configuration parameters are described in the following table:

Table 7.4. Additional Azure Stack Hub parameters

Parameter	Description	Values
<b>compute.platform.azure.osDisk.diskSizeGB</b>	The Azure disk size for the VM.	Integer that represents the size of the disk in GB. The default is <b>128</b> .
<b>compute.platform.azure.osDisk.diskType</b>	Defines the type of disk.	<b>standard_LRS</b> or <b>premium_LRS</b> . The default is <b>premium_LRS</b> .
<b>controlPlane.platform.azure.osDisk.diskSizeGB</b>	The Azure disk size for the VM.	Integer that represents the size of the disk in GB. The default is <b>1024</b> .

Parameter	Description	Values
<b>controlPlane.platform.azure.osDisk.diskType</b>	Defines the type of disk.	<b>premium_LRS.</b>
<b>platform.azure.armEndpoint</b>	The URL of the Azure Resource Manager endpoint that your Azure Stack Hub operator provides.	String
<b>platform.azure.baseDomainResourceGroupName</b>	The name of the resource group that contains the DNS zone for your base domain.	String, for example <b>production_cluster.</b>
<b>platform.azure.region</b>	The name of your Azure Stack Hub local region.	String
<b>platform.azure.resourceGroupName</b>	The name of an already existing resource group to install your cluster to. This resource group must be empty and only used for this specific cluster; the cluster components assume ownership of all resources in the resource group. If you limit the service principal scope of the installation program to this resource group, you must ensure all other resources used by the installation program in your environment have the necessary permissions, such as the public DNS zone and virtual network. Destroying the cluster by using the installation program deletes this resource group.	String, for example <b>existing_resource_group.</b>
<b>platform.azure.outboundType</b>	The outbound routing strategy used to connect your cluster to the internet. If you are using user-defined routing, you must have pre-existing networking available where the outbound routing has already been configured prior to installing a cluster. The installation program is not responsible for configuring user-defined routing.	<b>LoadBalancer</b> or <b>UserDefinedRouting.</b> The default is <b>LoadBalancer.</b>
<b>platform.azure.cloudName</b>	The name of the Azure cloud environment that is used to configure the Azure SDK with the appropriate Azure API endpoints.	<b>AzureStackCloud</b>

Parameter	Description	Values
<b>clusterOSImage</b>	The URL of a storage blob in the Azure Stack environment that contains an RHCOS VHD.	String, for example, <code>https://vhdsa.blob.example.example.com/vhd/rhcos-410.84.202112040202-0-azurestack.x86_64.vhd</code>

### 7.3.6.2. Sample customized install-config.yaml file for Azure Stack Hub

You can customize the **install-config.yaml** file to specify more details about your OpenShift Container Platform cluster's platform or modify the values of the required parameters.



#### IMPORTANT

This sample YAML file is provided for reference only. Use it as a resource to enter parameter values into the installation configuration file that you created manually.

```

apiVersion: v1
baseDomain: example.com 1
credentialsMode: Manual
controlPlane: 2 3
  name: master
  platform:
    azure:
      osDisk:
        diskSizeGB: 1024 4
        diskType: premium_LRS
      replicas: 3
compute: 5
- name: worker
  platform:
    azure:
      osDisk:
        diskSizeGB: 512 6
        diskType: premium_LRS
      replicas: 3
metadata:
  name: test-cluster 7 8
networking:
  clusterNetwork:
    - cidr: 10.128.0.0/14
      hostPrefix: 23
  machineNetwork:
    - cidr: 10.0.0.0/16
  networkType: OpenShiftSDN
  serviceNetwork:
    - 172.30.0.0/16
platform:
  azure:
    armEndpoint: azurestack_arm_endpoint 9 10
    baseDomainResourceGroupName: resource_group 11 12
    region: azure_stack_local_region 13 14

```

```

resourceGroupName: existing_resource_group 15
outboundType: Loadbalancer
cloudName: AzureStackCloud 16
clusterOSImage: https://vhdsa.blob.example.example.com/vhd/rhcos-410.84.202112040202-0-
azurestack.x86_64.vhd 17 18
pullSecret: '{"auths": ...}' 19 20
fips: false 21
sshKey: ssh-ed25519 AAAA... 22
additionalTrustBundle: | 23
  -----BEGIN CERTIFICATE-----
  <MY_TRUSTED_CA_CERT>
  -----END CERTIFICATE-----

```

1 7 9 11 13 16 17 19 Required.

2 5 If you do not provide these parameters and values, the installation program provides the default value.

3 The **controlPlane** section is a single mapping, but the **compute** section is a sequence of mappings. To meet the requirements of the different data structures, the first line of the **compute** section must begin with a hyphen, -, and the first line of the **controlPlane** section must not. Although both sections currently define a single machine pool, it is possible that future versions of OpenShift Container Platform will support defining multiple compute pools during installation. Only one control plane pool is used.

4 6 You can specify the size of the disk to use in GB. Minimum recommendation for control plane nodes is 1024 GB.

8 The name of the cluster.

10 The Azure Resource Manager endpoint that your Azure Stack Hub operator provides.

12 The name of the resource group that contains the DNS zone for your base domain.

14 The name of your Azure Stack Hub local region.

15 The name of an existing resource group to install your cluster to. If undefined, a new resource group is created for the cluster.

18 The URL of a storage blob in the Azure Stack environment that contains an RHCOS VHD.

20 The pull secret required to authenticate your cluster.

21 Whether to enable or disable FIPS mode. By default, FIPS mode is not enabled. If FIPS mode is enabled, the Red Hat Enterprise Linux CoreOS (RHCOS) machines that OpenShift Container Platform runs on bypass the default Kubernetes cryptography suite and use the cryptography modules that are provided with RHCOS instead.



## IMPORTANT

To enable FIPS mode for your cluster, you must run the installation program from a Red Hat Enterprise Linux (RHEL) computer configured to operate in FIPS mode. For more information about configuring FIPS mode on RHEL, see [Installing the system in FIPS mode](#). The use of FIPS validated or Modules In Process cryptographic libraries is only supported on OpenShift Container Platform deployments on the **x86\_64** architecture.

22

You can optionally provide the **sshKey** value that you use to access the machines in your cluster.



## NOTE

For production OpenShift Container Platform clusters on which you want to perform installation debugging or disaster recovery, specify an SSH key that your **ssh-agent** process uses.

23

If the Azure Stack Hub environment is using an internal Certificate Authority (CA), adding the CA certificate is required.

### 7.3.7. Manually manage cloud credentials

The Cloud Credential Operator (CCO) only supports your cloud provider in manual mode. As a result, you must specify the identity and access management (IAM) secrets for your cloud provider.

#### Procedure

1. Generate the manifests by running the following command from the directory that contains the installation program:

```
$ openshift-install create manifests --dir <installation_directory>
```

where **<installation\_directory>** is the directory in which the installation program creates files.

2. From the directory that contains the installation program, obtain details of the OpenShift Container Platform release image that your **openshift-install** binary is built to use by running the following command:

```
$ openshift-install version
```

#### Example output

```
release image quay.io/openshift-release-dev/ocp-release:4.y.z-x86_64
```

3. Locate all **CredentialsRequest** objects in this release image that target the cloud you are deploying on by running the following command:

```
$ oc adm release extract quay.io/openshift-release-dev/ocp-release:4.y.z-x86_64 \
  --credentials-requests \
  --cloud=azure
```

This command creates a YAML file for each **CredentialsRequest** object.



### Sample `CredentialsRequest` object

```

apiVersion: cloudcredential.openshift.io/v1
kind: CredentialsRequest
metadata:
  name: <component-credentials-request>
  namespace: openshift-cloud-credential-operator
  ...
spec:
  providerSpec:
    apiVersion: cloudcredential.openshift.io/v1
    kind: AzureProviderSpec
    roleBindings:
      - role: Contributor
    ...

```

4. Create YAML files for secrets in the **openshift-install** manifests directory that you generated previously. The secrets must be stored using the namespace and secret name defined in the **spec.secretRef** for each **CredentialsRequest** object.

### Sample `CredentialsRequest` object with secrets

```

apiVersion: cloudcredential.openshift.io/v1
kind: CredentialsRequest
metadata:
  name: <component-credentials-request>
  namespace: openshift-cloud-credential-operator
  ...
spec:
  providerSpec:
    apiVersion: cloudcredential.openshift.io/v1
    kind: AzureProviderSpec
    roleBindings:
      - role: Contributor
    ...
  secretRef:
    name: <component-secret>
    namespace: <component-namespace>
  ...

```

### Sample `Secret` object

```

apiVersion: v1
kind: Secret
metadata:
  name: <component-secret>
  namespace: <component-namespace>
data:
  azure_subscription_id: <base64_encoded_azure_subscription_id>
  azure_client_id: <base64_encoded_azure_client_id>
  azure_client_secret: <base64_encoded_azure_client_secret>
  azure_tenant_id: <base64_encoded_azure_tenant_id>

```

```
azure_resource_prefix: <base64_encoded_azure_resource_prefix>
azure_resourcegroup: <base64_encoded_azure_resourcegroup>
azure_region: <base64_encoded_azure_region>
```

### IMPORTANT

The release image includes **CredentialsRequest** objects for Technology Preview features that are enabled by the **TechPreviewNoUpgrade** feature set. You can identify these objects by their use of the **release.openshift.io/feature-gate: TechPreviewNoUpgrade** annotation.

- If you are not using any of these features, do not create secrets for these objects. Creating secrets for Technology Preview features that you are not using can cause the installation to fail.
  - If you are using any of these features, you must create secrets for the corresponding objects.
- To find **CredentialsRequest** objects with the **TechPreviewNoUpgrade** annotation, run the following command:

```
$ grep "release.openshift.io/feature-gate" *
```

#### Example output

```
0000_30_capi-operator_00_credentials-request.yaml: release.openshift.io/feature-gate:
TechPreviewNoUpgrade
```

### IMPORTANT

Before upgrading a cluster that uses manually maintained credentials, you must ensure that the CCO is in an upgradeable state.

#### Additional resources

- [Updating cloud provider resources with manually maintained credentials](#)

### 7.3.8. Configuring the cluster to use an internal CA

If the Azure Stack Hub environment is using an internal Certificate Authority (CA), update the **cluster-proxy-01-config.yaml** file to configure the cluster to use the internal CA.

#### Prerequisites

- Create the **install-config.yaml** file and specify the certificate trust bundle in **.pem** format.
- Create the cluster manifests.

#### Procedure

1. From the directory in which the installation program creates files, go to the **manifests** directory.
2. Add **user-ca-bundle** to the **spec.trustedCA.name** field.

### Example `cluster-proxy-01-config.yaml` file

```
apiVersion: config.openshift.io/v1
kind: Proxy
metadata:
  creationTimestamp: null
  name: cluster
spec:
  trustedCA:
    name: user-ca-bundle
status: {}
```

- Optional: Back up the **manifests/ cluster-proxy-01-config.yaml** file. The installation program consumes the **manifests/** directory when you deploy the cluster.

### 7.3.9. Deploying the cluster

You can install OpenShift Container Platform on a compatible cloud platform.

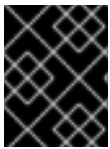

#### IMPORTANT

You can run the **create cluster** command of the installation program only once, during initial installation.

#### Prerequisites

- Configure an account with the cloud platform that hosts your cluster.
- Obtain the OpenShift Container Platform installation program and the pull secret for your cluster.

#### Procedure

- Change to the directory that contains the installation program and initialize the cluster deployment:

```
$ ./openshift-install create cluster --dir <installation_directory> \ 1
--log-level=info 2
```

- 1** For **<installation\_directory>**, specify the location of your customized **./install-config.yaml** file.
- 2** To view different installation details, specify **warn**, **debug**, or **error** instead of **info**.

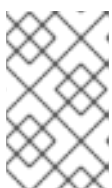

#### NOTE

If the cloud provider account that you configured on your host does not have sufficient permissions to deploy the cluster, the installation process stops, and the missing permissions are displayed.

When the cluster deployment completes, directions for accessing your cluster, including a link to its web console and credentials for the **kubeadmin** user, display in your terminal.

## Example output

```
...
INFO Install complete!
INFO To access the cluster as the system:admin user when using 'oc', run 'export
KUBECONFIG=/home/myuser/install_dir/auth/kubeconfig'
INFO Access the OpenShift web-console here: https://console-openshift-
console.apps.mycluster.example.com
INFO Login to the console with user: "kubeadmin", and password: "4vYBz-Ee6gm-ymBZj-
Wt5AL"
INFO Time elapsed: 36m22s
```



### NOTE

The cluster access and credential information also outputs to `<installation_directory>/openshift_install.log` when an installation succeeds.

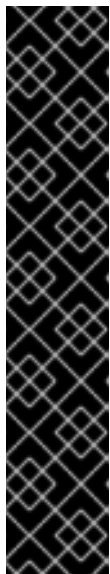

### IMPORTANT

- The Ignition config files that the installation program generates contain certificates that expire after 24 hours, which are then renewed at that time. If the cluster is shut down before renewing the certificates and the cluster is later restarted after the 24 hours have elapsed, the cluster automatically recovers the expired certificates. The exception is that you must manually approve the pending **node-bootstrapper** certificate signing requests (CSRs) to recover kubelet certificates. See the documentation for *Recovering from expired control plane certificates* for more information.
- It is recommended that you use Ignition config files within 12 hours after they are generated because the 24-hour certificate rotates from 16 to 22 hours after the cluster is installed. By using the Ignition config files within 12 hours, you can avoid installation failure if the certificate update runs during installation.



### IMPORTANT

You must not delete the installation program or the files that the installation program creates. Both are required to delete the cluster.

## 7.3.10. Installing the OpenShift CLI by downloading the binary

You can install the OpenShift CLI (**oc**) to interact with OpenShift Container Platform from a command-line interface. You can install **oc** on Linux, Windows, or macOS.

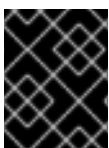

### IMPORTANT

If you installed an earlier version of **oc**, you cannot use it to complete all of the commands in OpenShift Container Platform 4.10. Download and install the new version of **oc**.

### Installing the OpenShift CLI on Linux

You can install the OpenShift CLI (**oc**) binary on Linux by using the following procedure.

#### Procedure

1. Navigate to the [OpenShift Container Platform downloads page](#) on the Red Hat Customer Portal.
2. Select the appropriate version in the **Version** drop-down menu.
3. Click **Download Now** next to the **OpenShift v4.10 Linux Client** entry and save the file.
4. Unpack the archive:

```
$ tar xvf <file>
```

5. Place the **oc** binary in a directory that is on your **PATH**.  
To check your **PATH**, execute the following command:

```
$ echo $PATH
```

After you install the OpenShift CLI, it is available using the **oc** command:

```
$ oc <command>
```

### Installing the OpenShift CLI on Windows

You can install the OpenShift CLI (**oc**) binary on Windows by using the following procedure.

#### Procedure

1. Navigate to the [OpenShift Container Platform downloads page](#) on the Red Hat Customer Portal.
2. Select the appropriate version in the **Version** drop-down menu.
3. Click **Download Now** next to the **OpenShift v4.10 Windows Client** entry and save the file.
4. Unzip the archive with a ZIP program.
5. Move the **oc** binary to a directory that is on your **PATH**.  
To check your **PATH**, open the command prompt and execute the following command:

```
C:\> path
```

After you install the OpenShift CLI, it is available using the **oc** command:

```
C:\> oc <command>
```

### Installing the OpenShift CLI on macOS

You can install the OpenShift CLI (**oc**) binary on macOS by using the following procedure.

#### Procedure

1. Navigate to the [OpenShift Container Platform downloads page](#) on the Red Hat Customer Portal.
2. Select the appropriate version in the **Version** drop-down menu.
3. Click **Download Now** next to the **OpenShift v4.10 MacOSX Client** entry and save the file.

4. Unpack and unzip the archive.
5. Move the **oc** binary to a directory on your PATH.  
To check your **PATH**, open a terminal and execute the following command:

```
$ echo $PATH
```

After you install the OpenShift CLI, it is available using the **oc** command:

```
$ oc <command>
```

### 7.3.11. Logging in to the cluster by using the CLI

You can log in to your cluster as a default system user by exporting the cluster **kubeconfig** file. The **kubeconfig** file contains information about the cluster that is used by the CLI to connect a client to the correct cluster and API server. The file is specific to a cluster and is created during OpenShift Container Platform installation.

#### Prerequisites

- You deployed an OpenShift Container Platform cluster.
- You installed the **oc** CLI.

#### Procedure

1. Export the **kubeadmin** credentials:

```
$ export KUBECONFIG=<installation_directory>/auth/kubeconfig 1
```

- 1** For **<installation\_directory>**, specify the path to the directory that you stored the installation files in.

2. Verify you can run **oc** commands successfully using the exported configuration:

```
$ oc whoami
```

#### Example output

```
system:admin
```

### 7.3.12. Logging in to the cluster by using the web console

The **kubeadmin** user exists by default after an OpenShift Container Platform installation. You can log in to your cluster as the **kubeadmin** user by using the OpenShift Container Platform web console.

#### Prerequisites

- You have access to the installation host.
- You completed a cluster installation and all cluster Operators are available.

## Procedure

1. Obtain the password for the **kubeadmin** user from the **kubeadmin-password** file on the installation host:

```
$ cat <installation_directory>/auth/kubeadmin-password
```



### NOTE

Alternatively, you can obtain the **kubeadmin** password from the **<installation\_directory>/openshift\_install.log** log file on the installation host.

2. List the OpenShift Container Platform web console route:

```
$ oc get routes -n openshift-console | grep 'console-openshift'
```

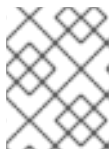

### NOTE

Alternatively, you can obtain the OpenShift Container Platform route from the **<installation\_directory>/openshift\_install.log** log file on the installation host.

## Example output

```
console    console-openshift-console.apps.<cluster_name>.<base_domain>    console
https    reencrypt/Redirect    None
```

3. Navigate to the route detailed in the output of the preceding command in a web browser and log in as the **kubeadmin** user.

## Additional resources

- [Accessing the web console](#)

### 7.3.13. Telemetry access for OpenShift Container Platform

In OpenShift Container Platform 4.10, the Telemetry service, which runs by default to provide metrics about cluster health and the success of updates, requires internet access. If your cluster is connected to the internet, Telemetry runs automatically, and your cluster is registered to [OpenShift Cluster Manager](#).

After you confirm that your [OpenShift Cluster Manager](#) inventory is correct, either maintained automatically by Telemetry or manually by using OpenShift Cluster Manager, [use subscription watch](#) to track your OpenShift Container Platform subscriptions at the account or multi-cluster level.

## Additional resources

- [About remote health monitoring](#)

### 7.3.14. Next steps

- [Validating an installation.](#)
- [Customize your cluster.](#)

- If necessary, you can [opt out of remote health reporting](#) .
- If necessary, you can [remove cloud provider credentials](#).

## 7.4. INSTALLING A CLUSTER ON AZURE STACK HUB WITH NETWORK CUSTOMIZATIONS

In OpenShift Container Platform version 4.10, you can install a cluster with a customized network configuration on infrastructure that the installation program provisions on Azure Stack Hub. By customizing your network configuration, your cluster can coexist with existing IP address allocations in your environment and integrate with existing MTU and VXLAN configurations.



### NOTE

While you can select **azure** when using the installation program to deploy a cluster using installer-provisioned infrastructure, this option is only supported for the Azure Public Cloud.

### 7.4.1. Prerequisites

- You reviewed details about the [OpenShift Container Platform installation and update](#) processes.
- You read the documentation on [selecting a cluster installation method and preparing it for users](#).
- You [configured an Azure Stack Hub account](#) to host the cluster.
- If you use a firewall, you [configured it to allow the sites](#) that your cluster requires access to.
- You verified that you have approximately 16 GB of local disk space. Installing the cluster requires that you download the RHCOS virtual hard disk (VHD) cluster image and upload it to your Azure Stack Hub environment so that it is accessible during deployment. Decompressing the VHD files requires this amount of local disk space.

### 7.4.2. Internet access for OpenShift Container Platform

In OpenShift Container Platform 4.10, you require access to the internet to install your cluster.

You must have internet access to:

- Access [OpenShift Cluster Manager](#) to download the installation program and perform subscription management. If the cluster has internet access and you do not disable Telemetry, that service automatically entitles your cluster.
- Access [Quay.io](#) to obtain the packages that are required to install your cluster.
- Obtain the packages that are required to perform cluster updates.



**IMPORTANT**

If your cluster cannot have direct internet access, you can perform a restricted network installation on some types of infrastructure that you provision. During that process, you download the required content and use it to populate a mirror registry with the installation packages. With some installation types, the environment that you install your cluster in will not require internet access. Before you update the cluster, you update the content of the mirror registry.

**7.4.3. Generating a key pair for cluster node SSH access**

During an OpenShift Container Platform installation, you can provide an SSH public key to the installation program. The key is passed to the Red Hat Enterprise Linux CoreOS (RHCOS) nodes through their Ignition config files and is used to authenticate SSH access to the nodes. The key is added to the `~/.ssh/authorized_keys` list for the **core** user on each node, which enables password-less authentication.

After the key is passed to the nodes, you can use the key pair to SSH in to the RHCOS nodes as the user **core**. To access the nodes through SSH, the private key identity must be managed by SSH for your local user.

If you want to SSH in to your cluster nodes to perform installation debugging or disaster recovery, you must provide the SSH public key during the installation process. The `./openshift-install gather` command also requires the SSH public key to be in place on the cluster nodes.

**IMPORTANT**

Do not skip this procedure in production environments, where disaster recovery and debugging is required.

**NOTE**

You must use a local key, not one that you configured with platform-specific approaches such as [AWS key pairs](#).

**Procedure**

1. If you do not have an existing SSH key pair on your local machine to use for authentication onto your cluster nodes, create one. For example, on a computer that uses a Linux operating system, run the following command:

```
$ ssh-keygen -t ed25519 -N "" -f <path>/<file_name> 1
```

- 1 Specify the path and file name, such as `~/.ssh/id_ed25519`, of the new SSH key. If you have an existing key pair, ensure your public key is in the your `~/.ssh` directory.

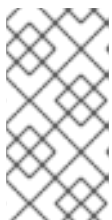
**NOTE**

If you plan to install an OpenShift Container Platform cluster that uses FIPS validated or Modules In Progress cryptographic libraries on the **x86\_64** architecture, do not create a key that uses the **ed25519** algorithm. Instead, create a key that uses the **rsa** or **ecdsa** algorithm.

- View the public SSH key:

```
$ cat <path>/<file_name>.pub
```

For example, run the following to view the `~/.ssh/id_ed25519.pub` public key:

```
$ cat ~/.ssh/id_ed25519.pub
```

- Add the SSH private key identity to the SSH agent for your local user, if it has not already been added. SSH agent management of the key is required for password-less SSH authentication onto your cluster nodes, or if you want to use the `./openshift-install gather` command.

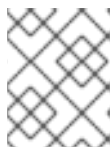

#### NOTE

On some distributions, default SSH private key identities such as `~/.ssh/id_rsa` and `~/.ssh/id_dsa` are managed automatically.

- If the `ssh-agent` process is not already running for your local user, start it as a background task:

```
$ eval "$(ssh-agent -s)"
```

#### Example output

```
Agent pid 31874
```



#### NOTE

If your cluster is in FIPS mode, only use FIPS-compliant algorithms to generate the SSH key. The key must be either RSA or ECDSA.

- Add your SSH private key to the `ssh-agent`:

```
$ ssh-add <path>/<file_name> 1
```

- 1** Specify the path and file name for your SSH private key, such as `~/.ssh/id_ed25519`

#### Example output

```
Identity added: /home/<you>/<path>/<file_name> (<computer_name>)
```

#### Next steps

- When you install OpenShift Container Platform, provide the SSH public key to the installation program.

### 7.4.4. Uploading the RHCOS cluster image

You must download the RHCOS virtual hard disk (VHD) cluster image and upload it to your Azure Stack Hub environment so that it is accessible during deployment.

## Prerequisites

- Configure an Azure account.

## Procedure

1. Obtain the RHCOS VHD cluster image:
  - a. Export the URL of the RHCOS VHD to an environment variable.

```
$ export COMPRESSED_VHD_URL=$(openshift-install coreos print-stream-json | jq -r
'.architectures.x86_64.artifacts.azurestack.formats."vhd.gz".disk.location')
```

- b. Download the compressed RHCOS VHD file locally.

```
$ curl -O -L ${COMPRESSED_VHD_URL}
```

2. Decompress the VHD file.

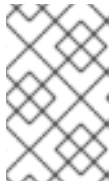

### NOTE

The decompressed VHD file is approximately 16 GB, so be sure that your host system has 16 GB of free space available. The VHD file can be deleted once you have uploaded it.

3. Upload the local VHD to the Azure Stack Hub environment, making sure that the blob is publicly available. For example, you can upload the VHD to a blob using the **az** cli or the web portal.

## 7.4.5. Obtaining the installation program

Before you install OpenShift Container Platform, download the installation file on a local computer.

### Prerequisites

- You have a computer that runs Linux or macOS, with 500 MB of local disk space

### Procedure

1. Access the [Infrastructure Provider](#) page on the OpenShift Cluster Manager site. If you have a Red Hat account, log in with your credentials. If you do not, create an account.
2. Select **Azure** as the cloud provider.
3. Navigate to the page for your installation type, download the installation program that corresponds with your host operating system and architecture, and place the file in the directory where you will store the installation configuration files.



### IMPORTANT

The installation program creates several files on the computer that you use to install your cluster. You must keep the installation program and the files that the installation program creates after you finish installing the cluster. Both files are required to delete the cluster.

**IMPORTANT**

Deleting the files created by the installation program does not remove your cluster, even if the cluster failed during installation. To remove your cluster, complete the OpenShift Container Platform uninstallation procedures for your specific cloud provider.

4. Extract the installation program. For example, on a computer that uses a Linux operating system, run the following command:

```
$ tar -xvf openshift-install-linux.tar.gz
```

5. Download your installation [pull secret from the Red Hat OpenShift Cluster Manager](#) . This pull secret allows you to authenticate with the services that are provided by the included authorities, including Quay.io, which serves the container images for OpenShift Container Platform components.

### 7.4.6. Manually creating the installation configuration file

When installing OpenShift Container Platform on Microsoft Azure Stack Hub, you must manually create your installation configuration file.

#### Prerequisites

- You have an SSH public key on your local machine to provide to the installation program. The key will be used for SSH authentication onto your cluster nodes for debugging and disaster recovery.
- You have obtained the OpenShift Container Platform installation program and the pull secret for your cluster.

#### Procedure

1. Create an installation directory to store your required installation assets in:

```
$ mkdir <installation_directory>
```

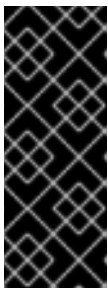
**IMPORTANT**

You must create a directory. Some installation assets, like bootstrap X.509 certificates have short expiration intervals, so you must not reuse an installation directory. If you want to reuse individual files from another cluster installation, you can copy them into your directory. However, the file names for the installation assets might change between releases. Use caution when copying installation files from an earlier OpenShift Container Platform version.

2. Customize the sample **install-config.yaml** file template that is provided and save it in the **<installation\_directory>**.

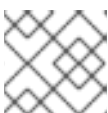
**NOTE**

You must name this configuration file **install-config.yaml**.

Make the following modifications:

- a. Specify the required installation parameters.
  - b. Update the **platform.azure** section to specify the parameters that are specific to Azure Stack Hub.
  - c. Optional: Update one or more of the default configuration parameters to customize the installation.  
For more information about the parameters, see "Installation configuration parameters".
3. Back up the **install-config.yaml** file so that you can use it to install multiple clusters.



### IMPORTANT

The **install-config.yaml** file is consumed during the next step of the installation process. You must back it up now.

#### 7.4.6.1. Installation configuration parameters

Before you deploy an OpenShift Container Platform cluster, you provide a customized **install-config.yaml** installation configuration file that describes the details for your environment.

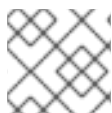

### NOTE

After installation, you cannot modify these parameters in the **install-config.yaml** file.

##### 7.4.6.1.1. Required configuration parameters

Required installation configuration parameters are described in the following table:

Table 7.5. Required parameters

Parameter	Description	Values
<b>apiVersion</b>	The API version for the <b>install-config.yaml</b> content. The current version is <b>v1</b> . The installer may also support older API versions.	String
<b>baseDomain</b>	The base domain of your cloud provider. The base domain is used to create routes to your OpenShift Container Platform cluster components. The full DNS name for your cluster is a combination of the <b>baseDomain</b> and <b>metadata.name</b> parameter values that uses the <b>&lt;metadata.name&gt;</b> . <b>&lt;baseDomain&gt;</b> format.	A fully-qualified domain or subdomain name, such as <b>example.com</b> .

Parameter	Description	Values
<b>metadata</b>	Kubernetes resource <b>ObjectMeta</b> , from which only the <b>name</b> parameter is consumed.	Object
<b>metadata.name</b>	The name of the cluster. DNS records for the cluster are all subdomains of <b>{{.metadata.name}}</b> . <b>{{.baseDomain}}</b> .	String of lowercase letters, hyphens (-), and periods (.), such as <b>dev</b> .
<b>platform</b>	The configuration for the specific platform upon which to perform the installation: <b>alibabacloud</b> , <b>aws</b> , <b>baremetal</b> , <b>azure</b> , <b>gcp</b> , <b>ibmcloud</b> , <b>openstack</b> , <b>ovirt</b> , <b>vsphere</b> , or <b>{}</b> . For additional information about <b>platform.&lt;platform&gt;</b> parameters, consult the table for your specific platform that follows.	Object
<b>pullSecret</b>	Get a <a href="#">pull secret from the Red Hat OpenShift Cluster Manager</a> to authenticate downloading container images for OpenShift Container Platform components from services such as Quay.io.	<pre>{   "auths":{     "cloud.openshift.com":{       "auth":"b3Blb=",       "email":"you@example.com"     },     "quay.io":{       "auth":"b3Blb=",       "email":"you@example.com"     }   } }</pre>

#### 7.4.6.1.2. Network configuration parameters

You can customize your installation configuration based on the requirements of your existing network infrastructure. For example, you can expand the IP address block for the cluster network or provide different IP address blocks than the defaults.

Only IPv4 addresses are supported.

Table 7.6. Network parameters

Parameter	Description	Values
<b>networking</b>	The configuration for the cluster network.	Object  <b>NOTE</b> You cannot modify parameters specified by the <b>networking</b> object after installation.
<b>networking.networkType</b>	The cluster network provider Container Network Interface (CNI) plugin to install.	Either <b>OpenShiftSDN</b> or <b>OVNKubernetes</b> . <b>OpenShiftSDN</b> is a CNI provider for all-Linux networks. <b>OVNKubernetes</b> is a CNI provider for Linux networks and hybrid networks that contain both Linux and Windows servers. The default value is <b>OpenShiftSDN</b> .
<b>networking.clusterNetwork</b>	The IP address blocks for pods.  The default value is <b>10.128.0.0/14</b> with a host prefix of <b>/23</b> .  If you specify multiple IP address blocks, the blocks must not overlap.	An array of objects. For example:  <pre>networking:   clusterNetwork:     - cidr: 10.128.0.0/14       hostPrefix: 23</pre>
<b>networking.clusterNetwork.cidr</b>	Required if you use <b>networking.clusterNetwork</b> . An IP address block.  An IPv4 network.	An IP address block in Classless Inter-Domain Routing (CIDR) notation. The prefix length for an IPv4 block is between <b>0</b> and <b>32</b> .
<b>networking.clusterNetwork.hostPrefix</b>	The subnet prefix length to assign to each individual node. For example, if <b>hostPrefix</b> is set to <b>23</b> then each node is assigned a <b>/23</b> subnet out of the given <b>cidr</b> . A <b>hostPrefix</b> value of <b>23</b> provides 510 ( $2^{(32 - 23)} - 2$ ) pod IP addresses.	A subnet prefix.  The default value is <b>23</b> .
<b>networking.serviceNetwork</b>	The IP address block for services. The default value is <b>172.30.0.0/16</b> .  The OpenShift SDN and OVN-Kubernetes network providers support only a single IP address block for the service network.	An array with an IP address block in CIDR format. For example:  <pre>networking:   serviceNetwork:     - 172.30.0.0/16</pre>

Parameter	Description	Values
<b>networking.machineNetwork</b>	The IP address blocks for machines.  If you specify multiple IP address blocks, the blocks must not overlap.	An array of objects. For example:  <pre>networking:   machineNetwork:   - cidr: 10.0.0.0/16</pre>
<b>networking.machineNetwork.cidr</b>	Required if you use <b>networking.machineNetwork</b> . An IP address block. The default value is <b>10.0.0.0/16</b> for all platforms other than libvirt. For libvirt, the default value is <b>192.168.126.0/24</b> .	An IP network block in CIDR notation.  For example, <b>10.0.0.0/16</b> .   <p><b>NOTE</b></p> <p>Set the <b>networking.machineNetwork</b> to match the CIDR that the preferred NIC resides in.</p>

#### 7.4.6.1.3. Optional configuration parameters

Optional installation configuration parameters are described in the following table:



Table 7.7. Optional parameters

Parameter	Description	Values
<b>additionalTrustBundle</b>	A PEM-encoded X.509 certificate bundle that is added to the nodes' trusted certificate store. This trust bundle may also be used when a proxy has been configured.	String
<b>cgroupsV2</b>	Enables <a href="#">Linux control groups version 2</a> (cgroups v2) on specific nodes in your cluster. The OpenShift Container Platform process for enabling cgroups v2 disables all cgroup version 1 controllers and hierarchies. The OpenShift Container Platform cgroups version 2 feature is in Developer Preview and is not supported by Red Hat at this time.	<b>true</b>
<b>compute</b>	The configuration for the machines that comprise the compute nodes.	Array of <b>MachinePool</b> objects.





Parameter	Description	Values
<b>compute.architecture</b>	Determines the instruction set architecture of the machines in the pool. Currently, clusters with varied architectures are not supported. All pools must specify the same architecture. Valid values are <b>amd64</b> (the default).	String
<b>compute.hyperthreading</b>	Whether to enable or disable simultaneous multithreading, or <b>hyperthreading</b> , on compute machines. By default, simultaneous multithreading is enabled to increase the performance of your machines' cores.   <b>IMPORTANT</b> If you disable simultaneous multithreading, ensure that your capacity planning accounts for the dramatically decreased machine performance.	<b>Enabled</b> or <b>Disabled</b>
<b>compute.name</b>	Required if you use <b>compute</b> . The name of the machine pool.	<b>worker</b>
<b>compute.platform</b>	Required if you use <b>compute</b> . Use this parameter to specify the cloud provider to host the worker machines. This parameter value must match the <b>controlPlane.platform</b> parameter value.	<b>alibabacloud, aws, azure, gcp, ibmcloud, openstack, ovirt, vsphere</b> , or <b>{}</b>
<b>compute.replicas</b>	The number of compute machines, which are also known as worker machines, to provision.	A positive integer greater than or equal to <b>2</b> . The default value is <b>3</b> .
<b>controlPlane</b>	The configuration for the machines that comprise the control plane.	Array of <b>MachinePool</b> objects.

Parameter	Description	Values
<b>controlPlane.architecture</b>	Determines the instruction set architecture of the machines in the pool. Currently, clusters with varied architectures are not supported. All pools must specify the same architecture. Valid values are <b>amd64</b> (the default).	String
<b>controlPlane.hyperthreading</b>	Whether to enable or disable simultaneous multithreading, or <b>hyperthreading</b> , on control plane machines. By default, simultaneous multithreading is enabled to increase the performance of your machines' cores.   <b>IMPORTANT</b>  If you disable simultaneous multithreading, ensure that your capacity planning accounts for the dramatically decreased machine performance.	<b>Enabled</b> or <b>Disabled</b>
<b>controlPlane.name</b>	Required if you use <b>controlPlane</b> . The name of the machine pool.	<b>master</b>
<b>controlPlane.platform</b>	Required if you use <b>controlPlane</b> . Use this parameter to specify the cloud provider that hosts the control plane machines. This parameter value must match the <b>compute.platform</b> parameter value.	<b>alibabacloud, aws, azure, gcp, ibmcloud, openstack, ovirt, vsphere, or {}</b>
<b>controlPlane.replicas</b>	The number of control plane machines to provision.	The only supported value is <b>3</b> , which is the default value.

Parameter	Description	Values
<b>credentialsMode</b>	<p>The Cloud Credential Operator (CCO) mode. If no mode is specified, the CCO dynamically tries to determine the capabilities of the provided credentials, with a preference for mint mode on the platforms where multiple modes are supported.</p> <div data-bbox="485 512 595 864" style="border: 1px solid black; padding: 5px; margin-bottom: 10px;">  </div> <p><b>NOTE</b></p> <p>Not all CCO modes are supported for all cloud providers. For more information on CCO modes, see the <i>Cloud Credential Operator</i> entry in the <i>Cluster Operators</i> reference content.</p> <div data-bbox="485 909 595 1261" style="border: 1px solid black; padding: 5px;">  </div> <p><b>NOTE</b></p> <p>If your AWS account has service control policies (SCP) enabled, you must configure the <b>credentialsMode</b> parameter to <b>Mint</b>, <b>Passthrough</b> or <b>Manual</b>.</p>	<b>Mint, Passthrough, Manual</b> or an empty string ("").

Parameter	Description	Values
<b>fips</b>	<p>Enable or disable FIPS mode. The default is <b>false</b> (disabled). If FIPS mode is enabled, the Red Hat Enterprise Linux CoreOS (RHCOS) machines that OpenShift Container Platform runs on bypass the default Kubernetes cryptography suite and use the cryptography modules that are provided with RHCOS instead.</p> <div style="display: flex; align-items: flex-start;"> <div style="width: 20px; height: 100px; background: repeating-linear-gradient(45deg, transparent, transparent 2px, black 2px, black 4px); margin-right: 10px;"></div> <div> <p><b>IMPORTANT</b></p> <p>To enable FIPS mode for your cluster, you must run the installation program from a Red Hat Enterprise Linux (RHEL) computer configured to operate in FIPS mode. For more information about configuring FIPS mode on RHEL, see <a href="#">Installing the system in FIPS mode</a>. The use of FIPS validated or Modules In Process cryptographic libraries is only supported on OpenShift Container Platform deployments on the <b>x86_64</b> architecture.</p> </div> </div> <div style="display: flex; align-items: flex-start; margin-top: 20px;"> <div style="width: 20px; height: 50px; background: repeating-linear-gradient(45deg, transparent, transparent 2px, black 2px, black 4px); margin-right: 10px;"></div> <div> <p><b>NOTE</b></p> <p>If you are using Azure File storage, you cannot enable FIPS mode.</p> </div> </div>	<b>false</b> or <b>true</b>
<b>imageContentSources</b>	Sources and repositories for the release-image content.	Array of objects. Includes a <b>source</b> and, optionally, <b>mirrors</b> , as described in the following rows of this table.
<b>imageContentSources.source</b>	Required if you use <b>imageContentSources</b> . Specify the repository that users refer to, for example, in image pull specifications.	String
<b>imageContentSources.mirrors</b>	Specify one or more repositories that may also contain the same images.	Array of strings

Parameter	Description	Values
<b>publish</b>	How to publish or expose the user-facing endpoints of your cluster, such as the Kubernetes API, OpenShift routes.	<p><b>Internal</b> or <b>External</b>. The default value is <b>External</b>.</p> <p>Setting this field to <b>Internal</b> is not supported on non-cloud platforms and IBM Cloud VPC.</p> <div style="display: flex; align-items: flex-start;">  <div> <p><b>IMPORTANT</b></p> <p>If the value of the field is set to <b>Internal</b>, the cluster will become non-functional. For more information, refer to <a href="#">BZ#1953035</a>.</p> </div> </div>
<b>sshKey</b>	<p>The SSH key or keys to authenticate access your cluster machines.</p> <div style="display: flex; align-items: flex-start;">  <div> <p><b>NOTE</b></p> <p>For production OpenShift Container Platform clusters on which you want to perform installation debugging or disaster recovery, specify an SSH key that your <b>ssh-agent</b> process uses.</p> </div> </div>	<p>One or more keys. For example:</p> <pre>sshKey:   &lt;key1&gt;   &lt;key2&gt;   &lt;key3&gt;</pre>

#### 7.4.6.1.4. Additional Azure Stack Hub configuration parameters

Additional Azure configuration parameters are described in the following table:

Table 7.8. Additional Azure Stack Hub parameters

Parameter	Description	Values
<b>compute.platform.azure.osDisk.diskSizeGB</b>	The Azure disk size for the VM.	Integer that represents the size of the disk in GB. The default is <b>128</b> .
<b>compute.platform.azure.osDisk.diskType</b>	Defines the type of disk.	<b>standard_LRS</b> or <b>premium_LRS</b> . The default is <b>premium_LRS</b> .
<b>controlPlane.platform.azure.osDisk.diskSizeGB</b>	The Azure disk size for the VM.	Integer that represents the size of the disk in GB. The default is <b>1024</b> .

Parameter	Description	Values
<b>controlPlane.platform.azure.osDisk.diskType</b>	Defines the type of disk.	<b>premium_LRS.</b>
<b>platform.azure.armEndpoint</b>	The URL of the Azure Resource Manager endpoint that your Azure Stack Hub operator provides.	String
<b>platform.azure.baseDomainResourceGroupName</b>	The name of the resource group that contains the DNS zone for your base domain.	String, for example <b>production_cluster.</b>
<b>platform.azure.region</b>	The name of your Azure Stack Hub local region.	String
<b>platform.azure.resourceGroupName</b>	The name of an already existing resource group to install your cluster to. This resource group must be empty and only used for this specific cluster; the cluster components assume ownership of all resources in the resource group. If you limit the service principal scope of the installation program to this resource group, you must ensure all other resources used by the installation program in your environment have the necessary permissions, such as the public DNS zone and virtual network. Destroying the cluster by using the installation program deletes this resource group.	String, for example <b>existing_resource_group.</b>
<b>platform.azure.outboundType</b>	The outbound routing strategy used to connect your cluster to the internet. If you are using user-defined routing, you must have pre-existing networking available where the outbound routing has already been configured prior to installing a cluster. The installation program is not responsible for configuring user-defined routing.	<b>LoadBalancer</b> or <b>UserDefinedRouting.</b> The default is <b>LoadBalancer.</b>
<b>platform.azure.cloudName</b>	The name of the Azure cloud environment that is used to configure the Azure SDK with the appropriate Azure API endpoints.	<b>AzureStackCloud</b>

Parameter	Description	Values
<b>clusterOSImage</b>	The URL of a storage blob in the Azure Stack environment that contains an RHCOS VHD.	String, for example, <code>https://vhdsa.blob.example.example.com/vhd/rhcos-410.84.202112040202-0-azurestack.x86_64.vhd</code>

### 7.4.6.2. Sample customized install-config.yaml file for Azure Stack Hub

You can customize the **install-config.yaml** file to specify more details about your OpenShift Container Platform cluster's platform or modify the values of the required parameters.



#### IMPORTANT

This sample YAML file is provided for reference only. Use it as a resource to enter parameter values into the installation configuration file that you created manually.

```

apiVersion: v1
baseDomain: example.com 1
credentialsMode: Manual
controlPlane: 2 3
  name: master
  platform:
    azure:
      osDisk:
        diskSizeGB: 1024 4
        diskType: premium_LRS
      replicas: 3
compute: 5
- name: worker
  platform:
    azure:
      osDisk:
        diskSizeGB: 512 6
        diskType: premium_LRS
      replicas: 3
metadata:
  name: test-cluster 7 8
networking:
  clusterNetwork:
    - cidr: 10.128.0.0/14
      hostPrefix: 23
  machineNetwork:
    - cidr: 10.0.0.0/16
  networkType: OpenShiftSDN
  serviceNetwork:
    - 172.30.0.0/16
platform:
  azure:
    armEndpoint: azurestack_arm_endpoint 9 10
    baseDomainResourceGroupName: resource_group 11 12
    region: azure_stack_local_region 13 14

```

```

resourceGroupName: existing_resource_group 15
outboundType: Loadbalancer
cloudName: AzureStackCloud 16
clusterOSImage: https://vhdsa.blob.example.example.com/vhd/rhcos-410.84.202112040202-0-
azurestack.x86_64.vhd 17 18
pullSecret: '{"auths": ...}' 19 20
fips: false 21
sshKey: ssh-ed25519 AAAA... 22
additionalTrustBundle: | 23
  -----BEGIN CERTIFICATE-----
  <MY_TRUSTED_CA_CERT>
  -----END CERTIFICATE-----

```

1 7 9 11 13 16 17 19 Required.

2 5 If you do not provide these parameters and values, the installation program provides the default value.

3 The **controlPlane** section is a single mapping, but the **compute** section is a sequence of mappings. To meet the requirements of the different data structures, the first line of the **compute** section must begin with a hyphen, -, and the first line of the **controlPlane** section must not. Although both sections currently define a single machine pool, it is possible that future versions of OpenShift Container Platform will support defining multiple compute pools during installation. Only one control plane pool is used.

4 6 You can specify the size of the disk to use in GB. Minimum recommendation for control plane nodes is 1024 GB.

8 The name of the cluster.

10 The Azure Resource Manager endpoint that your Azure Stack Hub operator provides.

12 The name of the resource group that contains the DNS zone for your base domain.

14 The name of your Azure Stack Hub local region.

15 The name of an existing resource group to install your cluster to. If undefined, a new resource group is created for the cluster.

18 The URL of a storage blob in the Azure Stack environment that contains an RHCOS VHD.

20 The pull secret required to authenticate your cluster.

21 Whether to enable or disable FIPS mode. By default, FIPS mode is not enabled. If FIPS mode is enabled, the Red Hat Enterprise Linux CoreOS (RHCOS) machines that OpenShift Container Platform runs on bypass the default Kubernetes cryptography suite and use the cryptography modules that are provided with RHCOS instead.





## IMPORTANT

To enable FIPS mode for your cluster, you must run the installation program from a Red Hat Enterprise Linux (RHEL) computer configured to operate in FIPS mode. For more information about configuring FIPS mode on RHEL, see [Installing the system in FIPS mode](#). The use of FIPS validated or Modules In Process cryptographic libraries is only supported on OpenShift Container Platform deployments on the **x86\_64** architecture.

22

You can optionally provide the **sshKey** value that you use to access the machines in your cluster.



## NOTE

For production OpenShift Container Platform clusters on which you want to perform installation debugging or disaster recovery, specify an SSH key that your **ssh-agent** process uses.

23

If the Azure Stack Hub environment is using an internal Certificate Authority (CA), adding the CA certificate is required.

### 7.4.7. Manually manage cloud credentials

The Cloud Credential Operator (CCO) only supports your cloud provider in manual mode. As a result, you must specify the identity and access management (IAM) secrets for your cloud provider.

#### Procedure

1. Generate the manifests by running the following command from the directory that contains the installation program:

```
$ openshift-install create manifests --dir <installation_directory>
```

where **<installation\_directory>** is the directory in which the installation program creates files.

2. From the directory that contains the installation program, obtain details of the OpenShift Container Platform release image that your **openshift-install** binary is built to use by running the following command:

```
$ openshift-install version
```

#### Example output

```
release image quay.io/openshift-release-dev/ocp-release:4.y.z-x86_64
```

3. Locate all **CredentialsRequest** objects in this release image that target the cloud you are deploying on by running the following command:

```
$ oc adm release extract quay.io/openshift-release-dev/ocp-release:4.y.z-x86_64 \
  --credentials-requests \
  --cloud=azure
```

This command creates a YAML file for each **CredentialsRequest** object.

### Sample `CredentialsRequest` object

```

apiVersion: cloudcredential.openshift.io/v1
kind: CredentialsRequest
metadata:
  name: <component-credentials-request>
  namespace: openshift-cloud-credential-operator
  ...
spec:
  providerSpec:
    apiVersion: cloudcredential.openshift.io/v1
    kind: AzureProviderSpec
    roleBindings:
      - role: Contributor
    ...

```

4. Create YAML files for secrets in the **openshift-install** manifests directory that you generated previously. The secrets must be stored using the namespace and secret name defined in the **spec.secretRef** for each **CredentialsRequest** object.

### Sample `CredentialsRequest` object with secrets

```

apiVersion: cloudcredential.openshift.io/v1
kind: CredentialsRequest
metadata:
  name: <component-credentials-request>
  namespace: openshift-cloud-credential-operator
  ...
spec:
  providerSpec:
    apiVersion: cloudcredential.openshift.io/v1
    kind: AzureProviderSpec
    roleBindings:
      - role: Contributor
    ...
  secretRef:
    name: <component-secret>
    namespace: <component-namespace>
  ...

```

### Sample `Secret` object

```

apiVersion: v1
kind: Secret
metadata:
  name: <component-secret>
  namespace: <component-namespace>
data:
  azure_subscription_id: <base64_encoded_azure_subscription_id>
  azure_client_id: <base64_encoded_azure_client_id>
  azure_client_secret: <base64_encoded_azure_client_secret>
  azure_tenant_id: <base64_encoded_azure_tenant_id>

```

```
azure_resource_prefix: <base64_encoded_azure_resource_prefix>
azure_resourcegroup: <base64_encoded_azure_resourcegroup>
azure_region: <base64_encoded_azure_region>
```

### IMPORTANT

The release image includes **CredentialsRequest** objects for Technology Preview features that are enabled by the **TechPreviewNoUpgrade** feature set. You can identify these objects by their use of the **release.openshift.io/feature-gate: TechPreviewNoUpgrade** annotation.

- If you are not using any of these features, do not create secrets for these objects. Creating secrets for Technology Preview features that you are not using can cause the installation to fail.
- If you are using any of these features, you must create secrets for the corresponding objects.

- To find **CredentialsRequest** objects with the **TechPreviewNoUpgrade** annotation, run the following command:

```
$ grep "release.openshift.io/feature-gate" *
```

#### Example output

```
0000_30_capi-operator_00_credentials-request.yaml: release.openshift.io/feature-gate:
TechPreviewNoUpgrade
```

### IMPORTANT

Before upgrading a cluster that uses manually maintained credentials, you must ensure that the CCO is in an upgradeable state.

#### Additional resources

- [Updating a cluster using the web console](#)
- [Updating a cluster using the CLI](#)

### 7.4.8. Configuring the cluster to use an internal CA

If the Azure Stack Hub environment is using an internal Certificate Authority (CA), update the **cluster-proxy-01-config.yaml** file to configure the cluster to use the internal CA.

#### Prerequisites

- Create the **install-config.yaml** file and specify the certificate trust bundle in **.pem** format.
- Create the cluster manifests.

#### Procedure

1. From the directory in which the installation program creates files, go to the **manifests** directory.

2. Add **user-ca-bundle** to the **spec.trustedCA.name** field.

#### Example cluster-proxy-01-config.yaml file

```
apiVersion: config.openshift.io/v1
kind: Proxy
metadata:
  creationTimestamp: null
  name: cluster
spec:
  trustedCA:
    name: user-ca-bundle
status: {}
```

3. Optional: Back up the **manifests/ cluster-proxy-01-config.yaml** file. The installation program consumes the **manifests/** directory when you deploy the cluster.

### 7.4.9. Network configuration phases

There are two phases prior to OpenShift Container Platform installation where you can customize the network configuration.

#### Phase 1

You can customize the following network-related fields in the **install-config.yaml** file before you create the manifest files:

- **networking.networkType**
- **networking.clusterNetwork**
- **networking.serviceNetwork**
- **networking.machineNetwork**

For more information on these fields, refer to *Installation configuration parameters*.



#### NOTE

Set the **networking.machineNetwork** to match the CIDR that the preferred NIC resides in.



#### IMPORTANT

The CIDR range **172.17.0.0/16** is reserved by libVirt. You cannot use this range or any range that overlaps with this range for any networks in your cluster.

#### Phase 2

After creating the manifest files by running **openshift-install create manifests**, you can define a customized Cluster Network Operator manifest with only the fields you want to modify. You can use the manifest to specify advanced network configuration.

You cannot override the values specified in phase 1 in the **install-config.yaml** file during phase 2. However, you can further customize the cluster network provider during phase 2.

## 7.4.10. Specifying advanced network configuration

You can use advanced network configuration for your cluster network provider to integrate your cluster into your existing network environment. You can specify advanced network configuration only before you install the cluster.



### IMPORTANT

Customizing your network configuration by modifying the OpenShift Container Platform manifest files created by the installation program is not supported. Applying a manifest file that you create, as in the following procedure, is supported.

### Prerequisites

- You have created the **install-config.yaml** file and completed any modifications to it.

### Procedure

- Change to the directory that contains the installation program and create the manifests:

```
$ ./openshift-install create manifests --dir <installation_directory> 1
```

- 1** **<installation\_directory>** specifies the name of the directory that contains the **install-config.yaml** file for your cluster.

- Create a stub manifest file for the advanced network configuration that is named **cluster-network-03-config.yml** in the **<installation\_directory>/manifests/** directory:

```
apiVersion: operator.openshift.io/v1
kind: Network
metadata:
  name: cluster
spec:
```

- Specify the advanced network configuration for your cluster in the **cluster-network-03-config.yml** file, such as in the following examples:

#### Specify a different VXLAN port for the OpenShift SDN network provider

```
apiVersion: operator.openshift.io/v1
kind: Network
metadata:
  name: cluster
spec:
  defaultNetwork:
    openshiftSDNConfig:
      vxlanPort: 4800
```

#### Enable IPsec for the OVN-Kubernetes network provider

```
apiVersion: operator.openshift.io/v1
kind: Network
metadata:
```

```

name: cluster
spec:
  defaultNetwork:
    ovnKubernetesConfig:
      ipsecConfig: {}

```

- Optional: Back up the **manifests/cluster-network-03-config.yml** file. The installation program consumes the **manifests/** directory when you create the Ignition config files.

### 7.4.11. Cluster Network Operator configuration

The configuration for the cluster network is specified as part of the Cluster Network Operator (CNO) configuration and stored in a custom resource (CR) object that is named **cluster**. The CR specifies the fields for the **Network** API in the **operator.openshift.io** API group.

The CNO configuration inherits the following fields during cluster installation from the **Network** API in the **Network.config.openshift.io** API group and these fields cannot be changed:

#### **clusterNetwork**

IP address pools from which pod IP addresses are allocated.

#### **serviceNetwork**

IP address pool for services.

#### **defaultNetwork.type**

Cluster network provider, such as OpenShift SDN or OVN-Kubernetes.

You can specify the cluster network provider configuration for your cluster by setting the fields for the **defaultNetwork** object in the CNO object named **cluster**.

#### 7.4.11.1. Cluster Network Operator configuration object

The fields for the Cluster Network Operator (CNO) are described in the following table:

Table 7.9. Cluster Network Operator configuration object

Field	Type	Description
<b>metadata.name</b>	<b>string</b>	The name of the CNO object. This name is always <b>cluster</b> .
<b>spec.clusterNetwork</b>	<b>array</b>	<p>A list specifying the blocks of IP addresses from which pod IP addresses are allocated and the subnet prefix length assigned to each individual node in the cluster. For example:</p> <pre> spec:   clusterNetwork:     - cidr: 10.128.0.0/19       hostPrefix: 23     - cidr: 10.128.32.0/19       hostPrefix: 23 </pre> <p>You can customize this field only in the <b>install-config.yaml</b> file before you create the manifests. The value is read-only in the manifest file.</p>

Field	Type	Description
<b>spec.serviceNetwork</b>	<b>array</b>	<p>A block of IP addresses for services. The OpenShift SDN and OVN-Kubernetes Container Network Interface (CNI) network providers support only a single IP address block for the service network. For example:</p> <pre>spec:   serviceNetwork:   - 172.30.0.0/14</pre> <p>You can customize this field only in the <b>install-config.yaml</b> file before you create the manifests. The value is read-only in the manifest file.</p>
<b>spec.defaultNetwork</b>	<b>object</b>	Configures the Container Network Interface (CNI) cluster network provider for the cluster network.
<b>spec.kubeProxyConfig</b>	<b>object</b>	The fields for this object specify the kube-proxy configuration. If you are using the OVN-Kubernetes cluster network provider, the kube-proxy configuration has no effect.

#### defaultNetwork object configuration

The values for the **defaultNetwork** object are defined in the following table:

Table 7.10. **defaultNetwork** object

Field	Type	Description
<b>type</b>	<b>string</b>	<p>Either <b>OpenShiftSDN</b> or <b>OVNKubernetes</b>. The cluster network provider is selected during installation. This value cannot be changed after cluster installation.</p> <div style="display: flex; align-items: flex-start;"> <div style="flex: 1;">  </div> <div style="flex: 2;"> <p><b>NOTE</b></p> <p>OpenShift Container Platform uses the OpenShift SDN Container Network Interface (CNI) cluster network provider by default.</p> </div> </div>
<b>openshiftSDNConfig</b>	<b>object</b>	This object is only valid for the OpenShift SDN cluster network provider.
<b>ovnKubernetesConfig</b>	<b>object</b>	This object is only valid for the OVN-Kubernetes cluster network provider.

#### Configuration for the OpenShift SDN CNI cluster network provider

The following table describes the configuration fields for the OpenShift SDN Container Network Interface (CNI) cluster network provider.

Table 7.11. openshiftSDNConfig object

Field	Type	Description
<b>mode</b>	<b>string</b>	<p>Configures the network isolation mode for OpenShift SDN. The default value is <b>NetworkPolicy</b>.</p> <p>The values <b>Multitenant</b> and <b>Subnet</b> are available for backwards compatibility with OpenShift Container Platform 3.x but are not recommended. This value cannot be changed after cluster installation.</p>
<b>mtu</b>	<b>integer</b>	<p>The maximum transmission unit (MTU) for the VXLAN overlay network. This is detected automatically based on the MTU of the primary network interface. You do not normally need to override the detected MTU.</p> <p>If the auto-detected value is not what you expect it to be, confirm that the MTU on the primary network interface on your nodes is correct. You cannot use this option to change the MTU value of the primary network interface on the nodes.</p> <p>If your cluster requires different MTU values for different nodes, you must set this value to <b>50</b> less than the lowest MTU value in your cluster. For example, if some nodes in your cluster have an MTU of <b>9001</b>, and some have an MTU of <b>1500</b>, you must set this value to <b>1450</b>.</p> <p>This value cannot be changed after cluster installation.</p>
<b>vxlanPort</b>	<b>integer</b>	<p>The port to use for all VXLAN packets. The default value is <b>4789</b>. This value cannot be changed after cluster installation.</p> <p>If you are running in a virtualized environment with existing nodes that are part of another VXLAN network, then you might be required to change this. For example, when running an OpenShift SDN overlay on top of VMware NSX-T, you must select an alternate port for the VXLAN, because both SDNs use the same default VXLAN port number.</p> <p>On Amazon Web Services (AWS), you can select an alternate port for the VXLAN between port <b>9000</b> and port <b>9999</b>.</p>

### Example OpenShift SDN configuration

```
defaultNetwork:
  type: OpenShiftSDN
  openshiftSDNConfig:
    mode: NetworkPolicy
    mtu: 1450
    vxlanPort: 4789
```

### Configuration for the OVN-Kubernetes CNI cluster network provider



The following table describes the configuration fields for the OVN-Kubernetes CNI cluster network provider.

Table 7.12. `ovnKubernetesConfig` object

Field	Type	Description
<code>mtu</code>	<code>integer</code>	<p>The maximum transmission unit (MTU) for the Geneve (Generic Network Virtualization Encapsulation) overlay network. This is detected automatically based on the MTU of the primary network interface. You do not normally need to override the detected MTU.</p> <p>If the auto-detected value is not what you expect it to be, confirm that the MTU on the primary network interface on your nodes is correct. You cannot use this option to change the MTU value of the primary network interface on the nodes.</p> <p>If your cluster requires different MTU values for different nodes, you must set this value to <b>100</b> less than the lowest MTU value in your cluster. For example, if some nodes in your cluster have an MTU of <b>9001</b>, and some have an MTU of <b>1500</b>, you must set this value to <b>1400</b>.</p>
<code>genevePort</code>	<code>integer</code>	The port to use for all Geneve packets. The default value is <b>6081</b> . This value cannot be changed after cluster installation.
<code>ipsecConfig</code>	<code>object</code>	Specify an empty object to enable IPsec encryption. This value cannot be changed after cluster installation.
<code>policyAuditConfig</code>	<code>object</code>	Specify a configuration object for customizing network policy audit logging. If unset, the defaults audit log settings are used.
<code>gatewayConfig</code>	<code>object</code>	<p>Optional: Specify a configuration object for customizing how egress traffic is sent to the node gateway.</p> <div style="display: flex; align-items: flex-start;"> <div style="flex: 1;">  </div> <div style="flex: 2;"> <p><b>NOTE</b></p> <p>While migrating egress traffic, you can expect some disruption to workloads and service traffic until the Cluster Network Operator (CNO) successfully rolls out the changes.</p> </div> </div>

Table 7.13. `policyAuditConfig` object

Field	Type	Description
<code>rateLimit</code>	<code>integer</code>	The maximum number of messages to generate every second per node. The default value is <b>20</b> messages per second.

Field	Type	Description
<b>maxFileSize</b>	integer	The maximum size for the audit log in bytes. The default value is <b>50000000</b> or 50 MB.
<b>destination</b>	string	One of the following additional audit log targets:  <b>libc</b> The libc <b>syslog()</b> function of the journald process on the host. <b>udp:&lt;host&gt;:&lt;port&gt;</b> A syslog server. Replace <b>&lt;host&gt;:&lt;port&gt;</b> with the host and port of the syslog server. <b>unix:&lt;file&gt;</b> A Unix Domain Socket file specified by <b>&lt;file&gt;</b> . <b>null</b> Do not send the audit logs to any additional target.
<b>syslogFacility</b>	string	The syslog facility, such as <b>kern</b> , as defined by RFC5424. The default value is <b>local0</b> .

Table 7.14. gatewayConfig object

Field	Type	Description
<b>routingViaHost</b>	<b>boolean</b>	Set this field to <b>true</b> to send egress traffic from pods to the host networking stack. For highly-specialized installations and applications that rely on manually configured routes in the kernel routing table, you might want to route egress traffic to the host networking stack. By default, egress traffic is processed in OVN to exit the cluster and is not affected by specialized routes in the kernel routing table. The default value is <b>false</b> .  This field has an interaction with the Open vSwitch hardware offloading feature. If you set this field to <b>true</b> , you do not receive the performance benefits of the offloading because egress traffic is processed by the host networking stack.

### Example OVN-Kubernetes configuration with IPsec enabled

```
defaultNetwork:
  type: OVNKubernetes
  ovnKubernetesConfig:
    mtu: 1400
    genevePort: 6081
    ipsecConfig: {}
```

### kubeProxyConfig object configuration

The values for the **kubeProxyConfig** object are defined in the following table:

Table 7.15. kubeProxyConfig object

Field	Type	Description
<b>iptablesSyncPeriod</b>	<b>string</b>	<p>The refresh period for <b>iptables</b> rules. The default value is <b>30s</b>. Valid suffixes include <b>s</b>, <b>m</b>, and <b>h</b> and are described in the <a href="#">Go time package</a> documentation.</p> <div style="display: flex; align-items: flex-start;">  <div> <p><b>NOTE</b></p> <p>Because of performance improvements introduced in OpenShift Container Platform 4.3 and greater, adjusting the <b>iptablesSyncPeriod</b> parameter is no longer necessary.</p> </div> </div>
<b>proxyArguments.iptables-min-sync-period</b>	<b>array</b>	<p>The minimum duration before refreshing <b>iptables</b> rules. This field ensures that the refresh does not happen too frequently. Valid suffixes include <b>s</b>, <b>m</b>, and <b>h</b> and are described in the <a href="#">Go time package</a>. The default value is:</p> <pre>kubeProxyConfig:   proxyArguments:     iptables-min-sync-period:       - 0s</pre>

### 7.4.12. Configuring hybrid networking with OVN-Kubernetes

You can configure your cluster to use hybrid networking with OVN-Kubernetes. This allows a hybrid cluster that supports different node networking configurations. For example, this is necessary to run both Linux and Windows nodes in a cluster.



#### IMPORTANT

You must configure hybrid networking with OVN-Kubernetes during the installation of your cluster. You cannot switch to hybrid networking after the installation process.

#### Prerequisites

- You defined **OVNKubernetes** for the **networking.networkType** parameter in the **install-config.yaml** file. See the installation documentation for configuring OpenShift Container Platform network customizations on your chosen cloud provider for more information.

#### Procedure

- Change to the directory that contains the installation program and create the manifests:

```
$ ./openshift-install create manifests --dir <installation_directory>
```

where:

**<installation\_directory>**

Specifies the name of the directory that contains the **install-config.yaml** file for your cluster.

2. Create a stub manifest file for the advanced network configuration that is named **cluster-network-03-config.yaml** in the **<installation\_directory>/manifests/** directory:

```
$ cat <<EOF > <installation_directory>/manifests/cluster-network-03-config.yaml
apiVersion: operator.openshift.io/v1
kind: Network
metadata:
  name: cluster
spec:
EOF
```

where:

**<installation\_directory>**

Specifies the directory name that contains the **manifests/** directory for your cluster.

3. Open the **cluster-network-03-config.yaml** file in an editor and configure OVN-Kubernetes with hybrid networking, such as in the following example:

### Specify a hybrid networking configuration

```
apiVersion: operator.openshift.io/v1
kind: Network
metadata:
  name: cluster
spec:
  defaultNetwork:
    ovnKubernetesConfig:
      hybridOverlayConfig:
        hybridClusterNetwork: 1
        - cidr: 10.132.0.0/14
        hostPrefix: 23
        hybridOverlayVXLANPort: 9898 2
```

- 1 Specify the CIDR configuration used for nodes on the additional overlay network. The **hybridClusterNetwork** CIDR cannot overlap with the **clusterNetwork** CIDR.
- 2 Specify a custom VXLAN port for the additional overlay network. This is required for running Windows nodes in a cluster installed on vSphere, and must not be configured for any other cloud provider. The custom port can be any open port excluding the default **4789** port. For more information on this requirement, see the Microsoft documentation on [Pod-to-pod connectivity between hosts is broken](#).

**NOTE**

Windows Server Long-Term Servicing Channel (LTSC): Windows Server 2019 is not supported on clusters with a custom **hybridOverlayVXLANPort** value because this Windows server version does not support selecting a custom VXLAN port.

4. Save the **cluster-network-03-config.yml** file and quit the text editor.
5. Optional: Back up the **manifests/cluster-network-03-config.yml** file. The installation program deletes the **manifests/** directory when creating the cluster.

**NOTE**

For more information on using Linux and Windows nodes in the same cluster, see [Understanding Windows container workloads](#).

### 7.4.13. Deploying the cluster

You can install OpenShift Container Platform on a compatible cloud platform.

**IMPORTANT**

You can run the **create cluster** command of the installation program only once, during initial installation.

#### Prerequisites

- Configure an account with the cloud platform that hosts your cluster.
- Obtain the OpenShift Container Platform installation program and the pull secret for your cluster.

#### Procedure

1. Change to the directory that contains the installation program and initialize the cluster deployment:

```
$ ./openshift-install create cluster --dir <installation_directory> \ 1
--log-level=info 2
```

- 1** For **<installation\_directory>**, specify the location of your customized **./install-config.yaml** file.
- 2** To view different installation details, specify **warn**, **debug**, or **error** instead of **info**.

**NOTE**

If the cloud provider account that you configured on your host does not have sufficient permissions to deploy the cluster, the installation process stops, and the missing permissions are displayed.

When the cluster deployment completes, directions for accessing your cluster, including a link to its web console and credentials for the **kubeadmin** user, display in your terminal.

### Example output

```
...
INFO Install complete!
INFO To access the cluster as the system:admin user when using 'oc', run 'export
KUBECONFIG=/home/myuser/install_dir/auth/kubeconfig'
INFO Access the OpenShift web-console here: https://console-openshift-
console.apps.mycluster.example.com
INFO Login to the console with user: "kubeadmin", and password: "4vYBz-Ee6gm-ymBZj-
Wt5AL"
INFO Time elapsed: 36m22s
```



### NOTE

The cluster access and credential information also outputs to **<installation\_directory>/openshift\_install.log** when an installation succeeds.

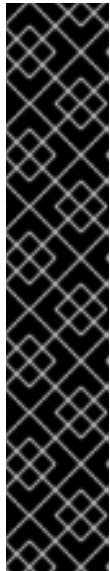

### IMPORTANT

- The Ignition config files that the installation program generates contain certificates that expire after 24 hours, which are then renewed at that time. If the cluster is shut down before renewing the certificates and the cluster is later restarted after the 24 hours have elapsed, the cluster automatically recovers the expired certificates. The exception is that you must manually approve the pending **node-bootstrapper** certificate signing requests (CSRs) to recover kubelet certificates. See the documentation for *Recovering from expired control plane certificates* for more information.
- It is recommended that you use Ignition config files within 12 hours after they are generated because the 24-hour certificate rotates from 16 to 22 hours after the cluster is installed. By using the Ignition config files within 12 hours, you can avoid installation failure if the certificate update runs during installation.



### IMPORTANT

You must not delete the installation program or the files that the installation program creates. Both are required to delete the cluster.

## 7.4.14. Installing the OpenShift CLI by downloading the binary

You can install the OpenShift CLI (**oc**) to interact with OpenShift Container Platform from a command-line interface. You can install **oc** on Linux, Windows, or macOS.

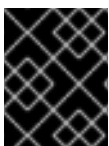

### IMPORTANT

If you installed an earlier version of **oc**, you cannot use it to complete all of the commands in OpenShift Container Platform 4.10. Download and install the new version of **oc**.

### Installing the OpenShift CLI on Linux

You can install the OpenShift CLI (**oc**) binary on Linux by using the following procedure.

### Procedure

1. Navigate to the [OpenShift Container Platform downloads page](#) on the Red Hat Customer Portal.
2. Select the appropriate version in the **Version** drop-down menu.
3. Click **Download Now** next to the **OpenShift v4.10 Linux Client** entry and save the file.
4. Unpack the archive:

```
$ tar xvf <file>
```

5. Place the **oc** binary in a directory that is on your **PATH**.  
To check your **PATH**, execute the following command:

```
$ echo $PATH
```

After you install the OpenShift CLI, it is available using the **oc** command:

```
$ oc <command>
```

### Installing the OpenShift CLI on Windows

You can install the OpenShift CLI (**oc**) binary on Windows by using the following procedure.

### Procedure

1. Navigate to the [OpenShift Container Platform downloads page](#) on the Red Hat Customer Portal.
2. Select the appropriate version in the **Version** drop-down menu.
3. Click **Download Now** next to the **OpenShift v4.10 Windows Client** entry and save the file.
4. Unzip the archive with a ZIP program.
5. Move the **oc** binary to a directory that is on your **PATH**.  
To check your **PATH**, open the command prompt and execute the following command:

```
C:\> path
```

After you install the OpenShift CLI, it is available using the **oc** command:

```
C:\> oc <command>
```

### Installing the OpenShift CLI on macOS

You can install the OpenShift CLI (**oc**) binary on macOS by using the following procedure.

### Procedure

1. Navigate to the [OpenShift Container Platform downloads page](#) on the Red Hat Customer Portal.
2. Select the appropriate version in the **Version** drop-down menu.
3. Click **Download Now** next to the **OpenShift v4.10 MacOSX Client** entry and save the file.
4. Unpack and unzip the archive.
5. Move the **oc** binary to a directory on your PATH.  
To check your **PATH**, open a terminal and execute the following command:

```
$ echo $PATH
```

After you install the OpenShift CLI, it is available using the **oc** command:

```
$ oc <command>
```

### 7.4.15. Logging in to the cluster by using the CLI

You can log in to your cluster as a default system user by exporting the cluster **kubeconfig** file. The **kubeconfig** file contains information about the cluster that is used by the CLI to connect a client to the correct cluster and API server. The file is specific to a cluster and is created during OpenShift Container Platform installation.

#### Prerequisites

- You deployed an OpenShift Container Platform cluster.
- You installed the **oc** CLI.

#### Procedure

1. Export the **kubeadmin** credentials:

```
$ export KUBECONFIG=<installation_directory>/auth/kubeconfig 1
```

- 1** For **<installation\_directory>**, specify the path to the directory that you stored the installation files in.

2. Verify you can run **oc** commands successfully using the exported configuration:

```
$ oc whoami
```

#### Example output

```
system:admin
```

### 7.4.16. Logging in to the cluster by using the web console

The **kubeadmin** user exists by default after an OpenShift Container Platform installation. You can log in to your cluster as the **kubeadmin** user by using the OpenShift Container Platform web console.



## Prerequisites

- You have access to the installation host.
- You completed a cluster installation and all cluster Operators are available.

## Procedure

1. Obtain the password for the **kubeadmin** user from the **kubeadmin-password** file on the installation host:

```
$ cat <installation_directory>/auth/kubeadmin-password
```



### NOTE

Alternatively, you can obtain the **kubeadmin** password from the **<installation\_directory>/openshift\_install.log** log file on the installation host.

2. List the OpenShift Container Platform web console route:

```
$ oc get routes -n openshift-console | grep 'console-openshift'
```



### NOTE

Alternatively, you can obtain the OpenShift Container Platform route from the **<installation\_directory>/openshift\_install.log** log file on the installation host.

## Example output

```
console    console-openshift-console.apps.<cluster_name>.<base_domain>    console
https reencrypt/Redirect None
```

3. Navigate to the route detailed in the output of the preceding command in a web browser and log in as the **kubeadmin** user.

## Additional resources

- [Accessing the web console.](#)

### 7.4.17. Telemetry access for OpenShift Container Platform

In OpenShift Container Platform 4.10, the Telemetry service, which runs by default to provide metrics about cluster health and the success of updates, requires internet access. If your cluster is connected to the internet, Telemetry runs automatically, and your cluster is registered to [OpenShift Cluster Manager](#).

After you confirm that your [OpenShift Cluster Manager](#) inventory is correct, either maintained automatically by Telemetry or manually by using OpenShift Cluster Manager, [use subscription watch](#) to track your OpenShift Container Platform subscriptions at the account or multi-cluster level.

## Additional resources

- [About remote health monitoring](#)

## 7.4.18. Next steps

- [Validating an installation.](#)
- [Customize your cluster.](#)
- If necessary, you can [opt out of remote health reporting](#) .
- If necessary, you can [remove cloud provider credentials](#).

## 7.5. INSTALLING A CLUSTER ON AZURE STACK HUB USING ARM TEMPLATES

In OpenShift Container Platform version 4.10, you can install a cluster on Microsoft Azure Stack Hub by using infrastructure that you provide.

Several [Azure Resource Manager](#) (ARM) templates are provided to assist in completing these steps or to help model your own.



### IMPORTANT

The steps for performing a user-provisioned infrastructure installation are provided as an example only. Installing a cluster with infrastructure you provide requires knowledge of the cloud provider and the installation process of OpenShift Container Platform. Several ARM templates are provided to assist in completing these steps or to help model your own. You are also free to create the required resources through other methods; the templates are just an example.

### 7.5.1. Prerequisites

- You reviewed details about the [OpenShift Container Platform installation and update](#) processes.
- You read the documentation on [selecting a cluster installation method and preparing it for users](#).
- You [configured an Azure Stack Hub account](#) to host the cluster.
- You downloaded the Azure CLI and installed it on your computer. See [Install the Azure CLI](#) in the Azure documentation. The documentation below was tested using version **2.28.0** of the Azure CLI. Azure CLI commands might perform differently based on the version you use.
- If you use a firewall and plan to use the Telemetry service, you [configured the firewall to allow the sites](#) that your cluster requires access to.

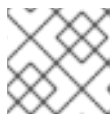

### NOTE

Be sure to also review this site list if you are configuring a proxy.

### 7.5.2. Internet access for OpenShift Container Platform

In OpenShift Container Platform 4.10, you require access to the internet to install your cluster.

You must have internet access to:

- Access [OpenShift Cluster Manager](#) to download the installation program and perform subscription management. If the cluster has internet access and you do not disable Telemetry, that service automatically entitles your cluster.
- Access [Quay.io](#) to obtain the packages that are required to install your cluster.
- Obtain the packages that are required to perform cluster updates.

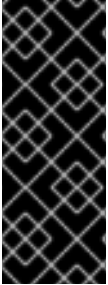

### IMPORTANT

If your cluster cannot have direct internet access, you can perform a restricted network installation on some types of infrastructure that you provision. During that process, you download the required content and use it to populate a mirror registry with the installation packages. With some installation types, the environment that you install your cluster in will not require internet access. Before you update the cluster, you update the content of the mirror registry.

## 7.5.3. Configuring your Azure Stack Hub project

Before you can install OpenShift Container Platform, you must configure an Azure project to host it.



### IMPORTANT

All Azure Stack Hub resources that are available through public endpoints are subject to resource name restrictions, and you cannot create resources that use certain terms. For a list of terms that Azure Stack Hub restricts, see [Resolve reserved resource name errors](#) in the Azure documentation.

### 7.5.3.1. Azure Stack Hub account limits

The OpenShift Container Platform cluster uses a number of Microsoft Azure Stack Hub components, and the default [Quota types in Azure Stack Hub](#) affect your ability to install OpenShift Container Platform clusters.

The following table summarizes the Azure Stack Hub components whose limits can impact your ability to install and run OpenShift Container Platform clusters.

Component	Number of components required by default	Description

Component	Number of components required by default	Description				
vCPU	56	<p>A default cluster requires 56 vCPUs, so you must increase the account limit.</p> <p>By default, each cluster creates the following instances:</p> <ul style="list-style-type: none"> <li>● One bootstrap machine, which is removed after installation</li> <li>● Three control plane machines</li> <li>● Three compute machines</li> </ul> <p>Because the bootstrap, control plane, and worker machines use <b>Standard_DS4_v2</b> virtual machines, which use 8 vCPUs, a default cluster requires 56 vCPUs. The bootstrap node VM is used only during installation.</p> <p>To deploy more worker nodes, enable autoscaling, deploy large workloads, or use a different instance type, you must further increase the vCPU limit for your account to ensure that your cluster can deploy the machines that you require.</p>				
VNet	1	Each default cluster requires one Virtual Network (VNet), which contains two subnets.				
Network interfaces	7	Each default cluster requires seven network interfaces. If you create more machines or your deployed workloads create load balancers, your cluster uses more network interfaces.				
Network security groups	2	<p>Each cluster creates network security groups for each subnet in the VNet. The default cluster creates network security groups for the control plane and for the compute node subnets:</p> <table border="1"> <tbody> <tr> <td><b>control plane</b></td> <td>Allows the control plane machines to be reached on port 6443 from anywhere</td> </tr> <tr> <td><b>node</b></td> <td>Allows worker nodes to be reached from the internet on ports 80 and 443</td> </tr> </tbody> </table>	<b>control plane</b>	Allows the control plane machines to be reached on port 6443 from anywhere	<b>node</b>	Allows worker nodes to be reached from the internet on ports 80 and 443
<b>control plane</b>	Allows the control plane machines to be reached on port 6443 from anywhere					
<b>node</b>	Allows worker nodes to be reached from the internet on ports 80 and 443					

Component	Number of components required by default	Description						
Network load balancers	3	<p>Each cluster creates the following <a href="#">load balancers</a>:</p> <table border="1"> <tr> <td><b>default</b></td> <td>Public IP address that load balances requests to ports 80 and 443 across worker machines</td> </tr> <tr> <td><b>internal</b></td> <td>Private IP address that load balances requests to ports 6443 and 22623 across control plane machines</td> </tr> <tr> <td><b>external</b></td> <td>Public IP address that load balances requests to port 6443 across control plane machines</td> </tr> </table> <p>If your applications create more Kubernetes <b>LoadBalancer</b> service objects, your cluster uses more load balancers.</p>	<b>default</b>	Public IP address that load balances requests to ports 80 and 443 across worker machines	<b>internal</b>	Private IP address that load balances requests to ports 6443 and 22623 across control plane machines	<b>external</b>	Public IP address that load balances requests to port 6443 across control plane machines
<b>default</b>	Public IP address that load balances requests to ports 80 and 443 across worker machines							
<b>internal</b>	Private IP address that load balances requests to ports 6443 and 22623 across control plane machines							
<b>external</b>	Public IP address that load balances requests to port 6443 across control plane machines							
Public IP addresses	2	The public load balancer uses a public IP address. The bootstrap machine also uses a public IP address so that you can SSH into the machine to troubleshoot issues during installation. The IP address for the bootstrap node is used only during installation.						
Private IP addresses	7	The internal load balancer, each of the three control plane machines, and each of the three worker machines each use a private IP address.						

### Additional resources

- [Optimizing storage](#).

#### 7.5.3.2. Configuring a DNS zone in Azure Stack Hub

To successfully install OpenShift Container Platform on Azure Stack Hub, you must create DNS records in an Azure Stack Hub DNS zone. The DNS zone must be authoritative for the domain. To delegate a registrar's DNS zone to Azure Stack Hub, see Microsoft's documentation for [Azure Stack Hub datacenter DNS integration](#).

You can view Azure's DNS solution by visiting this [example for creating DNS zones](#).

#### 7.5.3.3. Certificate signing requests management

Because your cluster has limited access to automatic machine management when you use infrastructure that you provision, you must provide a mechanism for approving cluster certificate signing requests (CSRs) after installation. The **kube-controller-manager** only approves the kubelet client CSRs. The **machine-approver** cannot guarantee the validity of a serving certificate that is requested by using kubelet credentials because it cannot confirm that the correct machine issued the request. You must determine and implement a method of verifying the validity of the kubelet serving certificate requests and approving them.

#### 7.5.3.4. Required Azure Stack Hub roles

Your Microsoft Azure Stack Hub account must have the following roles for the subscription that you use:

- **Owner**

To set roles on the Azure portal, see the [Manage access to resources in Azure Stack Hub with role-based access control](#) in the Microsoft documentation.

### 7.5.3.5. Creating a service principal

Because OpenShift Container Platform and its installation program create Microsoft Azure resources by using the Azure Resource Manager, you must create a service principal to represent it.

#### Prerequisites

- Install or update the [Azure CLI](#).
- Your Azure account has the required roles for the subscription that you use.

#### Procedure

1. Register your environment:

```
$ az cloud register -n AzureStackCloud --endpoint-resource-manager <endpoint> 1
```

- 1** Specify the Azure Resource Manager endpoint, ``https://management.<region>.<fqdn>/``.

See the [Microsoft documentation](#) for details.

2. Set the active environment:

```
$ az cloud set -n AzureStackCloud
```

3. Update your environment configuration to use the specific API version for Azure Stack Hub:

```
$ az cloud update --profile 2019-03-01-hybrid
```

4. Log in to the Azure CLI:

```
$ az login
```

If you are in a multitenant environment, you must also supply the tenant ID.

5. If your Azure account uses subscriptions, ensure that you are using the right subscription:

- a. View the list of available accounts and record the **tenantId** value for the subscription you want to use for your cluster:

```
$ az account list --refresh
```

#### Example output

```
{  
  {
```

```

"cloudName": AzureStackCloud",
"id": "9bab1460-96d5-40b3-a78e-17b15e978a80",
"isDefault": true,
"name": "Subscription Name",
"state": "Enabled",
"tenantId": "6057c7e9-b3ae-489d-a54e-de3f6bf6a8ee",
"user": {
  "name": "you@example.com",
  "type": "user"
}
}
]

```

- b. View your active account details and confirm that the **tenantId** value matches the subscription you want to use:

```
$ az account show
```

### Example output

```

{
  "environmentName": AzureStackCloud",
  "id": "9bab1460-96d5-40b3-a78e-17b15e978a80",
  "isDefault": true,
  "name": "Subscription Name",
  "state": "Enabled",
  "tenantId": "6057c7e9-b3ae-489d-a54e-de3f6bf6a8ee", 1
  "user": {
    "name": "you@example.com",
    "type": "user"
  }
}

```

- 1 Ensure that the value of the **tenantId** parameter is the correct subscription ID.

- c. If you are not using the right subscription, change the active subscription:

```
$ az account set -s <subscription_id> 1
```

- 1 Specify the subscription ID.

- d. Verify the subscription ID update:

```
$ az account show
```

### Example output

```

{
  "environmentName": AzureStackCloud",
  "id": "33212d16-bdf6-45cb-b038-f6565b61edda",
  "isDefault": true,
  "name": "Subscription Name",

```

```

    "state": "Enabled",
    "tenantId": "8049c7e9-c3de-762d-a54e-dc3f6be6a7ee",
    "user": {
      "name": "you@example.com",
      "type": "user"
    }
  }
}

```

- Record the **tenantId** and **id** parameter values from the output. You need these values during the OpenShift Container Platform installation.
- Create the service principal for your account:

```

$ az ad sp create-for-rbac --role Contributor --name <service_principal> \ 1
--scopes /subscriptions/<subscription_id> 2
--years <years> 3

```

- Specify the service principal name.
- Specify the subscription ID.
- Specify the number of years. By default, a service principal expires in one year. By using the **--years** option you can extend the validity of your service principal.

### Example output

```

Creating 'Contributor' role assignment under scope '/subscriptions/<subscription_id>'
The output includes credentials that you must protect. Be sure that you do not
include these credentials in your code or check the credentials into your source
control. For more information, see https://aka.ms/azadsp-cli
{
  "appId": "ac461d78-bf4b-4387-ad16-7e32e328aec6",
  "displayName": <service_principal>,
  "password": "00000000-0000-0000-0000-000000000000",
  "tenantId": "8049c7e9-c3de-762d-a54e-dc3f6be6a7ee"
}

```

- Record the values of the **appId** and **password** parameters from the previous output. You need these values during OpenShift Container Platform installation.

### Additional resources

- For more information about CCO modes, see [About the Cloud Credential Operator](#).

## 7.5.4. Obtaining the installation program

Before you install OpenShift Container Platform, download the installation file on a local computer.

### Prerequisites

- You have a computer that runs Linux or macOS, with 500 MB of local disk space

### Procedure



1. Access the [Infrastructure Provider](#) page on the OpenShift Cluster Manager site. If you have a Red Hat account, log in with your credentials. If you do not, create an account.
2. Select **Azure** as the cloud provider.
3. Navigate to the page for your installation type, download the installation program that corresponds with your host operating system and architecture, and place the file in the directory where you will store the installation configuration files.



### IMPORTANT

The installation program creates several files on the computer that you use to install your cluster. You must keep the installation program and the files that the installation program creates after you finish installing the cluster. Both files are required to delete the cluster.

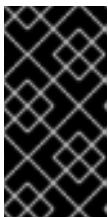

### IMPORTANT

Deleting the files created by the installation program does not remove your cluster, even if the cluster failed during installation. To remove your cluster, complete the OpenShift Container Platform uninstallation procedures for your specific cloud provider.

4. Extract the installation program. For example, on a computer that uses a Linux operating system, run the following command:

```
$ tar -xvf openshift-install-linux.tar.gz
```

5. Download your installation [pull secret from the Red Hat OpenShift Cluster Manager](#) . This pull secret allows you to authenticate with the services that are provided by the included authorities, including Quay.io, which serves the container images for OpenShift Container Platform components.

## 7.5.5. Generating a key pair for cluster node SSH access

During an OpenShift Container Platform installation, you can provide an SSH public key to the installation program. The key is passed to the Red Hat Enterprise Linux CoreOS (RHCOS) nodes through their Ignition config files and is used to authenticate SSH access to the nodes. The key is added to the `~/.ssh/authorized_keys` list for the **core** user on each node, which enables password-less authentication.

After the key is passed to the nodes, you can use the key pair to SSH in to the RHCOS nodes as the user **core**. To access the nodes through SSH, the private key identity must be managed by SSH for your local user.

If you want to SSH in to your cluster nodes to perform installation debugging or disaster recovery, you must provide the SSH public key during the installation process. The `./openshift-install gather` command also requires the SSH public key to be in place on the cluster nodes.

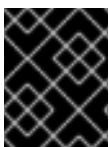

### IMPORTANT

Do not skip this procedure in production environments, where disaster recovery and debugging is required.

**NOTE**

You must use a local key, not one that you configured with platform-specific approaches such as [AWS key pairs](#).

**Procedure**

1. If you do not have an existing SSH key pair on your local machine to use for authentication onto your cluster nodes, create one. For example, on a computer that uses a Linux operating system, run the following command:

```
$ ssh-keygen -t ed25519 -N "" -f <path>/<file_name> 1
```

- 1 Specify the path and file name, such as `~/.ssh/id_ed25519`, of the new SSH key. If you have an existing key pair, ensure your public key is in the your `~/.ssh` directory.

**NOTE**

If you plan to install an OpenShift Container Platform cluster that uses FIPS validated or Modules In Process cryptographic libraries on the **x86\_64** architecture, do not create a key that uses the **ed25519** algorithm. Instead, create a key that uses the **rsa** or **ecdsa** algorithm.

2. View the public SSH key:

```
$ cat <path>/<file_name>.pub
```

For example, run the following to view the `~/.ssh/id_ed25519.pub` public key:

```
$ cat ~/.ssh/id_ed25519.pub
```

3. Add the SSH private key identity to the SSH agent for your local user, if it has not already been added. SSH agent management of the key is required for password-less SSH authentication onto your cluster nodes, or if you want to use the `./openshift-install gather` command.

**NOTE**

On some distributions, default SSH private key identities such as `~/.ssh/id_rsa` and `~/.ssh/id_dsa` are managed automatically.

- a. If the **ssh-agent** process is not already running for your local user, start it as a background task:

```
$ eval "$(ssh-agent -s)"
```

**Example output**

```
Agent pid 31874
```

**NOTE**

If your cluster is in FIPS mode, only use FIPS-compliant algorithms to generate the SSH key. The key must be either RSA or ECDSA.

4. Add your SSH private key to the **ssh-agent**:

```
$ ssh-add <path>/<file_name> 1
```

- 1 Specify the path and file name for your SSH private key, such as `~/.ssh/id_ed25519`

**Example output**

```
Identity added: /home/<you>/<path>/<file_name> (<computer_name>)
```

**Next steps**

- When you install OpenShift Container Platform, provide the SSH public key to the installation program.

**7.5.6. Creating the installation files for Azure Stack Hub**

To install OpenShift Container Platform on Microsoft Azure Stack Hub using user-provisioned infrastructure, you must generate the files that the installation program needs to deploy your cluster and modify them so that the cluster creates only the machines that it will use. You manually create the **install-config.yaml** file, and then generate and customize the Kubernetes manifests and Ignition config files. You also have the option to first set up a separate **var** partition during the preparation phases of installation.

**7.5.6.1. Manually creating the installation configuration file****Prerequisites**

- You have an SSH public key on your local machine to provide to the installation program. The key will be used for SSH authentication onto your cluster nodes for debugging and disaster recovery.
- You have obtained the OpenShift Container Platform installation program and the pull secret for your cluster.

**Procedure**

1. Create an installation directory to store your required installation assets in:

```
$ mkdir <installation_directory>
```



## IMPORTANT

You must create a directory. Some installation assets, like bootstrap X.509 certificates have short expiration intervals, so you must not reuse an installation directory. If you want to reuse individual files from another cluster installation, you can copy them into your directory. However, the file names for the installation assets might change between releases. Use caution when copying installation files from an earlier OpenShift Container Platform version.

2. Customize the sample **install-config.yaml** file template that is provided and save it in the **<installation\_directory>**.



## NOTE

You must name this configuration file **install-config.yaml**.

Make the following modifications for Azure Stack Hub:

- a. Set the **replicas** parameter to **0** for the **compute** pool:

```
compute:
- hyperthreading: Enabled
  name: worker
  platform: {}
  replicas: 0 1
```

- 1** Set to **0**.

The compute machines will be provisioned manually later.

- b. Update the **platform.azure** section of the **install-config.yaml** file to configure your Azure Stack Hub configuration:

```
platform:
  azure:
    armEndpoint: <azurestack_arm_endpoint> 1
    baseDomainResourceGroupName: <resource_group> 2
    cloudName: AzureStackCloud 3
    region: <azurestack_region> 4
```

- 1** Specify the Azure Resource Manager endpoint of your Azure Stack Hub environment, like **https://management.local.azurestack.external**.
- 2** Specify the name of the resource group that contains the DNS zone for your base domain.
- 3** Specify the Azure Stack Hub environment, which is used to configure the Azure SDK with the appropriate Azure API endpoints.
- 4** Specify the name of your Azure Stack Hub region.

3. Back up the **install-config.yaml** file so that you can use it to install multiple clusters.

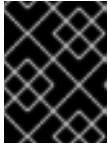
**IMPORTANT**

The **install-config.yaml** file is consumed during the next step of the installation process. You must back it up now.

**7.5.6.2. Sample customized install-config.yaml file for Azure Stack Hub**

You can customize the **install-config.yaml** file to specify more details about your OpenShift Container Platform cluster's platform or modify the values of the required parameters.

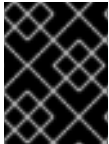
**IMPORTANT**

This sample YAML file is provided for reference only. Use it as a resource to enter parameter values into the installation configuration file that you created manually.

```

apiVersion: v1
baseDomain: example.com
controlPlane: 1
  name: master
  platform:
    azure:
      osDisk:
        diskSizeGB: 1024 2
        diskType: premium_LRS
      replicas: 3
compute: 3
  - name: worker
    platform:
      azure:
        osDisk:
          diskSizeGB: 512 4
          diskType: premium_LRS
        replicas: 0
metadata:
  name: test-cluster 5
networking:
  clusterNetwork:
    - cidr: 10.128.0.0/14
      hostPrefix: 23
  machineNetwork:
    - cidr: 10.0.0.0/16
  networkType: OpenShiftSDN
  serviceNetwork:
    - 172.30.0.0/16
platform:
  azure:
    armEndpoint: azurestack_arm_endpoint 6
    baseDomainResourceGroupName: resource_group 7
    region: azure_stack_local_region 8
    resourceGroupName: existing_resource_group 9
    outboundType: Loadbalancer
    cloudName: AzureStackCloud 10
pullSecret: '{"auths": ...}' 11

```

```
fips: false 12
additionalTrustBundle: | 13
  -----BEGIN CERTIFICATE-----
  <MY_TRUSTED_CA_CERT>
  -----END CERTIFICATE-----
sshKey: ssh-ed25519 AAAA... 14
```

- 1 3** The **controlPlane** section is a single mapping, but the **compute** section is a sequence of mappings. To meet the requirements of the different data structures, the first line of the **compute** section must begin with a hyphen, -, and the first line of the **controlPlane** section must not. Only one control plane pool is used.
- 2 4** You can specify the size of the disk to use in GB. Minimum recommendation for control plane nodes is 1024 GB.
- 5** Specify the name of the cluster.
- 6** Specify the Azure Resource Manager endpoint that your Azure Stack Hub operator provides.
- 7** Specify the name of the resource group that contains the DNS zone for your base domain.
- 8** Specify the name of your Azure Stack Hub local region.
- 9** Specify the name of an already existing resource group to install your cluster to. If undefined, a new resource group is created for the cluster.
- 10** Specify the Azure Stack Hub environment as your target platform.
- 11** Specify the pull secret required to authenticate your cluster.
- 12** Whether to enable or disable FIPS mode. By default, FIPS mode is not enabled. If FIPS mode is enabled, the Red Hat Enterprise Linux CoreOS (RHCOS) machines that OpenShift Container Platform runs on bypass the default Kubernetes cryptography suite and use the cryptography modules that are provided with RHCOS instead.



### IMPORTANT

To enable FIPS mode for your cluster, you must run the installation program from a Red Hat Enterprise Linux (RHEL) computer configured to operate in FIPS mode. For more information about configuring FIPS mode on RHEL, see [Installing the system in FIPS mode](#). The use of FIPS validated or Modules In Progress cryptographic libraries is only supported on OpenShift Container Platform deployments on the **x86\_64** architecture.

- 13** If your Azure Stack Hub environment uses an internal certificate authority (CA), add the necessary certificate bundle in **.pem** format.
- 14** You can optionally provide the **sshKey** value that you use to access the machines in your cluster.



### NOTE

For production OpenShift Container Platform clusters on which you want to perform installation debugging or disaster recovery, specify an SSH key that your **ssh-agent** process uses.

### 7.5.6.3. Configuring the cluster-wide proxy during installation

Production environments can deny direct access to the internet and instead have an HTTP or HTTPS proxy available. You can configure a new OpenShift Container Platform cluster to use a proxy by configuring the proxy settings in the **install-config.yaml** file.

#### Prerequisites

- You have an existing **install-config.yaml** file.
- You reviewed the sites that your cluster requires access to and determined whether any of them need to bypass the proxy. By default, all cluster egress traffic is proxied, including calls to hosting cloud provider APIs. You added sites to the **Proxy** object's **spec.noProxy** field to bypass the proxy if necessary.



#### NOTE

The **Proxy** object **status.noProxy** field is populated with the values of the **networking.machineNetwork[].cidr**, **networking.clusterNetwork[].cidr**, and **networking.serviceNetwork[]** fields from your installation configuration.

For installations on Amazon Web Services (AWS), Google Cloud Platform (GCP), Microsoft Azure, and Red Hat OpenStack Platform (RHOSP), the **Proxy** object **status.noProxy** field is also populated with the instance metadata endpoint (**169.254.169.254**).

#### Procedure

1. Edit your **install-config.yaml** file and add the proxy settings. For example:

```
apiVersion: v1
baseDomain: my.domain.com
proxy:
  httpProxy: http://<username>:<pswd>@<ip>:<port> 1
  httpsProxy: https://<username>:<pswd>@<ip>:<port> 2
  noProxy: example.com 3
  additionalTrustBundle: | 4
    -----BEGIN CERTIFICATE-----
    <MY_TRUSTED_CA_CERT>
    -----END CERTIFICATE-----
...

```

- 1 A proxy URL to use for creating HTTP connections outside the cluster. The URL scheme must be **http**.
- 2 A proxy URL to use for creating HTTPS connections outside the cluster.
- 3 A comma-separated list of destination domain names, IP addresses, or other network CIDRs to exclude from proxying. Preface a domain with **.** to match subdomains only. For example, **.y.com** matches **x.y.com**, but not **y.com**. Use **\*** to bypass the proxy for all destinations.
- 4 If provided, the installation program generates a config map that is named **user-ca-bundle** in the **openshift-config** namespace that contains one or more additional CA certificates that are required for proxying HTTPS connections. The Cluster Network Operator then

creates a **trusted-ca-bundle** config map that merges these contents with the Red Hat Enterprise Linux CoreOS (RHCOS) trust bundle, and this config map is referenced in the **trustedCA** field of the **Proxy** object. The **additionalTrustBundle** field is required unless the proxy's identity certificate is signed by an authority from the RHCOS trust bundle.

**NOTE**

The installation program does not support the proxy **readinessEndpoints** field.

**NOTE**

If the installer times out, restart and then complete the deployment by using the **wait-for** command of the installer. For example:

```
$ ./openshift-install wait-for install-complete --log-level debug
```

2. Save the file and reference it when installing OpenShift Container Platform.

The installation program creates a cluster-wide proxy that is named **cluster** that uses the proxy settings in the provided **install-config.yaml** file. If no proxy settings are provided, a **cluster Proxy** object is still created, but it will have a nil **spec**.

**NOTE**

Only the **Proxy** object named **cluster** is supported, and no additional proxies can be created.

#### 7.5.6.4. Exporting common variables for ARM templates

You must export a common set of variables that are used with the provided Azure Resource Manager (ARM) templates used to assist in completing a user-provided infrastructure install on Microsoft Azure Stack Hub.

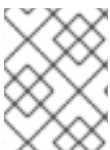
**NOTE**

Specific ARM templates can also require additional exported variables, which are detailed in their related procedures.

#### Prerequisites

- Obtain the OpenShift Container Platform installation program and the pull secret for your cluster.

#### Procedure

1. Export common variables found in the **install-config.yaml** to be used by the provided ARM templates:

```
$ export CLUSTER_NAME=<cluster_name> 1
$ export AZURE_REGION=<azure_region> 2
$ export SSH_KEY=<ssh_key> 3
```



```
$ export BASE_DOMAIN=<base_domain> 4
$ export BASE_DOMAIN_RESOURCE_GROUP=<base_domain_resource_group> 5
```

- 1 The value of the **.metadata.name** attribute from the **install-config.yaml** file.
- 2 The region to deploy the cluster into. This is the value of the **.platform.azure.region** attribute from the **install-config.yaml** file.
- 3 The SSH RSA public key file as a string. You must enclose the SSH key in quotes since it contains spaces. This is the value of the **.sshKey** attribute from the **install-config.yaml** file.
- 4 The base domain to deploy the cluster to. The base domain corresponds to the DNS zone that you created for your cluster. This is the value of the **.baseDomain** attribute from the **install-config.yaml** file.
- 5 The resource group where the DNS zone exists. This is the value of the **.platform.azure.baseDomainResourceGroupName** attribute from the **install-config.yaml** file.

For example:

```
$ export CLUSTER_NAME=test-cluster
$ export AZURE_REGION=centralus
$ export SSH_KEY="ssh-rsa xxx/xxx/xxx= user@email.com"
$ export BASE_DOMAIN=example.com
$ export BASE_DOMAIN_RESOURCE_GROUP=ocp-cluster
```

2. Export the kubeadmin credentials:

```
$ export KUBECONFIG=<installation_directory>/auth/kubeconfig 1
```

- 1 For **<installation\_directory>**, specify the path to the directory that you stored the installation files in.

#### 7.5.6.5. Creating the Kubernetes manifest and Ignition config files

Because you must modify some cluster definition files and manually start the cluster machines, you must generate the Kubernetes manifest and Ignition config files that the cluster needs to configure the machines.

The installation configuration file transforms into the Kubernetes manifests. The manifests wrap into the Ignition configuration files, which are later used to configure the cluster machines.



## IMPORTANT

- The Ignition config files that the OpenShift Container Platform installation program generates contain certificates that expire after 24 hours, which are then renewed at that time. If the cluster is shut down before renewing the certificates and the cluster is later restarted after the 24 hours have elapsed, the cluster automatically recovers the expired certificates. The exception is that you must manually approve the pending **node-bootstrapper** certificate signing requests (CSRs) to recover kubelet certificates. See the documentation for *Recovering from expired control plane certificates* for more information.
- It is recommended that you use Ignition config files within 12 hours after they are generated because the 24-hour certificate rotates from 16 to 22 hours after the cluster is installed. By using the Ignition config files within 12 hours, you can avoid installation failure if the certificate update runs during installation.

## Prerequisites

- You obtained the OpenShift Container Platform installation program.
- You created the **install-config.yaml** installation configuration file.

## Procedure

1. Change to the directory that contains the OpenShift Container Platform installation program and generate the Kubernetes manifests for the cluster:

```
$ ./openshift-install create manifests --dir <installation_directory> 1
```

- 1** For **<installation\_directory>**, specify the installation directory that contains the **install-config.yaml** file you created.

2. Remove the Kubernetes manifest files that define the control plane machines:

```
$ rm -f <installation_directory>/openshift/99_openshift-cluster-api_master-machines-*.yaml
```

By removing these files, you prevent the cluster from automatically generating control plane machines.

3. Remove the Kubernetes manifest files that define the worker machines:

```
$ rm -f <installation_directory>/openshift/99_openshift-cluster-api_worker-machineset-*.yaml
```

Because you create and manage the worker machines yourself, you do not need to initialize these machines.

4. Check that the **mastersSchedulable** parameter in the **<installation\_directory>/manifests/cluster-scheduler-02-config.yaml** Kubernetes manifest file is set to **false**. This setting prevents pods from being scheduled on the control plane machines:

- a. Open the **<installation\_directory>/manifests/cluster-scheduler-02-config.yaml** file.
- b. Locate the **mastersSchedulable** parameter and ensure that it is set to **false**.

- c. Save and exit the file.
5. Optional: If you do not want [the Ingress Operator](#) to create DNS records on your behalf, remove the **privateZone** and **publicZone** sections from the `<installation_directory>/manifests/cluster-dns-02-config.yml` DNS configuration file:

```

apiVersion: config.openshift.io/v1
kind: DNS
metadata:
  creationTimestamp: null
  name: cluster
spec:
  baseDomain: example.openshift.com
  privateZone: ❶
    id: mycluster-100419-private-zone
  publicZone: ❷
    id: example.openshift.com
status: {}

```

- ❶ ❷ Remove this section completely.

If you do so, you must add ingress DNS records manually in a later step.

6. Optional: If your Azure Stack Hub environment uses an internal certificate authority (CA), you must update the **.spec.trustedCA.name** field in the `<installation_directory>/manifests/cluster-proxy-01-config.yaml` file to use **user-ca-bundle**:

```

...
spec:
  trustedCA:
    name: user-ca-bundle
...

```

Later, you must update your bootstrap ignition to include the CA.

7. When configuring Azure on user-provisioned infrastructure, you must export some common variables defined in the manifest files to use later in the Azure Resource Manager (ARM) templates:

- a. Export the infrastructure ID by using the following command:

```
$ export INFRA_ID=<infra_id> ❶
```

- ❶ The OpenShift Container Platform cluster has been assigned an identifier (**INFRA\_ID**) in the form of `<cluster_name>-<random_string>`. This will be used as the base name for most resources created using the provided ARM templates. This is the value of the **.status.infrastructureName** attribute from the `manifests/cluster-infrastructure-02-config.yml` file.

- b. Export the resource group by using the following command:

```
$ export RESOURCE_GROUP=<resource_group> ❶
```

- 1 All resources created in this Azure deployment exists as part of a [resource group](#). The resource group name is also based on the **INFRA\_ID**, in the form of **<cluster\_name>-**

## 8. Manually create your cloud credentials.

- a. From the directory that contains the installation program, obtain details of the OpenShift Container Platform release image that your **openshift-install** binary is built to use:

```
$ openshift-install version
```

### Example output

```
release image quay.io/openshift-release-dev/ocp-release:4.y.z-x86_64
```

- b. Locate all **CredentialsRequest** objects in this release image that target the cloud you are deploying on:

```
$ oc adm release extract quay.io/openshift-release-dev/ocp-release:4.y.z-x86_64 --
credentials-requests --cloud=azure
```

This command creates a YAML file for each **CredentialsRequest** object.

### Sample **CredentialsRequest** object

```
apiVersion: cloudcredential.openshift.io/v1
kind: CredentialsRequest
metadata:
  labels:
    controller-tools.k8s.io: "1.0"
    name: openshift-image-registry-azure
    namespace: openshift-cloud-credential-operator
spec:
  secretRef:
    name: installer-cloud-credentials
    namespace: openshift-image-registry
  providerSpec:
    apiVersion: cloudcredential.openshift.io/v1
    kind: AzureProviderSpec
    roleBindings:
      - role: Contributor
```

- c. Create YAML files for secrets in the **openshift-install** manifests directory that you generated previously. The secrets must be stored using the namespace and secret name defined in the **spec.secretRef** for each **CredentialsRequest** object. The format for the secret data varies for each cloud provider.

### Sample **secrets.yaml** file:

```
apiVersion: v1
kind: Secret
metadata:
  name: ${secret_name}
  namespace: ${secret_namespace}
```

```
stringData:
  azure_subscription_id: ${subscription_id}
  azure_client_id: ${app_id}
  azure_client_secret: ${client_secret}
  azure_tenant_id: ${tenant_id}
  azure_resource_prefix: ${cluster_name}
  azure_resourcegroup: ${resource_group}
  azure_region: ${azure_region}
```

## IMPORTANT

The release image includes **CredentialsRequest** objects for Technology Preview features that are enabled by the **TechPreviewNoUpgrade** feature set. You can identify these objects by their use of the **release.openshift.io/feature-gate:**

**TechPreviewNoUpgrade** annotation.

- If you are not using any of these features, do not create secrets for these objects. Creating secrets for Technology Preview features that you are not using can cause the installation to fail.
- If you are using any of these features, you must create secrets for the corresponding objects.

- To find **CredentialsRequest** objects with the **TechPreviewNoUpgrade** annotation, run the following command:

```
$ grep "release.openshift.io/feature-gate" *
```

### Example output

```
0000_30_capi-operator_00_credentials-request.yaml: release.openshift.io/feature-gate:
TechPreviewNoUpgrade
```

- a. Create a **cco-configmap.yaml** file in the manifests directory with the Cloud Credential Operator (CCO) disabled:

### Sample ConfigMap object

```
apiVersion: v1
kind: ConfigMap
metadata:
  name: cloud-credential-operator-config
  namespace: openshift-cloud-credential-operator
  annotations:
    release.openshift.io/create-only: "true"
data:
  disabled: "true"
```

1. To create the Ignition configuration files, run the following command from the directory that contains the installation program:

```
$ ./openshift-install create ignition-configs --dir <installation_directory> 1
```

- 1 For `<installation_directory>`, specify the same installation directory.

Ignition config files are created for the bootstrap, control plane, and compute nodes in the installation directory. The **kubeadmin-password** and **kubeconfig** files are created in the `./<installation_directory>/auth` directory:

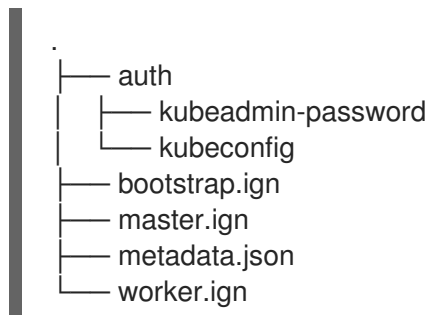

### 7.5.6.6. Optional: Creating a separate `/var` partition

It is recommended that disk partitioning for OpenShift Container Platform be left to the installer. However, there are cases where you might want to create separate partitions in a part of the filesystem that you expect to grow.

OpenShift Container Platform supports the addition of a single partition to attach storage to either the `/var` partition or a subdirectory of `/var`. For example:

- **`/var/lib/containers`**: Holds container-related content that can grow as more images and containers are added to a system.
- **`/var/lib/etcd`**: Holds data that you might want to keep separate for purposes such as performance optimization of etcd storage.
- **`/var`**: Holds data that you might want to keep separate for purposes such as auditing.

Storing the contents of a `/var` directory separately makes it easier to grow storage for those areas as needed and reinstall OpenShift Container Platform at a later date and keep that data intact. With this method, you will not have to pull all your containers again, nor will you have to copy massive log files when you update systems.

Because `/var` must be in place before a fresh installation of Red Hat Enterprise Linux CoreOS (RHCOS), the following procedure sets up the separate `/var` partition by creating a machine config manifest that is inserted during the **openshift-install** preparation phases of an OpenShift Container Platform installation.

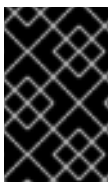

#### IMPORTANT

If you follow the steps to create a separate `/var` partition in this procedure, it is not necessary to create the Kubernetes manifest and Ignition config files again as described later in this section.

#### Procedure

1. Create a directory to hold the OpenShift Container Platform installation files:

```
$ mkdir $HOME/clusterconfig
```

- Run **openshift-install** to create a set of files in the **manifest** and **openshift** subdirectories. Answer the system questions as you are prompted:

```
$ openshift-install create manifests --dir $HOME/clusterconfig
```

### Example output

```
? SSH Public Key ...
INFO Credentials loaded from the "myprofile" profile in file "/home/myuser/.aws/credentials"
INFO Consuming Install Config from target directory
INFO Manifests created in: $HOME/clusterconfig/manifests and
$HOME/clusterconfig/openshift
```

- Optional: Confirm that the installation program created manifests in the **clusterconfig/openshift** directory:

```
$ ls $HOME/clusterconfig/openshift/
```

### Example output

```
99_kubeadmin-password-secret.yaml
99_openshift-cluster-api_master-machines-0.yaml
99_openshift-cluster-api_master-machines-1.yaml
99_openshift-cluster-api_master-machines-2.yaml
...
```

- Create a Butane config that configures the additional partition. For example, name the file **\$HOME/clusterconfig/98-var-partition.bu**, change the disk device name to the name of the storage device on the **worker** systems, and set the storage size as appropriate. This example places the **/var** directory on a separate partition:

```
variant: openshift
version: 4.10.0
metadata:
  labels:
    machineconfiguration.openshift.io/role: worker
  name: 98-var-partition
storage:
  disks:
    - device: /dev/<device_name> 1
  partitions:
    - label: var
      start_mib: <partition_start_offset> 2
      size_mib: <partition_size> 3
  filesystems:
    - device: /dev/disk/by-partlabel/var
      path: /var
      format: xfs
      mount_options: [defaults, prjquota] 4
      with_mount_unit: true
```

- The storage device name of the disk that you want to partition.

- 2 When adding a data partition to the boot disk, a minimum value of 25000 MiB (Mebibytes) is recommended. The root file system is automatically resized to fill all available space up
- 3 The size of the data partition in mebibytes.
- 4 The **prjquota** mount option must be enabled for filesystems used for container storage.

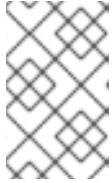

#### NOTE

When creating a separate **/var** partition, you cannot use different instance types for worker nodes, if the different instance types do not have the same device name.

5. Create a manifest from the Butane config and save it to the **clusterconfig/openshift** directory. For example, run the following command:

```
$ butane $HOME/clusterconfig/98-var-partition.bu -o $HOME/clusterconfig/openshift/98-var-partition.yaml
```

6. Run **openshift-install** again to create Ignition configs from a set of files in the **manifest** and **openshift** subdirectories:

```
$ openshift-install create ignition-configs --dir $HOME/clusterconfig
$ ls $HOME/clusterconfig/
auth bootstrap.ign master.ign metadata.json worker.ign
```

Now you can use the Ignition config files as input to the installation procedures to install Red Hat Enterprise Linux CoreOS (RHCOS) systems.

### 7.5.7. Creating the Azure resource group

You must create a Microsoft Azure [resource group](#). This is used during the installation of your OpenShift Container Platform cluster on Azure Stack Hub.

#### Prerequisites

- Configure an Azure account.
- Generate the Ignition config files for your cluster.

#### Procedure

- Create the resource group in a supported Azure region:

```
$ az group create --name ${RESOURCE_GROUP} --location ${AZURE_REGION}
```

### 7.5.8. Uploading the RHCOS cluster image and bootstrap Ignition config file

The Azure client does not support deployments based on files existing locally. You must copy and store the RHCOS virtual hard disk (VHD) cluster image and bootstrap Ignition config file in a storage container so they are accessible during deployment.



## Prerequisites

- Configure an Azure account.
- Generate the Ignition config files for your cluster.

## Procedure

1. Create an Azure storage account to store the VHD cluster image:

```
$ az storage account create -g ${RESOURCE_GROUP} --location ${AZURE_REGION} --name ${CLUSTER_NAME}sa --kind Storage --sku Standard_LRS
```



### WARNING

The Azure storage account name must be between 3 and 24 characters in length and use numbers and lower-case letters only. If your **CLUSTER\_NAME** variable does not follow these restrictions, you must manually define the Azure storage account name. For more information on Azure storage account name restrictions, see [Resolve errors for storage account names](#) in the Azure documentation.

2. Export the storage account key as an environment variable:

```
$ export ACCOUNT_KEY=`az storage account keys list -g ${RESOURCE_GROUP} --account-name ${CLUSTER_NAME}sa --query "[0].value" -o tsv`
```

3. Export the URL of the RHCOS VHD to an environment variable:

```
$ export COMPRESSED_VHD_URL=$(openshift-install coreos print-stream-json | jq -r '.architectures.x86_64.artifacts.azurestack.formats."vhd.gz".disk.location')
```

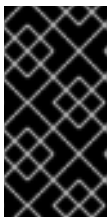

### IMPORTANT

The RHCOS images might not change with every release of OpenShift Container Platform. You must specify an image with the highest version that is less than or equal to the OpenShift Container Platform version that you install. Use the image version that matches your OpenShift Container Platform version if it is available.

4. Create the storage container for the VHD:

```
$ az storage container create --name vhd --account-name ${CLUSTER_NAME}sa --account-key ${ACCOUNT_KEY}
```

5. Download the compressed RHCOS VHD file locally:

```
$ curl -O -L ${COMPRESSED_VHD_URL}
```

- Decompress the VHD file.



#### NOTE

The decompressed VHD file is approximately 16 GB, so be sure that your host system has 16 GB of free space available. You can delete the VHD file after you upload it.

- Copy the local VHD to a blob:

```
$ az storage blob upload --account-name ${CLUSTER_NAME}sa --account-key
${ACCOUNT_KEY} -c vhd -n "rhcos.vhd" -f rhcos-<rhcos_version>-azurestack.x86_64.vhd
```

- Create a blob storage container and upload the generated **bootstrap.ign** file:

```
$ az storage container create --name files --account-name ${CLUSTER_NAME}sa --
account-key ${ACCOUNT_KEY}
```

```
$ az storage blob upload --account-name ${CLUSTER_NAME}sa --account-key
${ACCOUNT_KEY} -c "files" -f "<installation_directory>/bootstrap.ign" -n "bootstrap.ign"
```

### 7.5.9. Example for creating DNS zones

DNS records are required for clusters that use user-provisioned infrastructure. You should choose the DNS strategy that fits your scenario.

For this example, [Azure Stack Hub's datacenter DNS integration](#) is used, so you will create a DNS zone.



#### NOTE

The DNS zone is not required to exist in the same resource group as the cluster deployment and might already exist in your organization for the desired base domain. If that is the case, you can skip creating the DNS zone; be sure the installation config you generated earlier reflects that scenario.

#### Prerequisites

- Configure an Azure account.
- Generate the Ignition config files for your cluster.

#### Procedure

- Create the new DNS zone in the resource group exported in the **BASE\_DOMAIN\_RESOURCE\_GROUP** environment variable:

```
$ az network dns zone create -g ${BASE_DOMAIN_RESOURCE_GROUP} -n
${CLUSTER_NAME}.${BASE_DOMAIN}
```

You can skip this step if you are using a DNS zone that already exists.

You can learn more about [configuring a DNS zone in Azure Stack Hub](#) by visiting that section.

## 7.5.10. Creating a VNet in Azure Stack Hub

You must create a virtual network (VNet) in Microsoft Azure Stack Hub for your OpenShift Container Platform cluster to use. You can customize the VNet to meet your requirements. One way to create the VNet is to modify the provided Azure Resource Manager (ARM) template.



### NOTE

If you do not use the provided ARM template to create your Azure Stack Hub infrastructure, you must review the provided information and manually create the infrastructure. If your cluster does not initialize correctly, you might have to contact Red Hat support with your installation logs.

### Prerequisites

- Configure an Azure account.
- Generate the Ignition config files for your cluster.

### Procedure

1. Copy the template from the **ARM template for the VNet** section of this topic and save it as **01\_vnet.json** in your cluster's installation directory. This template describes the VNet that your cluster requires.
2. Create the deployment by using the **az** CLI:

```
$ az deployment group create -g ${RESOURCE_GROUP} \
  --template-file "<installation_directory>/01_vnet.json" \
  --parameters baseName="${INFRA_ID}" 1
```

- 1** The base name to be used in resource names; this is usually the cluster's infrastructure ID.

### 7.5.10.1. ARM template for the VNet

You can use the following Azure Resource Manager (ARM) template to deploy the VNet that you need for your OpenShift Container Platform cluster:

#### Example 7.1. 01\_vnet.json ARM template

```
link:https://raw.githubusercontent.com/openshift/installer/release-4.10/upi/azurestack/01_vnet.json[]
```

## 7.5.11. Deploying the RHCOS cluster image for the Azure Stack Hub infrastructure

You must use a valid Red Hat Enterprise Linux CoreOS (RHCOS) image for Microsoft Azure Stack Hub for your OpenShift Container Platform nodes.

### Prerequisites

- Configure an Azure account.

- Generate the Ignition config files for your cluster.
- Store the RHCOS virtual hard disk (VHD) cluster image in an Azure storage container.
- Store the bootstrap Ignition config file in an Azure storage container.

## Procedure

1. Copy the template from the **ARM template for image storage** section of this topic and save it as **02\_storage.json** in your cluster's installation directory. This template describes the image storage that your cluster requires.
2. Export the RHCOS VHD blob URL as a variable:

```
$ export VHD_BLOB_URL=`az storage blob url --account-name ${CLUSTER_NAME}sa --
account-key ${ACCOUNT_KEY} -c vhd -n "rhcos.vhd" -o tsv`
```

3. Deploy the cluster image:

```
$ az deployment group create -g ${RESOURCE_GROUP} \
--template-file "<installation_directory>/02_storage.json" \
--parameters vhdBlobURL="${VHD_BLOB_URL}" \ 1
--parameters baseName="${INFRA_ID}" 2
```

**1** The blob URL of the RHCOS VHD to be used to create master and worker machines.

**2** The base name to be used in resource names; this is usually the cluster's infrastructure ID.

### 7.5.11.1. ARM template for image storage

You can use the following Azure Resource Manager (ARM) template to deploy the stored Red Hat Enterprise Linux CoreOS (RHCOS) image that you need for your OpenShift Container Platform cluster:

#### Example 7.2. 02\_storage.json ARM template

```
link:https://raw.githubusercontent.com/openshift/installer/release-
4.10/upi/azurestack/02_storage.json[]
```

### 7.5.12. Networking requirements for user-provisioned infrastructure

All the Red Hat Enterprise Linux CoreOS (RHCOS) machines require networking to be configured in **initramfs** during boot to fetch their Ignition config files.

#### 7.5.12.1. Network connectivity requirements

You must configure the network connectivity between machines to allow OpenShift Container Platform cluster components to communicate. Each machine must be able to resolve the hostnames of all other machines in the cluster.

This section provides details about the ports that are required.

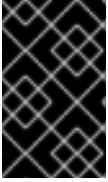

## IMPORTANT

In connected OpenShift Container Platform environments, all nodes are required to have internet access to pull images for platform containers and provide telemetry data to Red Hat.

**Table 7.16. Ports used for all-machine to all-machine communications**

Protocol	Port	Description
ICMP	N/A	Network reachability tests
TCP	<b>1936</b>	Metrics
	<b>9000-9999</b>	Host level services, including the node exporter on ports <b>9100-9101</b> and the Cluster Version Operator on port <b>9099</b> .
	<b>10250-10259</b>	The default ports that Kubernetes reserves
	<b>10256</b>	openshift-sdn
UDP	<b>4789</b>	VXLAN
	<b>6081</b>	Geneve
	<b>9000-9999</b>	Host level services, including the node exporter on ports <b>9100-9101</b> .
	<b>500</b>	IPsec IKE packets
	<b>4500</b>	IPsec NAT-T packets
TCP/UDP	<b>30000-32767</b>	Kubernetes node port
ESP	N/A	IPsec Encapsulating Security Payload (ESP)

**Table 7.17. Ports used for all-machine to control plane communications**

Protocol	Port	Description
TCP	<b>6443</b>	Kubernetes API

**Table 7.18. Ports used for control plane machine to control plane machine communications**

Protocol	Port	Description
TCP	<b>2379-2380</b>	etcd server and peer ports

### 7.5.13. Creating networking and load balancing components in Azure Stack Hub

You must configure networking and load balancing in Microsoft Azure Stack Hub for your OpenShift Container Platform cluster to use. One way to create these components is to modify the provided Azure Resource Manager (ARM) template.

Load balancing requires the following DNS records:

- An **api** DNS record for the API public load balancer in the DNS zone.
- An **api-int** DNS record for the API internal load balancer in the DNS zone.



#### NOTE

If you do not use the provided ARM template to create your Azure Stack Hub infrastructure, you must review the provided information and manually create the infrastructure. If your cluster does not initialize correctly, you might have to contact Red Hat support with your installation logs.

#### Prerequisites

- Configure an Azure account.
- Generate the Ignition config files for your cluster.
- Create and configure a VNet and associated subnets in Azure Stack Hub.

#### Procedure

1. Copy the template from the **ARM template for the network and load balancers** section of this topic and save it as **03\_infra.json** in your cluster's installation directory. This template describes the networking and load balancing objects that your cluster requires.
2. Create the deployment by using the **az** CLI:

```
$ az deployment group create -g ${RESOURCE_GROUP} \
  --template-file "<installation_directory>/03_infra.json" \
  --parameters baseName="${INFRA_ID}" 1
```

- 1** The base name to be used in resource names; this is usually the cluster's infrastructure ID.

3. Create an **api** DNS record and an **api-int** DNS record. When creating the API DNS records, the **\${BASE\_DOMAIN\_RESOURCE\_GROUP}** variable must point to the resource group where the DNS zone exists.

- a. Export the following variable:

```
$ export PUBLIC_IP=`az network public-ip list -g ${RESOURCE_GROUP} --query "[?name=='${INFRA_ID}-master-pip'] | [0].ipAddress" -o tsv`
```

- b. Export the following variable:

```
$ export PRIVATE_IP=`az network lb frontend-ip show -g "$RESOURCE_GROUP" --lb-name "${INFRA_ID}-internal" -n internal-lb-ip --query "privateIpAddress" -o tsv`
```

c. Create the **api** DNS record in a new DNS zone:

```
$ az network dns record-set a add-record -g ${BASE_DOMAIN_RESOURCE_GROUP} -
z ${CLUSTER_NAME}.${BASE_DOMAIN} -n api -a ${PUBLIC_IP} --ttl 60
```

If you are adding the cluster to an existing DNS zone, you can create the **api** DNS record in it instead:

```
$ az network dns record-set a add-record -g ${BASE_DOMAIN_RESOURCE_GROUP} -
z ${BASE_DOMAIN} -n api.${CLUSTER_NAME} -a ${PUBLIC_IP} --ttl 60
```

d. Create the **api-int** DNS record in a new DNS zone:

```
$ az network dns record-set a add-record -g ${BASE_DOMAIN_RESOURCE_GROUP} -
z "${CLUSTER_NAME}.${BASE_DOMAIN}" -n api-int -a ${PRIVATE_IP} --ttl 60
```

If you are adding the cluster to an existing DNS zone, you can create the **api-int** DNS record in it instead:

```
$ az network dns record-set a add-record -g ${BASE_DOMAIN_RESOURCE_GROUP} -
z ${BASE_DOMAIN} -n api-int.${CLUSTER_NAME} -a ${PRIVATE_IP} --ttl 60
```

### 7.5.13.1. ARM template for the network and load balancers

You can use the following Azure Resource Manager (ARM) template to deploy the networking objects and load balancers that you need for your OpenShift Container Platform cluster:

#### Example 7.3. 03\_infra.json ARM template

link:[https://raw.githubusercontent.com/openshift/installer/release-4.10/upi/azurestack/03\\_infra.json](https://raw.githubusercontent.com/openshift/installer/release-4.10/upi/azurestack/03_infra.json)

### 7.5.14. Creating the bootstrap machine in Azure Stack Hub

You must create the bootstrap machine in Microsoft Azure Stack Hub to use during OpenShift Container Platform cluster initialization. One way to create this machine is to modify the provided Azure Resource Manager (ARM) template.



#### NOTE

If you do not use the provided ARM template to create your bootstrap machine, you must review the provided information and manually create the infrastructure. If your cluster does not initialize correctly, you might have to contact Red Hat support with your installation logs.

#### Prerequisites

- Configure an Azure account.
- Generate the Ignition config files for your cluster.

- Create and configure a VNet and associated subnets in Azure Stack Hub.
- Create and configure networking and load balancers in Azure Stack Hub.
- Create control plane and compute roles.

## Procedure

1. Copy the template from the **ARM template for the bootstrap machine** section of this topic and save it as **04\_bootstrap.json** in your cluster's installation directory. This template describes the bootstrap machine that your cluster requires.

2. Export the bootstrap URL variable:

```
$ bootstrap_url_expiry=`date -u -d "10 hours" '+%Y-%m-%dT%H:%MZ`
```

```
$ export BOOTSTRAP_URL=`az storage blob generate-sas -c 'files' -n 'bootstrap.ign' --https-only --full-uri --permissions r --expiry $bootstrap_url_expiry --account-name ${CLUSTER_NAME}sa --account-key ${ACCOUNT_KEY} -o tsv`
```

3. Export the bootstrap ignition variable:

- a. If your environment uses a public certificate authority (CA), run this command:

```
$ export BOOTSTRAP_IGNITION=`jq -rcnM --arg v "3.2.0" --arg url ${BOOTSTRAP_URL} '{ignition:{version:$v,config:{replace:{source:$url}}}}' | base64 | tr -d '\n`
```

- b. If your environment uses an internal CA, you must add your PEM encoded bundle to the bootstrap ignition stub so that your bootstrap virtual machine can pull the bootstrap ignition from the storage account. Run the following commands, which assume your CA is in a file called **CA.pem**:

```
$ export CA="data:text/plain;charset=utf-8;base64,$(cat CA.pem |base64 |tr -d '\n')"
```

```
$ export BOOTSTRAP_IGNITION=`jq -rcnM --arg v "3.2.0" --arg url "$BOOTSTRAP_URL" --arg cert "$CA" '{ignition:{version:$v,security:{tls:{certificateAuthorities:[{source:$cert}]},config:{replace:{source:$url}}}}' | base64 | tr -d '\n`
```

4. Create the deployment by using the **az** CLI:

```
$ az deployment group create --verbose -g ${RESOURCE_GROUP} \
  --template-file "<installation_directory>/04_bootstrap.json" \
  --parameters bootstrapIgnition="${BOOTSTRAP_IGNITION}" \ 1
  --parameters baseName="${INFRA_ID}" \ 2
  --parameters diagnosticsStorageAccountName="${CLUSTER_NAME}sa" \ 3
```

- 1** The bootstrap Ignition content for the bootstrap cluster.
- 2** The base name to be used in resource names; this is usually the cluster's infrastructure ID.
- 3** The name of the storage account for your cluster.



### 7.5.14.1. ARM template for the bootstrap machine

You can use the following Azure Resource Manager (ARM) template to deploy the bootstrap machine that you need for your OpenShift Container Platform cluster:

#### Example 7.4. 04\_bootstrap.json ARM template

link:[https://raw.githubusercontent.com/openshift/installer/release-4.10/upi/azurestack/04\\_bootstrap.json](https://raw.githubusercontent.com/openshift/installer/release-4.10/upi/azurestack/04_bootstrap.json)

### 7.5.15. Creating the control plane machines in Azure Stack Hub

You must create the control plane machines in Microsoft Azure Stack Hub for your cluster to use. One way to create these machines is to modify the provided Azure Resource Manager (ARM) template.

If you do not use the provided ARM template to create your control plane machines, you must review the provided information and manually create the infrastructure. If your cluster does not initialize correctly, consider contacting Red Hat support with your installation logs.

#### Prerequisites

- Configure an Azure account.
- Generate the Ignition config files for your cluster.
- Create and configure a VNet and associated subnets in Azure Stack Hub.
- Create and configure networking and load balancers in Azure Stack Hub.
- Create control plane and compute roles.
- Create the bootstrap machine.

#### Procedure

1. Copy the template from the **ARM template for control plane machines** section of this topic and save it as **05\_masters.json** in your cluster's installation directory. This template describes the control plane machines that your cluster requires.
2. Export the following variable needed by the control plane machine deployment:

```
$ export MASTER_IGNITION=`cat <installation_directory>/master.ign | base64 | tr -d "\n`
```

3. Create the deployment by using the **az** CLI:

```
$ az deployment group create -g ${RESOURCE_GROUP} \
  --template-file "<installation_directory>/05_masters.json" \
  --parameters masterIgnition="${MASTER_IGNITION}" \ 1
  --parameters baseName="${INFRA_ID}" \ 2
  --parameters diagnosticsStorageAccountName="${CLUSTER_NAME}sa" 3
```

- 1** The Ignition content for the control plane nodes (also known as the master nodes).

- 2 The base name to be used in resource names; this is usually the cluster's infrastructure ID.
- 3 The name of the storage account for your cluster.

### 7.5.15.1. ARM template for control plane machines

You can use the following Azure Resource Manager (ARM) template to deploy the control plane machines that you need for your OpenShift Container Platform cluster:

#### Example 7.5. 05\_masters.json ARM template

```
link:https://raw.githubusercontent.com/openshift/installer/release-4.10/upi/azurestack/05_masters.json[]
```

### 7.5.16. Wait for bootstrap completion and remove bootstrap resources in Azure Stack Hub

After you create all of the required infrastructure in Microsoft Azure Stack Hub, wait for the bootstrap process to complete on the machines that you provisioned by using the Ignition config files that you generated with the installation program.

#### Prerequisites

- Configure an Azure account.
- Generate the Ignition config files for your cluster.
- Create and configure a VNet and associated subnets in Azure Stack Hub.
- Create and configure networking and load balancers in Azure Stack Hub.
- Create control plane and compute roles.
- Create the bootstrap machine.
- Create the control plane machines.

#### Procedure

1. Change to the directory that contains the installation program and run the following command:

```
$ ./openshift-install wait-for bootstrap-complete --dir <installation_directory> \ 1
--log-level info 2
```

1 For **<installation\_directory>**, specify the path to the directory that you stored the installation files in.

2 To view different installation details, specify **warn**, **debug**, or **error** instead of **info**.

If the command exits without a **FATAL** warning, your production control plane has initialized.

2. Delete the bootstrap resources:

```
$ az network nsg rule delete -g ${RESOURCE_GROUP} --nsg-name ${INFRA_ID}-nsg --
name bootstrap_ssh_in
$ az vm stop -g ${RESOURCE_GROUP} --name ${INFRA_ID}-bootstrap
$ az vm deallocate -g ${RESOURCE_GROUP} --name ${INFRA_ID}-bootstrap
$ az vm delete -g ${RESOURCE_GROUP} --name ${INFRA_ID}-bootstrap --yes
$ az disk delete -g ${RESOURCE_GROUP} --name ${INFRA_ID}-bootstrap OSDisk --no-
wait --yes
$ az network nic delete -g ${RESOURCE_GROUP} --name ${INFRA_ID}-bootstrap-nic --no-
wait
$ az storage blob delete --account-key ${ACCOUNT_KEY} --account-name
${CLUSTER_NAME}sa --container-name files --name bootstrap.ign
$ az network public-ip delete -g ${RESOURCE_GROUP} --name ${INFRA_ID}-bootstrap-
ssh-pip
```



#### NOTE

If you do not delete the bootstrap server, installation may not succeed due to API traffic being routed to the bootstrap server.

### 7.5.17. Creating additional worker machines in Azure Stack Hub

You can create worker machines in Microsoft Azure Stack Hub for your cluster to use by launching individual instances discretely or by automated processes outside the cluster, such as auto scaling groups. You can also take advantage of the built-in cluster scaling mechanisms and the machine API in OpenShift Container Platform.

In this example, you manually launch one instance by using the Azure Resource Manager (ARM) template. Additional instances can be launched by including additional resources of type **06\_workers.json** in the file.

If you do not use the provided ARM template to create your control plane machines, you must review the provided information and manually create the infrastructure. If your cluster does not initialize correctly, consider contacting Red Hat support with your installation logs.

#### Prerequisites

- Configure an Azure account.
- Generate the Ignition config files for your cluster.
- Create and configure a VNet and associated subnets in Azure Stack Hub.
- Create and configure networking and load balancers in Azure Stack Hub.
- Create control plane and compute roles.
- Create the bootstrap machine.
- Create the control plane machines.

#### Procedure

1. Copy the template from the **ARM template for worker machines** section of this topic and save it as **06\_workers.json** in your cluster's installation directory. This template describes the worker machines that your cluster requires.
2. Export the following variable needed by the worker machine deployment:

```
$ export WORKER_IGNITION=`cat <installation_directory>/worker.ign | base64 | tr -d '\n'
```

3. Create the deployment by using the **az** CLI:

```
$ az deployment group create -g ${RESOURCE_GROUP} \
  --template-file "<installation_directory>/06_workers.json" \
  --parameters workerIgnition="${WORKER_IGNITION}" \ 1
  --parameters baseName="${INFRA_ID}" 2
  --parameters diagnosticsStorageAccountName="${CLUSTER_NAME}sa" 3
```

- 1** The Ignition content for the worker nodes.
- 2** The base name to be used in resource names; this is usually the cluster's infrastructure ID.
- 3** The name of the storage account for your cluster.

### 7.5.17.1. ARM template for worker machines

You can use the following Azure Resource Manager (ARM) template to deploy the worker machines that you need for your OpenShift Container Platform cluster:

#### Example 7.6. 06\_workers.json ARM template

```
link:https://raw.githubusercontent.com/openshift/installer/release-4.10/upi/azurestack/06_workers.json[]
```

### 7.5.18. Installing the OpenShift CLI by downloading the binary

You can install the OpenShift CLI (**oc**) to interact with OpenShift Container Platform from a command-line interface. You can install **oc** on Linux, Windows, or macOS.

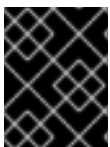

#### IMPORTANT

If you installed an earlier version of **oc**, you cannot use it to complete all of the commands in OpenShift Container Platform 4.10. Download and install the new version of **oc**.

#### Installing the OpenShift CLI on Linux

You can install the OpenShift CLI (**oc**) binary on Linux by using the following procedure.

#### Procedure

1. Navigate to the [OpenShift Container Platform downloads page](#) on the Red Hat Customer Portal.
2. Select the appropriate version in the **Version** drop-down menu.

3. Click **Download Now** next to the **OpenShift v4.10 Linux Client** entry and save the file.
4. Unpack the archive:

```
$ tar xvf <file>
```

5. Place the **oc** binary in a directory that is on your **PATH**.  
To check your **PATH**, execute the following command:

```
$ echo $PATH
```

After you install the OpenShift CLI, it is available using the **oc** command:

```
$ oc <command>
```

### Installing the OpenShift CLI on Windows

You can install the OpenShift CLI (**oc**) binary on Windows by using the following procedure.

#### Procedure

1. Navigate to the [OpenShift Container Platform downloads page](#) on the Red Hat Customer Portal.
2. Select the appropriate version in the **Version** drop-down menu.
3. Click **Download Now** next to the **OpenShift v4.10 Windows Client** entry and save the file.
4. Unzip the archive with a ZIP program.
5. Move the **oc** binary to a directory that is on your **PATH**.  
To check your **PATH**, open the command prompt and execute the following command:

```
C:\> path
```

After you install the OpenShift CLI, it is available using the **oc** command:

```
C:\> oc <command>
```

### Installing the OpenShift CLI on macOS

You can install the OpenShift CLI (**oc**) binary on macOS by using the following procedure.

#### Procedure

1. Navigate to the [OpenShift Container Platform downloads page](#) on the Red Hat Customer Portal.
2. Select the appropriate version in the **Version** drop-down menu.
3. Click **Download Now** next to the **OpenShift v4.10 MacOSX Client** entry and save the file.
4. Unpack and unzip the archive.
5. Move the **oc** binary to a directory on your **PATH**.  
To check your **PATH**, open a terminal and execute the following command:

```
$ echo $PATH
```

After you install the OpenShift CLI, it is available using the **oc** command:

```
$ oc <command>
```

### 7.5.19. Logging in to the cluster by using the CLI

You can log in to your cluster as a default system user by exporting the cluster **kubeconfig** file. The **kubeconfig** file contains information about the cluster that is used by the CLI to connect a client to the correct cluster and API server. The file is specific to a cluster and is created during OpenShift Container Platform installation.

#### Prerequisites

- You deployed an OpenShift Container Platform cluster.
- You installed the **oc** CLI.

#### Procedure

1. Export the **kubeadmin** credentials:

```
$ export KUBECONFIG=<installation_directory>/auth/kubeconfig 1
```

- 1** For **<installation\_directory>**, specify the path to the directory that you stored the installation files in.

2. Verify you can run **oc** commands successfully using the exported configuration:

```
$ oc whoami
```

#### Example output

```
system:admin
```

### 7.5.20. Approving the certificate signing requests for your machines

When you add machines to a cluster, two pending certificate signing requests (CSRs) are generated for each machine that you added. You must confirm that these CSRs are approved or, if necessary, approve them yourself. The client requests must be approved first, followed by the server requests.

#### Prerequisites

- You added machines to your cluster.

#### Procedure

1. Confirm that the cluster recognizes the machines:

```
$ oc get nodes
```

## Example output

NAME	STATUS	ROLES	AGE	VERSION
master-0	Ready	master	63m	v1.23.0
master-1	Ready	master	63m	v1.23.0
master-2	Ready	master	64m	v1.23.0

The output lists all of the machines that you created.

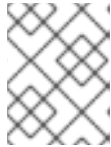

### NOTE

The preceding output might not include the compute nodes, also known as worker nodes, until some CSRs are approved.

2. Review the pending CSRs and ensure that you see the client requests with the **Pending** or **Approved** status for each machine that you added to the cluster:

```
$ oc get csr
```

## Example output

NAME	AGE	REQUESTOR	CONDITION
csr-8b2br	15m	system:serviceaccount:openshift-machine-config-operator:node-bootstrapper	Pending
csr-8vnps	15m	system:serviceaccount:openshift-machine-config-operator:node-bootstrapper	Pending
...			

In this example, two machines are joining the cluster. You might see more approved CSRs in the list.

3. If the CSRs were not approved, after all of the pending CSRs for the machines you added are in **Pending** status, approve the CSRs for your cluster machines:



### NOTE

Because the CSRs rotate automatically, approve your CSRs within an hour of adding the machines to the cluster. If you do not approve them within an hour, the certificates will rotate, and more than two certificates will be present for each node. You must approve all of these certificates. After the client CSR is approved, the Kubelet creates a secondary CSR for the serving certificate, which requires manual approval. Then, subsequent serving certificate renewal requests are automatically approved by the **machine-approver** if the Kubelet requests a new certificate with identical parameters.

**NOTE**

For clusters running on platforms that are not machine API enabled, such as bare metal and other user-provisioned infrastructure, you must implement a method of automatically approving the kubelet serving certificate requests (CSRs). If a request is not approved, then the **oc exec**, **oc rsh**, and **oc logs** commands cannot succeed, because a serving certificate is required when the API server connects to the kubelet. Any operation that contacts the Kubelet endpoint requires this certificate approval to be in place. The method must watch for new CSRs, confirm that the CSR was submitted by the **node-bootstrap** service account in the **system:node** or **system:admin** groups, and confirm the identity of the node.

- To approve them individually, run the following command for each valid CSR:

```
$ oc adm certificate approve <csr_name> 1
```

- 1** **<csr\_name>** is the name of a CSR from the list of current CSRs.

- To approve all pending CSRs, run the following command:

```
$ oc get csr -o go-template='{{range .items}}{{if not .status}}{{.metadata.name}}{\n"}\n{{end}}' | xargs --no-run-if-empty oc adm certificate approve
```

**NOTE**

Some Operators might not become available until some CSRs are approved.

- Now that your client requests are approved, you must review the server requests for each machine that you added to the cluster:

```
$ oc get csr
```

**Example output**

```
NAME      AGE   REQUESTOR                                     CONDITION
csr-bfd72 5m26s system:node:ip-10-0-50-126.us-east-2.compute.internal
Pending
csr-c57lv 5m26s system:node:ip-10-0-95-157.us-east-2.compute.internal
Pending
...
```

- If the remaining CSRs are not approved, and are in the **Pending** status, approve the CSRs for your cluster machines:

- To approve them individually, run the following command for each valid CSR:

```
$ oc adm certificate approve <csr_name> 1
```

- 1** **<csr\_name>** is the name of a CSR from the list of current CSRs.



- To approve all pending CSRs, run the following command:

```
$ oc get csr -o go-template='{{range .items}}{{if not .status}}{{.metadata.name}}{\n"}\n{{end}}\n{{end}}' | xargs oc adm certificate approve
```

6. After all client and server CSRs have been approved, the machines have the **Ready** status. Verify this by running the following command:

```
$ oc get nodes
```

### Example output

```
NAME      STATUS  ROLES  AGE  VERSION
master-0  Ready   master 73m  v1.23.0
master-1  Ready   master 73m  v1.23.0
master-2  Ready   master 74m  v1.23.0
worker-0  Ready   worker 11m  v1.23.0
worker-1  Ready   worker 11m  v1.23.0
```



### NOTE

It can take a few minutes after approval of the server CSRs for the machines to transition to the **Ready** status.

### Additional information

- For more information on CSRs, see [Certificate Signing Requests](#).

## 7.5.21. Adding the Ingress DNS records

If you removed the DNS Zone configuration when creating Kubernetes manifests and generating Ignition configs, you must manually create DNS records that point at the Ingress load balancer. You can create either a wildcard **\*.apps.{baseDomain}**, or specific records. You can use A, CNAME, and other records per your requirements.

### Prerequisites

- You deployed an OpenShift Container Platform cluster on Microsoft Azure Stack Hub by using infrastructure that you provisioned.
- Install the OpenShift CLI (**oc**).
- Install or update the [Azure CLI](#).

### Procedure

1. Confirm the Ingress router has created a load balancer and populated the **EXTERNAL-IP** field:

```
$ oc -n openshift-ingress get service router-default
```

### Example output

NAME	TYPE	CLUSTER-IP	EXTERNAL-IP	PORT(S)	AGE
router-default	LoadBalancer	172.30.20.10	35.130.120.110	80:32288/TCP,443:31215/TCP	20

- Export the Ingress router IP as a variable:

```
$ export PUBLIC_IP_ROUTER=`oc -n openshift-ingress get service router-default --no-headers | awk '{print $4}'`
```

- Add a **\*.apps** record to the DNS zone.

- If you are adding this cluster to a new DNS zone, run:

```
$ az network dns record-set a add-record -g ${BASE_DOMAIN_RESOURCE_GROUP} -z ${CLUSTER_NAME}.${BASE_DOMAIN} -n *.apps -a ${PUBLIC_IP_ROUTER} --ttl 300
```

- If you are adding this cluster to an already existing DNS zone, run:

```
$ az network dns record-set a add-record -g ${BASE_DOMAIN_RESOURCE_GROUP} -z ${BASE_DOMAIN} -n *.apps.${CLUSTER_NAME} -a ${PUBLIC_IP_ROUTER} --ttl 300
```

If you prefer to add explicit domains instead of using a wildcard, you can create entries for each of the cluster's current routes:

```
$ oc get --all-namespaces -o jsonpath='{range .items[*]}{range .status.ingress[*]}{.host}{"\n"}{end}{end}' routes
```

### Example output

```
oauth-openshift.apps.cluster.basedomain.com
console-openshift-console.apps.cluster.basedomain.com
downloads-openshift-console.apps.cluster.basedomain.com
alertmanager-main-openshift-monitoring.apps.cluster.basedomain.com
grafana-openshift-monitoring.apps.cluster.basedomain.com
prometheus-k8s-openshift-monitoring.apps.cluster.basedomain.com
```

## 7.5.22. Completing an Azure Stack Hub installation on user-provisioned infrastructure

After you start the OpenShift Container Platform installation on Microsoft Azure Stack Hub user-provisioned infrastructure, you can monitor the cluster events until the cluster is ready.

### Prerequisites

- Deploy the bootstrap machine for an OpenShift Container Platform cluster on user-provisioned Azure Stack Hub infrastructure.
- Install the **oc** CLI and log in.

### Procedure

- Complete the cluster installation:

-

```
$ ./openshift-install --dir <installation_directory> wait-for install-complete 1
```

### Example output

```
INFO Waiting up to 30m0s for the cluster to initialize...
```

- 1** For **<installation\_directory>**, specify the path to the directory that you stored the installation files in.

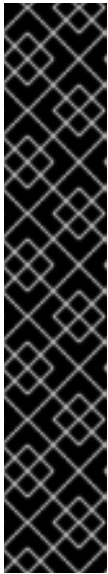

### IMPORTANT

- The Ignition config files that the installation program generates contain certificates that expire after 24 hours, which are then renewed at that time. If the cluster is shut down before renewing the certificates and the cluster is later restarted after the 24 hours have elapsed, the cluster automatically recovers the expired certificates. The exception is that you must manually approve the pending **node-bootstrapper** certificate signing requests (CSRs) to recover kubelet certificates. See the documentation for *Recovering from expired control plane certificates* for more information.
- It is recommended that you use Ignition config files within 12 hours after they are generated because the 24-hour certificate rotates from 16 to 22 hours after the cluster is installed. By using the Ignition config files within 12 hours, you can avoid installation failure if the certificate update runs during installation.

### Additional resources

- See [About remote health monitoring](#) for more information about the Telemetry service.

## 7.6. UNINSTALLING A CLUSTER ON AZURE STACK HUB

You can remove a cluster that you deployed to Azure Stack Hub.

### 7.6.1. Removing a cluster that uses installer-provisioned infrastructure

You can remove a cluster that uses installer-provisioned infrastructure from your cloud.



### NOTE

After uninstallation, check your cloud provider for any resources not removed properly, especially with User Provisioned Infrastructure (UPI) clusters. There might be resources that the installer did not create or that the installer is unable to access.

### Prerequisites

- Have a copy of the installation program that you used to deploy the cluster.
- Have the files that the installation program generated when you created your cluster.

While you can uninstall the cluster using the copy of the installation program that was used to deploy it, using OpenShift Container Platform version 4.13 or later is recommended.

The removal of service principals is dependent on the Microsoft Azure AD Graph API. Using version 4.13 or later of the installation program ensures that service principals are removed without the need for manual intervention, if and when Microsoft decides to [retire](#) the Azure AD Graph API.

## Procedure

1. From the directory that contains the installation program on the computer that you used to install the cluster, run the following command:

```
$. /openshift-install destroy cluster \  
--dir <installation_directory> --log-level info 1 2
```

- 1** For **<installation\_directory>**, specify the path to the directory that you stored the installation files in.
- 2** To view different details, specify **warn**, **debug**, or **error** instead of **info**.

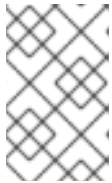

### NOTE

You must specify the directory that contains the cluster definition files for your cluster. The installation program requires the **metadata.json** file in this directory to delete the cluster.

1. Optional: Delete the **<installation\_directory>** directory and the OpenShift Container Platform installation program.

## CHAPTER 8. INSTALLING ON GCP

### 8.1. PREPARING TO INSTALL ON GCP

#### 8.1.1. Prerequisites

- You reviewed details about the [OpenShift Container Platform installation and update](#) processes.
- You read the documentation on [selecting a cluster installation method and preparing it for users](#).

#### 8.1.2. Requirements for installing OpenShift Container Platform on GCP

Before installing OpenShift Container Platform on Google Cloud Platform (GCP), you must create a service account and configure a GCP project. See [Configuring a GCP project](#) for details about creating a project, enabling API services, configuring DNS, GCP account limits, and supported GCP regions.

If the cloud identity and access management (IAM) APIs are not accessible in your environment, or if you do not want to store an administrator-level credential secret in the **kube-system** namespace, see [Manually creating IAM for GCP](#) for other options.

#### 8.1.3. Choosing a method to install OpenShift Container Platform on GCP

You can install OpenShift Container Platform on installer-provisioned or user-provisioned infrastructure. The default installation type uses installer-provisioned infrastructure, where the installation program provisions the underlying infrastructure for the cluster. You can also install OpenShift Container Platform on infrastructure that you provision. If you do not use infrastructure that the installation program provisions, you must manage and maintain the cluster resources yourself.

See [Installation process](#) for more information about installer-provisioned and user-provisioned installation processes.

##### 8.1.3.1. Installing a cluster on installer-provisioned infrastructure

You can install a cluster on GCP infrastructure that is provisioned by the OpenShift Container Platform installation program, by using one of the following methods:

- **Installing a cluster quickly on GCP** You can install OpenShift Container Platform on GCP infrastructure that is provisioned by the OpenShift Container Platform installation program. You can install a cluster quickly by using the default configuration options.
- **Installing a customized cluster on GCP** You can install a customized cluster on GCP infrastructure that the installation program provisions. The installation program allows for some customization to be applied at the installation stage. Many other customization options are available [post-installation](#).
- **Installing a cluster on GCP with network customizations** You can customize your OpenShift Container Platform network configuration during installation, so that your cluster can coexist with your existing IP address allocations and adhere to your network requirements.
- **Installing a cluster on GCP in a restricted network** You can install OpenShift Container Platform on GCP on installer-provisioned infrastructure by using an internal mirror of the installation release content. You can use this method to install a cluster that does not require an

active internet connection to obtain the software components. While you can install OpenShift Container Platform by using the mirrored content, your cluster still requires internet access to use the GCP APIs.

- **Installing a cluster into an existing Virtual Private Cloud** You can install OpenShift Container Platform on an existing GCP Virtual Private Cloud (VPC). You can use this installation method if you have constraints set by the guidelines of your company, such as limits on creating new accounts or infrastructure.
- **Installing a private cluster on an existing VPC** You can install a private cluster on an existing GCP VPC. You can use this method to deploy OpenShift Container Platform on an internal network that is not visible to the internet.

### 8.1.3.2. Installing a cluster on user-provisioned infrastructure

You can install a cluster on GCP infrastructure that you provision, by using one of the following methods:

- **Installing a cluster on GCP with user-provisioned infrastructure** You can install OpenShift Container Platform on GCP infrastructure that you provide. You can use the provided Deployment Manager templates to assist with the installation.
- **Installing a cluster with shared VPC on user-provisioned infrastructure in GCP** You can use the provided Deployment Manager templates to create GCP resources in a shared VPC infrastructure.
- **Installing a cluster on GCP in a restricted network with user-provisioned infrastructure** You can install OpenShift Container Platform on GCP in a restricted network with user-provisioned infrastructure. By creating an internal mirror of the installation release content, you can install a cluster that does not require an active internet connection to obtain the software components. You can also use this installation method to ensure that your clusters only use container images that satisfy your organizational controls on external content.

### 8.1.4. Next steps

- [Configuring a GCP project](#)

## 8.2. CONFIGURING A GCP PROJECT

Before you can install OpenShift Container Platform, you must configure a Google Cloud Platform (GCP) project to host it.

### 8.2.1. Creating a GCP project

To install OpenShift Container Platform, you must create a project in your Google Cloud Platform (GCP) account to host the cluster.

#### Procedure

- Create a project to host your OpenShift Container Platform cluster. See [Creating and Managing Projects](#) in the GCP documentation.

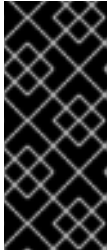

## IMPORTANT

Your GCP project must use the Premium Network Service Tier if you are using installer-provisioned infrastructure. The Standard Network Service Tier is not supported for clusters installed using the installation program. The installation program configures internal load balancing for the **api-int.<cluster\_name>.<base\_domain>** URL; the Premium Tier is required for internal load balancing.

### 8.2.2. Enabling API services in GCP

Your Google Cloud Platform (GCP) project requires access to several API services to complete OpenShift Container Platform installation.

#### Prerequisites

- You created a project to host your cluster.

#### Procedure

- Enable the following required API services in the project that hosts your cluster. You can also enable optional API services which are not required for installation. See [Enabling services](#) in the GCP documentation.

**Table 8.1. Required API services**

API service	Console service name
Compute Engine API	<b>compute.googleapis.com</b>
Cloud Resource Manager API	<b>cloudresourcemanager.googleapis.com</b>
Google DNS API	<b>dns.googleapis.com</b>
IAM Service Account Credentials API	<b>iamcredentials.googleapis.com</b>
Identity and Access Management (IAM) API	<b>iam.googleapis.com</b>
Service Usage API	<b>serviceusage.googleapis.com</b>

**Table 8.2. Optional API services**

API service	Console service name
Google Cloud APIs	<b>cloudapis.googleapis.com</b>
Service Management API	<b>servicemanagement.googleapis.com</b>
Google Cloud Storage JSON API	<b>storage-api.googleapis.com</b>

API service	Console service name
Cloud Storage	<b>storage-component.googleapis.com</b>

### 8.2.3. Configuring DNS for GCP

To install OpenShift Container Platform, the Google Cloud Platform (GCP) account you use must have a dedicated public hosted zone in the same project that you host the OpenShift Container Platform cluster. This zone must be authoritative for the domain. The DNS service provides cluster DNS resolution and name lookup for external connections to the cluster.

#### Procedure

1. Identify your domain, or subdomain, and registrar. You can transfer an existing domain and registrar or obtain a new one through GCP or another source.

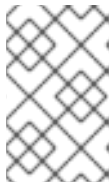

#### NOTE

If you purchase a new domain, it can take time for the relevant DNS changes to propagate. For more information about purchasing domains through Google, see [Google Domains](#).

2. Create a public hosted zone for your domain or subdomain in your GCP project. See [Creating public zones](#) in the GCP documentation. Use an appropriate root domain, such as **openshiftcorp.com**, or subdomain, such as **clusters.openshiftcorp.com**.
3. Extract the new authoritative name servers from the hosted zone records. See [Look up your Cloud DNS name servers](#) in the GCP documentation. You typically have four name servers.
4. Update the registrar records for the name servers that your domain uses. For example, if you registered your domain to Google Domains, see the following topic in the Google Domains Help: [How to switch to custom name servers](#).
5. If you migrated your root domain to Google Cloud DNS, migrate your DNS records. See [Migrating to Cloud DNS](#) in the GCP documentation.
6. If you use a subdomain, follow your company's procedures to add its delegation records to the parent domain. This process might include a request to your company's IT department or the division that controls the root domain and DNS services for your company.

### 8.2.4. GCP account limits

The OpenShift Container Platform cluster uses a number of Google Cloud Platform (GCP) components, but the default [Quotas](#) do not affect your ability to install a default OpenShift Container Platform cluster.

A default cluster, which contains three compute and three control plane machines, uses the following resources. Note that some resources are required only during the bootstrap process and are removed after the cluster deploys.

**Table 8.3. GCP resources used in a default cluster**



Service	Component	Location	Total resources required	Resources removed after bootstrap
Service account	IAM	Global	5	0
Firewall rules	Compute	Global	11	1
Forwarding rules	Compute	Global	2	0
In-use global IP addresses	Compute	Global	4	1
Health checks	Compute	Global	3	0
Images	Compute	Global	1	0
Networks	Compute	Global	2	0
Static IP addresses	Compute	Region	4	1
Routers	Compute	Global	1	0
Routes	Compute	Global	2	0
Subnetworks	Compute	Global	2	0
Target pools	Compute	Global	3	0
CPUs	Compute	Region	28	4
Persistent disk SSD (GB)	Compute	Region	896	128



## NOTE

If any of the quotas are insufficient during installation, the installation program displays an error that states both which quota was exceeded and the region.

Be sure to consider your actual cluster size, planned cluster growth, and any usage from other clusters that are associated with your account. The CPU, static IP addresses, and persistent disk SSD (storage) quotas are the ones that are most likely to be insufficient.

If you plan to deploy your cluster in one of the following regions, you will exceed the maximum storage quota and are likely to exceed the CPU quota limit:

- **asia-east2**
- **asia-northeast2**

- **asia-south1**
- **australia-southeast1**
- **europa-north1**
- **europa-west2**
- **europa-west3**
- **europa-west6**
- **northamerica-northeast1**
- **southamerica-east1**
- **us-west2**

You can increase resource quotas from the [GCP console](#), but you might need to file a support ticket. Be sure to plan your cluster size early so that you can allow time to resolve the support ticket before you install your OpenShift Container Platform cluster.

### 8.2.5. Creating a service account in GCP

OpenShift Container Platform requires a Google Cloud Platform (GCP) service account that provides authentication and authorization to access data in the Google APIs. If you do not have an existing IAM service account that contains the required roles in your project, you must create one.

#### Prerequisites

- You created a project to host your cluster.

#### Procedure

1. Create a service account in the project that you use to host your OpenShift Container Platform cluster. See [Creating a service account](#) in the GCP documentation.
2. Grant the service account the appropriate permissions. You can either grant the individual permissions that follow or assign the **Owner** role to it. See [Granting roles to a service account for specific resources](#).



#### NOTE

While making the service account an owner of the project is the easiest way to gain the required permissions, it means that service account has complete control over the project. You must determine if the risk that comes from offering that power is acceptable.

3. Create the service account key in JSON format. See [Creating service account keys](#) in the GCP documentation.  
The service account key is required to create a cluster.

#### 8.2.5.1. Required GCP roles

When you attach the **Owner** role to the service account that you create, you grant that service account

all permissions, including those that are required to install OpenShift Container Platform. If your organization's security policies require a more restrictive set of permissions, you can create a service account with the following permissions. If you deploy your cluster into an existing virtual private cloud (VPC), the service account does not require certain networking permissions, which are noted in the following lists:

#### Required roles for the installation program

- Compute Admin
- Security Admin
- Service Account Admin
- Service Account Key Admin
- Service Account User
- Storage Admin

#### Required roles for creating network resources during installation

- DNS Administrator

The roles are applied to the service accounts that the control plane and compute machines use:

**Table 8.4. GCP service account permissions**

Account	Roles
Control Plane	<b>roles/compute.instanceAdmin</b>
	<b>roles/compute.networkAdmin</b>
	<b>roles/compute.securityAdmin</b>
	<b>roles/storage.admin</b>
	<b>roles/iam.serviceAccountUser</b>
Compute	<b>roles/compute.viewer</b>
	<b>roles/storage.admin</b>

#### 8.2.5.2. Required GCP permissions for installer-provisioned infrastructure

When you attach the **Owner** role to the service account that you create, you grant that service account all permissions, including those that are required to install OpenShift Container Platform.

If your organization's security policies require a more restrictive set of permissions, you can create [custom roles](#) with the necessary permissions. The following permissions are required for the installer-provisioned infrastructure for creating and deleting the OpenShift Container Platform cluster.

-

**Example 8.1. Required permissions for creating network resources**

- **compute.addresses.create**
- **compute.addresses.createInternal**
- **compute.addresses.delete**
- **compute.addresses.get**
- **compute.addresses.list**
- **compute.addresses.use**
- **compute.addresses.useInternal**
- **compute.firewalls.create**
- **compute.firewalls.delete**
- **compute.firewalls.get**
- **compute.firewalls.list**
- **compute.forwardingRules.create**
- **compute.forwardingRules.get**
- **compute.forwardingRules.list**
- **compute.forwardingRules.setLabels**
- **compute.networks.create**
- **compute.networks.get**
- **compute.networks.list**
- **compute.networks.updatePolicy**
- **compute.routers.create**
- **compute.routers.get**
- **compute.routers.list**
- **compute.routers.update**
- **compute.routes.list**
- **compute.subnetworks.create**
- **compute.subnetworks.get**
- **compute.subnetworks.list**
- **compute.subnetworks.use**

- `compute.subnetworks.useExternalIp`

Example 8.2. Required permissions for creating load balancer resources

- `compute.regionBackendServices.create`
- `compute.regionBackendServices.get`
- `compute.regionBackendServices.list`
- `compute.regionBackendServices.update`
- `compute.regionBackendServices.use`
- `compute.targetPools.addInstance`
- `compute.targetPools.create`
- `compute.targetPools.get`
- `compute.targetPools.list`
- `compute.targetPools.removeInstance`
- `compute.targetPools.use`

Example 8.3. Required permissions for creating DNS resources

- `dns.changes.create`
- `dns.changes.get`
- `dns.managedZones.create`
- `dns.managedZones.get`
- `dns.managedZones.list`
- `dns.networks.bindPrivateDNSZone`
- `dns.resourceRecordSets.create`
- `dns.resourceRecordSets.list`

Example 8.4. Required permissions for creating Service Account resources

- `iam.serviceAccountKeys.create`
- `iam.serviceAccountKeys.delete`
- `iam.serviceAccountKeys.get`
- `iam.serviceAccountKeys.list`

- `iam.serviceAccounts.actAs`
- `iam.serviceAccounts.create`
- `iam.serviceAccounts.delete`
- `iam.serviceAccounts.get`
- `iam.serviceAccounts.list`
- `resourcemanager.projects.get`
- `resourcemanager.projects.getIamPolicy`
- `resourcemanager.projects.setIamPolicy`

Example 8.5. Required permissions for creating compute resources

- `compute.disks.create`
- `compute.disks.get`
- `compute.disks.list`
- `compute.instanceGroups.create`
- `compute.instanceGroups.delete`
- `compute.instanceGroups.get`
- `compute.instanceGroups.list`
- `compute.instanceGroups.update`
- `compute.instanceGroups.use`
- `compute.instances.create`
- `compute.instances.delete`
- `compute.instances.get`
- `compute.instances.list`
- `compute.instances.setLabels`
- `compute.instances.setMetadata`
- `compute.instances.setServiceAccount`
- `compute.instances.setTags`
- `compute.instances.use`
- `compute.machineTypes.get`
- `compute.machineTypes.list`

**Example 8.6. Required for creating storage resources**

- **storage.buckets.create**
- **storage.buckets.delete**
- **storage.buckets.get**
- **storage.buckets.list**
- **storage.objects.create**
- **storage.objects.delete**
- **storage.objects.get**
- **storage.objects.list**

**Example 8.7. Required permissions for creating health check resources**

- **compute.healthChecks.create**
- **compute.healthChecks.get**
- **compute.healthChecks.list**
- **compute.healthChecks.useReadOnly**
- **compute.httpHealthChecks.create**
- **compute.httpHealthChecks.get**
- **compute.httpHealthChecks.list**
- **compute.httpHealthChecks.useReadOnly**

**Example 8.8. Required permissions to get GCP zone and region related information**

- **compute.globalOperations.get**
- **compute.regionOperations.get**
- **compute.regions.list**
- **compute.zoneOperations.get**
- **compute.zones.get**
- **compute.zones.list**

**Example 8.9. Required permissions for checking services and quotas**

- **monitoring.timeSeries.list**
- **serviceusage.quotas.get**
- **serviceusage.services.list**

Example 8.10. Required IAM permissions for installation

- **iam.roles.get**

Example 8.11. Optional Images permissions for installation

- **compute.images.list**

Example 8.12. Optional permission for running gather bootstrap

- **compute.instances.getSerialPortOutput**

Example 8.13. Required permissions for deleting network resources

- **compute.addresses.delete**
- **compute.addresses.deleteInternal**
- **compute.addresses.list**
- **compute.firewalls.delete**
- **compute.firewalls.list**
- **compute.forwardingRules.delete**
- **compute.forwardingRules.list**
- **compute.networks.delete**
- **compute.networks.list**
- **compute.networks.updatePolicy**
- **compute.routers.delete**
- **compute.routers.list**
- **compute.routes.list**
- **compute.subnetworks.delete**
- **compute.subnetworks.list**



**Example 8.14. Required permissions for deleting load balancer resources**

- **compute.regionBackendServices.delete**
- **compute.regionBackendServices.list**
- **compute.targetPools.delete**
- **compute.targetPools.list**

**Example 8.15. Required permissions for deleting DNS resources**

- **dns.changes.create**
- **dns.managedZones.delete**
- **dns.managedZones.get**
- **dns.managedZones.list**
- **dns.resourceRecordSets.delete**
- **dns.resourceRecordSets.list**

**Example 8.16. Required permissions for deleting Service Account resources**

- **iam.serviceAccounts.delete**
- **iam.serviceAccounts.get**
- **iam.serviceAccounts.list**
- **resourcemanager.projects.getIamPolicy**
- **resourcemanager.projects.setIamPolicy**

**Example 8.17. Required permissions for deleting compute resources**

- **compute.disks.delete**
- **compute.disks.list**
- **compute.instanceGroups.delete**
- **compute.instanceGroups.list**
- **compute.instances.delete**
- **compute.instances.list**
- **compute.instances.stop**
- **compute.machineTypes.list**

#### Example 8.18. Required for deleting storage resources

- **storage.buckets.delete**
- **storage.buckets.getIamPolicy**
- **storage.buckets.list**
- **storage.objects.delete**
- **storage.objects.list**

#### Example 8.19. Required permissions for deleting health check resources

- **compute.healthChecks.delete**
- **compute.healthChecks.list**
- **compute.httpHealthChecks.delete**
- **compute.httpHealthChecks.list**

#### Example 8.20. Required Images permissions for deletion

- **compute.images.list**

### 8.2.6. Supported GCP regions

You can deploy an OpenShift Container Platform cluster to the following Google Cloud Platform (GCP) regions:

- **asia-east1** (Changhua County, Taiwan)
- **asia-east2** (Hong Kong)
- **asia-northeast1** (Tokyo, Japan)
- **asia-northeast2** (Osaka, Japan)
- **asia-northeast3** (Seoul, South Korea)
- **asia-south1** (Mumbai, India)
- **asia-south2** (Delhi, India)
- **asia-southeast1** (Jurong West, Singapore)
- **asia-southeast2** (Jakarta, Indonesia)
- **australia-southeast1** (Sydney, Australia)
- **australia-southeast2** (Melbourne, Australia)

- **europa-central2** (Warsaw, Poland)
- **europa-north1** (Hamina, Finland)
- **europa-southwest1** (Madrid, Spain)
- **europa-west1** (St. Ghislain, Belgium)
- **europa-west2** (London, England, UK)
- **europa-west3** (Frankfurt, Germany)
- **europa-west4** (Eemshaven, Netherlands)
- **europa-west6** (Zürich, Switzerland)
- **europa-west8** (Milan, Italy)
- **europa-west9** (Paris, France)
- **northamerica-northeast1** (Montréal, Québec, Canada)
- **northamerica-northeast2** (Toronto, Ontario, Canada)
- **southamerica-east1** (São Paulo, Brazil)
- **southamerica-west1** (Santiago, Chile)
- **us-central1** (Council Bluffs, Iowa, USA)
- **us-east1** (Moncks Corner, South Carolina, USA)
- **us-east4** (Ashburn, Northern Virginia, USA)
- **us-east5** (Columbus, Ohio)
- **us-south1** (Dallas, Texas)
- **us-west1** (The Dalles, Oregon, USA)
- **us-west2** (Los Angeles, California, USA)
- **us-west3** (Salt Lake City, Utah, USA)
- **us-west4** (Las Vegas, Nevada, USA)

### 8.2.7. Next steps

- Install an OpenShift Container Platform cluster on GCP. You can [install a customized cluster](#) or [quickly install a cluster](#) with default options.

## 8.3. MANUALLY CREATING IAM FOR GCP

In environments where the cloud identity and access management (IAM) APIs are not reachable, or the administrator prefers not to store an administrator-level credential secret in the cluster **kube-system** namespace, you can put the Cloud Credential Operator (CCO) into manual mode before you install the cluster.

### 8.3.1. Alternatives to storing administrator-level secrets in the kube-system project

The Cloud Credential Operator (CCO) manages cloud provider credentials as Kubernetes custom resource definitions (CRDs). You can configure the CCO to suit the security requirements of your organization by setting different values for the **credentialsMode** parameter in the **install-config.yaml** file.

If you prefer not to store an administrator-level credential secret in the cluster **kube-system** project, you can choose one of the following options when installing OpenShift Container Platform:

- **Use manual mode with GCP Workload Identity**

You can use the CCO utility (**ccoctl**) to configure the cluster to use manual mode with GCP Workload Identity. When the CCO utility is used to configure the cluster for GCP Workload Identity, it signs service account tokens that provide short-term, limited-privilege security credentials to components.

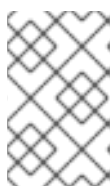

#### NOTE

This credentials strategy is supported for only new OpenShift Container Platform clusters and must be configured during installation. You cannot reconfigure an existing cluster that uses a different credentials strategy to use this feature.

- **Manage cloud credentials manually.**

You can set the **credentialsMode** parameter for the CCO to **Manual** to manage cloud credentials manually. Using manual mode allows each cluster component to have only the permissions it requires, without storing an administrator-level credential in the cluster. You can also use this mode if your environment does not have connectivity to the cloud provider public IAM endpoint. However, you must manually reconcile permissions with new release images for every upgrade. You must also manually supply credentials for every component that requests them.

- **Remove the administrator-level credential secret after installing OpenShift Container Platform with mint mode:**

If you are using the CCO with the **credentialsMode** parameter set to **Mint**, you can remove or rotate the administrator-level credential after installing OpenShift Container Platform. Mint mode is the default configuration for the CCO. This option requires the presence of the administrator-level credential during an installation. The administrator-level credential is used during the installation to mint other credentials with some permissions granted. The original credential secret is not stored in the cluster permanently.



#### NOTE

Prior to a non z-stream upgrade, you must reinstate the credential secret with the administrator-level credential. If the credential is not present, the upgrade might be blocked.

#### Additional resources

- [Using manual mode with GCP Workload Identity](#)
- [Rotating or removing cloud provider credentials](#)

For a detailed description of all available CCO credential modes and their supported platforms, see [About the Cloud Credential Operator](#).

### 8.3.2. Manually create IAM

The Cloud Credential Operator (CCO) can be put into manual mode prior to installation in environments where the cloud identity and access management (IAM) APIs are not reachable, or the administrator prefers not to store an administrator-level credential secret in the cluster **kube-system** namespace.

#### Procedure

1. Change to the directory that contains the installation program and create the **install-config.yaml** file by running the following command:

```
$ openshift-install create install-config --dir <installation_directory>
```

where **<installation\_directory>** is the directory in which the installation program creates files.

2. Edit the **install-config.yaml** configuration file so that it contains the **credentialsMode** parameter set to **Manual**.

#### Example install-config.yaml configuration file

```
apiVersion: v1
baseDomain: cluster1.example.com
credentialsMode: Manual 1
compute:
- architecture: amd64
  hyperthreading: Enabled
...
```

- 1** This line is added to set the **credentialsMode** parameter to **Manual**.

3. Generate the manifests by running the following command from the directory that contains the installation program:

```
$ openshift-install create manifests --dir <installation_directory>
```

where **<installation\_directory>** is the directory in which the installation program creates files.

4. From the directory that contains the installation program, obtain details of the OpenShift Container Platform release image that your **openshift-install** binary is built to use by running the following command:

```
$ openshift-install version
```

#### Example output

```
release image quay.io/openshift-release-dev/ocp-release:4.y.z-x86_64
```

5. Locate all **CredentialsRequest** objects in this release image that target the cloud you are deploying on by running the following command:

```
$ oc adm release extract quay.io/openshift-release-dev/ocp-release:4.y.z-x86_64 \
  --credentials-requests \
  --cloud=gcp
```

This command creates a YAML file for each **CredentialsRequest** object.

### Sample CredentialsRequest object

```
apiVersion: cloudcredential.openshift.io/v1
kind: CredentialsRequest
metadata:
  name: <component-credentials-request>
  namespace: openshift-cloud-credential-operator
  ...
spec:
  providerSpec:
    apiVersion: cloudcredential.openshift.io/v1
    kind: GCPProviderSpec
    predefinedRoles:
      - roles/storage.admin
      - roles/iam.serviceAccountUser
    skipServiceCheck: true
  ...
```

6. Create YAML files for secrets in the **openshift-install** manifests directory that you generated previously. The secrets must be stored using the namespace and secret name defined in the **spec.secretRef** for each **CredentialsRequest** object.

### Sample CredentialsRequest object with secrets

```
apiVersion: cloudcredential.openshift.io/v1
kind: CredentialsRequest
metadata:
  name: <component-credentials-request>
  namespace: openshift-cloud-credential-operator
  ...
spec:
  providerSpec:
    apiVersion: cloudcredential.openshift.io/v1
    ...
  secretRef:
    name: <component-secret>
    namespace: <component-namespace>
  ...
```

### Sample Secret object

```
apiVersion: v1
kind: Secret
metadata:
  name: <component-secret>
  namespace: <component-namespace>
data:
  service_account.json: <base64_encoded_gcp_service_account_file>
```

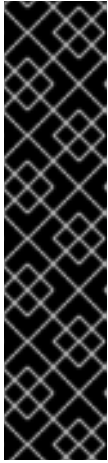

## IMPORTANT

The release image includes **CredentialsRequest** objects for Technology Preview features that are enabled by the **TechPreviewNoUpgrade** feature set. You can identify these objects by their use of the **release.openshift.io/feature-gate: TechPreviewNoUpgrade** annotation.

- If you are not using any of these features, do not create secrets for these objects. Creating secrets for Technology Preview features that you are not using can cause the installation to fail.
- If you are using any of these features, you must create secrets for the corresponding objects.

- To find **CredentialsRequest** objects with the **TechPreviewNoUpgrade** annotation, run the following command:

```
$ grep "release.openshift.io/feature-gate" *
```

### Example output

```
0000_30_capi-operator_00_credentials-request.yaml: release.openshift.io/feature-gate:
TechPreviewNoUpgrade
```

7. From the directory that contains the installation program, proceed with your cluster creation:

```
$ openshift-install create cluster --dir <installation_directory>
```

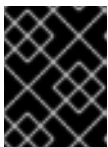

## IMPORTANT

Before upgrading a cluster that uses manually maintained credentials, you must ensure that the CCO is in an upgradeable state.

### Additional resources

- [Updating a cluster using the web console](#)
- [Updating a cluster using the CLI](#)

### 8.3.3. Mint mode

Mint mode is the default Cloud Credential Operator (CCO) credentials mode for OpenShift Container Platform on platforms that support it. In this mode, the CCO uses the provided administrator-level cloud credential to run the cluster. Mint mode is supported for AWS and GCP.

In mint mode, the **admin** credential is stored in the **kube-system** namespace and then used by the CCO to process the **CredentialsRequest** objects in the cluster and create users for each with specific permissions.

The benefits of mint mode include:

- Each cluster component has only the permissions it requires

- Automatic, on-going reconciliation for cloud credentials, including additional credentials or permissions that might be required for upgrades

One drawback is that mint mode requires **admin** credential storage in a cluster **kube-system** secret.

### 8.3.4. Mint mode with removal or rotation of the administrator-level credential

Currently, this mode is only supported on AWS and GCP.

In this mode, a user installs OpenShift Container Platform with an administrator-level credential just like the normal mint mode. However, this process removes the administrator-level credential secret from the cluster post-installation.

The administrator can have the Cloud Credential Operator make its own request for a read-only credential that allows it to verify if all **CredentialsRequest** objects have their required permissions, thus the administrator-level credential is not required unless something needs to be changed. After the associated credential is removed, it can be deleted or deactivated on the underlying cloud, if desired.



#### NOTE

Prior to a non z-stream upgrade, you must reinstate the credential secret with the administrator-level credential. If the credential is not present, the upgrade might be blocked.

The administrator-level credential is not stored in the cluster permanently.

Following these steps still requires the administrator-level credential in the cluster for brief periods of time. It also requires manually re-instating the secret with administrator-level credentials for each upgrade.

### 8.3.5. Next steps

- Install an OpenShift Container Platform cluster:
  - [Installing a cluster quickly on GCP](#) with default options on installer-provisioned infrastructure
  - [Install a cluster with cloud customizations on installer-provisioned infrastructure](#)
  - [Install a cluster with network customizations on installer-provisioned infrastructure](#)

## 8.4. INSTALLING A CLUSTER QUICKLY ON GCP

In OpenShift Container Platform version 4.10, you can install a cluster on Google Cloud Platform (GCP) that uses the default configuration options.

### 8.4.1. Prerequisites

- You reviewed details about the [OpenShift Container Platform installation and update](#) processes.
- You read the documentation on [selecting a cluster installation method and preparing it for users](#).
- You [configured a GCP project](#) to host the cluster.



- If you use a firewall, you [configured it to allow the sites](#) that your cluster requires access to.
- If the cloud identity and access management (IAM) APIs are not accessible in your environment, or if you do not want to store an administrator-level credential secret in the **kube-system** namespace, you can [manually create and maintain IAM credentials](#).
- You have determined that the GCP region to which you are installing supports the **N1** machine type. For more information, see the [Google documentation](#). By default, the installation program deploys control plane and compute nodes with the **N1** machine type.



#### NOTE

If the region to which you are installing does not support the **N1** machine type, you cannot complete the installation using these steps. You must specify a supported machine type in the **install-config.yaml** file before you install the cluster. For more information, see [Installing a cluster on GCP with customizations](#).

### 8.4.2. Internet access for OpenShift Container Platform

In OpenShift Container Platform 4.10, you require access to the internet to install your cluster.

You must have internet access to:

- Access [OpenShift Cluster Manager](#) to download the installation program and perform subscription management. If the cluster has internet access and you do not disable Telemetry, that service automatically entitles your cluster.
- Access [Quay.io](#) to obtain the packages that are required to install your cluster.
- Obtain the packages that are required to perform cluster updates.

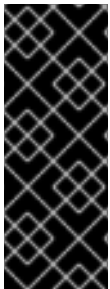

#### IMPORTANT

If your cluster cannot have direct internet access, you can perform a restricted network installation on some types of infrastructure that you provision. During that process, you download the required content and use it to populate a mirror registry with the installation packages. With some installation types, the environment that you install your cluster in will not require internet access. Before you update the cluster, you update the content of the mirror registry.

### 8.4.3. Generating a key pair for cluster node SSH access

During an OpenShift Container Platform installation, you can provide an SSH public key to the installation program. The key is passed to the Red Hat Enterprise Linux CoreOS (RHCOS) nodes through their Ignition config files and is used to authenticate SSH access to the nodes. The key is added to the `~/.ssh/authorized_keys` list for the **core** user on each node, which enables password-less authentication.

After the key is passed to the nodes, you can use the key pair to SSH in to the RHCOS nodes as the user **core**. To access the nodes through SSH, the private key identity must be managed by SSH for your local user.

If you want to SSH in to your cluster nodes to perform installation debugging or disaster recovery, you must provide the SSH public key during the installation process. The **./openshift-install gather** command also requires the SSH public key to be in place on the cluster nodes.

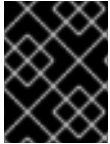
**IMPORTANT**

Do not skip this procedure in production environments, where disaster recovery and debugging is required.

**NOTE**

You must use a local key, not one that you configured with platform-specific approaches such as [AWS key pairs](#).

**Procedure**

1. If you do not have an existing SSH key pair on your local machine to use for authentication onto your cluster nodes, create one. For example, on a computer that uses a Linux operating system, run the following command:

```
$ ssh-keygen -t ed25519 -N "" -f <path>/<file_name> 1
```

- 1 Specify the path and file name, such as `~/.ssh/id_ed25519`, of the new SSH key. If you have an existing key pair, ensure your public key is in the your `~/.ssh` directory.

**NOTE**

If you plan to install an OpenShift Container Platform cluster that uses FIPS validated or Modules In Process cryptographic libraries on the **x86\_64** architecture, do not create a key that uses the **ed25519** algorithm. Instead, create a key that uses the **rsa** or **ecdsa** algorithm.

2. View the public SSH key:

```
$ cat <path>/<file_name>.pub
```

For example, run the following to view the `~/.ssh/id_ed25519.pub` public key:

```
$ cat ~/.ssh/id_ed25519.pub
```

3. Add the SSH private key identity to the SSH agent for your local user, if it has not already been added. SSH agent management of the key is required for password-less SSH authentication onto your cluster nodes, or if you want to use the `./openshift-install gather` command.

**NOTE**

On some distributions, default SSH private key identities such as `~/.ssh/id_rsa` and `~/.ssh/id_dsa` are managed automatically.

- a. If the **ssh-agent** process is not already running for your local user, start it as a background task:

```
$ eval "$(ssh-agent -s)"
```

**Example output**

```
Agent pid 31874
```

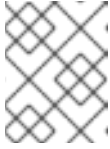
**NOTE**

If your cluster is in FIPS mode, only use FIPS-compliant algorithms to generate the SSH key. The key must be either RSA or ECDSA.

4. Add your SSH private key to the **ssh-agent**:

```
$ ssh-add <path>/<file_name> 1
```

- 1** Specify the path and file name for your SSH private key, such as `~/.ssh/id_ed25519`

**Example output**

```
Identity added: /home/<you>/<path>/<file_name> (<computer_name>)
```

5. Set the **GOOGLE\_APPLICATION\_CREDENTIALS** environment variable to the full path to your service account private key file.

```
$ export GOOGLE_APPLICATION_CREDENTIALS="<your_service_account_file>"
```

6. Verify that the credentials were applied.

```
$ gcloud auth list
```

**Next steps**

- When you install OpenShift Container Platform, provide the SSH public key to the installation program.

**8.4.4. Obtaining the installation program**

Before you install OpenShift Container Platform, download the installation file on a local computer.

**Prerequisites**

- You have a computer that runs Linux or macOS, with 500 MB of local disk space

**Procedure**

1. Access the [Infrastructure Provider](#) page on the OpenShift Cluster Manager site. If you have a Red Hat account, log in with your credentials. If you do not, create an account.
2. Select your infrastructure provider.
3. Navigate to the page for your installation type, download the installation program that corresponds with your host operating system and architecture, and place the file in the directory where you will store the installation configuration files.

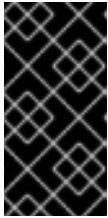

### IMPORTANT

The installation program creates several files on the computer that you use to install your cluster. You must keep the installation program and the files that the installation program creates after you finish installing the cluster. Both files are required to delete the cluster.



### IMPORTANT

Deleting the files created by the installation program does not remove your cluster, even if the cluster failed during installation. To remove your cluster, complete the OpenShift Container Platform uninstallation procedures for your specific cloud provider.

4. Extract the installation program. For example, on a computer that uses a Linux operating system, run the following command:

```
$ tar -xvf openshift-install-linux.tar.gz
```

5. Download your installation [pull secret from the Red Hat OpenShift Cluster Manager](#) . This pull secret allows you to authenticate with the services that are provided by the included authorities, including Quay.io, which serves the container images for OpenShift Container Platform components.

## 8.4.5. Deploying the cluster

You can install OpenShift Container Platform on a compatible cloud platform.

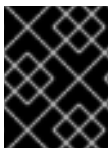

### IMPORTANT

You can run the **create cluster** command of the installation program only once, during initial installation.

### Prerequisites

- Configure an account with the cloud platform that hosts your cluster.
- Obtain the OpenShift Container Platform installation program and the pull secret for your cluster.

### Procedure

1. Remove any existing GCP credentials that do not use the service account key for the GCP account that you configured for your cluster and that are stored in the following locations:
  - The **GOOGLE\_CREDENTIALS**, **GOOGLE\_CLOUD\_KEYFILE\_JSON**, or **GCPLOUD\_KEYFILE\_JSON** environment variables
  - The `~/.gcp/osServiceAccount.json` file
  - The **gcloud cli** default credentials
2. Change to the directory that contains the installation program and initialize the cluster deployment:  
-

```
$ ./openshift-install create cluster --dir <installation_directory> \ 1
--log-level=info 2
```

- 1** For **<installation\_directory>**, specify the directory name to store the files that the installation program creates.
- 2** To view different installation details, specify **warn**, **debug**, or **error** instead of **info**.

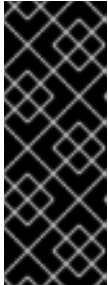

### IMPORTANT

Specify an empty directory. Some installation assets, like bootstrap X.509 certificates have short expiration intervals, so you must not reuse an installation directory. If you want to reuse individual files from another cluster installation, you can copy them into your directory. However, the file names for the installation assets might change between releases. Use caution when copying installation files from an earlier OpenShift Container Platform version.

Provide values at the prompts:

- a. Optional: Select an SSH key to use to access your cluster machines.



### NOTE

For production OpenShift Container Platform clusters on which you want to perform installation debugging or disaster recovery, specify an SSH key that your **ssh-agent** process uses.

- b. Select **gcp** as the platform to target.
- c. If you have not configured the service account key for your GCP account on your computer, you must obtain it from GCP and paste the contents of the file or enter the absolute path to the file.
- d. Select the project ID to provision the cluster in. The default value is specified by the service account that you configured.
- e. Select the region to deploy the cluster to.
- f. Select the base domain to deploy the cluster to. The base domain corresponds to the public DNS zone that you created for your cluster.
- g. Enter a descriptive name for your cluster. If you provide a name that is longer than 6 characters, only the first 6 characters will be used in the infrastructure ID that is generated from the cluster name.
- h. Paste the [pull secret from the Red Hat OpenShift Cluster Manager](#) .



### NOTE

If the cloud provider account that you configured on your host does not have sufficient permissions to deploy the cluster, the installation process stops, and the missing permissions are displayed.

When the cluster deployment completes, directions for accessing your cluster, including a link to its web console and credentials for the **kubeadmin** user, display in your terminal.

### Example output

```
...
INFO Install complete!
INFO To access the cluster as the system:admin user when using 'oc', run 'export
KUBECONFIG=/home/myuser/install_dir/auth/kubeconfig'
INFO Access the OpenShift web-console here: https://console-openshift-
console.apps.mycluster.example.com
INFO Login to the console with user: "kubeadmin", and password: "4vYBz-Ee6gm-ymBZj-
Wt5AL"
INFO Time elapsed: 36m22s
```



### NOTE

The cluster access and credential information also outputs to **<installation\_directory>/openshift\_install.log** when an installation succeeds.

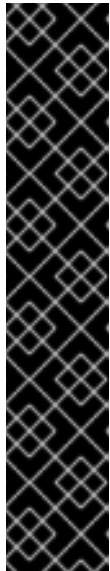

### IMPORTANT

- The Ignition config files that the installation program generates contain certificates that expire after 24 hours, which are then renewed at that time. If the cluster is shut down before renewing the certificates and the cluster is later restarted after the 24 hours have elapsed, the cluster automatically recovers the expired certificates. The exception is that you must manually approve the pending **node-bootstrapper** certificate signing requests (CSRs) to recover kubelet certificates. See the documentation for *Recovering from expired control plane certificates* for more information.
- It is recommended that you use Ignition config files within 12 hours after they are generated because the 24-hour certificate rotates from 16 to 22 hours after the cluster is installed. By using the Ignition config files within 12 hours, you can avoid installation failure if the certificate update runs during installation.



### IMPORTANT

You must not delete the installation program or the files that the installation program creates. Both are required to delete the cluster.

- Optional: You can reduce the number of permissions for the service account that you used to install the cluster.
  - If you assigned the **Owner** role to your service account, you can remove that role and replace it with the **Viewer** role.
  - If you included the **Service Account Key Admin** role, you can remove it.

## 8.4.6. Installing the OpenShift CLI by downloading the binary

You can install the OpenShift CLI (**oc**) to interact with OpenShift Container Platform from a command-line interface. You can install **oc** on Linux, Windows, or macOS.



## IMPORTANT

If you installed an earlier version of **oc**, you cannot use it to complete all of the commands in OpenShift Container Platform 4.10. Download and install the new version of **oc**.

### Installing the OpenShift CLI on Linux

You can install the OpenShift CLI (**oc**) binary on Linux by using the following procedure.

#### Procedure

1. Navigate to the [OpenShift Container Platform downloads page](#) on the Red Hat Customer Portal.
2. Select the appropriate version in the **Version** drop-down menu.
3. Click **Download Now** next to the **OpenShift v4.10 Linux Client** entry and save the file.
4. Unpack the archive:

```
$ tar xvf <file>
```

5. Place the **oc** binary in a directory that is on your **PATH**.  
To check your **PATH**, execute the following command:

```
$ echo $PATH
```

After you install the OpenShift CLI, it is available using the **oc** command:

```
$ oc <command>
```

### Installing the OpenShift CLI on Windows

You can install the OpenShift CLI (**oc**) binary on Windows by using the following procedure.

#### Procedure

1. Navigate to the [OpenShift Container Platform downloads page](#) on the Red Hat Customer Portal.
2. Select the appropriate version in the **Version** drop-down menu.
3. Click **Download Now** next to the **OpenShift v4.10 Windows Client** entry and save the file.
4. Unzip the archive with a ZIP program.
5. Move the **oc** binary to a directory that is on your **PATH**.  
To check your **PATH**, open the command prompt and execute the following command:

```
C:\> path
```

After you install the OpenShift CLI, it is available using the **oc** command:

```
C:\> oc <command>
```

## Installing the OpenShift CLI on macOS

You can install the OpenShift CLI (**oc**) binary on macOS by using the following procedure.

### Procedure

1. Navigate to the [OpenShift Container Platform downloads page](#) on the Red Hat Customer Portal.
2. Select the appropriate version in the **Version** drop-down menu.
3. Click **Download Now** next to the **OpenShift v4.10 MacOSX Client** entry and save the file.
4. Unpack and unzip the archive.
5. Move the **oc** binary to a directory on your PATH.  
To check your **PATH**, open a terminal and execute the following command:

```
$ echo $PATH
```

After you install the OpenShift CLI, it is available using the **oc** command:

```
$ oc <command>
```

### 8.4.7. Logging in to the cluster by using the CLI

You can log in to your cluster as a default system user by exporting the cluster **kubeconfig** file. The **kubeconfig** file contains information about the cluster that is used by the CLI to connect a client to the correct cluster and API server. The file is specific to a cluster and is created during OpenShift Container Platform installation.

#### Prerequisites

- You deployed an OpenShift Container Platform cluster.
- You installed the **oc** CLI.

#### Procedure

1. Export the **kubeadmin** credentials:

```
$ export KUBECONFIG=<installation_directory>/auth/kubeconfig 1
```

- 1** For **<installation\_directory>**, specify the path to the directory that you stored the installation files in.

2. Verify you can run **oc** commands successfully using the exported configuration:

```
$ oc whoami
```

#### Example output

```
system:admin
```



### Additional resources

- See [Accessing the web console](#) for more details about accessing and understanding the OpenShift Container Platform web console.

## 8.4.8. Telemetry access for OpenShift Container Platform

In OpenShift Container Platform 4.10, the Telemetry service, which runs by default to provide metrics about cluster health and the success of updates, requires internet access. If your cluster is connected to the internet, Telemetry runs automatically, and your cluster is registered to [OpenShift Cluster Manager](#).

After you confirm that your [OpenShift Cluster Manager](#) inventory is correct, either maintained automatically by Telemetry or manually by using OpenShift Cluster Manager, [use subscription watch](#) to track your OpenShift Container Platform subscriptions at the account or multi-cluster level.

### Additional resources

- See [About remote health monitoring](#) for more information about the Telemetry service

## 8.4.9. Next steps

- [Customize your cluster](#).
- If necessary, you can [opt out of remote health reporting](#).

# 8.5. INSTALLING A CLUSTER ON GCP WITH CUSTOMIZATIONS

In OpenShift Container Platform version 4.10, you can install a customized cluster on infrastructure that the installation program provisions on Google Cloud Platform (GCP). To customize the installation, you modify parameters in the `install-config.yaml` file before you install the cluster.

## 8.5.1. Prerequisites

- You reviewed details about the [OpenShift Container Platform installation and update](#) processes.
- You read the documentation on [selecting a cluster installation method and preparing it for users](#).
- You [configured a GCP project](#) to host the cluster.
- If you use a firewall, you [configured it to allow the sites](#) that your cluster requires access to.
- If the cloud identity and access management (IAM) APIs are not accessible in your environment, or if you do not want to store an administrator-level credential secret in the `kube-system` namespace, you can [manually create and maintain IAM credentials](#).

## 8.5.2. Internet access for OpenShift Container Platform

In OpenShift Container Platform 4.10, you require access to the internet to install your cluster.

You must have internet access to:

- Access [OpenShift Cluster Manager](#) to download the installation program and perform subscription management. If the cluster has internet access and you do not disable Telemetry, that service automatically entitles your cluster.
- Access [Quay.io](#) to obtain the packages that are required to install your cluster.
- Obtain the packages that are required to perform cluster updates.

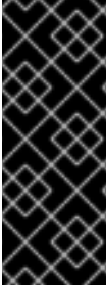

### IMPORTANT

If your cluster cannot have direct internet access, you can perform a restricted network installation on some types of infrastructure that you provision. During that process, you download the required content and use it to populate a mirror registry with the installation packages. With some installation types, the environment that you install your cluster in will not require internet access. Before you update the cluster, you update the content of the mirror registry.

### 8.5.3. Generating a key pair for cluster node SSH access

During an OpenShift Container Platform installation, you can provide an SSH public key to the installation program. The key is passed to the Red Hat Enterprise Linux CoreOS (RHCOS) nodes through their Ignition config files and is used to authenticate SSH access to the nodes. The key is added to the `~/.ssh/authorized_keys` list for the **core** user on each node, which enables password-less authentication.

After the key is passed to the nodes, you can use the key pair to SSH in to the RHCOS nodes as the user **core**. To access the nodes through SSH, the private key identity must be managed by SSH for your local user.

If you want to SSH in to your cluster nodes to perform installation debugging or disaster recovery, you must provide the SSH public key during the installation process. The `./openshift-install gather` command also requires the SSH public key to be in place on the cluster nodes.



### IMPORTANT

Do not skip this procedure in production environments, where disaster recovery and debugging is required.



### NOTE

You must use a local key, not one that you configured with platform-specific approaches such as [AWS key pairs](#).

### Procedure

1. If you do not have an existing SSH key pair on your local machine to use for authentication onto your cluster nodes, create one. For example, on a computer that uses a Linux operating system, run the following command:

```
$ ssh-keygen -t ed25519 -N "" -f <path>/<file_name> 1
```

- 1 Specify the path and file name, such as `~/.ssh/id_ed25519`, of the new SSH key. If you have an existing key pair, ensure your public key is in the your `~/.ssh` directory.

**NOTE**

If you plan to install an OpenShift Container Platform cluster that uses FIPS validated or Modules In Process cryptographic libraries on the **x86\_64** architecture, do not create a key that uses the **ed25519** algorithm. Instead, create a key that uses the **rsa** or **ecdsa** algorithm.

2. View the public SSH key:

```
$ cat <path>/<file_name>.pub
```

For example, run the following to view the `~/.ssh/id_ed25519.pub` public key:

```
$ cat ~/.ssh/id_ed25519.pub
```

3. Add the SSH private key identity to the SSH agent for your local user, if it has not already been added. SSH agent management of the key is required for password-less SSH authentication onto your cluster nodes, or if you want to use the `./openshift-install gather` command.

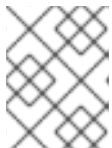
**NOTE**

On some distributions, default SSH private key identities such as `~/.ssh/id_rsa` and `~/.ssh/id_dsa` are managed automatically.

- a. If the **ssh-agent** process is not already running for your local user, start it as a background task:

```
$ eval "$(ssh-agent -s)"
```

**Example output**

```
Agent pid 31874
```

**NOTE**

If your cluster is in FIPS mode, only use FIPS-compliant algorithms to generate the SSH key. The key must be either RSA or ECDSA.

4. Add your SSH private key to the **ssh-agent**:

```
$ ssh-add <path>/<file_name> 1
```

- 1** Specify the path and file name for your SSH private key, such as `~/.ssh/id_ed25519`

**Example output**

```
Identity added: /home/<you>/<path>/<file_name> (<computer_name>)
```

5. Set the **GOOGLE\_APPLICATION\_CREDENTIALS** environment variable to the full path to your service account private key file.

```
$ export GOOGLE_APPLICATION_CREDENTIALS="<your_service_account_file>"
```

6. Verify that the credentials were applied.

```
$ gcloud auth list
```

### Next steps

- When you install OpenShift Container Platform, provide the SSH public key to the installation program.

## 8.5.4. Obtaining the installation program

Before you install OpenShift Container Platform, download the installation file on a local computer.

### Prerequisites

- You have a computer that runs Linux or macOS, with 500 MB of local disk space

### Procedure

1. Access the [Infrastructure Provider](#) page on the OpenShift Cluster Manager site. If you have a Red Hat account, log in with your credentials. If you do not, create an account.
2. Select your infrastructure provider.
3. Navigate to the page for your installation type, download the installation program that corresponds with your host operating system and architecture, and place the file in the directory where you will store the installation configuration files.

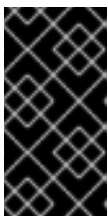

#### IMPORTANT

The installation program creates several files on the computer that you use to install your cluster. You must keep the installation program and the files that the installation program creates after you finish installing the cluster. Both files are required to delete the cluster.

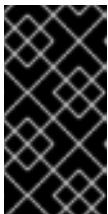

#### IMPORTANT

Deleting the files created by the installation program does not remove your cluster, even if the cluster failed during installation. To remove your cluster, complete the OpenShift Container Platform uninstallation procedures for your specific cloud provider.

4. Extract the installation program. For example, on a computer that uses a Linux operating system, run the following command:

```
$ tar -xvf openshift-install-linux.tar.gz
```

5. Download your installation [pull secret from the Red Hat OpenShift Cluster Manager](#) . This pull secret allows you to authenticate with the services that are provided by the included authorities, including Quay.io, which serves the container images for OpenShift Container Platform components.

## 8.5.5. Creating the installation configuration file

You can customize the OpenShift Container Platform cluster you install on Google Cloud Platform (GCP).

### Prerequisites

- Obtain the OpenShift Container Platform installation program and the pull secret for your cluster.
- Obtain service principal permissions at the subscription level.

### Procedure

1. Create the **install-config.yaml** file.
  - a. Change to the directory that contains the installation program and run the following command:

```
$ ./openshift-install create install-config --dir <installation_directory> 1
```

- 1** For **<installation\_directory>**, specify the directory name to store the files that the installation program creates.



### IMPORTANT

Specify an empty directory. Some installation assets, like bootstrap X.509 certificates have short expiration intervals, so you must not reuse an installation directory. If you want to reuse individual files from another cluster installation, you can copy them into your directory. However, the file names for the installation assets might change between releases. Use caution when copying installation files from an earlier OpenShift Container Platform version.

- b. At the prompts, provide the configuration details for your cloud:
  - i. Optional: Select an SSH key to use to access your cluster machines.



### NOTE

For production OpenShift Container Platform clusters on which you want to perform installation debugging or disaster recovery, specify an SSH key that your **ssh-agent** process uses.

- ii. Select **gcp** as the platform to target.
- iii. If you have not configured the service account key for your GCP account on your computer, you must obtain it from GCP and paste the contents of the file or enter the absolute path to the file.
- iv. Select the project ID to provision the cluster in. The default value is specified by the service account that you configured.
- v. Select the region to deploy the cluster to.

- vi. Select the base domain to deploy the cluster to. The base domain corresponds to the public DNS zone that you created for your cluster.
  - vii. Enter a descriptive name for your cluster.
  - viii. Paste the [pull secret from the Red Hat OpenShift Cluster Manager](#) .
2. Modify the **install-config.yaml** file. You can find more information about the available parameters in the "Installation configuration parameters" section.
  3. Back up the **install-config.yaml** file so that you can use it to install multiple clusters.

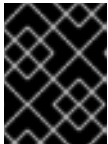

### IMPORTANT

The **install-config.yaml** file is consumed during the installation process. If you want to reuse the file, you must back it up now.

#### 8.5.5.1. Installation configuration parameters

Before you deploy an OpenShift Container Platform cluster, you provide parameter values to describe your account on the cloud platform that hosts your cluster and optionally customize your cluster's platform. When you create the **install-config.yaml** installation configuration file, you provide values for the required parameters through the command line. If you customize your cluster, you can modify the **install-config.yaml** file to provide more details about the platform.

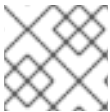

### NOTE

After installation, you cannot modify these parameters in the **install-config.yaml** file.

##### 8.5.5.1.1. Required configuration parameters

Required installation configuration parameters are described in the following table:

Table 8.5. Required parameters

Parameter	Description	Values
<b>apiVersion</b>	The API version for the <b>install-config.yaml</b> content. The current version is <b>v1</b> . The installer may also support older API versions.	String

Parameter	Description	Values
<b>baseDomain</b>	The base domain of your cloud provider. The base domain is used to create routes to your OpenShift Container Platform cluster components. The full DNS name for your cluster is a combination of the <b>baseDomain</b> and <b>metadata.name</b> parameter values that uses the <b>&lt;metadata.name&gt;</b> . <b>&lt;baseDomain&gt;</b> format.	A fully-qualified domain or subdomain name, such as <b>example.com</b> .
<b>metadata</b>	Kubernetes resource <b>ObjectMeta</b> , from which only the <b>name</b> parameter is consumed.	Object
<b>metadata.name</b>	The name of the cluster. DNS records for the cluster are all subdomains of <b>{{.metadata.name}}</b> . <b>{{.baseDomain}}</b> .	String of lowercase letters, hyphens (-), and periods (.), such as <b>dev</b> .
<b>platform</b>	The configuration for the specific platform upon which to perform the installation: <b>alibabacloud</b> , <b>aws</b> , <b>baremetal</b> , <b>azure</b> , <b>gcp</b> , <b>ibmcloud</b> , <b>openstack</b> , <b>ovirt</b> , <b>vsphere</b> , or <b>{}</b> . For additional information about <b>platform.&lt;platform&gt;</b> parameters, consult the table for your specific platform that follows.	Object

Parameter	Description	Values
<b>pullSecret</b>	Get a <a href="#">pull secret from the Red Hat OpenShift Cluster Manager</a> to authenticate downloading container images for OpenShift Container Platform components from services such as Quay.io.	<pre>{   "auths":{     "cloud.openshift.com":{       "auth":"b3Blb=",       "email":"you@example.com"     },     "quay.io":{       "auth":"b3Blb=",       "email":"you@example.com"     }   } }</pre>

### 8.5.5.1.2. Network configuration parameters

You can customize your installation configuration based on the requirements of your existing network infrastructure. For example, you can expand the IP address block for the cluster network or provide different IP address blocks than the defaults.

Only IPv4 addresses are supported.

Table 8.6. Network parameters

Parameter	Description	Values
<b>networking</b>	The configuration for the cluster network.	Object  <p><b>NOTE</b></p> <p>You cannot modify parameters specified by the <b>networking</b> object after installation.</p>
<b>networking.networkType</b>	The cluster network provider Container Network Interface (CNI) plugin to install.	Either <b>OpenShiftSDN</b> or <b>OVNKubernetes</b> . <b>OpenShiftSDN</b> is a CNI provider for all-Linux networks. <b>OVNKubernetes</b> is a CNI provider for Linux networks and hybrid networks that contain both Linux and Windows servers. The default value is <b>OpenShiftSDN</b> .



Parameter	Description	Values
<b>networking.clusterNetwork</b>	<p>The IP address blocks for pods.</p> <p>The default value is <b>10.128.0.0/14</b> with a host prefix of <b>/23</b>.</p> <p>If you specify multiple IP address blocks, the blocks must not overlap.</p>	<p>An array of objects. For example:</p> <pre>networking:   clusterNetwork:     - cidr: 10.128.0.0/14       hostPrefix: 23</pre>
<b>networking.clusterNetwork.cidr</b>	<p>Required if you use <b>networking.clusterNetwork</b>. An IP address block.</p> <p>An IPv4 network.</p>	<p>An IP address block in Classless Inter-Domain Routing (CIDR) notation. The prefix length for an IPv4 block is between <b>0</b> and <b>32</b>.</p>
<b>networking.clusterNetwork.hostPrefix</b>	<p>The subnet prefix length to assign to each individual node. For example, if <b>hostPrefix</b> is set to <b>23</b> then each node is assigned a <b>/23</b> subnet out of the given <b>cidr</b>. A <b>hostPrefix</b> value of <b>23</b> provides 510 (<math>2^{(32 - 23)} - 2</math>) pod IP addresses.</p>	<p>A subnet prefix.</p> <p>The default value is <b>23</b>.</p>
<b>networking.serviceNetwork</b>	<p>The IP address block for services. The default value is <b>172.30.0.0/16</b>.</p> <p>The OpenShift SDN and OVN-Kubernetes network providers support only a single IP address block for the service network.</p>	<p>An array with an IP address block in CIDR format. For example:</p> <pre>networking:   serviceNetwork:     - 172.30.0.0/16</pre>
<b>networking.machineNetwork</b>	<p>The IP address blocks for machines.</p> <p>If you specify multiple IP address blocks, the blocks must not overlap.</p>	<p>An array of objects. For example:</p> <pre>networking:   machineNetwork:     - cidr: 10.0.0.0/16</pre>
<b>networking.machineNetwork.cidr</b>	<p>Required if you use <b>networking.machineNetwork</b>. An IP address block. The default value is <b>10.0.0.0/16</b> for all platforms other than libvirt. For libvirt, the default value is <b>192.168.126.0/24</b>.</p>	<p>An IP network block in CIDR notation.</p> <p>For example, <b>10.0.0.0/16</b>.</p> <div style="display: flex; align-items: flex-start;">  <div> <p><b>NOTE</b></p> <p>Set the <b>networking.machineNetwork</b> to match the CIDR that the preferred NIC resides in.</p> </div> </div>



## 8.5.5.1.3. Optional configuration parameters

Optional installation configuration parameters are described in the following table:

Table 8.7. Optional parameters

Parameter	Description	Values
<b>additionalTrustBundle</b>	A PEM-encoded X.509 certificate bundle that is added to the nodes' trusted certificate store. This trust bundle may also be used when a proxy has been configured.	String
<b>cgroupsV2</b>	Enables <a href="#">Linux control groups version 2</a> (cgroups v2) on specific nodes in your cluster. The OpenShift Container Platform process for enabling cgroups v2 disables all cgroup version 1 controllers and hierarchies. The OpenShift Container Platform cgroups version 2 feature is in Developer Preview and is not supported by Red Hat at this time.	<b>true</b>
<b>compute</b>	The configuration for the machines that comprise the compute nodes.	Array of <b>MachinePool</b> objects.
<b>compute.architecture</b>	Determines the instruction set architecture of the machines in the pool. Currently, clusters with varied architectures are not supported. All pools must specify the same architecture. Valid values are <b>amd64</b> (the default).	String
<b>compute.hyperthreading</b>	Whether to enable or disable simultaneous multithreading, or <b>hyperthreading</b> , on compute machines. By default, simultaneous multithreading is enabled to increase the performance of your machines' cores.	<b>Enabled</b> or <b>Disabled</b>
	 <p><b>IMPORTANT</b></p> <p>If you disable simultaneous multithreading, ensure that your capacity planning accounts for the dramatically decreased machine performance.</p>	

Parameter	Description	Values
<b>compute.name</b>	Required if you use <b>compute</b> . The name of the machine pool.	<b>worker</b>
<b>compute.platform</b>	Required if you use <b>compute</b> . Use this parameter to specify the cloud provider to host the worker machines. This parameter value must match the <b>controlPlane.platform</b> parameter value.	<b>alibabacloud, aws, azure, gcp, ibmcloud, openstack, ovirt, vsphere</b> , or <b>{}</b>
<b>compute.replicas</b>	The number of compute machines, which are also known as worker machines, to provision.	A positive integer greater than or equal to <b>2</b> . The default value is <b>3</b> .
<b>controlPlane</b>	The configuration for the machines that comprise the control plane.	Array of <b>MachinePool</b> objects.
<b>controlPlane.architecture</b>	Determines the instruction set architecture of the machines in the pool. Currently, clusters with varied architectures are not supported. All pools must specify the same architecture. Valid values are <b>amd64</b> (the default).	String
<b>controlPlane.hyperthreading</b>	<p>Whether to enable or disable simultaneous multithreading, or <b>hyperthreading</b>, on control plane machines. By default, simultaneous multithreading is enabled to increase the performance of your machines' cores.</p> <div data-bbox="485 1469 592 1787" style="background-color: black; width: 67px; height: 142px; margin-bottom: 10px;"></div> <p><b>IMPORTANT</b></p> <p>If you disable simultaneous multithreading, ensure that your capacity planning accounts for the dramatically decreased machine performance.</p>	<b>Enabled</b> or <b>Disabled</b>
<b>controlPlane.name</b>	Required if you use <b>controlPlane</b> . The name of the machine pool.	<b>master</b>

Parameter	Description	Values
<b>controlPlane.platform</b>	Required if you use <b>controlPlane</b> . Use this parameter to specify the cloud provider that hosts the control plane machines. This parameter value must match the <b>compute.platform</b> parameter value.	<b>alibabacloud, aws, azure, gcp, ibmcloud, openstack, ovirt, vsphere</b> , or {}
<b>controlPlane.replicas</b>	The number of control plane machines to provision.	The only supported value is <b>3</b> , which is the default value.
<b>credentialsMode</b>	<p>The Cloud Credential Operator (CCO) mode. If no mode is specified, the CCO dynamically tries to determine the capabilities of the provided credentials, with a preference for mint mode on the platforms where multiple modes are supported. If you are installing on GCP into a shared virtual private cloud (VPC), <b>credentialsMode</b> must be set to <b>Passthrough</b>.</p> <p> <b>NOTE</b></p> <p>Not all CCO modes are supported for all cloud providers. For more information on CCO modes, see the <i>Cloud Credential Operator</i> entry in the <i>Cluster Operators reference</i> content.</p> <p> <b>NOTE</b></p> <p>If your AWS account has service control policies (SCP) enabled, you must configure the <b>credentialsMode</b> parameter to <b>Mint</b>, <b>Passthrough</b> or <b>Manual</b>.</p>	<b>Mint, Passthrough, Manual</b> or an empty string ("").

Parameter	Description	Values
<b>fips</b>	<p>Enable or disable FIPS mode. The default is <b>false</b> (disabled). If FIPS mode is enabled, the Red Hat Enterprise Linux CoreOS (RHCOS) machines that OpenShift Container Platform runs on bypass the default Kubernetes cryptography suite and use the cryptography modules that are provided with RHCOS instead.</p> <div data-bbox="486 586 592 1361" style="background-color: black; width: 66px; height: 346px; margin-bottom: 10px;"></div> <p><b>IMPORTANT</b></p> <p>To enable FIPS mode for your cluster, you must run the installation program from a Red Hat Enterprise Linux (RHEL) computer configured to operate in FIPS mode. For more information about configuring FIPS mode on RHEL, see <a href="#">Installing the system in FIPS mode</a>. The use of FIPS validated or Modules In Process cryptographic libraries is only supported on OpenShift Container Platform deployments on the <b>x86_64</b> architecture.</p> <div data-bbox="486 1406 592 1608" style="background-color: black; width: 66px; height: 90px; margin-bottom: 10px;"></div> <p><b>NOTE</b></p> <p>If you are using Azure File storage, you cannot enable FIPS mode.</p>	<b>false</b> or <b>true</b>
<b>imageContentSources</b>	Sources and repositories for the release-image content.	Array of objects. Includes a <b>source</b> and, optionally, <b>mirrors</b> , as described in the following rows of this table.

Parameter	Description	Values
<b>imageContentSources.source</b>	Required if you use <b>imageContentSources</b> . Specify the repository that users refer to, for example, in image pull specifications.	String
<b>imageContentSources.mirrors</b>	Specify one or more repositories that may also contain the same images.	Array of strings
<b>publish</b>	How to publish or expose the user-facing endpoints of your cluster, such as the Kubernetes API, OpenShift routes.	<b>Internal</b> or <b>External</b> . To deploy a private cluster, which cannot be accessed from the internet, set <b>publish</b> to <b>Internal</b> . The default value is <b>External</b> .
<b>sshKey</b>	<p>The SSH key or keys to authenticate access your cluster machines.</p>  <p><b>NOTE</b></p> <p>For production OpenShift Container Platform clusters on which you want to perform installation debugging or disaster recovery, specify an SSH key that your <b>ssh-agent</b> process uses.</p>	<p>One or more keys. For example:</p> <pre>sshKey:   &lt;key1&gt;   &lt;key2&gt;   &lt;key3&gt;</pre>

#### 8.5.5.1.4. Additional Google Cloud Platform (GCP) configuration parameters

Additional GCP configuration parameters are described in the following table:

**Table 8.8. Additional GCP parameters**

Parameter	Description	Values
<b>platform.gcp.network</b>	The name of the existing VPC that you want to deploy your cluster to.	String.
<b>platform.gcp.region</b>	The name of the GCP region that hosts your cluster.	Any valid region name, such as <b>us-central1</b> .
<b>platform.gcp.type</b>	The <a href="#">GCP machine type</a> .	The GCP machine type.
<b>platform.gcp.zones</b>	The availability zones where the installation program creates machines for the specified MachinePool.	A list of valid <a href="#">GCP availability zones</a> , such as <b>us-central1-a</b> , in a <a href="#">YAML sequence</a> .
<b>platform.gcp.controlPlaneSubnet</b>	The name of the existing subnet in your VPC that you want to deploy your control plane machines to.	The subnet name.
<b>platform.gcp.computeSubnet</b>	The name of the existing subnet in your VPC that you want to deploy your compute machines to.	The subnet name.
<b>platform.gcp.licenses</b>	<p>A list of license URLs that must be applied to the compute images.</p> <div style="display: flex; align-items: flex-start;">  <div> <p><b>IMPORTANT</b></p> <p>The <b>licenses</b> parameter is a deprecated field and nested virtualization is enabled by default. It is not recommended to use this field.</p> </div> </div>	Any license available with the <a href="#">license API</a> , such as the license to enable <a href="#">nested virtualization</a> . You cannot use this parameter with a mechanism that generates pre-built images. Using a license URL forces the installer to copy the source image before use.

Parameter	Description	Values
<code>platform.gcp.osDisk.SizeGB</code>	The size of the disk in gigabytes (GB).	Any size between 16 GB and 65536 GB.
<code>platform.gcp.osDisk.Type</code>	The type of disk.	Either the default <b>pd-ssd</b> or the <b>pd-standard</b> disk type. The control plane nodes must be the <b>pd-ssd</b> disk type. The worker nodes can be either type.
<code>controlplane.platform.gcp.osDisk.encryptionKey.kmsKeyName</code>	The name of the customer managed encryption key to be used for control plane machine disk encryption.	The encryption key name.
<code>controlplane.platform.gcp.osDisk.encryptionKey.kmsKeyRing</code>	For control plane machines, the name of the KMS key ring to which the KMS key belongs.	The KMS key ring name.
<code>controlplane.platform.gcp.osDisk.encryptionKey.kmsLocation</code>	For control plane machines, the GCP location in which the key ring exists. For more information on KMS locations, see Google's documentation on <a href="#">Cloud KMS locations</a> .	The GCP location for the key ring.



Parameter	Description	Values
<b>controlPlane.platform.gcp.osDisk.encryptionKey.kmsKey.projectID</b>	For control plane machines, the ID of the project in which the KMS key ring exists. This value defaults to the VM project ID if not set.	The GCP project ID.
<b>compute.platform.gcp.osDisk.encryptionKey.kmsKeyName</b>	The name of the customer managed encryption key to be used for compute machine disk encryption.	The encryption key name.
<b>compute.platform.gcp.osDisk.encryptionKey.kmsKey.keyRing</b>	For compute machines, the name of the KMS key ring to which the KMS key belongs.	The KMS key ring name.
<b>compute.platform.gcp.osDisk.encryptionKey.location</b>	For compute machines, the GCP location in which the key ring exists. For more information on KMS locations, see Google's documentation on <a href="#">Cloud KMS locations</a> .	The GCP location for the key ring.

Parameter	Description	Values
<code>compute.platform.gcp.ossDiskEncryptionKey.kmsKey.projectID</code>	For compute machines, the ID of the project in which the KMS key ring exists. This value defaults to the VM project ID if not set.	The GCP project ID.

### 8.5.5.2. Minimum resource requirements for cluster installation

Each cluster machine must meet the following minimum requirements:

**Table 8.9. Minimum resource requirements**

Machine	Operating System	vCPU [1]	Virtual RAM	Storage	IOPS [2]
Bootstrap	RHCOS	4	16 GB	100 GB	300
Control plane	RHCOS	4	16 GB	100 GB	300
Compute	RHCOS, RHEL 8.4, or RHEL 8.5 [3]	2	8 GB	100 GB	300

1. One vCPU is equivalent to one physical core when simultaneous multithreading (SMT), or hyperthreading, is not enabled. When enabled, use the following formula to calculate the corresponding ratio:  $(\text{threads per core} \times \text{cores}) \times \text{sockets} = \text{vCPUs}$ .
2. OpenShift Container Platform and Kubernetes are sensitive to disk performance, and faster storage is recommended, particularly for etcd on the control plane nodes which require a 10 ms p99 fsync duration. Note that on many cloud platforms, storage size and IOPS scale together, so you might need to over-allocate storage volume to obtain sufficient performance.
3. As with all user-provisioned installations, if you choose to use RHEL compute machines in your cluster, you take responsibility for all operating system life cycle management and maintenance, including performing system updates, applying patches, and completing all other required tasks. Use of RHEL 7 compute machines is deprecated and has been removed in OpenShift Container Platform 4.10 and later.

If an instance type for your platform meets the minimum requirements for cluster machines, it is supported to use in OpenShift Container Platform.

### 8.5.5.3. Tested instance types for GCP

The following Google Cloud Platform instance types have been tested with OpenShift Container Platform.

#### Example 8.21. Machine series

- C2
- C2D
- C3
- E2
- M1
- N1
- N2
- N2D
- Tau T2D

#### 8.5.5.4. Using custom machine types

Using a custom machine type to install a OpenShift Container Platform cluster is supported.

Consider the following when using a custom machine type:

- Similar to predefined instance types, custom machine types must meet the minimum resource requirements for control plane and compute machines. For more information, see "Minimum resource requirements for cluster installation".
- The name of the custom machine type must adhere to the following syntax:  
**custom-`<number_of_cpus>`-`<amount_of_memory_in_mb>`**

For example, **custom-6-20480**.

As part of the installation process, you specify the custom machine type in the **install-config.yaml** file.

#### Sample install-config.yaml file with a custom machine type

```
compute:
- architecture: amd64
  hyperthreading: Enabled
  name: worker
  platform:
    gcp:
      type: custom-6-20480
  replicas: 2
controlPlane:
  architecture: amd64
  hyperthreading: Enabled
  name: master
  platform:
```

```

gcp:
  type: custom-6-20480
  replicas: 3

```

### 8.5.5.5. Sample customized install-config.yaml file for GCP

You can customize the **install-config.yaml** file to specify more details about your OpenShift Container Platform cluster's platform or modify the values of the required parameters.



#### IMPORTANT

This sample YAML file is provided for reference only. You must obtain your **install-config.yaml** file by using the installation program and modify it.

```

apiVersion: v1
baseDomain: example.com 1
controlPlane: 2 3
  hyperthreading: Enabled 4
  name: master
  platform:
    gcp:
      type: n2-standard-4
      zones:
      - us-central1-a
      - us-central1-c
    osDisk:
      diskType: pd-ssd
      diskSizeGB: 1024
      encryptionKey: 5
      kmsKey:
        name: worker-key
        keyRing: test-machine-keys
        location: global
        projectID: project-id
  replicas: 3
compute: 6 7
  - hyperthreading: Enabled 8
  name: worker
  platform:
    gcp:
      type: n2-standard-4
      zones:
      - us-central1-a
      - us-central1-c
    osDisk:
      diskType: pd-standard
      diskSizeGB: 128
      encryptionKey: 9
      kmsKey:
        name: worker-key
        keyRing: test-machine-keys
        location: global
        projectID: project-id

```

```

replicas: 3
metadata:
  name: test-cluster 10
networking:
  clusterNetwork:
    - cidr: 10.128.0.0/14
      hostPrefix: 23
  machineNetwork:
    - cidr: 10.0.0.0/16
  networkType: OpenShiftSDN
  serviceNetwork:
    - 172.30.0.0/16
platform:
  gcp:
    projectID: openshift-production 11
    region: us-central1 12
  pullSecret: '{"auths": ...}' 13
  fips: false 14
  sshKey: ssh-ed25519 AAAA... 15

```

- 1 10 11 12 13** Required. The installation program prompts you for this value.
- 2 6** If you do not provide these parameters and values, the installation program provides the default value.
- 3 7** The **controlPlane** section is a single mapping, but the **compute** section is a sequence of mappings. To meet the requirements of the different data structures, the first line of the **compute** section must begin with a hyphen, -, and the first line of the **controlPlane** section must not. Only one control plane pool is used.
- 4 8** Whether to enable or disable simultaneous multithreading, or **hyperthreading**. By default, simultaneous multithreading is enabled to increase the performance of your machines' cores. You can disable it by setting the parameter value to **Disabled**. If you disable simultaneous multithreading in some cluster machines, you must disable it in all cluster machines.



### IMPORTANT

If you disable simultaneous multithreading, ensure that your capacity planning accounts for the dramatically decreased machine performance. Use larger machine types, such as **n1-standard-8**, for your machines if you disable simultaneous multithreading.

- 5 9** Optional: The custom encryption key section to encrypt both virtual machines and persistent volumes. Your default compute service account must have the permissions granted to use your KMS key and have the correct IAM role assigned. The default service account name follows the **service-<project\_number>@compute-system.iam.gserviceaccount.com** pattern. For more information on granting the correct permissions for your service account, see "Machine management" → "Creating machine sets" → "Creating a machine set on GCP".
- 14** Whether to enable or disable FIPS mode. By default, FIPS mode is not enabled. If FIPS mode is enabled, the Red Hat Enterprise Linux CoreOS (RHCOS) machines that OpenShift Container Platform runs on bypass the default Kubernetes cryptography suite and use the cryptography modules that are provided with RHCOS instead.



## IMPORTANT

To enable FIPS mode for your cluster, you must run the installation program from a Red Hat Enterprise Linux (RHEL) computer configured to operate in FIPS mode. For more information about configuring FIPS mode on RHEL, see [Installing the system in FIPS mode](#). The use of FIPS validated or Modules In Process cryptographic libraries is only supported on OpenShift Container Platform deployments on the **x86\_64** architecture.

15

You can optionally provide the **sshKey** value that you use to access the machines in your cluster.



## NOTE

For production OpenShift Container Platform clusters on which you want to perform installation debugging or disaster recovery, specify an SSH key that your **ssh-agent** process uses.

### Additional resources

- [Enabling customer-managed encryption keys for a machine set](#)

### 8.5.5.6. Configuring the cluster-wide proxy during installation

Production environments can deny direct access to the internet and instead have an HTTP or HTTPS proxy available. You can configure a new OpenShift Container Platform cluster to use a proxy by configuring the proxy settings in the **install-config.yaml** file.

### Prerequisites

- You have an existing **install-config.yaml** file.
- You reviewed the sites that your cluster requires access to and determined whether any of them need to bypass the proxy. By default, all cluster egress traffic is proxied, including calls to hosting cloud provider APIs. You added sites to the **Proxy** object's **spec.noProxy** field to bypass the proxy if necessary.



## NOTE

The **Proxy** object **status.noProxy** field is populated with the values of the **networking.machineNetwork[].cidr**, **networking.clusterNetwork[].cidr**, and **networking.serviceNetwork[]** fields from your installation configuration.

For installations on Amazon Web Services (AWS), Google Cloud Platform (GCP), Microsoft Azure, and Red Hat OpenStack Platform (RHOSP), the **Proxy** object **status.noProxy** field is also populated with the instance metadata endpoint (**169.254.169.254**).

### Procedure

1. Edit your **install-config.yaml** file and add the proxy settings. For example:

```
apiVersion: v1
baseDomain: my.domain.com
```

```

proxy:
  httpProxy: http://<username>:<pswd>@<ip>:<port> 1
  httpsProxy: https://<username>:<pswd>@<ip>:<port> 2
  noProxy: example.com 3
  additionalTrustBundle: | 4
    -----BEGIN CERTIFICATE-----
    <MY_TRUSTED_CA_CERT>
    -----END CERTIFICATE-----
  ...

```

- 1 A proxy URL to use for creating HTTP connections outside the cluster. The URL scheme must be **http**.
- 2 A proxy URL to use for creating HTTPS connections outside the cluster.
- 3 A comma-separated list of destination domain names, IP addresses, or other network CIDRs to exclude from proxying. Preface a domain with **.** to match subdomains only. For example, **.y.com** matches **x.y.com**, but not **y.com**. Use **\*** to bypass the proxy for all destinations.
- 4 If provided, the installation program generates a config map that is named **user-ca-bundle** in the **openshift-config** namespace that contains one or more additional CA certificates that are required for proxying HTTPS connections. The Cluster Network Operator then creates a **trusted-ca-bundle** config map that merges these contents with the Red Hat Enterprise Linux CoreOS (RHCOS) trust bundle, and this config map is referenced in the **trustedCA** field of the **Proxy** object. The **additionalTrustBundle** field is required unless the proxy's identity certificate is signed by an authority from the RHCOS trust bundle.

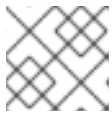

#### NOTE

The installation program does not support the proxy **readinessEndpoints** field.



#### NOTE

If the installer times out, restart and then complete the deployment by using the **wait-for** command of the installer. For example:

```
$ ./openshift-install wait-for install-complete --log-level debug
```

2. Save the file and reference it when installing OpenShift Container Platform.

The installation program creates a cluster-wide proxy that is named **cluster** that uses the proxy settings in the provided **install-config.yaml** file. If no proxy settings are provided, a **cluster Proxy** object is still created, but it will have a nil **spec**.



#### NOTE

Only the **Proxy** object named **cluster** is supported, and no additional proxies can be created.

### 8.5.6. Using a GCP Marketplace image

If you want to deploy an OpenShift Container Platform cluster using a GCP Marketplace image, you must create the manifests and edit the compute machine set definitions to specify the GCP Marketplace image.

## Prerequisites

- You have the OpenShift Container Platform installation program and the pull secret for your cluster.

## Procedure

1. Generate the installation manifests by running the following command:

```
$ openshift-install create manifests --dir <installation_dir>
```

2. Locate the following files:

- `<installation_dir>/openshift/99_openshift-cluster-api_worker-machineset-0.yaml`
- `<installation_dir>/openshift/99_openshift-cluster-api_worker-machineset-1.yaml`
- `<installation_dir>/openshift/99_openshift-cluster-api_worker-machineset-2.yaml`

3. In each file, edit the `.spec.template.spec.providerSpec.value.disks[0].image` property to reference the offer to use:

### OpenShift Container Platform

```
projects/redhat-marketplace-public/global/images/redhat-coreos-ocp-48-x86-64-202210040145
```

### OpenShift Platform Plus

```
projects/redhat-marketplace-public/global/images/redhat-coreos-opp-48-x86-64-202206140145
```

### OpenShift Kubernetes Engine

```
projects/redhat-marketplace-public/global/images/redhat-coreos-oke-48-x86-64-202206140145
```

## Example compute machine set with the GCP Marketplace image

```
deletionProtection: false
disks:
- autoDelete: true
  boot: true
  image: projects/redhat-marketplace-public/global/images/redhat-coreos-ocp-48-x86-64-202210040145
  labels: null
  sizeGb: 128
  type: pd-ssd
kind: GCPMachineProviderSpec
machineType: n2-standard-4
```

### 8.5.7. Deploying the cluster

You can install OpenShift Container Platform on a compatible cloud platform.



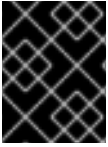

## IMPORTANT

You can run the **create cluster** command of the installation program only once, during initial installation.

### Prerequisites

- Configure an account with the cloud platform that hosts your cluster.
- Obtain the OpenShift Container Platform installation program and the pull secret for your cluster.

### Procedure

1. Remove any existing GCP credentials that do not use the service account key for the GCP account that you configured for your cluster and that are stored in the following locations:
  - The **GOOGLE\_CREDENTIALS**, **GOOGLE\_CLOUD\_KEYFILE\_JSON**, or **GCPLOUD\_KEYFILE\_JSON** environment variables
  - The `~/.gcp/osServiceAccount.json` file
  - The **gcloud cli** default credentials
2. Change to the directory that contains the installation program and initialize the cluster deployment:

```
$ ./openshift-install create cluster --dir <installation_directory> \ 1
--log-level=info 2
```

- 1 For `<installation_directory>`, specify the location of your customized `./install-config.yaml` file.
- 2 To view different installation details, specify **warn**, **debug**, or **error** instead of **info**.

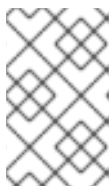

## NOTE

If the cloud provider account that you configured on your host does not have sufficient permissions to deploy the cluster, the installation process stops, and the missing permissions are displayed.

When the cluster deployment completes, directions for accessing your cluster, including a link to its web console and credentials for the **kubeadmin** user, display in your terminal.

### Example output

```
...
INFO Install complete!
INFO To access the cluster as the system:admin user when using 'oc', run 'export
KUBECONFIG=/home/myuser/install_dir/auth/kubeconfig'
INFO Access the OpenShift web-console here: https://console-openshift-
console.apps.mycluster.example.com
```

INFO Login to the console with user: "kubeadmin", and password: "4vYBz-Ee6gm-ymBZj-Wt5AL"  
 INFO Time elapsed: 36m22s



## NOTE

The cluster access and credential information also outputs to `<installation_directory>/openshift_install.log` when an installation succeeds.



## IMPORTANT

- The Ignition config files that the installation program generates contain certificates that expire after 24 hours, which are then renewed at that time. If the cluster is shut down before renewing the certificates and the cluster is later restarted after the 24 hours have elapsed, the cluster automatically recovers the expired certificates. The exception is that you must manually approve the pending **node-bootstrapper** certificate signing requests (CSRs) to recover kubelet certificates. See the documentation for *Recovering from expired control plane certificates* for more information.
- It is recommended that you use Ignition config files within 12 hours after they are generated because the 24-hour certificate rotates from 16 to 22 hours after the cluster is installed. By using the Ignition config files within 12 hours, you can avoid installation failure if the certificate update runs during installation.



## IMPORTANT

You must not delete the installation program or the files that the installation program creates. Both are required to delete the cluster.

- Optional: You can reduce the number of permissions for the service account that you used to install the cluster.
  - If you assigned the **Owner** role to your service account, you can remove that role and replace it with the **Viewer** role.
  - If you included the **Service Account Key Admin** role, you can remove it.

### 8.5.8. Installing the OpenShift CLI by downloading the binary

You can install the OpenShift CLI (**oc**) to interact with OpenShift Container Platform from a command-line interface. You can install **oc** on Linux, Windows, or macOS.



## IMPORTANT

If you installed an earlier version of **oc**, you cannot use it to complete all of the commands in OpenShift Container Platform 4.10. Download and install the new version of **oc**.

#### Installing the OpenShift CLI on Linux

You can install the OpenShift CLI (**oc**) binary on Linux by using the following procedure.

#### Procedure

1. Navigate to the [OpenShift Container Platform downloads page](#) on the Red Hat Customer Portal.
2. Select the appropriate version in the **Version** drop-down menu.
3. Click **Download Now** next to the **OpenShift v4.10 Linux Client** entry and save the file.
4. Unpack the archive:

```
$ tar xvf <file>
```

5. Place the **oc** binary in a directory that is on your **PATH**.  
To check your **PATH**, execute the following command:

```
$ echo $PATH
```

After you install the OpenShift CLI, it is available using the **oc** command:

```
$ oc <command>
```

### Installing the OpenShift CLI on Windows

You can install the OpenShift CLI (**oc**) binary on Windows by using the following procedure.

#### Procedure

1. Navigate to the [OpenShift Container Platform downloads page](#) on the Red Hat Customer Portal.
2. Select the appropriate version in the **Version** drop-down menu.
3. Click **Download Now** next to the **OpenShift v4.10 Windows Client** entry and save the file.
4. Unzip the archive with a ZIP program.
5. Move the **oc** binary to a directory that is on your **PATH**.  
To check your **PATH**, open the command prompt and execute the following command:

```
C:\> path
```

After you install the OpenShift CLI, it is available using the **oc** command:

```
C:\> oc <command>
```

### Installing the OpenShift CLI on macOS

You can install the OpenShift CLI (**oc**) binary on macOS by using the following procedure.

#### Procedure

1. Navigate to the [OpenShift Container Platform downloads page](#) on the Red Hat Customer Portal.
2. Select the appropriate version in the **Version** drop-down menu.
3. Click **Download Now** next to the **OpenShift v4.10 MacOSX Client** entry and save the file.

4. Unpack and unzip the archive.
5. Move the **oc** binary to a directory on your PATH.  
To check your **PATH**, open a terminal and execute the following command:

```
$ echo $PATH
```

After you install the OpenShift CLI, it is available using the **oc** command:

```
$ oc <command>
```

### 8.5.9. Logging in to the cluster by using the CLI

You can log in to your cluster as a default system user by exporting the cluster **kubeconfig** file. The **kubeconfig** file contains information about the cluster that is used by the CLI to connect a client to the correct cluster and API server. The file is specific to a cluster and is created during OpenShift Container Platform installation.

#### Prerequisites

- You deployed an OpenShift Container Platform cluster.
- You installed the **oc** CLI.

#### Procedure

1. Export the **kubeadmin** credentials:

```
$ export KUBECONFIG=<installation_directory>/auth/kubeconfig 1
```

- 1** For **<installation\_directory>**, specify the path to the directory that you stored the installation files in.

2. Verify you can run **oc** commands successfully using the exported configuration:

```
$ oc whoami
```

#### Example output

```
system:admin
```

#### Additional resources

- See [Accessing the web console](#) for more details about accessing and understanding the OpenShift Container Platform web console.

### 8.5.10. Telemetry access for OpenShift Container Platform

In OpenShift Container Platform 4.10, the Telemetry service, which runs by default to provide metrics about cluster health and the success of updates, requires internet access. If your cluster is connected to the internet, Telemetry runs automatically, and your cluster is registered to [OpenShift Cluster Manager](#).

After you confirm that your [OpenShift Cluster Manager](#) inventory is correct, either maintained automatically by Telemetry or manually by using OpenShift Cluster Manager, [use subscription watch](#) to track your OpenShift Container Platform subscriptions at the account or multi-cluster level.

### Additional resources

- See [About remote health monitoring](#) for more information about the Telemetry service

### 8.5.11. Next steps

- [Customize your cluster.](#)
- If necessary, you can [opt out of remote health reporting](#) .

## 8.6. INSTALLING A CLUSTER ON GCP WITH NETWORK CUSTOMIZATIONS

In OpenShift Container Platform version 4.10, you can install a cluster with a customized network configuration on infrastructure that the installation program provisions on Google Cloud Platform (GCP). By customizing your network configuration, your cluster can coexist with existing IP address allocations in your environment and integrate with existing MTU and VXLAN configurations. To customize the installation, you modify parameters in the **install-config.yaml** file before you install the cluster.

You must set most of the network configuration parameters during installation, and you can modify only **kubeProxy** configuration parameters in a running cluster.

### 8.6.1. Prerequisites

- You reviewed details about the [OpenShift Container Platform installation and update](#) processes.
- You read the documentation on [selecting a cluster installation method and preparing it for users](#).
- You [configured a GCP project](#) to host the cluster.
- If you use a firewall, you [configured it to allow the sites](#) that your cluster requires access to.
- If the cloud identity and access management (IAM) APIs are not accessible in your environment, or if you do not want to store an administrator-level credential secret in the **kube-system** namespace, you can [manually create and maintain IAM credentials](#) .

### 8.6.2. Internet access for OpenShift Container Platform

In OpenShift Container Platform 4.10, you require access to the internet to install your cluster.

You must have internet access to:

- Access [OpenShift Cluster Manager](#) to download the installation program and perform subscription management. If the cluster has internet access and you do not disable Telemetry, that service automatically entitles your cluster.
- Access [Quay.io](#) to obtain the packages that are required to install your cluster.

- Obtain the packages that are required to perform cluster updates.

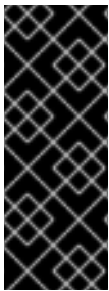

### IMPORTANT

If your cluster cannot have direct internet access, you can perform a restricted network installation on some types of infrastructure that you provision. During that process, you download the required content and use it to populate a mirror registry with the installation packages. With some installation types, the environment that you install your cluster in will not require internet access. Before you update the cluster, you update the content of the mirror registry.

### 8.6.3. Generating a key pair for cluster node SSH access

During an OpenShift Container Platform installation, you can provide an SSH public key to the installation program. The key is passed to the Red Hat Enterprise Linux CoreOS (RHCOS) nodes through their Ignition config files and is used to authenticate SSH access to the nodes. The key is added to the `~/.ssh/authorized_keys` list for the **core** user on each node, which enables password-less authentication.

After the key is passed to the nodes, you can use the key pair to SSH in to the RHCOS nodes as the user **core**. To access the nodes through SSH, the private key identity must be managed by SSH for your local user.

If you want to SSH in to your cluster nodes to perform installation debugging or disaster recovery, you must provide the SSH public key during the installation process. The `./openshift-install gather` command also requires the SSH public key to be in place on the cluster nodes.



### IMPORTANT

Do not skip this procedure in production environments, where disaster recovery and debugging is required.



### NOTE

You must use a local key, not one that you configured with platform-specific approaches such as [AWS key pairs](#).

### Procedure

1. If you do not have an existing SSH key pair on your local machine to use for authentication onto your cluster nodes, create one. For example, on a computer that uses a Linux operating system, run the following command:

```
$ ssh-keygen -t ed25519 -N "" -f <path>/<file_name> 1
```

- 1 Specify the path and file name, such as `~/.ssh/id_ed25519`, of the new SSH key. If you have an existing key pair, ensure your public key is in the your `~/.ssh` directory.

**NOTE**

If you plan to install an OpenShift Container Platform cluster that uses FIPS validated or Modules In Process cryptographic libraries on the **x86\_64** architecture, do not create a key that uses the **ed25519** algorithm. Instead, create a key that uses the **rsa** or **ecdsa** algorithm.

2. View the public SSH key:

```
$ cat <path>/<file_name>.pub
```

For example, run the following to view the `~/.ssh/id_ed25519.pub` public key:

```
$ cat ~/.ssh/id_ed25519.pub
```

3. Add the SSH private key identity to the SSH agent for your local user, if it has not already been added. SSH agent management of the key is required for password-less SSH authentication onto your cluster nodes, or if you want to use the `./openshift-install gather` command.

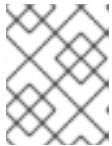
**NOTE**

On some distributions, default SSH private key identities such as `~/.ssh/id_rsa` and `~/.ssh/id_dsa` are managed automatically.

- a. If the **ssh-agent** process is not already running for your local user, start it as a background task:

```
$ eval "$(ssh-agent -s)"
```

**Example output**

```
Agent pid 31874
```

**NOTE**

If your cluster is in FIPS mode, only use FIPS-compliant algorithms to generate the SSH key. The key must be either RSA or ECDSA.

4. Add your SSH private key to the **ssh-agent**:

```
$ ssh-add <path>/<file_name> 1
```

- 1** Specify the path and file name for your SSH private key, such as `~/.ssh/id_ed25519`

**Example output**

```
Identity added: /home/<you>/<path>/<file_name> (<computer_name>)
```

5. Set the **GOOGLE\_APPLICATION\_CREDENTIALS** environment variable to the full path to your service account private key file.

-

```
$ export GOOGLE_APPLICATION_CREDENTIALS="your\_service\_account\_file"
```

6. Verify that the credentials were applied.

```
$ gcloud auth list
```

### Next steps

- When you install OpenShift Container Platform, provide the SSH public key to the installation program.

## 8.6.4. Obtaining the installation program

Before you install OpenShift Container Platform, download the installation file on a local computer.

### Prerequisites

- You have a computer that runs Linux or macOS, with 500 MB of local disk space

### Procedure

1. Access the [Infrastructure Provider](#) page on the OpenShift Cluster Manager site. If you have a Red Hat account, log in with your credentials. If you do not, create an account.
2. Select your infrastructure provider.
3. Navigate to the page for your installation type, download the installation program that corresponds with your host operating system and architecture, and place the file in the directory where you will store the installation configuration files.

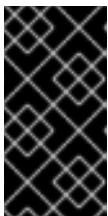

#### IMPORTANT

The installation program creates several files on the computer that you use to install your cluster. You must keep the installation program and the files that the installation program creates after you finish installing the cluster. Both files are required to delete the cluster.

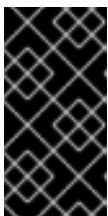

#### IMPORTANT

Deleting the files created by the installation program does not remove your cluster, even if the cluster failed during installation. To remove your cluster, complete the OpenShift Container Platform uninstallation procedures for your specific cloud provider.

4. Extract the installation program. For example, on a computer that uses a Linux operating system, run the following command:

```
$ tar -xvf openshift-install-linux.tar.gz
```

5. Download your installation [pull secret from the Red Hat OpenShift Cluster Manager](#) . This pull secret allows you to authenticate with the services that are provided by the included authorities, including Quay.io, which serves the container images for OpenShift Container Platform components.



## 8.6.5. Creating the installation configuration file

You can customize the OpenShift Container Platform cluster you install on Google Cloud Platform (GCP).

### Prerequisites

- Obtain the OpenShift Container Platform installation program and the pull secret for your cluster.
- Obtain service principal permissions at the subscription level.

### Procedure

1. Create the **install-config.yaml** file.
  - a. Change to the directory that contains the installation program and run the following command:

```
$ ./openshift-install create install-config --dir <installation_directory> 1
```

- 1** For **<installation\_directory>**, specify the directory name to store the files that the installation program creates.



### IMPORTANT

Specify an empty directory. Some installation assets, like bootstrap X.509 certificates have short expiration intervals, so you must not reuse an installation directory. If you want to reuse individual files from another cluster installation, you can copy them into your directory. However, the file names for the installation assets might change between releases. Use caution when copying installation files from an earlier OpenShift Container Platform version.

- b. At the prompts, provide the configuration details for your cloud:
  - i. Optional: Select an SSH key to use to access your cluster machines.



### NOTE

For production OpenShift Container Platform clusters on which you want to perform installation debugging or disaster recovery, specify an SSH key that your **ssh-agent** process uses.

- ii. Select **gcp** as the platform to target.
- iii. If you have not configured the service account key for your GCP account on your computer, you must obtain it from GCP and paste the contents of the file or enter the absolute path to the file.
- iv. Select the project ID to provision the cluster in. The default value is specified by the service account that you configured.
- v. Select the region to deploy the cluster to.

- vi. Select the base domain to deploy the cluster to. The base domain corresponds to the public DNS zone that you created for your cluster.
  - vii. Enter a descriptive name for your cluster.
  - viii. Paste the [pull secret from the Red Hat OpenShift Cluster Manager](#) .
2. Modify the **install-config.yaml** file. You can find more information about the available parameters in the "Installation configuration parameters" section.
  3. Back up the **install-config.yaml** file so that you can use it to install multiple clusters.

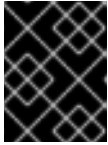

### IMPORTANT

The **install-config.yaml** file is consumed during the installation process. If you want to reuse the file, you must back it up now.

#### 8.6.5.1. Installation configuration parameters

Before you deploy an OpenShift Container Platform cluster, you provide parameter values to describe your account on the cloud platform that hosts your cluster and optionally customize your cluster's platform. When you create the **install-config.yaml** installation configuration file, you provide values for the required parameters through the command line. If you customize your cluster, you can modify the **install-config.yaml** file to provide more details about the platform.

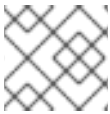

### NOTE

After installation, you cannot modify these parameters in the **install-config.yaml** file.

##### 8.6.5.1.1. Required configuration parameters

Required installation configuration parameters are described in the following table:

Table 8.10. Required parameters

Parameter	Description	Values
<b>apiVersion</b>	The API version for the <b>install-config.yaml</b> content. The current version is <b>v1</b> . The installer may also support older API versions.	String

Parameter	Description	Values
<b>baseDomain</b>	The base domain of your cloud provider. The base domain is used to create routes to your OpenShift Container Platform cluster components. The full DNS name for your cluster is a combination of the <b>baseDomain</b> and <b>metadata.name</b> parameter values that uses the <b>&lt;metadata.name&gt;</b> . <b>&lt;baseDomain&gt;</b> format.	A fully-qualified domain or subdomain name, such as <b>example.com</b> .
<b>metadata</b>	Kubernetes resource <b>ObjectMeta</b> , from which only the <b>name</b> parameter is consumed.	Object
<b>metadata.name</b>	The name of the cluster. DNS records for the cluster are all subdomains of <b>{{.metadata.name}}</b> . <b>{{.baseDomain}}</b> .	String of lowercase letters, hyphens (-), and periods (.), such as <b>dev</b> .
<b>platform</b>	The configuration for the specific platform upon which to perform the installation: <b>alibabacloud</b> , <b>aws</b> , <b>baremetal</b> , <b>azure</b> , <b>gcp</b> , <b>ibmcloud</b> , <b>openstack</b> , <b>ovirt</b> , <b>vsphere</b> , or <b>{}</b> . For additional information about <b>platform.&lt;platform&gt;</b> parameters, consult the table for your specific platform that follows.	Object

Parameter	Description	Values
<b>pullSecret</b>	Get a <a href="#">pull secret from the Red Hat OpenShift Cluster Manager</a> to authenticate downloading container images for OpenShift Container Platform components from services such as Quay.io.	<pre>{   "auths":{     "cloud.openshift.com":{       "auth":"b3Blb=",       "email":"you@example.com"     },     "quay.io":{       "auth":"b3Blb=",       "email":"you@example.com"     }   } }</pre>

### 8.6.5.1.2. Network configuration parameters

You can customize your installation configuration based on the requirements of your existing network infrastructure. For example, you can expand the IP address block for the cluster network or provide different IP address blocks than the defaults.

Only IPv4 addresses are supported.

Table 8.11. Network parameters

Parameter	Description	Values
<b>networking</b>	The configuration for the cluster network.	Object <div style="display: flex; align-items: center; margin-top: 10px;">  <div> <p><b>NOTE</b></p> <p>You cannot modify parameters specified by the <b>networking</b> object after installation.</p> </div> </div>
<b>networking.networkType</b>	The cluster network provider Container Network Interface (CNI) plugin to install.	Either <b>OpenShiftSDN</b> or <b>OVNKubernetes</b> . <b>OpenShiftSDN</b> is a CNI provider for all-Linux networks. <b>OVNKubernetes</b> is a CNI provider for Linux networks and hybrid networks that contain both Linux and Windows servers. The default value is <b>OpenShiftSDN</b> .

Parameter	Description	Values
<b>networking.clusterNetwork</b>	<p>The IP address blocks for pods.</p> <p>The default value is <b>10.128.0.0/14</b> with a host prefix of <b>/23</b>.</p> <p>If you specify multiple IP address blocks, the blocks must not overlap.</p>	<p>An array of objects. For example:</p> <pre>networking:   clusterNetwork:     - cidr: 10.128.0.0/14       hostPrefix: 23</pre>
<b>networking.clusterNetwork.cidr</b>	<p>Required if you use <b>networking.clusterNetwork</b>. An IP address block.</p> <p>An IPv4 network.</p>	<p>An IP address block in Classless Inter-Domain Routing (CIDR) notation. The prefix length for an IPv4 block is between <b>0</b> and <b>32</b>.</p>
<b>networking.clusterNetwork.hostPrefix</b>	<p>The subnet prefix length to assign to each individual node. For example, if <b>hostPrefix</b> is set to <b>23</b> then each node is assigned a <b>/23</b> subnet out of the given <b>cidr</b>. A <b>hostPrefix</b> value of <b>23</b> provides 510 (<math>2^{(32 - 23)} - 2</math>) pod IP addresses.</p>	<p>A subnet prefix.</p> <p>The default value is <b>23</b>.</p>
<b>networking.serviceNetwork</b>	<p>The IP address block for services. The default value is <b>172.30.0.0/16</b>.</p> <p>The OpenShift SDN and OVN-Kubernetes network providers support only a single IP address block for the service network.</p>	<p>An array with an IP address block in CIDR format. For example:</p> <pre>networking:   serviceNetwork:     - 172.30.0.0/16</pre>
<b>networking.machineNetwork</b>	<p>The IP address blocks for machines.</p> <p>If you specify multiple IP address blocks, the blocks must not overlap.</p>	<p>An array of objects. For example:</p> <pre>networking:   machineNetwork:     - cidr: 10.0.0.0/16</pre>
<b>networking.machineNetwork.cidr</b>	<p>Required if you use <b>networking.machineNetwork</b>. An IP address block. The default value is <b>10.0.0.0/16</b> for all platforms other than libvirt. For libvirt, the default value is <b>192.168.126.0/24</b>.</p>	<p>An IP network block in CIDR notation.</p> <p>For example, <b>10.0.0.0/16</b>.</p> <div style="display: flex; align-items: flex-start;">  <div> <p><b>NOTE</b></p> <p>Set the <b>networking.machineNetwork</b> to match the CIDR that the preferred NIC resides in.</p> </div> </div>



### 8.6.5.1.3. Optional configuration parameters

Optional installation configuration parameters are described in the following table:

**Table 8.12. Optional parameters**

Parameter	Description	Values
<b>additionalTrustBundle</b>	A PEM-encoded X.509 certificate bundle that is added to the nodes' trusted certificate store. This trust bundle may also be used when a proxy has been configured.	String
<b>cgroupsV2</b>	Enables <a href="#">Linux control groups version 2</a> (cgroups v2) on specific nodes in your cluster. The OpenShift Container Platform process for enabling cgroups v2 disables all cgroup version 1 controllers and hierarchies. The OpenShift Container Platform cgroups version 2 feature is in Developer Preview and is not supported by Red Hat at this time.	<b>true</b>
<b>compute</b>	The configuration for the machines that comprise the compute nodes.	Array of <b>MachinePool</b> objects.
<b>compute.architecture</b>	Determines the instruction set architecture of the machines in the pool. Currently, clusters with varied architectures are not supported. All pools must specify the same architecture. Valid values are <b>amd64</b> (the default).	String
<b>compute.hyperthreading</b>	Whether to enable or disable simultaneous multithreading, or <b>hyperthreading</b> , on compute machines. By default, simultaneous multithreading is enabled to increase the performance of your machines' cores.	<b>Enabled</b> or <b>Disabled</b>
	 <p><b>IMPORTANT</b></p> <p>If you disable simultaneous multithreading, ensure that your capacity planning accounts for the dramatically decreased machine performance.</p>	

Parameter	Description	Values
<b>compute.name</b>	Required if you use <b>compute</b> . The name of the machine pool.	<b>worker</b>
<b>compute.platform</b>	Required if you use <b>compute</b> . Use this parameter to specify the cloud provider to host the worker machines. This parameter value must match the <b>controlPlane.platform</b> parameter value.	<b>alibabacloud, aws, azure, gcp, ibmcloud, openstack, ovirt, vsphere</b> , or <b>{}</b>
<b>compute.replicas</b>	The number of compute machines, which are also known as worker machines, to provision.	A positive integer greater than or equal to <b>2</b> . The default value is <b>3</b> .
<b>controlPlane</b>	The configuration for the machines that comprise the control plane.	Array of <b>MachinePool</b> objects.
<b>controlPlane.architecture</b>	Determines the instruction set architecture of the machines in the pool. Currently, clusters with varied architectures are not supported. All pools must specify the same architecture. Valid values are <b>amd64</b> (the default).	String
<b>controlPlane.hyperthreading</b>	<p>Whether to enable or disable simultaneous multithreading, or <b>hyperthreading</b>, on control plane machines. By default, simultaneous multithreading is enabled to increase the performance of your machines' cores.</p> <div data-bbox="485 1469 592 1787" style="background-color: black; width: 67px; height: 142px; margin-bottom: 10px;"></div> <p><b>IMPORTANT</b></p> <p>If you disable simultaneous multithreading, ensure that your capacity planning accounts for the dramatically decreased machine performance.</p>	<b>Enabled</b> or <b>Disabled</b>
<b>controlPlane.name</b>	Required if you use <b>controlPlane</b> . The name of the machine pool.	<b>master</b>

Parameter	Description	Values
<b>controlPlane.platform</b>	Required if you use <b>controlPlane</b> . Use this parameter to specify the cloud provider that hosts the control plane machines. This parameter value must match the <b>compute.platform</b> parameter value.	<b>alibabacloud, aws, azure, gcp, ibmcloud, openstack, ovirt, vsphere</b> , or <b>{}</b>
<b>controlPlane.replicas</b>	The number of control plane machines to provision.	The only supported value is <b>3</b> , which is the default value.
<b>credentialsMode</b>	<p>The Cloud Credential Operator (CCO) mode. If no mode is specified, the CCO dynamically tries to determine the capabilities of the provided credentials, with a preference for mint mode on the platforms where multiple modes are supported. If you are installing on GCP into a shared virtual private cloud (VPC), <b>credentialsMode</b> must be set to <b>Passthrough</b>.</p> <p> <b>NOTE</b></p> <p>Not all CCO modes are supported for all cloud providers. For more information on CCO modes, see the <i>Cloud Credential Operator</i> entry in the <i>Cluster Operators reference</i> content.</p> <p> <b>NOTE</b></p> <p>If your AWS account has service control policies (SCP) enabled, you must configure the <b>credentialsMode</b> parameter to <b>Mint</b>, <b>Passthrough</b> or <b>Manual</b>.</p>	<b>Mint, Passthrough, Manual</b> or an empty string ( <b>""</b> ).



Parameter	Description	Values
<b>fips</b>	<p>Enable or disable FIPS mode. The default is <b>false</b> (disabled). If FIPS mode is enabled, the Red Hat Enterprise Linux CoreOS (RHCOS) machines that OpenShift Container Platform runs on bypass the default Kubernetes cryptography suite and use the cryptography modules that are provided with RHCOS instead.</p> <div data-bbox="488 589 593 1361" style="background-color: black; color: white; padding: 5px; margin-bottom: 10px;"> <p><b>IMPORTANT</b></p> <p>To enable FIPS mode for your cluster, you must run the installation program from a Red Hat Enterprise Linux (RHEL) computer configured to operate in FIPS mode. For more information about configuring FIPS mode on RHEL, see <a href="#">Installing the system in FIPS mode</a>. The use of FIPS validated or Modules In Process cryptographic libraries is only supported on OpenShift Container Platform deployments on the <b>x86_64</b> architecture.</p> </div> <div data-bbox="488 1413 593 1608" style="background-color: black; color: white; padding: 5px;"> <p><b>NOTE</b></p> <p>If you are using Azure File storage, you cannot enable FIPS mode.</p> </div>	<b>false</b> or <b>true</b>
<b>imageContentSources</b>	Sources and repositories for the release-image content.	Array of objects. Includes a <b>source</b> and, optionally, <b>mirrors</b> , as described in the following rows of this table.

Parameter	Description	Values
<b>imageContentSources.source</b>	Required if you use <b>imageContentSources</b> . Specify the repository that users refer to, for example, in image pull specifications.	String
<b>imageContentSources.mirrors</b>	Specify one or more repositories that may also contain the same images.	Array of strings
<b>publish</b>	How to publish or expose the user-facing endpoints of your cluster, such as the Kubernetes API, OpenShift routes.	<b>Internal</b> or <b>External</b> . To deploy a private cluster, which cannot be accessed from the internet, set <b>publish</b> to <b>Internal</b> . The default value is <b>External</b> .
<b>sshKey</b>	<p>The SSH key or keys to authenticate access your cluster machines.</p>  <p><b>NOTE</b></p> <p>For production OpenShift Container Platform clusters on which you want to perform installation debugging or disaster recovery, specify an SSH key that your <b>ssh-agent</b> process uses.</p>	<p>One or more keys. For example:</p> <pre>sshKey:   &lt;key1&gt;   &lt;key2&gt;   &lt;key3&gt;</pre>

#### 8.6.5.1.4. Additional Google Cloud Platform (GCP) configuration parameters

Additional GCP configuration parameters are described in the following table:

Table 8.13. Additional GCP parameters

Parameter	Description	Values
<b>platform.gcp.network</b>	The name of the existing VPC that you want to deploy your cluster to.	String.
<b>platform.gcp.region</b>	The name of the GCP region that hosts your cluster.	Any valid region name, such as <b>us-central1</b> .
<b>platform.gcp.type</b>	The <a href="#">GCP machine type</a> .	The GCP machine type.
<b>platform.gcp.zones</b>	The availability zones where the installation program creates machines for the specified MachinePool.	A list of valid <a href="#">GCP availability zones</a> , such as <b>us-central1-a</b> , in a <a href="#">YAML sequence</a> .
<b>platform.gcp.controlPlaneSubnet</b>	The name of the existing subnet in your VPC that you want to deploy your control plane machines to.	The subnet name.
<b>platform.gcp.computeSubnet</b>	The name of the existing subnet in your VPC that you want to deploy your compute machines to.	The subnet name.
<b>platform.gcp.licenses</b>	<p>A list of license URLs that must be applied to the compute images.</p> <div style="display: flex; align-items: flex-start;">  <div> <p><b>IMPORTANT</b></p> <p>The <b>licenses</b> parameter is a deprecated field and nested virtualization is enabled by default. It is not recommended to use this field.</p> </div> </div>	Any license available with the <a href="#">license API</a> , such as the license to enable <a href="#">nested virtualization</a> . You cannot use this parameter with a mechanism that generates pre-built images. Using a license URL forces the installer to copy the source image before use.

Parameter	Description	Values
<code>platform.gcp.osDiskSizeGB</code>	The size of the disk in gigabytes (GB).	Any size between 16 GB and 65536 GB.
<code>platform.gcp.osDiskType</code>	The type of disk.	Either the default <b>pd-ssd</b> or the <b>pd-standard</b> disk type. The control plane nodes must be the <b>pd-ssd</b> disk type. The worker nodes can be either type.
<code>controlplane.platform.gcp.osDiskEncryptionKey.kmsKeyName</code>	The name of the customer managed encryption key to be used for control plane machine disk encryption.	The encryption key name.
<code>controlplane.platform.gcp.osDiskEncryptionKey.kmsKeyRing</code>	For control plane machines, the name of the KMS key ring to which the KMS key belongs.	The KMS key ring name.
<code>controlplane.platform.gcp.osDiskEncryptionKey.kmsLocation</code>	For control plane machines, the GCP location in which the key ring exists. For more information on KMS locations, see Google's documentation on <a href="#">Cloud KMS locations</a> .	The GCP location for the key ring.

Parameter	Description	Values
<b>controlPlane.platform.gcp.osDisk.encryptionKey.kmsKey.projectID</b>	For control plane machines, the ID of the project in which the KMS key ring exists. This value defaults to the VM project ID if not set.	The GCP project ID.
<b>compute.platform.gcp.osDisk.encryptionKey.kmsKeyName</b>	The name of the customer managed encryption key to be used for compute machine disk encryption.	The encryption key name.
<b>compute.platform.gcp.osDisk.encryptionKey.kmsKey.keyRing</b>	For compute machines, the name of the KMS key ring to which the KMS key belongs.	The KMS key ring name.
<b>compute.platform.gcp.osDisk.encryptionKey.kmsKey.location</b>	For compute machines, the GCP location in which the key ring exists. For more information on KMS locations, see Google's documentation on <a href="#">Cloud KMS locations</a> .	The GCP location for the key ring.

Parameter	Description	Values
<code>compute.platform.gcp.ossDisk.encryptionKey.kmsKey.projectID</code>	For compute machines, the ID of the project in which the KMS key ring exists. This value defaults to the VM project ID if not set.	The GCP project ID.

### 8.6.5.2. Minimum resource requirements for cluster installation

Each cluster machine must meet the following minimum requirements:

**Table 8.14. Minimum resource requirements**

Machine	Operating System	vCPU [1]	Virtual RAM	Storage	IOPS [2]
Bootstrap	RHCOS	4	16 GB	100 GB	300
Control plane	RHCOS	4	16 GB	100 GB	300
Compute	RHCOS, RHEL 8.4, or RHEL 8.5 [3]	2	8 GB	100 GB	300

1. One vCPU is equivalent to one physical core when simultaneous multithreading (SMT), or hyperthreading, is not enabled. When enabled, use the following formula to calculate the corresponding ratio:  $(\text{threads per core} \times \text{cores}) \times \text{sockets} = \text{vCPUs}$ .
2. OpenShift Container Platform and Kubernetes are sensitive to disk performance, and faster storage is recommended, particularly for etcd on the control plane nodes which require a 10 ms p99 fsync duration. Note that on many cloud platforms, storage size and IOPS scale together, so you might need to over-allocate storage volume to obtain sufficient performance.
3. As with all user-provisioned installations, if you choose to use RHEL compute machines in your cluster, you take responsibility for all operating system life cycle management and maintenance, including performing system updates, applying patches, and completing all other required tasks. Use of RHEL 7 compute machines is deprecated and has been removed in OpenShift Container Platform 4.10 and later.

If an instance type for your platform meets the minimum requirements for cluster machines, it is supported to use in OpenShift Container Platform.

### 8.6.5.3. Tested instance types for GCP

The following Google Cloud Platform instance types have been tested with OpenShift Container Platform.

#### Example 8.22. Machine series

- C2
- C2D
- C3
- E2
- M1
- N1
- N2
- N2D
- Tau T2D

#### 8.6.5.4. Using custom machine types

Using a custom machine type to install a OpenShift Container Platform cluster is supported.

Consider the following when using a custom machine type:

- Similar to predefined instance types, custom machine types must meet the minimum resource requirements for control plane and compute machines. For more information, see "Minimum resource requirements for cluster installation".
- The name of the custom machine type must adhere to the following syntax:  
**custom-<number\_of\_cpus>-<amount\_of\_memory\_in\_mb>**

For example, **custom-6-20480**.

As part of the installation process, you specify the custom machine type in the **install-config.yaml** file.

#### Sample install-config.yaml file with a custom machine type

```
compute:
- architecture: amd64
  hyperthreading: Enabled
  name: worker
  platform:
    gcp:
      type: custom-6-20480
  replicas: 2
controlPlane:
  architecture: amd64
  hyperthreading: Enabled
  name: master
  platform:
```

```
gcp:
  type: custom-6-20480
  replicas: 3
```

### 8.6.5.5. Sample customized install-config.yaml file for GCP

You can customize the **install-config.yaml** file to specify more details about your OpenShift Container Platform cluster's platform or modify the values of the required parameters.



#### IMPORTANT

This sample YAML file is provided for reference only. You must obtain your **install-config.yaml** file by using the installation program and modify it.

```
apiVersion: v1
baseDomain: example.com 1
controlPlane: 2 3
  hyperthreading: Enabled 4
  name: master
  platform:
    gcp:
      type: n2-standard-4
      zones:
      - us-central1-a
      - us-central1-c
    osDisk:
      diskType: pd-ssd
      diskSizeGB: 1024
      encryptionKey: 5
      kmsKey:
        name: worker-key
        keyRing: test-machine-keys
        location: global
        projectID: project-id
  replicas: 3
compute: 6 7
- hyperthreading: Enabled 8
  name: worker
  platform:
    gcp:
      type: n2-standard-4
      zones:
      - us-central1-a
      - us-central1-c
    osDisk:
      diskType: pd-standard
      diskSizeGB: 128
      encryptionKey: 9
      kmsKey:
        name: worker-key
        keyRing: test-machine-keys
        location: global
        projectID: project-id
```



```

replicas: 3
metadata:
  name: test-cluster 10
networking: 11
  clusterNetwork:
  - cidr: 10.128.0.0/14
    hostPrefix: 23
  machineNetwork:
  - cidr: 10.0.0.0/16
  networkType: OpenShiftSDN
  serviceNetwork:
  - 172.30.0.0/16
platform:
  gcp:
    projectID: openshift-production 12
    region: us-central1 13
  pullSecret: '{"auths": ...}' 14
  fips: false 15
  sshKey: ssh-ed25519 AAAA... 16

```

1 10 12 13 14 Required. The installation program prompts you for this value.

2 6 11 If you do not provide these parameters and values, the installation program provides the default value.

3 7 The **controlPlane** section is a single mapping, but the **compute** section is a sequence of mappings. To meet the requirements of the different data structures, the first line of the **compute** section must begin with a hyphen, -, and the first line of the **controlPlane** section must not. Only one control plane pool is used.

4 8 Whether to enable or disable simultaneous multithreading, or **hyperthreading**. By default, simultaneous multithreading is enabled to increase the performance of your machines' cores. You can disable it by setting the parameter value to **Disabled**. If you disable simultaneous multithreading in some cluster machines, you must disable it in all cluster machines.



## IMPORTANT

If you disable simultaneous multithreading, ensure that your capacity planning accounts for the dramatically decreased machine performance. Use larger machine types, such as **n1-standard-8**, for your machines if you disable simultaneous multithreading.

5 9 Optional: The custom encryption key section to encrypt both virtual machines and persistent volumes. Your default compute service account must have the permissions granted to use your KMS key and have the correct IAM role assigned. The default service account name follows the **service-`<project_number>`@compute-system.iam.gserviceaccount.com** pattern. For more information on granting the correct permissions for your service account, see "Machine management" → "Creating machine sets" → "Creating a machine set on GCP".

15 Whether to enable or disable FIPS mode. By default, FIPS mode is not enabled. If FIPS mode is enabled, the Red Hat Enterprise Linux CoreOS (RHCOS) machines that OpenShift Container Platform runs on bypass the default Kubernetes cryptography suite and use the cryptography modules that are provided with RHCOS instead.



## IMPORTANT

To enable FIPS mode for your cluster, you must run the installation program from a Red Hat Enterprise Linux (RHEL) computer configured to operate in FIPS mode. For more information about configuring FIPS mode on RHEL, see [Installing the system in FIPS mode](#). The use of FIPS validated or Modules In Process cryptographic libraries is only supported on OpenShift Container Platform deployments on the **x86\_64** architecture.

16

You can optionally provide the **sshKey** value that you use to access the machines in your cluster.



## NOTE

For production OpenShift Container Platform clusters on which you want to perform installation debugging or disaster recovery, specify an SSH key that your **ssh-agent** process uses.

### 8.6.6. Additional resources

- [Enabling customer-managed encryption keys for a machine set](#)

#### 8.6.6.1. Configuring the cluster-wide proxy during installation

Production environments can deny direct access to the internet and instead have an HTTP or HTTPS proxy available. You can configure a new OpenShift Container Platform cluster to use a proxy by configuring the proxy settings in the **install-config.yaml** file.

#### Prerequisites

- You have an existing **install-config.yaml** file.
- You reviewed the sites that your cluster requires access to and determined whether any of them need to bypass the proxy. By default, all cluster egress traffic is proxied, including calls to hosting cloud provider APIs. You added sites to the **Proxy** object's **spec.noProxy** field to bypass the proxy if necessary.



## NOTE

The **Proxy** object **status.noProxy** field is populated with the values of the **networking.machineNetwork[].cidr**, **networking.clusterNetwork[].cidr**, and **networking.serviceNetwork[]** fields from your installation configuration.

For installations on Amazon Web Services (AWS), Google Cloud Platform (GCP), Microsoft Azure, and Red Hat OpenStack Platform (RHOSP), the **Proxy** object **status.noProxy** field is also populated with the instance metadata endpoint (**169.254.169.254**).

#### Procedure

1. Edit your **install-config.yaml** file and add the proxy settings. For example:

```
apiVersion: v1
baseDomain: my.domain.com
```

```

proxy:
  httpProxy: http://<username>:<pswd>@<ip>:<port> 1
  httpsProxy: https://<username>:<pswd>@<ip>:<port> 2
  noProxy: example.com 3
  additionalTrustBundle: | 4
    -----BEGIN CERTIFICATE-----
    <MY_TRUSTED_CA_CERT>
    -----END CERTIFICATE-----
  ...

```

- 1 A proxy URL to use for creating HTTP connections outside the cluster. The URL scheme must be **http**.
- 2 A proxy URL to use for creating HTTPS connections outside the cluster.
- 3 A comma-separated list of destination domain names, IP addresses, or other network CIDRs to exclude from proxying. Preface a domain with **.** to match subdomains only. For example, **.y.com** matches **x.y.com**, but not **y.com**. Use **\*** to bypass the proxy for all destinations.
- 4 If provided, the installation program generates a config map that is named **user-ca-bundle** in the **openshift-config** namespace that contains one or more additional CA certificates that are required for proxying HTTPS connections. The Cluster Network Operator then creates a **trusted-ca-bundle** config map that merges these contents with the Red Hat Enterprise Linux CoreOS (RHCOS) trust bundle, and this config map is referenced in the **trustedCA** field of the **Proxy** object. The **additionalTrustBundle** field is required unless the proxy's identity certificate is signed by an authority from the RHCOS trust bundle.

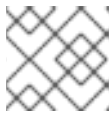

#### NOTE

The installation program does not support the proxy **readinessEndpoints** field.

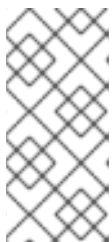

#### NOTE

If the installer times out, restart and then complete the deployment by using the **wait-for** command of the installer. For example:

```
$ ./openshift-install wait-for install-complete --log-level debug
```

2. Save the file and reference it when installing OpenShift Container Platform.

The installation program creates a cluster-wide proxy that is named **cluster** that uses the proxy settings in the provided **install-config.yaml** file. If no proxy settings are provided, a **cluster Proxy** object is still created, but it will have a nil **spec**.

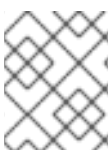

#### NOTE

Only the **Proxy** object named **cluster** is supported, and no additional proxies can be created.

### 8.6.7. Network configuration phases

There are two phases prior to OpenShift Container Platform installation where you can customize the network configuration.

### Phase 1

You can customize the following network-related fields in the **install-config.yaml** file before you create the manifest files:

- **networking.networkType**
- **networking.clusterNetwork**
- **networking.serviceNetwork**
- **networking.machineNetwork**

For more information on these fields, refer to *Installation configuration parameters*.



#### NOTE

Set the **networking.machineNetwork** to match the CIDR that the preferred NIC resides in.



#### IMPORTANT

The CIDR range **172.17.0.0/16** is reserved by libVirt. You cannot use this range or any range that overlaps with this range for any networks in your cluster.

### Phase 2

After creating the manifest files by running **openshift-install create manifests**, you can define a customized Cluster Network Operator manifest with only the fields you want to modify. You can use the manifest to specify advanced network configuration.

You cannot override the values specified in phase 1 in the **install-config.yaml** file during phase 2. However, you can further customize the cluster network provider during phase 2.

### 8.6.8. Specifying advanced network configuration

You can use advanced network configuration for your cluster network provider to integrate your cluster into your existing network environment. You can specify advanced network configuration only before you install the cluster.



#### IMPORTANT

Customizing your network configuration by modifying the OpenShift Container Platform manifest files created by the installation program is not supported. Applying a manifest file that you create, as in the following procedure, is supported.

#### Prerequisites

- You have created the **install-config.yaml** file and completed any modifications to it.

#### Procedure

1. Change to the directory that contains the installation program and create the manifests:

```
$ ./openshift-install create manifests --dir <installation_directory> 1
```

- 1 **<installation\_directory>** specifies the name of the directory that contains the **install-config.yaml** file for your cluster.

2. Create a stub manifest file for the advanced network configuration that is named **cluster-network-03-config.yml** in the **<installation\_directory>/manifests/** directory:

```
apiVersion: operator.openshift.io/v1
kind: Network
metadata:
  name: cluster
spec:
```

3. Specify the advanced network configuration for your cluster in the **cluster-network-03-config.yml** file, such as in the following examples:

#### Specify a different VXLAN port for the OpenShift SDN network provider

```
apiVersion: operator.openshift.io/v1
kind: Network
metadata:
  name: cluster
spec:
  defaultNetwork:
    openshiftSDNConfig:
      vxlanPort: 4800
```

#### Enable IPsec for the OVN-Kubernetes network provider

```
apiVersion: operator.openshift.io/v1
kind: Network
metadata:
  name: cluster
spec:
  defaultNetwork:
    ovnKubernetesConfig:
      ipsecConfig: {}
```

4. Optional: Back up the **manifests/cluster-network-03-config.yml** file. The installation program consumes the **manifests/** directory when you create the Ignition config files.

### 8.6.9. Cluster Network Operator configuration

The configuration for the cluster network is specified as part of the Cluster Network Operator (CNO) configuration and stored in a custom resource (CR) object that is named **cluster**. The CR specifies the fields for the **Network** API in the **operator.openshift.io** API group.

The CNO configuration inherits the following fields during cluster installation from the **Network** API in the **Network.config.openshift.io** API group and these fields cannot be changed:

**clusterNetwork**

IP address pools from which pod IP addresses are allocated.

**serviceNetwork**

IP address pool for services.

**defaultNetwork.type**

Cluster network provider, such as OpenShift SDN or OVN-Kubernetes.

You can specify the cluster network provider configuration for your cluster by setting the fields for the **defaultNetwork** object in the CNO object named **cluster**.

**8.6.9.1. Cluster Network Operator configuration object**

The fields for the Cluster Network Operator (CNO) are described in the following table:

**Table 8.15. Cluster Network Operator configuration object**

Field	Type	Description
<b>metadata.name</b>	<b>string</b>	The name of the CNO object. This name is always <b>cluster</b> .
<b>spec.clusterNetwork</b>	<b>array</b>	<p>A list specifying the blocks of IP addresses from which pod IP addresses are allocated and the subnet prefix length assigned to each individual node in the cluster. For example:</p> <pre>spec:   clusterNetwork:   - cidr: 10.128.0.0/19     hostPrefix: 23   - cidr: 10.128.32.0/19     hostPrefix: 23</pre> <p>You can customize this field only in the <b>install-config.yaml</b> file before you create the manifests. The value is read-only in the manifest file.</p>
<b>spec.serviceNetwork</b>	<b>array</b>	<p>A block of IP addresses for services. The OpenShift SDN and OVN-Kubernetes Container Network Interface (CNI) network providers support only a single IP address block for the service network. For example:</p> <pre>spec:   serviceNetwork:   - 172.30.0.0/14</pre> <p>You can customize this field only in the <b>install-config.yaml</b> file before you create the manifests. The value is read-only in the manifest file.</p>
<b>spec.defaultNetwork</b>	<b>object</b>	Configures the Container Network Interface (CNI) cluster network provider for the cluster network.

Field	Type	Description
<b>spec.kubeProxy Config</b>	<b>object</b>	The fields for this object specify the kube-proxy configuration. If you are using the OVN-Kubernetes cluster network provider, the kube-proxy configuration has no effect.

### defaultNetwork object configuration

The values for the **defaultNetwork** object are defined in the following table:

Table 8.16. **defaultNetwork** object

Field	Type	Description
<b>type</b>	<b>string</b>	<p>Either <b>OpenShiftSDN</b> or <b>OVNKubernetes</b>. The cluster network provider is selected during installation. This value cannot be changed after cluster installation.</p> <div style="display: flex; align-items: flex-start;"> <div style="flex: 1;">  </div> <div style="flex: 2;"> <p><b>NOTE</b></p> <p>OpenShift Container Platform uses the OpenShift SDN Container Network Interface (CNI) cluster network provider by default.</p> </div> </div>
<b>openshiftSDNConfig</b>	<b>object</b>	This object is only valid for the OpenShift SDN cluster network provider.
<b>ovnKubernetesConfig</b>	<b>object</b>	This object is only valid for the OVN-Kubernetes cluster network provider.

### Configuration for the OpenShift SDN CNI cluster network provider

The following table describes the configuration fields for the OpenShift SDN Container Network Interface (CNI) cluster network provider.

Table 8.17. **openshiftSDNConfig** object

Field	Type	Description
<b>mode</b>	<b>string</b>	<p>Configures the network isolation mode for OpenShift SDN. The default value is <b>NetworkPolicy</b>.</p> <p>The values <b>Multitenant</b> and <b>Subnet</b> are available for backwards compatibility with OpenShift Container Platform 3.x but are not recommended. This value cannot be changed after cluster installation.</p>

Field	Type	Description
<b>mtu</b>	<b>integer</b>	<p>The maximum transmission unit (MTU) for the VXLAN overlay network. This is detected automatically based on the MTU of the primary network interface. You do not normally need to override the detected MTU.</p> <p>If the auto-detected value is not what you expect it to be, confirm that the MTU on the primary network interface on your nodes is correct. You cannot use this option to change the MTU value of the primary network interface on the nodes.</p> <p>If your cluster requires different MTU values for different nodes, you must set this value to <b>50</b> less than the lowest MTU value in your cluster. For example, if some nodes in your cluster have an MTU of <b>9001</b>, and some have an MTU of <b>1500</b>, you must set this value to <b>1450</b>.</p> <p>This value cannot be changed after cluster installation.</p>
<b>vxlanPort</b>	<b>integer</b>	<p>The port to use for all VXLAN packets. The default value is <b>4789</b>. This value cannot be changed after cluster installation.</p> <p>If you are running in a virtualized environment with existing nodes that are part of another VXLAN network, then you might be required to change this. For example, when running an OpenShift SDN overlay on top of VMware NSX-T, you must select an alternate port for the VXLAN, because both SDNs use the same default VXLAN port number.</p> <p>On Amazon Web Services (AWS), you can select an alternate port for the VXLAN between port <b>9000</b> and port <b>9999</b>.</p>

### Example OpenShift SDN configuration

```
defaultNetwork:
  type: OpenShiftSDN
  openshiftSDNConfig:
    mode: NetworkPolicy
    mtu: 1450
    vxlanPort: 4789
```

### Configuration for the OVN-Kubernetes CNI cluster network provider

The following table describes the configuration fields for the OVN-Kubernetes CNI cluster network provider.

Table 8.18. `ovnKubernetesConfig` object



Field	Type	Description
<b>mtu</b>	<b>integer</b>	<p>The maximum transmission unit (MTU) for the Geneve (Generic Network Virtualization Encapsulation) overlay network. This is detected automatically based on the MTU of the primary network interface. You do not normally need to override the detected MTU.</p> <p>If the auto-detected value is not what you expect it to be, confirm that the MTU on the primary network interface on your nodes is correct. You cannot use this option to change the MTU value of the primary network interface on the nodes.</p> <p>If your cluster requires different MTU values for different nodes, you must set this value to <b>100</b> less than the lowest MTU value in your cluster. For example, if some nodes in your cluster have an MTU of <b>9001</b>, and some have an MTU of <b>1500</b>, you must set this value to <b>1400</b>.</p>
<b>genevePort</b>	<b>integer</b>	The port to use for all Geneve packets. The default value is <b>6081</b> . This value cannot be changed after cluster installation.
<b>ipsecConfig</b>	<b>object</b>	Specify an empty object to enable IPsec encryption. This value cannot be changed after cluster installation.
<b>policyAuditConfig</b>	<b>object</b>	Specify a configuration object for customizing network policy audit logging. If unset, the defaults audit log settings are used.
<b>gatewayConfig</b>	<b>object</b>	<p>Optional: Specify a configuration object for customizing how egress traffic is sent to the node gateway.</p> <div style="display: flex; align-items: flex-start;">  <div> <p><b>NOTE</b></p> <p>While migrating egress traffic, you can expect some disruption to workloads and service traffic until the Cluster Network Operator (CNO) successfully rolls out the changes.</p> </div> </div>

Table 8.19. **policyAuditConfig** object

Field	Type	Description
<b>rateLimit</b>	integer	The maximum number of messages to generate every second per node. The default value is <b>20</b> messages per second.
<b>maxFileSize</b>	integer	The maximum size for the audit log in bytes. The default value is <b>50000000</b> or 50 MB.

Field	Type	Description
<b>destination</b>	string	<p>One of the following additional audit log targets:</p> <p><b>libc</b> The libc <b>syslog()</b> function of the journald process on the host.</p> <p><b>udp:&lt;host&gt;:&lt;port&gt;</b> A syslog server. Replace <b>&lt;host&gt;:&lt;port&gt;</b> with the host and port of the syslog server.</p> <p><b>unix:&lt;file&gt;</b> A Unix Domain Socket file specified by <b>&lt;file&gt;</b>.</p> <p><b>null</b> Do not send the audit logs to any additional target.</p>
<b>syslogFacility</b>	string	The syslog facility, such as <b>kern</b> , as defined by RFC5424. The default value is <b>local0</b> .

Table 8.20. gatewayConfig object

Field	Type	Description
<b>routingViaHost</b>	<b>boolean</b>	<p>Set this field to <b>true</b> to send egress traffic from pods to the host networking stack. For highly-specialized installations and applications that rely on manually configured routes in the kernel routing table, you might want to route egress traffic to the host networking stack. By default, egress traffic is processed in OVN to exit the cluster and is not affected by specialized routes in the kernel routing table. The default value is <b>false</b>.</p> <p>This field has an interaction with the Open vSwitch hardware offloading feature. If you set this field to <b>true</b>, you do not receive the performance benefits of the offloading because egress traffic is processed by the host networking stack.</p>

### Example OVN-Kubernetes configuration with IPsec enabled

```

defaultNetwork:
  type: OVNKubernetes
  ovnKubernetesConfig:
    mtu: 1400
    genevePort: 6081
    ipsecConfig: {}

```

### kubeProxyConfig object configuration

The values for the **kubeProxyConfig** object are defined in the following table:

Table 8.21. kubeProxyConfig object

Field	Type	Description
<b>iptablesSyncPeriod</b>	<b>string</b>	<p>The refresh period for <b>iptables</b> rules. The default value is <b>30s</b>. Valid suffixes include <b>s</b>, <b>m</b>, and <b>h</b> and are described in the <a href="#">Go time package</a> documentation.</p> <div style="display: flex; align-items: flex-start;">  <div> <p><b>NOTE</b></p> <p>Because of performance improvements introduced in OpenShift Container Platform 4.3 and greater, adjusting the <b>iptablesSyncPeriod</b> parameter is no longer necessary.</p> </div> </div>
<b>proxyArguments.iptables-min-sync-period</b>	<b>array</b>	<p>The minimum duration before refreshing <b>iptables</b> rules. This field ensures that the refresh does not happen too frequently. Valid suffixes include <b>s</b>, <b>m</b>, and <b>h</b> and are described in the <a href="#">Go time package</a>. The default value is:</p> <pre>kubeProxyConfig:   proxyArguments:     iptables-min-sync-period:       - 0s</pre>

## 8.6.10. Deploying the cluster

You can install OpenShift Container Platform on a compatible cloud platform.



### IMPORTANT

You can run the **create cluster** command of the installation program only once, during initial installation.

### Prerequisites

- Configure an account with the cloud platform that hosts your cluster.
- Obtain the OpenShift Container Platform installation program and the pull secret for your cluster.

### Procedure

1. Change to the directory that contains the installation program and initialize the cluster deployment:

```
$ ./openshift-install create cluster --dir <installation_directory> \ 1
--log-level=info 2
```

- 1 For `<installation_directory>`, specify the
- 2 To view different installation details, specify **warn**, **debug**, or **error** instead of **info**.



#### NOTE

If the cloud provider account that you configured on your host does not have sufficient permissions to deploy the cluster, the installation process stops, and the missing permissions are displayed.

When the cluster deployment completes, directions for accessing your cluster, including a link to its web console and credentials for the **kubeadmin** user, display in your terminal.

#### Example output

```
...
INFO Install complete!
INFO To access the cluster as the system:admin user when using 'oc', run 'export
KUBECONFIG=/home/myuser/install_dir/auth/kubeconfig'
INFO Access the OpenShift web-console here: https://console-openshift-
console.apps.mycluster.example.com
INFO Login to the console with user: "kubeadmin", and password: "4vYBz-Ee6gm-ymBZj-
Wt5AL"
INFO Time elapsed: 36m22s
```



#### NOTE

The cluster access and credential information also outputs to `<installation_directory>/openshift_install.log` when an installation succeeds.



#### IMPORTANT

- The Ignition config files that the installation program generates contain certificates that expire after 24 hours, which are then renewed at that time. If the cluster is shut down before renewing the certificates and the cluster is later restarted after the 24 hours have elapsed, the cluster automatically recovers the expired certificates. The exception is that you must manually approve the pending **node-bootstrapper** certificate signing requests (CSRs) to recover kubelet certificates. See the documentation for *Recovering from expired control plane certificates* for more information.
- It is recommended that you use Ignition config files within 12 hours after they are generated because the 24-hour certificate rotates from 16 to 22 hours after the cluster is installed. By using the Ignition config files within 12 hours, you can avoid installation failure if the certificate update runs during installation.

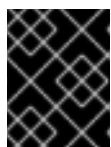

#### IMPORTANT

You must not delete the installation program or the files that the installation program creates. Both are required to delete the cluster.

## 8.6.11. Installing the OpenShift CLI by downloading the binary

You can install the OpenShift CLI (**oc**) to interact with OpenShift Container Platform from a command-line interface. You can install **oc** on Linux, Windows, or macOS.

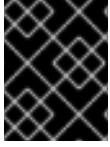

### IMPORTANT

If you installed an earlier version of **oc**, you cannot use it to complete all of the commands in OpenShift Container Platform 4.10. Download and install the new version of **oc**.

### Installing the OpenShift CLI on Linux

You can install the OpenShift CLI (**oc**) binary on Linux by using the following procedure.

#### Procedure

1. Navigate to the [OpenShift Container Platform downloads page](#) on the Red Hat Customer Portal.
2. Select the appropriate version in the **Version** drop-down menu.
3. Click **Download Now** next to the **OpenShift v4.10 Linux Client** entry and save the file.
4. Unpack the archive:

```
$ tar xvf <file>
```

5. Place the **oc** binary in a directory that is on your **PATH**.  
To check your **PATH**, execute the following command:

```
$ echo $PATH
```

After you install the OpenShift CLI, it is available using the **oc** command:

```
$ oc <command>
```

### Installing the OpenShift CLI on Windows

You can install the OpenShift CLI (**oc**) binary on Windows by using the following procedure.

#### Procedure

1. Navigate to the [OpenShift Container Platform downloads page](#) on the Red Hat Customer Portal.
2. Select the appropriate version in the **Version** drop-down menu.
3. Click **Download Now** next to the **OpenShift v4.10 Windows Client** entry and save the file.
4. Unzip the archive with a ZIP program.
5. Move the **oc** binary to a directory that is on your **PATH**.  
To check your **PATH**, open the command prompt and execute the following command:

```
C:\> path
```

After you install the OpenShift CLI, it is available using the **oc** command:

```
C:\> oc <command>
```

### Installing the OpenShift CLI on macOS

You can install the OpenShift CLI (**oc**) binary on macOS by using the following procedure.

#### Procedure

1. Navigate to the [OpenShift Container Platform downloads page](#) on the Red Hat Customer Portal.
2. Select the appropriate version in the **Version** drop-down menu.
3. Click **Download Now** next to the **OpenShift v4.10 MacOSX Client** entry and save the file.
4. Unpack and unzip the archive.
5. Move the **oc** binary to a directory on your PATH.  
To check your **PATH**, open a terminal and execute the following command:

```
$ echo $PATH
```

After you install the OpenShift CLI, it is available using the **oc** command:

```
$ oc <command>
```

### 8.6.12. Logging in to the cluster by using the CLI

You can log in to your cluster as a default system user by exporting the cluster **kubeconfig** file. The **kubeconfig** file contains information about the cluster that is used by the CLI to connect a client to the correct cluster and API server. The file is specific to a cluster and is created during OpenShift Container Platform installation.

#### Prerequisites

- You deployed an OpenShift Container Platform cluster.
- You installed the **oc** CLI.

#### Procedure

1. Export the **kubeadmin** credentials:

```
$ export KUBECONFIG=<installation_directory>/auth/kubeconfig 1
```

- 1** For **<installation\_directory>**, specify the path to the directory that you stored the installation files in.

2. Verify you can run **oc** commands successfully using the exported configuration:

```
$ oc whoami
```

## Example output

```
system:admin
```

### Additional resources

- See [Accessing the web console](#) for more details about accessing and understanding the OpenShift Container Platform web console.

### 8.6.13. Telemetry access for OpenShift Container Platform

In OpenShift Container Platform 4.10, the Telemetry service, which runs by default to provide metrics about cluster health and the success of updates, requires internet access. If your cluster is connected to the internet, Telemetry runs automatically, and your cluster is registered to [OpenShift Cluster Manager](#).

After you confirm that your [OpenShift Cluster Manager](#) inventory is correct, either maintained automatically by Telemetry or manually by using OpenShift Cluster Manager, [use subscription watch](#) to track your OpenShift Container Platform subscriptions at the account or multi-cluster level.

### Additional resources

- See [About remote health monitoring](#) for more information about the Telemetry service

### 8.6.14. Next steps

- [Customize your cluster](#).
- If necessary, you can [opt out of remote health reporting](#).

## 8.7. INSTALLING A CLUSTER ON GCP IN A RESTRICTED NETWORK

In OpenShift Container Platform 4.10, you can install a cluster on Google Cloud Platform (GCP) in a restricted network by creating an internal mirror of the installation release content on an existing Google Virtual Private Cloud (VPC).

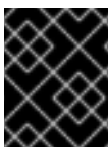

### IMPORTANT

You can install an OpenShift Container Platform cluster by using mirrored installation release content, but your cluster will require internet access to use the GCP APIs.

### 8.7.1. Prerequisites

- You reviewed details about the [OpenShift Container Platform installation and update](#) processes.
- You read the documentation on [selecting a cluster installation method and preparing it for users](#).
- You [configured a GCP project](#) to host the cluster.
- You [mirrored the images for a disconnected installation](#) to your registry and obtained the **imageContentSources** data for your version of OpenShift Container Platform.

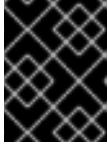

## IMPORTANT

Because the installation media is on the mirror host, you can use that computer to complete all installation steps.

- You have an existing VPC in GCP. While installing a cluster in a restricted network that uses installer-provisioned infrastructure, you cannot use the installer-provisioned VPC. You must use a user-provisioned VPC that satisfies one of the following requirements:
  - Contains the mirror registry
  - Has firewall rules or a peering connection to access the mirror registry hosted elsewhere
- If you use a firewall, you [configured it to allow the sites](#) that your cluster requires access to. While you might need to grant access to more sites, you must grant access to **\*.googleapis.com** and **accounts.google.com**.
- If the cloud identity and access management (IAM) APIs are not accessible in your environment, or if you do not want to store an administrator-level credential secret in the **kube-system** namespace, you can [manually create and maintain IAM credentials](#).

### 8.7.2. About installations in restricted networks

In OpenShift Container Platform 4.10, you can perform an installation that does not require an active connection to the internet to obtain software components. Restricted network installations can be completed using installer-provisioned infrastructure or user-provisioned infrastructure, depending on the cloud platform to which you are installing the cluster.

If you choose to perform a restricted network installation on a cloud platform, you still require access to its cloud APIs. Some cloud functions, like Amazon Web Service's Route 53 DNS and IAM services, require internet access. Depending on your network, you might require less internet access for an installation on bare metal hardware or on VMware vSphere.

To complete a restricted network installation, you must create a registry that mirrors the contents of the OpenShift image registry and contains the installation media. You can create this registry on a mirror host, which can access both the internet and your closed network, or by using other methods that meet your restrictions.

#### 8.7.2.1. Additional limits

Clusters in restricted networks have the following additional limitations and restrictions:

- The **ClusterVersion** status includes an **Unable to retrieve available updates** error.
- By default, you cannot use the contents of the Developer Catalog because you cannot access the required image stream tags.

### 8.7.3. Internet access for OpenShift Container Platform

In OpenShift Container Platform 4.10, you require access to the internet to obtain the images that are necessary to install your cluster.

You must have internet access to:



- Access [OpenShift Cluster Manager](#) to download the installation program and perform subscription management. If the cluster has internet access and you do not disable Telemetry, that service automatically entitles your cluster.
- Access [Quay.io](#) to obtain the packages that are required to install your cluster.
- Obtain the packages that are required to perform cluster updates.



### IMPORTANT

If your cluster cannot have direct internet access, you can perform a restricted network installation on some types of infrastructure that you provision. During that process, you download the required content and use it to populate a mirror registry with the installation packages. With some installation types, the environment that you install your cluster in will not require internet access. Before you update the cluster, you update the content of the mirror registry.

#### 8.7.4. Generating a key pair for cluster node SSH access

During an OpenShift Container Platform installation, you can provide an SSH public key to the installation program. The key is passed to the Red Hat Enterprise Linux CoreOS (RHCOS) nodes through their Ignition config files and is used to authenticate SSH access to the nodes. The key is added to the `~/.ssh/authorized_keys` list for the **core** user on each node, which enables password-less authentication.

After the key is passed to the nodes, you can use the key pair to SSH in to the RHCOS nodes as the user **core**. To access the nodes through SSH, the private key identity must be managed by SSH for your local user.

If you want to SSH in to your cluster nodes to perform installation debugging or disaster recovery, you must provide the SSH public key during the installation process. The `./openshift-install gather` command also requires the SSH public key to be in place on the cluster nodes.



### IMPORTANT

Do not skip this procedure in production environments, where disaster recovery and debugging is required.



### NOTE

You must use a local key, not one that you configured with platform-specific approaches such as [AWS key pairs](#).

#### Procedure

1. If you do not have an existing SSH key pair on your local machine to use for authentication onto your cluster nodes, create one. For example, on a computer that uses a Linux operating system, run the following command:

```
$ ssh-keygen -t ed25519 -N "" -f <path>/<file_name> 1
```

- 1 Specify the path and file name, such as `~/.ssh/id_ed25519`, of the new SSH key. If you have an existing key pair, ensure your public key is in the your `~/.ssh` directory.

**NOTE**

If you plan to install an OpenShift Container Platform cluster that uses FIPS validated or Modules In Process cryptographic libraries on the **x86\_64** architecture, do not create a key that uses the **ed25519** algorithm. Instead, create a key that uses the **rsa** or **ecdsa** algorithm.

- View the public SSH key:

```
$ cat <path>/<file_name>.pub
```

For example, run the following to view the `~/.ssh/id_ed25519.pub` public key:

```
$ cat ~/.ssh/id_ed25519.pub
```

- Add the SSH private key identity to the SSH agent for your local user, if it has not already been added. SSH agent management of the key is required for password-less SSH authentication onto your cluster nodes, or if you want to use the `./openshift-install gather` command.

**NOTE**

On some distributions, default SSH private key identities such as `~/.ssh/id_rsa` and `~/.ssh/id_dsa` are managed automatically.

- If the **ssh-agent** process is not already running for your local user, start it as a background task:

```
$ eval "$(ssh-agent -s)"
```

**Example output**

```
Agent pid 31874
```

**NOTE**

If your cluster is in FIPS mode, only use FIPS-compliant algorithms to generate the SSH key. The key must be either RSA or ECDSA.

- Add your SSH private key to the **ssh-agent**:

```
$ ssh-add <path>/<file_name> 1
```

- 1** Specify the path and file name for your SSH private key, such as `~/.ssh/id_ed25519`

**Example output**

```
Identity added: /home/<you>/<path>/<file_name> (<computer_name>)
```

- Set the **GOOGLE\_APPLICATION\_CREDENTIALS** environment variable to the full path to your service account private key file.

```
$ export GOOGLE_APPLICATION_CREDENTIALS="<your_service_account_file>"
```

6. Verify that the credentials were applied.

```
$ gcloud auth list
```

### Next steps

- When you install OpenShift Container Platform, provide the SSH public key to the installation program.

## 8.7.5. Creating the installation configuration file

You can customize the OpenShift Container Platform cluster you install on Google Cloud Platform (GCP).

### Prerequisites

- Obtain the OpenShift Container Platform installation program and the pull secret for your cluster. For a restricted network installation, these files are on your mirror host.
- Have the **imageContentSources** values that were generated during mirror registry creation.
- Obtain the contents of the certificate for your mirror registry.
- Obtain service principal permissions at the subscription level.

### Procedure

1. Create the **install-config.yaml** file.
  - a. Change to the directory that contains the installation program and run the following command:

```
$ ./openshift-install create install-config --dir <installation_directory> 1
```

- 1** For **<installation\_directory>**, specify the directory name to store the files that the installation program creates.



### IMPORTANT

Specify an empty directory. Some installation assets, like bootstrap X.509 certificates have short expiration intervals, so you must not reuse an installation directory. If you want to reuse individual files from another cluster installation, you can copy them into your directory. However, the file names for the installation assets might change between releases. Use caution when copying installation files from an earlier OpenShift Container Platform version.

- b. At the prompts, provide the configuration details for your cloud:
  - i. Optional: Select an SSH key to use to access your cluster machines.

**NOTE**

For production OpenShift Container Platform clusters on which you want to perform installation debugging or disaster recovery, specify an SSH key that your **ssh-agent** process uses.

- ii. Select **gcp** as the platform to target.
  - iii. If you have not configured the service account key for your GCP account on your computer, you must obtain it from GCP and paste the contents of the file or enter the absolute path to the file.
  - iv. Select the project ID to provision the cluster in. The default value is specified by the service account that you configured.
  - v. Select the region to deploy the cluster to.
  - vi. Select the base domain to deploy the cluster to. The base domain corresponds to the public DNS zone that you created for your cluster.
  - vii. Enter a descriptive name for your cluster.
  - viii. Paste the [pull secret from the Red Hat OpenShift Cluster Manager](#) .
2. Edit the **install-config.yaml** file to give the additional information that is required for an installation in a restricted network.
    - a. Update the **pullSecret** value to contain the authentication information for your registry:

```
pullSecret: '{"auths":{"<mirror_host_name>:5000": {"auth": "<credentials>","email": "you@example.com"}}}'
```

For **<mirror\_host\_name>**, specify the registry domain name that you specified in the certificate for your mirror registry, and for **<credentials>**, specify the base64-encoded user name and password for your mirror registry.

- b. Add the **additionalTrustBundle** parameter and value.

```
additionalTrustBundle: |
  -----BEGIN CERTIFICATE-----
  /-----END CERTIFICATE-----
```

The value must be the contents of the certificate file that you used for your mirror registry. The certificate file can be an existing, trusted certificate authority, or the self-signed certificate that you generated for the mirror registry.

- c. Define the network and subnets for the VPC to install the cluster in under the parent **platform.gcp** field:

```
network: <existing_vpc>
controlPlaneSubnet: <control_plane_subnet>
computeSubnet: <compute_subnet>
```

5. **platform.gcp.network** field is required only if you are installing on GCP VPC F

For **platform.gcp.network**, specify the name for the existing Google VPC. For **platform.gcp.controlPlaneSubnet** and **platform.gcp.computeSubnet**, specify the existing subnets to deploy the control plane machines and compute machines, respectively.

- d. Add the image content resources, which resemble the following YAML excerpt:

```
imageContentSources:
- mirrors:
  - <mirror_host_name>:5000/<repo_name>/release
    source: quay.io/openshift-release-dev/ocp-release
- mirrors:
  - <mirror_host_name>:5000/<repo_name>/release
    source: registry.redhat.io/ocp/release
```

For these values, use the **imageContentSources** that you recorded during mirror registry creation.

3. Make any other modifications to the **install-config.yaml** file that you require. You can find more information about the available parameters in the **Installation configuration parameters** section.
4. Back up the **install-config.yaml** file so that you can use it to install multiple clusters.

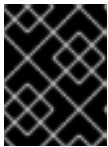

#### IMPORTANT

The **install-config.yaml** file is consumed during the installation process. If you want to reuse the file, you must back it up now.

### 8.7.5.1. Installation configuration parameters

Before you deploy an OpenShift Container Platform cluster, you provide parameter values to describe your account on the cloud platform that hosts your cluster and optionally customize your cluster's platform. When you create the **install-config.yaml** installation configuration file, you provide values for the required parameters through the command line. If you customize your cluster, you can modify the **install-config.yaml** file to provide more details about the platform.

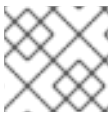

#### NOTE

After installation, you cannot modify these parameters in the **install-config.yaml** file.

#### 8.7.5.1.1. Required configuration parameters

Required installation configuration parameters are described in the following table:

Table 8.22. Required parameters

Parameter	Description	Values
<b>apiVersion</b>	The API version for the <b>install-config.yaml</b> content. The current version is <b>v1</b> . The installer may also support older API versions.	String

Parameter	Description	Values
<b>baseDomain</b>	The base domain of your cloud provider. The base domain is used to create routes to your OpenShift Container Platform cluster components. The full DNS name for your cluster is a combination of the <b>baseDomain</b> and <b>metadata.name</b> parameter values that uses the <b>&lt;metadata.name&gt;.&lt;baseDomain&gt;</b> format.	A fully-qualified domain or subdomain name, such as <b>example.com</b> .
<b>metadata</b>	Kubernetes resource <b>ObjectMeta</b> , from which only the <b>name</b> parameter is consumed.	Object
<b>metadata.name</b>	The name of the cluster. DNS records for the cluster are all subdomains of <b>{{.metadata.name}}.{{.baseDomain}}</b> .	String of lowercase letters, hyphens (-), and periods (.), such as <b>dev</b> .
<b>platform</b>	The configuration for the specific platform upon which to perform the installation: <b>alibabacloud, aws, baremetal, azure, gcp, ibmcloud, openstack, ovirt, vsphere</b> , or <b>{}</b> . For additional information about <b>platform.&lt;platform&gt;</b> parameters, consult the table for your specific platform that follows.	Object

Parameter	Description	Values
<b>pullSecret</b>	Get a <a href="#">pull secret from the Red Hat OpenShift Cluster Manager</a> to authenticate downloading container images for OpenShift Container Platform components from services such as Quay.io.	<pre>{   "auths":{     "cloud.openshift.com":{       "auth":"b3Blb=",       "email":"you@example.com"     },     "quay.io":{       "auth":"b3Blb=",       "email":"you@example.com"     }   } }</pre>

### 8.7.5.1.2. Network configuration parameters

You can customize your installation configuration based on the requirements of your existing network infrastructure. For example, you can expand the IP address block for the cluster network or provide different IP address blocks than the defaults.

Only IPv4 addresses are supported.

Table 8.23. Network parameters

Parameter	Description	Values
<b>networking</b>	The configuration for the cluster network.	Object <div style="display: flex; align-items: center; margin-top: 10px;">  <div> <p><b>NOTE</b></p> <p>You cannot modify parameters specified by the <b>networking</b> object after installation.</p> </div> </div>
<b>networking.networkType</b>	The cluster network provider Container Network Interface (CNI) plugin to install.	Either <b>OpenShiftSDN</b> or <b>OVNKubernetes</b> . <b>OpenShiftSDN</b> is a CNI provider for all-Linux networks. <b>OVNKubernetes</b> is a CNI provider for Linux networks and hybrid networks that contain both Linux and Windows servers. The default value is <b>OpenShiftSDN</b> .

Parameter	Description	Values
<b>networking.clusterNetwork</b>	<p>The IP address blocks for pods.</p> <p>The default value is <b>10.128.0.0/14</b> with a host prefix of <b>/23</b>.</p> <p>If you specify multiple IP address blocks, the blocks must not overlap.</p>	<p>An array of objects. For example:</p> <pre>networking:   clusterNetwork:     - cidr: 10.128.0.0/14       hostPrefix: 23</pre>
<b>networking.clusterNetwork.cidr</b>	<p>Required if you use <b>networking.clusterNetwork</b>. An IP address block.</p> <p>An IPv4 network.</p>	<p>An IP address block in Classless Inter-Domain Routing (CIDR) notation. The prefix length for an IPv4 block is between <b>0</b> and <b>32</b>.</p>
<b>networking.clusterNetwork.hostPrefix</b>	<p>The subnet prefix length to assign to each individual node. For example, if <b>hostPrefix</b> is set to <b>23</b> then each node is assigned a <b>/23</b> subnet out of the given <b>cidr</b>. A <b>hostPrefix</b> value of <b>23</b> provides 510 (<math>2^{(32 - 23)} - 2</math>) pod IP addresses.</p>	<p>A subnet prefix.</p> <p>The default value is <b>23</b>.</p>
<b>networking.serviceNetwork</b>	<p>The IP address block for services. The default value is <b>172.30.0.0/16</b>.</p> <p>The OpenShift SDN and OVN-Kubernetes network providers support only a single IP address block for the service network.</p>	<p>An array with an IP address block in CIDR format. For example:</p> <pre>networking:   serviceNetwork:     - 172.30.0.0/16</pre>
<b>networking.machineNetwork</b>	<p>The IP address blocks for machines.</p> <p>If you specify multiple IP address blocks, the blocks must not overlap.</p>	<p>An array of objects. For example:</p> <pre>networking:   machineNetwork:     - cidr: 10.0.0.0/16</pre>
<b>networking.machineNetwork.cidr</b>	<p>Required if you use <b>networking.machineNetwork</b>. An IP address block. The default value is <b>10.0.0.0/16</b> for all platforms other than libvirt. For libvirt, the default value is <b>192.168.126.0/24</b>.</p>	<p>An IP network block in CIDR notation.</p> <p>For example, <b>10.0.0.0/16</b>.</p> <div style="display: flex; align-items: flex-start;">  <div> <p><b>NOTE</b></p> <p>Set the <b>networking.machineNetwork</b> to match the CIDR that the preferred NIC resides in.</p> </div> </div>





## 8.7.5.1.3. Optional configuration parameters

Optional installation configuration parameters are described in the following table:

Table 8.24. Optional parameters

Parameter	Description	Values
<b>additionalTrustBundle</b>	A PEM-encoded X.509 certificate bundle that is added to the nodes' trusted certificate store. This trust bundle may also be used when a proxy has been configured.	String
<b>cgroupsV2</b>	Enables <a href="#">Linux control groups version 2</a> (cgroups v2) on specific nodes in your cluster. The OpenShift Container Platform process for enabling cgroups v2 disables all cgroup version 1 controllers and hierarchies. The OpenShift Container Platform cgroups version 2 feature is in Developer Preview and is not supported by Red Hat at this time.	<b>true</b>
<b>compute</b>	The configuration for the machines that comprise the compute nodes.	Array of <b>MachinePool</b> objects.
<b>compute.architecture</b>	Determines the instruction set architecture of the machines in the pool. Currently, clusters with varied architectures are not supported. All pools must specify the same architecture. Valid values are <b>amd64</b> (the default).	String
<b>compute.hyperthreading</b>	Whether to enable or disable simultaneous multithreading, or <b>hyperthreading</b> , on compute machines. By default, simultaneous multithreading is enabled to increase the performance of your machines' cores.	<b>Enabled</b> or <b>Disabled</b>
	 <p><b>IMPORTANT</b></p> <p>If you disable simultaneous multithreading, ensure that your capacity planning accounts for the dramatically decreased machine performance.</p>	

Parameter	Description	Values
<b>compute.name</b>	Required if you use <b>compute</b> . The name of the machine pool.	<b>worker</b>
<b>compute.platform</b>	Required if you use <b>compute</b> . Use this parameter to specify the cloud provider to host the worker machines. This parameter value must match the <b>controlPlane.platform</b> parameter value.	<b>alibabacloud, aws, azure, gcp, ibmcloud, openstack, ovirt, vsphere, or {}</b>
<b>compute.replicas</b>	The number of compute machines, which are also known as worker machines, to provision.	A positive integer greater than or equal to <b>2</b> . The default value is <b>3</b> .
<b>controlPlane</b>	The configuration for the machines that comprise the control plane.	Array of <b>MachinePool</b> objects.
<b>controlPlane.architecture</b>	Determines the instruction set architecture of the machines in the pool. Currently, clusters with varied architectures are not supported. All pools must specify the same architecture. Valid values are <b>amd64</b> (the default).	String
<b>controlPlane.hyperthreading</b>	<p>Whether to enable or disable simultaneous multithreading, or <b>hyperthreading</b>, on control plane machines. By default, simultaneous multithreading is enabled to increase the performance of your machines' cores.</p> <div style="display: flex; align-items: flex-start;"> <div style="background-color: black; width: 60px; height: 100px; margin-right: 10px; position: relative;">  </div> <div> <p><b>IMPORTANT</b></p> <p>If you disable simultaneous multithreading, ensure that your capacity planning accounts for the dramatically decreased machine performance.</p> </div> </div>	<b>Enabled</b> or <b>Disabled</b>
<b>controlPlane.name</b>	Required if you use <b>controlPlane</b> . The name of the machine pool.	<b>master</b>

Parameter	Description	Values
<b>controlPlane.platform</b>	Required if you use <b>controlPlane</b> . Use this parameter to specify the cloud provider that hosts the control plane machines. This parameter value must match the <b>compute.platform</b> parameter value.	<b>alibabacloud, aws, azure, gcp, ibmcloud, openstack, ovirt, vsphere</b> , or {}
<b>controlPlane.replicas</b>	The number of control plane machines to provision.	The only supported value is <b>3</b> , which is the default value.
<b>credentialsMode</b>	<p>The Cloud Credential Operator (CCO) mode. If no mode is specified, the CCO dynamically tries to determine the capabilities of the provided credentials, with a preference for mint mode on the platforms where multiple modes are supported. If you are installing on GCP into a shared virtual private cloud (VPC), <b>credentialsMode</b> must be set to <b>Passthrough</b>.</p> <p> <b>NOTE</b></p> <p>Not all CCO modes are supported for all cloud providers. For more information on CCO modes, see the <i>Cloud Credential Operator</i> entry in the <i>Cluster Operators reference</i> content.</p> <p> <b>NOTE</b></p> <p>If your AWS account has service control policies (SCP) enabled, you must configure the <b>credentialsMode</b> parameter to <b>Mint</b>, <b>Passthrough</b> or <b>Manual</b>.</p>	<b>Mint, Passthrough, Manual</b> or an empty string ("").

Parameter	Description	Values
<b>fips</b>	<p>Enable or disable FIPS mode. The default is <b>false</b> (disabled). If FIPS mode is enabled, the Red Hat Enterprise Linux CoreOS (RHCOS) machines that OpenShift Container Platform runs on bypass the default Kubernetes cryptography suite and use the cryptography modules that are provided with RHCOS instead.</p> <div data-bbox="486 584 592 1361" style="background-color: black; color: white; padding: 5px; margin-bottom: 10px;"> <p><b>IMPORTANT</b></p> <p>To enable FIPS mode for your cluster, you must run the installation program from a Red Hat Enterprise Linux (RHEL) computer configured to operate in FIPS mode. For more information about configuring FIPS mode on RHEL, see <a href="#">Installing the system in FIPS mode</a>. The use of FIPS validated or Modules In Process cryptographic libraries is only supported on OpenShift Container Platform deployments on the <b>x86_64</b> architecture.</p> </div> <div data-bbox="486 1406 592 1603" style="background-color: #f0f0f0; padding: 5px;"> <p><b>NOTE</b></p> <p>If you are using Azure File storage, you cannot enable FIPS mode.</p> </div>	<b>false</b> or <b>true</b>
<b>imageContentSources</b>	Sources and repositories for the release-image content.	Array of objects. Includes a <b>source</b> and, optionally, <b>mirrors</b> , as described in the following rows of this table.

Parameter	Description	Values
<b>imageContentSources.source</b>	Required if you use <b>imageContentSources</b> . Specify the repository that users refer to, for example, in image pull specifications.	String
<b>imageContentSources.mirrors</b>	Specify one or more repositories that may also contain the same images.	Array of strings
<b>publish</b>	How to publish or expose the user-facing endpoints of your cluster, such as the Kubernetes API, OpenShift routes.	<b>Internal</b> or <b>External</b> . To deploy a private cluster, which cannot be accessed from the internet, set <b>publish</b> to <b>Internal</b> . The default value is <b>External</b> .
<b>sshKey</b>	<p>The SSH key or keys to authenticate access your cluster machines.</p>  <p><b>NOTE</b></p> <p>For production OpenShift Container Platform clusters on which you want to perform installation debugging or disaster recovery, specify an SSH key that your <b>ssh-agent</b> process uses.</p>	<p>One or more keys. For example:</p> <pre>sshKey:   &lt;key1&gt;   &lt;key2&gt;   &lt;key3&gt;</pre>

#### 8.7.5.1.4. Additional Google Cloud Platform (GCP) configuration parameters

Additional GCP configuration parameters are described in the following table:

Table 8.25. Additional GCP parameters

Parameter	Description	Values
<code>platform.gcp.network</code>	The name of the existing VPC that you want to deploy your cluster to.	String.
<code>platform.gcp.region</code>	The name of the GCP region that hosts your cluster.	Any valid region name, such as <b>us-central1</b> .
<code>platform.gcp.type</code>	The <a href="#">GCP machine type</a> .	The GCP machine type.
<code>platform.gcp.zones</code>	The availability zones where the installation program creates machines for the specified MachinePool.	A list of valid <a href="#">GCP availability zones</a> , such as <b>us-central1-a</b> , in a <a href="#">YAML sequence</a> .
<code>platform.gcp.controlPlaneSubnet</code>	The name of the existing subnet in your VPC that you want to deploy your control plane machines to.	The subnet name.
<code>platform.gcp.computeSubnet</code>	The name of the existing subnet in your VPC that you want to deploy your compute machines to.	The subnet name.
<code>platform.gcp.licenses</code>	<p>A list of license URLs that must be applied to the compute images.</p> <div style="display: flex; align-items: flex-start;">  <div> <p><b>IMPORTANT</b></p> <p>The <b>licenses</b> parameter is a deprecated field and nested virtualization is enabled by default. It is not recommended to use this field.</p> </div> </div>	Any license available with the <a href="#">license API</a> , such as the license to enable <a href="#">nested virtualization</a> . You cannot use this parameter with a mechanism that generates pre-built images. Using a license URL forces the installer to copy the source image before use.

Parameter	Description	Values
<b>platform.gcp.osDiskSizeGB</b>	The size of the disk in gigabytes (GB).	Any size between 16 GB and 65536 GB.
<b>platform.gcp.osDiskType</b>	The type of disk.	Either the default <b>pd-ssd</b> or the <b>pd-standard</b> disk type. The control plane nodes must be the <b>pd-ssd</b> disk type. The worker nodes can be either type.
<b>controlplane.platform.gcp.osDiskEncryptionKey.kmsKeyName</b>	The name of the customer managed encryption key to be used for control plane machine disk encryption.	The encryption key name.
<b>controlplane.platform.gcp.osDiskEncryptionKey.kmsKeyRing</b>	For control plane machines, the name of the KMS key ring to which the KMS key belongs.	The KMS key ring name.
<b>controlplane.platform.gcp.osDiskEncryptionKey.kmsLocation</b>	For control plane machines, the GCP location in which the key ring exists. For more information on KMS locations, see Google's documentation on <a href="#">Cloud KMS locations</a> .	The GCP location for the key ring.

Parameter	Description	Values
<b>controlPlane.platform.gcp.osDisk.encryptionKey.kmsKey.projectID</b>	For control plane machines, the ID of the project in which the KMS key ring exists. This value defaults to the VM project ID if not set.	The GCP project ID.
<b>compute.platform.gcp.osDisk.encryptionKey.kmsKeyName</b>	The name of the customer managed encryption key to be used for compute machine disk encryption.	The encryption key name.
<b>compute.platform.gcp.osDisk.encryptionKey.kmsKey.keyRing</b>	For compute machines, the name of the KMS key ring to which the KMS key belongs.	The KMS key ring name.
<b>compute.platform.gcp.osDisk.encryptionKey.location</b>	For compute machines, the GCP location in which the key ring exists. For more information on KMS locations, see Google's documentation on <a href="#">Cloud KMS locations</a> .	The GCP location for the key ring.



Parameter	Description	Values
<code>compute.platform.gcp.ossDisk.encryptionKey.kmsKey.projectID</code>	For compute machines, the ID of the project in which the KMS key ring exists. This value defaults to the VM project ID if not set.	The GCP project ID.

### 8.7.5.2. Minimum resource requirements for cluster installation

Each cluster machine must meet the following minimum requirements:

**Table 8.26. Minimum resource requirements**

Machine	Operating System	vCPU [1]	Virtual RAM	Storage	IOPS [2]
Bootstrap	RHCOS	4	16 GB	100 GB	300
Control plane	RHCOS	4	16 GB	100 GB	300
Compute	RHCOS, RHEL 8.4, or RHEL 8.5 <sup>[3]</sup>	2	8 GB	100 GB	300

1. One vCPU is equivalent to one physical core when simultaneous multithreading (SMT), or hyperthreading, is not enabled. When enabled, use the following formula to calculate the corresponding ratio:  $(\text{threads per core} \times \text{cores}) \times \text{sockets} = \text{vCPUs}$ .
2. OpenShift Container Platform and Kubernetes are sensitive to disk performance, and faster storage is recommended, particularly for etcd on the control plane nodes which require a 10 ms p99 fsync duration. Note that on many cloud platforms, storage size and IOPS scale together, so you might need to over-allocate storage volume to obtain sufficient performance.
3. As with all user-provisioned installations, if you choose to use RHEL compute machines in your cluster, you take responsibility for all operating system life cycle management and maintenance, including performing system updates, applying patches, and completing all other required tasks. Use of RHEL 7 compute machines is deprecated and has been removed in OpenShift Container Platform 4.10 and later.

If an instance type for your platform meets the minimum requirements for cluster machines, it is supported to use in OpenShift Container Platform.

### 8.7.5.3. Tested instance types for GCP

The following Google Cloud Platform instance types have been tested with OpenShift Container Platform.

#### Example 8.23. Machine series

- C2
- C2D
- C3
- E2
- M1
- N1
- N2
- N2D
- Tau T2D

#### 8.7.5.4. Using custom machine types

Using a custom machine type to install a OpenShift Container Platform cluster is supported.

Consider the following when using a custom machine type:

- Similar to predefined instance types, custom machine types must meet the minimum resource requirements for control plane and compute machines. For more information, see "Minimum resource requirements for cluster installation".
- The name of the custom machine type must adhere to the following syntax:  
**custom-`<number_of_cpus>`-`<amount_of_memory_in_mb>`**

For example, **custom-6-20480**.

As part of the installation process, you specify the custom machine type in the **install-config.yaml** file.

#### Sample install-config.yaml file with a custom machine type

```
compute:
- architecture: amd64
  hyperthreading: Enabled
  name: worker
  platform:
    gcp:
      type: custom-6-20480
  replicas: 2
controlPlane:
  architecture: amd64
  hyperthreading: Enabled
  name: master
  platform:
```

```

gcp:
  type: custom-6-20480
  replicas: 3

```

### 8.7.5.5. Sample customized install-config.yaml file for GCP

You can customize the **install-config.yaml** file to specify more details about your OpenShift Container Platform cluster's platform or modify the values of the required parameters.



#### IMPORTANT

This sample YAML file is provided for reference only. You must obtain your **install-config.yaml** file by using the installation program and modify it.

```

apiVersion: v1
baseDomain: example.com 1
controlPlane: 2 3
  hyperthreading: Enabled 4
  name: master
  platform:
    gcp:
      type: n2-standard-4
      zones:
      - us-central1-a
      - us-central1-c
    osDisk:
      diskType: pd-ssd
      diskSizeGB: 1024
      encryptionKey: 5
      kmsKey:
        name: worker-key
        keyRing: test-machine-keys
        location: global
        projectID: project-id
  replicas: 3
compute: 6 7
- hyperthreading: Enabled 8
  name: worker
  platform:
    gcp:
      type: n2-standard-4
      zones:
      - us-central1-a
      - us-central1-c
    osDisk:
      diskType: pd-standard
      diskSizeGB: 128
      encryptionKey: 9
      kmsKey:
        name: worker-key
        keyRing: test-machine-keys
        location: global
        projectID: project-id

```

```

replicas: 3
metadata:
  name: test-cluster 10
networking:
  clusterNetwork:
  - cidr: 10.128.0.0/14
    hostPrefix: 23
  machineNetwork:
  - cidr: 10.0.0.0/16
  networkType: OpenShiftSDN
  serviceNetwork:
  - 172.30.0.0/16
platform:
  gcp:
    projectID: openshift-production 11
    region: us-central1 12
    network: existing_vpc 13
    controlPlaneSubnet: control_plane_subnet 14
    computeSubnet: compute_subnet 15
  pullSecret: '{"auths":{"<local_registry>":{"auth": "<credentials>","email": "you@example.com"}}}' 16
  fips: false 17
  sshKey: ssh-ed25519 AAAA... 18
  additionalTrustBundle: | 19
    -----BEGIN CERTIFICATE-----
    <MY_TRUSTED_CA_CERT>
    -----END CERTIFICATE-----
  imageContentSources: 20
  - mirrors:
    - <local_registry>/<local_repository_name>/release
      source: quay.io/openshift-release-dev/ocp-release
  - mirrors:
    - <local_registry>/<local_repository_name>/release
      source: quay.io/openshift-release-dev/ocp-v4.0-art-dev

```

**1 10 11 12** Required. The installation program prompts you for this value.

**2 6** If you do not provide these parameters and values, the installation program provides the default value.

**3 7** The **controlPlane** section is a single mapping, but the **compute** section is a sequence of mappings. To meet the requirements of the different data structures, the first line of the **compute** section must begin with a hyphen, -, and the first line of the **controlPlane** section must not. Only one control plane pool is used.

**4 8** Whether to enable or disable simultaneous multithreading, or **hyperthreading**. By default, simultaneous multithreading is enabled to increase the performance of your machines' cores. You can disable it by setting the parameter value to **Disabled**. If you disable simultaneous multithreading in some cluster machines, you must disable it in all cluster machines.



### IMPORTANT

If you disable simultaneous multithreading, ensure that your capacity planning accounts for the dramatically decreased machine performance. Use larger machine types, such as **n1-standard-8**, for your machines if you disable simultaneous multithreading.

- 5 9 Optional: The custom encryption key section to encrypt both virtual machines and persistent volumes. Your default compute service account must have the permissions granted to use your KMS key and have the correct IAM role assigned. The default service account name follows the **service-`<project_number>`@compute-system.iam.gserviceaccount.com** pattern. For more information on granting the correct permissions for your service account, see "Machine management" → "Creating machine sets" → "Creating a machine set on GCP".
- 13 Specify the name of an existing VPC.
- 14 Specify the name of the existing subnet to deploy the control plane machines to. The subnet must belong to the VPC that you specified.
- 15 Specify the name of the existing subnet to deploy the compute machines to. The subnet must belong to the VPC that you specified.
- 16 For **<local\_registry>**, specify the registry domain name, and optionally the port, that your mirror registry uses to serve content. For example, **registry.example.com** or **registry.example.com:5000**. For **<credentials>**, specify the base64-encoded user name and password for your mirror registry.
- 17 Whether to enable or disable FIPS mode. By default, FIPS mode is not enabled. If FIPS mode is enabled, the Red Hat Enterprise Linux CoreOS (RHCOS) machines that OpenShift Container Platform runs on bypass the default Kubernetes cryptography suite and use the cryptography modules that are provided with RHCOS instead.



### IMPORTANT

To enable FIPS mode for your cluster, you must run the installation program from a Red Hat Enterprise Linux (RHEL) computer configured to operate in FIPS mode. For more information about configuring FIPS mode on RHEL, see [Installing the system in FIPS mode](#). The use of FIPS validated or Modules In Process cryptographic libraries is only supported on OpenShift Container Platform deployments on the **x86\_64** architecture.

- 18 You can optionally provide the **sshKey** value that you use to access the machines in your cluster.



### NOTE

For production OpenShift Container Platform clusters on which you want to perform installation debugging or disaster recovery, specify an SSH key that your **ssh-agent** process uses.

- 19 Provide the contents of the certificate file that you used for your mirror registry.
- 20 Provide the **imageContentSources** section from the output of the command to mirror the repository.

### 8.7.5.6. Create an Ingress Controller with global access on GCP

You can create an Ingress Controller that has global access to a Google Cloud Platform (GCP) cluster. Global access is only available to Ingress Controllers using internal load balancers.

#### Prerequisites

- You created the **install-config.yaml** and complete any modifications to it.

#### Procedure

Create an Ingress Controller with global access on a new GCP cluster.

- Change to the directory that contains the installation program and create a manifest file:

```
$ ./openshift-install create manifests --dir <installation_directory> 1
```

- For **<installation\_directory>**, specify the name of the directory that contains the **install-config.yaml** file for your cluster.

- Create a file that is named **cluster-ingress-default-ingresscontroller.yaml** in the **<installation\_directory>/manifests/** directory:

```
$ touch <installation_directory>/manifests/cluster-ingress-default-ingresscontroller.yaml 1
```

- For **<installation\_directory>**, specify the directory name that contains the **manifests/** directory for your cluster.

After creating the file, several network configuration files are in the **manifests/** directory, as shown:

```
$ ls <installation_directory>/manifests/cluster-ingress-default-ingresscontroller.yaml
```

#### Example output

```
cluster-ingress-default-ingresscontroller.yaml
```

- Open the **cluster-ingress-default-ingresscontroller.yaml** file in an editor and enter a custom resource (CR) that describes the Operator configuration you want:

#### Sample clientAccess configuration to Global

```
apiVersion: operator.openshift.io/v1
kind: IngressController
metadata:
  name: default
  namespace: openshift-ingress-operator
spec:
  endpointPublishingStrategy:
    loadBalancer:
      providerParameters:
        gcp:
```

```

clientAccess: Global ❶
type: GCP
scope: Internal ❷
type: LoadBalancerService

```

- ❶ Set `gcp.clientAccess` to **Global**.
- ❷ Global access is only available to Ingress Controllers using internal load balancers.

### 8.7.5.7. Configuring the cluster-wide proxy during installation

Production environments can deny direct access to the internet and instead have an HTTP or HTTPS proxy available. You can configure a new OpenShift Container Platform cluster to use a proxy by configuring the proxy settings in the `install-config.yaml` file.

#### Prerequisites

- You have an existing `install-config.yaml` file.
- You reviewed the sites that your cluster requires access to and determined whether any of them need to bypass the proxy. By default, all cluster egress traffic is proxied, including calls to hosting cloud provider APIs. You added sites to the **Proxy** object's `spec.noProxy` field to bypass the proxy if necessary.



#### NOTE

The **Proxy** object `status.noProxy` field is populated with the values of the `networking.machineNetwork[].cidr`, `networking.clusterNetwork[].cidr`, and `networking.serviceNetwork[]` fields from your installation configuration.

For installations on Amazon Web Services (AWS), Google Cloud Platform (GCP), Microsoft Azure, and Red Hat OpenStack Platform (RHOSP), the **Proxy** object `status.noProxy` field is also populated with the instance metadata endpoint (`169.254.169.254`).

#### Procedure

1. Edit your `install-config.yaml` file and add the proxy settings. For example:

```

apiVersion: v1
baseDomain: my.domain.com
proxy:
  httpProxy: http://<username>:<pswd>@<ip>:<port> ❶
  httpsProxy: https://<username>:<pswd>@<ip>:<port> ❷
  noProxy: example.com ❸
  additionalTrustBundle: | ❹
    -----BEGIN CERTIFICATE-----
    <MY_TRUSTED_CA_CERT>
    -----END CERTIFICATE-----
  ...

```

- ❶ A proxy URL to use for creating HTTP connections outside the cluster. The URL scheme must be **http**.

- 2 A proxy URL to use for creating HTTPS connections outside the cluster.
- 3 A comma-separated list of destination domain names, IP addresses, or other network CIDRs to exclude from proxying. Preface a domain with `.` to match subdomains only. For example, `.y.com` matches `x.y.com`, but not `y.com`. Use `*` to bypass the proxy for all destinations.
- 4 If provided, the installation program generates a config map that is named **user-ca-bundle** in the **openshift-config** namespace that contains one or more additional CA certificates that are required for proxying HTTPS connections. The Cluster Network Operator then creates a **trusted-ca-bundle** config map that merges these contents with the Red Hat Enterprise Linux CoreOS (RHCOS) trust bundle, and this config map is referenced in the **trustedCA** field of the **Proxy** object. The **additionalTrustBundle** field is required unless the proxy's identity certificate is signed by an authority from the RHCOS trust bundle.

**NOTE**

The installation program does not support the proxy **readinessEndpoints** field.

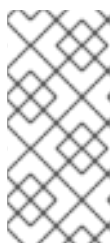
**NOTE**

If the installer times out, restart and then complete the deployment by using the **wait-for** command of the installer. For example:

```
$ ./openshift-install wait-for install-complete --log-level debug
```

2. Save the file and reference it when installing OpenShift Container Platform.

The installation program creates a cluster-wide proxy that is named **cluster** that uses the proxy settings in the provided **install-config.yaml** file. If no proxy settings are provided, a **cluster Proxy** object is still created, but it will have a nil **spec**.

**NOTE**

Only the **Proxy** object named **cluster** is supported, and no additional proxies can be created.

### 8.7.6. Deploying the cluster

You can install OpenShift Container Platform on a compatible cloud platform.

**IMPORTANT**

You can run the **create cluster** command of the installation program only once, during initial installation.

#### Prerequisites

- Configure an account with the cloud platform that hosts your cluster.
- Obtain the OpenShift Container Platform installation program and the pull secret for your cluster.



## Procedure

1. Remove any existing GCP credentials that do not use the service account key for the GCP account that you configured for your cluster and that are stored in the following locations:
  - The **GOOGLE\_CREDENTIALS**, **GOOGLE\_CLOUD\_KEYFILE\_JSON**, or **GKLOUD\_KEYFILE\_JSON** environment variables
  - The `~/.gcp/osServiceAccount.json` file
  - The **gcloud cli** default credentials
2. Change to the directory that contains the installation program and initialize the cluster deployment:

```
$ ./openshift-install create cluster --dir <installation_directory> \ 1
--log-level=info 2
```

- 1** For `<installation_directory>`, specify the location of your customized `./install-config.yaml` file.
- 2** To view different installation details, specify **warn**, **debug**, or **error** instead of **info**.

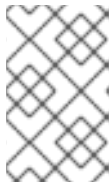

### NOTE

If the cloud provider account that you configured on your host does not have sufficient permissions to deploy the cluster, the installation process stops, and the missing permissions are displayed.

When the cluster deployment completes, directions for accessing your cluster, including a link to its web console and credentials for the **kubeadmin** user, display in your terminal.

### Example output

```
...
INFO Install complete!
INFO To access the cluster as the system:admin user when using 'oc', run 'export
KUBECONFIG=/home/myuser/install_dir/auth/kubeconfig'
INFO Access the OpenShift web-console here: https://console-openshift-
console.apps.mycluster.example.com
INFO Login to the console with user: "kubeadmin", and password: "4vYBz-Ee6gm-ymBZj-
Wt5AL"
INFO Time elapsed: 36m22s
```

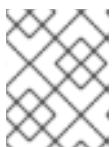

### NOTE

The cluster access and credential information also outputs to `<installation_directory>/openshift_install.log` when an installation succeeds.

**IMPORTANT**

- The Ignition config files that the installation program generates contain certificates that expire after 24 hours, which are then renewed at that time. If the cluster is shut down before renewing the certificates and the cluster is later restarted after the 24 hours have elapsed, the cluster automatically recovers the expired certificates. The exception is that you must manually approve the pending **node-bootstrapper** certificate signing requests (CSRs) to recover kubelet certificates. See the documentation for *Recovering from expired control plane certificates* for more information.
- It is recommended that you use Ignition config files within 12 hours after they are generated because the 24-hour certificate rotates from 16 to 22 hours after the cluster is installed. By using the Ignition config files within 12 hours, you can avoid installation failure if the certificate update runs during installation.

**IMPORTANT**

You must not delete the installation program or the files that the installation program creates. Both are required to delete the cluster.

3. Optional: You can reduce the number of permissions for the service account that you used to install the cluster.
  - If you assigned the **Owner** role to your service account, you can remove that role and replace it with the **Viewer** role.
  - If you included the **Service Account Key Admin** role, you can remove it.

### 8.7.7. Installing the OpenShift CLI by downloading the binary

You can install the OpenShift CLI (**oc**) to interact with OpenShift Container Platform from a command-line interface. You can install **oc** on Linux, Windows, or macOS.

**IMPORTANT**

If you installed an earlier version of **oc**, you cannot use it to complete all of the commands in OpenShift Container Platform 4.10. Download and install the new version of **oc**.

#### Installing the OpenShift CLI on Linux

You can install the OpenShift CLI (**oc**) binary on Linux by using the following procedure.

#### Procedure

1. Navigate to the [OpenShift Container Platform downloads page](#) on the Red Hat Customer Portal.
2. Select the appropriate version in the **Version** drop-down menu.
3. Click **Download Now** next to the **OpenShift v4.10 Linux Client** entry and save the file.
4. Unpack the archive:

```
$ tar xvf <file>
```

- 
- 5. Place the **oc** binary in a directory that is on your **PATH**.  
To check your **PATH**, execute the following command:

```
$ echo $PATH
```

After you install the OpenShift CLI, it is available using the **oc** command:

```
$ oc <command>
```

### Installing the OpenShift CLI on Windows

You can install the OpenShift CLI (**oc**) binary on Windows by using the following procedure.

#### Procedure

1. Navigate to the [OpenShift Container Platform downloads page](#) on the Red Hat Customer Portal.
2. Select the appropriate version in the **Version** drop-down menu.
3. Click **Download Now** next to the **OpenShift v4.10 Windows Client** entry and save the file.
4. Unzip the archive with a ZIP program.
5. Move the **oc** binary to a directory that is on your **PATH**.  
To check your **PATH**, open the command prompt and execute the following command:

```
C:\> path
```

After you install the OpenShift CLI, it is available using the **oc** command:

```
C:\> oc <command>
```

### Installing the OpenShift CLI on macOS

You can install the OpenShift CLI (**oc**) binary on macOS by using the following procedure.

#### Procedure

1. Navigate to the [OpenShift Container Platform downloads page](#) on the Red Hat Customer Portal.
2. Select the appropriate version in the **Version** drop-down menu.
3. Click **Download Now** next to the **OpenShift v4.10 MacOSX Client** entry and save the file.
4. Unpack and unzip the archive.
5. Move the **oc** binary to a directory on your **PATH**.  
To check your **PATH**, open a terminal and execute the following command:

```
$ echo $PATH
```

After you install the OpenShift CLI, it is available using the **oc** command:

```
$ oc <command>
```

### 8.7.8. Logging in to the cluster by using the CLI

You can log in to your cluster as a default system user by exporting the cluster **kubeconfig** file. The **kubeconfig** file contains information about the cluster that is used by the CLI to connect a client to the correct cluster and API server. The file is specific to a cluster and is created during OpenShift Container Platform installation.

#### Prerequisites

- You deployed an OpenShift Container Platform cluster.
- You installed the **oc** CLI.

#### Procedure

1. Export the **kubeadmin** credentials:

```
$ export KUBECONFIG=<installation_directory>/auth/kubeconfig 1
```

- 1** For **<installation\_directory>**, specify the path to the directory that you stored the installation files in.

2. Verify you can run **oc** commands successfully using the exported configuration:

```
$ oc whoami
```

#### Example output

```
system:admin
```

### 8.7.9. Disabling the default OperatorHub sources

Operator catalogs that source content provided by Red Hat and community projects are configured for OperatorHub by default during an OpenShift Container Platform installation. In a restricted network environment, you must disable the default catalogs as a cluster administrator.

#### Procedure

- Disable the sources for the default catalogs by adding **disableAllDefaultSources: true** to the **OperatorHub** object:

```
$ oc patch OperatorHub cluster --type json \  
-p [{"op": "add", "path": "/spec/disableAllDefaultSources", "value": true}]
```

#### TIP

Alternatively, you can use the web console to manage catalog sources. From the **Administration** → **Cluster Settings** → **Configuration** → **OperatorHub** page, click the **Sources** tab, where you can create, delete, disable, and enable individual sources.

### 8.7.10. Telemetry access for OpenShift Container Platform

In OpenShift Container Platform 4.10, the Telemetry service, which runs by default to provide metrics about cluster health and the success of updates, requires internet access. If your cluster is connected to the internet, Telemetry runs automatically, and your cluster is registered to [OpenShift Cluster Manager](#).

After you confirm that your [OpenShift Cluster Manager](#) inventory is correct, either maintained automatically by Telemetry or manually by using OpenShift Cluster Manager, [use subscription watch](#) to track your OpenShift Container Platform subscriptions at the account or multi-cluster level.

#### Additional resources

- See [About remote health monitoring](#) for more information about the Telemetry service

### 8.7.11. Next steps

- [Validate an installation](#).
- [Customize your cluster](#).
- [Configure image streams](#) for the Cluster Samples Operator and the **must-gather** tool.
- Learn how to [use Operator Lifecycle Manager \(OLM\) on restricted networks](#).
- If the mirror registry that you used to install your cluster has a trusted CA, add it to the cluster by [configuring additional trust stores](#).
- If necessary, you can [opt out of remote health reporting](#).
- If necessary, see [Registering your disconnected cluster](#)

## 8.8. INSTALLING A CLUSTER ON GCP INTO AN EXISTING VPC

In OpenShift Container Platform version 4.10, you can install a cluster into an existing Virtual Private Cloud (VPC) on Google Cloud Platform (GCP). The installation program provisions the rest of the required infrastructure, which you can further customize. To customize the installation, you modify parameters in the **install-config.yaml** file before you install the cluster.

### 8.8.1. Prerequisites

- You reviewed details about the [OpenShift Container Platform installation and update](#) processes.
- You read the documentation on [selecting a cluster installation method and preparing it for users](#).
- You [configured a GCP project](#) to host the cluster.
- If you use a firewall, you [configured it to allow the sites](#) that your cluster requires access to.
- If the cloud identity and access management (IAM) APIs are not accessible in your environment, or if you do not want to store an administrator-level credential secret in the **kube-system** namespace, you can [manually create and maintain IAM credentials](#).

### 8.8.2. About using a custom VPC

In OpenShift Container Platform 4.10, you can deploy a cluster into existing subnets in an existing Virtual Private Cloud (VPC) in Google Cloud Platform (GCP). By deploying OpenShift Container Platform into an existing GCP VPC, you might be able to avoid limit constraints in new accounts or more easily abide by the operational constraints that your company's guidelines set. If you cannot obtain the infrastructure creation permissions that are required to create the VPC yourself, use this installation option. You must configure networking for the subnets.

### 8.8.2.1. Requirements for using your VPC

The union of the VPC CIDR block and the machine network CIDR must be non-empty. The subnets must be within the machine network.

The installation program does not create the following components:

- NAT gateways
- Subnets
- Route tables
- VPC network



#### NOTE

The installation program requires that you use the cloud-provided DNS server. Using a custom DNS server is not supported and causes the installation to fail.

### 8.8.2.2. VPC validation

To ensure that the subnets that you provide are suitable, the installation program confirms the following data:

- All the subnets that you specify exist.
- You provide one subnet for control-plane machines and one subnet for compute machines.
- The subnet's CIDRs belong to the machine CIDR that you specified.

### 8.8.2.3. Division of permissions

Some individuals can create different resource in your clouds than others. For example, you might be able to create application-specific items, like instances, buckets, and load balancers, but not networking-related components such as VPCs, subnets, or ingress rules.

### 8.8.2.4. Isolation between clusters

If you deploy OpenShift Container Platform to an existing network, the isolation of cluster services is reduced in the following ways:

- You can install multiple OpenShift Container Platform clusters in the same VPC.
- ICMP ingress is allowed to the entire network.
- TCP 22 ingress (SSH) is allowed to the entire network.

- Control plane TCP 6443 ingress (Kubernetes API) is allowed to the entire network.
- Control plane TCP 22623 ingress (MCS) is allowed to the entire network.

### 8.8.3. Internet access for OpenShift Container Platform

In OpenShift Container Platform 4.10, you require access to the internet to install your cluster.

You must have internet access to:

- Access [OpenShift Cluster Manager](#) to download the installation program and perform subscription management. If the cluster has internet access and you do not disable Telemetry, that service automatically entitles your cluster.
- Access [Quay.io](#) to obtain the packages that are required to install your cluster.
- Obtain the packages that are required to perform cluster updates.

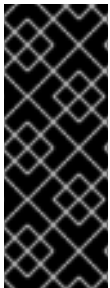

#### IMPORTANT

If your cluster cannot have direct internet access, you can perform a restricted network installation on some types of infrastructure that you provision. During that process, you download the required content and use it to populate a mirror registry with the installation packages. With some installation types, the environment that you install your cluster in will not require internet access. Before you update the cluster, you update the content of the mirror registry.

### 8.8.4. Generating a key pair for cluster node SSH access

During an OpenShift Container Platform installation, you can provide an SSH public key to the installation program. The key is passed to the Red Hat Enterprise Linux CoreOS (RHCOS) nodes through their Ignition config files and is used to authenticate SSH access to the nodes. The key is added to the `~/.ssh/authorized_keys` list for the **core** user on each node, which enables password-less authentication.

After the key is passed to the nodes, you can use the key pair to SSH in to the RHCOS nodes as the user **core**. To access the nodes through SSH, the private key identity must be managed by SSH for your local user.

If you want to SSH in to your cluster nodes to perform installation debugging or disaster recovery, you must provide the SSH public key during the installation process. The `./openshift-install gather` command also requires the SSH public key to be in place on the cluster nodes.

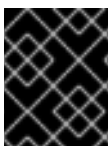

#### IMPORTANT

Do not skip this procedure in production environments, where disaster recovery and debugging is required.



#### NOTE

You must use a local key, not one that you configured with platform-specific approaches such as [AWS key pairs](#).

#### Procedure

1. If you do not have an existing SSH key pair on your local machine to use for authentication onto your cluster nodes, create one. For example, on a computer that uses a Linux operating system, run the following command:

```
$ ssh-keygen -t ed25519 -N "" -f <path>/<file_name> 1
```

- 1 Specify the path and file name, such as `~/.ssh/id_ed25519`, of the new SSH key. If you have an existing key pair, ensure your public key is in the your `~/.ssh` directory.



#### NOTE

If you plan to install an OpenShift Container Platform cluster that uses FIPS validated or Modules In Process cryptographic libraries on the **x86\_64** architecture, do not create a key that uses the **ed25519** algorithm. Instead, create a key that uses the **rsa** or **ecdsa** algorithm.

2. View the public SSH key:

```
$ cat <path>/<file_name>.pub
```

For example, run the following to view the `~/.ssh/id_ed25519.pub` public key:

```
$ cat ~/.ssh/id_ed25519.pub
```

3. Add the SSH private key identity to the SSH agent for your local user, if it has not already been added. SSH agent management of the key is required for password-less SSH authentication onto your cluster nodes, or if you want to use the `./openshift-install gather` command.



#### NOTE

On some distributions, default SSH private key identities such as `~/.ssh/id_rsa` and `~/.ssh/id_dsa` are managed automatically.

- a. If the **ssh-agent** process is not already running for your local user, start it as a background task:

```
$ eval "$(ssh-agent -s)"
```

#### Example output

```
Agent pid 31874
```



#### NOTE

If your cluster is in FIPS mode, only use FIPS-compliant algorithms to generate the SSH key. The key must be either RSA or ECDSA.

4. Add your SSH private key to the **ssh-agent**:

```
$ ssh-add <path>/<file_name> 1
```



- 1 Specify the path and file name for your SSH private key, such as `~/.ssh/id_ed25519`

### Example output

```
Identity added: /home/<you>/<path>/<file_name> (<computer_name>)
```

5. Set the **GOOGLE\_APPLICATION\_CREDENTIALS** environment variable to the full path to your service account private key file.

```
$ export GOOGLE_APPLICATION_CREDENTIALS="<your_service_account_file>"
```

6. Verify that the credentials were applied.

```
$ gcloud auth list
```

### Next steps

- When you install OpenShift Container Platform, provide the SSH public key to the installation program.

## 8.8.5. Obtaining the installation program

Before you install OpenShift Container Platform, download the installation file on a local computer.

### Prerequisites

- You have a computer that runs Linux or macOS, with 500 MB of local disk space

### Procedure

1. Access the [Infrastructure Provider](#) page on the OpenShift Cluster Manager site. If you have a Red Hat account, log in with your credentials. If you do not, create an account.
2. Select your infrastructure provider.
3. Navigate to the page for your installation type, download the installation program that corresponds with your host operating system and architecture, and place the file in the directory where you will store the installation configuration files.

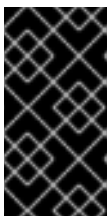

#### IMPORTANT

The installation program creates several files on the computer that you use to install your cluster. You must keep the installation program and the files that the installation program creates after you finish installing the cluster. Both files are required to delete the cluster.

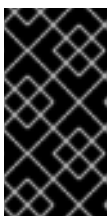

#### IMPORTANT

Deleting the files created by the installation program does not remove your cluster, even if the cluster failed during installation. To remove your cluster, complete the OpenShift Container Platform uninstallation procedures for your specific cloud provider.

4. Extract the installation program. For example, on a computer that uses a Linux operating system, run the following command:

```
$ tar -xvf openshift-install-linux.tar.gz
```

5. Download your installation [pull secret from the Red Hat OpenShift Cluster Manager](#) . This pull secret allows you to authenticate with the services that are provided by the included authorities, including Quay.io, which serves the container images for OpenShift Container Platform components.

### 8.8.6. Creating the installation configuration file

You can customize the OpenShift Container Platform cluster you install on Google Cloud Platform (GCP).

#### Prerequisites

- Obtain the OpenShift Container Platform installation program and the pull secret for your cluster.
- Obtain service principal permissions at the subscription level.

#### Procedure

1. Create the **install-config.yaml** file.
  - a. Change to the directory that contains the installation program and run the following command:

```
$ ./openshift-install create install-config --dir <installation_directory> 1
```

- 1** For **<installation\_directory>**, specify the directory name to store the files that the installation program creates.



#### IMPORTANT

Specify an empty directory. Some installation assets, like bootstrap X.509 certificates have short expiration intervals, so you must not reuse an installation directory. If you want to reuse individual files from another cluster installation, you can copy them into your directory. However, the file names for the installation assets might change between releases. Use caution when copying installation files from an earlier OpenShift Container Platform version.

- b. At the prompts, provide the configuration details for your cloud:
  - i. Optional: Select an SSH key to use to access your cluster machines.



#### NOTE

For production OpenShift Container Platform clusters on which you want to perform installation debugging or disaster recovery, specify an SSH key that your **ssh-agent** process uses.

- ii. Select **gcp** as the platform to target.
  - iii. If you have not configured the service account key for your GCP account on your computer, you must obtain it from GCP and paste the contents of the file or enter the absolute path to the file.
  - iv. Select the project ID to provision the cluster in. The default value is specified by the service account that you configured.
  - v. Select the region to deploy the cluster to.
  - vi. Select the base domain to deploy the cluster to. The base domain corresponds to the public DNS zone that you created for your cluster.
  - vii. Enter a descriptive name for your cluster.
  - viii. Paste the [pull secret from the Red Hat OpenShift Cluster Manager](#) .
2. Modify the **install-config.yaml** file. You can find more information about the available parameters in the "Installation configuration parameters" section.
  3. Back up the **install-config.yaml** file so that you can use it to install multiple clusters.

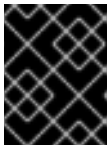

### IMPORTANT

The **install-config.yaml** file is consumed during the installation process. If you want to reuse the file, you must back it up now.

#### 8.8.6.1. Installation configuration parameters

Before you deploy an OpenShift Container Platform cluster, you provide parameter values to describe your account on the cloud platform that hosts your cluster and optionally customize your cluster's platform. When you create the **install-config.yaml** installation configuration file, you provide values for the required parameters through the command line. If you customize your cluster, you can modify the **install-config.yaml** file to provide more details about the platform.



### NOTE

After installation, you cannot modify these parameters in the **install-config.yaml** file.

##### 8.8.6.1.1. Required configuration parameters

Required installation configuration parameters are described in the following table:

**Table 8.27. Required parameters**

Parameter	Description	Values
<b>apiVersion</b>	The API version for the <b>install-config.yaml</b> content. The current version is <b>v1</b> . The installer may also support older API versions.	String

Parameter	Description	Values
<b>baseDomain</b>	The base domain of your cloud provider. The base domain is used to create routes to your OpenShift Container Platform cluster components. The full DNS name for your cluster is a combination of the <b>baseDomain</b> and <b>metadata.name</b> parameter values that uses the <b>&lt;metadata.name&gt;.&lt;baseDomain&gt;</b> format.	A fully-qualified domain or subdomain name, such as <b>example.com</b> .
<b>metadata</b>	Kubernetes resource <b>ObjectMeta</b> , from which only the <b>name</b> parameter is consumed.	Object
<b>metadata.name</b>	The name of the cluster. DNS records for the cluster are all subdomains of <b>{{.metadata.name}}</b> . <b>{{.baseDomain}}</b> .	String of lowercase letters, hyphens (-), and periods (.), such as <b>dev</b> .
<b>platform</b>	The configuration for the specific platform upon which to perform the installation: <b>alibabacloud, aws, baremetal, azure, gcp, ibmcloud, openstack, ovirt, vsphere</b> , or <b>{}</b> . For additional information about <b>platform.&lt;platform&gt;</b> parameters, consult the table for your specific platform that follows.	Object

Parameter	Description	Values
<b>pullSecret</b>	Get a <a href="#">pull secret from the Red Hat OpenShift Cluster Manager</a> to authenticate downloading container images for OpenShift Container Platform components from services such as Quay.io.	<pre>{   "auths":{     "cloud.openshift.com":{       "auth":"b3Blb=",       "email":"you@example.com"     },     "quay.io":{       "auth":"b3Blb=",       "email":"you@example.com"     }   } }</pre>

### 8.8.6.1.2. Network configuration parameters

You can customize your installation configuration based on the requirements of your existing network infrastructure. For example, you can expand the IP address block for the cluster network or provide different IP address blocks than the defaults.

Only IPv4 addresses are supported.

Table 8.28. Network parameters

Parameter	Description	Values
<b>networking</b>	The configuration for the cluster network.	Object <div style="display: flex; align-items: center; margin-top: 10px;">  <div> <p><b>NOTE</b></p> <p>You cannot modify parameters specified by the <b>networking</b> object after installation.</p> </div> </div>
<b>networking.networkType</b>	The cluster network provider Container Network Interface (CNI) plugin to install.	Either <b>OpenShiftSDN</b> or <b>OVNKubernetes</b> . <b>OpenShiftSDN</b> is a CNI provider for all-Linux networks. <b>OVNKubernetes</b> is a CNI provider for Linux networks and hybrid networks that contain both Linux and Windows servers. The default value is <b>OpenShiftSDN</b> .

Parameter	Description	Values
<b>networking.clusterNetwork</b>	<p>The IP address blocks for pods.</p> <p>The default value is <b>10.128.0.0/14</b> with a host prefix of <b>/23</b>.</p> <p>If you specify multiple IP address blocks, the blocks must not overlap.</p>	<p>An array of objects. For example:</p> <pre>networking:   clusterNetwork:     - cidr: 10.128.0.0/14       hostPrefix: 23</pre>
<b>networking.clusterNetwork.cidr</b>	<p>Required if you use <b>networking.clusterNetwork</b>. An IP address block.</p> <p>An IPv4 network.</p>	<p>An IP address block in Classless Inter-Domain Routing (CIDR) notation. The prefix length for an IPv4 block is between <b>0</b> and <b>32</b>.</p>
<b>networking.clusterNetwork.hostPrefix</b>	<p>The subnet prefix length to assign to each individual node. For example, if <b>hostPrefix</b> is set to <b>23</b> then each node is assigned a <b>/23</b> subnet out of the given <b>cidr</b>. A <b>hostPrefix</b> value of <b>23</b> provides 510 (<math>2^{(32 - 23)} - 2</math>) pod IP addresses.</p>	<p>A subnet prefix.</p> <p>The default value is <b>23</b>.</p>
<b>networking.serviceNetwork</b>	<p>The IP address block for services. The default value is <b>172.30.0.0/16</b>.</p> <p>The OpenShift SDN and OVN-Kubernetes network providers support only a single IP address block for the service network.</p>	<p>An array with an IP address block in CIDR format. For example:</p> <pre>networking:   serviceNetwork:     - 172.30.0.0/16</pre>
<b>networking.machineNetwork</b>	<p>The IP address blocks for machines.</p> <p>If you specify multiple IP address blocks, the blocks must not overlap.</p>	<p>An array of objects. For example:</p> <pre>networking:   machineNetwork:     - cidr: 10.0.0.0/16</pre>
<b>networking.machineNetwork.cidr</b>	<p>Required if you use <b>networking.machineNetwork</b>. An IP address block. The default value is <b>10.0.0.0/16</b> for all platforms other than libvirt. For libvirt, the default value is <b>192.168.126.0/24</b>.</p>	<p>An IP network block in CIDR notation.</p> <p>For example, <b>10.0.0.0/16</b>.</p> <div style="display: flex; align-items: flex-start;">  <div> <p><b>NOTE</b></p> <p>Set the <b>networking.machineNetwork</b> to match the CIDR that the preferred NIC resides in.</p> </div> </div>

### 8.8.6.1.3. Optional configuration parameters



Optional installation configuration parameters are described in the following table:

**Table 8.29. Optional parameters**

Parameter	Description	Values
<b>additionalTrustBundle</b>	A PEM-encoded X.509 certificate bundle that is added to the nodes' trusted certificate store. This trust bundle may also be used when a proxy has been configured.	String
<b>cgroupsV2</b>	Enables <a href="#">Linux control groups version 2</a> (cgroups v2) on specific nodes in your cluster. The OpenShift Container Platform process for enabling cgroups v2 disables all cgroup version 1 controllers and hierarchies. The OpenShift Container Platform cgroups version 2 feature is in Developer Preview and is not supported by Red Hat at this time.	<b>true</b>
<b>compute</b>	The configuration for the machines that comprise the compute nodes.	Array of <b>MachinePool</b> objects.
<b>compute.architecture</b>	Determines the instruction set architecture of the machines in the pool. Currently, clusters with varied architectures are not supported. All pools must specify the same architecture. Valid values are <b>amd64</b> (the default).	String
<b>compute.hyperthreading</b>	Whether to enable or disable simultaneous multithreading, or <b>hyperthreading</b> , on compute machines. By default, simultaneous multithreading is enabled to increase the performance of your machines' cores.	<b>Enabled</b> or <b>Disabled</b>
	 <p><b>IMPORTANT</b></p> <p>If you disable simultaneous multithreading, ensure that your capacity planning accounts for the dramatically decreased machine performance.</p>	

Parameter	Description	Values
<b>compute.name</b>	Required if you use <b>compute</b> . The name of the machine pool.	<b>worker</b>
<b>compute.platform</b>	Required if you use <b>compute</b> . Use this parameter to specify the cloud provider to host the worker machines. This parameter value must match the <b>controlPlane.platform</b> parameter value.	<b>alibabacloud, aws, azure, gcp, ibmcloud, openstack, ovirt, vsphere, or {}</b>
<b>compute.replicas</b>	The number of compute machines, which are also known as worker machines, to provision.	A positive integer greater than or equal to <b>2</b> . The default value is <b>3</b> .
<b>controlPlane</b>	The configuration for the machines that comprise the control plane.	Array of <b>MachinePool</b> objects.
<b>controlPlane.architecture</b>	Determines the instruction set architecture of the machines in the pool. Currently, clusters with varied architectures are not supported. All pools must specify the same architecture. Valid values are <b>amd64</b> (the default).	String
<b>controlPlane.hyperthreading</b>	<p>Whether to enable or disable simultaneous multithreading, or <b>hyperthreading</b>, on control plane machines. By default, simultaneous multithreading is enabled to increase the performance of your machines' cores.</p> <div style="display: flex; align-items: center;">  <div> <p><b>IMPORTANT</b></p> <p>If you disable simultaneous multithreading, ensure that your capacity planning accounts for the dramatically decreased machine performance.</p> </div> </div>	<b>Enabled</b> or <b>Disabled</b>
<b>controlPlane.name</b>	Required if you use <b>controlPlane</b> . The name of the machine pool.	<b>master</b>



Parameter	Description	Values
<b>controlPlane.platform</b>	Required if you use <b>controlPlane</b> . Use this parameter to specify the cloud provider that hosts the control plane machines. This parameter value must match the <b>compute.platform</b> parameter value.	<b>alibabacloud, aws, azure, gcp, ibmcloud, openstack, ovirt, vsphere</b> , or {}
<b>controlPlane.replicas</b>	The number of control plane machines to provision.	The only supported value is <b>3</b> , which is the default value.
<b>credentialsMode</b>	<p>The Cloud Credential Operator (CCO) mode. If no mode is specified, the CCO dynamically tries to determine the capabilities of the provided credentials, with a preference for mint mode on the platforms where multiple modes are supported. If you are installing on GCP into a shared virtual private cloud (VPC), <b>credentialsMode</b> must be set to <b>Passthrough</b>.</p> <div style="display: flex; align-items: flex-start;"> <div style="width: 2em; height: 2em; border: 1px solid black; margin-right: 1em;">  </div> <div> <p><b>NOTE</b></p> <p>Not all CCO modes are supported for all cloud providers. For more information on CCO modes, see the <i>Cloud Credential Operator</i> entry in the <i>Cluster Operators reference</i> content.</p> </div> </div> <div style="display: flex; align-items: flex-start; margin-top: 1em;"> <div style="width: 2em; height: 2em; border: 1px solid black; margin-right: 1em;">  </div> <div> <p><b>NOTE</b></p> <p>If your AWS account has service control policies (SCP) enabled, you must configure the <b>credentialsMode</b> parameter to <b>Mint</b>, <b>Passthrough</b> or <b>Manual</b>.</p> </div> </div>	<b>Mint, Passthrough, Manual</b> or an empty string ("").

Parameter	Description	Values
<b>fips</b>	<p>Enable or disable FIPS mode. The default is <b>false</b> (disabled). If FIPS mode is enabled, the Red Hat Enterprise Linux CoreOS (RHCOS) machines that OpenShift Container Platform runs on bypass the default Kubernetes cryptography suite and use the cryptography modules that are provided with RHCOS instead.</p> <div data-bbox="486 584 592 1361" style="background-color: black; color: white; padding: 5px; margin-bottom: 10px;"> <p><b>IMPORTANT</b></p> <p>To enable FIPS mode for your cluster, you must run the installation program from a Red Hat Enterprise Linux (RHEL) computer configured to operate in FIPS mode. For more information about configuring FIPS mode on RHEL, see <a href="#">Installing the system in FIPS mode</a>. The use of FIPS validated or Modules In Process cryptographic libraries is only supported on OpenShift Container Platform deployments on the <b>x86_64</b> architecture.</p> </div> <div data-bbox="486 1408 592 1603" style="background-color: #f0f0f0; padding: 5px;"> <p><b>NOTE</b></p> <p>If you are using Azure File storage, you cannot enable FIPS mode.</p> </div>	<b>false</b> or <b>true</b>
<b>imageContentSources</b>	Sources and repositories for the release-image content.	Array of objects. Includes a <b>source</b> and, optionally, <b>mirrors</b> , as described in the following rows of this table.

Parameter	Description	Values
<b>imageContentSources.source</b>	Required if you use <b>imageContentSources</b> . Specify the repository that users refer to, for example, in image pull specifications.	String
<b>imageContentSources.mirrors</b>	Specify one or more repositories that may also contain the same images.	Array of strings
<b>publish</b>	How to publish or expose the user-facing endpoints of your cluster, such as the Kubernetes API, OpenShift routes.	<b>Internal</b> or <b>External</b> . To deploy a private cluster, which cannot be accessed from the internet, set <b>publish</b> to <b>Internal</b> . The default value is <b>External</b> .
<b>sshKey</b>	<p>The SSH key or keys to authenticate access your cluster machines.</p>  <p><b>NOTE</b></p> <p>For production OpenShift Container Platform clusters on which you want to perform installation debugging or disaster recovery, specify an SSH key that your <b>ssh-agent</b> process uses.</p>	<p>One or more keys. For example:</p> <pre>sshKey:   &lt;key1&gt;   &lt;key2&gt;   &lt;key3&gt;</pre>

#### 8.8.6.1.4. Additional Google Cloud Platform (GCP) configuration parameters

Additional GCP configuration parameters are described in the following table:

**Table 8.30. Additional GCP parameters**

Parameter	Description	Values
<code>platform.gcp.network</code>	The name of the existing VPC that you want to deploy your cluster to.	String.
<code>platform.gcp.region</code>	The name of the GCP region that hosts your cluster.	Any valid region name, such as <b>us-central1</b> .
<code>platform.gcp.type</code>	The <a href="#">GCP machine type</a> .	The GCP machine type.
<code>platform.gcp.zones</code>	The availability zones where the installation program creates machines for the specified MachinePool.	A list of valid <a href="#">GCP availability zones</a> , such as <b>us-central1-a</b> , in a <a href="#">YAML sequence</a> .
<code>platform.gcp.controlPlaneSubnet</code>	The name of the existing subnet in your VPC that you want to deploy your control plane machines to.	The subnet name.
<code>platform.gcp.computeSubnet</code>	The name of the existing subnet in your VPC that you want to deploy your compute machines to.	The subnet name.
<code>platform.gcp.licenses</code>	<p>A list of license URLs that must be applied to the compute images.</p> <div style="display: flex; align-items: flex-start;">  <div> <p><b>IMPORTANT</b></p> <p>The <b>licenses</b> parameter is a deprecated field and nested virtualization is enabled by default. It is not recommended to use this field.</p> </div> </div>	Any license available with the <a href="#">license API</a> , such as the license to enable <a href="#">nested virtualization</a> . You cannot use this parameter with a mechanism that generates pre-built images. Using a license URL forces the installer to copy the source image before use.

Parameter	Description	Values
<b>platform.gcp.osDiskSizeGB</b>	The size of the disk in gigabytes (GB).	Any size between 16 GB and 65536 GB.
<b>platform.gcp.osDiskType</b>	The type of disk.	Either the default <b>pd-ssd</b> or the <b>pd-standard</b> disk type. The control plane nodes must be the <b>pd-ssd</b> disk type. The worker nodes can be either type.
<b>controlplane.platform.gcp.osDiskEncryptionKey.kmsKeyName</b>	The name of the customer managed encryption key to be used for control plane machine disk encryption.	The encryption key name.
<b>controlplane.platform.gcp.osDiskEncryptionKey.kmsKeyRing</b>	For control plane machines, the name of the KMS key ring to which the KMS key belongs.	The KMS key ring name.
<b>controlplane.platform.gcp.osDiskEncryptionKey.kmsLocation</b>	For control plane machines, the GCP location in which the key ring exists. For more information on KMS locations, see Google's documentation on <a href="#">Cloud KMS locations</a> .	The GCP location for the key ring.

Parameter	Description	Values
<b>controlPlane.platform.gcp.osDisk.encryptedKey.kmsKey.projectID</b>	For control plane machines, the ID of the project in which the KMS key ring exists. This value defaults to the VM project ID if not set.	The GCP project ID.
<b>compute.platform.gcp.osDisk.encryptedKey.kmsKeyName</b>	The name of the customer managed encryption key to be used for compute machine disk encryption.	The encryption key name.
<b>compute.platform.gcp.osDisk.encryptedKey.kmsKey.keyRing</b>	For compute machines, the name of the KMS key ring to which the KMS key belongs.	The KMS key ring name.
<b>compute.platform.gcp.osDisk.encryptedKey.kmsKey.location</b>	For compute machines, the GCP location in which the key ring exists. For more information on KMS locations, see Google's documentation on <a href="#">Cloud KMS locations</a> .	The GCP location for the key ring.

Parameter	Description	Values
<code>compute.platform.gcp.ossDisk.encryptionKey.kmsKey.projectID</code>	For compute machines, the ID of the project in which the KMS key ring exists. This value defaults to the VM project ID if not set.	The GCP project ID.

### 8.8.6.2. Minimum resource requirements for cluster installation

Each cluster machine must meet the following minimum requirements:

Table 8.31. Minimum resource requirements

Machine	Operating System	vCPU [1]	Virtual RAM	Storage	IOPS [2]
Bootstrap	RHCOS	4	16 GB	100 GB	300
Control plane	RHCOS	4	16 GB	100 GB	300
Compute	RHCOS, RHEL 8.4, or RHEL 8.5 [3]	2	8 GB	100 GB	300

1. One vCPU is equivalent to one physical core when simultaneous multithreading (SMT), or hyperthreading, is not enabled. When enabled, use the following formula to calculate the corresponding ratio:  $(\text{threads per core} \times \text{cores}) \times \text{sockets} = \text{vCPUs}$ .
2. OpenShift Container Platform and Kubernetes are sensitive to disk performance, and faster storage is recommended, particularly for etcd on the control plane nodes which require a 10 ms p99 fsync duration. Note that on many cloud platforms, storage size and IOPS scale together, so you might need to over-allocate storage volume to obtain sufficient performance.
3. As with all user-provisioned installations, if you choose to use RHEL compute machines in your cluster, you take responsibility for all operating system life cycle management and maintenance, including performing system updates, applying patches, and completing all other required tasks. Use of RHEL 7 compute machines is deprecated and has been removed in OpenShift Container Platform 4.10 and later.

If an instance type for your platform meets the minimum requirements for cluster machines, it is supported to use in OpenShift Container Platform.

### 8.8.6.3. Tested instance types for GCP

The following Google Cloud Platform instance types have been tested with OpenShift Container Platform.

#### Example 8.24. Machine series

- **C2**
- **C2D**
- **C3**
- **E2**
- **M1**
- **N1**
- **N2**
- **N2D**
- **Tau T2D**

#### 8.8.6.4. Using custom machine types

Using a custom machine type to install a OpenShift Container Platform cluster is supported.

Consider the following when using a custom machine type:

- Similar to predefined instance types, custom machine types must meet the minimum resource requirements for control plane and compute machines. For more information, see "Minimum resource requirements for cluster installation".
- The name of the custom machine type must adhere to the following syntax:  
**custom-<number\_of\_cpus>-<amount\_of\_memory\_in\_mb>**

For example, **custom-6-20480**.

As part of the installation process, you specify the custom machine type in the **install-config.yaml** file.

#### Sample install-config.yaml file with a custom machine type

```
compute:
- architecture: amd64
  hyperthreading: Enabled
  name: worker
  platform:
    gcp:
      type: custom-6-20480
  replicas: 2
controlPlane:
  architecture: amd64
  hyperthreading: Enabled
  name: master
  platform:
```



```
gcp:
  type: custom-6-20480
  replicas: 3
```

### 8.8.6.5. Sample customized install-config.yaml file for GCP

You can customize the **install-config.yaml** file to specify more details about your OpenShift Container Platform cluster's platform or modify the values of the required parameters.



#### IMPORTANT

This sample YAML file is provided for reference only. You must obtain your **install-config.yaml** file by using the installation program and modify it.

```
apiVersion: v1
baseDomain: example.com 1
controlPlane: 2 3
  hyperthreading: Enabled 4
  name: master
  platform:
    gcp:
      type: n2-standard-4
      zones:
      - us-central1-a
      - us-central1-c
    osDisk:
      diskType: pd-ssd
      diskSizeGB: 1024
      encryptionKey: 5
      kmsKey:
        name: worker-key
        keyRing: test-machine-keys
        location: global
        projectID: project-id
  replicas: 3
compute: 6 7
  - hyperthreading: Enabled 8
  name: worker
  platform:
    gcp:
      type: n2-standard-4
      zones:
      - us-central1-a
      - us-central1-c
    osDisk:
      diskType: pd-standard
      diskSizeGB: 128
      encryptionKey: 9
      kmsKey:
        name: worker-key
        keyRing: test-machine-keys
        location: global
        projectID: project-id
```

```

replicas: 3
metadata:
  name: test-cluster 10
networking:
  clusterNetwork:
  - cidr: 10.128.0.0/14
    hostPrefix: 23
  machineNetwork:
  - cidr: 10.0.0.0/16
  networkType: OpenShiftSDN
  serviceNetwork:
  - 172.30.0.0/16
platform:
  gcp:
  projectID: openshift-production 11
  region: us-central1 12
  network: existing_vpc 13
  controlPlaneSubnet: control_plane_subnet 14
  computeSubnet: compute_subnet 15
pullSecret: '{"auths": ...}' 16
fips: false 17
sshKey: ssh-ed25519 AAAA... 18

```

**1 10 11 12 16** Required. The installation program prompts you for this value.

**2 6** If you do not provide these parameters and values, the installation program provides the default value.

**3 7** The **controlPlane** section is a single mapping, but the **compute** section is a sequence of mappings. To meet the requirements of the different data structures, the first line of the **compute** section must begin with a hyphen, -, and the first line of the **controlPlane** section must not. Only one control plane pool is used.

**4 8** Whether to enable or disable simultaneous multithreading, or **hyperthreading**. By default, simultaneous multithreading is enabled to increase the performance of your machines' cores. You can disable it by setting the parameter value to **Disabled**. If you disable simultaneous multithreading in some cluster machines, you must disable it in all cluster machines.

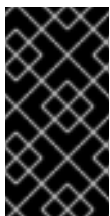

### IMPORTANT

If you disable simultaneous multithreading, ensure that your capacity planning accounts for the dramatically decreased machine performance. Use larger machine types, such as **n1-standard-8**, for your machines if you disable simultaneous multithreading.

**5 9** Optional: The custom encryption key section to encrypt both virtual machines and persistent volumes. Your default compute service account must have the permissions granted to use your KMS key and have the correct IAM role assigned. The default service account name follows the **service-<project\_number>@compute-system.iam.gserviceaccount.com** pattern. For more information on granting the correct permissions for your service account, see "Machine management" → "Creating machine sets" → "Creating a machine set on GCP".

**13** Specify the name of an existing VPC.

- 14 Specify the name of the existing subnet to deploy the control plane machines to. The subnet must belong to the VPC that you specified.
- 15 Specify the name of the existing subnet to deploy the compute machines to. The subnet must belong to the VPC that you specified.
- 17 Whether to enable or disable FIPS mode. By default, FIPS mode is not enabled. If FIPS mode is enabled, the Red Hat Enterprise Linux CoreOS (RHCOS) machines that OpenShift Container Platform runs on bypass the default Kubernetes cryptography suite and use the cryptography modules that are provided with RHCOS instead.



### IMPORTANT

To enable FIPS mode for your cluster, you must run the installation program from a Red Hat Enterprise Linux (RHEL) computer configured to operate in FIPS mode. For more information about configuring FIPS mode on RHEL, see [Installing the system in FIPS mode](#). The use of FIPS validated or Modules In Process cryptographic libraries is only supported on OpenShift Container Platform deployments on the **x86\_64** architecture.

- 18 You can optionally provide the **sshKey** value that you use to access the machines in your cluster.

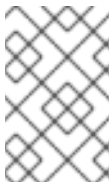

### NOTE

For production OpenShift Container Platform clusters on which you want to perform installation debugging or disaster recovery, specify an SSH key that your **ssh-agent** process uses.

#### 8.8.6.6. Create an Ingress Controller with global access on GCP

You can create an Ingress Controller that has global access to a Google Cloud Platform (GCP) cluster. Global access is only available to Ingress Controllers using internal load balancers.

#### Prerequisites

- You created the **install-config.yaml** and complete any modifications to it.

#### Procedure

Create an Ingress Controller with global access on a new GCP cluster.

1. Change to the directory that contains the installation program and create a manifest file:

```
$ ./openshift-install create manifests --dir <installation_directory> 1
```

- 1 For **<installation\_directory>**, specify the name of the directory that contains the **install-config.yaml** file for your cluster.

2. Create a file that is named **cluster-ingress-default-ingresscontroller.yaml** in the **<installation\_directory>/manifests/** directory:

```
$ touch <installation_directory>/manifests/cluster-ingress-default-ingresscontroller.yaml 1
```

- 1 For **<installation\_directory>**, specify the directory name that contains the **manifests/** directory for your cluster.

After creating the file, several network configuration files are in the **manifests/** directory, as shown:

```
$ ls <installation_directory>/manifests/cluster-ingress-default-ingresscontroller.yaml
```

### Example output

```
cluster-ingress-default-ingresscontroller.yaml
```

3. Open the **cluster-ingress-default-ingresscontroller.yaml** file in an editor and enter a custom resource (CR) that describes the Operator configuration you want:

### Sample `clientAccess` configuration to Global

```
apiVersion: operator.openshift.io/v1
kind: IngressController
metadata:
  name: default
  namespace: openshift-ingress-operator
spec:
  endpointPublishingStrategy:
    loadBalancer:
      providerParameters:
        gcp:
          clientAccess: Global 1
          type: GCP
          scope: Internal 2
          type: LoadBalancerService
```

- 1 Set **`gcp.clientAccess`** to **Global**.
- 2 Global access is only available to Ingress Controllers using internal load balancers.

## 8.8.7. Additional resources

- [Enabling customer-managed encryption keys for a machine set](#)

### 8.8.7.1. Configuring the cluster-wide proxy during installation

Production environments can deny direct access to the internet and instead have an HTTP or HTTPS proxy available. You can configure a new OpenShift Container Platform cluster to use a proxy by configuring the proxy settings in the **install-config.yaml** file.

#### Prerequisites

- You have an existing **install-config.yaml** file.
- You reviewed the sites that your cluster requires access to and determined whether any of them need to bypass the proxy. By default, all cluster egress traffic is proxied, including calls to

hosting cloud provider APIs. You added sites to the **Proxy** object's **spec.noProxy** field to bypass the proxy if necessary.



## NOTE

The **Proxy** object **status.noProxy** field is populated with the values of the **networking.machineNetwork[].cidr**, **networking.clusterNetwork[].cidr**, and **networking.serviceNetwork[]** fields from your installation configuration.

For installations on Amazon Web Services (AWS), Google Cloud Platform (GCP), Microsoft Azure, and Red Hat OpenStack Platform (RHOSP), the **Proxy** object **status.noProxy** field is also populated with the instance metadata endpoint (**169.254.169.254**).

## Procedure

1. Edit your **install-config.yaml** file and add the proxy settings. For example:

```
apiVersion: v1
baseDomain: my.domain.com
proxy:
  httpProxy: http://<username>:<pswd>@<ip>:<port> 1
  httpsProxy: https://<username>:<pswd>@<ip>:<port> 2
  noProxy: example.com 3
  additionalTrustBundle: | 4
    -----BEGIN CERTIFICATE-----
    <MY_TRUSTED_CA_CERT>
    -----END CERTIFICATE-----
  ...
```

- 1 A proxy URL to use for creating HTTP connections outside the cluster. The URL scheme must be **http**.
- 2 A proxy URL to use for creating HTTPS connections outside the cluster.
- 3 A comma-separated list of destination domain names, IP addresses, or other network CIDRs to exclude from proxying. Preface a domain with **.** to match subdomains only. For example, **.y.com** matches **x.y.com**, but not **y.com**. Use **\*** to bypass the proxy for all destinations.
- 4 If provided, the installation program generates a config map that is named **user-ca-bundle** in the **openshift-config** namespace that contains one or more additional CA certificates that are required for proxying HTTPS connections. The Cluster Network Operator then creates a **trusted-ca-bundle** config map that merges these contents with the Red Hat Enterprise Linux CoreOS (RHCOS) trust bundle, and this config map is referenced in the **trustedCA** field of the **Proxy** object. The **additionalTrustBundle** field is required unless the proxy's identity certificate is signed by an authority from the RHCOS trust bundle.



## NOTE

The installation program does not support the proxy **readinessEndpoints** field.

**NOTE**

If the installer times out, restart and then complete the deployment by using the **wait-for** command of the installer. For example:

```
$ ./openshift-install wait-for install-complete --log-level debug
```

2. Save the file and reference it when installing OpenShift Container Platform.

The installation program creates a cluster-wide proxy that is named **cluster** that uses the proxy settings in the provided **install-config.yaml** file. If no proxy settings are provided, a **cluster Proxy** object is still created, but it will have a nil **spec**.

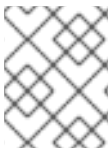
**NOTE**

Only the **Proxy** object named **cluster** is supported, and no additional proxies can be created.

### 8.8.8. Deploying the cluster

You can install OpenShift Container Platform on a compatible cloud platform.

**IMPORTANT**

You can run the **create cluster** command of the installation program only once, during initial installation.

#### Prerequisites

- Configure an account with the cloud platform that hosts your cluster.
- Obtain the OpenShift Container Platform installation program and the pull secret for your cluster.

#### Procedure

1. Remove any existing GCP credentials that do not use the service account key for the GCP account that you configured for your cluster and that are stored in the following locations:
  - The **GOOGLE\_CREDENTIALS**, **GOOGLE\_CLOUD\_KEYFILE\_JSON**, or **GKLOUD\_KEYFILE\_JSON** environment variables
  - The `~/gcp/osServiceAccount.json` file
  - The **gcloud cli** default credentials
2. Change to the directory that contains the installation program and initialize the cluster deployment:

```
$ ./openshift-install create cluster --dir <installation_directory> \ 1  
--log-level=info 2
```

- 1** For `<installation_directory>`, specify the location of your customized `./install-config.yaml` file.

- 2 To view different installation details, specify **warn**, **debug**, or **error** instead of **info**.

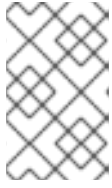

## NOTE

If the cloud provider account that you configured on your host does not have sufficient permissions to deploy the cluster, the installation process stops, and the missing permissions are displayed.

When the cluster deployment completes, directions for accessing your cluster, including a link to its web console and credentials for the **kubeadmin** user, display in your terminal.

## Example output

```
...
INFO Install complete!
INFO To access the cluster as the system:admin user when using 'oc', run 'export
KUBECONFIG=/home/myuser/install_dir/auth/kubeconfig'
INFO Access the OpenShift web-console here: https://console-openshift-
console.apps.mycluster.example.com
INFO Login to the console with user: "kubeadmin", and password: "4vYBz-Ee6gm-ymBZj-
Wt5AL"
INFO Time elapsed: 36m22s
```

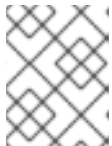

## NOTE

The cluster access and credential information also outputs to **<installation\_directory>/openshift\_install.log** when an installation succeeds.



## IMPORTANT

- The Ignition config files that the installation program generates contain certificates that expire after 24 hours, which are then renewed at that time. If the cluster is shut down before renewing the certificates and the cluster is later restarted after the 24 hours have elapsed, the cluster automatically recovers the expired certificates. The exception is that you must manually approve the pending **node-bootstrapper** certificate signing requests (CSRs) to recover kubelet certificates. See the documentation for *Recovering from expired control plane certificates* for more information.
- It is recommended that you use Ignition config files within 12 hours after they are generated because the 24-hour certificate rotates from 16 to 22 hours after the cluster is installed. By using the Ignition config files within 12 hours, you can avoid installation failure if the certificate update runs during installation.

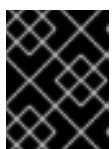

## IMPORTANT

You must not delete the installation program or the files that the installation program creates. Both are required to delete the cluster.

3. Optional: You can reduce the number of permissions for the service account that you used to install the cluster.

- If you assigned the **Owner** role to your service account, you can remove that role and replace it with the **Viewer** role.
- If you included the **Service Account Key Admin** role, you can remove it.

### 8.8.9. Installing the OpenShift CLI by downloading the binary

You can install the OpenShift CLI (**oc**) to interact with OpenShift Container Platform from a command-line interface. You can install **oc** on Linux, Windows, or macOS.

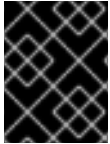

#### IMPORTANT

If you installed an earlier version of **oc**, you cannot use it to complete all of the commands in OpenShift Container Platform 4.10. Download and install the new version of **oc**.

#### Installing the OpenShift CLI on Linux

You can install the OpenShift CLI (**oc**) binary on Linux by using the following procedure.

##### Procedure

1. Navigate to the [OpenShift Container Platform downloads page](#) on the Red Hat Customer Portal.
2. Select the appropriate version in the **Version** drop-down menu.
3. Click **Download Now** next to the **OpenShift v4.10 Linux Client** entry and save the file.
4. Unpack the archive:

```
$ tar xvf <file>
```

5. Place the **oc** binary in a directory that is on your **PATH**.  
To check your **PATH**, execute the following command:

```
$ echo $PATH
```

After you install the OpenShift CLI, it is available using the **oc** command:

```
$ oc <command>
```

#### Installing the OpenShift CLI on Windows

You can install the OpenShift CLI (**oc**) binary on Windows by using the following procedure.

##### Procedure

1. Navigate to the [OpenShift Container Platform downloads page](#) on the Red Hat Customer Portal.
2. Select the appropriate version in the **Version** drop-down menu.
3. Click **Download Now** next to the **OpenShift v4.10 Windows Client** entry and save the file.
4. Unzip the archive with a ZIP program.



5. Move the **oc** binary to a directory that is on your **PATH**.  
To check your **PATH**, open the command prompt and execute the following command:

```
C:\> path
```

After you install the OpenShift CLI, it is available using the **oc** command:

```
C:\> oc <command>
```

### Installing the OpenShift CLI on macOS

You can install the OpenShift CLI (**oc**) binary on macOS by using the following procedure.

#### Procedure

1. Navigate to the [OpenShift Container Platform downloads page](#) on the Red Hat Customer Portal.
2. Select the appropriate version in the **Version** drop-down menu.
3. Click **Download Now** next to the **OpenShift v4.10 MacOSX Client** entry and save the file.
4. Unpack and unzip the archive.
5. Move the **oc** binary to a directory on your PATH.  
To check your **PATH**, open a terminal and execute the following command:

```
$ echo $PATH
```

After you install the OpenShift CLI, it is available using the **oc** command:

```
$ oc <command>
```

### 8.8.10. Logging in to the cluster by using the CLI

You can log in to your cluster as a default system user by exporting the cluster **kubeconfig** file. The **kubeconfig** file contains information about the cluster that is used by the CLI to connect a client to the correct cluster and API server. The file is specific to a cluster and is created during OpenShift Container Platform installation.

#### Prerequisites

- You deployed an OpenShift Container Platform cluster.
- You installed the **oc** CLI.

#### Procedure

1. Export the **kubeadmin** credentials:

```
$ export KUBECONFIG=<installation_directory>/auth/kubeconfig 1
```

- 1** For **<installation\_directory>**, specify the path to the directory that you stored the installation files in.

2. Verify you can run **oc** commands successfully using the exported configuration:

```
$ oc whoami
```

#### Example output

```
system:admin
```

#### Additional resources

- See [Accessing the web console](#) for more details about accessing and understanding the OpenShift Container Platform web console.

### 8.8.11. Telemetry access for OpenShift Container Platform

In OpenShift Container Platform 4.10, the Telemetry service, which runs by default to provide metrics about cluster health and the success of updates, requires internet access. If your cluster is connected to the internet, Telemetry runs automatically, and your cluster is registered to [OpenShift Cluster Manager](#).

After you confirm that your [OpenShift Cluster Manager](#) inventory is correct, either maintained automatically by Telemetry or manually by using OpenShift Cluster Manager, [use subscription watch](#) to track your OpenShift Container Platform subscriptions at the account or multi-cluster level.

#### Additional resources

- See [About remote health monitoring](#) for more information about the Telemetry service

### 8.8.12. Next steps

- [Customize your cluster](#).
- If necessary, you can [opt out of remote health reporting](#).

## 8.9. INSTALLING A PRIVATE CLUSTER ON GCP

In OpenShift Container Platform version 4.10, you can install a private cluster into an existing VPC on Google Cloud Platform (GCP). The installation program provisions the rest of the required infrastructure, which you can further customize. To customize the installation, you modify parameters in the **install-config.yaml** file before you install the cluster.

### 8.9.1. Prerequisites

- You reviewed details about the [OpenShift Container Platform installation and update](#) processes.
- You read the documentation on [selecting a cluster installation method and preparing it for users](#).
- You [configured a GCP project](#) to host the cluster.
- If you use a firewall, you [configured it to allow the sites](#) that your cluster requires access to.

- If the cloud identity and access management (IAM) APIs are not accessible in your environment, or if you do not want to store an administrator-level credential secret in the **kube-system** namespace, you can [manually create and maintain IAM credentials](#).

## 8.9.2. Private clusters

You can deploy a private OpenShift Container Platform cluster that does not expose external endpoints. Private clusters are accessible from only an internal network and are not visible to the internet.

By default, OpenShift Container Platform is provisioned to use publicly-accessible DNS and endpoints. A private cluster sets the DNS, Ingress Controller, and API server to private when you deploy your cluster. This means that the cluster resources are only accessible from your internal network and are not visible to the internet.

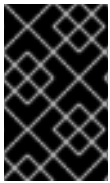

### IMPORTANT

If the cluster has any public subnets, load balancer services created by administrators might be publicly accessible. To ensure cluster security, verify that these services are explicitly annotated as private.

To deploy a private cluster, you must:

- Use existing networking that meets your requirements. Your cluster resources might be shared between other clusters on the network.
- Deploy from a machine that has access to:
  - The API services for the cloud to which you provision.
  - The hosts on the network that you provision.
  - The internet to obtain installation media.

You can use any machine that meets these access requirements and follows your company's guidelines. For example, this machine can be a bastion host on your cloud network or a machine that has access to the network through a VPN.

### 8.9.2.1. Private clusters in GCP

To create a private cluster on Google Cloud Platform (GCP), you must provide an existing private VPC and subnets to host the cluster. The installation program must also be able to resolve the DNS records that the cluster requires. The installation program configures the Ingress Operator and API server for only internal traffic.

The cluster still requires access to internet to access the GCP APIs.

The following items are not required or created when you install a private cluster:

- Public subnets
- Public network load balancers, which support public ingress
- A public DNS zone that matches the **baseDomain** for the cluster

The installation program does use the **baseDomain** that you specify to create a private DNS zone and the required records for the cluster. The cluster is configured so that the Operators do not create public records for the cluster and all cluster machines are placed in the private subnets that you specify.

Because it is not possible to limit access to external load balancers based on source tags, the private cluster uses only internal load balancers to allow access to internal instances.

The internal load balancer relies on instance groups rather than the target pools that the network load balancers use. The installation program creates instance groups for each zone, even if there is no instance in that group.

- The cluster IP address is internal only.
- One forwarding rule manages both the Kubernetes API and machine config server ports.
- The backend service is comprised of each zone's instance group and, while it exists, the bootstrap instance group.
- The firewall uses a single rule that is based on only internal source ranges.

#### 8.9.2.1.1. Limitations

No health check for the Machine config server, **/healthz**, runs because of a difference in load balancer functionality. Two internal load balancers cannot share a single IP address, but two network load balancers can share a single external IP address. Instead, the health of an instance is determined entirely by the **/readyz** check on port 6443.

### 8.9.3. About using a custom VPC

In OpenShift Container Platform 4.10, you can deploy a cluster into an existing VPC in Google Cloud Platform (GCP). If you do, you must also use existing subnets within the VPC and routing rules.

By deploying OpenShift Container Platform into an existing GCP VPC, you might be able to avoid limit constraints in new accounts or more easily abide by the operational constraints that your company's guidelines set. This is a good option to use if you cannot obtain the infrastructure creation permissions that are required to create the VPC yourself.

#### 8.9.3.1. Requirements for using your VPC

The installation program will no longer create the following components:

- VPC
- Subnets
- Cloud router
- Cloud NAT
- NAT IP addresses

If you use a custom VPC, you must correctly configure it and its subnets for the installation program and the cluster to use. The installation program cannot subdivide network ranges for the cluster to use, set route tables for the subnets, or set VPC options like DHCP, so you must do so before you install the cluster.

Your VPC and subnets must meet the following characteristics:

- The VPC must be in the same GCP project that you deploy the OpenShift Container Platform cluster to.
- To allow access to the internet from the control plane and compute machines, you must configure cloud NAT on the subnets to allow egress to it. These machines do not have a public address. Even if you do not require access to the internet, you must allow egress to the VPC network to obtain the installation program and images. Because multiple cloud NATs cannot be configured on the shared subnets, the installation program cannot configure it.

To ensure that the subnets that you provide are suitable, the installation program confirms the following data:

- All the subnets that you specify exist and belong to the VPC that you specified.
- The subnet CIDRs belong to the machine CIDR.
- You must provide a subnet to deploy the cluster control plane and compute machines to. You can use the same subnet for both machine types.

If you destroy a cluster that uses an existing VPC, the VPC is not deleted.

### 8.9.3.2. Division of permissions

Starting with OpenShift Container Platform 4.3, you do not need all of the permissions that are required for an installation program-provisioned infrastructure cluster to deploy a cluster. This change mimics the division of permissions that you might have at your company: some individuals can create different resources in your clouds than others. For example, you might be able to create application-specific items, like instances, buckets, and load balancers, but not networking-related components such as VPCs, subnets, or Ingress rules.

The GCP credentials that you use when you create your cluster do not need the networking permissions that are required to make VPCs and core networking components within the VPC, such as subnets, routing tables, internet gateways, NAT, and VPN. You still need permission to make the application resources that the machines within the cluster require, such as load balancers, security groups, storage, and nodes.

### 8.9.3.3. Isolation between clusters

If you deploy OpenShift Container Platform to an existing network, the isolation of cluster services is preserved by firewall rules that reference the machines in your cluster by the cluster's infrastructure ID. Only traffic within the cluster is allowed.

If you deploy multiple clusters to the same VPC, the following components might share access between clusters:

- The API, which is globally available with an external publishing strategy or available throughout the network in an internal publishing strategy
- Debugging tools, such as ports on VM instances that are open to the machine CIDR for SSH and ICMP access

### 8.9.4. Internet access for OpenShift Container Platform

In OpenShift Container Platform 4.10, you require access to the internet to install your cluster.

You must have internet access to:

- Access [OpenShift Cluster Manager](#) to download the installation program and perform subscription management. If the cluster has internet access and you do not disable Telemetry, that service automatically entitles your cluster.
- Access [Quay.io](#) to obtain the packages that are required to install your cluster.
- Obtain the packages that are required to perform cluster updates.



### IMPORTANT

If your cluster cannot have direct internet access, you can perform a restricted network installation on some types of infrastructure that you provision. During that process, you download the required content and use it to populate a mirror registry with the installation packages. With some installation types, the environment that you install your cluster in will not require internet access. Before you update the cluster, you update the content of the mirror registry.

## 8.9.5. Generating a key pair for cluster node SSH access

During an OpenShift Container Platform installation, you can provide an SSH public key to the installation program. The key is passed to the Red Hat Enterprise Linux CoreOS (RHCOS) nodes through their Ignition config files and is used to authenticate SSH access to the nodes. The key is added to the `~/.ssh/authorized_keys` list for the **core** user on each node, which enables password-less authentication.

After the key is passed to the nodes, you can use the key pair to SSH in to the RHCOS nodes as the user **core**. To access the nodes through SSH, the private key identity must be managed by SSH for your local user.

If you want to SSH in to your cluster nodes to perform installation debugging or disaster recovery, you must provide the SSH public key during the installation process. The `./openshift-install gather` command also requires the SSH public key to be in place on the cluster nodes.



### IMPORTANT

Do not skip this procedure in production environments, where disaster recovery and debugging is required.



### NOTE

You must use a local key, not one that you configured with platform-specific approaches such as [AWS key pairs](#).

### Procedure

1. If you do not have an existing SSH key pair on your local machine to use for authentication onto your cluster nodes, create one. For example, on a computer that uses a Linux operating system, run the following command:

```
$ ssh-keygen -t ed25519 -N "" -f <path>/<file_name> 1
```

- 1 Specify the path and file name, such as `~/.ssh/id_ed25519`, of the new SSH key. If you have an existing key pair, ensure your public key is in the your `~/.ssh` directory.

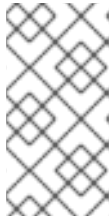
**NOTE**

If you plan to install an OpenShift Container Platform cluster that uses FIPS validated or Modules In Process cryptographic libraries on the **x86\_64** architecture, do not create a key that uses the **ed25519** algorithm. Instead, create a key that uses the **rsa** or **ecdsa** algorithm.

2. View the public SSH key:

```
$ cat <path>/<file_name>.pub
```

For example, run the following to view the `~/.ssh/id_ed25519.pub` public key:

```
$ cat ~/.ssh/id_ed25519.pub
```

3. Add the SSH private key identity to the SSH agent for your local user, if it has not already been added. SSH agent management of the key is required for password-less SSH authentication onto your cluster nodes, or if you want to use the `./openshift-install gather` command.

**NOTE**

On some distributions, default SSH private key identities such as `~/.ssh/id_rsa` and `~/.ssh/id_dsa` are managed automatically.

- a. If the **ssh-agent** process is not already running for your local user, start it as a background task:

```
$ eval "$(ssh-agent -s)"
```

**Example output**

```
Agent pid 31874
```

**NOTE**

If your cluster is in FIPS mode, only use FIPS-compliant algorithms to generate the SSH key. The key must be either RSA or ECDSA.

4. Add your SSH private key to the **ssh-agent**:

```
$ ssh-add <path>/<file_name> 1
```

- 1** Specify the path and file name for your SSH private key, such as `~/.ssh/id_ed25519`

**Example output**

```
Identity added: /home/<you>/<path>/<file_name> (<computer_name>)
```

5. Set the **GOOGLE\_APPLICATION\_CREDENTIALS** environment variable to the full path to your service account private key file.

```
$ export GOOGLE_APPLICATION_CREDENTIALS="<your_service_account_file>"
```

6. Verify that the credentials were applied.

```
$ gcloud auth list
```

### Next steps

- When you install OpenShift Container Platform, provide the SSH public key to the installation program.

## 8.9.6. Obtaining the installation program

Before you install OpenShift Container Platform, download the installation file on a local computer.

### Prerequisites

- You have a computer that runs Linux or macOS, with 500 MB of local disk space

### Procedure

1. Access the [Infrastructure Provider](#) page on the OpenShift Cluster Manager site. If you have a Red Hat account, log in with your credentials. If you do not, create an account.
2. Select your infrastructure provider.
3. Navigate to the page for your installation type, download the installation program that corresponds with your host operating system and architecture, and place the file in the directory where you will store the installation configuration files.



#### IMPORTANT

The installation program creates several files on the computer that you use to install your cluster. You must keep the installation program and the files that the installation program creates after you finish installing the cluster. Both files are required to delete the cluster.

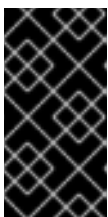

#### IMPORTANT

Deleting the files created by the installation program does not remove your cluster, even if the cluster failed during installation. To remove your cluster, complete the OpenShift Container Platform uninstallation procedures for your specific cloud provider.

4. Extract the installation program. For example, on a computer that uses a Linux operating system, run the following command:

```
$ tar -xvf openshift-install-linux.tar.gz
```

5. Download your installation [pull secret from the Red Hat OpenShift Cluster Manager](#) . This pull secret allows you to authenticate with the services that are provided by the included authorities, including Quay.io, which serves the container images for OpenShift Container Platform components.



## 8.9.7. Manually creating the installation configuration file

For installations of a private OpenShift Container Platform cluster that are only accessible from an internal network and are not visible to the internet, you must manually generate your installation configuration file.

### Prerequisites

- You have an SSH public key on your local machine to provide to the installation program. The key will be used for SSH authentication onto your cluster nodes for debugging and disaster recovery.
- You have obtained the OpenShift Container Platform installation program and the pull secret for your cluster.

### Procedure

1. Create an installation directory to store your required installation assets in:

```
$ mkdir <installation_directory>
```

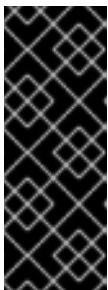

#### IMPORTANT

You must create a directory. Some installation assets, like bootstrap X.509 certificates have short expiration intervals, so you must not reuse an installation directory. If you want to reuse individual files from another cluster installation, you can copy them into your directory. However, the file names for the installation assets might change between releases. Use caution when copying installation files from an earlier OpenShift Container Platform version.

2. Customize the sample **install-config.yaml** file template that is provided and save it in the **<installation\_directory>**.



#### NOTE

You must name this configuration file **install-config.yaml**.



#### NOTE

For some platform types, you can alternatively run **./openshift-install create install-config --dir <installation\_directory>** to generate an **install-config.yaml** file. You can provide details about your cluster configuration at the prompts.

3. Back up the **install-config.yaml** file so that you can use it to install multiple clusters.

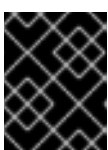

#### IMPORTANT

The **install-config.yaml** file is consumed during the next step of the installation process. You must back it up now.

### 8.9.7.1. Installation configuration parameters

Before you deploy an OpenShift Container Platform cluster, you provide parameter values to describe

your account on the cloud platform that hosts your cluster and optionally customize your cluster's platform. When you create the **install-config.yaml** installation configuration file, you provide values for the required parameters through the command line. If you customize your cluster, you can modify the **install-config.yaml** file to provide more details about the platform.

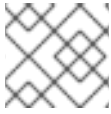

#### NOTE

After installation, you cannot modify these parameters in the **install-config.yaml** file.

#### 8.9.7.1.1. Required configuration parameters

Required installation configuration parameters are described in the following table:

Table 8.32. Required parameters

Parameter	Description	Values
<b>apiVersion</b>	The API version for the <b>install-config.yaml</b> content. The current version is <b>v1</b> . The installer may also support older API versions.	String
<b>baseDomain</b>	The base domain of your cloud provider. The base domain is used to create routes to your OpenShift Container Platform cluster components. The full DNS name for your cluster is a combination of the <b>baseDomain</b> and <b>metadata.name</b> parameter values that uses the <b>&lt;metadata.name&gt;</b> . <b>&lt;baseDomain&gt;</b> format.	A fully-qualified domain or subdomain name, such as <b>example.com</b> .
<b>metadata</b>	Kubernetes resource <b>ObjectMeta</b> , from which only the <b>name</b> parameter is consumed.	Object
<b>metadata.name</b>	The name of the cluster. DNS records for the cluster are all subdomains of <b>{{.metadata.name}}</b> . <b>{{.baseDomain}}</b> .	String of lowercase letters, hyphens (-), and periods (.), such as <b>dev</b> .

Parameter	Description	Values
<b>platform</b>	The configuration for the specific platform upon which to perform the installation: <b>alibabacloud</b> , <b>aws</b> , <b>baremetal</b> , <b>azure</b> , <b>gcp</b> , <b>ibmcloud</b> , <b>openstack</b> , <b>ovirt</b> , <b>vsphere</b> , or <b>{}</b> . For additional information about <b>platform.&lt;platform&gt;</b> parameters, consult the table for your specific platform that follows.	Object
<b>pullSecret</b>	Get a <a href="#">pull secret from the Red Hat OpenShift Cluster Manager</a> to authenticate downloading container images for OpenShift Container Platform components from services such as Quay.io.	<pre>{   "auths":{     "cloud.openshift.com":{       "auth":"b3Blb=",       "email":"you@example.com"     },     "quay.io":{       "auth":"b3Blb=",       "email":"you@example.com"     }   } }</pre>

### 8.9.7.1.2. Network configuration parameters

You can customize your installation configuration based on the requirements of your existing network infrastructure. For example, you can expand the IP address block for the cluster network or provide different IP address blocks than the defaults.

Only IPv4 addresses are supported.

**Table 8.33. Network parameters**

Parameter	Description	Values
-----------	-------------	--------

Parameter	Description	Values
<b>networking</b>	The configuration for the cluster network.	Object  <b>NOTE</b> You cannot modify parameters specified by the <b>networking</b> object after installation.
<b>networking.networkType</b>	The cluster network provider Container Network Interface (CNI) plugin to install.	Either <b>OpenShiftSDN</b> or <b>OVNKubernetes</b> . <b>OpenShiftSDN</b> is a CNI provider for all-Linux networks. <b>OVNKubernetes</b> is a CNI provider for Linux networks and hybrid networks that contain both Linux and Windows servers. The default value is <b>OpenShiftSDN</b> .
<b>networking.clusterNetwork</b>	The IP address blocks for pods.  The default value is <b>10.128.0.0/14</b> with a host prefix of <b>/23</b> .  If you specify multiple IP address blocks, the blocks must not overlap.	An array of objects. For example:  <pre>networking:   clusterNetwork:     - cidr: 10.128.0.0/14       hostPrefix: 23</pre>
<b>networking.clusterNetwork.cidr</b>	Required if you use <b>networking.clusterNetwork</b> . An IP address block.  An IPv4 network.	An IP address block in Classless Inter-Domain Routing (CIDR) notation. The prefix length for an IPv4 block is between <b>0</b> and <b>32</b> .
<b>networking.clusterNetwork.hostPrefix</b>	The subnet prefix length to assign to each individual node. For example, if <b>hostPrefix</b> is set to <b>23</b> then each node is assigned a <b>/23</b> subnet out of the given <b>cidr</b> . A <b>hostPrefix</b> value of <b>23</b> provides 510 ( $2^{(32 - 23)} - 2$ ) pod IP addresses.	A subnet prefix.  The default value is <b>23</b> .
<b>networking.serviceNetwork</b>	The IP address block for services. The default value is <b>172.30.0.0/16</b> .  The OpenShift SDN and OVN-Kubernetes network providers support only a single IP address block for the service network.	An array with an IP address block in CIDR format. For example:  <pre>networking:   serviceNetwork:     - 172.30.0.0/16</pre>

Parameter	Description	Values
<b>networking.machineNetwork</b>	The IP address blocks for machines.  If you specify multiple IP address blocks, the blocks must not overlap.	An array of objects. For example:  <pre>networking:   machineNetwork:   - cidr: 10.0.0.0/16</pre>
<b>networking.machineNetwork.cidr</b>	Required if you use <b>networking.machineNetwork</b> . An IP address block. The default value is <b>10.0.0.0/16</b> for all platforms other than libvirt. For libvirt, the default value is <b>192.168.126.0/24</b> .	An IP network block in CIDR notation.  For example, <b>10.0.0.0/16</b> .   <p><b>NOTE</b></p> <p>Set the <b>networking.machineNetwork</b> to match the CIDR that the preferred NIC resides in.</p>

### 8.9.7.1.3. Optional configuration parameters



Optional installation configuration parameters are described in the following table:

Table 8.34. Optional parameters

Parameter	Description	Values
<b>additionalTrustBundle</b>	A PEM-encoded X.509 certificate bundle that is added to the nodes' trusted certificate store. This trust bundle may also be used when a proxy has been configured.	String
<b>cgroupsV2</b>	Enables <a href="#">Linux control groups version 2</a> (cgroups v2) on specific nodes in your cluster. The OpenShift Container Platform process for enabling cgroups v2 disables all cgroup version 1 controllers and hierarchies. The OpenShift Container Platform cgroups version 2 feature is in Developer Preview and is not supported by Red Hat at this time.	<b>true</b>
<b>compute</b>	The configuration for the machines that comprise the compute nodes.	Array of <b>MachinePool</b> objects.

Parameter	Description	Values
<b>compute.architecture</b>	Determines the instruction set architecture of the machines in the pool. Currently, clusters with varied architectures are not supported. All pools must specify the same architecture. Valid values are <b>amd64</b> (the default).	String
<b>compute.hyperthreading</b>	Whether to enable or disable simultaneous multithreading, or <b>hyperthreading</b> , on compute machines. By default, simultaneous multithreading is enabled to increase the performance of your machines' cores.   <b>IMPORTANT</b> If you disable simultaneous multithreading, ensure that your capacity planning accounts for the dramatically decreased machine performance.	<b>Enabled</b> or <b>Disabled</b>
<b>compute.name</b>	Required if you use <b>compute</b> . The name of the machine pool.	<b>worker</b>
<b>compute.platform</b>	Required if you use <b>compute</b> . Use this parameter to specify the cloud provider to host the worker machines. This parameter value must match the <b>controlPlane.platform</b> parameter value.	<b>alibabacloud, aws, azure, gcp, ibmcloud, openstack, ovirt, vsphere</b> , or <b>{}</b>
<b>compute.replicas</b>	The number of compute machines, which are also known as worker machines, to provision.	A positive integer greater than or equal to <b>2</b> . The default value is <b>3</b> .
<b>controlPlane</b>	The configuration for the machines that comprise the control plane.	Array of <b>MachinePool</b> objects.

Parameter	Description	Values
<b>controlPlane.architecture</b>	Determines the instruction set architecture of the machines in the pool. Currently, clusters with varied architectures are not supported. All pools must specify the same architecture. Valid values are <b>amd64</b> (the default).	String
<b>controlPlane.hyperthreading</b>	Whether to enable or disable simultaneous multithreading, or <b>hyperthreading</b> , on control plane machines. By default, simultaneous multithreading is enabled to increase the performance of your machines' cores.   <b>IMPORTANT</b>  If you disable simultaneous multithreading, ensure that your capacity planning accounts for the dramatically decreased machine performance.	<b>Enabled</b> or <b>Disabled</b>
<b>controlPlane.name</b>	Required if you use <b>controlPlane</b> . The name of the machine pool.	<b>master</b>
<b>controlPlane.platform</b>	Required if you use <b>controlPlane</b> . Use this parameter to specify the cloud provider that hosts the control plane machines. This parameter value must match the <b>compute.platform</b> parameter value.	<b>alibabacloud, aws, azure, gcp, ibmcloud, openstack, ovirt, vsphere</b> , or <b>{}</b>
<b>controlPlane.replicas</b>	The number of control plane machines to provision.	The only supported value is <b>3</b> , which is the default value.

Parameter	Description	Values
<b>credentialsMode</b>	<p>The Cloud Credential Operator (CCO) mode. If no mode is specified, the CCO dynamically tries to determine the capabilities of the provided credentials, with a preference for mint mode on the platforms where multiple modes are supported. If you are installing on GCP into a shared virtual private cloud (VPC), <b>credentialsMode</b> must be set to <b>Passthrough</b>.</p> <p> <b>NOTE</b></p> <p>Not all CCO modes are supported for all cloud providers. For more information on CCO modes, see the <i>Cloud Credential Operator</i> entry in the <i>Cluster Operators reference</i> content.</p> <p> <b>NOTE</b></p> <p>If your AWS account has service control policies (SCP) enabled, you must configure the <b>credentialsMode</b> parameter to <b>Mint</b>, <b>Passthrough</b> or <b>Manual</b>.</p>	<b>Mint, Passthrough, Manual</b> or an empty string ("").



Parameter	Description	Values
<b>fips</b>	<p>Enable or disable FIPS mode. The default is <b>false</b> (disabled). If FIPS mode is enabled, the Red Hat Enterprise Linux CoreOS (RHCOS) machines that OpenShift Container Platform runs on bypass the default Kubernetes cryptography suite and use the cryptography modules that are provided with RHCOS instead.</p> <div style="display: flex; align-items: flex-start;"> <div style="width: 20px; height: 100px; background: repeating-linear-gradient(45deg, transparent, transparent 2px, black 2px, black 4px); margin-right: 10px;"></div> <div> <p><b>IMPORTANT</b></p> <p>To enable FIPS mode for your cluster, you must run the installation program from a Red Hat Enterprise Linux (RHEL) computer configured to operate in FIPS mode. For more information about configuring FIPS mode on RHEL, see <a href="#">Installing the system in FIPS mode</a>. The use of FIPS validated or Modules In Process cryptographic libraries is only supported on OpenShift Container Platform deployments on the <b>x86_64</b> architecture.</p> </div> </div> <div style="display: flex; align-items: flex-start; margin-top: 10px;"> <div style="width: 20px; height: 50px; background: repeating-linear-gradient(45deg, transparent, transparent 2px, black 2px, black 4px); margin-right: 10px;"></div> <div> <p><b>NOTE</b></p> <p>If you are using Azure File storage, you cannot enable FIPS mode.</p> </div> </div>	<b>false</b> or <b>true</b>
<b>imageContentSources</b>	Sources and repositories for the release-image content.	Array of objects. Includes a <b>source</b> and, optionally, <b>mirrors</b> , as described in the following rows of this table.
<b>imageContentSources.source</b>	Required if you use <b>imageContentSources</b> . Specify the repository that users refer to, for example, in image pull specifications.	String
<b>imageContentSources.mirrors</b>	Specify one or more repositories that may also contain the same images.	Array of strings

Parameter	Description	Values
<b>publish</b>	How to publish or expose the user-facing endpoints of your cluster, such as the Kubernetes API, OpenShift routes.	<b>Internal</b> or <b>External</b> . To deploy a private cluster, which cannot be accessed from the internet, set <b>publish</b> to <b>Internal</b> . The default value is <b>External</b> .
<b>sshKey</b>	<p>The SSH key or keys to authenticate access your cluster machines.</p>  <p><b>NOTE</b></p> <p>For production OpenShift Container Platform clusters on which you want to perform installation debugging or disaster recovery, specify an SSH key that your <b>ssh-agent</b> process uses.</p>	<p>One or more keys. For example:</p> <pre>sshKey:   &lt;key1&gt;   &lt;key2&gt;   &lt;key3&gt;</pre>

#### 8.9.7.1.4. Additional Google Cloud Platform (GCP) configuration parameters

Additional GCP configuration parameters are described in the following table:

Table 8.35. Additional GCP parameters

Parameter	Description	Values
<b>platform.gcp.network</b>	The name of the existing VPC that you want to deploy your cluster to.	String.
<b>platform.gcp.region</b>	The name of the GCP region that hosts your cluster.	Any valid region name, such as <b>us-central1</b> .
<b>platform.gcp.type</b>	The <a href="#">GCP machine type</a> .	The GCP machine type.
<b>platform.gcp.zones</b>	The availability zones where the installation program creates machines for the specified MachinePool.	A list of valid <a href="#">GCP availability zones</a> , such as <b>us-central1-a</b> , in a <a href="#">YAML sequence</a> .

Parameter	Description	Values
<code>platform.gcp.controlPlaneSubnet</code>	The name of the existing subnet in your VPC that you want to deploy your control plane machines to.	The subnet name.
<code>platform.gcp.computeSubnet</code>	The name of the existing subnet in your VPC that you want to deploy your compute machines to.	The subnet name.
<code>platform.gcp.licenses</code>	<p>A list of license URLs that must be applied to the compute images.</p>  <p><b>IMPORTANT</b></p> <p>The <b>licenses</b> parameter is a deprecated field and nested virtualization is enabled by default. It is not recommended to use this field.</p>	Any license available with the <a href="#">license API</a> , such as the license to enable <a href="#">nested virtualization</a> . You cannot use this parameter with a mechanism that generates pre-built images. Using a license URL forces the installer to copy the source image before use.
<code>platform.gcp.osDiskSizeGB</code>	The size of the disk in gigabytes (GB).	Any size between 16 GB and 65536 GB.
<code>platform.gcp.osDiskType</code>	The type of disk.	Either the default <b>pd-ssd</b> or the <b>pd-standard</b> disk type. The control plane nodes must be the <b>pd-ssd</b> disk type. The worker nodes can be either type.

Parameter	Description	Values
<b>controlPlane.platform.gcp.osDiskEncryptionKey.kmsKeyName</b>	The name of the customer managed encryption key to be used for control plane machine disk encryption.	The encryption key name.
<b>controlPlane.platform.gcp.osDiskEncryptionKey.kmsKeyRing</b>	For control plane machines, the name of the KMS key ring to which the KMS key belongs.	The KMS key ring name.
<b>controlPlane.platform.gcp.osDiskEncryptionKey.kmsKeyLocation</b>	For control plane machines, the GCP location in which the key ring exists. For more information on KMS locations, see Google's documentation on <a href="#">Cloud KMS locations</a> .	The GCP location for the key ring.
<b>controlPlane.platform.gcp.osDiskEncryptionKey.projectID</b>	For control plane machines, the ID of the project in which the KMS key ring exists. This value defaults to the VM project ID if not set.	The GCP project ID.

Parameter	Description	Values
<code>compute.platform.gcp.osDisk.encryptionKey.kmsKeyName</code>	The name of the customer managed encryption key to be used for compute machine disk encryption.	The encryption key name.
<code>compute.platform.gcp.osDisk.encryptionKey.kmsKeyRing</code>	For compute machines, the name of the KMS key ring to which the KMS key belongs.	The KMS key ring name.
<code>compute.platform.gcp.osDisk.encryptionKey.kmsKeyLocation</code>	For compute machines, the GCP location in which the key ring exists. For more information on KMS locations, see Google's documentation on <a href="#">Cloud KMS locations</a> .	The GCP location for the key ring.
<code>compute.platform.gcp.osDisk.encryptionKey.projectID</code>	For compute machines, the ID of the project in which the KMS key ring exists. This value defaults to the VM project ID if not set.	The GCP project ID.

### 8.9.7.2. Minimum resource requirements for cluster installation

Each cluster machine must meet the following minimum requirements:

**Table 8.36. Minimum resource requirements**

Machine	Operating System	vCPU [1]	Virtual RAM	Storage	IOPS [2]
Bootstrap	RHCOS	4	16 GB	100 GB	300
Control plane	RHCOS	4	16 GB	100 GB	300
Compute	RHCOS, RHEL 8.4, or RHEL 8.5 [3]	2	8 GB	100 GB	300

1. One vCPU is equivalent to one physical core when simultaneous multithreading (SMT), or hyperthreading, is not enabled. When enabled, use the following formula to calculate the corresponding ratio: (threads per core × cores) × sockets = vCPUs.
2. OpenShift Container Platform and Kubernetes are sensitive to disk performance, and faster storage is recommended, particularly for etcd on the control plane nodes which require a 10 ms p99 fsync duration. Note that on many cloud platforms, storage size and IOPS scale together, so you might need to over-allocate storage volume to obtain sufficient performance.
3. As with all user-provisioned installations, if you choose to use RHEL compute machines in your cluster, you take responsibility for all operating system life cycle management and maintenance, including performing system updates, applying patches, and completing all other required tasks. Use of RHEL 7 compute machines is deprecated and has been removed in OpenShift Container Platform 4.10 and later.

If an instance type for your platform meets the minimum requirements for cluster machines, it is supported to use in OpenShift Container Platform.

### 8.9.7.3. Tested instance types for GCP

The following Google Cloud Platform instance types have been tested with OpenShift Container Platform.

#### Example 8.25. Machine series

- **C2**
- **C2D**
- **C3**
- **E2**
- **M1**
- **N1**

- N2
- N2D
- Tau T2D

#### 8.9.7.4. Using custom machine types

Using a custom machine type to install a OpenShift Container Platform cluster is supported.

Consider the following when using a custom machine type:

- Similar to predefined instance types, custom machine types must meet the minimum resource requirements for control plane and compute machines. For more information, see "Minimum resource requirements for cluster installation".
- The name of the custom machine type must adhere to the following syntax:  
**custom-<number\_of\_cpus>-<amount\_of\_memory\_in\_mb>**

For example, **custom-6-20480**.

As part of the installation process, you specify the custom machine type in the **install-config.yaml** file.

#### Sample install-config.yaml file with a custom machine type

```
compute:
- architecture: amd64
  hyperthreading: Enabled
  name: worker
  platform:
    gcp:
      type: custom-6-20480
  replicas: 2
controlPlane:
  architecture: amd64
  hyperthreading: Enabled
  name: master
  platform:
    gcp:
      type: custom-6-20480
  replicas: 3
```

#### 8.9.7.5. Sample customized install-config.yaml file for GCP

You can customize the **install-config.yaml** file to specify more details about your OpenShift Container Platform cluster's platform or modify the values of the required parameters.

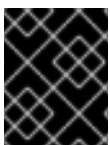

#### IMPORTANT

This sample YAML file is provided for reference only. You must obtain your **install-config.yaml** file by using the installation program and modify it.

```
apiVersion: v1
```

```
baseDomain: example.com 1
controlPlane: 2 3
  hyperthreading: Enabled 4
  name: master
  platform:
    gcp:
      type: n2-standard-4
      zones:
        - us-central1-a
        - us-central1-c
      osDisk:
        diskType: pd-ssd
        diskSizeGB: 1024
        encryptionKey: 5
        kmsKey:
          name: worker-key
          keyRing: test-machine-keys
          location: global
          projectID: project-id
      replicas: 3
compute: 6 7
- hyperthreading: Enabled 8
  name: worker
  platform:
    gcp:
      type: n2-standard-4
      zones:
        - us-central1-a
        - us-central1-c
      osDisk:
        diskType: pd-standard
        diskSizeGB: 128
        encryptionKey: 9
        kmsKey:
          name: worker-key
          keyRing: test-machine-keys
          location: global
          projectID: project-id
      replicas: 3
metadata:
  name: test-cluster 10
networking:
  clusterNetwork:
    - cidr: 10.128.0.0/14
      hostPrefix: 23
  machineNetwork:
    - cidr: 10.0.0.0/16
  networkType: OpenShiftSDN
  serviceNetwork:
    - 172.30.0.0/16
platform:
  gcp:
    projectID: openshift-production 11
    region: us-central1 12
    network: existing_vpc 13
```



```

controlPlaneSubnet: control_plane_subnet 14
computeSubnet: compute_subnet 15
pullSecret: '{"auths": ...}' 16
fips: false 17
sshKey: ssh-ed25519 AAAA... 18
publish: Internal 19

```

- 1 10 11 12 16 Required. The installation program prompts you for this value.
- 2 6 If you do not provide these parameters and values, the installation program provides the default value.
- 3 7 The **controlPlane** section is a single mapping, but the **compute** section is a sequence of mappings. To meet the requirements of the different data structures, the first line of the **compute** section must begin with a hyphen, -, and the first line of the **controlPlane** section must not. Only one control plane pool is used.
- 4 8 Whether to enable or disable simultaneous multithreading, or **hyperthreading**. By default, simultaneous multithreading is enabled to increase the performance of your machines' cores. You can disable it by setting the parameter value to **Disabled**. If you disable simultaneous multithreading in some cluster machines, you must disable it in all cluster machines.



### IMPORTANT

If you disable simultaneous multithreading, ensure that your capacity planning accounts for the dramatically decreased machine performance. Use larger machine types, such as **n1-standard-8**, for your machines if you disable simultaneous multithreading.

- 5 9 Optional: The custom encryption key section to encrypt both virtual machines and persistent volumes. Your default compute service account must have the permissions granted to use your KMS key and have the correct IAM role assigned. The default service account name follows the **service-`<project_number>`@compute-system.iam.gserviceaccount.com** pattern. For more information on granting the correct permissions for your service account, see "Machine management" → "Creating machine sets" → "Creating a machine set on GCP".
- 13 Specify the name of an existing VPC.
- 14 Specify the name of the existing subnet to deploy the control plane machines to. The subnet must belong to the VPC that you specified.
- 15 Specify the name of the existing subnet to deploy the compute machines to. The subnet must belong to the VPC that you specified.
- 17 Whether to enable or disable FIPS mode. By default, FIPS mode is not enabled. If FIPS mode is enabled, the Red Hat Enterprise Linux CoreOS (RHCOS) machines that OpenShift Container Platform runs on bypass the default Kubernetes cryptography suite and use the cryptography modules that are provided with RHCOS instead.



## IMPORTANT

To enable FIPS mode for your cluster, you must run the installation program from a Red Hat Enterprise Linux (RHEL) computer configured to operate in FIPS mode. For more information about configuring FIPS mode on RHEL, see [Installing the system in FIPS mode](#). The use of FIPS validated or Modules In Process cryptographic libraries is only supported on OpenShift Container Platform deployments on the **x86\_64** architecture.

- 18 You can optionally provide the **sshKey** value that you use to access the machines in your cluster.



## NOTE

For production OpenShift Container Platform clusters on which you want to perform installation debugging or disaster recovery, specify an SSH key that your **ssh-agent** process uses.

- 19 How to publish the user-facing endpoints of your cluster. Set **publish** to **Internal** to deploy a private cluster, which cannot be accessed from the internet. The default value is **External**.

### 8.9.7.6. Create an Ingress Controller with global access on GCP

You can create an Ingress Controller that has global access to a Google Cloud Platform (GCP) cluster. Global access is only available to Ingress Controllers using internal load balancers.

#### Prerequisites

- You created the **install-config.yaml** and complete any modifications to it.

#### Procedure

Create an Ingress Controller with global access on a new GCP cluster.

1. Change to the directory that contains the installation program and create a manifest file:

```
$ ./openshift-install create manifests --dir <installation_directory> 1
```

- 1 For **<installation\_directory>**, specify the name of the directory that contains the **install-config.yaml** file for your cluster.

2. Create a file that is named **cluster-ingress-default-ingresscontroller.yaml** in the **<installation\_directory>/manifests/** directory:

```
$ touch <installation_directory>/manifests/cluster-ingress-default-ingresscontroller.yaml 1
```

- 1 For **<installation\_directory>**, specify the directory name that contains the **manifests/** directory for your cluster.

After creating the file, several network configuration files are in the **manifests/** directory, as shown:

```
$ ls <installation_directory>/manifests/cluster-ingress-default-ingresscontroller.yaml
```

### Example output

```
cluster-ingress-default-ingresscontroller.yaml
```

3. Open the **cluster-ingress-default-ingresscontroller.yaml** file in an editor and enter a custom resource (CR) that describes the Operator configuration you want:

### Sample `clientAccess` configuration to Global

```
apiVersion: operator.openshift.io/v1
kind: IngressController
metadata:
  name: default
  namespace: openshift-ingress-operator
spec:
  endpointPublishingStrategy:
    loadBalancer:
      providerParameters:
        gcp:
          clientAccess: Global 1
          type: GCP
        scope: Internal 2
      type: LoadBalancerService
```

- 1** Set `gcp.clientAccess` to **Global**.
- 2** Global access is only available to Ingress Controllers using internal load balancers.

## 8.9.8. Additional resources

- [Enabling customer-managed encryption keys for a machine set](#)

### 8.9.8.1. Configuring the cluster-wide proxy during installation

Production environments can deny direct access to the internet and instead have an HTTP or HTTPS proxy available. You can configure a new OpenShift Container Platform cluster to use a proxy by configuring the proxy settings in the **install-config.yaml** file.

#### Prerequisites

- You have an existing **install-config.yaml** file.
- You reviewed the sites that your cluster requires access to and determined whether any of them need to bypass the proxy. By default, all cluster egress traffic is proxied, including calls to hosting cloud provider APIs. You added sites to the **Proxy** object's **spec.noProxy** field to bypass the proxy if necessary.



## NOTE

The **Proxy** object **status.noProxy** field is populated with the values of the **networking.machineNetwork[].cidr**, **networking.clusterNetwork[].cidr**, and **networking.serviceNetwork[]** fields from your installation configuration.

For installations on Amazon Web Services (AWS), Google Cloud Platform (GCP), Microsoft Azure, and Red Hat OpenStack Platform (RHOSP), the **Proxy** object **status.noProxy** field is also populated with the instance metadata endpoint (**169.254.169.254**).

## Procedure

1. Edit your **install-config.yaml** file and add the proxy settings. For example:

```
apiVersion: v1
baseDomain: my.domain.com
proxy:
  httpProxy: http://<username>:<pswd>@<ip>:<port> 1
  httpsProxy: https://<username>:<pswd>@<ip>:<port> 2
  noProxy: example.com 3
  additionalTrustBundle: | 4
    -----BEGIN CERTIFICATE-----
    <MY_TRUSTED_CA_CERT>
    -----END CERTIFICATE-----
  ...
```

- 1 A proxy URL to use for creating HTTP connections outside the cluster. The URL scheme must be **http**.
- 2 A proxy URL to use for creating HTTPS connections outside the cluster.
- 3 A comma-separated list of destination domain names, IP addresses, or other network CIDRs to exclude from proxying. Preface a domain with **.** to match subdomains only. For example, **.y.com** matches **x.y.com**, but not **y.com**. Use **\*** to bypass the proxy for all destinations.
- 4 If provided, the installation program generates a config map that is named **user-ca-bundle** in the **openshift-config** namespace that contains one or more additional CA certificates that are required for proxying HTTPS connections. The Cluster Network Operator then creates a **trusted-ca-bundle** config map that merges these contents with the Red Hat Enterprise Linux CoreOS (RHCOS) trust bundle, and this config map is referenced in the **trustedCA** field of the **Proxy** object. The **additionalTrustBundle** field is required unless the proxy's identity certificate is signed by an authority from the RHCOS trust bundle.



## NOTE

The installation program does not support the proxy **readinessEndpoints** field.

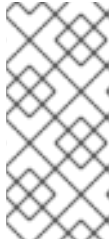
**NOTE**

If the installer times out, restart and then complete the deployment by using the **wait-for** command of the installer. For example:

```
$ ./openshift-install wait-for install-complete --log-level debug
```

2. Save the file and reference it when installing OpenShift Container Platform.

The installation program creates a cluster-wide proxy that is named **cluster** that uses the proxy settings in the provided **install-config.yaml** file. If no proxy settings are provided, a **cluster Proxy** object is still created, but it will have a nil **spec**.

**NOTE**

Only the **Proxy** object named **cluster** is supported, and no additional proxies can be created.

### 8.9.9. Deploying the cluster

You can install OpenShift Container Platform on a compatible cloud platform.

**IMPORTANT**

You can run the **create cluster** command of the installation program only once, during initial installation.

#### Prerequisites

- Configure an account with the cloud platform that hosts your cluster.
- Obtain the OpenShift Container Platform installation program and the pull secret for your cluster.

#### Procedure

1. Change to the directory that contains the installation program and initialize the cluster deployment:

```
$ ./openshift-install create cluster --dir <installation_directory> \ 1  
--log-level=info 2
```

- 1** For **<installation\_directory>**, specify the
- 2** To view different installation details, specify **warn**, **debug**, or **error** instead of **info**.

**NOTE**

If the cloud provider account that you configured on your host does not have sufficient permissions to deploy the cluster, the installation process stops, and the missing permissions are displayed.

When the cluster deployment completes, directions for accessing your cluster, including a link to its web console and credentials for the **kubeadmin** user, display in your terminal.

### Example output

```
...
INFO Install complete!
INFO To access the cluster as the system:admin user when using 'oc', run 'export
KUBECONFIG=/home/myuser/install_dir/auth/kubeconfig'
INFO Access the OpenShift web-console here: https://console-openshift-
console.apps.mycluster.example.com
INFO Login to the console with user: "kubeadmin", and password: "4vYBz-Ee6gm-ymBZj-
Wt5AL"
INFO Time elapsed: 36m22s
```



### NOTE

The cluster access and credential information also outputs to **<installation\_directory>/openshift\_install.log** when an installation succeeds.

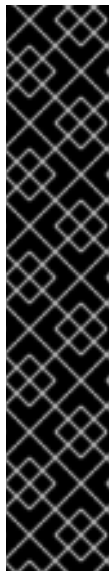

### IMPORTANT

- The Ignition config files that the installation program generates contain certificates that expire after 24 hours, which are then renewed at that time. If the cluster is shut down before renewing the certificates and the cluster is later restarted after the 24 hours have elapsed, the cluster automatically recovers the expired certificates. The exception is that you must manually approve the pending **node-bootstrapper** certificate signing requests (CSRs) to recover kubelet certificates. See the documentation for *Recovering from expired control plane certificates* for more information.
- It is recommended that you use Ignition config files within 12 hours after they are generated because the 24-hour certificate rotates from 16 to 22 hours after the cluster is installed. By using the Ignition config files within 12 hours, you can avoid installation failure if the certificate update runs during installation.



### IMPORTANT

You must not delete the installation program or the files that the installation program creates. Both are required to delete the cluster.

## 8.9.10. Installing the OpenShift CLI by downloading the binary

You can install the OpenShift CLI (**oc**) to interact with OpenShift Container Platform from a command-line interface. You can install **oc** on Linux, Windows, or macOS.

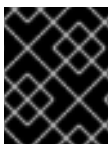

### IMPORTANT

If you installed an earlier version of **oc**, you cannot use it to complete all of the commands in OpenShift Container Platform 4.10. Download and install the new version of **oc**.

### Installing the OpenShift CLI on Linux

You can install the OpenShift CLI (**oc**) binary on Linux by using the following procedure.

### Procedure

1. Navigate to the [OpenShift Container Platform downloads page](#) on the Red Hat Customer Portal.
2. Select the appropriate version in the **Version** drop-down menu.
3. Click **Download Now** next to the **OpenShift v4.10 Linux Client** entry and save the file.
4. Unpack the archive:

```
$ tar xvf <file>
```

5. Place the **oc** binary in a directory that is on your **PATH**.  
To check your **PATH**, execute the following command:

```
$ echo $PATH
```

After you install the OpenShift CLI, it is available using the **oc** command:

```
$ oc <command>
```

### Installing the OpenShift CLI on Windows

You can install the OpenShift CLI (**oc**) binary on Windows by using the following procedure.

### Procedure

1. Navigate to the [OpenShift Container Platform downloads page](#) on the Red Hat Customer Portal.
2. Select the appropriate version in the **Version** drop-down menu.
3. Click **Download Now** next to the **OpenShift v4.10 Windows Client** entry and save the file.
4. Unzip the archive with a ZIP program.
5. Move the **oc** binary to a directory that is on your **PATH**.  
To check your **PATH**, open the command prompt and execute the following command:

```
C:\> path
```

After you install the OpenShift CLI, it is available using the **oc** command:

```
C:\> oc <command>
```

### Installing the OpenShift CLI on macOS

You can install the OpenShift CLI (**oc**) binary on macOS by using the following procedure.

### Procedure

1. Navigate to the [OpenShift Container Platform downloads page](#) on the Red Hat Customer Portal.
2. Select the appropriate version in the **Version** drop-down menu.
3. Click **Download Now** next to the **OpenShift v4.10 MacOSX Client** entry and save the file.
4. Unpack and unzip the archive.
5. Move the **oc** binary to a directory on your PATH.  
To check your **PATH**, open a terminal and execute the following command:

```
$ echo $PATH
```

After you install the OpenShift CLI, it is available using the **oc** command:

```
$ oc <command>
```

### 8.9.11. Logging in to the cluster by using the CLI

You can log in to your cluster as a default system user by exporting the cluster **kubeconfig** file. The **kubeconfig** file contains information about the cluster that is used by the CLI to connect a client to the correct cluster and API server. The file is specific to a cluster and is created during OpenShift Container Platform installation.

#### Prerequisites

- You deployed an OpenShift Container Platform cluster.
- You installed the **oc** CLI.

#### Procedure

1. Export the **kubeadmin** credentials:

```
$ export KUBECONFIG=<installation_directory>/auth/kubeconfig 1
```

- 1** For **<installation\_directory>**, specify the path to the directory that you stored the installation files in.

2. Verify you can run **oc** commands successfully using the exported configuration:

```
$ oc whoami
```

#### Example output

```
system:admin
```

#### Additional resources

- See [Accessing the web console](#) for more details about accessing and understanding the OpenShift Container Platform web console.



### 8.9.12. Telemetry access for OpenShift Container Platform

In OpenShift Container Platform 4.10, the Telemetry service, which runs by default to provide metrics about cluster health and the success of updates, requires internet access. If your cluster is connected to the internet, Telemetry runs automatically, and your cluster is registered to [OpenShift Cluster Manager](#).

After you confirm that your [OpenShift Cluster Manager](#) inventory is correct, either maintained automatically by Telemetry or manually by using OpenShift Cluster Manager, [use subscription watch](#) to track your OpenShift Container Platform subscriptions at the account or multi-cluster level.

#### Additional resources

- See [About remote health monitoring](#) for more information about the Telemetry service

### 8.9.13. Next steps

- [Customize your cluster](#).
- If necessary, you can [opt out of remote health reporting](#).

## 8.10. INSTALLING A CLUSTER ON USER-PROVISIONED INFRASTRUCTURE IN GCP BY USING DEPLOYMENT MANAGER TEMPLATES

In OpenShift Container Platform version 4.10, you can install a cluster on Google Cloud Platform (GCP) that uses infrastructure that you provide.

The steps for performing a user-provided infrastructure install are outlined here. Several [Deployment Manager](#) templates are provided to assist in completing these steps or to help model your own. You are also free to create the required resources through other methods.

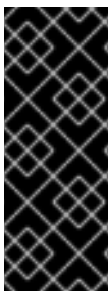

#### IMPORTANT

The steps for performing a user-provisioned infrastructure installation are provided as an example only. Installing a cluster with infrastructure you provide requires knowledge of the cloud provider and the installation process of OpenShift Container Platform. Several Deployment Manager templates are provided to assist in completing these steps or to help model your own. You are also free to create the required resources through other methods; the templates are just an example.

### 8.10.1. Prerequisites

- You reviewed details about the [OpenShift Container Platform installation and update](#) processes.
- You read the documentation on [selecting a cluster installation method and preparing it for users](#).
- If you use a firewall and plan to use the Telemetry service, you [configured the firewall to allow the sites](#) that your cluster requires access to.
- If the cloud identity and access management (IAM) APIs are not accessible in your environment, or if you do not want to store an administrator-level credential secret in the **kube-system** namespace, you can [manually create and maintain IAM credentials](#).

**NOTE**

Be sure to also review this site list if you are configuring a proxy.

## 8.10.2. Certificate signing requests management

Because your cluster has limited access to automatic machine management when you use infrastructure that you provision, you must provide a mechanism for approving cluster certificate signing requests (CSRs) after installation. The **kube-controller-manager** only approves the kubelet client CSRs. The **machine-approver** cannot guarantee the validity of a serving certificate that is requested by using kubelet credentials because it cannot confirm that the correct machine issued the request. You must determine and implement a method of verifying the validity of the kubelet serving certificate requests and approving them.

## 8.10.3. Internet access for OpenShift Container Platform

In OpenShift Container Platform 4.10, you require access to the internet to install your cluster.

You must have internet access to:

- Access [OpenShift Cluster Manager](#) to download the installation program and perform subscription management. If the cluster has internet access and you do not disable Telemetry, that service automatically entitles your cluster.
- Access [Quay.io](#) to obtain the packages that are required to install your cluster.
- Obtain the packages that are required to perform cluster updates.

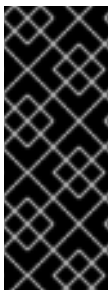
**IMPORTANT**

If your cluster cannot have direct internet access, you can perform a restricted network installation on some types of infrastructure that you provision. During that process, you download the required content and use it to populate a mirror registry with the installation packages. With some installation types, the environment that you install your cluster in will not require internet access. Before you update the cluster, you update the content of the mirror registry.

## 8.10.4. Configuring your GCP project

Before you can install OpenShift Container Platform, you must configure a Google Cloud Platform (GCP) project to host it.

### 8.10.4.1. Creating a GCP project

To install OpenShift Container Platform, you must create a project in your Google Cloud Platform (GCP) account to host the cluster.

**Procedure**

- Create a project to host your OpenShift Container Platform cluster. See [Creating and Managing Projects](#) in the GCP documentation.



## IMPORTANT

Your GCP project must use the Premium Network Service Tier if you are using installer-provisioned infrastructure. The Standard Network Service Tier is not supported for clusters installed using the installation program. The installation program configures internal load balancing for the **api-int.<cluster\_name>.<base\_domain>** URL; the Premium Tier is required for internal load balancing.

### 8.10.4.2. Enabling API services in GCP

Your Google Cloud Platform (GCP) project requires access to several API services to complete OpenShift Container Platform installation.

#### Prerequisites

- You created a project to host your cluster.

#### Procedure

- Enable the following required API services in the project that hosts your cluster. You can also enable optional API services which are not required for installation. See [Enabling services](#) in the GCP documentation.

**Table 8.37. Required API services**

API service	Console service name
Compute Engine API	<b>compute.googleapis.com</b>
Cloud Resource Manager API	<b>cloudresourcemanager.googleapis.com</b>
Google DNS API	<b>dns.googleapis.com</b>
IAM Service Account Credentials API	<b>iamcredentials.googleapis.com</b>
Identity and Access Management (IAM) API	<b>iam.googleapis.com</b>
Service Usage API	<b>serviceusage.googleapis.com</b>

**Table 8.38. Optional API services**

API service	Console service name
Cloud Deployment Manager V2 API	<b>deploymentmanager.googleapis.com</b>
Google Cloud APIs	<b>cloudapis.googleapis.com</b>
Service Management API	<b>servicemanagement.googleapis.com</b>

API service	Console service name
Google Cloud Storage JSON API	<b>storage-api.googleapis.com</b>
Cloud Storage	<b>storage-component.googleapis.com</b>

### 8.10.4.3. Configuring DNS for GCP

To install OpenShift Container Platform, the Google Cloud Platform (GCP) account you use must have a dedicated public hosted zone in the same project that you host the OpenShift Container Platform cluster. This zone must be authoritative for the domain. The DNS service provides cluster DNS resolution and name lookup for external connections to the cluster.

#### Procedure

1. Identify your domain, or subdomain, and registrar. You can transfer an existing domain and registrar or obtain a new one through GCP or another source.

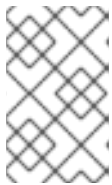

#### NOTE

If you purchase a new domain, it can take time for the relevant DNS changes to propagate. For more information about purchasing domains through Google, see [Google Domains](#).

2. Create a public hosted zone for your domain or subdomain in your GCP project. See [Creating public zones](#) in the GCP documentation. Use an appropriate root domain, such as **openshiftcorp.com**, or subdomain, such as **clusters.openshiftcorp.com**.
3. Extract the new authoritative name servers from the hosted zone records. See [Look up your Cloud DNS name servers](#) in the GCP documentation. You typically have four name servers.
4. Update the registrar records for the name servers that your domain uses. For example, if you registered your domain to Google Domains, see the following topic in the Google Domains Help: [How to switch to custom name servers](#).
5. If you migrated your root domain to Google Cloud DNS, migrate your DNS records. See [Migrating to Cloud DNS](#) in the GCP documentation.
6. If you use a subdomain, follow your company's procedures to add its delegation records to the parent domain. This process might include a request to your company's IT department or the division that controls the root domain and DNS services for your company.

### 8.10.4.4. GCP account limits

The OpenShift Container Platform cluster uses a number of Google Cloud Platform (GCP) components, but the default [Quotas](#) do not affect your ability to install a default OpenShift Container Platform cluster.

A default cluster, which contains three compute and three control plane machines, uses the following resources. Note that some resources are required only during the bootstrap process and are removed after the cluster deploys.

Table 8.39. GCP resources used in a default cluster

Service	Component	Location	Total resources required	Resources removed after bootstrap
Service account	IAM	Global	5	0
Firewall rules	Networking	Global	11	1
Forwarding rules	Compute	Global	2	0
Health checks	Compute	Global	2	0
Images	Compute	Global	1	0
Networks	Networking	Global	1	0
Routers	Networking	Global	1	0
Routes	Networking	Global	2	0
Subnetworks	Compute	Global	2	0
Target pools	Networking	Global	2	0

**NOTE**

If any of the quotas are insufficient during installation, the installation program displays an error that states both which quota was exceeded and the region.

Be sure to consider your actual cluster size, planned cluster growth, and any usage from other clusters that are associated with your account. The CPU, static IP addresses, and persistent disk SSD (storage) quotas are the ones that are most likely to be insufficient.

If you plan to deploy your cluster in one of the following regions, you will exceed the maximum storage quota and are likely to exceed the CPU quota limit:

- **asia-east2**
- **asia-northeast2**
- **asia-south1**
- **australia-southeast1**
- **europa-north1**
- **europa-west2**
- **europa-west3**

- **europa-west6**
- **northamerica-northeast1**
- **southamerica-east1**
- **us-west2**

You can increase resource quotas from the [GCP console](#), but you might need to file a support ticket. Be sure to plan your cluster size early so that you can allow time to resolve the support ticket before you install your OpenShift Container Platform cluster.

#### 8.10.4.5. Creating a service account in GCP

OpenShift Container Platform requires a Google Cloud Platform (GCP) service account that provides authentication and authorization to access data in the Google APIs. If you do not have an existing IAM service account that contains the required roles in your project, you must create one.

##### Prerequisites

- You created a project to host your cluster.

##### Procedure

1. Create a service account in the project that you use to host your OpenShift Container Platform cluster. See [Creating a service account](#) in the GCP documentation.
2. Grant the service account the appropriate permissions. You can either grant the individual permissions that follow or assign the **Owner** role to it. See [Granting roles to a service account for specific resources](#).



##### NOTE

While making the service account an owner of the project is the easiest way to gain the required permissions, it means that service account has complete control over the project. You must determine if the risk that comes from offering that power is acceptable.

3. Create the service account key in JSON format. See [Creating service account keys](#) in the GCP documentation.  
The service account key is required to create a cluster.

#### 8.10.4.6. Required GCP roles

When you attach the **Owner** role to the service account that you create, you grant that service account all permissions, including those that are required to install OpenShift Container Platform. If your organization's security policies require a more restrictive set of permissions, you can create a service account with the following permissions. If you deploy your cluster into an existing virtual private cloud (VPC), the service account does not require certain networking permissions, which are noted in the following lists:

##### Required roles for the installation program

- Compute Admin

- Security Admin
- Service Account Admin
- Service Account Key Admin
- Service Account User
- Storage Admin

#### Required roles for creating network resources during installation

- DNS Administrator

#### Required roles for user-provisioned GCP infrastructure

- Deployment Manager Editor

The roles are applied to the service accounts that the control plane and compute machines use:

**Table 8.40. GCP service account permissions**

Account	Roles
Control Plane	<b>roles/compute.instanceAdmin</b>
	<b>roles/compute.networkAdmin</b>
	<b>roles/compute.securityAdmin</b>
	<b>roles/storage.admin</b>
	<b>roles/iam.serviceAccountUser</b>
Compute	<b>roles/compute.viewer</b>
	<b>roles/storage.admin</b>

#### 8.10.4.7. Required GCP permissions for user-provisioned infrastructure

When you attach the **Owner** role to the service account that you create, you grant that service account all permissions, including those that are required to install OpenShift Container Platform.

If your organization's security policies require a more restrictive set of permissions, you can create [custom roles](#) with the necessary permissions. The following permissions are required for the user-provisioned infrastructure for creating and deleting the OpenShift Container Platform cluster.

##### Example 8.26. Required permissions for creating network resources

- **compute.addresses.create**
- **compute.addresses.createInternal**

- `compute.addresses.delete`
- `compute.addresses.get`
- `compute.addresses.list`
- `compute.addresses.use`
- `compute.addresses.useInternal`
- `compute.firewalls.create`
- `compute.firewalls.delete`
- `compute.firewalls.get`
- `compute.firewalls.list`
- `compute.forwardingRules.create`
- `compute.forwardingRules.get`
- `compute.forwardingRules.list`
- `compute.forwardingRules.setLabels`
- `compute.networks.create`
- `compute.networks.get`
- `compute.networks.list`
- `compute.networks.updatePolicy`
- `compute.routers.create`
- `compute.routers.get`
- `compute.routers.list`
- `compute.routers.update`
- `compute.routes.list`
- `compute.subnetworks.create`
- `compute.subnetworks.get`
- `compute.subnetworks.list`
- `compute.subnetworks.use`
- `compute.subnetworks.useExternalIp`

Example 8.27. Required permissions for creating load balancer resources

- `compute.regionBackendServices.create`



- `compute.regionBackendServices.get`
- `compute.regionBackendServices.list`
- `compute.regionBackendServices.update`
- `compute.regionBackendServices.use`
- `compute.targetPools.addInstance`
- `compute.targetPools.create`
- `compute.targetPools.get`
- `compute.targetPools.list`
- `compute.targetPools.removeInstance`
- `compute.targetPools.use`

Example 8.28. Required permissions for creating DNS resources

- `dns.changes.create`
- `dns.changes.get`
- `dns.managedZones.create`
- `dns.managedZones.get`
- `dns.managedZones.list`
- `dns.networks.bindPrivateDNSZone`
- `dns.resourceRecordSets.create`
- `dns.resourceRecordSets.list`
- `dns.resourceRecordSets.update`

Example 8.29. Required permissions for creating Service Account resources

- `iam.serviceAccountKeys.create`
- `iam.serviceAccountKeys.delete`
- `iam.serviceAccountKeys.get`
- `iam.serviceAccountKeys.list`
- `iam.serviceAccounts.actAs`
- `iam.serviceAccounts.create`
- `iam.serviceAccounts.delete`

- `iam.serviceAccounts.get`
- `iam.serviceAccounts.list`
- `resourcemanager.projects.get`
- `resourcemanager.projects.getIamPolicy`
- `resourcemanager.projects.setIamPolicy`

Example 8.30. Required permissions for creating compute resources

- `compute.disks.create`
- `compute.disks.get`
- `compute.disks.list`
- `compute.instanceGroups.create`
- `compute.instanceGroups.delete`
- `compute.instanceGroups.get`
- `compute.instanceGroups.list`
- `compute.instanceGroups.update`
- `compute.instanceGroups.use`
- `compute.instances.create`
- `compute.instances.delete`
- `compute.instances.get`
- `compute.instances.list`
- `compute.instances.setLabels`
- `compute.instances.setMetadata`
- `compute.instances.setServiceAccount`
- `compute.instances.setTags`
- `compute.instances.use`
- `compute.machineTypes.get`
- `compute.machineTypes.list`

Example 8.31. Required for creating storage resources

- `storage.buckets.create`

- `storage.buckets.delete`
- `storage.buckets.get`
- `storage.buckets.list`
- `storage.objects.create`
- `storage.objects.delete`
- `storage.objects.get`
- `storage.objects.list`

Example 8.32. Required permissions for creating health check resources

- `compute.healthChecks.create`
- `compute.healthChecks.get`
- `compute.healthChecks.list`
- `compute.healthChecks.useReadOnly`
- `compute.httpHealthChecks.create`
- `compute.httpHealthChecks.get`
- `compute.httpHealthChecks.list`
- `compute.httpHealthChecks.useReadOnly`

Example 8.33. Required permissions to get GCP zone and region related information

- `compute.globalOperations.get`
- `compute.regionOperations.get`
- `compute.regions.list`
- `compute.zoneOperations.get`
- `compute.zones.get`
- `compute.zones.list`

Example 8.34. Required permissions for checking services and quotas

- `monitoring.timeSeries.list`
- `serviceusage.quotas.get`
- `serviceusage.services.list`

■

Example 8.35. Required IAM permissions for installation

- `iam.roles.get`

Example 8.36. Required Images permissions for installation

- `compute.images.create`
- `compute.images.delete`
- `compute.images.get`
- `compute.images.list`

Example 8.37. Optional permission for running gather bootstrap

- `compute.instances.getSerialPortOutput`

Example 8.38. Required permissions for deleting network resources

- `compute.addresses.delete`
- `compute.addresses.deleteInternal`
- `compute.addresses.list`
- `compute.firewalls.delete`
- `compute.firewalls.list`
- `compute.forwardingRules.delete`
- `compute.forwardingRules.list`
- `compute.networks.delete`
- `compute.networks.list`
- `compute.networks.updatePolicy`
- `compute.routers.delete`
- `compute.routers.list`
- `compute.routes.list`
- `compute.subnetworks.delete`
- `compute.subnetworks.list`

**Example 8.39. Required permissions for deleting load balancer resources**

- **compute.regionBackendServices.delete**
- **compute.regionBackendServices.list**
- **compute.targetPools.delete**
- **compute.targetPools.list**

**Example 8.40. Required permissions for deleting DNS resources**

- **dns.changes.create**
- **dns.managedZones.delete**
- **dns.managedZones.get**
- **dns.managedZones.list**
- **dns.resourceRecordSets.delete**
- **dns.resourceRecordSets.list**

**Example 8.41. Required permissions for deleting Service Account resources**

- **iam.serviceAccounts.delete**
- **iam.serviceAccounts.get**
- **iam.serviceAccounts.list**
- **resourcemanager.projects.getIamPolicy**
- **resourcemanager.projects.setIamPolicy**

**Example 8.42. Required permissions for deleting compute resources**

- **compute.disks.delete**
- **compute.disks.list**
- **compute.instanceGroups.delete**
- **compute.instanceGroups.list**
- **compute.instances.delete**
- **compute.instances.list**
- **compute.instances.stop**
- **compute.machineTypes.list**

**Example 8.43. Required for deleting storage resources**

- **storage.buckets.delete**
- **storage.buckets.getIamPolicy**
- **storage.buckets.list**
- **storage.objects.delete**
- **storage.objects.list**

**Example 8.44. Required permissions for deleting health check resources**

- **compute.healthChecks.delete**
- **compute.healthChecks.list**
- **compute.httpHealthChecks.delete**
- **compute.httpHealthChecks.list**

**Example 8.45. Required Images permissions for deletion**

- **compute.images.delete**
- **compute.images.list**

**Example 8.46. Required permissions to get Region related information**

- **compute.regions.get**

**Example 8.47. Required Deployment Manager permissions**

- **deploymentmanager.deployments.create**
- **deploymentmanager.deployments.delete**
- **deploymentmanager.deployments.get**
- **deploymentmanager.deployments.list**
- **deploymentmanager.manifests.get**
- **deploymentmanager.operations.get**
- **deploymentmanager.resources.list**

#### 8.10.4.8. Supported GCP regions

You can deploy an OpenShift Container Platform cluster to the following Google Cloud Platform (GCP) regions:

- **asia-east1** (Changhua County, Taiwan)
- **asia-east2** (Hong Kong)
- **asia-northeast1** (Tokyo, Japan)
- **asia-northeast2** (Osaka, Japan)
- **asia-northeast3** (Seoul, South Korea)
- **asia-south1** (Mumbai, India)
- **asia-south2** (Delhi, India)
- **asia-southeast1** (Jurong West, Singapore)
- **asia-southeast2** (Jakarta, Indonesia)
- **australia-southeast1** (Sydney, Australia)
- **australia-southeast2** (Melbourne, Australia)
- **europa-central2** (Warsaw, Poland)
- **europa-north1** (Hamina, Finland)
- **europa-southwest1** (Madrid, Spain)
- **europa-west1** (St. Ghislain, Belgium)
- **europa-west2** (London, England, UK)
- **europa-west3** (Frankfurt, Germany)
- **europa-west4** (Eemshaven, Netherlands)
- **europa-west6** (Zürich, Switzerland)
- **europa-west8** (Milan, Italy)
- **europa-west9** (Paris, France)
- **northamerica-northeast1** (Montréal, Québec, Canada)
- **northamerica-northeast2** (Toronto, Ontario, Canada)
- **southamerica-east1** (São Paulo, Brazil)
- **southamerica-west1** (Santiago, Chile)
- **us-central1** (Council Bluffs, Iowa, USA)
- **us-east1** (Moncks Corner, South Carolina, USA)

- **us-east4** (Ashburn, Northern Virginia, USA)
- **us-east5** (Columbus, Ohio)
- **us-south1** (Dallas, Texas)
- **us-west1** (The Dalles, Oregon, USA)
- **us-west2** (Los Angeles, California, USA)
- **us-west3** (Salt Lake City, Utah, USA)
- **us-west4** (Las Vegas, Nevada, USA)

#### 8.10.4.9. Installing and configuring CLI tools for GCP

To install OpenShift Container Platform on Google Cloud Platform (GCP) using user-provisioned infrastructure, you must install and configure the CLI tools for GCP.

##### Prerequisites

- You created a project to host your cluster.
- You created a service account and granted it the required permissions.

##### Procedure

1. Install the following binaries in **\$PATH**:

- **gcloud**
- **gsutil**

See [Install the latest Cloud SDK version](#) in the GCP documentation.

2. Authenticate using the **gcloud** tool with your configured service account.  
See [Authorizing with a service account](#) in the GCP documentation.

### 8.10.5. Requirements for a cluster with user-provisioned infrastructure

For a cluster that contains user-provisioned infrastructure, you must deploy all of the required machines.

This section describes the requirements for deploying OpenShift Container Platform on user-provisioned infrastructure.

#### 8.10.5.1. Required machines for cluster installation

The smallest OpenShift Container Platform clusters require the following hosts:

**Table 8.41. Minimum required hosts**

Hosts	Description
-------	-------------



Hosts	Description
One temporary bootstrap machine	The cluster requires the bootstrap machine to deploy the OpenShift Container Platform cluster on the three control plane machines. You can remove the bootstrap machine after you install the cluster.
Three control plane machines	The control plane machines run the Kubernetes and OpenShift Container Platform services that form the control plane.
At least two compute machines, which are also known as worker machines.	The workloads requested by OpenShift Container Platform users run on the compute machines.



### IMPORTANT

To maintain high availability of your cluster, use separate physical hosts for these cluster machines.

The bootstrap and control plane machines must use Red Hat Enterprise Linux CoreOS (RHCOS) as the operating system. However, the compute machines can choose between Red Hat Enterprise Linux CoreOS (RHCOS), Red Hat Enterprise Linux (RHEL) 8.4, or RHEL 8.5.

Note that RHCOS is based on Red Hat Enterprise Linux (RHEL) 8 and inherits all of its hardware certifications and requirements. See [Red Hat Enterprise Linux technology capabilities and limits](#).

#### 8.10.5.2. Minimum resource requirements for cluster installation

Each cluster machine must meet the following minimum requirements:

**Table 8.42. Minimum resource requirements**

Machine	Operating System	vCPU [1]	Virtual RAM	Storage	IOPS [2]
Bootstrap	RHCOS	4	16 GB	100 GB	300
Control plane	RHCOS	4	16 GB	100 GB	300
Compute	RHCOS, RHEL 8.4, or RHEL 8.5 [3]	2	8 GB	100 GB	300

1. One vCPU is equivalent to one physical core when simultaneous multithreading (SMT), or hyperthreading, is not enabled. When enabled, use the following formula to calculate the corresponding ratio:  $(\text{threads per core} \times \text{cores}) \times \text{sockets} = \text{vCPUs}$ .
2. OpenShift Container Platform and Kubernetes are sensitive to disk performance, and faster storage is recommended, particularly for etcd on the control plane nodes which require a 10 ms p99 fsync duration. Note that on many cloud platforms, storage size and IOPS scale together, so

you might need to over-allocate storage volume to obtain sufficient performance.

3. As with all user-provisioned installations, if you choose to use RHEL compute machines in your cluster, you take responsibility for all operating system life cycle management and maintenance, including performing system updates, applying patches, and completing all other required tasks. Use of RHEL 7 compute machines is deprecated and has been removed in OpenShift Container Platform 4.10 and later.

If an instance type for your platform meets the minimum requirements for cluster machines, it is supported to use in OpenShift Container Platform.

### 8.10.5.3. Tested instance types for GCP

The following Google Cloud Platform instance types have been tested with OpenShift Container Platform.

#### Example 8.48. Machine series

- **C2**
- **C2D**
- **C3**
- **E2**
- **M1**
- **N1**
- **N2**
- **N2D**
- **Tau T2D**

### 8.10.5.4. Using custom machine types

Using a custom machine type to install a OpenShift Container Platform cluster is supported.

Consider the following when using a custom machine type:

- Similar to predefined instance types, custom machine types must meet the minimum resource requirements for control plane and compute machines. For more information, see "Minimum resource requirements for cluster installation".
- The name of the custom machine type must adhere to the following syntax:  
**custom-`<number_of_cpus>`-`<amount_of_memory_in_mb>`**

For example, **custom-6-20480**.

### 8.10.6. Creating the installation files for GCP

To install OpenShift Container Platform on Google Cloud Platform (GCP) using user-provisioned infrastructure, you must generate the files that the installation program needs to deploy your cluster

and modify them so that the cluster creates only the machines that it will use. You generate and customize the **install-config.yaml** file, Kubernetes manifests, and Ignition config files. You also have the option to first set up a separate **var** partition during the preparation phases of installation.

### 8.10.6.1. Optional: Creating a separate **/var** partition

It is recommended that disk partitioning for OpenShift Container Platform be left to the installer. However, there are cases where you might want to create separate partitions in a part of the filesystem that you expect to grow.

OpenShift Container Platform supports the addition of a single partition to attach storage to either the **/var** partition or a subdirectory of **/var**. For example:

- **/var/lib/containers**: Holds container-related content that can grow as more images and containers are added to a system.
- **/var/lib/etcd**: Holds data that you might want to keep separate for purposes such as performance optimization of etcd storage.
- **/var**: Holds data that you might want to keep separate for purposes such as auditing.

Storing the contents of a **/var** directory separately makes it easier to grow storage for those areas as needed and reinstall OpenShift Container Platform at a later date and keep that data intact. With this method, you will not have to pull all your containers again, nor will you have to copy massive log files when you update systems.

Because **/var** must be in place before a fresh installation of Red Hat Enterprise Linux CoreOS (RHCOS), the following procedure sets up the separate **/var** partition by creating a machine config manifest that is inserted during the **openshift-install** preparation phases of an OpenShift Container Platform installation.



#### IMPORTANT

If you follow the steps to create a separate **/var** partition in this procedure, it is not necessary to create the Kubernetes manifest and Ignition config files again as described later in this section.

#### Procedure

1. Create a directory to hold the OpenShift Container Platform installation files:

```
$ mkdir $HOME/clusterconfig
```

2. Run **openshift-install** to create a set of files in the **manifest** and **openshift** subdirectories. Answer the system questions as you are prompted:

```
$ openshift-install create manifests --dir $HOME/clusterconfig
```

#### Example output

```
? SSH Public Key ...
INFO Credentials loaded from the "myprofile" profile in file "/home/myuser/.aws/credentials"
INFO Consuming Install Config from target directory
```

INFO Manifests created in: `$HOME/clusterconfig/manifests` and `$HOME/clusterconfig/openshift`

- Optional: Confirm that the installation program created manifests in the **clusterconfig/openshift** directory:

```
$ ls $HOME/clusterconfig/openshift/
```

### Example output

```
99_kubeadmin-password-secret.yaml
99_openshift-cluster-api_master-machines-0.yaml
99_openshift-cluster-api_master-machines-1.yaml
99_openshift-cluster-api_master-machines-2.yaml
...
```

- Create a Butane config that configures the additional partition. For example, name the file **`$HOME/clusterconfig/98-var-partition.bu`**, change the disk device name to the name of the storage device on the **worker** systems, and set the storage size as appropriate. This example places the **`/var`** directory on a separate partition:

```
variant: openshift
version: 4.10.0
metadata:
  labels:
    machineconfiguration.openshift.io/role: worker
  name: 98-var-partition
storage:
  disks:
    - device: /dev/<device_name> 1
      partitions:
        - label: var
          start_mib: <partition_start_offset> 2
          size_mib: <partition_size> 3
      filesystems:
        - device: /dev/disk/by-partlabel/var
          path: /var
          format: xfs
          mount_options: [defaults, prjquota] 4
          with_mount_unit: true
```

- The storage device name of the disk that you want to partition.
- When adding a data partition to the boot disk, a minimum value of 25000 MiB (Mebibytes) is recommended. The root file system is automatically resized to fill all available space up to the specified offset. If no value is specified, or if the specified value is smaller than the recommended minimum, the resulting root file system will be too small, and future reinstalls of RHCOS might overwrite the beginning of the data partition.
- The size of the data partition in mebibytes.
- The **prjquota** mount option must be enabled for filesystems used for container storage.



## NOTE

When creating a separate **/var** partition, you cannot use different instance types for worker nodes, if the different instance types do not have the same device name.

5. Create a manifest from the Butane config and save it to the **clusterconfig/openshift** directory. For example, run the following command:

```
$ butane $HOME/clusterconfig/98-var-partition.bu -o $HOME/clusterconfig/openshift/98-var-partition.yaml
```

6. Run **openshift-install** again to create Ignition configs from a set of files in the **manifest** and **openshift** subdirectories:

```
$ openshift-install create ignition-configs --dir $HOME/clusterconfig
$ ls $HOME/clusterconfig/
auth bootstrap.ign master.ign metadata.json worker.ign
```

Now you can use the Ignition config files as input to the installation procedures to install Red Hat Enterprise Linux CoreOS (RHCOS) systems.

### 8.10.6.2. Creating the installation configuration file

You can customize the OpenShift Container Platform cluster you install on Google Cloud Platform (GCP).

#### Prerequisites

- Obtain the OpenShift Container Platform installation program and the pull secret for your cluster.
- Obtain service principal permissions at the subscription level.

#### Procedure

1. Create the **install-config.yaml** file.
  - a. Change to the directory that contains the installation program and run the following command:

```
$ ./openshift-install create install-config --dir <installation_directory> 1
```

- 1** For **<installation\_directory>**, specify the directory name to store the files that the installation program creates.

**IMPORTANT**

Specify an empty directory. Some installation assets, like bootstrap X.509 certificates have short expiration intervals, so you must not reuse an installation directory. If you want to reuse individual files from another cluster installation, you can copy them into your directory. However, the file names for the installation assets might change between releases. Use caution when copying installation files from an earlier OpenShift Container Platform version.

- b. At the prompts, provide the configuration details for your cloud:
  - i. Optional: Select an SSH key to use to access your cluster machines.

**NOTE**

For production OpenShift Container Platform clusters on which you want to perform installation debugging or disaster recovery, specify an SSH key that your **ssh-agent** process uses.

- ii. Select **gcp** as the platform to target.
  - iii. If you have not configured the service account key for your GCP account on your computer, you must obtain it from GCP and paste the contents of the file or enter the absolute path to the file.
  - iv. Select the project ID to provision the cluster in. The default value is specified by the service account that you configured.
  - v. Select the region to deploy the cluster to.
  - vi. Select the base domain to deploy the cluster to. The base domain corresponds to the public DNS zone that you created for your cluster.
  - vii. Enter a descriptive name for your cluster.
  - viii. Paste the [pull secret from the Red Hat OpenShift Cluster Manager](#) .
- c. Optional: If you do not want the cluster to provision compute machines, empty the compute pool by editing the resulting **install-config.yaml** file to set **replicas** to **0** for the **compute** pool:
 

```
compute:
- hyperthreading: Enabled
  name: worker
  platform: {}
  replicas: 0 1
```

**1** Set to **0**.

2. Modify the **install-config.yaml** file. You can find more information about the available parameters in the "Installation configuration parameters" section.
3. Back up the **install-config.yaml** file so that you can use it to install multiple clusters.

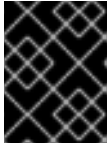

## IMPORTANT

The **install-config.yaml** file is consumed during the installation process. If you want to reuse the file, you must back it up now.

### 8.10.6.3. Configuring the cluster-wide proxy during installation

Production environments can deny direct access to the internet and instead have an HTTP or HTTPS proxy available. You can configure a new OpenShift Container Platform cluster to use a proxy by configuring the proxy settings in the **install-config.yaml** file.

#### Prerequisites

- You have an existing **install-config.yaml** file.
- You reviewed the sites that your cluster requires access to and determined whether any of them need to bypass the proxy. By default, all cluster egress traffic is proxied, including calls to hosting cloud provider APIs. You added sites to the **Proxy** object's **spec.noProxy** field to bypass the proxy if necessary.



## NOTE

The **Proxy** object **status.noProxy** field is populated with the values of the **networking.machineNetwork[].cidr**, **networking.clusterNetwork[].cidr**, and **networking.serviceNetwork[]** fields from your installation configuration.

For installations on Amazon Web Services (AWS), Google Cloud Platform (GCP), Microsoft Azure, and Red Hat OpenStack Platform (RHOSP), the **Proxy** object **status.noProxy** field is also populated with the instance metadata endpoint (**169.254.169.254**).

#### Procedure

1. Edit your **install-config.yaml** file and add the proxy settings. For example:

```
apiVersion: v1
baseDomain: my.domain.com
proxy:
  httpProxy: http://<username>:<pswd>@<ip>:<port> 1
  httpsProxy: https://<username>:<pswd>@<ip>:<port> 2
  noProxy: example.com 3
  additionalTrustBundle: | 4
    -----BEGIN CERTIFICATE-----
    <MY_TRUSTED_CA_CERT>
    -----END CERTIFICATE-----
  ...
```

- 1 A proxy URL to use for creating HTTP connections outside the cluster. The URL scheme must be **http**.
- 2 A proxy URL to use for creating HTTPS connections outside the cluster.
- 3 A comma-separated list of destination domain names, IP addresses, or other network CIDRs to exclude from proxying. Preface a domain with **.** to match subdomains only. For example, **.y.com** matches **x.y.com**, but not **y.com**. Use **\*** to bypass the proxy for all

destinations.

- 4 If provided, the installation program generates a config map that is named **user-ca-bundle** in the **openshift-config** namespace that contains one or more additional CA certificates that are required for proxying HTTPS connections. The Cluster Network Operator then creates a **trusted-ca-bundle** config map that merges these contents with the Red Hat Enterprise Linux CoreOS (RHCOS) trust bundle, and this config map is referenced in the **trustedCA** field of the **Proxy** object. The **additionalTrustBundle** field is required unless the proxy's identity certificate is signed by an authority from the RHCOS trust bundle.



#### NOTE

The installation program does not support the proxy **readinessEndpoints** field.



#### NOTE

If the installer times out, restart and then complete the deployment by using the **wait-for** command of the installer. For example:

```
$ ./openshift-install wait-for install-complete --log-level debug
```

2. Save the file and reference it when installing OpenShift Container Platform.

The installation program creates a cluster-wide proxy that is named **cluster** that uses the proxy settings in the provided **install-config.yaml** file. If no proxy settings are provided, a **cluster Proxy** object is still created, but it will have a nil **spec**.



#### NOTE

Only the **Proxy** object named **cluster** is supported, and no additional proxies can be created.

#### 8.10.6.4. Creating the Kubernetes manifest and Ignition config files

Because you must modify some cluster definition files and manually start the cluster machines, you must generate the Kubernetes manifest and Ignition config files that the cluster needs to configure the machines.

The installation configuration file transforms into the Kubernetes manifests. The manifests wrap into the Ignition configuration files, which are later used to configure the cluster machines.



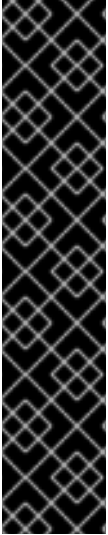

## IMPORTANT

- The Ignition config files that the OpenShift Container Platform installation program generates contain certificates that expire after 24 hours, which are then renewed at that time. If the cluster is shut down before renewing the certificates and the cluster is later restarted after the 24 hours have elapsed, the cluster automatically recovers the expired certificates. The exception is that you must manually approve the pending **node-bootstrapper** certificate signing requests (CSRs) to recover kubelet certificates. See the documentation for *Recovering from expired control plane certificates* for more information.
- It is recommended that you use Ignition config files within 12 hours after they are generated because the 24-hour certificate rotates from 16 to 22 hours after the cluster is installed. By using the Ignition config files within 12 hours, you can avoid installation failure if the certificate update runs during installation.

## Prerequisites

- You obtained the OpenShift Container Platform installation program.
- You created the **install-config.yaml** installation configuration file.

## Procedure

1. Change to the directory that contains the OpenShift Container Platform installation program and generate the Kubernetes manifests for the cluster:

```
$ ./openshift-install create manifests --dir <installation_directory> 1
```

- 1 For **<installation\_directory>**, specify the installation directory that contains the **install-config.yaml** file you created.

2. Remove the Kubernetes manifest files that define the control plane machines:

```
$ rm -f <installation_directory>/openshift/99_openshift-cluster-api_master-machines-*.yaml
```

By removing these files, you prevent the cluster from automatically generating control plane machines.

3. Optional: If you do not want the cluster to provision compute machines, remove the Kubernetes manifest files that define the worker machines:

```
$ rm -f <installation_directory>/openshift/99_openshift-cluster-api_worker-machineset-*.yaml
```

Because you create and manage the worker machines yourself, you do not need to initialize these machines.

4. Check that the **mastersSchedulable** parameter in the **<installation\_directory>/manifests/cluster-scheduler-02-config.yaml** Kubernetes manifest file is set to **false**. This setting prevents pods from being scheduled on the control plane machines:
  - a. Open the **<installation\_directory>/manifests/cluster-scheduler-02-config.yaml** file.
  - b. Locate the **mastersSchedulable** parameter and ensure that it is set to **false**.

- c. Save and exit the file.
5. Optional: If you do not want [the Ingress Operator](#) to create DNS records on your behalf, remove the **privateZone** and **publicZone** sections from the `<installation_directory>/manifests/cluster-dns-02-config.yml` DNS configuration file:

```
apiVersion: config.openshift.io/v1
kind: DNS
metadata:
  creationTimestamp: null
  name: cluster
spec:
  baseDomain: example.openshift.com
  privateZone: 1
    id: mycluster-100419-private-zone
  publicZone: 2
    id: example.openshift.com
status: {}
```

- 1 2 Remove this section completely.

If you do so, you must add ingress DNS records manually in a later step.

6. To create the Ignition configuration files, run the following command from the directory that contains the installation program:

```
$ ./openshift-install create ignition-configs --dir <installation_directory> 1
```

- 1 For `<installation_directory>`, specify the same installation directory.

Ignition config files are created for the bootstrap, control plane, and compute nodes in the installation directory. The **kubeadmin-password** and **kubeconfig** files are created in the `./<installation_directory>/auth` directory:

```
.
├── auth
│   ├── kubeadmin-password
│   └── kubeconfig
├── bootstrap.ign
├── master.ign
├── metadata.json
└── worker.ign
```

## Additional resources

- [Optional: Adding the ingress DNS records](#)

## 8.10.7. Exporting common variables

### 8.10.7.1. Extracting the infrastructure name

The Ignition config files contain a unique cluster identifier that you can use to uniquely identify your

cluster in Google Cloud Platform (GCP). The infrastructure name is also used to locate the appropriate GCP resources during an OpenShift Container Platform installation. The provided Deployment Manager templates contain references to this infrastructure name, so you must extract it.

### Prerequisites

- You obtained the OpenShift Container Platform installation program and the pull secret for your cluster.
- You generated the Ignition config files for your cluster.
- You installed the **jq** package.

### Procedure

- To extract and view the infrastructure name from the Ignition config file metadata, run the following command:

```
$ jq -r .infraID <installation_directory>/metadata.json 1
```

- 1 For **<installation\_directory>**, specify the path to the directory that you stored the installation files in.

### Example output

```
openshift-vw9j6 1
```

- 1 The output of this command is your cluster name and a random string.

#### 8.10.7.2. Exporting common variables for Deployment Manager templates

You must export a common set of variables that are used with the provided Deployment Manager templates used to assist in completing a user-provided infrastructure install on Google Cloud Platform (GCP).



#### NOTE

Specific Deployment Manager templates can also require additional exported variables, which are detailed in their related procedures.

### Prerequisites

- Obtain the OpenShift Container Platform installation program and the pull secret for your cluster.
- Generate the Ignition config files for your cluster.
- Install the **jq** package.

### Procedure

1. Export the following common variables to be used by the provided Deployment Manager templates:

```
$ export BASE_DOMAIN='<base_domain>'
$ export BASE_DOMAIN_ZONE_NAME='<base_domain_zone_name>'
$ export NETWORK_CIDR='10.0.0.0/16'
$ export MASTER_SUBNET_CIDR='10.0.0.0/17'
$ export WORKER_SUBNET_CIDR='10.0.128.0/17'

$ export KUBECONFIG=<installation_directory>/auth/kubeconfig 1
$ export CLUSTER_NAME=`jq -r .clusterName <installation_directory>/metadata.json`
$ export INFRA_ID=`jq -r .infraID <installation_directory>/metadata.json`
$ export PROJECT_NAME=`jq -r .gcp.projectID <installation_directory>/metadata.json`
$ export REGION=`jq -r .gcp.region <installation_directory>/metadata.json`
```

- 1** For **<installation\_directory>**, specify the path to the directory that you stored the installation files in.

### 8.10.8. Creating a VPC in GCP

You must create a VPC in Google Cloud Platform (GCP) for your OpenShift Container Platform cluster to use. You can customize the VPC to meet your requirements. One way to create the VPC is to modify the provided Deployment Manager template.



#### NOTE

If you do not use the provided Deployment Manager template to create your GCP infrastructure, you must review the provided information and manually create the infrastructure. If your cluster does not initialize correctly, you might have to contact Red Hat support with your installation logs.

#### Prerequisites

- Configure a GCP account.
- Generate the Ignition config files for your cluster.

#### Procedure

1. Copy the template from the **Deployment Manager template for the VPC** section of this topic and save it as **01\_vpc.py** on your computer. This template describes the VPC that your cluster requires.
2. Create a **01\_vpc.yaml** resource definition file:

```
$ cat <<EOF >01_vpc.yaml
imports:
- path: 01_vpc.py

resources:
- name: cluster-vpc
  type: 01_vpc.py
  properties:
    infra_id: '${INFRA_ID}' 1
```

```

region: '${REGION}' ❷
master_subnet_cidr: '${MASTER_SUBNET_CIDR}' ❸
worker_subnet_cidr: '${WORKER_SUBNET_CIDR}' ❹
EOF

```

- ❶ **infra\_id** is the **INFRA\_ID** infrastructure name from the extraction step.
- ❷ **region** is the region to deploy the cluster into, for example **us-central1**.
- ❸ **master\_subnet\_cidr** is the CIDR for the master subnet, for example **10.0.0.0/17**.
- ❹ **worker\_subnet\_cidr** is the CIDR for the worker subnet, for example **10.0.128.0/17**.

3. Create the deployment by using the **gcloud** CLI:

```
$ gcloud deployment-manager deployments create ${INFRA_ID}-vpc --config 01_vpc.yaml
```

### 8.10.8.1. Deployment Manager template for the VPC

You can use the following Deployment Manager template to deploy the VPC that you need for your OpenShift Container Platform cluster:

#### Example 8.49. 01\_vpc.py Deployment Manager template

```

def GenerateConfig(context):

    resources = [{
        'name': context.properties['infra_id'] + '-network',
        'type': 'compute.v1.network',
        'properties': {
            'region': context.properties['region'],
            'autoCreateSubnetworks': False
        }
    }, {
        'name': context.properties['infra_id'] + '-master-subnet',
        'type': 'compute.v1.subnetwork',
        'properties': {
            'region': context.properties['region'],
            'network': '${ref.' + context.properties['infra_id'] + '-network.selfLink}',
            'ipCidrRange': context.properties['master_subnet_cidr']
        }
    }, {
        'name': context.properties['infra_id'] + '-worker-subnet',
        'type': 'compute.v1.subnetwork',
        'properties': {
            'region': context.properties['region'],
            'network': '${ref.' + context.properties['infra_id'] + '-network.selfLink}',
            'ipCidrRange': context.properties['worker_subnet_cidr']
        }
    }, {
        'name': context.properties['infra_id'] + '-router',
        'type': 'compute.v1.router',
        'properties': {
            'region': context.properties['region'],

```

```

'network': '$(ref.' + context.properties['infra_id'] + '-network.selfLink)',
'nats': [{
  'name': context.properties['infra_id'] + '-nat-master',
  'natIplAllocateOption': 'AUTO_ONLY',
  'minPortsPerVm': 7168,
  'sourceSubnetworkIplRangesToNat': 'LIST_OF_SUBNETWORKS',
  'subnetworks': [{
    'name': '$(ref.' + context.properties['infra_id'] + '-master-subnet.selfLink)',
    'sourceIplRangesToNat': ['ALL_IP_RANGES']
  }]
}, {
  'name': context.properties['infra_id'] + '-nat-worker',
  'natIplAllocateOption': 'AUTO_ONLY',
  'minPortsPerVm': 512,
  'sourceSubnetworkIplRangesToNat': 'LIST_OF_SUBNETWORKS',
  'subnetworks': [{
    'name': '$(ref.' + context.properties['infra_id'] + '-worker-subnet.selfLink)',
    'sourceIplRangesToNat': ['ALL_IP_RANGES']
  }]
}]
}
]]

return {'resources': resources}

```

### 8.10.9. Networking requirements for user-provisioned infrastructure

All the Red Hat Enterprise Linux CoreOS (RHCOS) machines require networking to be configured in **initramfs** during boot to fetch their Ignition config files.

#### 8.10.9.1. Setting the cluster node hostnames through DHCP

On Red Hat Enterprise Linux CoreOS (RHCOS) machines, the hostname is set through NetworkManager. By default, the machines obtain their hostname through DHCP. If the hostname is not provided by DHCP, set statically through kernel arguments, or another method, it is obtained through a reverse DNS lookup. Reverse DNS lookup occurs after the network has been initialized on a node and can take time to resolve. Other system services can start prior to this and detect the hostname as **localhost** or similar. You can avoid this by using DHCP to provide the hostname for each cluster node.

Additionally, setting the hostnames through DHCP can bypass any manual DNS record name configuration errors in environments that have a DNS split-horizon implementation.

#### 8.10.9.2. Network connectivity requirements

You must configure the network connectivity between machines to allow OpenShift Container Platform cluster components to communicate. Each machine must be able to resolve the hostnames of all other machines in the cluster.

This section provides details about the ports that are required.



## IMPORTANT

In connected OpenShift Container Platform environments, all nodes are required to have internet access to pull images for platform containers and provide telemetry data to Red Hat.

**Table 8.43. Ports used for all-machine to all-machine communications**

Protocol	Port	Description
ICMP	N/A	Network reachability tests
TCP	<b>1936</b>	Metrics
	<b>9000-9999</b>	Host level services, including the node exporter on ports <b>9100-9101</b> and the Cluster Version Operator on port <b>9099</b> .
	<b>10250-10259</b>	The default ports that Kubernetes reserves
	<b>10256</b>	openshift-sdn
UDP	<b>4789</b>	VXLAN
	<b>6081</b>	Geneve
	<b>9000-9999</b>	Host level services, including the node exporter on ports <b>9100-9101</b> .
	<b>500</b>	IPsec IKE packets
	<b>4500</b>	IPsec NAT-T packets
TCP/UDP	<b>30000-32767</b>	Kubernetes node port
ESP	N/A	IPsec Encapsulating Security Payload (ESP)

**Table 8.44. Ports used for all-machine to control plane communications**

Protocol	Port	Description
TCP	<b>6443</b>	Kubernetes API

**Table 8.45. Ports used for control plane machine to control plane machine communications**

Protocol	Port	Description
TCP	<b>2379-2380</b>	etcd server and peer ports

### 8.10.10. Creating load balancers in GCP

You must configure load balancers in Google Cloud Platform (GCP) for your OpenShift Container Platform cluster to use. One way to create these components is to modify the provided Deployment Manager template.



#### NOTE

If you do not use the provided Deployment Manager template to create your GCP infrastructure, you must review the provided information and manually create the infrastructure. If your cluster does not initialize correctly, you might have to contact Red Hat support with your installation logs.

#### Prerequisites

- Configure a GCP account.
- Generate the Ignition config files for your cluster.
- Create and configure a VPC and associated subnets in GCP.

#### Procedure

1. Copy the template from the **Deployment Manager template for the internal load balancer** section of this topic and save it as **02\_lb\_int.py** on your computer. This template describes the internal load balancing objects that your cluster requires.
2. For an external cluster, also copy the template from the **Deployment Manager template for the external load balancer** section of this topic and save it as **02\_lb\_ext.py** on your computer. This template describes the external load balancing objects that your cluster requires.
3. Export the variables that the deployment template uses:

- a. Export the cluster network location:

```
$ export CLUSTER_NETWORK=(`gcloud compute networks describe ${INFRA_ID}-network --format json | jq -r .selfLink`)
```

- b. Export the control plane subnet location:

```
$ export CONTROL_SUBNET=(`gcloud compute networks subnets describe ${INFRA_ID}-master-subnet --region=${REGION} --format json | jq -r .selfLink`)
```

- c. Export the three zones that the cluster uses:

```
$ export ZONE_0=(`gcloud compute regions describe ${REGION} --format=json | jq -r .zones[0] | cut -d "/" -f9`)
```

```
$ export ZONE_1=(`gcloud compute regions describe ${REGION} --format=json | jq -r .zones[1] | cut -d "/" -f9`)
```

```
$ export ZONE_2=(`gcloud compute regions describe ${REGION} --format=json | jq -r .zones[2] | cut -d "/" -f9`)
```



4. Create a **02\_infra.yaml** resource definition file:

```
$ cat <<EOF >02_infra.yaml
imports:
- path: 02_lb_ext.py
- path: 02_lb_int.py ❶
resources:
- name: cluster-lb-ext ❷
  type: 02_lb_ext.py
  properties:
    infra_id: '${INFRA_ID}' ❸
    region: '${REGION}' ❹
- name: cluster-lb-int
  type: 02_lb_int.py
  properties:
    cluster_network: '${CLUSTER_NETWORK}'
    control_subnet: '${CONTROL_SUBNET}' ❺
    infra_id: '${INFRA_ID}'
    region: '${REGION}'
    zones: ❻
    - '${ZONE_0}'
    - '${ZONE_1}'
    - '${ZONE_2}'
EOF
```

- ❶ ❷ Required only when deploying an external cluster.
- ❸ **infra\_id** is the **INFRA\_ID** infrastructure name from the extraction step.
- ❹ **region** is the region to deploy the cluster into, for example **us-central1**.
- ❺ **control\_subnet** is the URI to the control subnet.
- ❻ **zones** are the zones to deploy the control plane instances into, like **us-east1-b**, **us-east1-c**, and **us-east1-d**.

5. Create the deployment by using the **gcloud** CLI:

```
$ gcloud deployment-manager deployments create ${INFRA_ID}-infra --config 02_infra.yaml
```

6. Export the cluster IP address:

```
$ export CLUSTER_IP=$(gcloud compute addresses describe ${INFRA_ID}-cluster-ip --
region=${REGION} --format json | jq -r .address)
```

7. For an external cluster, also export the cluster public IP address:

```
$ export CLUSTER_PUBLIC_IP=$(gcloud compute addresses describe ${INFRA_ID}-cluster-
public-ip --region=${REGION} --format json | jq -r .address)
```

### 8.10.10.1. Deployment Manager template for the external load balancer

You can use the following Deployment Manager template to deploy the external load balancer that you need for your OpenShift Container Platform cluster:

### Example 8.50. 02\_lb\_ext.py Deployment Manager template

```
def GenerateConfig(context):

    resources = [{
        'name': context.properties['infra_id'] + '-cluster-public-ip',
        'type': 'compute.v1.address',
        'properties': {
            'region': context.properties['region']
        }
    }, {
        # Refer to docs/dev/kube-apiserver-health-check.md on how to correctly setup health check
        # probe for kube-apiserver
        'name': context.properties['infra_id'] + '-api-http-health-check',
        'type': 'compute.v1.httpHealthCheck',
        'properties': {
            'port': 6080,
            'requestPath': '/readyz'
        }
    }, {
        'name': context.properties['infra_id'] + '-api-target-pool',
        'type': 'compute.v1.targetPool',
        'properties': {
            'region': context.properties['region'],
            'healthChecks': ['$$(ref.' + context.properties['infra_id'] + '-api-http-health-check.selfLink)'],
            'instances': []
        }
    }, {
        'name': context.properties['infra_id'] + '-api-forwarding-rule',
        'type': 'compute.v1.forwardingRule',
        'properties': {
            'region': context.properties['region'],
            'IPAddress': '$$(ref.' + context.properties['infra_id'] + '-cluster-public-ip.selfLink)',
            'target': '$$(ref.' + context.properties['infra_id'] + '-api-target-pool.selfLink)',
            'portRange': '6443'
        }
    }
    ]

    return {'resources': resources}
```

### 8.10.10.2. Deployment Manager template for the internal load balancer

You can use the following Deployment Manager template to deploy the internal load balancer that you need for your OpenShift Container Platform cluster:

### Example 8.51. 02\_lb\_int.py Deployment Manager template

```
def GenerateConfig(context):

    backends = []
    for zone in context.properties['zones']:
```

```

backends.append({
  'group': '${ref.' + context.properties['infra_id'] + '-master-' + zone + '-ig' + '.selfLink}'
})

resources = [{
  'name': context.properties['infra_id'] + '-cluster-ip',
  'type': 'compute.v1.address',
  'properties': {
    'addressType': 'INTERNAL',
    'region': context.properties['region'],
    'subnetwork': context.properties['control_subnet']
  }
}, {
  # Refer to docs/dev/kube-apiserver-health-check.md on how to correctly setup health check
  # probe for kube-apiserver
  'name': context.properties['infra_id'] + '-api-internal-health-check',
  'type': 'compute.v1.healthCheck',
  'properties': {
    'httpsHealthCheck': {
      'port': 6443,
      'requestPath': '/readyz'
    },
    'type': "HTTPS"
  }
}, {
  'name': context.properties['infra_id'] + '-api-internal-backend-service',
  'type': 'compute.v1.regionBackendService',
  'properties': {
    'backends': backends,
    'healthChecks': ['${ref.' + context.properties['infra_id'] + '-api-internal-health-
check.selfLink}'],
    'loadBalancingScheme': 'INTERNAL',
    'region': context.properties['region'],
    'protocol': 'TCP',
    'timeoutSec': 120
  }
}, {
  'name': context.properties['infra_id'] + '-api-internal-forwarding-rule',
  'type': 'compute.v1.forwardingRule',
  'properties': {
    'backendService': '${ref.' + context.properties['infra_id'] + '-api-internal-backend-
service.selfLink}',
    'IPAddress': '${ref.' + context.properties['infra_id'] + '-cluster-ip.selfLink}',
    'loadBalancingScheme': 'INTERNAL',
    'ports': ['6443','22623'],
    'region': context.properties['region'],
    'subnetwork': context.properties['control_subnet']
  }
}
]]

for zone in context.properties['zones']:
  resources.append({
    'name': context.properties['infra_id'] + '-master-' + zone + '-ig',
    'type': 'compute.v1.instanceGroup',
    'properties': {
      'namedPorts': [

```

```

        {
            'name': 'ignition',
            'port': 22623
        }, {
            'name': 'https',
            'port': 6443
        }
    ],
    'network': context.properties['cluster_network'],
    'zone': zone
}
}))

return {'resources': resources}

```

You will need this template in addition to the **02\_lb\_ext.py** template when you create an external cluster.

### 8.10.11. Creating a private DNS zone in GCP

You must configure a private DNS zone in Google Cloud Platform (GCP) for your OpenShift Container Platform cluster to use. One way to create this component is to modify the provided Deployment Manager template.



#### NOTE

If you do not use the provided Deployment Manager template to create your GCP infrastructure, you must review the provided information and manually create the infrastructure. If your cluster does not initialize correctly, you might have to contact Red Hat support with your installation logs.

#### Prerequisites

- Configure a GCP account.
- Generate the Ignition config files for your cluster.
- Create and configure a VPC and associated subnets in GCP.

#### Procedure

1. Copy the template from the **Deployment Manager template for the private DNS** section of this topic and save it as **02\_dns.py** on your computer. This template describes the private DNS objects that your cluster requires.
2. Create a **02\_dns.yaml** resource definition file:

```

$ cat <<EOF >02_dns.yaml
imports:
- path: 02_dns.py

resources:
- name: cluster-dns
  type: 02_dns.py

```

```

properties:
  infra_id: '${INFRA_ID}' 1
  cluster_domain: '${CLUSTER_NAME}.${BASE_DOMAIN}' 2
  cluster_network: '${CLUSTER_NETWORK}' 3
EOF

```

- 1** **infra\_id** is the **INFRA\_ID** infrastructure name from the extraction step.
- 2** **cluster\_domain** is the domain for the cluster, for example **openshift.example.com**.
- 3** **cluster\_network** is the **selfLink** URL to the cluster network.

3. Create the deployment by using the **gcloud** CLI:

```
$ gcloud deployment-manager deployments create ${INFRA_ID}-dns --config 02_dns.yaml
```

4. The templates do not create DNS entries due to limitations of Deployment Manager, so you must create them manually:

- a. Add the internal DNS entries:

```

$ if [ -f transaction.yaml ]; then rm transaction.yaml; fi
$ gcloud dns record-sets transaction start --zone ${INFRA_ID}-private-zone
$ gcloud dns record-sets transaction add ${CLUSTER_IP} --name
api.${CLUSTER_NAME}.${BASE_DOMAIN}. --ttl 60 --type A --zone ${INFRA_ID}-
private-zone
$ gcloud dns record-sets transaction add ${CLUSTER_IP} --name api-
int.${CLUSTER_NAME}.${BASE_DOMAIN}. --ttl 60 --type A --zone ${INFRA_ID}-
private-zone
$ gcloud dns record-sets transaction execute --zone ${INFRA_ID}-private-zone

```

- b. For an external cluster, also add the external DNS entries:

```

$ if [ -f transaction.yaml ]; then rm transaction.yaml; fi
$ gcloud dns record-sets transaction start --zone ${BASE_DOMAIN_ZONE_NAME}
$ gcloud dns record-sets transaction add ${CLUSTER_PUBLIC_IP} --name
api.${CLUSTER_NAME}.${BASE_DOMAIN}. --ttl 60 --type A --zone
${BASE_DOMAIN_ZONE_NAME}
$ gcloud dns record-sets transaction execute --zone ${BASE_DOMAIN_ZONE_NAME}

```

### 8.10.11.1. Deployment Manager template for the private DNS

You can use the following Deployment Manager template to deploy the private DNS that you need for your OpenShift Container Platform cluster:

#### Example 8.52. **02\_dns.py** Deployment Manager template

```

def GenerateConfig(context):

    resources = [{
        'name': context.properties['infra_id'] + '-private-zone',
        'type': 'dns.v1.managedZone',
        'properties': {

```

```

'description': "",
'dnsName': context.properties['cluster_domain'] + '.',
'visibility': 'private',
'privateVisibilityConfig': {
  'networks': [{
    'networkUrl': context.properties['cluster_network']
  }]
}
}
}]

return {'resources': resources}

```

### 8.10.12. Creating firewall rules in GCP

You must create firewall rules in Google Cloud Platform (GCP) for your OpenShift Container Platform cluster to use. One way to create these components is to modify the provided Deployment Manager template.

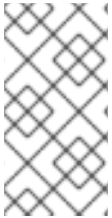

#### NOTE

If you do not use the provided Deployment Manager template to create your GCP infrastructure, you must review the provided information and manually create the infrastructure. If your cluster does not initialize correctly, you might have to contact Red Hat support with your installation logs.

#### Prerequisites

- Configure a GCP account.
- Generate the Ignition config files for your cluster.
- Create and configure a VPC and associated subnets in GCP.

#### Procedure

1. Copy the template from the **Deployment Manager template for firewall rules** section of this topic and save it as **03\_firewall.py** on your computer. This template describes the security groups that your cluster requires.
2. Create a **03\_firewall.yaml** resource definition file:

```

$ cat <<EOF >03_firewall.yaml
imports:
- path: 03_firewall.py

resources:
- name: cluster-firewall
  type: 03_firewall.py
  properties:
    allowed_external_cidr: '0.0.0.0/0' 1
    infra_id: '${INFRA_ID}' 2

```

```

cluster_network: '${CLUSTER_NETWORK}' 3
network_cidr: '${NETWORK_CIDR}' 4
EOF

```

- 1** `allowed_external_cidr` is the CIDR range that can access the cluster API and SSH to the bootstrap host. For an internal cluster, set this value to `${NETWORK_CIDR}`.
- 2** `infra_id` is the `INFRA_ID` infrastructure name from the extraction step.
- 3** `cluster_network` is the `selfLink` URL to the cluster network.
- 4** `network_cidr` is the CIDR of the VPC network, for example `10.0.0.0/16`.

3. Create the deployment by using the `gcloud` CLI:

```

$ gcloud deployment-manager deployments create ${INFRA_ID}-firewall --config
03_firewall.yaml

```

### 8.10.12.1. Deployment Manager template for firewall rules

You can use the following Deployment Manager template to deploy the firewall rules that you need for your OpenShift Container Platform cluster:

#### Example 8.53. `03_firewall.py` Deployment Manager template

```

def GenerateConfig(context):

    resources = [{
        'name': context.properties['infra_id'] + '-bootstrap-in-ssh',
        'type': 'compute.v1.firewall',
        'properties': {
            'network': context.properties['cluster_network'],
            'allowed': [{
                'IPProtocol': 'tcp',
                'ports': ['22']
            }],
            'sourceRanges': [context.properties['allowed_external_cidr']],
            'targetTags': [context.properties['infra_id'] + '-bootstrap']
        }
    ], {
        'name': context.properties['infra_id'] + '-api',
        'type': 'compute.v1.firewall',
        'properties': {
            'network': context.properties['cluster_network'],
            'allowed': [{
                'IPProtocol': 'tcp',
                'ports': ['6443']
            }],
            'sourceRanges': [context.properties['allowed_external_cidr']],
            'targetTags': [context.properties['infra_id'] + '-master']
        }
    }, {
        'name': context.properties['infra_id'] + '-health-checks',
        'type': 'compute.v1.firewall',

```

```

'properties': {
  'network': context.properties[cluster_network],
  'allowed': [{
    'IPProtocol': 'tcp',
    'ports': ['6080', '6443', '22624']
  }],
  'sourceRanges': ['35.191.0.0/16', '130.211.0.0/22', '209.85.152.0/22', '209.85.204.0/22'],
  'targetTags': [context.properties[infra_id] + '-master']
}
}, {
  'name': context.properties[infra_id] + '-etcd',
  'type': 'compute.v1.firewall',
  'properties': {
    'network': context.properties[cluster_network],
    'allowed': [{
      'IPProtocol': 'tcp',
      'ports': ['2379-2380']
    }],
    'sourceTags': [context.properties[infra_id] + '-master'],
    'targetTags': [context.properties[infra_id] + '-master']
  }
}, {
  'name': context.properties[infra_id] + '-control-plane',
  'type': 'compute.v1.firewall',
  'properties': {
    'network': context.properties[cluster_network],
    'allowed': [{
      'IPProtocol': 'tcp',
      'ports': ['10257']
    }],
    {
      'IPProtocol': 'tcp',
      'ports': ['10259']
    },
    {
      'IPProtocol': 'tcp',
      'ports': ['22623']
    }
  ],
  'sourceTags': [
    context.properties[infra_id] + '-master',
    context.properties[infra_id] + '-worker'
  ],
  'targetTags': [context.properties[infra_id] + '-master']
}
}, {
  'name': context.properties[infra_id] + '-internal-network',
  'type': 'compute.v1.firewall',
  'properties': {
    'network': context.properties[cluster_network],
    'allowed': [{
      'IPProtocol': 'icmp'
    }],
    {
      'IPProtocol': 'tcp',
      'ports': ['22']
    }
  ],
  'sourceRanges': [context.properties[network_cidr]],
  'targetTags': [
    context.properties[infra_id] + '-master',

```



```

        context.properties['infra_id'] + '-worker'
    ]
}
}, {
  'name': context.properties['infra_id'] + '-internal-cluster',
  'type': 'compute.v1.firewall',
  'properties': {
    'network': context.properties['cluster_network'],
    'allowed': [{
      'IPProtocol': 'udp',
      'ports': ['4789', '6081']
    }, {
      'IPProtocol': 'udp',
      'ports': ['500', '4500']
    }, {
      'IPProtocol': 'esp',
    }, {
      'IPProtocol': 'tcp',
      'ports': ['9000-9999']
    }, {
      'IPProtocol': 'udp',
      'ports': ['9000-9999']
    }, {
      'IPProtocol': 'tcp',
      'ports': ['10250']
    }, {
      'IPProtocol': 'tcp',
      'ports': ['30000-32767']
    }, {
      'IPProtocol': 'udp',
      'ports': ['30000-32767']
    }
  ],
  'sourceTags': [
    context.properties['infra_id'] + '-master',
    context.properties['infra_id'] + '-worker'
  ],
  'targetTags': [
    context.properties['infra_id'] + '-master',
    context.properties['infra_id'] + '-worker'
  ]
}
]]

return {'resources': resources}

```

### 8.10.13. Creating IAM roles in GCP

You must create IAM roles in Google Cloud Platform (GCP) for your OpenShift Container Platform cluster to use. One way to create these components is to modify the provided Deployment Manager template.



## NOTE

If you do not use the provided Deployment Manager template to create your GCP infrastructure, you must review the provided information and manually create the infrastructure. If your cluster does not initialize correctly, you might have to contact Red Hat support with your installation logs.

## Prerequisites

- Configure a GCP account.
- Generate the Ignition config files for your cluster.
- Create and configure a VPC and associated subnets in GCP.

## Procedure

1. Copy the template from the **Deployment Manager template for IAM roles** section of this topic and save it as **03\_iam.py** on your computer. This template describes the IAM roles that your cluster requires.
2. Create a **03\_iam.yaml** resource definition file:

```
$ cat <<EOF >03_iam.yaml
imports:
- path: 03_iam.py
resources:
- name: cluster-iam
  type: 03_iam.py
  properties:
    infra_id: '${INFRA_ID}' 1
EOF
```

- 1** **infra\_id** is the **INFRA\_ID** infrastructure name from the extraction step.

3. Create the deployment by using the **gcloud** CLI:

```
$ gcloud deployment-manager deployments create ${INFRA_ID}-iam --config 03_iam.yaml
```

4. Export the variable for the master service account:

```
$ export MASTER_SERVICE_ACCOUNT=$(gcloud iam service-accounts list --filter
"email~^${INFRA_ID}-m@${PROJECT_NAME}." --format json | jq -r '.[0].email')
```

5. Export the variable for the worker service account:

```
$ export WORKER_SERVICE_ACCOUNT=$(gcloud iam service-accounts list --filter
"email~^${INFRA_ID}-w@${PROJECT_NAME}." --format json | jq -r '.[0].email')
```

6. Export the variable for the subnet that hosts the compute machines:

```
$ export COMPUTE_SUBNET=$(gcloud compute networks subnets describe ${INFRA_ID}-
worker-subnet --region=${REGION} --format json | jq -r .selfLink')
```

- The templates do not create the policy bindings due to limitations of Deployment Manager, so you must create them manually:

```
$ gcloud projects add-iam-policy-binding ${PROJECT_NAME} --member
"serviceAccount:${MASTER_SERVICE_ACCOUNT}" --role "roles/compute.instanceAdmin"
$ gcloud projects add-iam-policy-binding ${PROJECT_NAME} --member
"serviceAccount:${MASTER_SERVICE_ACCOUNT}" --role "roles/compute.networkAdmin"
$ gcloud projects add-iam-policy-binding ${PROJECT_NAME} --member
"serviceAccount:${MASTER_SERVICE_ACCOUNT}" --role "roles/compute.securityAdmin"
$ gcloud projects add-iam-policy-binding ${PROJECT_NAME} --member
"serviceAccount:${MASTER_SERVICE_ACCOUNT}" --role "roles/iam.serviceAccountUser"
$ gcloud projects add-iam-policy-binding ${PROJECT_NAME} --member
"serviceAccount:${MASTER_SERVICE_ACCOUNT}" --role "roles/storage.admin"

$ gcloud projects add-iam-policy-binding ${PROJECT_NAME} --member
"serviceAccount:${WORKER_SERVICE_ACCOUNT}" --role "roles/compute.viewer"
$ gcloud projects add-iam-policy-binding ${PROJECT_NAME} --member
"serviceAccount:${WORKER_SERVICE_ACCOUNT}" --role "roles/storage.admin"
```

- Create a service account key and store it locally for later use:

```
$ gcloud iam service-accounts keys create service-account-key.json --iam-
account=${MASTER_SERVICE_ACCOUNT}
```

### 8.10.13.1. Deployment Manager template for IAM roles

You can use the following Deployment Manager template to deploy the IAM roles that you need for your OpenShift Container Platform cluster:

#### Example 8.54. 03\_iam.py Deployment Manager template

```
def GenerateConfig(context):

    resources = [{
        'name': context.properties['infra_id'] + '-master-node-sa',
        'type': 'iam.v1.serviceAccount',
        'properties': {
            'accountId': context.properties['infra_id'] + '-m',
            'displayName': context.properties['infra_id'] + '-master-node'
        }
    }, {
        'name': context.properties['infra_id'] + '-worker-node-sa',
        'type': 'iam.v1.serviceAccount',
        'properties': {
            'accountId': context.properties['infra_id'] + '-w',
            'displayName': context.properties['infra_id'] + '-worker-node'
        }
    }
    ]

    return {'resources': resources}
```

### 8.10.14. Creating the RHCOS cluster image for the GCP infrastructure

You must use a valid Red Hat Enterprise Linux CoreOS (RHCOS) image for Google Cloud Platform (GCP) for your OpenShift Container Platform nodes.

## Procedure

1. Obtain the RHCOS image from the [RHCOS image mirror](#) page.



### IMPORTANT

The RHCOS images might not change with every release of OpenShift Container Platform. You must download an image with the highest version that is less than or equal to the OpenShift Container Platform version that you install. Use the image version that matches your OpenShift Container Platform version if it is available.

The file name contains the OpenShift Container Platform version number in the format **rhcos-  
<version>-<arch>-gcp.<arch>.tar.gz**.

2. Create the Google storage bucket:

```
$ gsutil mb gs://<bucket_name>
```

3. Upload the RHCOS image to the Google storage bucket:

```
$ gsutil cp <downloaded_image_file_path>/rhcos-<version>-x86_64-gcp.x86_64.tar.gz  
gs://<bucket_name>
```

4. Export the uploaded RHCOS image location as a variable:

```
$ export IMAGE_SOURCE=gs://<bucket_name>/rhcos-<version>-x86_64-gcp.x86_64.tar.gz
```

5. Create the cluster image:

```
$ gcloud compute images create "${INFRA_ID}-rhcos-image" \  
--source-uri="${IMAGE_SOURCE}"
```

## 8.10.15. Creating the bootstrap machine in GCP

You must create the bootstrap machine in Google Cloud Platform (GCP) to use during OpenShift Container Platform cluster initialization. One way to create this machine is to modify the provided Deployment Manager template.



### NOTE

If you do not use the provided Deployment Manager template to create your bootstrap machine, you must review the provided information and manually create the infrastructure. If your cluster does not initialize correctly, you might have to contact Red Hat support with your installation logs.

## Prerequisites

- Configure a GCP account.

- Generate the Ignition config files for your cluster.
- Create and configure a VPC and associated subnets in GCP.
- Create and configure networking and load balancers in GCP.
- Create control plane and compute roles.
- Ensure pyOpenSSL is installed.

## Procedure

1. Copy the template from the **Deployment Manager template for the bootstrap machine** section of this topic and save it as **04\_bootstrap.py** on your computer. This template describes the bootstrap machine that your cluster requires.
2. Export the location of the Red Hat Enterprise Linux CoreOS (RHCOS) image that the installation program requires:

```
$ export CLUSTER_IMAGE=(`gcloud compute images describe ${INFRA_ID}-rhcos-image --
format json | jq -r .selfLink`)
```

3. Create a bucket and upload the **bootstrap.ign** file:

```
$ gsutil mb gs://${INFRA_ID}-bootstrap-ignition
```

```
$ gsutil cp <installation_directory>/bootstrap.ign gs://${INFRA_ID}-bootstrap-ignition/
```

4. Create a signed URL for the bootstrap instance to use to access the Ignition config. Export the URL from the output as a variable:

```
$ export BOOTSTRAP_IGN=`gsutil signurl -d 1h service-account-key.json gs://${INFRA_ID}-
bootstrap-ignition/bootstrap.ign | grep "^gs:" | awk '{print $5}'`
```

5. Create a **04\_bootstrap.yaml** resource definition file:

```
$ cat <<EOF >04_bootstrap.yaml
imports:
- path: 04_bootstrap.py

resources:
- name: cluster-bootstrap
  type: 04_bootstrap.py
  properties:
    infra_id: '${INFRA_ID}' 1
    region: '${REGION}' 2
    zone: '${ZONE_0}' 3

    cluster_network: '${CLUSTER_NETWORK}' 4
    control_subnet: '${CONTROL_SUBNET}' 5
    image: '${CLUSTER_IMAGE}' 6
    machine_type: 'n1-standard-4' 7
    root_volume_size: '128' 8
```

```
bootstrap_ign: '${BOOTSTRAP_IGN}' 9
EOF
```

- 1 **infra\_id** is the **INFRA\_ID** infrastructure name from the extraction step.
- 2 **region** is the region to deploy the cluster into, for example **us-central1**.
- 3 **zone** is the zone to deploy the bootstrap instance into, for example **us-central1-b**.
- 4 **cluster\_network** is the **selfLink** URL to the cluster network.
- 5 **control\_subnet** is the **selfLink** URL to the control subnet.
- 6 **image** is the **selfLink** URL to the RHCOS image.
- 7 **machine\_type** is the machine type of the instance, for example **n1-standard-4**.
- 8 **root\_volume\_size** is the boot disk size for the bootstrap machine.
- 9 **bootstrap\_ign** is the URL output when creating a signed URL.

6. Create the deployment by using the **gcloud** CLI:

```
$ gcloud deployment-manager deployments create ${INFRA_ID}-bootstrap --config
04_bootstrap.yaml
```

7. The templates do not manage load balancer membership due to limitations of Deployment Manager, so you must add the bootstrap machine manually.
  - a. Add the bootstrap instance to the internal load balancer instance group:

```
$ gcloud compute instance-groups unmanaged add-instances \
  ${INFRA_ID}-bootstrap-ig --zone=${ZONE_0} --instances=${INFRA_ID}-bootstrap
```

- b. Add the bootstrap instance group to the internal load balancer backend service:

```
$ gcloud compute backend-services add-backend \
  ${INFRA_ID}-api-internal-backend-service --region=${REGION} --instance-
group=${INFRA_ID}-bootstrap-ig --instance-group-zone=${ZONE_0}
```

### 8.10.15.1. Deployment Manager template for the bootstrap machine

You can use the following Deployment Manager template to deploy the bootstrap machine that you need for your OpenShift Container Platform cluster:

#### Example 8.55. 04\_bootstrap.py Deployment Manager template

```
def GenerateConfig(context):

    resources = [{
        'name': context.properties['infra_id'] + '-bootstrap-public-ip',
        'type': 'compute.v1.address',
        'properties': {
```

```

    'region': context.properties['region']
  }
}, {
  'name': context.properties['infra_id'] + '-bootstrap',
  'type': 'compute.v1.instance',
  'properties': {
    'disks': [{
      'autoDelete': True,
      'boot': True,
      'initializeParams': {
        'diskSizeGb': context.properties['root_volume_size'],
        'sourceImage': context.properties['image']
      }
    }],
    'machineType': 'zones/' + context.properties['zone'] + '/machineTypes/' +
context.properties['machine_type'],
    'metadata': {
      'items': [{
        'key': 'user-data',
        'value': '{"ignition":{"config":{"replace":{"source":"' + context.properties['bootstrap_ign']
+ '"},"version":"3.2.0"}}}',
      }],
    },
    'networkInterfaces': [{
      'subnetwork': context.properties['control_subnet'],
      'accessConfigs': [{
        'natIP': '${ref.' + context.properties['infra_id'] + '-bootstrap-public-ip.address}'
      }],
    }],
    'tags': {
      'items': [
        context.properties['infra_id'] + '-master',
        context.properties['infra_id'] + '-bootstrap'
      ]
    },
    'zone': context.properties['zone']
  }
}, {
  'name': context.properties['infra_id'] + '-bootstrap-ig',
  'type': 'compute.v1.instanceGroup',
  'properties': {
    'namedPorts': [
      {
        'name': 'ignition',
        'port': 22623
      }, {
        'name': 'https',
        'port': 6443
      }
    ],
    'network': context.properties['cluster_network'],
    'zone': context.properties['zone']
  }
}
]]

return {'resources': resources}

```

## 8.10.16. Creating the control plane machines in GCP

You must create the control plane machines in Google Cloud Platform (GCP) for your cluster to use. One way to create these machines is to modify the provided Deployment Manager template.



### NOTE

If you do not use the provided Deployment Manager template to create your control plane machines, you must review the provided information and manually create the infrastructure. If your cluster does not initialize correctly, you might have to contact Red Hat support with your installation logs.

### Prerequisites

- Configure a GCP account.
- Generate the Ignition config files for your cluster.
- Create and configure a VPC and associated subnets in GCP.
- Create and configure networking and load balancers in GCP.
- Create control plane and compute roles.
- Create the bootstrap machine.

### Procedure

1. Copy the template from the **Deployment Manager template for control plane machines** section of this topic and save it as **05\_control\_plane.py** on your computer. This template describes the control plane machines that your cluster requires.
2. Export the following variable required by the resource definition:

```
$ export MASTER_IGNITION=`cat <installation_directory>/master.ign`
```

3. Create a **05\_control\_plane.yaml** resource definition file:

```
$ cat <<EOF >05_control_plane.yaml
imports:
- path: 05_control_plane.py

resources:
- name: cluster-control-plane
  type: 05_control_plane.py
  properties:
    infra_id: '${INFRA_ID}' 1
    zones: 2
    - '${ZONE_0}'
    - '${ZONE_1}'
    - '${ZONE_2}'

    control_subnet: '${CONTROL_SUBNET}' 3
```



```

image: '${CLUSTER_IMAGE}' 4
machine_type: 'n1-standard-4' 5
root_volume_size: '128'
service_account_email: '${MASTER_SERVICE_ACCOUNT}' 6

ignition: '${MASTER_IGNITION}' 7
EOF

```

- 1 **infra\_id** is the **INFRA\_ID** infrastructure name from the extraction step.
- 2 **zones** are the zones to deploy the control plane instances into, for example **us-central1-a**, **us-central1-b**, and **us-central1-c**.
- 3 **control\_subnet** is the **selfLink** URL to the control subnet.
- 4 **image** is the **selfLink** URL to the RHCOS image.
- 5 **machine\_type** is the machine type of the instance, for example **n1-standard-4**.
- 6 **service\_account\_email** is the email address for the master service account that you created.
- 7 **ignition** is the contents of the **master.ign** file.

4. Create the deployment by using the **gcloud** CLI:

```

$ gcloud deployment-manager deployments create ${INFRA_ID}-control-plane --config
05_control_plane.yaml

```

5. The templates do not manage load balancer membership due to limitations of Deployment Manager, so you must add the control plane machines manually.

- Run the following commands to add the control plane machines to the appropriate instance groups:

```

$ gcloud compute instance-groups unmanaged add-instances ${INFRA_ID}-master-
${ZONE_0}-ig --zone=${ZONE_0} --instances=${INFRA_ID}-master-0

```

```

$ gcloud compute instance-groups unmanaged add-instances ${INFRA_ID}-master-
${ZONE_1}-ig --zone=${ZONE_1} --instances=${INFRA_ID}-master-1

```

```

$ gcloud compute instance-groups unmanaged add-instances ${INFRA_ID}-master-
${ZONE_2}-ig --zone=${ZONE_2} --instances=${INFRA_ID}-master-2

```

- For an external cluster, you must also run the following commands to add the control plane machines to the target pools:

```

$ gcloud compute target-pools add-instances ${INFRA_ID}-api-target-pool --instances-
zone="${ZONE_0}" --instances=${INFRA_ID}-master-0

```

```

$ gcloud compute target-pools add-instances ${INFRA_ID}-api-target-pool --instances-
zone="${ZONE_1}" --instances=${INFRA_ID}-master-1

```

-

```
$ gcloud compute target-pools add-instances ${INFRA_ID}-api-target-pool --instances-zone="${ZONE_2}" --instances=${INFRA_ID}-master-2
```

### 8.10.16.1. Deployment Manager template for control plane machines

You can use the following Deployment Manager template to deploy the control plane machines that you need for your OpenShift Container Platform cluster:

#### Example 8.56. 05\_control\_plane.py Deployment Manager template

```
def GenerateConfig(context):

    resources = [{
        'name': context.properties['infra_id'] + '-master-0',
        'type': 'compute.v1.instance',
        'properties': {
            'disks': [{
                'autoDelete': True,
                'boot': True,
                'initializeParams': {
                    'diskSizeGb': context.properties['root_volume_size'],
                    'diskType': 'zones/' + context.properties['zones'][0] + '/diskTypes/pd-ssd',
                    'sourceImage': context.properties['image']
                }
            }],
            'machineType': 'zones/' + context.properties['zones'][0] + '/machineTypes/' +
context.properties['machine_type'],
            'metadata': {
                'items': [{
                    'key': 'user-data',
                    'value': context.properties['ignition']
                }]
            },
            'networkInterfaces': [{
                'subnetwork': context.properties['control_subnet']
            }],
            'serviceAccounts': [{
                'email': context.properties['service_account_email'],
                'scopes': ['https://www.googleapis.com/auth/cloud-platform']
            }],
            'tags': {
                'items': [
                    context.properties['infra_id'] + '-master',
                ]
            },
            'zone': context.properties['zones'][0]
        }
    ], {
        'name': context.properties['infra_id'] + '-master-1',
        'type': 'compute.v1.instance',
        'properties': {
            'disks': [{
                'autoDelete': True,
                'boot': True,
                'initializeParams': {
```

```

        'diskSizeGb': context.properties['root_volume_size'],
        'diskType': 'zones/' + context.properties['zones'][1] + '/diskTypes/pd-ssd',
        'sourceImage': context.properties['image']
    }
  }],
  'machineType': 'zones/' + context.properties['zones'][1] + '/machineTypes/' +
context.properties['machine_type'],
  'metadata': {
    'items': [{
      'key': 'user-data',
      'value': context.properties['ignition']
    }]
  },
  'networkInterfaces': [{
    'subnetwork': context.properties['control_subnet']
  }],
  'serviceAccounts': [{
    'email': context.properties['service_account_email'],
    'scopes': ['https://www.googleapis.com/auth/cloud-platform']
  }],
  'tags': {
    'items': [
      context.properties['infra_id'] + '-master',
    ]
  },
  'zone': context.properties['zones'][1]
}
}, {
  'name': context.properties['infra_id'] + '-master-2',
  'type': 'compute.v1.instance',
  'properties': {
    'disks': [{
      'autoDelete': True,
      'boot': True,
      'initializeParams': {
        'diskSizeGb': context.properties['root_volume_size'],
        'diskType': 'zones/' + context.properties['zones'][2] + '/diskTypes/pd-ssd',
        'sourceImage': context.properties['image']
      }
    }]
  },
  'machineType': 'zones/' + context.properties['zones'][2] + '/machineTypes/' +
context.properties['machine_type'],
  'metadata': {
    'items': [{
      'key': 'user-data',
      'value': context.properties['ignition']
    }]
  },
  'networkInterfaces': [{
    'subnetwork': context.properties['control_subnet']
  }],
  'serviceAccounts': [{
    'email': context.properties['service_account_email'],
    'scopes': ['https://www.googleapis.com/auth/cloud-platform']
  }],
  'tags': {

```

```

        'items': [
            context.properties['infra_id'] + '-master',
        ]
    },
    'zone': context.properties['zones'][2]
}
}}

return {'resources': resources}

```

### 8.10.17. Wait for bootstrap completion and remove bootstrap resources in GCP

After you create all of the required infrastructure in Google Cloud Platform (GCP), wait for the bootstrap process to complete on the machines that you provisioned by using the Ignition config files that you generated with the installation program.

#### Prerequisites

- Configure a GCP account.
- Generate the Ignition config files for your cluster.
- Create and configure a VPC and associated subnets in GCP.
- Create and configure networking and load balancers in GCP.
- Create control plane and compute roles.
- Create the bootstrap machine.
- Create the control plane machines.

#### Procedure

1. Change to the directory that contains the installation program and run the following command:

```

$ ./openshift-install wait-for bootstrap-complete --dir <installation_directory> \ 1
--log-level info 2

```

- 1 For **<installation\_directory>**, specify the path to the directory that you stored the installation files in.
- 2 To view different installation details, specify **warn**, **debug**, or **error** instead of **info**.

If the command exits without a **FATAL** warning, your production control plane has initialized.

2. Delete the bootstrap resources:

```

$ gcloud compute backend-services remove-backend ${INFRA_ID}-api-internal-backend-
service --region=${REGION} --instance-group=${INFRA_ID}-bootstrap-ig --instance-group-
zone=${ZONE_0}

```

```
$ gsutil rm gs://{INFRA_ID}-bootstrap-ignition/bootstrap.ign
```

```
$ gsutil rb gs://{INFRA_ID}-bootstrap-ignition
```

```
$ gcloud deployment-manager deployments delete ${INFRA_ID}-bootstrap
```

### 8.10.18. Creating additional worker machines in GCP

You can create worker machines in Google Cloud Platform (GCP) for your cluster to use by launching individual instances discretely or by automated processes outside the cluster, such as auto scaling groups. You can also take advantage of the built-in cluster scaling mechanisms and the machine API in OpenShift Container Platform.

In this example, you manually launch one instance by using the Deployment Manager template. Additional instances can be launched by including additional resources of type **06\_worker.py** in the file.



#### NOTE

If you do not use the provided Deployment Manager template to create your worker machines, you must review the provided information and manually create the infrastructure. If your cluster does not initialize correctly, you might have to contact Red Hat support with your installation logs.

#### Prerequisites

- Configure a GCP account.
- Generate the Ignition config files for your cluster.
- Create and configure a VPC and associated subnets in GCP.
- Create and configure networking and load balancers in GCP.
- Create control plane and compute roles.
- Create the bootstrap machine.
- Create the control plane machines.

#### Procedure

1. Copy the template from the **Deployment Manager template for worker machines** section of this topic and save it as **06\_worker.py** on your computer. This template describes the worker machines that your cluster requires.
2. Export the variables that the resource definition uses.
  - a. Export the subnet that hosts the compute machines:

```
$ export COMPUTE_SUBNET=`gcloud compute networks subnets describe  
${INFRA_ID}-worker-subnet --region=${REGION} --format json | jq -r .selfLink`
```

- b. Export the email address for your service account:

```
$ export WORKER_SERVICE_ACCOUNT=$(gcloud iam service-accounts list --filter
"email~^${INFRA_ID}-w@${PROJECT_NAME}." --format json | jq -r '[0].email')
```

- c. Export the location of the compute machine Ignition config file:

```
$ export WORKER_IGNITION=`cat <installation_directory>/worker.ign`
```

3. Create a **06\_worker.yaml** resource definition file:

```
$ cat <<EOF >06_worker.yaml
imports:
- path: 06_worker.py

resources:
- name: 'worker-0' 1
  type: 06_worker.py
  properties:
    infra_id: '${INFRA_ID}' 2
    zone: '${ZONE_0}' 3
    compute_subnet: '${COMPUTE_SUBNET}' 4
    image: '${CLUSTER_IMAGE}' 5
    machine_type: 'n1-standard-4' 6
    root_volume_size: '128'
    service_account_email: '${WORKER_SERVICE_ACCOUNT}' 7
    ignition: '${WORKER_IGNITION}' 8
- name: 'worker-1'
  type: 06_worker.py
  properties:
    infra_id: '${INFRA_ID}' 9
    zone: '${ZONE_1}' 10
    compute_subnet: '${COMPUTE_SUBNET}' 11
    image: '${CLUSTER_IMAGE}' 12
    machine_type: 'n1-standard-4' 13
    root_volume_size: '128'
    service_account_email: '${WORKER_SERVICE_ACCOUNT}' 14
    ignition: '${WORKER_IGNITION}' 15
EOF
```

- 1 **name** is the name of the worker machine, for example **worker-0**.
- 2 9 **infra\_id** is the **INFRA\_ID** infrastructure name from the extraction step.
- 3 10 **zone** is the zone to deploy the worker machine into, for example **us-central1-a**.
- 4 11 **compute\_subnet** is the **selfLink** URL to the compute subnet.
- 5 12 **image** is the **selfLink** URL to the RHCOS image. <sup>1</sup>
- 6 13 **machine\_type** is the machine type of the instance, for example **n1-standard-4**.
- 7 14 **service\_account\_email** is the email address for the worker service account that you created.

**8 15** **ignition** is the contents of the **worker.ign** file.

4. Optional: If you want to launch additional instances, include additional resources of type **06\_worker.py** in your **06\_worker.yaml** resource definition file.
5. Create the deployment by using the **gcloud** CLI:

```
$ gcloud deployment-manager deployments create ${INFRA_ID}-worker --config
06_worker.yaml
```

1. To use a GCP Marketplace image, specify the offer to use:
  - OpenShift Container Platform: <https://www.googleapis.com/compute/v1/projects/redhat-marketplace-public/global/images/redhat-coreos-ocp-48-x86-64-202210040145>
  - OpenShift Platform Plus: <https://www.googleapis.com/compute/v1/projects/redhat-marketplace-public/global/images/redhat-coreos-opp-48-x86-64-202206140145>
  - OpenShift Kubernetes Engine: <https://www.googleapis.com/compute/v1/projects/redhat-marketplace-public/global/images/redhat-coreos-oke-48-x86-64-202206140145>

### 8.10.18.1. Deployment Manager template for worker machines

You can use the following Deployment Manager template to deploy the worker machines that you need for your OpenShift Container Platform cluster:

#### Example 8.57. 06\_worker.py Deployment Manager template

```
def GenerateConfig(context):

    resources = [{
        'name': context.properties['infra_id'] + '-' + context.env['name'],
        'type': 'compute.v1.instance',
        'properties': {
            'disks': [{
                'autoDelete': True,
                'boot': True,
                'initializeParams': {
                    'diskSizeGb': context.properties['root_volume_size'],
                    'sourceImage': context.properties['image']
                }
            }],
            'machineType': 'zones/' + context.properties['zone'] + '/machineTypes/' +
context.properties['machine_type'],
            'metadata': {
                'items': [{
                    'key': 'user-data',
                    'value': context.properties['ignition']
                }]
            },
            'networkInterfaces': [{
                'subnetwork': context.properties['compute_subnet']
            }],
        }],
```

```

    'serviceAccounts': [{
      'email': context.properties['service_account_email'],
      'scopes': ['https://www.googleapis.com/auth/cloud-platform']
    }],
    'tags': {
      'items': [
        context.properties['infra_id'] + '-worker',
      ]
    },
    'zone': context.properties['zone']
  }
}]

return {'resources': resources}

```

### 8.10.19. Installing the OpenShift CLI by downloading the binary

You can install the OpenShift CLI (**oc**) to interact with OpenShift Container Platform from a command-line interface. You can install **oc** on Linux, Windows, or macOS.



#### IMPORTANT

If you installed an earlier version of **oc**, you cannot use it to complete all of the commands in OpenShift Container Platform 4.10. Download and install the new version of **oc**.

#### Installing the OpenShift CLI on Linux

You can install the OpenShift CLI (**oc**) binary on Linux by using the following procedure.

#### Procedure

1. Navigate to the [OpenShift Container Platform downloads page](#) on the Red Hat Customer Portal.
2. Select the appropriate version in the **Version** drop-down menu.
3. Click **Download Now** next to the **OpenShift v4.10 Linux Client** entry and save the file.
4. Unpack the archive:

```
$ tar xvf <file>
```

5. Place the **oc** binary in a directory that is on your **PATH**.  
To check your **PATH**, execute the following command:

```
$ echo $PATH
```

After you install the OpenShift CLI, it is available using the **oc** command:

```
$ oc <command>
```

#### Installing the OpenShift CLI on Windows

You can install the OpenShift CLI (**oc**) binary on Windows by using the following procedure.



## Procedure

1. Navigate to the [OpenShift Container Platform downloads page](#) on the Red Hat Customer Portal.
2. Select the appropriate version in the **Version** drop-down menu.
3. Click **Download Now** next to the **OpenShift v4.10 Windows Client** entry and save the file.
4. Unzip the archive with a ZIP program.
5. Move the **oc** binary to a directory that is on your **PATH**.  
To check your **PATH**, open the command prompt and execute the following command:

```
C:\> path
```

After you install the OpenShift CLI, it is available using the **oc** command:

```
C:\> oc <command>
```

## Installing the OpenShift CLI on macOS

You can install the OpenShift CLI (**oc**) binary on macOS by using the following procedure.

## Procedure

1. Navigate to the [OpenShift Container Platform downloads page](#) on the Red Hat Customer Portal.
2. Select the appropriate version in the **Version** drop-down menu.
3. Click **Download Now** next to the **OpenShift v4.10 MacOSX Client** entry and save the file.
4. Unpack and unzip the archive.
5. Move the **oc** binary to a directory on your PATH.  
To check your **PATH**, open a terminal and execute the following command:

```
$ echo $PATH
```

After you install the OpenShift CLI, it is available using the **oc** command:

```
$ oc <command>
```

## 8.10.20. Logging in to the cluster by using the CLI

You can log in to your cluster as a default system user by exporting the cluster **kubeconfig** file. The **kubeconfig** file contains information about the cluster that is used by the CLI to connect a client to the correct cluster and API server. The file is specific to a cluster and is created during OpenShift Container Platform installation.

## Prerequisites

- You deployed an OpenShift Container Platform cluster.

- You installed the **oc** CLI.

### Procedure

- Export the **kubeadmin** credentials:

```
$ export KUBECONFIG=<installation_directory>/auth/kubeconfig 1
```

- 1** For **<installation\_directory>**, specify the path to the directory that you stored the installation files in.

- Verify you can run **oc** commands successfully using the exported configuration:

```
$ oc whoami
```

### Example output

```
system:admin
```

## 8.10.21. Approving the certificate signing requests for your machines

When you add machines to a cluster, two pending certificate signing requests (CSRs) are generated for each machine that you added. You must confirm that these CSRs are approved or, if necessary, approve them yourself. The client requests must be approved first, followed by the server requests.

### Prerequisites

- You added machines to your cluster.

### Procedure

- Confirm that the cluster recognizes the machines:

```
$ oc get nodes
```

### Example output

```
NAME      STATUS   ROLES    AGE   VERSION
master-0  Ready   master   63m   v1.23.0
master-1  Ready   master   63m   v1.23.0
master-2  Ready   master   64m   v1.23.0
```

The output lists all of the machines that you created.



### NOTE

The preceding output might not include the compute nodes, also known as worker nodes, until some CSRs are approved.

- Review the pending CSRs and ensure that you see the client requests with the **Pending** or **Approved** status for each machine that you added to the cluster:

```
$ oc get csr
```

### Example output

```
NAME      AGE   REQUESTOR                                     CONDITION
csr-8b2br 15m   system:serviceaccount:openshift-machine-config-operator:node-
bootstrapper Pending
csr-8vnps 15m   system:serviceaccount:openshift-machine-config-operator:node-
bootstrapper Pending
...
```

In this example, two machines are joining the cluster. You might see more approved CSRs in the list.

- If the CSRs were not approved, after all of the pending CSRs for the machines you added are in **Pending** status, approve the CSRs for your cluster machines:



#### NOTE

Because the CSRs rotate automatically, approve your CSRs within an hour of adding the machines to the cluster. If you do not approve them within an hour, the certificates will rotate, and more than two certificates will be present for each node. You must approve all of these certificates. After the client CSR is approved, the Kubelet creates a secondary CSR for the serving certificate, which requires manual approval. Then, subsequent serving certificate renewal requests are automatically approved by the **machine-approver** if the Kubelet requests a new certificate with identical parameters.



#### NOTE

For clusters running on platforms that are not machine API enabled, such as bare metal and other user-provisioned infrastructure, you must implement a method of automatically approving the kubelet serving certificate requests (CSRs). If a request is not approved, then the **oc exec**, **oc rsh**, and **oc logs** commands cannot succeed, because a serving certificate is required when the API server connects to the kubelet. Any operation that contacts the Kubelet endpoint requires this certificate approval to be in place. The method must watch for new CSRs, confirm that the CSR was submitted by the **node-bootstrapper** service account in the **system:node** or **system:admin** groups, and confirm the identity of the node.

- To approve them individually, run the following command for each valid CSR:

```
$ oc adm certificate approve <csr_name> 1
```

- 1** **<csr\_name>** is the name of a CSR from the list of current CSRs.

- To approve all pending CSRs, run the following command:

```
$ oc get csr -o go-template='{{range .items}}{{if not .status}}{{.metadata.name}}{\n"}\n{{end}}\n{{end}}' | xargs --no-run-if-empty oc adm certificate approve
```

**NOTE**

Some Operators might not become available until some CSRs are approved.

- Now that your client requests are approved, you must review the server requests for each machine that you added to the cluster:

```
$ oc get csr
```

**Example output**

```
NAME      AGE   REQUESTOR                                     CONDITION
csr-bfd72 5m26s system:node:ip-10-0-50-126.us-east-2.compute.internal
Pending
csr-c57lv 5m26s system:node:ip-10-0-95-157.us-east-2.compute.internal
Pending
...
```

- If the remaining CSRs are not approved, and are in the **Pending** status, approve the CSRs for your cluster machines:

- To approve them individually, run the following command for each valid CSR:

```
$ oc adm certificate approve <csr_name> 1
```

**1** **<csr\_name>** is the name of a CSR from the list of current CSRs.

- To approve all pending CSRs, run the following command:

```
$ oc get csr -o go-template='{{range .items}}{{if not .status}}{{.metadata.name}}{\n"}\n{{end}}' | xargs oc adm certificate approve
```

- After all client and server CSRs have been approved, the machines have the **Ready** status. Verify this by running the following command:

```
$ oc get nodes
```

**Example output**

```
NAME      STATUS  ROLES  AGE  VERSION
master-0  Ready   master 73m  v1.23.0
master-1  Ready   master 73m  v1.23.0
master-2  Ready   master 74m  v1.23.0
worker-0  Ready   worker 11m  v1.23.0
worker-1  Ready   worker 11m  v1.23.0
```

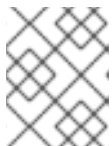
**NOTE**

It can take a few minutes after approval of the server CSRs for the machines to transition to the **Ready** status.

## Additional information

- For more information on CSRs, see [Certificate Signing Requests](#).

### 8.10.22. Optional: Adding the ingress DNS records

If you removed the DNS zone configuration when creating Kubernetes manifests and generating Ignition configs, you must manually create DNS records that point at the ingress load balancer. You can create either a wildcard `*.apps.{baseDomain}`, or specific records. You can use A, CNAME, and other records per your requirements.

#### Prerequisites

- Configure a GCP account.
- Remove the DNS Zone configuration when creating Kubernetes manifests and generating Ignition configs.
- Create and configure a VPC and associated subnets in GCP.
- Create and configure networking and load balancers in GCP.
- Create control plane and compute roles.
- Create the bootstrap machine.
- Create the control plane machines.
- Create the worker machines.

#### Procedure

1. Wait for the Ingress router to create a load balancer and populate the **EXTERNAL-IP** field:

```
$ oc -n openshift-ingress get service router-default
```

#### Example output

```
NAME          TYPE          CLUSTER-IP   EXTERNAL-IP   PORT(S)          AGE
router-default LoadBalancer  172.30.18.154 35.233.157.184 80:32288/TCP,443:31215/TCP 98
```

2. Add the A record to your zones:

- To use A records:
  - i. Export the variable for the router IP address:

```
$ export ROUTER_IP=`oc -n openshift-ingress get service router-default --no-headers | awk '{print $4}'`
```

- ii. Add the A record to the private zones:

```
$ if [ -f transaction.yaml ]; then rm transaction.yaml; fi
$ gcloud dns record-sets transaction start --zone ${INFRA_ID}-private-zone
```

```
$ gcloud dns record-sets transaction add ${ROUTER_IP} --name
\*.apps.${CLUSTER_NAME}.${BASE_DOMAIN}. --ttl 300 --type A --zone
${INFRA_ID}-private-zone
$ gcloud dns record-sets transaction execute --zone ${INFRA_ID}-private-zone
```

- iii. For an external cluster, also add the A record to the public zones:

```
$ if [ -f transaction.yaml ]; then rm transaction.yaml; fi
$ gcloud dns record-sets transaction start --zone ${BASE_DOMAIN_ZONE_NAME}
$ gcloud dns record-sets transaction add ${ROUTER_IP} --name
\*.apps.${CLUSTER_NAME}.${BASE_DOMAIN}. --ttl 300 --type A --zone
${BASE_DOMAIN_ZONE_NAME}
$ gcloud dns record-sets transaction execute --zone
${BASE_DOMAIN_ZONE_NAME}
```

- To add explicit domains instead of using a wildcard, create entries for each of the cluster's current routes:

```
$ oc get --all-namespaces -o jsonpath='{range .items[*]}{range .status.ingress[*]}{.host}
{"\n"}{end}{end}' routes
```

### Example output

```
oauth-openshift.apps.your.cluster.domain.example.com
console-openshift-console.apps.your.cluster.domain.example.com
downloads-openshift-console.apps.your.cluster.domain.example.com
alertmanager-main-openshift-monitoring.apps.your.cluster.domain.example.com
grafana-openshift-monitoring.apps.your.cluster.domain.example.com
prometheus-k8s-openshift-monitoring.apps.your.cluster.domain.example.com
```

## 8.10.23. Completing a GCP installation on user-provisioned infrastructure

After you start the OpenShift Container Platform installation on Google Cloud Platform (GCP) user-provisioned infrastructure, you can monitor the cluster events until the cluster is ready.

### Prerequisites

- Deploy the bootstrap machine for an OpenShift Container Platform cluster on user-provisioned GCP infrastructure.
- Install the **oc** CLI and log in.

### Procedure

- Complete the cluster installation:

```
$ ./openshift-install --dir <installation_directory> wait-for install-complete 1
```

### Example output

```
INFO Waiting up to 30m0s for the cluster to initialize...
```

- 1 For `<installation_directory>`, specify the path to the directory that you stored the installation files in.



## IMPORTANT

- The Ignition config files that the installation program generates contain certificates that expire after 24 hours, which are then renewed at that time. If the cluster is shut down before renewing the certificates and the cluster is later restarted after the 24 hours have elapsed, the cluster automatically recovers the expired certificates. The exception is that you must manually approve the pending **node-bootstrapper** certificate signing requests (CSRs) to recover kubelet certificates. See the documentation for *Recovering from expired control plane certificates* for more information.
- It is recommended that you use Ignition config files within 12 hours after they are generated because the 24-hour certificate rotates from 16 to 22 hours after the cluster is installed. By using the Ignition config files within 12 hours, you can avoid installation failure if the certificate update runs during installation.

2. Observe the running state of your cluster.

- a. Run the following command to view the current cluster version and status:

```
$ oc get clusterversion
```

### Example output

```
NAME      VERSION  AVAILABLE  PROGRESSING  SINCE  STATUS
version   False    True        24m          Working towards 4.5.4: 99% complete
```

- b. Run the following command to view the Operators managed on the control plane by the Cluster Version Operator (CVO):

```
$ oc get clusteroperators
```

### Example output

```
NAME                               VERSION  AVAILABLE  PROGRESSING  DEGRADED  SINCE
authentication                      4.5.4   True       False        False     7m56s
cloud-credential                     4.5.4   True       False        False     31m
cluster-autoscaler                   4.5.4   True       False        False     16m
console                              4.5.4   True       False        False     10m
csi-snapshot-controller              4.5.4   True       False        False     16m
dns                                  4.5.4   True       False        False     22m
etcd                                  4.5.4   False      False        False     25s
image-registry                       4.5.4   True       False        False     16m
ingress                              4.5.4   True       False        False     16m
insights                             4.5.4   True       False        False     17m
kube-apiserver                       4.5.4   True       False        False     19m
kube-controller-manager              4.5.4   True       False        False     20m
kube-scheduler                       4.5.4   True       False        False     20m
```

kube-storage-version-migrator	4.5.4	True	False	False	16m
machine-api	4.5.4	True	False	False	22m
machine-config	4.5.4	True	False	False	22m
marketplace	4.5.4	True	False	False	16m
monitoring	4.5.4	True	False	False	10m
network	4.5.4	True	False	False	23m
node-tuning	4.5.4	True	False	False	23m
openshift-apiserver	4.5.4	True	False	False	17m
openshift-controller-manager	4.5.4	True	False	False	15m
openshift-samples	4.5.4	True	False	False	16m
operator-lifecycle-manager	4.5.4	True	False	False	22m
operator-lifecycle-manager-catalog	4.5.4	True	False	False	22m
operator-lifecycle-manager-packageserver	4.5.4	True	False	False	18m
service-ca	4.5.4	True	False	False	23m
service-catalog-apiserver	4.5.4	True	False	False	23m
service-catalog-controller-manager	4.5.4	True	False	False	23m
storage	4.5.4	True	False	False	17m

- c. Run the following command to view your cluster pods:

```
$ oc get pods --all-namespaces
```

### Example output

```

NAMESPACE                               NAME
READY STATUS  RESTARTS  AGE
kube-system                               etcd-member-ip-10-0-3-111.us-east-
2.compute.internal                       1/1    Running  0    35m
kube-system                               etcd-member-ip-10-0-3-239.us-east-
2.compute.internal                       1/1    Running  0    37m
kube-system                               etcd-member-ip-10-0-3-24.us-east-
2.compute.internal                       1/1    Running  0    35m
openshift-apiserver-operator             openshift-apiserver-operator-6d6674f4f4-
h7t2t                                     1/1    Running  1    37m
openshift-apiserver                      apiserver-fm48r
1/1    Running  0    30m
openshift-apiserver                      apiserver-fxkvv
1/1    Running  0    29m
openshift-apiserver                      apiserver-q85nm
1/1    Running  0    29m
...
openshift-service-ca-operator             openshift-service-ca-operator-66ff6dc6cd-
9r257                                     1/1    Running  0    37m
openshift-service-ca                     apiservice-cabundle-injector-695b6bcbc-cl5hm
1/1    Running  0    35m
openshift-service-ca                     configmap-cabundle-injector-8498544d7-
25qn6                                     1/1    Running  0    35m
openshift-service-ca                     service-serving-cert-signer-6445fc9c6-wqdqn
1/1    Running  0    35m
openshift-service-catalog-apiserver-operator openshift-service-catalog-apiserver-
operator-549f44668b-b5q2w                1/1    Running  0    32m
openshift-service-catalog-controller-manager-operator openshift-service-catalog-
controller-manager-operator-b78cr2lnm    1/1    Running  0    31m

```

When the current cluster version is **AVAILABLE**, the installation is complete.



### 8.10.24. Telemetry access for OpenShift Container Platform

In OpenShift Container Platform 4.10, the Telemetry service, which runs by default to provide metrics about cluster health and the success of updates, requires internet access. If your cluster is connected to the internet, Telemetry runs automatically, and your cluster is registered to [OpenShift Cluster Manager](#).

After you confirm that your [OpenShift Cluster Manager](#) inventory is correct, either maintained automatically by Telemetry or manually by using OpenShift Cluster Manager, [use subscription watch](#) to track your OpenShift Container Platform subscriptions at the account or multi-cluster level.

#### Additional resources

- See [About remote health monitoring](#) for more information about the Telemetry service

### 8.10.25. Next steps

- [Customize your cluster](#).
- If necessary, you can [opt out of remote health reporting](#).
- [Configure Global Access for an Ingress Controller on GCP](#).

## 8.11. INSTALLING A CLUSTER INTO A SHARED VPC ON GCP USING DEPLOYMENT MANAGER TEMPLATES

In OpenShift Container Platform version 4.10, you can install a cluster into a shared Virtual Private Cloud (VPC) on Google Cloud Platform (GCP) that uses infrastructure that you provide. In this context, a cluster installed into a shared VPC is a cluster that is configured to use a VPC from a project different from where the cluster is being deployed.

A shared VPC enables an organization to connect resources from multiple projects to a common VPC network. You can communicate within the organization securely and efficiently by using internal IPs from that network. For more information about shared VPC, see [Shared VPC overview](#) in the GCP documentation.

The steps for performing a user-provided infrastructure installation into a shared VPC are outlined here. Several [Deployment Manager](#) templates are provided to assist in completing these steps or to help model your own. You are also free to create the required resources through other methods.

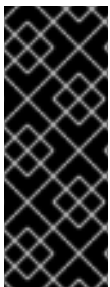

#### IMPORTANT

The steps for performing a user-provisioned infrastructure installation are provided as an example only. Installing a cluster with infrastructure you provide requires knowledge of the cloud provider and the installation process of OpenShift Container Platform. Several Deployment Manager templates are provided to assist in completing these steps or to help model your own. You are also free to create the required resources through other methods; the templates are just an example.

### 8.11.1. Prerequisites

- You reviewed details about the [OpenShift Container Platform installation and update](#) processes.

- You read the documentation on [selecting a cluster installation method and preparing it for users](#).
- If you use a firewall and plan to use the Telemetry service, you [configured the firewall to allow the sites](#) that your cluster requires access to.
- If the cloud identity and access management (IAM) APIs are not accessible in your environment, or if you do not want to store an administrator-level credential secret in the **kube-system** namespace, you can [manually create and maintain IAM credentials](#).

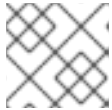

#### NOTE

Be sure to also review this site list if you are configuring a proxy.

### 8.1.2. Certificate signing requests management

Because your cluster has limited access to automatic machine management when you use infrastructure that you provision, you must provide a mechanism for approving cluster certificate signing requests (CSRs) after installation. The **kube-controller-manager** only approves the kubelet client CSRs. The **machine-approver** cannot guarantee the validity of a serving certificate that is requested by using kubelet credentials because it cannot confirm that the correct machine issued the request. You must determine and implement a method of verifying the validity of the kubelet serving certificate requests and approving them.

### 8.1.3. Internet access for OpenShift Container Platform

In OpenShift Container Platform 4.10, you require access to the internet to install your cluster.

You must have internet access to:

- Access [OpenShift Cluster Manager](#) to download the installation program and perform subscription management. If the cluster has internet access and you do not disable Telemetry, that service automatically entitles your cluster.
- Access [Quay.io](#) to obtain the packages that are required to install your cluster.
- Obtain the packages that are required to perform cluster updates.

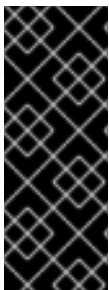

#### IMPORTANT

If your cluster cannot have direct internet access, you can perform a restricted network installation on some types of infrastructure that you provision. During that process, you download the required content and use it to populate a mirror registry with the installation packages. With some installation types, the environment that you install your cluster in will not require internet access. Before you update the cluster, you update the content of the mirror registry.

### 8.1.4. Configuring the GCP project that hosts your cluster

Before you can install OpenShift Container Platform, you must configure a Google Cloud Platform (GCP) project to host it.

#### 8.1.4.1. Creating a GCP project

To install OpenShift Container Platform, you must create a project in your Google Cloud Platform (GCP) account to host the cluster.

### Procedure

- Create a project to host your OpenShift Container Platform cluster. See [Creating and Managing Projects](#) in the GCP documentation.

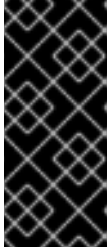

### IMPORTANT

Your GCP project must use the Premium Network Service Tier if you are using installer-provisioned infrastructure. The Standard Network Service Tier is not supported for clusters installed using the installation program. The installation program configures internal load balancing for the **api-int.<cluster\_name>.<base\_domain>** URL; the Premium Tier is required for internal load balancing.

#### 8.11.4.2. Enabling API services in GCP

Your Google Cloud Platform (GCP) project requires access to several API services to complete OpenShift Container Platform installation.

### Prerequisites

- You created a project to host your cluster.

### Procedure

- Enable the following required API services in the project that hosts your cluster. You can also enable optional API services which are not required for installation. See [Enabling services](#) in the GCP documentation.

Table 8.46. Required API services

API service	Console service name
Compute Engine API	<b>compute.googleapis.com</b>
Cloud Resource Manager API	<b>cloudresourcemanager.googleapis.com</b>
Google DNS API	<b>dns.googleapis.com</b>
IAM Service Account Credentials API	<b>iamcredentials.googleapis.com</b>
Identity and Access Management (IAM) API	<b>iam.googleapis.com</b>
Service Usage API	<b>serviceusage.googleapis.com</b>

Table 8.47. Optional API services

API service	Console service name
Cloud Deployment Manager V2 API	<b>deploymentmanager.googleapis.com</b>
Google Cloud APIs	<b>cloudapis.googleapis.com</b>
Service Management API	<b>servicemanagement.googleapis.com</b>
Google Cloud Storage JSON API	<b>storage-api.googleapis.com</b>
Cloud Storage	<b>storage-component.googleapis.com</b>

### 8.11.4.3. GCP account limits

The OpenShift Container Platform cluster uses a number of Google Cloud Platform (GCP) components, but the default [Quotas](#) do not affect your ability to install a default OpenShift Container Platform cluster.

A default cluster, which contains three compute and three control plane machines, uses the following resources. Note that some resources are required only during the bootstrap process and are removed after the cluster deploys.

**Table 8.48. GCP resources used in a default cluster**

Service	Component	Location	Total resources required	Resources removed after bootstrap
Service account	IAM	Global	5	0
Firewall rules	Networking	Global	11	1
Forwarding rules	Compute	Global	2	0
Health checks	Compute	Global	2	0
Images	Compute	Global	1	0
Networks	Networking	Global	1	0
Routers	Networking	Global	1	0
Routes	Networking	Global	2	0
Subnetworks	Compute	Global	2	0
Target pools	Networking	Global	2	0

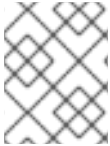
**NOTE**

If any of the quotas are insufficient during installation, the installation program displays an error that states both which quota was exceeded and the region.

Be sure to consider your actual cluster size, planned cluster growth, and any usage from other clusters that are associated with your account. The CPU, static IP addresses, and persistent disk SSD (storage) quotas are the ones that are most likely to be insufficient.

If you plan to deploy your cluster in one of the following regions, you will exceed the maximum storage quota and are likely to exceed the CPU quota limit:

- **asia-east2**
- **asia-northeast2**
- **asia-south1**
- **australia-southeast1**
- **europa-north1**
- **europa-west2**
- **europa-west3**
- **europa-west6**
- **northamerica-northeast1**
- **southamerica-east1**
- **us-west2**

You can increase resource quotas from the [GCP console](#), but you might need to file a support ticket. Be sure to plan your cluster size early so that you can allow time to resolve the support ticket before you install your OpenShift Container Platform cluster.

#### 8.11.4.4. Creating a service account in GCP

OpenShift Container Platform requires a Google Cloud Platform (GCP) service account that provides authentication and authorization to access data in the Google APIs. If you do not have an existing IAM service account that contains the required roles in your project, you must create one.

#### Prerequisites

- You created a project to host your cluster.

#### Procedure

1. Create a service account in the project that you use to host your OpenShift Container Platform cluster. See [Creating a service account](#) in the GCP documentation.
2. Grant the service account the appropriate permissions. You can either grant the individual permissions that follow or assign the **Owner** role to it. See [Granting roles to a service account for specific resources](#).

**NOTE**

While making the service account an owner of the project is the easiest way to gain the required permissions, it means that service account has complete control over the project. You must determine if the risk that comes from offering that power is acceptable.

3. Create the service account key in JSON format. See [Creating service account keys](#) in the GCP documentation.  
The service account key is required to create a cluster.

**8.11.4.4.1. Required GCP roles**

When you attach the **Owner** role to the service account that you create, you grant that service account all permissions, including those that are required to install OpenShift Container Platform. If your organization's security policies require a more restrictive set of permissions, you can create a service account with the following permissions. If you deploy your cluster into an existing virtual private cloud (VPC), the service account does not require certain networking permissions, which are noted in the following lists:

**Required roles for the installation program**

- Compute Admin
- Security Admin
- Service Account Admin
- Service Account Key Admin
- Service Account User
- Storage Admin

**Required roles for creating network resources during installation**

- DNS Administrator

**Required roles for user-provisioned GCP infrastructure**

- Deployment Manager Editor

The roles are applied to the service accounts that the control plane and compute machines use:

**Table 8.49. GCP service account permissions**

Account	Roles
Control Plane	<b>roles/compute.instanceAdmin</b>
	<b>roles/compute.networkAdmin</b>
	<b>roles/compute.securityAdmin</b>

Account	Roles
	<b>roles/storage.admin</b>
	<b>roles/iam.serviceAccountUser</b>
Compute	<b>roles/compute.viewer</b>
	<b>roles/storage.admin</b>

#### 8.11.4.5. Supported GCP regions

You can deploy an OpenShift Container Platform cluster to the following Google Cloud Platform (GCP) regions:

- **asia-east1** (Changhua County, Taiwan)
- **asia-east2** (Hong Kong)
- **asia-northeast1** (Tokyo, Japan)
- **asia-northeast2** (Osaka, Japan)
- **asia-northeast3** (Seoul, South Korea)
- **asia-south1** (Mumbai, India)
- **asia-south2** (Delhi, India)
- **asia-southeast1** (Jurong West, Singapore)
- **asia-southeast2** (Jakarta, Indonesia)
- **australia-southeast1** (Sydney, Australia)
- **australia-southeast2** (Melbourne, Australia)
- **europa-central2** (Warsaw, Poland)
- **europa-north1** (Hamina, Finland)
- **europa-southwest1** (Madrid, Spain)
- **europa-west1** (St. Ghislain, Belgium)
- **europa-west2** (London, England, UK)
- **europa-west3** (Frankfurt, Germany)
- **europa-west4** (Eemshaven, Netherlands)
- **europa-west6** (Zürich, Switzerland)
- **europa-west8** (Milan, Italy)

- **europa-west9** (Paris, France)
- **northamerica-northeast1** (Montréal, Québec, Canada)
- **northamerica-northeast2** (Toronto, Ontario, Canada)
- **southamerica-east1** (São Paulo, Brazil)
- **southamerica-west1** (Santiago, Chile)
- **us-central1** (Council Bluffs, Iowa, USA)
- **us-east1** (Moncks Corner, South Carolina, USA)
- **us-east4** (Ashburn, Northern Virginia, USA)
- **us-east5** (Columbus, Ohio)
- **us-south1** (Dallas, Texas)
- **us-west1** (The Dalles, Oregon, USA)
- **us-west2** (Los Angeles, California, USA)
- **us-west3** (Salt Lake City, Utah, USA)
- **us-west4** (Las Vegas, Nevada, USA)

#### 8.11.4.6. Installing and configuring CLI tools for GCP

To install OpenShift Container Platform on Google Cloud Platform (GCP) using user-provisioned infrastructure, you must install and configure the CLI tools for GCP.

##### Prerequisites

- You created a project to host your cluster.
- You created a service account and granted it the required permissions.

##### Procedure

1. Install the following binaries in **\$PATH**:

- **gcloud**
- **gsutil**

See [Install the latest Cloud SDK version](#) in the GCP documentation.

2. Authenticate using the **gcloud** tool with your configured service account.  
See [Authorizing with a service account](#) in the GCP documentation.

#### 8.11.5. Requirements for a cluster with user-provisioned infrastructure

For a cluster that contains user-provisioned infrastructure, you must deploy all of the required machines.



This section describes the requirements for deploying OpenShift Container Platform on user-provisioned infrastructure.

### 8.11.5.1. Required machines for cluster installation

The smallest OpenShift Container Platform clusters require the following hosts:

**Table 8.50. Minimum required hosts**

Hosts	Description
One temporary bootstrap machine	The cluster requires the bootstrap machine to deploy the OpenShift Container Platform cluster on the three control plane machines. You can remove the bootstrap machine after you install the cluster.
Three control plane machines	The control plane machines run the Kubernetes and OpenShift Container Platform services that form the control plane.
At least two compute machines, which are also known as worker machines.	The workloads requested by OpenShift Container Platform users run on the compute machines.

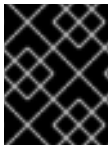

#### IMPORTANT

To maintain high availability of your cluster, use separate physical hosts for these cluster machines.

The bootstrap and control plane machines must use Red Hat Enterprise Linux CoreOS (RHCOS) as the operating system. However, the compute machines can choose between Red Hat Enterprise Linux CoreOS (RHCOS), Red Hat Enterprise Linux (RHEL) 8.4, or RHEL 8.5.

Note that RHCOS is based on Red Hat Enterprise Linux (RHEL) 8 and inherits all of its hardware certifications and requirements. See [Red Hat Enterprise Linux technology capabilities and limits](#).

### 8.11.5.2. Minimum resource requirements for cluster installation

Each cluster machine must meet the following minimum requirements:

**Table 8.51. Minimum resource requirements**

Machine	Operating System	vCPU [1]	Virtual RAM	Storage	IOPS [2]
Bootstrap	RHCOS	4	16 GB	100 GB	300
Control plane	RHCOS	4	16 GB	100 GB	300
Compute	RHCOS, RHEL 8.4, or RHEL 8.5 [3]	2	8 GB	100 GB	300

1. One vCPU is equivalent to one physical core when simultaneous multithreading (SMT), or hyperthreading, is not enabled. When enabled, use the following formula to calculate the corresponding ratio:  $(\text{threads per core} \times \text{cores}) \times \text{sockets} = \text{vCPUs}$ .
2. OpenShift Container Platform and Kubernetes are sensitive to disk performance, and faster storage is recommended, particularly for etcd on the control plane nodes which require a 10 ms p99 fsync duration. Note that on many cloud platforms, storage size and IOPS scale together, so you might need to over-allocate storage volume to obtain sufficient performance.
3. As with all user-provisioned installations, if you choose to use RHEL compute machines in your cluster, you take responsibility for all operating system life cycle management and maintenance, including performing system updates, applying patches, and completing all other required tasks. Use of RHEL 7 compute machines is deprecated and has been removed in OpenShift Container Platform 4.10 and later.

If an instance type for your platform meets the minimum requirements for cluster machines, it is supported to use in OpenShift Container Platform.

### 8.11.5.3. Tested instance types for GCP

The following Google Cloud Platform instance types have been tested with OpenShift Container Platform.

#### Example 8.58. Machine series

- C2
- C2D
- C3
- E2
- M1
- N1
- N2
- N2D
- Tau T2D

### 8.11.5.4. Using custom machine types

Using a custom machine type to install a OpenShift Container Platform cluster is supported.

Consider the following when using a custom machine type:

- Similar to predefined instance types, custom machine types must meet the minimum resource requirements for control plane and compute machines. For more information, see "Minimum resource requirements for cluster installation".
- The name of the custom machine type must adhere to the following syntax:  
**custom-`<number_of_cpus>`-`<amount_of_memory_in_mb>`**

For example, **custom-6-20480**.

### 8.11.6. Configuring the GCP project that hosts your shared VPC network

If you use a shared Virtual Private Cloud (VPC) to host your OpenShift Container Platform cluster in Google Cloud Platform (GCP), you must configure the project that hosts it.



#### NOTE

If you already have a project that hosts the shared VPC network, review this section to ensure that the project meets all of the requirements to install an OpenShift Container Platform cluster.

#### Procedure

1. Create a project to host the shared VPC for your OpenShift Container Platform cluster. See [Creating and Managing Projects](#) in the GCP documentation.
2. Create a service account in the project that hosts your shared VPC. See [Creating a service account](#) in the GCP documentation.
3. Grant the service account the appropriate permissions. You can either grant the individual permissions that follow or assign the **Owner** role to it. See [Granting roles to a service account for specific resources](#).



#### NOTE

While making the service account an owner of the project is the easiest way to gain the required permissions, it means that service account has complete control over the project. You must determine if the risk that comes from offering that power is acceptable.

The service account for the project that hosts the shared VPC network requires the following roles:

- Compute Network User
- Compute Security Admin
- Deployment Manager Editor
- DNS Administrator
- Security Admin
- Network Management Admin

#### 8.11.6.1. Configuring DNS for GCP

To install OpenShift Container Platform, the Google Cloud Platform (GCP) account you use must have a dedicated public hosted zone in the project that hosts the shared VPC that you install the cluster into. This zone must be authoritative for the domain. The DNS service provides cluster DNS resolution and name lookup for external connections to the cluster.

#### Procedure

1. Identify your domain, or subdomain, and registrar. You can transfer an existing domain and registrar or obtain a new one through GCP or another source.

**NOTE**

If you purchase a new domain, it can take time for the relevant DNS changes to propagate. For more information about purchasing domains through Google, see [Google Domains](#).

2. Create a public hosted zone for your domain or subdomain in your GCP project. See [Creating public zones](#) in the GCP documentation. Use an appropriate root domain, such as **openshiftcorp.com**, or subdomain, such as **clusters.openshiftcorp.com**.
3. Extract the new authoritative name servers from the hosted zone records. See [Look up your Cloud DNS name servers](#) in the GCP documentation. You typically have four name servers.
4. Update the registrar records for the name servers that your domain uses. For example, if you registered your domain to Google Domains, see the following topic in the Google Domains Help: [How to switch to custom name servers](#).
5. If you migrated your root domain to Google Cloud DNS, migrate your DNS records. See [Migrating to Cloud DNS](#) in the GCP documentation.
6. If you use a subdomain, follow your company's procedures to add its delegation records to the parent domain. This process might include a request to your company's IT department or the division that controls the root domain and DNS services for your company.

**8.11.6.2. Creating a VPC in GCP**

You must create a VPC in Google Cloud Platform (GCP) for your OpenShift Container Platform cluster to use. You can customize the VPC to meet your requirements. One way to create the VPC is to modify the provided Deployment Manager template.

**NOTE**

If you do not use the provided Deployment Manager template to create your GCP infrastructure, you must review the provided information and manually create the infrastructure. If your cluster does not initialize correctly, you might have to contact Red Hat support with your installation logs.

**Prerequisites**

- Configure a GCP account.

**Procedure**

1. Copy the template from the **Deployment Manager template for the VPC** section of this topic and save it as **01\_vpc.py** on your computer. This template describes the VPC that your cluster requires.
2. Export the following variables required by the resource definition:
  - a. Export the control plane CIDR:

```
$ export MASTER_SUBNET_CIDR='10.0.0.0/17'
```

- b. Export the compute CIDR:

```
$ export WORKER_SUBNET_CIDR='10.0.128.0/17'
```

- c. Export the region to deploy the VPC network and cluster to:

```
$ export REGION='<region>'
```

3. Export the variable for the ID of the project that hosts the shared VPC:

```
$ export HOST_PROJECT=<host_project>
```

4. Export the variable for the email of the service account that belongs to host project:

```
$ export HOST_PROJECT_ACCOUNT=<host_service_account_email>
```

5. Create a **01\_vpc.yaml** resource definition file:

```
$ cat <<EOF >01_vpc.yaml
imports:
- path: 01_vpc.py

resources:
- name: cluster-vpc
  type: 01_vpc.py
  properties:
    infra_id: '<prefix>' 1
    region: '${REGION}' 2
    master_subnet_cidr: '${MASTER_SUBNET_CIDR}' 3
    worker_subnet_cidr: '${WORKER_SUBNET_CIDR}' 4
EOF
```

- 1 **infra\_id** is the prefix of the network name.
- 2 **region** is the region to deploy the cluster into, for example **us-central1**.
- 3 **master\_subnet\_cidr** is the CIDR for the master subnet, for example **10.0.0.0/17**.
- 4 **worker\_subnet\_cidr** is the CIDR for the worker subnet, for example **10.0.128.0/17**.

6. Create the deployment by using the **gcloud** CLI:

```
$ gcloud deployment-manager deployments create <vpc_deployment_name> --config
01_vpc.yaml --project ${HOST_PROJECT} --account ${HOST_PROJECT_ACCOUNT} 1
```

- 1 For **<vpc\_deployment\_name>**, specify the name of the VPC to deploy.

7. Export the VPC variable that other components require:

- a. Export the name of the host project network:

```

-----

```

```

$ export HOST_PROJECT_NETWORK=<vpc_network>

```

- b. Export the name of the host project control plane subnet:

```

$ export HOST_PROJECT_CONTROL_SUBNET=<control_plane_subnet>

```

- c. Export the name of the host project compute subnet:

```

$ export HOST_PROJECT_COMPUTE_SUBNET=<compute_subnet>

```

8. Set up the shared VPC. See [Setting up Shared VPC](#) in the GCP documentation.

### 8.11.6.2.1. Deployment Manager template for the VPC

You can use the following Deployment Manager template to deploy the VPC that you need for your OpenShift Container Platform cluster:

#### Example 8.59. 01\_vpc.py Deployment Manager template

```

def GenerateConfig(context):

    resources = [{
        'name': context.properties['infra_id'] + '-network',
        'type': 'compute.v1.network',
        'properties': {
            'region': context.properties['region'],
            'autoCreateSubnetworks': False
        }
    }, {
        'name': context.properties['infra_id'] + '-master-subnet',
        'type': 'compute.v1.subnetwork',
        'properties': {
            'region': context.properties['region'],
            'network': '$(ref.' + context.properties['infra_id'] + '-network.selfLink)',
            'ipCidrRange': context.properties['master_subnet_cidr']
        }
    }, {
        'name': context.properties['infra_id'] + '-worker-subnet',
        'type': 'compute.v1.subnetwork',
        'properties': {
            'region': context.properties['region'],
            'network': '$(ref.' + context.properties['infra_id'] + '-network.selfLink)',
            'ipCidrRange': context.properties['worker_subnet_cidr']
        }
    }, {
        'name': context.properties['infra_id'] + '-router',
        'type': 'compute.v1.router',
        'properties': {
            'region': context.properties['region'],
            'network': '$(ref.' + context.properties['infra_id'] + '-network.selfLink)',
            'nats': [{
                'name': context.properties['infra_id'] + '-nat-master',
                'natIpAllocateOption': 'AUTO_ONLY',

```

```

        'minPortsPerVm': 7168,
        'sourceSubnetworkIpRangesToNat': 'LIST_OF_SUBNETWORKS',
        'subnetworks': [{
            'name': '${ref.' + context.properties['infra_id'] + '-master-subnet.selfLink)',
            'sourceIpRangesToNat': ['ALL_IP_RANGES']
        }]
    }, {
        'name': context.properties['infra_id'] + '-nat-worker',
        'natIpAllocateOption': 'AUTO_ONLY',
        'minPortsPerVm': 512,
        'sourceSubnetworkIpRangesToNat': 'LIST_OF_SUBNETWORKS',
        'subnetworks': [{
            'name': '${ref.' + context.properties['infra_id'] + '-worker-subnet.selfLink)',
            'sourceIpRangesToNat': ['ALL_IP_RANGES']
        }]
    }
}
]]
}
}

return {'resources': resources}

```

### 8.11.7. Creating the installation files for GCP

To install OpenShift Container Platform on Google Cloud Platform (GCP) using user-provisioned infrastructure, you must generate the files that the installation program needs to deploy your cluster and modify them so that the cluster creates only the machines that it will use. You generate and customize the **install-config.yaml** file, Kubernetes manifests, and Ignition config files. You also have the option to first set up a separate **var** partition during the preparation phases of installation.

#### 8.11.7.1. Manually creating the installation configuration file

For user-provisioned installations of OpenShift Container Platform, you manually generate your installation configuration file.

#### Prerequisites

- You have an SSH public key on your local machine to provide to the installation program. The key will be used for SSH authentication onto your cluster nodes for debugging and disaster recovery.
- You have obtained the OpenShift Container Platform installation program and the pull secret for your cluster.

#### Procedure

1. Create an installation directory to store your required installation assets in:

```
$ mkdir <installation_directory>
```

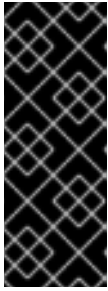
**IMPORTANT**

You must create a directory. Some installation assets, like bootstrap X.509 certificates have short expiration intervals, so you must not reuse an installation directory. If you want to reuse individual files from another cluster installation, you can copy them into your directory. However, the file names for the installation assets might change between releases. Use caution when copying installation files from an earlier OpenShift Container Platform version.

2. Customize the sample **install-config.yaml** file template that is provided and save it in the **<installation\_directory>**.

**NOTE**

You must name this configuration file **install-config.yaml**.

**NOTE**

For some platform types, you can alternatively run **./openshift-install create install-config --dir <installation\_directory>** to generate an **install-config.yaml** file. You can provide details about your cluster configuration at the prompts.

3. Back up the **install-config.yaml** file so that you can use it to install multiple clusters.

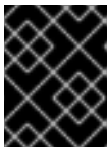
**IMPORTANT**

The **install-config.yaml** file is consumed during the next step of the installation process. You must back it up now.

**8.11.7.2. Sample customized install-config.yaml file for GCP**

You can customize the **install-config.yaml** file to specify more details about your OpenShift Container Platform cluster's platform or modify the values of the required parameters.

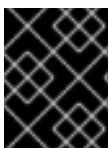
**IMPORTANT**

This sample YAML file is provided for reference only. You must obtain your **install-config.yaml** file by using the installation program and modify it.

```
apiVersion: v1
baseDomain: example.com ①
controlPlane: ②
hyperthreading: Enabled ③ ④
name: master
platform:
  gcp:
    type: n2-standard-4
    zones:
      - us-central1-a
      - us-central1-c
replicas: 3
compute: ⑤
```



```

- hyperthreading: Enabled 6
  name: worker
  platform:
    gcp:
      type: n2-standard-4
      zones:
        - us-central1-a
        - us-central1-c
    replicas: 0
  metadata:
    name: test-cluster
  networking:
    clusterNetwork:
      - cidr: 10.128.0.0/14
        hostPrefix: 23
    machineNetwork:
      - cidr: 10.0.0.0/16
    networkType: OpenShiftSDN
    serviceNetwork:
      - 172.30.0.0/16
  platform:
    gcp:
      projectID: openshift-production 7
      region: us-central1 8
  pullSecret: '{"auths": ...}'
  fips: false 9
  sshKey: ssh-ed25519 AAAA... 10
  publish: Internal 11

```

- 1 Specify the public DNS on the host project.
- 2 5 If you do not provide these parameters and values, the installation program provides the default value.
- 3 6 The **controlPlane** section is a single mapping, but the compute section is a sequence of mappings. To meet the requirements of the different data structures, the first line of the **compute** section must begin with a hyphen, -, and the first line of the **controlPlane** section must not. Although both sections currently define a single machine pool, it is possible that future versions of OpenShift Container Platform will support defining multiple compute pools during installation. Only one control plane pool is used.
- 4 Whether to enable or disable simultaneous multithreading, or **hyperthreading**. By default, simultaneous multithreading is enabled to increase the performance of your machines' cores. You can disable it by setting the parameter value to **Disabled**. If you disable simultaneous multithreading in some cluster machines, you must disable it in all cluster machines.



### IMPORTANT

If you disable simultaneous multithreading, ensure that your capacity planning accounts for the dramatically decreased machine performance. Use larger machine types, such as **n1-standard-8**, for your machines if you disable simultaneous multithreading.

- 7 Specify the main project where the VM instances reside.

- 8 Specify the region that your VPC network is in.
- 9 Whether to enable or disable FIPS mode. By default, FIPS mode is not enabled. If FIPS mode is enabled, the Red Hat Enterprise Linux CoreOS (RHCOS) machines that OpenShift Container Platform runs on bypass the default Kubernetes cryptography suite and use the cryptography modules that are provided with RHCOS instead.



### IMPORTANT

The use of FIPS validated or Modules In Progress cryptographic libraries is only supported on OpenShift Container Platform deployments on the **x86\_64** architecture.

- 10 You can optionally provide the **sshKey** value that you use to access the machines in your cluster.



### NOTE

For production OpenShift Container Platform clusters on which you want to perform installation debugging or disaster recovery, specify an SSH key that your **ssh-agent** process uses.

- 11 How to publish the user-facing endpoints of your cluster. Set **publish** to **Internal** to deploy a private cluster, which cannot be accessed from the internet. The default value is **External**. To use a shared VPC in a cluster that uses infrastructure that you provision, you must set **publish** to **Internal**. The installation program will no longer be able to access the public DNS zone for the base domain in the host project.

### 8.11.7.3. Configuring the cluster-wide proxy during installation

Production environments can deny direct access to the internet and instead have an HTTP or HTTPS proxy available. You can configure a new OpenShift Container Platform cluster to use a proxy by configuring the proxy settings in the **install-config.yaml** file.

#### Prerequisites

- You have an existing **install-config.yaml** file.
- You reviewed the sites that your cluster requires access to and determined whether any of them need to bypass the proxy. By default, all cluster egress traffic is proxied, including calls to hosting cloud provider APIs. You added sites to the **Proxy** object's **spec.noProxy** field to bypass the proxy if necessary.



### NOTE

The **Proxy** object **status.noProxy** field is populated with the values of the **networking.machineNetwork[].cidr**, **networking.clusterNetwork[].cidr**, and **networking.serviceNetwork[]** fields from your installation configuration.

For installations on Amazon Web Services (AWS), Google Cloud Platform (GCP), Microsoft Azure, and Red Hat OpenStack Platform (RHOSP), the **Proxy** object **status.noProxy** field is also populated with the instance metadata endpoint (**169.254.169.254**).

## Procedure

1. Edit your **install-config.yaml** file and add the proxy settings. For example:

```

apiVersion: v1
baseDomain: my.domain.com
proxy:
  httpProxy: http://<username>:<pswd>@<ip>:<port> 1
  httpsProxy: https://<username>:<pswd>@<ip>:<port> 2
  noProxy: example.com 3
  additionalTrustBundle: | 4
    -----BEGIN CERTIFICATE-----
    <MY_TRUSTED_CA_CERT>
    -----END CERTIFICATE-----
...

```

- 1 A proxy URL to use for creating HTTP connections outside the cluster. The URL scheme must be **http**.
- 2 A proxy URL to use for creating HTTPS connections outside the cluster.
- 3 A comma-separated list of destination domain names, IP addresses, or other network CIDRs to exclude from proxying. Preface a domain with **.** to match subdomains only. For example, **.y.com** matches **x.y.com**, but not **y.com**. Use **\*** to bypass the proxy for all destinations.
- 4 If provided, the installation program generates a config map that is named **user-ca-bundle** in the **openshift-config** namespace that contains one or more additional CA certificates that are required for proxying HTTPS connections. The Cluster Network Operator then creates a **trusted-ca-bundle** config map that merges these contents with the Red Hat Enterprise Linux CoreOS (RHCOS) trust bundle, and this config map is referenced in the **trustedCA** field of the **Proxy** object. The **additionalTrustBundle** field is required unless the proxy's identity certificate is signed by an authority from the RHCOS trust bundle.



### NOTE

The installation program does not support the proxy **readinessEndpoints** field.

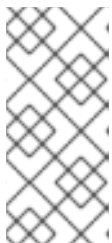

### NOTE

If the installer times out, restart and then complete the deployment by using the **wait-for** command of the installer. For example:

```
$ ./openshift-install wait-for install-complete --log-level debug
```

2. Save the file and reference it when installing OpenShift Container Platform.

The installation program creates a cluster-wide proxy that is named **cluster** that uses the proxy settings in the provided **install-config.yaml** file. If no proxy settings are provided, a **cluster Proxy** object is still created, but it will have a nil **spec**.

**NOTE**

Only the **Proxy** object named **cluster** is supported, and no additional proxies can be created.

**8.11.7.4. Creating the Kubernetes manifest and Ignition config files**

Because you must modify some cluster definition files and manually start the cluster machines, you must generate the Kubernetes manifest and Ignition config files that the cluster needs to configure the machines.

The installation configuration file transforms into the Kubernetes manifests. The manifests wrap into the Ignition configuration files, which are later used to configure the cluster machines.

**IMPORTANT**

- The Ignition config files that the OpenShift Container Platform installation program generates contain certificates that expire after 24 hours, which are then renewed at that time. If the cluster is shut down before renewing the certificates and the cluster is later restarted after the 24 hours have elapsed, the cluster automatically recovers the expired certificates. The exception is that you must manually approve the pending **node-bootstrapper** certificate signing requests (CSRs) to recover kubelet certificates. See the documentation for *Recovering from expired control plane certificates* for more information.
- It is recommended that you use Ignition config files within 12 hours after they are generated because the 24-hour certificate rotates from 16 to 22 hours after the cluster is installed. By using the Ignition config files within 12 hours, you can avoid installation failure if the certificate update runs during installation.

**Prerequisites**

- You obtained the OpenShift Container Platform installation program.
- You created the **install-config.yaml** installation configuration file.

**Procedure**

1. Change to the directory that contains the OpenShift Container Platform installation program and generate the Kubernetes manifests for the cluster:

```
$ ./openshift-install create manifests --dir <installation_directory> 1
```

- 1** For **<installation\_directory>**, specify the installation directory that contains the **install-config.yaml** file you created.

2. Remove the Kubernetes manifest files that define the control plane machines:

```
$ rm -f <installation_directory>/openshift/99_openshift-cluster-api_master-machines-*.yaml
```

By removing these files, you prevent the cluster from automatically generating control plane machines.

3. Remove the Kubernetes manifest files that define the worker machines:

```
$ rm -f <installation_directory>/openshift/99_openshift-cluster-api_worker-machineset-*.yaml
```

Because you create and manage the worker machines yourself, you do not need to initialize these machines.

4. Check that the **mastersSchedulable** parameter in the **<installation\_directory>/manifests/cluster-scheduler-02-config.yml** Kubernetes manifest file is set to **false**. This setting prevents pods from being scheduled on the control plane machines:
  - a. Open the **<installation\_directory>/manifests/cluster-scheduler-02-config.yml** file.
  - b. Locate the **mastersSchedulable** parameter and ensure that it is set to **false**.
  - c. Save and exit the file.
5. Remove the **privateZone** sections from the **<installation\_directory>/manifests/cluster-dns-02-config.yml** DNS configuration file:

```
apiVersion: config.openshift.io/v1
kind: DNS
metadata:
  creationTimestamp: null
  name: cluster
spec:
  baseDomain: example.openshift.com
  privateZone: ❶
    id: mycluster-100419-private-zone
  status: {}
```

- ❶ Remove this section completely.

6. Configure the cloud provider for your VPC.
  - a. Open the **<installation\_directory>/manifests/cloud-provider-config.yaml** file.
  - b. Add the **network-project-id** parameter and set its value to the ID of project that hosts the shared VPC network.
  - c. Add the **network-name** parameter and set its value to the name of the shared VPC network that hosts the OpenShift Container Platform cluster.
  - d. Replace the value of the **subnet-name** parameter with the value of the shared VPC subnet that hosts your compute machines.

The contents of the **<installation\_directory>/manifests/cloud-provider-config.yaml** resemble the following example:

```
config: |+
  [global]
  project-id = example-project
  regional  = true
  multizone  = true
  node-tags  = opensh-ptzxx-master
  node-tags  = opensh-ptzxx-worker
```

```
node-instance-prefix = opensh-ptzzx
external-instance-groups-prefix = opensh-ptzzx
network-project-id = example-shared-vpc
network-name = example-network
subnetwork-name = example-worker-subnet
```

- If you deploy a cluster that is not on a private network, open the `<installation_directory>/manifests/cluster-ingress-default-ingresscontroller.yaml` file and replace the value of the `scope` parameter with `External`. The contents of the file resemble the following example:

```
apiVersion: operator.openshift.io/v1
kind: IngressController
metadata:
  creationTimestamp: null
  name: default
  namespace: openshift-ingress-operator
spec:
  endpointPublishingStrategy:
    loadBalancer:
      scope: External
      type: LoadBalancerService
status:
  availableReplicas: 0
  domain: ""
  selector: ""
```

- To create the Ignition configuration files, run the following command from the directory that contains the installation program:

```
$ ./openshift-install create ignition-configs --dir <installation_directory> 1
```

- For `<installation_directory>`, specify the same installation directory.

Ignition config files are created for the bootstrap, control plane, and compute nodes in the installation directory. The `kubeadmin-password` and `kubeconfig` files are created in the `./<installation_directory>/auth` directory:

```
.
├── auth
│   ├── kubeadmin-password
│   └── kubeconfig
├── bootstrap.ign
├── master.ign
├── metadata.json
└── worker.ign
```

## 8.11.8. Exporting common variables

### 8.11.8.1. Extracting the infrastructure name

The Ignition config files contain a unique cluster identifier that you can use to uniquely identify your cluster in Google Cloud Platform (GCP). The infrastructure name is also used to locate the appropriate

GCP resources during an OpenShift Container Platform installation. The provided Deployment Manager templates contain references to this infrastructure name, so you must extract it.

### Prerequisites

- You obtained the OpenShift Container Platform installation program and the pull secret for your cluster.
- You generated the Ignition config files for your cluster.
- You installed the **jq** package.

### Procedure

- To extract and view the infrastructure name from the Ignition config file metadata, run the following command:

```
$ jq -r .infraID <installation_directory>/metadata.json 1
```

- 1 For **<installation\_directory>**, specify the path to the directory that you stored the installation files in.

### Example output

```
openshift-vw9j6 1
```

- 1 The output of this command is your cluster name and a random string.

#### 8.11.8.2. Exporting common variables for Deployment Manager templates

You must export a common set of variables that are used with the provided Deployment Manager templates used to assist in completing a user-provided infrastructure install on Google Cloud Platform (GCP).



#### NOTE

Specific Deployment Manager templates can also require additional exported variables, which are detailed in their related procedures.

### Prerequisites

- Obtain the OpenShift Container Platform installation program and the pull secret for your cluster.
- Generate the Ignition config files for your cluster.
- Install the **jq** package.

### Procedure

1. Export the following common variables to be used by the provided Deployment Manager templates:

```

$ export BASE_DOMAIN='<base_domain>' 1
$ export BASE_DOMAIN_ZONE_NAME='<base_domain_zone_name>' 2
$ export NETWORK_CIDR='10.0.0.0/16'

$ export KUBECONFIG=<installation_directory>/auth/kubeconfig 3
$ export CLUSTER_NAME=`jq -r .clusterName <installation_directory>/metadata.json`
$ export INFRA_ID=`jq -r .infraID <installation_directory>/metadata.json`
$ export PROJECT_NAME=`jq -r .gcp.projectID <installation_directory>/metadata.json`

```

- 1 2 Supply the values for the host project.
- 3 For **<installation\_directory>**, specify the path to the directory that you stored the installation files in.

## 8.11.9. Networking requirements for user-provisioned infrastructure

All the Red Hat Enterprise Linux CoreOS (RHCOS) machines require networking to be configured in **initramfs** during boot to fetch their Ignition config files.

### 8.11.9.1. Setting the cluster node hostnames through DHCP

On Red Hat Enterprise Linux CoreOS (RHCOS) machines, the hostname is set through NetworkManager. By default, the machines obtain their hostname through DHCP. If the hostname is not provided by DHCP, set statically through kernel arguments, or another method, it is obtained through a reverse DNS lookup. Reverse DNS lookup occurs after the network has been initialized on a node and can take time to resolve. Other system services can start prior to this and detect the hostname as **localhost** or similar. You can avoid this by using DHCP to provide the hostname for each cluster node.

Additionally, setting the hostnames through DHCP can bypass any manual DNS record name configuration errors in environments that have a DNS split-horizon implementation.

### 8.11.9.2. Network connectivity requirements

You must configure the network connectivity between machines to allow OpenShift Container Platform cluster components to communicate. Each machine must be able to resolve the hostnames of all other machines in the cluster.

This section provides details about the ports that are required.



#### IMPORTANT

In connected OpenShift Container Platform environments, all nodes are required to have internet access to pull images for platform containers and provide telemetry data to Red Hat.

Table 8.52. Ports used for all-machine to all-machine communications

Protocol	Port	Description
ICMP	N/A	Network reachability tests



Protocol	Port	Description
TCP	<b>1936</b>	Metrics
	<b>9000-9999</b>	Host level services, including the node exporter on ports <b>9100-9101</b> and the Cluster Version Operator on port <b>9099</b> .
	<b>10250-10259</b>	The default ports that Kubernetes reserves
	<b>10256</b>	openshift-sdn
UDP	<b>4789</b>	VXLAN
	<b>6081</b>	Geneve
	<b>9000-9999</b>	Host level services, including the node exporter on ports <b>9100-9101</b> .
	<b>500</b>	IPsec IKE packets
	<b>4500</b>	IPsec NAT-T packets
TCP/UDP	<b>30000-32767</b>	Kubernetes node port
ESP	N/A	IPsec Encapsulating Security Payload (ESP)

Table 8.53. Ports used for all-machine to control plane communications

Protocol	Port	Description
TCP	<b>6443</b>	Kubernetes API

Table 8.54. Ports used for control plane machine to control plane machine communications

Protocol	Port	Description
TCP	<b>2379-2380</b>	etcd server and peer ports

### 8.11.10. Creating load balancers in GCP

You must configure load balancers in Google Cloud Platform (GCP) for your OpenShift Container Platform cluster to use. One way to create these components is to modify the provided Deployment Manager template.



## NOTE

If you do not use the provided Deployment Manager template to create your GCP infrastructure, you must review the provided information and manually create the infrastructure. If your cluster does not initialize correctly, you might have to contact Red Hat support with your installation logs.

## Prerequisites

- Configure a GCP account.
- Generate the Ignition config files for your cluster.
- Create and configure a VPC and associated subnets in GCP.

## Procedure

1. Copy the template from the **Deployment Manager template for the internal load balancer** section of this topic and save it as **02\_lb\_int.py** on your computer. This template describes the internal load balancing objects that your cluster requires.
2. For an external cluster, also copy the template from the **Deployment Manager template for the external load balancer** section of this topic and save it as **02\_lb\_ext.py** on your computer. This template describes the external load balancing objects that your cluster requires.
3. Export the variables that the deployment template uses:

- a. Export the cluster network location:

```
$ export CLUSTER_NETWORK=(`gcloud compute networks describe
${HOST_PROJECT_NETWORK} --project ${HOST_PROJECT} --account
${HOST_PROJECT_ACCOUNT} --format json | jq -r .selfLink`)
```

- b. Export the control plane subnet location:

```
$ export CONTROL_SUBNET=(`gcloud compute networks subnets describe
${HOST_PROJECT_CONTROL_SUBNET} --region=${REGION} --project
${HOST_PROJECT} --account ${HOST_PROJECT_ACCOUNT} --format json | jq -r
.selfLink`)
```

- c. Export the three zones that the cluster uses:

```
$ export ZONE_0=(`gcloud compute regions describe ${REGION} --format=json | jq -r
.zones[0] | cut -d "/" -f9`)
```

```
$ export ZONE_1=(`gcloud compute regions describe ${REGION} --format=json | jq -r
.zones[1] | cut -d "/" -f9`)
```

```
$ export ZONE_2=(`gcloud compute regions describe ${REGION} --format=json | jq -r
.zones[2] | cut -d "/" -f9`)
```

4. Create a **02\_infra.yaml** resource definition file:

```
$ cat <<EOF >02_infra.yaml
```

```

imports:
- path: 02_lb_ext.py
- path: 02_lb_int.py ❶
resources:
- name: cluster-lb-ext ❷
  type: 02_lb_ext.py
  properties:
    infra_id: '${INFRA_ID}' ❸
    region: '${REGION}' ❹
- name: cluster-lb-int
  type: 02_lb_int.py
  properties:
    cluster_network: '${CLUSTER_NETWORK}'
    control_subnet: '${CONTROL_SUBNET}' ❺
    infra_id: '${INFRA_ID}'
    region: '${REGION}'
    zones: ❻
    - '${ZONE_0}'
    - '${ZONE_1}'
    - '${ZONE_2}'
EOF

```

❶ ❷ Required only when deploying an external cluster.

❸ **infra\_id** is the **INFRA\_ID** infrastructure name from the extraction step.

❹ **region** is the region to deploy the cluster into, for example **us-central1**.

❺ **control\_subnet** is the URI to the control subnet.

❻ **zones** are the zones to deploy the control plane instances into, like **us-east1-b**, **us-east1-c**, and **us-east1-d**.

5. Create the deployment by using the **gcloud** CLI:

```
$ gcloud deployment-manager deployments create ${INFRA_ID}-infra --config 02_infra.yaml
```

6. Export the cluster IP address:

```
$ export CLUSTER_IP=$(gcloud compute addresses describe ${INFRA_ID}-cluster-ip --
region=${REGION} --format json | jq -r .address)
```

7. For an external cluster, also export the cluster public IP address:

```
$ export CLUSTER_PUBLIC_IP=$(gcloud compute addresses describe ${INFRA_ID}-cluster-
public-ip --region=${REGION} --format json | jq -r .address)
```

### 8.11.10.1. Deployment Manager template for the external load balancer

You can use the following Deployment Manager template to deploy the external load balancer that you need for your OpenShift Container Platform cluster:

**Example 8.60. 02\_lb\_ext.py Deployment Manager template**

```
def GenerateConfig(context):
```

```

resources = [
    'name': context.properties['infra_id'] + '-cluster-public-ip',
    'type': 'compute.v1.address',
    'properties': {
        'region': context.properties['region']
    }
], {
    # Refer to docs/dev/kube-apiserver-health-check.md on how to correctly setup health check
    # probe for kube-apiserver
    'name': context.properties['infra_id'] + '-api-http-health-check',
    'type': 'compute.v1.httpHealthCheck',
    'properties': {
        'port': 6080,
        'requestPath': '/readyz'
    }
}, {
    'name': context.properties['infra_id'] + '-api-target-pool',
    'type': 'compute.v1.targetPool',
    'properties': {
        'region': context.properties['region'],
        'healthChecks': ['$$(ref.' + context.properties['infra_id'] + '-api-http-health-check.selfLink)'],
        'instances': []
    }
}, {
    'name': context.properties['infra_id'] + '-api-forwarding-rule',
    'type': 'compute.v1.forwardingRule',
    'properties': {
        'region': context.properties['region'],
        'IPAddress': '$$(ref.' + context.properties['infra_id'] + '-cluster-public-ip.selfLink)',
        'target': '$$(ref.' + context.properties['infra_id'] + '-api-target-pool.selfLink)',
        'portRange': '6443'
    }
}
]

return {'resources': resources}

```

### 8.11.10.2. Deployment Manager template for the internal load balancer

You can use the following Deployment Manager template to deploy the internal load balancer that you need for your OpenShift Container Platform cluster:

#### Example 8.61. 02\_lb\_int.py Deployment Manager template

```
def GenerateConfig(context):
```

```

backends = []
for zone in context.properties['zones']:
    backends.append({
        'group': '$(ref.' + context.properties['infra_id'] + '-master-' + zone + '-ig' + '.selfLink)'
    })

```

```

resources = [{
  'name': context.properties['infra_id'] + '-cluster-ip',
  'type': 'compute.v1.address',
  'properties': {
    'addressType': 'INTERNAL',
    'region': context.properties['region'],
    'subnetwork': context.properties['control_subnet']
  }
}, {
  # Refer to docs/dev/kube-apiserver-health-check.md on how to correctly setup health check
  # probe for kube-apiserver
  'name': context.properties['infra_id'] + '-api-internal-health-check',
  'type': 'compute.v1.healthCheck',
  'properties': {
    'httpsHealthCheck': {
      'port': 6443,
      'requestPath': '/readyz'
    },
    'type': "HTTPS"
  }
}, {
  'name': context.properties['infra_id'] + '-api-internal-backend-service',
  'type': 'compute.v1.regionBackendService',
  'properties': {
    'backends': backends,
    'healthChecks': ['$(ref.' + context.properties['infra_id'] + '-api-internal-health-
check.selfLink)'],
    'loadBalancingScheme': 'INTERNAL',
    'region': context.properties['region'],
    'protocol': 'TCP',
    'timeoutSec': 120
  }
}, {
  'name': context.properties['infra_id'] + '-api-internal-forwarding-rule',
  'type': 'compute.v1.forwardingRule',
  'properties': {
    'backendService': '$(ref.' + context.properties['infra_id'] + '-api-internal-backend-
service.selfLink)',
    'IPAddress': '$(ref.' + context.properties['infra_id'] + '-cluster-ip.selfLink)',
    'loadBalancingScheme': 'INTERNAL',
    'ports': ['6443','22623'],
    'region': context.properties['region'],
    'subnetwork': context.properties['control_subnet']
  }
}
]]

for zone in context.properties['zones']:
  resources.append({
    'name': context.properties['infra_id'] + '-master-' + zone + '-ig',
    'type': 'compute.v1.instanceGroup',
    'properties': {
      'namedPorts': [
        {
          'name': 'ignition',
          'port': 22623
        }, {

```

```

        'name': 'https',
        'port': 6443
    }
],
'network': context.properties['cluster_network'],
'zone': zone
}
})

return {'resources': resources}

```

You will need this template in addition to the **02\_lb\_ext.py** template when you create an external cluster.

### 8.11.11. Creating a private DNS zone in GCP

You must configure a private DNS zone in Google Cloud Platform (GCP) for your OpenShift Container Platform cluster to use. One way to create this component is to modify the provided Deployment Manager template.



#### NOTE

If you do not use the provided Deployment Manager template to create your GCP infrastructure, you must review the provided information and manually create the infrastructure. If your cluster does not initialize correctly, you might have to contact Red Hat support with your installation logs.

#### Prerequisites

- Configure a GCP account.
- Generate the Ignition config files for your cluster.
- Create and configure a VPC and associated subnets in GCP.

#### Procedure

1. Copy the template from the **Deployment Manager template for the private DNS** section of this topic and save it as **02\_dns.py** on your computer. This template describes the private DNS objects that your cluster requires.
2. Create a **02\_dns.yaml** resource definition file:

```

$ cat <<EOF >02_dns.yaml
imports:
- path: 02_dns.py

resources:
- name: cluster-dns
  type: 02_dns.py
  properties:
    infra_id: '${INFRA_ID}' 1

```

```
cluster_domain: '${CLUSTER_NAME}.${BASE_DOMAIN}' 2
cluster_network: '${CLUSTER_NETWORK}' 3
EOF
```

- 1 **infra\_id** is the **INFRA\_ID** infrastructure name from the extraction step.
- 2 **cluster\_domain** is the domain for the cluster, for example **openshift.example.com**.
- 3 **cluster\_network** is the **selfLink** URL to the cluster network.

3. Create the deployment by using the **gcloud** CLI:

```
$ gcloud deployment-manager deployments create ${INFRA_ID}-dns --config 02_dns.yaml --
project ${HOST_PROJECT} --account ${HOST_PROJECT_ACCOUNT}
```

4. The templates do not create DNS entries due to limitations of Deployment Manager, so you must create them manually:
  - a. Add the internal DNS entries:

```
$ if [ -f transaction.yaml ]; then rm transaction.yaml; fi
$ gcloud dns record-sets transaction start --zone ${INFRA_ID}-private-zone --project
${HOST_PROJECT} --account ${HOST_PROJECT_ACCOUNT}
$ gcloud dns record-sets transaction add ${CLUSTER_IP} --name
api.${CLUSTER_NAME}.${BASE_DOMAIN}. --ttl 60 --type A --zone ${INFRA_ID}-
private-zone --project ${HOST_PROJECT} --account ${HOST_PROJECT_ACCOUNT}
$ gcloud dns record-sets transaction add ${CLUSTER_IP} --name api-
int.${CLUSTER_NAME}.${BASE_DOMAIN}. --ttl 60 --type A --zone ${INFRA_ID}-
private-zone --project ${HOST_PROJECT} --account ${HOST_PROJECT_ACCOUNT}
$ gcloud dns record-sets transaction execute --zone ${INFRA_ID}-private-zone --project
${HOST_PROJECT} --account ${HOST_PROJECT_ACCOUNT}
```

- b. For an external cluster, also add the external DNS entries:

```
$ if [ -f transaction.yaml ]; then rm transaction.yaml; fi
$ gcloud --account=${HOST_PROJECT_ACCOUNT} --project=${HOST_PROJECT} dns
record-sets transaction start --zone ${BASE_DOMAIN_ZONE_NAME}
$ gcloud --account=${HOST_PROJECT_ACCOUNT} --project=${HOST_PROJECT} dns
record-sets transaction add ${CLUSTER_PUBLIC_IP} --name
api.${CLUSTER_NAME}.${BASE_DOMAIN}. --ttl 60 --type A --zone
${BASE_DOMAIN_ZONE_NAME}
$ gcloud --account=${HOST_PROJECT_ACCOUNT} --project=${HOST_PROJECT} dns
record-sets transaction execute --zone ${BASE_DOMAIN_ZONE_NAME}
```

### 8.11.11.1. Deployment Manager template for the private DNS

You can use the following Deployment Manager template to deploy the private DNS that you need for your OpenShift Container Platform cluster:

#### Example 8.62. 02\_dns.py Deployment Manager template

```
def GenerateConfig(context):
```

```

resources = [{
  'name': context.properties['infra_id'] + '-private-zone',
  'type': 'dns.v1.managedZone',
  'properties': {
    'description': '',
    'dnsName': context.properties['cluster_domain'] + '.',
    'visibility': 'private',
    'privateVisibilityConfig': {
      'networks': [{
        'networkUrl': context.properties['cluster_network']
      }]
    }
  }
}]

return {'resources': resources}

```

### 8.11.12. Creating firewall rules in GCP

You must create firewall rules in Google Cloud Platform (GCP) for your OpenShift Container Platform cluster to use. One way to create these components is to modify the provided Deployment Manager template.



#### NOTE

If you do not use the provided Deployment Manager template to create your GCP infrastructure, you must review the provided information and manually create the infrastructure. If your cluster does not initialize correctly, you might have to contact Red Hat support with your installation logs.

#### Prerequisites

- Configure a GCP account.
- Generate the Ignition config files for your cluster.
- Create and configure a VPC and associated subnets in GCP.

#### Procedure

1. Copy the template from the **Deployment Manager template for firewall rules** section of this topic and save it as **03\_firewall.py** on your computer. This template describes the security groups that your cluster requires.
2. Create a **03\_firewall.yaml** resource definition file:

```

$ cat <<EOF >03_firewall.yaml
imports:
- path: 03_firewall.py

resources:
- name: cluster-firewall
  type: 03_firewall.py

```



```

properties:
  allowed_external_cidr: '0.0.0.0/0' ❶
  infra_id: '${INFRA_ID}' ❷
  cluster_network: '${CLUSTER_NETWORK}' ❸
  network_cidr: '${NETWORK_CIDR}' ❹
EOF

```

- ❶ **allowed\_external\_cidr** is the CIDR range that can access the cluster API and SSH to the bootstrap host. For an internal cluster, set this value to **`\${NETWORK\_CIDR}`**.
- ❷ **infra\_id** is the **INFRA\_ID** infrastructure name from the extraction step.
- ❸ **cluster\_network** is the **selfLink** URL to the cluster network.
- ❹ **network\_cidr** is the CIDR of the VPC network, for example **10.0.0.0/16**.

3. Create the deployment by using the **gcloud** CLI:

```

$ gcloud deployment-manager deployments create ${INFRA_ID}-firewall --config
03_firewall.yaml --project ${HOST_PROJECT} --account ${HOST_PROJECT_ACCOUNT}

```

### 8.11.12.1. Deployment Manager template for firewall rules

You can use the following Deployment Manager template to deploy the firewall rules that you need for your OpenShift Container Platform cluster:

#### Example 8.63. 03\_firewall.py Deployment Manager template

```

def GenerateConfig(context):

    resources = [{
        'name': context.properties['infra_id'] + '-bootstrap-in-ssh',
        'type': 'compute.v1.firewall',
        'properties': {
            'network': context.properties['cluster_network'],
            'allowed': [{
                'IPProtocol': 'tcp',
                'ports': ['22']
            }],
            'sourceRanges': [context.properties['allowed_external_cidr']],
            'targetTags': [context.properties['infra_id'] + '-bootstrap']
        }
    ], {
        'name': context.properties['infra_id'] + '-api',
        'type': 'compute.v1.firewall',
        'properties': {
            'network': context.properties['cluster_network'],
            'allowed': [{
                'IPProtocol': 'tcp',
                'ports': ['6443']
            }],
            'sourceRanges': [context.properties['allowed_external_cidr']],
            'targetTags': [context.properties['infra_id'] + '-master']
        }
    }

```

```

}, {
  'name': context.properties['infra_id'] + '-health-checks',
  'type': 'compute.v1.firewall',
  'properties': {
    'network': context.properties['cluster_network'],
    'allowed': [{
      'IPProtocol': 'tcp',
      'ports': ['6080', '6443', '22624']
    }],
    'sourceRanges': ['35.191.0.0/16', '130.211.0.0/22', '209.85.152.0/22', '209.85.204.0/22'],
    'targetTags': [context.properties['infra_id'] + '-master']
  }
}, {
  'name': context.properties['infra_id'] + '-etcd',
  'type': 'compute.v1.firewall',
  'properties': {
    'network': context.properties['cluster_network'],
    'allowed': [{
      'IPProtocol': 'tcp',
      'ports': ['2379-2380']
    }],
    'sourceTags': [context.properties['infra_id'] + '-master'],
    'targetTags': [context.properties['infra_id'] + '-master']
  }
}, {
  'name': context.properties['infra_id'] + '-control-plane',
  'type': 'compute.v1.firewall',
  'properties': {
    'network': context.properties['cluster_network'],
    'allowed': [{
      'IPProtocol': 'tcp',
      'ports': ['10257']
    }],
    {
      'IPProtocol': 'tcp',
      'ports': ['10259']
    },
    {
      'IPProtocol': 'tcp',
      'ports': ['22623']
    }
  ],
  'sourceTags': [
    context.properties['infra_id'] + '-master',
    context.properties['infra_id'] + '-worker'
  ],
  'targetTags': [context.properties['infra_id'] + '-master']
}
}, {
  'name': context.properties['infra_id'] + '-internal-network',
  'type': 'compute.v1.firewall',
  'properties': {
    'network': context.properties['cluster_network'],
    'allowed': [{
      'IPProtocol': 'icmp'
    }],
    {
      'IPProtocol': 'tcp',
      'ports': ['22']
    }
  ],
}

```

```

    'sourceRanges': [context.properties['network_cidr']],
    'targetTags': [
      context.properties['infra_id'] + '-master',
      context.properties['infra_id'] + '-worker'
    ]
  }
}, {
  'name': context.properties['infra_id'] + '-internal-cluster',
  'type': 'compute.v1.firewall',
  'properties': {
    'network': context.properties['cluster_network'],
    'allowed': [{
      'IPProtocol': 'udp',
      'ports': ['4789', '6081']
    }, {
      'IPProtocol': 'udp',
      'ports': ['500', '4500']
    }, {
      'IPProtocol': 'esp',
    }, {
      'IPProtocol': 'tcp',
      'ports': ['9000-9999']
    }, {
      'IPProtocol': 'udp',
      'ports': ['9000-9999']
    }, {
      'IPProtocol': 'tcp',
      'ports': ['10250']
    }, {
      'IPProtocol': 'tcp',
      'ports': ['30000-32767']
    }, {
      'IPProtocol': 'udp',
      'ports': ['30000-32767']
    }
  ],
  'sourceTags': [
    context.properties['infra_id'] + '-master',
    context.properties['infra_id'] + '-worker'
  ],
  'targetTags': [
    context.properties['infra_id'] + '-master',
    context.properties['infra_id'] + '-worker'
  ]
}
}]

return {'resources': resources}

```

### 8.11.13. Creating IAM roles in GCP

You must create IAM roles in Google Cloud Platform (GCP) for your OpenShift Container Platform cluster to use. One way to create these components is to modify the provided Deployment Manager template.



## NOTE

If you do not use the provided Deployment Manager template to create your GCP infrastructure, you must review the provided information and manually create the infrastructure. If your cluster does not initialize correctly, you might have to contact Red Hat support with your installation logs.

## Prerequisites

- Configure a GCP account.
- Generate the Ignition config files for your cluster.
- Create and configure a VPC and associated subnets in GCP.

## Procedure

1. Copy the template from the **Deployment Manager template for IAM roles** section of this topic and save it as **03\_iam.py** on your computer. This template describes the IAM roles that your cluster requires.
2. Create a **03\_iam.yaml** resource definition file:

```
$ cat <<EOF >03_iam.yaml
imports:
- path: 03_iam.py
resources:
- name: cluster-iam
  type: 03_iam.py
  properties:
    infra_id: '${INFRA_ID}' 1
EOF
```

- 1 **infra\_id** is the **INFRA\_ID** infrastructure name from the extraction step.

3. Create the deployment by using the **gcloud** CLI:

```
$ gcloud deployment-manager deployments create ${INFRA_ID}-iam --config 03_iam.yaml
```

4. Export the variable for the master service account:

```
$ export MASTER_SERVICE_ACCOUNT=$(gcloud iam service-accounts list --filter
"email~^${INFRA_ID}-m@${PROJECT_NAME}." --format json | jq -r '[0].email')
```

5. Export the variable for the worker service account:

```
$ export WORKER_SERVICE_ACCOUNT=$(gcloud iam service-accounts list --filter
"email~^${INFRA_ID}-w@${PROJECT_NAME}." --format json | jq -r '[0].email')
```

6. Assign the permissions that the installation program requires to the service accounts for the subnets that host the control plane and compute subnets:
  - a. Grant the **networkViewer** role of the project that hosts your shared VPC to the master service account:

```
$ gcloud --account=${HOST_PROJECT_ACCOUNT} --project=${HOST_PROJECT}
projects add-iam-policy-binding ${HOST_PROJECT} --member
"serviceAccount:${MASTER_SERVICE_ACCOUNT}" --role
"roles/compute.networkViewer"
```

- b. Grant the **networkUser** role to the master service account for the control plane subnet:

```
$ gcloud --account=${HOST_PROJECT_ACCOUNT} --project=${HOST_PROJECT}
compute networks subnets add-iam-policy-binding
"${HOST_PROJECT_CONTROL_SUBNET}" --member
"serviceAccount:${MASTER_SERVICE_ACCOUNT}" --role "roles/compute.networkUser"
--region ${REGION}
```

- c. Grant the **networkUser** role to the worker service account for the control plane subnet:

```
$ gcloud --account=${HOST_PROJECT_ACCOUNT} --project=${HOST_PROJECT}
compute networks subnets add-iam-policy-binding
"${HOST_PROJECT_CONTROL_SUBNET}" --member
"serviceAccount:${WORKER_SERVICE_ACCOUNT}" --role
"roles/compute.networkUser" --region ${REGION}
```

- d. Grant the **networkUser** role to the master service account for the compute subnet:

```
$ gcloud --account=${HOST_PROJECT_ACCOUNT} --project=${HOST_PROJECT}
compute networks subnets add-iam-policy-binding
"${HOST_PROJECT_COMPUTE_SUBNET}" --member
"serviceAccount:${MASTER_SERVICE_ACCOUNT}" --role "roles/compute.networkUser"
--region ${REGION}
```

- e. Grant the **networkUser** role to the worker service account for the compute subnet:

```
$ gcloud --account=${HOST_PROJECT_ACCOUNT} --project=${HOST_PROJECT}
compute networks subnets add-iam-policy-binding
"${HOST_PROJECT_COMPUTE_SUBNET}" --member
"serviceAccount:${WORKER_SERVICE_ACCOUNT}" --role
"roles/compute.networkUser" --region ${REGION}
```

7. The templates do not create the policy bindings due to limitations of Deployment Manager, so you must create them manually:

```
$ gcloud projects add-iam-policy-binding ${PROJECT_NAME} --member
"serviceAccount:${MASTER_SERVICE_ACCOUNT}" --role "roles/compute.instanceAdmin"
$ gcloud projects add-iam-policy-binding ${PROJECT_NAME} --member
"serviceAccount:${MASTER_SERVICE_ACCOUNT}" --role "roles/compute.networkAdmin"
$ gcloud projects add-iam-policy-binding ${PROJECT_NAME} --member
"serviceAccount:${MASTER_SERVICE_ACCOUNT}" --role "roles/compute.securityAdmin"
$ gcloud projects add-iam-policy-binding ${PROJECT_NAME} --member
"serviceAccount:${MASTER_SERVICE_ACCOUNT}" --role "roles/iam.serviceAccountUser"
$ gcloud projects add-iam-policy-binding ${PROJECT_NAME} --member
"serviceAccount:${MASTER_SERVICE_ACCOUNT}" --role "roles/storage.admin"

$ gcloud projects add-iam-policy-binding ${PROJECT_NAME} --member
```

```
"serviceAccount:${WORKER_SERVICE_ACCOUNT}" --role "roles/compute.viewer"
$ gcloud projects add-iam-policy-binding ${PROJECT_NAME} --member
"serviceAccount:${WORKER_SERVICE_ACCOUNT}" --role "roles/storage.admin"
```

8. Create a service account key and store it locally for later use:

```
$ gcloud iam service-accounts keys create service-account-key.json --iam-
account=${MASTER_SERVICE_ACCOUNT}
```

### 8.11.13.1. Deployment Manager template for IAM roles

You can use the following Deployment Manager template to deploy the IAM roles that you need for your OpenShift Container Platform cluster:

#### Example 8.64. 03\_iam.py Deployment Manager template

```
def GenerateConfig(context):

    resources = [{
        'name': context.properties['infra_id'] + '-master-node-sa',
        'type': 'iam.v1.serviceAccount',
        'properties': {
            'accountId': context.properties['infra_id'] + '-m',
            'displayName': context.properties['infra_id'] + '-master-node'
        }
    }, {
        'name': context.properties['infra_id'] + '-worker-node-sa',
        'type': 'iam.v1.serviceAccount',
        'properties': {
            'accountId': context.properties['infra_id'] + '-w',
            'displayName': context.properties['infra_id'] + '-worker-node'
        }
    }
    ]

    return {'resources': resources}
```

### 8.11.14. Creating the RHCOS cluster image for the GCP infrastructure

You must use a valid Red Hat Enterprise Linux CoreOS (RHCOS) image for Google Cloud Platform (GCP) for your OpenShift Container Platform nodes.

#### Procedure

1. Obtain the RHCOS image from the [RHCOS image mirror](#) page.

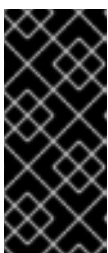

#### IMPORTANT

The RHCOS images might not change with every release of OpenShift Container Platform. You must download an image with the highest version that is less than or equal to the OpenShift Container Platform version that you install. Use the image version that matches your OpenShift Container Platform version if it is available.

The file name contains the OpenShift Container Platform version number in the format **rhcos-  
<version>-<arch>-gcp.<arch>.tar.gz**.

2. Create the Google storage bucket:

```
$ gsutil mb gs://<bucket_name>
```

3. Upload the RHCOS image to the Google storage bucket:

```
$ gsutil cp <downloaded_image_file_path>/rhcos-<version>-x86_64-gcp.x86_64.tar.gz  
gs://<bucket_name>
```

4. Export the uploaded RHCOS image location as a variable:

```
$ export IMAGE_SOURCE=gs://<bucket_name>/rhcos-<version>-x86_64-gcp.x86_64.tar.gz
```

5. Create the cluster image:

```
$ gcloud compute images create "${INFRA_ID}-rhcos-image" \  
--source-uri="${IMAGE_SOURCE}"
```

### 8.11.15. Creating the bootstrap machine in GCP

You must create the bootstrap machine in Google Cloud Platform (GCP) to use during OpenShift Container Platform cluster initialization. One way to create this machine is to modify the provided Deployment Manager template.



#### NOTE

If you do not use the provided Deployment Manager template to create your bootstrap machine, you must review the provided information and manually create the infrastructure. If your cluster does not initialize correctly, you might have to contact Red Hat support with your installation logs.

#### Prerequisites

- Configure a GCP account.
- Generate the Ignition config files for your cluster.
- Create and configure a VPC and associated subnets in GCP.
- Create and configure networking and load balancers in GCP.
- Create control plane and compute roles.
- Ensure pyOpenSSL is installed.

#### Procedure

1. Copy the template from the **Deployment Manager template for the bootstrap machine** section of this topic and save it as **04\_bootstrap.py** on your computer. This template describes the bootstrap machine that your cluster requires.

- Export the location of the Red Hat Enterprise Linux CoreOS (RHCOS) image that the installation program requires:

```
$ export CLUSTER_IMAGE=$(gcloud compute images describe ${INFRA_ID}-rhcos-image --format json | jq -r .selfLink)
```

- Create a bucket and upload the **bootstrap.ign** file:

```
$ gsutil mb gs://${INFRA_ID}-bootstrap-ignition
```

```
$ gsutil cp <installation_directory>/bootstrap.ign gs://${INFRA_ID}-bootstrap-ignition/
```

- Create a signed URL for the bootstrap instance to use to access the Ignition config. Export the URL from the output as a variable:

```
$ export BOOTSTRAP_IGN=`gsutil signurl -d 1h service-account-key.json gs://${INFRA_ID}-bootstrap-ignition/bootstrap.ign | grep "^gs:" | awk '{print $5}'`
```

- Create a **04\_bootstrap.yaml** resource definition file:

```
$ cat <<EOF >04_bootstrap.yaml
imports:
- path: 04_bootstrap.py

resources:
- name: cluster-bootstrap
  type: 04_bootstrap.py
  properties:
    infra_id: '${INFRA_ID}' 1
    region: '${REGION}' 2
    zone: '${ZONE_0}' 3

    cluster_network: '${CLUSTER_NETWORK}' 4
    control_subnet: '${CONTROL_SUBNET}' 5
    image: '${CLUSTER_IMAGE}' 6
    machine_type: 'n1-standard-4' 7
    root_volume_size: '128' 8

    bootstrap_ign: '${BOOTSTRAP_IGN}' 9
EOF
```

- infra\_id** is the **INFRA\_ID** infrastructure name from the extraction step.
- region** is the region to deploy the cluster into, for example **us-central1**.
- zone** is the zone to deploy the bootstrap instance into, for example **us-central1-b**.
- cluster\_network** is the **selfLink** URL to the cluster network.
- control\_subnet** is the **selfLink** URL to the control subnet.
- image** is the **selfLink** URL to the RHCOS image.



- 7 **machine\_type** is the machine type of the instance, for example **n1-standard-4**.
- 8 **root\_volume\_size** is the boot disk size for the bootstrap machine.
- 9 **bootstrap\_ign** is the URL output when creating a signed URL.

6. Create the deployment by using the **gcloud** CLI:

```
$ gcloud deployment-manager deployments create ${INFRA_ID}-bootstrap --config
04_bootstrap.yaml
```

7. Add the bootstrap instance to the internal load balancer instance group:

```
$ gcloud compute instance-groups unmanaged add-instances ${INFRA_ID}-bootstrap-ig --
zone=${ZONE_0} --instances=${INFRA_ID}-bootstrap
```

8. Add the bootstrap instance group to the internal load balancer backend service:

```
$ gcloud compute backend-services add-backend ${INFRA_ID}-api-internal-backend-service
--region=${REGION} --instance-group=${INFRA_ID}-bootstrap-ig --instance-group-
zone=${ZONE_0}
```

### 8.11.15.1. Deployment Manager template for the bootstrap machine

You can use the following Deployment Manager template to deploy the bootstrap machine that you need for your OpenShift Container Platform cluster:

#### Example 8.65. 04\_bootstrap.py Deployment Manager template

```
def GenerateConfig(context):

    resources = [{
        'name': context.properties['infra_id'] + '-bootstrap-public-ip',
        'type': 'compute.v1.address',
        'properties': {
            'region': context.properties['region']
        }
    }, {
        'name': context.properties['infra_id'] + '-bootstrap',
        'type': 'compute.v1.instance',
        'properties': {
            'disks': [{
                'autoDelete': True,
                'boot': True,
                'initializeParams': {
                    'diskSizeGb': context.properties['root_volume_size'],
                    'sourceImage': context.properties['image']
                }
            }
        ],
        'machineType': 'zones/' + context.properties['zone'] + '/machineTypes/' +
context.properties['machine_type'],
        'metadata': {
            'items': [{
```

```

        'key': 'user-data',
        'value': '{"ignition":{"config":{"replace":{"source":"' + context.properties['bootstrap_ign']
+ ""}},"version":"3.2.0"}}',
    }
  },
  'networkInterfaces': [{
    'subnetwork': context.properties['control_subnet'],
    'accessConfigs': [{
      'natIP': '${ref.' + context.properties['infra_id'] + '-bootstrap-public-ip.address}'
    }
  ]
}],
'tags': {
  'items': [
    context.properties['infra_id'] + '-master',
    context.properties['infra_id'] + '-bootstrap'
  ]
},
'zone': context.properties['zone']
}
}, {
  'name': context.properties['infra_id'] + '-bootstrap-ig',
  'type': 'compute.v1.instanceGroup',
  'properties': {
    'namedPorts': [
      {
        'name': 'ignition',
        'port': 22623
      }, {
        'name': 'https',
        'port': 6443
      }
    ]
  },
  'network': context.properties['cluster_network'],
  'zone': context.properties['zone']
}
]]

return {'resources': resources}

```

### 8.11.16. Creating the control plane machines in GCP

You must create the control plane machines in Google Cloud Platform (GCP) for your cluster to use. One way to create these machines is to modify the provided Deployment Manager template.



#### NOTE

If you do not use the provided Deployment Manager template to create your control plane machines, you must review the provided information and manually create the infrastructure. If your cluster does not initialize correctly, you might have to contact Red Hat support with your installation logs.

#### Prerequisites

- Configure a GCP account.

- Generate the Ignition config files for your cluster.
- Create and configure a VPC and associated subnets in GCP.
- Create and configure networking and load balancers in GCP.
- Create control plane and compute roles.
- Create the bootstrap machine.

## Procedure

1. Copy the template from the **Deployment Manager template for control plane machines** section of this topic and save it as **05\_control\_plane.py** on your computer. This template describes the control plane machines that your cluster requires.
2. Export the following variable required by the resource definition:

```
$ export MASTER_IGNITION=`cat <installation_directory>/master.ign`
```

3. Create a **05\_control\_plane.yaml** resource definition file:

```
$ cat <<EOF >05_control_plane.yaml
imports:
- path: 05_control_plane.py

resources:
- name: cluster-control-plane
  type: 05_control_plane.py
  properties:
    infra_id: '${INFRA_ID}' ❶
    zones: ❷
    - '${ZONE_0}'
    - '${ZONE_1}'
    - '${ZONE_2}'

    control_subnet: '${CONTROL_SUBNET}' ❸
    image: '${CLUSTER_IMAGE}' ❹
    machine_type: 'n1-standard-4' ❺
    root_volume_size: '128'
    service_account_email: '${MASTER_SERVICE_ACCOUNT}' ❻

    ignition: '${MASTER_IGNITION}' ❼
EOF
```

- ❶ **infra\_id** is the **INFRA\_ID** infrastructure name from the extraction step.
- ❷ **zones** are the zones to deploy the control plane instances into, for example **us-central1-a**, **us-central1-b**, and **us-central1-c**.
- ❸ **control\_subnet** is the **selfLink** URL to the control subnet.
- ❹ **image** is the **selfLink** URL to the RHCOS image.
- ❺ **machine\_type** is the machine type of the instance, for example **n1-standard-4**.

- 6 **service\_account\_email** is the email address for the master service account that you created.
- 7 **ignition** is the contents of the **master.ign** file.

4. Create the deployment by using the **gcloud** CLI:

```
$ gcloud deployment-manager deployments create ${INFRA_ID}-control-plane --config 05_control_plane.yaml
```

5. The templates do not manage load balancer membership due to limitations of Deployment Manager, so you must add the control plane machines manually.

- Run the following commands to add the control plane machines to the appropriate instance groups:

```
$ gcloud compute instance-groups unmanaged add-instances ${INFRA_ID}-master-${ZONE_0}-ig --zone=${ZONE_0} --instances=${INFRA_ID}-master-0
```

```
$ gcloud compute instance-groups unmanaged add-instances ${INFRA_ID}-master-${ZONE_1}-ig --zone=${ZONE_1} --instances=${INFRA_ID}-master-1
```

```
$ gcloud compute instance-groups unmanaged add-instances ${INFRA_ID}-master-${ZONE_2}-ig --zone=${ZONE_2} --instances=${INFRA_ID}-master-2
```

- For an external cluster, you must also run the following commands to add the control plane machines to the target pools:

```
$ gcloud compute target-pools add-instances ${INFRA_ID}-api-target-pool --instances-zone="${ZONE_0}" --instances=${INFRA_ID}-master-0
```

```
$ gcloud compute target-pools add-instances ${INFRA_ID}-api-target-pool --instances-zone="${ZONE_1}" --instances=${INFRA_ID}-master-1
```

```
$ gcloud compute target-pools add-instances ${INFRA_ID}-api-target-pool --instances-zone="${ZONE_2}" --instances=${INFRA_ID}-master-2
```

### 8.11.16.1. Deployment Manager template for control plane machines

You can use the following Deployment Manager template to deploy the control plane machines that you need for your OpenShift Container Platform cluster:

#### Example 8.66. 05\_control\_plane.py Deployment Manager template

```
def GenerateConfig(context):

    resources = [{
        'name': context.properties['infra_id'] + '-master-0',
        'type': 'compute.v1.instance',
        'properties': {
            'disks': [{
```

```

      'autoDelete': True,
      'boot': True,
      'initializeParams': {
        'diskSizeGb': context.properties['root_volume_size'],
        'diskType': 'zones/' + context.properties['zones'][0] + '/diskTypes/pd-ssd',
        'sourceImage': context.properties['image']
      }
    ]],
    'machineType': 'zones/' + context.properties['zones'][0] + '/machineTypes/' +
context.properties['machine_type'],
    'metadata': {
      'items': [{
        'key': 'user-data',
        'value': context.properties['ignition']
      }]
    },
    'networkInterfaces': [{
      'subnetwork': context.properties['control_subnet']
    }],
    'serviceAccounts': [{
      'email': context.properties['service_account_email'],
      'scopes': ['https://www.googleapis.com/auth/cloud-platform']
    }],
    'tags': {
      'items': [
        context.properties['infra_id'] + '-master',
      ]
    },
    'zone': context.properties['zones'][0]
  }
}, {
  'name': context.properties['infra_id'] + '-master-1',
  'type': 'compute.v1.instance',
  'properties': {
    'disks': [{
      'autoDelete': True,
      'boot': True,
      'initializeParams': {
        'diskSizeGb': context.properties['root_volume_size'],
        'diskType': 'zones/' + context.properties['zones'][1] + '/diskTypes/pd-ssd',
        'sourceImage': context.properties['image']
      }
    }
  ]],
  'machineType': 'zones/' + context.properties['zones'][1] + '/machineTypes/' +
context.properties['machine_type'],
  'metadata': {
    'items': [{
      'key': 'user-data',
      'value': context.properties['ignition']
    }]
  },
  'networkInterfaces': [{
    'subnetwork': context.properties['control_subnet']
  }],
  'serviceAccounts': [{
    'email': context.properties['service_account_email'],

```

```

        'scopes': ['https://www.googleapis.com/auth/cloud-platform']
    }},
    'tags': {
        'items': [
            context.properties['infra_id'] + '-master',
        ]
    },
    'zone': context.properties['zones'][1]
}
}, {
    'name': context.properties['infra_id'] + '-master-2',
    'type': 'compute.v1.instance',
    'properties': {
        'disks': [{
            'autoDelete': True,
            'boot': True,
            'initializeParams': {
                'diskSizeGb': context.properties['root_volume_size'],
                'diskType': 'zones/' + context.properties['zones'][2] + '/diskTypes/pd-ssd',
                'sourceImage': context.properties['image']
            }
        }
    ],
    'machineType': 'zones/' + context.properties['zones'][2] + '/machineTypes/' +
context.properties['machine_type'],
    'metadata': {
        'items': [{
            'key': 'user-data',
            'value': context.properties['ignition']
        }
    ]
    },
    'networkInterfaces': [{
        'subnetwork': context.properties['control_subnet']
    }],
    'serviceAccounts': [{
        'email': context.properties['service_account_email'],
        'scopes': ['https://www.googleapis.com/auth/cloud-platform']
    }],
    'tags': {
        'items': [
            context.properties['infra_id'] + '-master',
        ]
    },
    'zone': context.properties['zones'][2]
}
}
}
}

return {'resources': resources}

```

### 8.11.17. Wait for bootstrap completion and remove bootstrap resources in GCP

After you create all of the required infrastructure in Google Cloud Platform (GCP), wait for the bootstrap process to complete on the machines that you provisioned by using the Ignition config files that you generated with the installation program.

## Prerequisites

- Configure a GCP account.
- Generate the Ignition config files for your cluster.
- Create and configure a VPC and associated subnets in GCP.
- Create and configure networking and load balancers in GCP.
- Create control plane and compute roles.
- Create the bootstrap machine.
- Create the control plane machines.

## Procedure

1. Change to the directory that contains the installation program and run the following command:

```
$ ./openshift-install wait-for bootstrap-complete --dir <installation_directory> \ 1
--log-level info 2
```

- 1 For **<installation\_directory>**, specify the path to the directory that you stored the installation files in.

- 2 To view different installation details, specify **warn**, **debug**, or **error** instead of **info**.

If the command exits without a **FATAL** warning, your production control plane has initialized.

2. Delete the bootstrap resources:

```
$ gcloud compute backend-services remove-backend ${INFRA_ID}-api-internal-backend-
service --region=${REGION} --instance-group=${INFRA_ID}-bootstrap-ig --instance-group-
zone=${ZONE_0}
```

```
$ gsutil rm gs://${INFRA_ID}-bootstrap-ignition/bootstrap.ign
```

```
$ gsutil rb gs://${INFRA_ID}-bootstrap-ignition
```

```
$ gcloud deployment-manager deployments delete ${INFRA_ID}-bootstrap
```

### 8.11.18. Creating additional worker machines in GCP

You can create worker machines in Google Cloud Platform (GCP) for your cluster to use by launching individual instances discretely or by automated processes outside the cluster, such as auto scaling groups. You can also take advantage of the built-in cluster scaling mechanisms and the machine API in OpenShift Container Platform.

In this example, you manually launch one instance by using the Deployment Manager template. Additional instances can be launched by including additional resources of type **06\_worker.py** in the file.



## NOTE

If you do not use the provided Deployment Manager template to create your worker machines, you must review the provided information and manually create the infrastructure. If your cluster does not initialize correctly, you might have to contact Red Hat support with your installation logs.

## Prerequisites

- Configure a GCP account.
- Generate the Ignition config files for your cluster.
- Create and configure a VPC and associated subnets in GCP.
- Create and configure networking and load balancers in GCP.
- Create control plane and compute roles.
- Create the bootstrap machine.
- Create the control plane machines.

## Procedure

1. Copy the template from the **Deployment Manager template for worker machines** section of this topic and save it as **06\_worker.py** on your computer. This template describes the worker machines that your cluster requires.
2. Export the variables that the resource definition uses.
  - a. Export the subnet that hosts the compute machines:

```
$ export COMPUTE_SUBNET=(`gcloud compute networks subnets describe
${HOST_PROJECT_COMPUTE_SUBNET} --region=${REGION} --project
${HOST_PROJECT} --account ${HOST_PROJECT_ACCOUNT} --format json | jq -r
.selfLink`)
```

- b. Export the email address for your service account:

```
$ export WORKER_SERVICE_ACCOUNT=(`gcloud iam service-accounts list --filter
"email~^${INFRA_ID}-w@${PROJECT_NAME}." --format json | jq -r '[0].email`)
```

- c. Export the location of the compute machine Ignition config file:

```
$ export WORKER_IGNITION=`cat <installation_directory>/worker.ign`
```

3. Create a **06\_worker.yaml** resource definition file:

```
$ cat <<EOF >06_worker.yaml
imports:
- path: 06_worker.py

resources:
- name: 'worker-0' 1
```



```

type: 06_worker.py
properties:
  infra_id: '${INFRA_ID}' 2
  zone: '${ZONE_0}' 3
  compute_subnet: '${COMPUTE_SUBNET}' 4
  image: '${CLUSTER_IMAGE}' 5
  machine_type: 'n1-standard-4' 6
  root_volume_size: '128'
  service_account_email: '${WORKER_SERVICE_ACCOUNT}' 7
  ignition: '${WORKER_IGNITION}' 8
- name: 'worker-1'
  type: 06_worker.py
  properties:
    infra_id: '${INFRA_ID}' 9
    zone: '${ZONE_1}' 10
    compute_subnet: '${COMPUTE_SUBNET}' 11
    image: '${CLUSTER_IMAGE}' 12
    machine_type: 'n1-standard-4' 13
    root_volume_size: '128'
    service_account_email: '${WORKER_SERVICE_ACCOUNT}' 14
    ignition: '${WORKER_IGNITION}' 15
EOF

```

- 1 **name** is the name of the worker machine, for example **worker-0**.
- 2 9 **infra\_id** is the **INFRA\_ID** infrastructure name from the extraction step.
- 3 10 **zone** is the zone to deploy the worker machine into, for example **us-central1-a**.
- 4 11 **compute\_subnet** is the **selfLink** URL to the compute subnet.
- 5 12 **image** is the **selfLink** URL to the RHCOS image. <sup>1</sup>
- 6 13 **machine\_type** is the machine type of the instance, for example **n1-standard-4**.
- 7 14 **service\_account\_email** is the email address for the worker service account that you created.
- 8 15 **ignition** is the contents of the **worker.ign** file.

4. Optional: If you want to launch additional instances, include additional resources of type **06\_worker.py** in your **06\_worker.yaml** resource definition file.
5. Create the deployment by using the **gcloud** CLI:

```
$ gcloud deployment-manager deployments create ${INFRA_ID}-worker --config
06_worker.yaml
```

1. To use a GCP Marketplace image, specify the offer to use:
  - OpenShift Container Platform:
<https://www.googleapis.com/compute/v1/projects/redhat-marketplace-public/global/images/redhat-coreos-ocp-48-x86-64-202210040145>

- OpenShift Platform Plus: <https://www.googleapis.com/compute/v1/projects/redhat-marketplace-public/global/images/redhat-coreos-opp-48-x86-64-202206140145>
- OpenShift Kubernetes Engine: <https://www.googleapis.com/compute/v1/projects/redhat-marketplace-public/global/images/redhat-coreos-oke-48-x86-64-202206140145>

### 8.11.18.1. Deployment Manager template for worker machines

You can use the following Deployment Manager template to deploy the worker machines that you need for your OpenShift Container Platform cluster:

#### Example 8.67. `06_worker.py` Deployment Manager template

```
def GenerateConfig(context):

    resources = [{
        'name': context.properties['infra_id'] + '-' + context.env['name'],
        'type': 'compute.v1.instance',
        'properties': {
            'disks': [{
                'autoDelete': True,
                'boot': True,
                'initializeParams': {
                    'diskSizeGb': context.properties['root_volume_size'],
                    'sourceImage': context.properties['image']
                }
            }],
            'machineType': 'zones/' + context.properties['zone'] + '/machineTypes/' +
context.properties['machine_type'],
            'metadata': {
                'items': [{
                    'key': 'user-data',
                    'value': context.properties['ignition']
                }]
            },
            'networkInterfaces': [{
                'subnetwork': context.properties['compute_subnet']
            }],
            'serviceAccounts': [{
                'email': context.properties['service_account_email'],
                'scopes': ['https://www.googleapis.com/auth/cloud-platform']
            }],
            'tags': {
                'items': [
                    context.properties['infra_id'] + '-worker',
                ]
            },
            'zone': context.properties['zone']
        }
    ]

    return {'resources': resources}
```

### 8.11.19. Installing the OpenShift CLI by downloading the binary

You can install the OpenShift CLI (**oc**) to interact with OpenShift Container Platform from a command-line interface. You can install **oc** on Linux, Windows, or macOS.

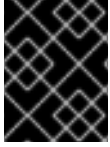

#### IMPORTANT

If you installed an earlier version of **oc**, you cannot use it to complete all of the commands in OpenShift Container Platform 4.10. Download and install the new version of **oc**.

#### Installing the OpenShift CLI on Linux

You can install the OpenShift CLI (**oc**) binary on Linux by using the following procedure.

##### Procedure

1. Navigate to the [OpenShift Container Platform downloads page](#) on the Red Hat Customer Portal.
2. Select the appropriate version in the **Version** drop-down menu.
3. Click **Download Now** next to the **OpenShift v4.10 Linux Client** entry and save the file.
4. Unpack the archive:

```
$ tar xvf <file>
```

5. Place the **oc** binary in a directory that is on your **PATH**.  
To check your **PATH**, execute the following command:

```
$ echo $PATH
```

After you install the OpenShift CLI, it is available using the **oc** command:

```
$ oc <command>
```

#### Installing the OpenShift CLI on Windows

You can install the OpenShift CLI (**oc**) binary on Windows by using the following procedure.

##### Procedure

1. Navigate to the [OpenShift Container Platform downloads page](#) on the Red Hat Customer Portal.
2. Select the appropriate version in the **Version** drop-down menu.
3. Click **Download Now** next to the **OpenShift v4.10 Windows Client** entry and save the file.
4. Unzip the archive with a ZIP program.
5. Move the **oc** binary to a directory that is on your **PATH**.  
To check your **PATH**, open the command prompt and execute the following command:

```
C:\> path
```

After you install the OpenShift CLI, it is available using the **oc** command:

```
C:\> oc <command>
```

### Installing the OpenShift CLI on macOS

You can install the OpenShift CLI (**oc**) binary on macOS by using the following procedure.

#### Procedure

1. Navigate to the [OpenShift Container Platform downloads page](#) on the Red Hat Customer Portal.
2. Select the appropriate version in the **Version** drop-down menu.
3. Click **Download Now** next to the **OpenShift v4.10 MacOSX Client** entry and save the file.
4. Unpack and unzip the archive.
5. Move the **oc** binary to a directory on your PATH.  
To check your **PATH**, open a terminal and execute the following command:

```
$ echo $PATH
```

After you install the OpenShift CLI, it is available using the **oc** command:

```
$ oc <command>
```

### 8.11.20. Logging in to the cluster by using the CLI

You can log in to your cluster as a default system user by exporting the cluster **kubeconfig** file. The **kubeconfig** file contains information about the cluster that is used by the CLI to connect a client to the correct cluster and API server. The file is specific to a cluster and is created during OpenShift Container Platform installation.

#### Prerequisites

- You deployed an OpenShift Container Platform cluster.
- You installed the **oc** CLI.

#### Procedure

1. Export the **kubeadmin** credentials:

```
$ export KUBECONFIG=<installation_directory>/auth/kubeconfig 1
```

- 1** For **<installation\_directory>**, specify the path to the directory that you stored the installation files in.

2. Verify you can run **oc** commands successfully using the exported configuration:

```
$ oc whoami
```

## Example output

```
system:admin
```

### 8.11.21. Approving the certificate signing requests for your machines

When you add machines to a cluster, two pending certificate signing requests (CSRs) are generated for each machine that you added. You must confirm that these CSRs are approved or, if necessary, approve them yourself. The client requests must be approved first, followed by the server requests.

#### Prerequisites

- You added machines to your cluster.

#### Procedure

- Confirm that the cluster recognizes the machines:

```
$ oc get nodes
```

#### Example output

```
NAME      STATUS    ROLES    AGE   VERSION
master-0  Ready    master   63m   v1.23.0
master-1  Ready    master   63m   v1.23.0
master-2  Ready    master   64m   v1.23.0
```

The output lists all of the machines that you created.

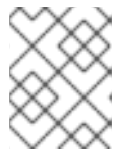

#### NOTE

The preceding output might not include the compute nodes, also known as worker nodes, until some CSRs are approved.

- Review the pending CSRs and ensure that you see the client requests with the **Pending** or **Approved** status for each machine that you added to the cluster:

```
$ oc get csr
```

#### Example output

```
NAME      AGE   REQUESTOR                                     CONDITION
csr-8b2br  15m   system:serviceaccount:openshift-machine-config-operator:node-
bootstrapper  Pending
csr-8vnps  15m   system:serviceaccount:openshift-machine-config-operator:node-
bootstrapper  Pending
...
```

In this example, two machines are joining the cluster. You might see more approved CSRs in the list.

- If the CSRs were not approved, after all of the pending CSRs for the machines you added are in **Pending** status, approve the CSRs for your cluster machines:



#### NOTE

Because the CSRs rotate automatically, approve your CSRs within an hour of adding the machines to the cluster. If you do not approve them within an hour, the certificates will rotate, and more than two certificates will be present for each node. You must approve all of these certificates. After the client CSR is approved, the Kubelet creates a secondary CSR for the serving certificate, which requires manual approval. Then, subsequent serving certificate renewal requests are automatically approved by the **machine-approver** if the Kubelet requests a new certificate with identical parameters.



#### NOTE

For clusters running on platforms that are not machine API enabled, such as bare metal and other user-provisioned infrastructure, you must implement a method of automatically approving the kubelet serving certificate requests (CSRs). If a request is not approved, then the **oc exec**, **oc rsh**, and **oc logs** commands cannot succeed, because a serving certificate is required when the API server connects to the kubelet. Any operation that contacts the Kubelet endpoint requires this certificate approval to be in place. The method must watch for new CSRs, confirm that the CSR was submitted by the **node-bootstrap** service account in the **system:node** or **system:admin** groups, and confirm the identity of the node.

- To approve them individually, run the following command for each valid CSR:

```
$ oc adm certificate approve <csr_name> 1
```

- 1** **<csr\_name>** is the name of a CSR from the list of current CSRs.

- To approve all pending CSRs, run the following command:

```
$ oc get csr -o go-template='{{range .items}}{{if not .status}}{{.metadata.name}}{"\n"}{{end}}{{end}}' | xargs --no-run-if-empty oc adm certificate approve
```



#### NOTE

Some Operators might not become available until some CSRs are approved.

- Now that your client requests are approved, you must review the server requests for each machine that you added to the cluster:

```
$ oc get csr
```

#### Example output

```
NAME      AGE   REQUESTOR                                     CONDITION
csr-bfd72 5m26s system:node:ip-10-0-50-126.us-east-2.compute.internal
Pending
```

```
csr-c57lv 5m26s system:node:ip-10-0-95-157.us-east-2.compute.internal
Pending
...
```

- If the remaining CSRs are not approved, and are in the **Pending** status, approve the CSRs for your cluster machines:

- To approve them individually, run the following command for each valid CSR:

```
$ oc adm certificate approve <csr_name> 1
```

- 1** `<csr_name>` is the name of a CSR from the list of current CSRs.

- To approve all pending CSRs, run the following command:

```
$ oc get csr -o go-template='{{range .items}}{{if not .status}}{{.metadata.name}}{"\n"}
{{end}}{{end}} | xargs oc adm certificate approve
```

- After all client and server CSRs have been approved, the machines have the **Ready** status. Verify this by running the following command:

```
$ oc get nodes
```

### Example output

```
NAME      STATUS  ROLES  AGE  VERSION
master-0  Ready   master 73m  v1.23.0
master-1  Ready   master 73m  v1.23.0
master-2  Ready   master 74m  v1.23.0
worker-0  Ready   worker 11m  v1.23.0
worker-1  Ready   worker 11m  v1.23.0
```



### NOTE

It can take a few minutes after approval of the server CSRs for the machines to transition to the **Ready** status.

### Additional information

- For more information on CSRs, see [Certificate Signing Requests](#).

### 8.11.22. Adding the ingress DNS records

DNS zone configuration is removed when creating Kubernetes manifests and generating Ignition configs. You must manually create DNS records that point at the ingress load balancer. You can create either a wildcard `*.apps.{baseDomain}`, or specific records. You can use A, CNAME, and other records per your requirements.

### Prerequisites

- Configure a GCP account.

- Remove the DNS Zone configuration when creating Kubernetes manifests and generating Ignition configs.
- Create and configure a VPC and associated subnets in GCP.
- Create and configure networking and load balancers in GCP.
- Create control plane and compute roles.
- Create the bootstrap machine.
- Create the control plane machines.
- Create the worker machines.

## Procedure

1. Wait for the Ingress router to create a load balancer and populate the **EXTERNAL-IP** field:

```
$ oc -n openshift-ingress get service router-default
```

### Example output

```
NAME          TYPE          CLUSTER-IP    EXTERNAL-IP    PORT(S)          AGE
router-default LoadBalancer  172.30.18.154 35.233.157.184 80:32288/TCP,443:31215/TCP 98
```

2. Add the A record to your zones:

- To use A records:

- i. Export the variable for the router IP address:

```
$ export ROUTER_IP=`oc -n openshift-ingress get service router-default --no-headers | awk '{print $4}'`
```

- ii. Add the A record to the private zones:

```
$ if [ -f transaction.yaml ]; then rm transaction.yaml; fi
$ gcloud dns record-sets transaction start --zone ${INFRA_ID}-private-zone --project ${HOST_PROJECT} --account ${HOST_PROJECT_ACCOUNT}
$ gcloud dns record-sets transaction add ${ROUTER_IP} --name \*.apps.${CLUSTER_NAME}.${BASE_DOMAIN}. --ttl 300 --type A --zone ${INFRA_ID}-private-zone --project ${HOST_PROJECT} --account ${HOST_PROJECT_ACCOUNT}
$ gcloud dns record-sets transaction execute --zone ${INFRA_ID}-private-zone --project ${HOST_PROJECT} --account ${HOST_PROJECT_ACCOUNT}
```

- iii. For an external cluster, also add the A record to the public zones:

```
$ if [ -f transaction.yaml ]; then rm transaction.yaml; fi
$ gcloud dns record-sets transaction start --zone ${BASE_DOMAIN_ZONE_NAME} --project ${HOST_PROJECT} --account ${HOST_PROJECT_ACCOUNT}
$ gcloud dns record-sets transaction add ${ROUTER_IP} --name \*.apps.${CLUSTER_NAME}.${BASE_DOMAIN}. --ttl 300 --type A --zone
```



```

${BASE_DOMAIN_ZONE_NAME} --project ${HOST_PROJECT} --account
${HOST_PROJECT_ACCOUNT}
$ gcloud dns record-sets transaction execute --zone
${BASE_DOMAIN_ZONE_NAME} --project ${HOST_PROJECT} --account
${HOST_PROJECT_ACCOUNT}

```

- To add explicit domains instead of using a wildcard, create entries for each of the cluster's current routes:

```

$ oc get --all-namespaces -o jsonpath='{range .items[*]}{range .status.ingress[*]}{.host}
{"\n"}{end}{end}' routes

```

### Example output

```

oauth-openshift.apps.your.cluster.domain.example.com
console-openshift-console.apps.your.cluster.domain.example.com
downloads-openshift-console.apps.your.cluster.domain.example.com
alertmanager-main-openshift-monitoring.apps.your.cluster.domain.example.com
grafana-openshift-monitoring.apps.your.cluster.domain.example.com
prometheus-k8s-openshift-monitoring.apps.your.cluster.domain.example.com

```

## 8.11.23. Adding ingress firewall rules

The cluster requires several firewall rules. If you do not use a shared VPC, these rules are created by the Ingress Controller via the GCP cloud provider. When you use a shared VPC, you can either create cluster-wide firewall rules for all services now or create each rule based on events, when the cluster requests access. By creating each rule when the cluster requests access, you know exactly which firewall rules are required. By creating cluster-wide firewall rules, you can apply the same rule set across multiple clusters.

If you choose to create each rule based on events, you must create firewall rules after you provision the cluster and during the life of the cluster when the console notifies you that rules are missing. Events that are similar to the following event are displayed, and you must add the firewall rules that are required:

```

$ oc get events -n openshift-ingress --field-selector="reason=LoadBalancerManualChange"

```

### Example output

```

Firewall change required by security admin: `gcloud compute firewall-rules create k8s-fw-
a26e631036a3f46cba28f8df67266d55 --network example-network --description "
{"kubernetes.io/service-name":"openshift-ingress/router-default", "kubernetes.io/service-
ip":"35.237.236.234"}" --allow tcp:443,tcp:80 --source-ranges 0.0.0.0/0 --target-tags exampl-fqzq7-
master,exampl-fqzq7-worker --project example-project`

```

If you encounter issues when creating these rule-based events, you can configure the cluster-wide firewall rules while your cluster is running.

### 8.11.23.1. Creating cluster-wide firewall rules for a shared VPC in GCP

You can create cluster-wide firewall rules to allow the access that the OpenShift Container Platform cluster requires.

**WARNING**

If you do not choose to create firewall rules based on cluster events, you must create cluster-wide firewall rules.

**Prerequisites**

- You exported the variables that the Deployment Manager templates require to deploy your cluster.
- You created the networking and load balancing components in GCP that your cluster requires.

**Procedure**

1. Add a single firewall rule to allow the Google Cloud Engine health checks to access all of the services. This rule enables the ingress load balancers to determine the health status of their instances.

```
$ gcloud compute firewall-rules create --allow='tcp:30000-32767,udp:30000-32767' --
network="${CLUSTER_NETWORK}" --source-
ranges='130.211.0.0/22,35.191.0.0/16,209.85.152.0/22,209.85.204.0/22' --target-
tags="${INFRA_ID}-master,${INFRA_ID}-worker" ${INFRA_ID}-ingress-hc --
account=${HOST_PROJECT_ACCOUNT} --project=${HOST_PROJECT}
```

2. Add a single firewall rule to allow access to all cluster services:

- For an external cluster:

```
$ gcloud compute firewall-rules create --allow='tcp:80,tcp:443' --
network="${CLUSTER_NETWORK}" --source-ranges="0.0.0.0/0" --target-
tags="${INFRA_ID}-master,${INFRA_ID}-worker" ${INFRA_ID}-ingress --
account=${HOST_PROJECT_ACCOUNT} --project=${HOST_PROJECT}
```

- For a private cluster:

```
$ gcloud compute firewall-rules create --allow='tcp:80,tcp:443' --
network="${CLUSTER_NETWORK}" --source-ranges=${NETWORK_CIDR} --target-
tags="${INFRA_ID}-master,${INFRA_ID}-worker" ${INFRA_ID}-ingress --
account=${HOST_PROJECT_ACCOUNT} --project=${HOST_PROJECT}
```

Because this rule only allows traffic on TCP ports **80** and **443**, ensure that you add all the ports that your services use.

**8.11.24. Completing a GCP installation on user-provisioned infrastructure**

After you start the OpenShift Container Platform installation on Google Cloud Platform (GCP) user-provisioned infrastructure, you can monitor the cluster events until the cluster is ready.

**Prerequisites**

- Deploy the bootstrap machine for an OpenShift Container Platform cluster on user-provisioned GCP infrastructure.
- Install the **oc** CLI and log in.

## Procedure

1. Complete the cluster installation:

```
$ ./openshift-install --dir <installation_directory> wait-for install-complete 1
```

### Example output

```
INFO Waiting up to 30m0s for the cluster to initialize...
```

- 1** For **<installation\_directory>**, specify the path to the directory that you stored the installation files in.

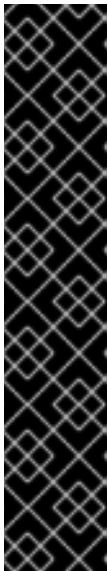

### IMPORTANT

- The Ignition config files that the installation program generates contain certificates that expire after 24 hours, which are then renewed at that time. If the cluster is shut down before renewing the certificates and the cluster is later restarted after the 24 hours have elapsed, the cluster automatically recovers the expired certificates. The exception is that you must manually approve the pending **node-bootstrapper** certificate signing requests (CSRs) to recover kubelet certificates. See the documentation for *Recovering from expired control plane certificates* for more information.
- It is recommended that you use Ignition config files within 12 hours after they are generated because the 24-hour certificate rotates from 16 to 22 hours after the cluster is installed. By using the Ignition config files within 12 hours, you can avoid installation failure if the certificate update runs during installation.

2. Observe the running state of your cluster.

- a. Run the following command to view the current cluster version and status:

```
$ oc get clusterversion
```

### Example output

```
NAME      VERSION  AVAILABLE  PROGRESSING  SINCE           STATUS
version   False    True       24m          Working towards 4.5.4: 99% complete
```

- b. Run the following command to view the Operators managed on the control plane by the Cluster Version Operator (CVO):

```
$ oc get clusteroperators
```

### Example output

NAME	VERSION	AVAILABLE	PROGRESSING	DEGRADED	SINCE
authentication	4.5.4	True	False	False	7m56s
cloud-credential	4.5.4	True	False	False	31m
cluster-autoscaler	4.5.4	True	False	False	16m
console	4.5.4	True	False	False	10m
csi-snapshot-controller	4.5.4	True	False	False	16m
dns	4.5.4	True	False	False	22m
etcd	4.5.4	False	False	False	25s
image-registry	4.5.4	True	False	False	16m
ingress	4.5.4	True	False	False	16m
insights	4.5.4	True	False	False	17m
kube-apiserver	4.5.4	True	False	False	19m
kube-controller-manager	4.5.4	True	False	False	20m
kube-scheduler	4.5.4	True	False	False	20m
kube-storage-version-migrator	4.5.4	True	False	False	16m
machine-api	4.5.4	True	False	False	22m
machine-config	4.5.4	True	False	False	22m
marketplace	4.5.4	True	False	False	16m
monitoring	4.5.4	True	False	False	10m
network	4.5.4	True	False	False	23m
node-tuning	4.5.4	True	False	False	23m
openshift-apiserver	4.5.4	True	False	False	17m
openshift-controller-manager	4.5.4	True	False	False	15m
openshift-samples	4.5.4	True	False	False	16m
operator-lifecycle-manager	4.5.4	True	False	False	22m
operator-lifecycle-manager-catalog	4.5.4	True	False	False	22m
operator-lifecycle-manager-packageserver	4.5.4	True	False	False	18m
service-ca	4.5.4	True	False	False	23m
service-catalog-apiserver	4.5.4	True	False	False	23m
service-catalog-controller-manager	4.5.4	True	False	False	23m
storage	4.5.4	True	False	False	17m

- c. Run the following command to view your cluster pods:

```
$ oc get pods --all-namespaces
```

### Example output

```

NAMESPACE          NAME
READY STATUS  RESTARTS AGE
kube-system        etcd-member-ip-10-0-3-111.us-east-
2.compute.internal 1/1   Running 0    35m
kube-system        etcd-member-ip-10-0-3-239.us-east-
2.compute.internal 1/1   Running 0    37m
kube-system        etcd-member-ip-10-0-3-24.us-east-
2.compute.internal 1/1   Running 0    35m
openshift-apiserver-operator
h7t2t              1/1   Running 1    37m
openshift-apiserver
1/1   Running 0    30m
openshift-apiserver
1/1   Running 0    29m
openshift-apiserver
1/1   Running 0    29m

```

```

...
openshift-service-ca-operator          openshift-service-ca-operator-66ff6dc6cd-
9r257          1/1    Running    0    37m
openshift-service-ca                  apiservice-cabundle-injector-695b6bcbc-cl5hm
1/1    Running    0    35m
openshift-service-ca                  configmap-cabundle-injector-8498544d7-
25qn6          1/1    Running    0    35m
openshift-service-ca                  service-serving-cert-signer-6445fc9c6-wqdqn
1/1    Running    0    35m
openshift-service-catalog-apiserver-operator  openshift-service-catalog-apiserver-
operator-549f44668b-b5q2w  1/1    Running    0    32m
openshift-service-catalog-controller-manager-operator  openshift-service-catalog-
controller-manager-operator-b78cr2lnm  1/1    Running    0    31m

```

When the current cluster version is **AVAILABLE**, the installation is complete.

### 8.11.25. Telemetry access for OpenShift Container Platform

In OpenShift Container Platform 4.10, the Telemetry service, which runs by default to provide metrics about cluster health and the success of updates, requires internet access. If your cluster is connected to the internet, Telemetry runs automatically, and your cluster is registered to [OpenShift Cluster Manager](#).

After you confirm that your [OpenShift Cluster Manager](#) inventory is correct, either maintained automatically by Telemetry or manually by using OpenShift Cluster Manager, [use subscription watch](#) to track your OpenShift Container Platform subscriptions at the account or multi-cluster level.

#### Additional resources

- See [About remote health monitoring](#) for more information about the Telemetry service

### 8.11.26. Next steps

- [Customize your cluster](#).
- If necessary, you can [opt out of remote health reporting](#).

## 8.12. INSTALLING A CLUSTER ON GCP IN A RESTRICTED NETWORK WITH USER-PROVISIONED INFRASTRUCTURE

In OpenShift Container Platform version 4.10, you can install a cluster on Google Cloud Platform (GCP) that uses infrastructure that you provide and an internal mirror of the installation release content.

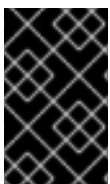

#### IMPORTANT

While you can install an OpenShift Container Platform cluster by using mirrored installation release content, your cluster still requires internet access to use the GCP APIs.

The steps for performing a user-provided infrastructure install are outlined here. Several [Deployment Manager](#) templates are provided to assist in completing these steps or to help model your own. You are also free to create the required resources through other methods.

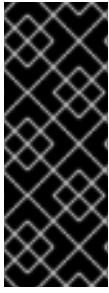

## IMPORTANT

The steps for performing a user-provisioned infrastructure installation are provided as an example only. Installing a cluster with infrastructure you provide requires knowledge of the cloud provider and the installation process of OpenShift Container Platform. Several Deployment Manager templates are provided to assist in completing these steps or to help model your own. You are also free to create the required resources through other methods; the templates are just an example.

### 8.12.1. Prerequisites

- You reviewed details about the [OpenShift Container Platform installation and update](#) processes.
- You read the documentation on [selecting a cluster installation method and preparing it for users](#).
- You [created a registry on your mirror host](#) and obtained the **imageContentSources** data for your version of OpenShift Container Platform.

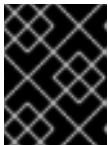

## IMPORTANT

Because the installation media is on the mirror host, you can use that computer to complete all installation steps.

- If you use a firewall, you [configured it to allow the sites](#) that your cluster requires access to. While you might need to grant access to more sites, you must grant access to **\*.googleapis.com** and **accounts.google.com**.
- If the cloud identity and access management (IAM) APIs are not accessible in your environment, or if you do not want to store an administrator-level credential secret in the **kube-system** namespace, you can [manually create and maintain IAM credentials](#).

### 8.12.2. About installations in restricted networks

In OpenShift Container Platform 4.10, you can perform an installation that does not require an active connection to the internet to obtain software components. Restricted network installations can be completed using installer-provisioned infrastructure or user-provisioned infrastructure, depending on the cloud platform to which you are installing the cluster.

If you choose to perform a restricted network installation on a cloud platform, you still require access to its cloud APIs. Some cloud functions, like Amazon Web Service's Route 53 DNS and IAM services, require internet access. Depending on your network, you might require less internet access for an installation on bare metal hardware or on VMware vSphere.

To complete a restricted network installation, you must create a registry that mirrors the contents of the OpenShift image registry and contains the installation media. You can create this registry on a mirror host, which can access both the internet and your closed network, or by using other methods that meet your restrictions.



## IMPORTANT

Because of the complexity of the configuration for user-provisioned installations, consider completing a standard user-provisioned infrastructure installation before you attempt a restricted network installation using user-provisioned infrastructure. Completing this test installation might make it easier to isolate and troubleshoot any issues that might arise during your installation in a restricted network.

### 8.12.2.1. Additional limits

Clusters in restricted networks have the following additional limitations and restrictions:

- The **ClusterVersion** status includes an **Unable to retrieve available updates** error.
- By default, you cannot use the contents of the Developer Catalog because you cannot access the required image stream tags.

### 8.12.3. Internet access for OpenShift Container Platform

In OpenShift Container Platform 4.10, you require access to the internet to obtain the images that are necessary to install your cluster.

You must have internet access to:

- Access [OpenShift Cluster Manager](#) to download the installation program and perform subscription management. If the cluster has internet access and you do not disable Telemetry, that service automatically entitles your cluster.
- Access [Quay.io](#) to obtain the packages that are required to install your cluster.
- Obtain the packages that are required to perform cluster updates.



## IMPORTANT

If your cluster cannot have direct internet access, you can perform a restricted network installation on some types of infrastructure that you provision. During that process, you download the required content and use it to populate a mirror registry with the installation packages. With some installation types, the environment that you install your cluster in will not require internet access. Before you update the cluster, you update the content of the mirror registry.

### 8.12.4. Configuring your GCP project

Before you can install OpenShift Container Platform, you must configure a Google Cloud Platform (GCP) project to host it.

#### 8.12.4.1. Creating a GCP project

To install OpenShift Container Platform, you must create a project in your Google Cloud Platform (GCP) account to host the cluster.

#### Procedure

- Create a project to host your OpenShift Container Platform cluster. See [Creating and Managing Projects](#) in the GCP documentation.

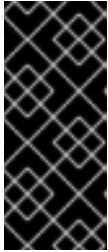

## IMPORTANT

Your GCP project must use the Premium Network Service Tier if you are using installer-provisioned infrastructure. The Standard Network Service Tier is not supported for clusters installed using the installation program. The installation program configures internal load balancing for the **api-int.<cluster\_name>.<base\_domain>** URL; the Premium Tier is required for internal load balancing.

### 8.12.4.2. Enabling API services in GCP

Your Google Cloud Platform (GCP) project requires access to several API services to complete OpenShift Container Platform installation.

#### Prerequisites

- You created a project to host your cluster.

#### Procedure

- Enable the following required API services in the project that hosts your cluster. You can also enable optional API services which are not required for installation. See [Enabling services](#) in the GCP documentation.

**Table 8.55. Required API services**

API service	Console service name
Compute Engine API	<b>compute.googleapis.com</b>
Cloud Resource Manager API	<b>cloudresourcemanager.googleapis.com</b>
Google DNS API	<b>dns.googleapis.com</b>
IAM Service Account Credentials API	<b>iamcredentials.googleapis.com</b>
Identity and Access Management (IAM) API	<b>iam.googleapis.com</b>
Service Usage API	<b>serviceusage.googleapis.com</b>

**Table 8.56. Optional API services**

API service	Console service name
Google Cloud APIs	<b>cloudapis.googleapis.com</b>
Service Management API	<b>servicemanagement.googleapis.com</b>
Google Cloud Storage JSON API	<b>storage-api.googleapis.com</b>



API service	Console service name
Cloud Storage	<b>storage-component.googleapis.com</b>

### 8.12.4.3. Configuring DNS for GCP

To install OpenShift Container Platform, the Google Cloud Platform (GCP) account you use must have a dedicated public hosted zone in the same project that you host the OpenShift Container Platform cluster. This zone must be authoritative for the domain. The DNS service provides cluster DNS resolution and name lookup for external connections to the cluster.

#### Procedure

1. Identify your domain, or subdomain, and registrar. You can transfer an existing domain and registrar or obtain a new one through GCP or another source.



#### NOTE

If you purchase a new domain, it can take time for the relevant DNS changes to propagate. For more information about purchasing domains through Google, see [Google Domains](#).

2. Create a public hosted zone for your domain or subdomain in your GCP project. See [Creating public zones](#) in the GCP documentation. Use an appropriate root domain, such as **openshiftcorp.com**, or subdomain, such as **clusters.openshiftcorp.com**.
3. Extract the new authoritative name servers from the hosted zone records. See [Look up your Cloud DNS name servers](#) in the GCP documentation. You typically have four name servers.
4. Update the registrar records for the name servers that your domain uses. For example, if you registered your domain to Google Domains, see the following topic in the Google Domains Help: [How to switch to custom name servers](#).
5. If you migrated your root domain to Google Cloud DNS, migrate your DNS records. See [Migrating to Cloud DNS](#) in the GCP documentation.
6. If you use a subdomain, follow your company's procedures to add its delegation records to the parent domain. This process might include a request to your company's IT department or the division that controls the root domain and DNS services for your company.

### 8.12.4.4. GCP account limits

The OpenShift Container Platform cluster uses a number of Google Cloud Platform (GCP) components, but the default [Quotas](#) do not affect your ability to install a default OpenShift Container Platform cluster.

A default cluster, which contains three compute and three control plane machines, uses the following resources. Note that some resources are required only during the bootstrap process and are removed after the cluster deploys.

#### Table 8.57. GCP resources used in a default cluster

Service	Component	Location	Total resources required	Resources removed after bootstrap
Service account	IAM	Global	5	0
Firewall rules	Networking	Global	11	1
Forwarding rules	Compute	Global	2	0
Health checks	Compute	Global	2	0
Images	Compute	Global	1	0
Networks	Networking	Global	1	0
Routers	Networking	Global	1	0
Routes	Networking	Global	2	0
Subnetworks	Compute	Global	2	0
Target pools	Networking	Global	2	0



## NOTE

If any of the quotas are insufficient during installation, the installation program displays an error that states both which quota was exceeded and the region.

Be sure to consider your actual cluster size, planned cluster growth, and any usage from other clusters that are associated with your account. The CPU, static IP addresses, and persistent disk SSD (storage) quotas are the ones that are most likely to be insufficient.

If you plan to deploy your cluster in one of the following regions, you will exceed the maximum storage quota and are likely to exceed the CPU quota limit:

- **asia-east2**
- **asia-northeast2**
- **asia-south1**
- **australia-southeast1**
- **europa-north1**
- **europa-west2**
- **europa-west3**
- **europa-west6**

- **northamerica-northeast1**
- **southamerica-east1**
- **us-west2**

You can increase resource quotas from the [GCP console](#), but you might need to file a support ticket. Be sure to plan your cluster size early so that you can allow time to resolve the support ticket before you install your OpenShift Container Platform cluster.

#### 8.12.4.5. Creating a service account in GCP

OpenShift Container Platform requires a Google Cloud Platform (GCP) service account that provides authentication and authorization to access data in the Google APIs. If you do not have an existing IAM service account that contains the required roles in your project, you must create one.

##### Prerequisites

- You created a project to host your cluster.

##### Procedure

1. Create a service account in the project that you use to host your OpenShift Container Platform cluster. See [Creating a service account](#) in the GCP documentation.
2. Grant the service account the appropriate permissions. You can either grant the individual permissions that follow or assign the **Owner** role to it. See [Granting roles to a service account for specific resources](#).

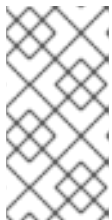

##### NOTE

While making the service account an owner of the project is the easiest way to gain the required permissions, it means that service account has complete control over the project. You must determine if the risk that comes from offering that power is acceptable.

3. Create the service account key in JSON format. See [Creating service account keys](#) in the GCP documentation.

The service account key is required to create a cluster.

#### 8.12.4.6. Required GCP roles

When you attach the **Owner** role to the service account that you create, you grant that service account all permissions, including those that are required to install OpenShift Container Platform. If your organization's security policies require a more restrictive set of permissions, you can create a service account with the following permissions. If you deploy your cluster into an existing virtual private cloud (VPC), the service account does not require certain networking permissions, which are noted in the following lists:

##### Required roles for the installation program

- Compute Admin
- Security Admin

- Service Account Admin
- Service Account Key Admin
- Service Account User
- Storage Admin

#### Required roles for creating network resources during installation

- DNS Administrator

#### Required roles for user-provisioned GCP infrastructure

- Deployment Manager Editor

The roles are applied to the service accounts that the control plane and compute machines use:

**Table 8.58. GCP service account permissions**

Account	Roles
Control Plane	<b>roles/compute.instanceAdmin</b>
	<b>roles/compute.networkAdmin</b>
	<b>roles/compute.securityAdmin</b>
	<b>roles/storage.admin</b>
	<b>roles/iam.serviceAccountUser</b>
Compute	<b>roles/compute.viewer</b>
	<b>roles/storage.admin</b>

#### 8.12.4.7. Required GCP permissions for user-provisioned infrastructure

When you attach the **Owner** role to the service account that you create, you grant that service account all permissions, including those that are required to install OpenShift Container Platform.

If your organization's security policies require a more restrictive set of permissions, you can create [custom roles](#) with the necessary permissions. The following permissions are required for the user-provisioned infrastructure for creating and deleting the OpenShift Container Platform cluster.

##### Example 8.68. Required permissions for creating network resources

- **compute.addresses.create**
- **compute.addresses.createInternal**
- **compute.addresses.delete**

- `compute.addresses.get`
- `compute.addresses.list`
- `compute.addresses.use`
- `compute.addresses.useInternal`
- `compute.firewalls.create`
- `compute.firewalls.delete`
- `compute.firewalls.get`
- `compute.firewalls.list`
- `compute.forwardingRules.create`
- `compute.forwardingRules.get`
- `compute.forwardingRules.list`
- `compute.forwardingRules.setLabels`
- `compute.networks.create`
- `compute.networks.get`
- `compute.networks.list`
- `compute.networks.updatePolicy`
- `compute.routers.create`
- `compute.routers.get`
- `compute.routers.list`
- `compute.routers.update`
- `compute.routes.list`
- `compute.subnetworks.create`
- `compute.subnetworks.get`
- `compute.subnetworks.list`
- `compute.subnetworks.use`
- `compute.subnetworks.useExternallp`

Example 8.69. Required permissions for creating load balancer resources

- `compute.regionBackendServices.create`
- `compute.regionBackendServices.get`

- `compute.regionBackendServices.list`
- `compute.regionBackendServices.update`
- `compute.regionBackendServices.use`
- `compute.targetPools.addInstance`
- `compute.targetPools.create`
- `compute.targetPools.get`
- `compute.targetPools.list`
- `compute.targetPools.removeInstance`
- `compute.targetPools.use`

Example 8.70. Required permissions for creating DNS resources

- `dns.changes.create`
- `dns.changes.get`
- `dns.managedZones.create`
- `dns.managedZones.get`
- `dns.managedZones.list`
- `dns.networks.bindPrivateDNSZone`
- `dns.resourceRecordSets.create`
- `dns.resourceRecordSets.list`
- `dns.resourceRecordSets.update`

Example 8.71. Required permissions for creating Service Account resources

- `iam.serviceAccountKeys.create`
- `iam.serviceAccountKeys.delete`
- `iam.serviceAccountKeys.get`
- `iam.serviceAccountKeys.list`
- `iam.serviceAccounts.actAs`
- `iam.serviceAccounts.create`
- `iam.serviceAccounts.delete`
- `iam.serviceAccounts.get`

- `iam.serviceAccounts.list`
- `resourcemanager.projects.get`
- `resourcemanager.projects.getIamPolicy`
- `resourcemanager.projects.setIamPolicy`

Example 8.72. Required permissions for creating compute resources

- `compute.disks.create`
- `compute.disks.get`
- `compute.disks.list`
- `compute.instanceGroups.create`
- `compute.instanceGroups.delete`
- `compute.instanceGroups.get`
- `compute.instanceGroups.list`
- `compute.instanceGroups.update`
- `compute.instanceGroups.use`
- `compute.instances.create`
- `compute.instances.delete`
- `compute.instances.get`
- `compute.instances.list`
- `compute.instances.setLabels`
- `compute.instances.setMetadata`
- `compute.instances.setServiceAccount`
- `compute.instances.setTags`
- `compute.instances.use`
- `compute.machineTypes.get`
- `compute.machineTypes.list`

Example 8.73. Required for creating storage resources

- `storage.buckets.create`
- `storage.buckets.delete`

- `storage.buckets.get`
- `storage.buckets.list`
- `storage.objects.create`
- `storage.objects.delete`
- `storage.objects.get`
- `storage.objects.list`

Example 8.74. Required permissions for creating health check resources

- `compute.healthChecks.create`
- `compute.healthChecks.get`
- `compute.healthChecks.list`
- `compute.healthChecks.useReadOnly`
- `compute.httpHealthChecks.create`
- `compute.httpHealthChecks.get`
- `compute.httpHealthChecks.list`
- `compute.httpHealthChecks.useReadOnly`

Example 8.75. Required permissions to get GCP zone and region related information

- `compute.globalOperations.get`
- `compute.regionOperations.get`
- `compute.regions.list`
- `compute.zoneOperations.get`
- `compute.zones.get`
- `compute.zones.list`

Example 8.76. Required permissions for checking services and quotas

- `monitoring.timeSeries.list`
- `serviceusage.quotas.get`
- `serviceusage.services.list`



**Example 8.77. Required IAM permissions for installation**

- `iam.roles.get`

**Example 8.78. Required Images permissions for installation**

- `compute.images.create`
- `compute.images.delete`
- `compute.images.get`
- `compute.images.list`

**Example 8.79. Optional permission for running gather bootstrap**

- `compute.instances.getSerialPortOutput`

**Example 8.80. Required permissions for deleting network resources**

- `compute.addresses.delete`
- `compute.addresses.deleteInternal`
- `compute.addresses.list`
- `compute.firewalls.delete`
- `compute.firewalls.list`
- `compute.forwardingRules.delete`
- `compute.forwardingRules.list`
- `compute.networks.delete`
- `compute.networks.list`
- `compute.networks.updatePolicy`
- `compute.routers.delete`
- `compute.routers.list`
- `compute.routes.list`
- `compute.subnetworks.delete`
- `compute.subnetworks.list`

**Example 8.81. Required permissions for deleting load balancer resources**

- `compute.regionBackendServices.delete`
- `compute.regionBackendServices.list`
- `compute.targetPools.delete`
- `compute.targetPools.list`

Example 8.82. Required permissions for deleting DNS resources

- `dns.changes.create`
- `dns.managedZones.delete`
- `dns.managedZones.get`
- `dns.managedZones.list`
- `dns.resourceRecordSets.delete`
- `dns.resourceRecordSets.list`

Example 8.83. Required permissions for deleting Service Account resources

- `iam.serviceAccounts.delete`
- `iam.serviceAccounts.get`
- `iam.serviceAccounts.list`
- `resourcemanager.projects.getIamPolicy`
- `resourcemanager.projects.setIamPolicy`

Example 8.84. Required permissions for deleting compute resources

- `compute.disks.delete`
- `compute.disks.list`
- `compute.instanceGroups.delete`
- `compute.instanceGroups.list`
- `compute.instances.delete`
- `compute.instances.list`
- `compute.instances.stop`
- `compute.machineTypes.list`

Example 8.85. Required for deleting storage resources

- `storage.buckets.delete`
- `storage.buckets.getiamPolicy`
- `storage.buckets.list`
- `storage.objects.delete`
- `storage.objects.list`

Example 8.86. Required permissions for deleting health check resources

- `compute.healthChecks.delete`
- `compute.healthChecks.list`
- `compute.httpHealthChecks.delete`
- `compute.httpHealthChecks.list`

Example 8.87. Required Images permissions for deletion

- `compute.images.delete`
- `compute.images.list`

Example 8.88. Required permissions to get Region related information

- `compute.regions.get`

Example 8.89. Required Deployment Manager permissions

- `deploymentmanager.deployments.create`
- `deploymentmanager.deployments.delete`
- `deploymentmanager.deployments.get`
- `deploymentmanager.deployments.list`
- `deploymentmanager.manifests.get`
- `deploymentmanager.operations.get`
- `deploymentmanager.resources.list`

#### 8.12.4.8. Supported GCP regions

You can deploy an OpenShift Container Platform cluster to the following Google Cloud Platform (GCP) regions:

- **asia-east1** (Changhua County, Taiwan)
- **asia-east2** (Hong Kong)
- **asia-northeast1** (Tokyo, Japan)
- **asia-northeast2** (Osaka, Japan)
- **asia-northeast3** (Seoul, South Korea)
- **asia-south1** (Mumbai, India)
- **asia-south2** (Delhi, India)
- **asia-southeast1** (Jurong West, Singapore)
- **asia-southeast2** (Jakarta, Indonesia)
- **australia-southeast1** (Sydney, Australia)
- **australia-southeast2** (Melbourne, Australia)
- **europa-central2** (Warsaw, Poland)
- **europa-north1** (Hamina, Finland)
- **europa-southwest1** (Madrid, Spain)
- **europa-west1** (St. Ghislain, Belgium)
- **europa-west2** (London, England, UK)
- **europa-west3** (Frankfurt, Germany)
- **europa-west4** (Eemshaven, Netherlands)
- **europa-west6** (Zürich, Switzerland)
- **europa-west8** (Milan, Italy)
- **europa-west9** (Paris, France)
- **northamerica-northeast1** (Montréal, Québec, Canada)
- **northamerica-northeast2** (Toronto, Ontario, Canada)
- **southamerica-east1** (São Paulo, Brazil)
- **southamerica-west1** (Santiago, Chile)
- **us-central1** (Council Bluffs, Iowa, USA)
- **us-east1** (Moncks Corner, South Carolina, USA)
- **us-east4** (Ashburn, Northern Virginia, USA)

- **us-east5** (Columbus, Ohio)
- **us-south1** (Dallas, Texas)
- **us-west1** (The Dalles, Oregon, USA)
- **us-west2** (Los Angeles, California, USA)
- **us-west3** (Salt Lake City, Utah, USA)
- **us-west4** (Las Vegas, Nevada, USA)

#### 8.12.4.9. Installing and configuring CLI tools for GCP

To install OpenShift Container Platform on Google Cloud Platform (GCP) using user-provisioned infrastructure, you must install and configure the CLI tools for GCP.

##### Prerequisites

- You created a project to host your cluster.
- You created a service account and granted it the required permissions.

##### Procedure

1. Install the following binaries in **\$PATH**:

- **gcloud**
- **gsutil**

See [Install the latest Cloud SDK version](#) in the GCP documentation.

2. Authenticate using the **gcloud** tool with your configured service account.

See [Authorizing with a service account](#) in the GCP documentation.

#### 8.12.5. Requirements for a cluster with user-provisioned infrastructure

For a cluster that contains user-provisioned infrastructure, you must deploy all of the required machines.

This section describes the requirements for deploying OpenShift Container Platform on user-provisioned infrastructure.

##### 8.12.5.1. Required machines for cluster installation

The smallest OpenShift Container Platform clusters require the following hosts:

**Table 8.59. Minimum required hosts**

Hosts	Description
One temporary bootstrap machine	The cluster requires the bootstrap machine to deploy the OpenShift Container Platform cluster on the three control plane machines. You can remove the bootstrap machine after you install the cluster.

Hosts	Description
Three control plane machines	The control plane machines run the Kubernetes and OpenShift Container Platform services that form the control plane.
At least two compute machines, which are also known as worker machines.	The workloads requested by OpenShift Container Platform users run on the compute machines.

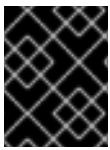

### IMPORTANT

To maintain high availability of your cluster, use separate physical hosts for these cluster machines.

The bootstrap and control plane machines must use Red Hat Enterprise Linux CoreOS (RHCOS) as the operating system. However, the compute machines can choose between Red Hat Enterprise Linux CoreOS (RHCOS), Red Hat Enterprise Linux (RHEL) 8.4, or RHEL 8.5.

Note that RHCOS is based on Red Hat Enterprise Linux (RHEL) 8 and inherits all of its hardware certifications and requirements. See [Red Hat Enterprise Linux technology capabilities and limits](#) .

#### 8.12.5.2. Minimum resource requirements for cluster installation

Each cluster machine must meet the following minimum requirements:

**Table 8.60. Minimum resource requirements**

Machine	Operating System	vCPU [1]	Virtual RAM	Storage	IOPS [2]
Bootstrap	RHCOS	4	16 GB	100 GB	300
Control plane	RHCOS	4	16 GB	100 GB	300
Compute	RHCOS, RHEL 8.4, or RHEL 8.5 <sup>[3]</sup>	2	8 GB	100 GB	300

1. One vCPU is equivalent to one physical core when simultaneous multithreading (SMT), or hyperthreading, is not enabled. When enabled, use the following formula to calculate the corresponding ratio:  $(\text{threads per core} \times \text{cores}) \times \text{sockets} = \text{vCPUs}$ .
2. OpenShift Container Platform and Kubernetes are sensitive to disk performance, and faster storage is recommended, particularly for etcd on the control plane nodes which require a 10 ms p99 fsync duration. Note that on many cloud platforms, storage size and IOPS scale together, so

you might need to over-allocate storage volume to obtain sufficient performance.

3. As with all user-provisioned installations, if you choose to use RHEL compute machines in your cluster, you take responsibility for all operating system life cycle management and maintenance, including performing system updates, applying patches, and completing all other required tasks. Use of RHEL 7 compute machines is deprecated and has been removed in OpenShift Container Platform 4.10 and later.

If an instance type for your platform meets the minimum requirements for cluster machines, it is supported to use in OpenShift Container Platform.

### 8.12.5.3. Tested instance types for GCP

The following Google Cloud Platform instance types have been tested with OpenShift Container Platform.

#### Example 8.90. Machine series

- **C2**
- **C2D**
- **C3**
- **E2**
- **M1**
- **N1**
- **N2**
- **N2D**
- **Tau T2D**

### 8.12.5.4. Using custom machine types

Using a custom machine type to install a OpenShift Container Platform cluster is supported.

Consider the following when using a custom machine type:

- Similar to predefined instance types, custom machine types must meet the minimum resource requirements for control plane and compute machines. For more information, see "Minimum resource requirements for cluster installation".
- The name of the custom machine type must adhere to the following syntax:  
**custom-`<number_of_cpus>-<amount_of_memory_in_mb>`**

For example, **custom-6-20480**.

### 8.12.6. Creating the installation files for GCP

To install OpenShift Container Platform on Google Cloud Platform (GCP) using user-provisioned infrastructure, you must generate the files that the installation program needs to deploy your cluster

and modify them so that the cluster creates only the machines that it will use. You generate and customize the **install-config.yaml** file, Kubernetes manifests, and Ignition config files. You also have the option to first set up a separate **var** partition during the preparation phases of installation.

### 8.12.6.1. Optional: Creating a separate **/var** partition

It is recommended that disk partitioning for OpenShift Container Platform be left to the installer. However, there are cases where you might want to create separate partitions in a part of the filesystem that you expect to grow.

OpenShift Container Platform supports the addition of a single partition to attach storage to either the **/var** partition or a subdirectory of **/var**. For example:

- **/var/lib/containers**: Holds container-related content that can grow as more images and containers are added to a system.
- **/var/lib/etcd**: Holds data that you might want to keep separate for purposes such as performance optimization of etcd storage.
- **/var**: Holds data that you might want to keep separate for purposes such as auditing.

Storing the contents of a **/var** directory separately makes it easier to grow storage for those areas as needed and reinstall OpenShift Container Platform at a later date and keep that data intact. With this method, you will not have to pull all your containers again, nor will you have to copy massive log files when you update systems.

Because **/var** must be in place before a fresh installation of Red Hat Enterprise Linux CoreOS (RHCOS), the following procedure sets up the separate **/var** partition by creating a machine config manifest that is inserted during the **openshift-install** preparation phases of an OpenShift Container Platform installation.



#### IMPORTANT

If you follow the steps to create a separate **/var** partition in this procedure, it is not necessary to create the Kubernetes manifest and Ignition config files again as described later in this section.

#### Procedure

1. Create a directory to hold the OpenShift Container Platform installation files:

```
$ mkdir $HOME/clusterconfig
```

2. Run **openshift-install** to create a set of files in the **manifest** and **openshift** subdirectories. Answer the system questions as you are prompted:

```
$ openshift-install create manifests --dir $HOME/clusterconfig
```

#### Example output

```
? SSH Public Key ...
INFO Credentials loaded from the "myprofile" profile in file "/home/myuser/.aws/credentials"
INFO Consuming Install Config from target directory
```



INFO Manifests created in: `$HOME/clusterconfig/manifests` and `$HOME/clusterconfig/openshift`

- Optional: Confirm that the installation program created manifests in the **clusterconfig/openshift** directory:

```
$ ls $HOME/clusterconfig/openshift/
```

### Example output

```
99_kubeadmin-password-secret.yaml
99_openshift-cluster-api_master-machines-0.yaml
99_openshift-cluster-api_master-machines-1.yaml
99_openshift-cluster-api_master-machines-2.yaml
...
```

- Create a Butane config that configures the additional partition. For example, name the file **`$HOME/clusterconfig/98-var-partition.bu`**, change the disk device name to the name of the storage device on the **worker** systems, and set the storage size as appropriate. This example places the **`/var`** directory on a separate partition:

```
variant: openshift
version: 4.10.0
metadata:
  labels:
    machineconfiguration.openshift.io/role: worker
  name: 98-var-partition
storage:
  disks:
    - device: /dev/<device_name> ❶
      partitions:
        - label: var
          start_mib: <partition_start_offset> ❷
          size_mib: <partition_size> ❸
      filesystems:
        - device: /dev/disk/by-partlabel/var
          path: /var
          format: xfs
          mount_options: [defaults, prjquota] ❹
          with_mount_unit: true
```

- The storage device name of the disk that you want to partition.
- When adding a data partition to the boot disk, a minimum value of 25000 MiB (Mebibytes) is recommended. The root file system is automatically resized to fill all available space up to the specified offset. If no value is specified, or if the specified value is smaller than the recommended minimum, the resulting root file system will be too small, and future reinstalls of RHCOS might overwrite the beginning of the data partition.
- The size of the data partition in mebibytes.
- The **prjquota** mount option must be enabled for filesystems used for container storage.

**NOTE**

When creating a separate **/var** partition, you cannot use different instance types for worker nodes, if the different instance types do not have the same device name.

5. Create a manifest from the Butane config and save it to the **clusterconfig/openshift** directory. For example, run the following command:

```
$ butane $HOME/clusterconfig/98-var-partition.bu -o $HOME/clusterconfig/openshift/98-var-partition.yaml
```

6. Run **openshift-install** again to create Ignition configs from a set of files in the **manifest** and **openshift** subdirectories:

```
$ openshift-install create ignition-configs --dir $HOME/clusterconfig
$ ls $HOME/clusterconfig/
auth bootstrap.ign master.ign metadata.json worker.ign
```

Now you can use the Ignition config files as input to the installation procedures to install Red Hat Enterprise Linux CoreOS (RHCOS) systems.

### 8.12.6.2. Creating the installation configuration file

You can customize the OpenShift Container Platform cluster you install on Google Cloud Platform (GCP).

#### Prerequisites

- Obtain the OpenShift Container Platform installation program and the pull secret for your cluster. For a restricted network installation, these files are on your mirror host.
- Have the **imageContentSources** values that were generated during mirror registry creation.
- Obtain the contents of the certificate for your mirror registry.
- Obtain service principal permissions at the subscription level.

#### Procedure

1. Create the **install-config.yaml** file.
  - a. Change to the directory that contains the installation program and run the following command:

```
$ ./openshift-install create install-config --dir <installation_directory> 1
```

- 1** For **<installation\_directory>**, specify the directory name to store the files that the installation program creates.



## IMPORTANT

Specify an empty directory. Some installation assets, like bootstrap X.509 certificates have short expiration intervals, so you must not reuse an installation directory. If you want to reuse individual files from another cluster installation, you can copy them into your directory. However, the file names for the installation assets might change between releases. Use caution when copying installation files from an earlier OpenShift Container Platform version.

- b. At the prompts, provide the configuration details for your cloud:
  - i. Optional: Select an SSH key to use to access your cluster machines.



## NOTE

For production OpenShift Container Platform clusters on which you want to perform installation debugging or disaster recovery, specify an SSH key that your **ssh-agent** process uses.

- ii. Select **gcp** as the platform to target.
  - iii. If you have not configured the service account key for your GCP account on your computer, you must obtain it from GCP and paste the contents of the file or enter the absolute path to the file.
  - iv. Select the project ID to provision the cluster in. The default value is specified by the service account that you configured.
  - v. Select the region to deploy the cluster to.
  - vi. Select the base domain to deploy the cluster to. The base domain corresponds to the public DNS zone that you created for your cluster.
  - vii. Enter a descriptive name for your cluster.
  - viii. Paste the [pull secret from the Red Hat OpenShift Cluster Manager](#) .
2. Edit the **install-config.yaml** file to give the additional information that is required for an installation in a restricted network.

- a. Update the **pullSecret** value to contain the authentication information for your registry:

```
pullSecret: '{"auths":{"<mirror_host_name>:5000":{"auth": "<credentials>","email":
"you@example.com"}}}'
```

For **<mirror\_host\_name>**, specify the registry domain name that you specified in the certificate for your mirror registry, and for **<credentials>**, specify the base64-encoded user name and password for your mirror registry.

- b. Add the **additionalTrustBundle** parameter and value.

```
additionalTrustBundle: |
-----BEGIN CERTIFICATE-----
```



bypass the proxy if necessary.



## NOTE

The **Proxy** object **status.noProxy** field is populated with the values of the **networking.machineNetwork[].cidr**, **networking.clusterNetwork[].cidr**, and **networking.serviceNetwork[]** fields from your installation configuration.

For installations on Amazon Web Services (AWS), Google Cloud Platform (GCP), Microsoft Azure, and Red Hat OpenStack Platform (RHOSP), the **Proxy** object **status.noProxy** field is also populated with the instance metadata endpoint (**169.254.169.254**).

## Procedure

1. Edit your **install-config.yaml** file and add the proxy settings. For example:

```
apiVersion: v1
baseDomain: my.domain.com
proxy:
  httpProxy: http://<username>:<pswd>@<ip>:<port> 1
  httpsProxy: https://<username>:<pswd>@<ip>:<port> 2
  noProxy: example.com 3
  additionalTrustBundle: | 4
    -----BEGIN CERTIFICATE-----
    <MY_TRUSTED_CA_CERT>
    -----END CERTIFICATE-----
  ...
```

- 1 A proxy URL to use for creating HTTP connections outside the cluster. The URL scheme must be **http**.
- 2 A proxy URL to use for creating HTTPS connections outside the cluster.
- 3 A comma-separated list of destination domain names, IP addresses, or other network CIDRs to exclude from proxying. Preface a domain with **.** to match subdomains only. For example, **.y.com** matches **x.y.com**, but not **y.com**. Use **\*** to bypass the proxy for all destinations.
- 4 If provided, the installation program generates a config map that is named **user-ca-bundle** in the **openshift-config** namespace that contains one or more additional CA certificates that are required for proxying HTTPS connections. The Cluster Network Operator then creates a **trusted-ca-bundle** config map that merges these contents with the Red Hat Enterprise Linux CoreOS (RHCOS) trust bundle, and this config map is referenced in the **trustedCA** field of the **Proxy** object. The **additionalTrustBundle** field is required unless the proxy's identity certificate is signed by an authority from the RHCOS trust bundle.



## NOTE

The installation program does not support the proxy **readinessEndpoints** field.

**NOTE**

If the installer times out, restart and then complete the deployment by using the **wait-for** command of the installer. For example:

```
$ ./openshift-install wait-for install-complete --log-level debug
```

2. Save the file and reference it when installing OpenShift Container Platform.

The installation program creates a cluster-wide proxy that is named **cluster** that uses the proxy settings in the provided **install-config.yaml** file. If no proxy settings are provided, a **cluster Proxy** object is still created, but it will have a nil **spec**.

**NOTE**

Only the **Proxy** object named **cluster** is supported, and no additional proxies can be created.

#### 8.12.6.4. Creating the Kubernetes manifest and Ignition config files

Because you must modify some cluster definition files and manually start the cluster machines, you must generate the Kubernetes manifest and Ignition config files that the cluster needs to configure the machines.

The installation configuration file transforms into the Kubernetes manifests. The manifests wrap into the Ignition configuration files, which are later used to configure the cluster machines.

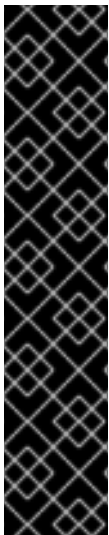
**IMPORTANT**

- The Ignition config files that the OpenShift Container Platform installation program generates contain certificates that expire after 24 hours, which are then renewed at that time. If the cluster is shut down before renewing the certificates and the cluster is later restarted after the 24 hours have elapsed, the cluster automatically recovers the expired certificates. The exception is that you must manually approve the pending **node-bootstrapper** certificate signing requests (CSRs) to recover kubelet certificates. See the documentation for *Recovering from expired control plane certificates* for more information.
- It is recommended that you use Ignition config files within 12 hours after they are generated because the 24-hour certificate rotates from 16 to 22 hours after the cluster is installed. By using the Ignition config files within 12 hours, you can avoid installation failure if the certificate update runs during installation.

**Prerequisites**

- You obtained the OpenShift Container Platform installation program. For a restricted network installation, these files are on your mirror host.
- You created the **install-config.yaml** installation configuration file.

**Procedure**

1. Change to the directory that contains the OpenShift Container Platform installation program and generate the Kubernetes manifests for the cluster:

```
$ ./openshift-install create manifests --dir <installation_directory> 1
```

- 1 For **<installation\_directory>**, specify the installation directory that contains the **install-config.yaml** file you created.

2. Remove the Kubernetes manifest files that define the control plane machines:

```
$ rm -f <installation_directory>/openshift/99_openshift-cluster-api_master-machines-*.yaml
```

By removing these files, you prevent the cluster from automatically generating control plane machines.

3. Optional: If you do not want the cluster to provision compute machines, remove the Kubernetes manifest files that define the worker machines:

```
$ rm -f <installation_directory>/openshift/99_openshift-cluster-api_worker-machineset-*.yaml
```

Because you create and manage the worker machines yourself, you do not need to initialize these machines.

4. Check that the **mastersSchedulable** parameter in the **<installation\_directory>/manifests/cluster-scheduler-02-config.yml** Kubernetes manifest file is set to **false**. This setting prevents pods from being scheduled on the control plane machines:

- a. Open the **<installation\_directory>/manifests/cluster-scheduler-02-config.yml** file.
- b. Locate the **mastersSchedulable** parameter and ensure that it is set to **false**.
- c. Save and exit the file.

5. Optional: If you do not want [the Ingress Operator](#) to create DNS records on your behalf, remove the **privateZone** and **publicZone** sections from the **<installation\_directory>/manifests/cluster-dns-02-config.yml** DNS configuration file:

```
apiVersion: config.openshift.io/v1
kind: DNS
metadata:
  creationTimestamp: null
  name: cluster
spec:
  baseDomain: example.openshift.com
  privateZone: 1
    id: mycluster-100419-private-zone
  publicZone: 2
    id: example.openshift.com
status: {}
```

- 1 2 Remove this section completely.

If you do so, you must add ingress DNS records manually in a later step.

- To create the Ignition configuration files, run the following command from the directory that contains the installation program:

```
$ ./openshift-install create ignition-configs --dir <installation_directory> 1
```

- For **<installation\_directory>**, specify the same installation directory.

Ignition config files are created for the bootstrap, control plane, and compute nodes in the installation directory. The **kubeadmin-password** and **kubeconfig** files are created in the **./<installation\_directory>/auth** directory:

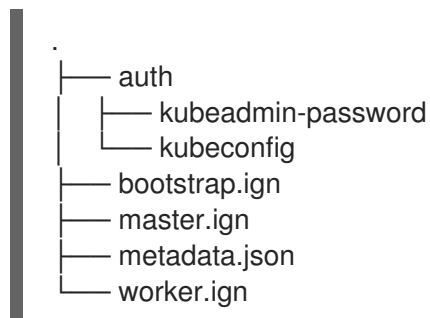

### Additional resources

- [Optional: Adding the ingress DNS records](#)

## 8.12.7. Exporting common variables

### 8.12.7.1. Extracting the infrastructure name

The Ignition config files contain a unique cluster identifier that you can use to uniquely identify your cluster in Google Cloud Platform (GCP). The infrastructure name is also used to locate the appropriate GCP resources during an OpenShift Container Platform installation. The provided Deployment Manager templates contain references to this infrastructure name, so you must extract it.

### Prerequisites

- You obtained the OpenShift Container Platform installation program and the pull secret for your cluster.
- You generated the Ignition config files for your cluster.
- You installed the **jq** package.

### Procedure

- To extract and view the infrastructure name from the Ignition config file metadata, run the following command:

```
$ jq -r .infraID <installation_directory>/metadata.json 1
```

- For **<installation\_directory>**, specify the path to the directory that you stored the installation files in.



## Example output

```
openshift-vw9j6 1
```

- 1** The output of this command is your cluster name and a random string.

### 8.12.7.2. Exporting common variables for Deployment Manager templates

You must export a common set of variables that are used with the provided Deployment Manager templates used to assist in completing a user-provided infrastructure install on Google Cloud Platform (GCP).



#### NOTE

Specific Deployment Manager templates can also require additional exported variables, which are detailed in their related procedures.

#### Prerequisites

- Obtain the OpenShift Container Platform installation program and the pull secret for your cluster.
- Generate the Ignition config files for your cluster.
- Install the **jq** package.

#### Procedure

1. Export the following common variables to be used by the provided Deployment Manager templates:

```
$ export BASE_DOMAIN='<base_domain>'
$ export BASE_DOMAIN_ZONE_NAME='<base_domain_zone_name>'
$ export NETWORK_CIDR='10.0.0.0/16'
$ export MASTER_SUBNET_CIDR='10.0.0.0/17'
$ export WORKER_SUBNET_CIDR='10.0.128.0/17'

$ export KUBECONFIG=<installation_directory>/auth/kubeconfig 1
$ export CLUSTER_NAME=`jq -r .clusterName <installation_directory>/metadata.json`
$ export INFRA_ID=`jq -r .infraID <installation_directory>/metadata.json`
$ export PROJECT_NAME=`jq -r .gcp.projectID <installation_directory>/metadata.json`
$ export REGION=`jq -r .gcp.region <installation_directory>/metadata.json`
```

- 1** For **<installation\_directory>**, specify the path to the directory that you stored the installation files in.

### 8.12.8. Creating a VPC in GCP

You must create a VPC in Google Cloud Platform (GCP) for your OpenShift Container Platform cluster to use. You can customize the VPC to meet your requirements. One way to create the VPC is to modify the provided Deployment Manager template.



## NOTE

If you do not use the provided Deployment Manager template to create your GCP infrastructure, you must review the provided information and manually create the infrastructure. If your cluster does not initialize correctly, you might have to contact Red Hat support with your installation logs.

## Prerequisites

- Configure a GCP account.
- Generate the Ignition config files for your cluster.

## Procedure

1. Copy the template from the **Deployment Manager template for the VPC** section of this topic and save it as **01\_vpc.py** on your computer. This template describes the VPC that your cluster requires.
2. Create a **01\_vpc.yaml** resource definition file:

```
$ cat <<EOF >01_vpc.yaml
imports:
- path: 01_vpc.py

resources:
- name: cluster-vpc
  type: 01_vpc.py
  properties:
    infra_id: '${INFRA_ID}' 1
    region: '${REGION}' 2
    master_subnet_cidr: '${MASTER_SUBNET_CIDR}' 3
    worker_subnet_cidr: '${WORKER_SUBNET_CIDR}' 4
EOF
```

- 1** **infra\_id** is the **INFRA\_ID** infrastructure name from the extraction step.
- 2** **region** is the region to deploy the cluster into, for example **us-central1**.
- 3** **master\_subnet\_cidr** is the CIDR for the master subnet, for example **10.0.0.0/17**.
- 4** **worker\_subnet\_cidr** is the CIDR for the worker subnet, for example **10.0.128.0/17**.

3. Create the deployment by using the **gcloud** CLI:

```
$ gcloud deployment-manager deployments create ${INFRA_ID}-vpc --config 01_vpc.yaml
```

### 8.12.8.1. Deployment Manager template for the VPC

You can use the following Deployment Manager template to deploy the VPC that you need for your OpenShift Container Platform cluster:

#### Example 8.91. 01\_vpc.py Deployment Manager template

-

```

def GenerateConfig(context):

    resources = [{
        'name': context.properties['infra_id'] + '-network',
        'type': 'compute.v1.network',
        'properties': {
            'region': context.properties['region'],
            'autoCreateSubnetworks': False
        }
    }, {
        'name': context.properties['infra_id'] + '-master-subnet',
        'type': 'compute.v1.subnetwork',
        'properties': {
            'region': context.properties['region'],
            'network': '$(ref.' + context.properties['infra_id'] + '-network.selfLink)',
            'ipCidrRange': context.properties['master_subnet_cidr']
        }
    }, {
        'name': context.properties['infra_id'] + '-worker-subnet',
        'type': 'compute.v1.subnetwork',
        'properties': {
            'region': context.properties['region'],
            'network': '$(ref.' + context.properties['infra_id'] + '-network.selfLink)',
            'ipCidrRange': context.properties['worker_subnet_cidr']
        }
    }, {
        'name': context.properties['infra_id'] + '-router',
        'type': 'compute.v1.router',
        'properties': {
            'region': context.properties['region'],
            'network': '$(ref.' + context.properties['infra_id'] + '-network.selfLink)',
            'nats': [{
                'name': context.properties['infra_id'] + '-nat-master',
                'natIppAllocateOption': 'AUTO_ONLY',
                'minPortsPerVm': 7168,
                'sourceSubnetworkIppRangesToNat': 'LIST_OF_SUBNETWORKS',
                'subnetworks': [{
                    'name': '$(ref.' + context.properties['infra_id'] + '-master-subnet.selfLink)',
                    'sourceIppRangesToNat': ['ALL_IP_RANGES']
                }]
            }]
        }
    }, {
        'name': context.properties['infra_id'] + '-nat-worker',
        'natIppAllocateOption': 'AUTO_ONLY',
        'minPortsPerVm': 512,
        'sourceSubnetworkIppRangesToNat': 'LIST_OF_SUBNETWORKS',
        'subnetworks': [{
            'name': '$(ref.' + context.properties['infra_id'] + '-worker-subnet.selfLink)',
            'sourceIppRangesToNat': ['ALL_IP_RANGES']
        }]
    }
    ]

    return {'resources': resources}

```

## 8.12.9. Networking requirements for user-provisioned infrastructure

All the Red Hat Enterprise Linux CoreOS (RHCOS) machines require networking to be configured in **initramfs** during boot to fetch their Ignition config files.

### 8.12.9.1. Setting the cluster node hostnames through DHCP

On Red Hat Enterprise Linux CoreOS (RHCOS) machines, the hostname is set through NetworkManager. By default, the machines obtain their hostname through DHCP. If the hostname is not provided by DHCP, set statically through kernel arguments, or another method, it is obtained through a reverse DNS lookup. Reverse DNS lookup occurs after the network has been initialized on a node and can take time to resolve. Other system services can start prior to this and detect the hostname as **localhost** or similar. You can avoid this by using DHCP to provide the hostname for each cluster node.

Additionally, setting the hostnames through DHCP can bypass any manual DNS record name configuration errors in environments that have a DNS split-horizon implementation.

### 8.12.9.2. Network connectivity requirements

You must configure the network connectivity between machines to allow OpenShift Container Platform cluster components to communicate. Each machine must be able to resolve the hostnames of all other machines in the cluster.

This section provides details about the ports that are required.

**Table 8.61. Ports used for all-machine to all-machine communications**

Protocol	Port	Description
ICMP	N/A	Network reachability tests
TCP	<b>1936</b>	Metrics
	<b>9000-9999</b>	Host level services, including the node exporter on ports <b>9100-9101</b> and the Cluster Version Operator on port <b>9099</b> .
	<b>10250-10259</b>	The default ports that Kubernetes reserves
	<b>10256</b>	openshift-sdn
UDP	<b>4789</b>	VXLAN
	<b>6081</b>	Geneve
	<b>9000-9999</b>	Host level services, including the node exporter on ports <b>9100-9101</b> .
	<b>500</b>	IPsec IKE packets
	<b>4500</b>	IPsec NAT-T packets

Protocol	Port	Description
TCP/UDP	<b>30000-32767</b>	Kubernetes node port
ESP	N/A	IPsec Encapsulating Security Payload (ESP)

Table 8.62. Ports used for all-machine to control plane communications

Protocol	Port	Description
TCP	<b>6443</b>	Kubernetes API

Table 8.63. Ports used for control plane machine to control plane machine communications

Protocol	Port	Description
TCP	<b>2379-2380</b>	etcd server and peer ports

### 8.12.10. Creating load balancers in GCP

You must configure load balancers in Google Cloud Platform (GCP) for your OpenShift Container Platform cluster to use. One way to create these components is to modify the provided Deployment Manager template.



#### NOTE

If you do not use the provided Deployment Manager template to create your GCP infrastructure, you must review the provided information and manually create the infrastructure. If your cluster does not initialize correctly, you might have to contact Red Hat support with your installation logs.

#### Prerequisites

- Configure a GCP account.
- Generate the Ignition config files for your cluster.
- Create and configure a VPC and associated subnets in GCP.

#### Procedure

1. Copy the template from the **Deployment Manager template for the internal load balancer** section of this topic and save it as **02\_lb\_int.py** on your computer. This template describes the internal load balancing objects that your cluster requires.
2. For an external cluster, also copy the template from the **Deployment Manager template for the external load balancer** section of this topic and save it as **02\_lb\_ext.py** on your computer. This template describes the external load balancing objects that your cluster requires.
3. Export the variables that the deployment template uses:

- a. Export the cluster network location:

```
$ export CLUSTER_NETWORK=(`gcloud compute networks describe ${INFRA_ID}-
network --format json | jq -r .selfLink`)
```

- b. Export the control plane subnet location:

```
$ export CONTROL_SUBNET=(`gcloud compute networks subnets describe
${INFRA_ID}-master-subnet --region=${REGION} --format json | jq -r .selfLink`)
```

- c. Export the three zones that the cluster uses:

```
$ export ZONE_0=(`gcloud compute regions describe ${REGION} --format=json | jq -r
.zones[0] | cut -d "/" -f9`)
```

```
$ export ZONE_1=(`gcloud compute regions describe ${REGION} --format=json | jq -r
.zones[1] | cut -d "/" -f9`)
```

```
$ export ZONE_2=(`gcloud compute regions describe ${REGION} --format=json | jq -r
.zones[2] | cut -d "/" -f9`)
```

4. Create a **02\_infra.yaml** resource definition file:

```
$ cat <<EOF >02_infra.yaml
imports:
- path: 02_lb_ext.py
- path: 02_lb_int.py 1
resources:
- name: cluster-lb-ext 2
  type: 02_lb_ext.py
  properties:
    infra_id: '${INFRA_ID}' 3
    region: '${REGION}' 4
- name: cluster-lb-int
  type: 02_lb_int.py
  properties:
    cluster_network: '${CLUSTER_NETWORK}'
    control_subnet: '${CONTROL_SUBNET}' 5
    infra_id: '${INFRA_ID}'
    region: '${REGION}'
    zones: 6
    - '${ZONE_0}'
    - '${ZONE_1}'
    - '${ZONE_2}'
EOF
```

**1** **2** Required only when deploying an external cluster.

**3** **infra\_id** is the **INFRA\_ID** infrastructure name from the extraction step.

**4** **region** is the region to deploy the cluster into, for example **us-central1**.

**5** **control\_subnet** is the URI to the control subnet.

- 6** **zones** are the zones to deploy the control plane instances into, like **us-east1-b**, **us-east1-c**, and **us-east1-d**.

5. Create the deployment by using the **gcloud** CLI:

```
$ gcloud deployment-manager deployments create ${INFRA_ID}-infra --config 02_infra.yaml
```

6. Export the cluster IP address:

```
$ export CLUSTER_IP=(`gcloud compute addresses describe ${INFRA_ID}-cluster-ip --region=${REGION} --format json | jq -r .address`)
```

7. For an external cluster, also export the cluster public IP address:

```
$ export CLUSTER_PUBLIC_IP=(`gcloud compute addresses describe ${INFRA_ID}-cluster-public-ip --region=${REGION} --format json | jq -r .address`)
```

### 8.12.10.1. Deployment Manager template for the external load balancer

You can use the following Deployment Manager template to deploy the external load balancer that you need for your OpenShift Container Platform cluster:

#### Example 8.92. 02\_lb\_ext.py Deployment Manager template

```
def GenerateConfig(context):

    resources = [{
        'name': context.properties['infra_id'] + '-cluster-public-ip',
        'type': 'compute.v1.address',
        'properties': {
            'region': context.properties['region']
        }
    }, {
        # Refer to docs/dev/kube-apiserver-health-check.md on how to correctly setup health check
        # probe for kube-apiserver
        'name': context.properties['infra_id'] + '-api-http-health-check',
        'type': 'compute.v1.httpHealthCheck',
        'properties': {
            'port': 6080,
            'requestPath': '/readyz'
        }
    }, {
        'name': context.properties['infra_id'] + '-api-target-pool',
        'type': 'compute.v1.targetPool',
        'properties': {
            'region': context.properties['region'],
            'healthChecks': ['$(ref.' + context.properties['infra_id'] + '-api-http-health-check.selfLink)'],
            'instances': []
        }
    }, {
        'name': context.properties['infra_id'] + '-api-forwarding-rule',
        'type': 'compute.v1.forwardingRule',
        'properties': {
```

```

        'region': context.properties['region'],
        'IPAddress': '$(ref.' + context.properties['infra_id'] + '-cluster-public-ip.selfLink)',
        'target': '$(ref.' + context.properties['infra_id'] + '-api-target-pool.selfLink)',
        'portRange': '6443'
    }
}
]]

return {'resources': resources}

```

### 8.12.10.2. Deployment Manager template for the internal load balancer

You can use the following Deployment Manager template to deploy the internal load balancer that you need for your OpenShift Container Platform cluster:

#### Example 8.93. 02\_lb\_int.py Deployment Manager template

```

def GenerateConfig(context):

    backends = []
    for zone in context.properties['zones']:
        backends.append({
            'group': '$(ref.' + context.properties['infra_id'] + '-master-' + zone + '-ig' + '.selfLink)'
        })

    resources = [{
        'name': context.properties['infra_id'] + '-cluster-ip',
        'type': 'compute.v1.address',
        'properties': {
            'addressType': 'INTERNAL',
            'region': context.properties['region'],
            'subnetwork': context.properties['control_subnet']
        }
    }, {
        # Refer to docs/dev/kube-apiserver-health-check.md on how to correctly setup health check
        # probe for kube-apiserver
        'name': context.properties['infra_id'] + '-api-internal-health-check',
        'type': 'compute.v1.healthCheck',
        'properties': {
            'httpsHealthCheck': {
                'port': 6443,
                'requestPath': '/readyz'
            },
            'type': "HTTPS"
        }
    }, {
        'name': context.properties['infra_id'] + '-api-internal-backend-service',
        'type': 'compute.v1.regionBackendService',
        'properties': {
            'backends': backends,
            'healthChecks': ['$(ref.' + context.properties['infra_id'] + '-api-internal-health-
check.selfLink)'],
            'loadBalancingScheme': 'INTERNAL',
            'region': context.properties['region'],
            'protocol': 'TCP',

```



```

        'timeoutSec': 120
    }
}, {
    'name': context.properties['infra_id'] + '-api-internal-forwarding-rule',
    'type': 'compute.v1.forwardingRule',
    'properties': {
        'backendService': '$(ref.' + context.properties['infra_id'] + '-api-internal-backend-
service.selfLink)',
        'IPAddress': '$(ref.' + context.properties['infra_id'] + '-cluster-ip.selfLink)',
        'loadBalancingScheme': 'INTERNAL',
        'ports': ['6443','22623'],
        'region': context.properties['region'],
        'subnetwork': context.properties['control_subnet']
    }
}
]]

for zone in context.properties['zones']:
    resources.append({
        'name': context.properties['infra_id'] + '-master-' + zone + '-ig',
        'type': 'compute.v1.instanceGroup',
        'properties': {
            'namedPorts': [
                {
                    'name': 'ignition',
                    'port': 22623
                }, {
                    'name': 'https',
                    'port': 6443
                }
            ],
            'network': context.properties['cluster_network'],
            'zone': zone
        }
    })

return {'resources': resources}

```

You will need this template in addition to the **02\_lb\_ext.py** template when you create an external cluster.

### 8.12.11. Creating a private DNS zone in GCP

You must configure a private DNS zone in Google Cloud Platform (GCP) for your OpenShift Container Platform cluster to use. One way to create this component is to modify the provided Deployment Manager template.



#### NOTE

If you do not use the provided Deployment Manager template to create your GCP infrastructure, you must review the provided information and manually create the infrastructure. If your cluster does not initialize correctly, you might have to contact Red Hat support with your installation logs.

## Prerequisites

- Configure a GCP account.
- Generate the Ignition config files for your cluster.
- Create and configure a VPC and associated subnets in GCP.

## Procedure

1. Copy the template from the **Deployment Manager template for the private DNS** section of this topic and save it as **02\_dns.py** on your computer. This template describes the private DNS objects that your cluster requires.
2. Create a **02\_dns.yaml** resource definition file:

```
$ cat <<EOF >02_dns.yaml
imports:
- path: 02_dns.py

resources:
- name: cluster-dns
  type: 02_dns.py
  properties:
    infra_id: '${INFRA_ID}' 1
    cluster_domain: '${CLUSTER_NAME}.${BASE_DOMAIN}' 2
    cluster_network: '${CLUSTER_NETWORK}' 3
EOF
```

- 1** **infra\_id** is the **INFRA\_ID** infrastructure name from the extraction step.
- 2** **cluster\_domain** is the domain for the cluster, for example **openshift.example.com**.
- 3** **cluster\_network** is the **selfLink** URL to the cluster network.

3. Create the deployment by using the **gcloud** CLI:

```
$ gcloud deployment-manager deployments create ${INFRA_ID}-dns --config 02_dns.yaml
```

4. The templates do not create DNS entries due to limitations of Deployment Manager, so you must create them manually:
  - a. Add the internal DNS entries:

```
$ if [ -f transaction.yaml ]; then rm transaction.yaml; fi
$ gcloud dns record-sets transaction start --zone ${INFRA_ID}-private-zone
$ gcloud dns record-sets transaction add ${CLUSTER_IP} --name
api.${CLUSTER_NAME}.${BASE_DOMAIN}. --ttl 60 --type A --zone ${INFRA_ID}-
private-zone
$ gcloud dns record-sets transaction add ${CLUSTER_IP} --name api-
int.${CLUSTER_NAME}.${BASE_DOMAIN}. --ttl 60 --type A --zone ${INFRA_ID}-
private-zone
$ gcloud dns record-sets transaction execute --zone ${INFRA_ID}-private-zone
```

- b. For an external cluster, also add the external DNS entries:

```
$ if [ -f transaction.yaml ]; then rm transaction.yaml; fi
$ gcloud dns record-sets transaction start --zone ${BASE_DOMAIN_ZONE_NAME}
$ gcloud dns record-sets transaction add ${CLUSTER_PUBLIC_IP} --name
api.${CLUSTER_NAME}.${BASE_DOMAIN}. --ttl 60 --type A --zone
${BASE_DOMAIN_ZONE_NAME}
$ gcloud dns record-sets transaction execute --zone ${BASE_DOMAIN_ZONE_NAME}
```

### 8.12.11.1. Deployment Manager template for the private DNS

You can use the following Deployment Manager template to deploy the private DNS that you need for your OpenShift Container Platform cluster:

#### Example 8.94. 02\_dns.py Deployment Manager template

```
def GenerateConfig(context):

    resources = [{
        'name': context.properties['infra_id'] + '-private-zone',
        'type': 'dns.v1.managedZone',
        'properties': {
            'description': "",
            'dnsName': context.properties['cluster_domain'] + '.',
            'visibility': 'private',
            'privateVisibilityConfig': {
                'networks': [{
                    'networkUrl': context.properties['cluster_network']
                }]
            }
        }
    }]

    return {'resources': resources}
```

### 8.12.12. Creating firewall rules in GCP

You must create firewall rules in Google Cloud Platform (GCP) for your OpenShift Container Platform cluster to use. One way to create these components is to modify the provided Deployment Manager template.



#### NOTE

If you do not use the provided Deployment Manager template to create your GCP infrastructure, you must review the provided information and manually create the infrastructure. If your cluster does not initialize correctly, you might have to contact Red Hat support with your installation logs.

#### Prerequisites

- Configure a GCP account.

- Generate the Ignition config files for your cluster.
- Create and configure a VPC and associated subnets in GCP.

## Procedure

1. Copy the template from the **Deployment Manager template for firewall rules** section of this topic and save it as **03\_firewall.py** on your computer. This template describes the security groups that your cluster requires.
2. Create a **03\_firewall.yaml** resource definition file:

```
$ cat <<EOF >03_firewall.yaml
imports:
- path: 03_firewall.py

resources:
- name: cluster-firewall
  type: 03_firewall.py
  properties:
    allowed_external_cidr: '0.0.0.0/0' 1
    infra_id: '${INFRA_ID}' 2
    cluster_network: '${CLUSTER_NETWORK}' 3
    network_cidr: '${NETWORK_CIDR}' 4
EOF
```

- 1 **allowed\_external\_cidr** is the CIDR range that can access the cluster API and SSH to the bootstrap host. For an internal cluster, set this value to **\${NETWORK\_CIDR}**.
- 2 **infra\_id** is the **INFRA\_ID** infrastructure name from the extraction step.
- 3 **cluster\_network** is the **selfLink** URL to the cluster network.
- 4 **network\_cidr** is the CIDR of the VPC network, for example **10.0.0.0/16**.

3. Create the deployment by using the **gcloud** CLI:

```
$ gcloud deployment-manager deployments create ${INFRA_ID}-firewall --config
03_firewall.yaml
```

### 8.12.12.1. Deployment Manager template for firewall rules

You can use the following Deployment Manager template to deploy the firewall rules that you need for your OpenShift Container Platform cluster:

#### Example 8.95. 03\_firewall.py Deployment Manager template

```
def GenerateConfig(context):

    resources = [{
        'name': context.properties['infra_id'] + '-bootstrap-in-ssh',
        'type': 'compute.v1.firewall',
        'properties': {
```

```

    'network': context.properties['cluster_network'],
    'allowed': [{
      'IPProtocol': 'tcp',
      'ports': ['22']
    }],
    'sourceRanges': [context.properties['allowed_external_cidr']],
    'targetTags': [context.properties['infra_id'] + '-bootstrap']
  }
}, {
  'name': context.properties['infra_id'] + '-api',
  'type': 'compute.v1.firewall',
  'properties': {
    'network': context.properties['cluster_network'],
    'allowed': [{
      'IPProtocol': 'tcp',
      'ports': ['6443']
    }],
    'sourceRanges': [context.properties['allowed_external_cidr']],
    'targetTags': [context.properties['infra_id'] + '-master']
  }
}, {
  'name': context.properties['infra_id'] + '-health-checks',
  'type': 'compute.v1.firewall',
  'properties': {
    'network': context.properties['cluster_network'],
    'allowed': [{
      'IPProtocol': 'tcp',
      'ports': ['6080', '6443', '22624']
    }],
    'sourceRanges': ['35.191.0.0/16', '130.211.0.0/22', '209.85.152.0/22', '209.85.204.0/22'],
    'targetTags': [context.properties['infra_id'] + '-master']
  }
}, {
  'name': context.properties['infra_id'] + '-etcd',
  'type': 'compute.v1.firewall',
  'properties': {
    'network': context.properties['cluster_network'],
    'allowed': [{
      'IPProtocol': 'tcp',
      'ports': ['2379-2380']
    }],
    'sourceTags': [context.properties['infra_id'] + '-master'],
    'targetTags': [context.properties['infra_id'] + '-master']
  }
}, {
  'name': context.properties['infra_id'] + '-control-plane',
  'type': 'compute.v1.firewall',
  'properties': {
    'network': context.properties['cluster_network'],
    'allowed': [{
      'IPProtocol': 'tcp',
      'ports': ['10257']
    }],
  }, {
    'IPProtocol': 'tcp',
    'ports': ['10259']
  }, {

```

```

        'IPProtocol': 'tcp',
        'ports': ['22623']
    }],
    'sourceTags': [
        context.properties['infra_id'] + '-master',
        context.properties['infra_id'] + '-worker'
    ],
    'targetTags': [context.properties['infra_id'] + '-master']
}
}, {
    'name': context.properties['infra_id'] + '-internal-network',
    'type': 'compute.v1.firewall',
    'properties': {
        'network': context.properties['cluster_network'],
        'allowed': [{
            'IPProtocol': 'icmp'
        }],
        'sourceRanges': [context.properties['network_cidr']],
        'targetTags': [
            context.properties['infra_id'] + '-master',
            context.properties['infra_id'] + '-worker'
        ]
    }
}, {
    'name': context.properties['infra_id'] + '-internal-cluster',
    'type': 'compute.v1.firewall',
    'properties': {
        'network': context.properties['cluster_network'],
        'allowed': [{
            'IPProtocol': 'udp',
            'ports': ['4789', '6081']
        }, {
            'IPProtocol': 'udp',
            'ports': ['500', '4500']
        }, {
            'IPProtocol': 'esp',
        }, {
            'IPProtocol': 'tcp',
            'ports': ['9000-9999']
        }, {
            'IPProtocol': 'udp',
            'ports': ['9000-9999']
        }, {
            'IPProtocol': 'tcp',
            'ports': ['10250']
        }, {
            'IPProtocol': 'tcp',
            'ports': ['30000-32767']
        }, {
            'IPProtocol': 'udp',
            'ports': ['30000-32767']
        }],
        'sourceTags': [

```

```

        context.properties['infra_id'] + '-master',
        context.properties['infra_id'] + '-worker'
    ],
    'targetTags': [
        context.properties['infra_id'] + '-master',
        context.properties['infra_id'] + '-worker'
    ]
}
}}

return {'resources': resources}

```

### 8.12.13. Creating IAM roles in GCP

You must create IAM roles in Google Cloud Platform (GCP) for your OpenShift Container Platform cluster to use. One way to create these components is to modify the provided Deployment Manager template.



#### NOTE

If you do not use the provided Deployment Manager template to create your GCP infrastructure, you must review the provided information and manually create the infrastructure. If your cluster does not initialize correctly, you might have to contact Red Hat support with your installation logs.

#### Prerequisites

- Configure a GCP account.
- Generate the Ignition config files for your cluster.
- Create and configure a VPC and associated subnets in GCP.

#### Procedure

1. Copy the template from the **Deployment Manager template for IAM roles** section of this topic and save it as **03\_iam.py** on your computer. This template describes the IAM roles that your cluster requires.
2. Create a **03\_iam.yaml** resource definition file:

```

$ cat <<EOF >03_iam.yaml
imports:
- path: 03_iam.py
resources:
- name: cluster-iam
  type: 03_iam.py
  properties:
    infra_id: '${INFRA_ID}' 1
EOF

```

- 1** **infra\_id** is the **INFRA\_ID** infrastructure name from the extraction step.

3. Create the deployment by using the **gcloud** CLI:

```
$ gcloud deployment-manager deployments create ${INFRA_ID}-iam --config 03_iam.yaml
```

4. Export the variable for the master service account:

```
$ export MASTER_SERVICE_ACCOUNT=$(gcloud iam service-accounts list --filter "email~^${INFRA_ID}-m@${PROJECT_NAME}." --format json | jq -r '.[0].email')
```

5. Export the variable for the worker service account:

```
$ export WORKER_SERVICE_ACCOUNT=$(gcloud iam service-accounts list --filter "email~^${INFRA_ID}-w@${PROJECT_NAME}." --format json | jq -r '.[0].email')
```

6. Export the variable for the subnet that hosts the compute machines:

```
$ export COMPUTE_SUBNET=$(gcloud compute networks subnets describe ${INFRA_ID}-worker-subnet --region=${REGION} --format json | jq -r .selfLink)
```

7. The templates do not create the policy bindings due to limitations of Deployment Manager, so you must create them manually:

```
$ gcloud projects add-iam-policy-binding ${PROJECT_NAME} --member "serviceAccount:${MASTER_SERVICE_ACCOUNT}" --role "roles/compute.instanceAdmin"
$ gcloud projects add-iam-policy-binding ${PROJECT_NAME} --member "serviceAccount:${MASTER_SERVICE_ACCOUNT}" --role "roles/compute.networkAdmin"
$ gcloud projects add-iam-policy-binding ${PROJECT_NAME} --member "serviceAccount:${MASTER_SERVICE_ACCOUNT}" --role "roles/compute.securityAdmin"
$ gcloud projects add-iam-policy-binding ${PROJECT_NAME} --member "serviceAccount:${MASTER_SERVICE_ACCOUNT}" --role "roles/iam.serviceAccountUser"
$ gcloud projects add-iam-policy-binding ${PROJECT_NAME} --member "serviceAccount:${MASTER_SERVICE_ACCOUNT}" --role "roles/storage.admin"

$ gcloud projects add-iam-policy-binding ${PROJECT_NAME} --member "serviceAccount:${WORKER_SERVICE_ACCOUNT}" --role "roles/compute.viewer"
$ gcloud projects add-iam-policy-binding ${PROJECT_NAME} --member "serviceAccount:${WORKER_SERVICE_ACCOUNT}" --role "roles/storage.admin"
```

8. Create a service account key and store it locally for later use:

```
$ gcloud iam service-accounts keys create service-account-key.json --iam-account=${MASTER_SERVICE_ACCOUNT}
```

### 8.12.13.1. Deployment Manager template for IAM roles

You can use the following Deployment Manager template to deploy the IAM roles that you need for your OpenShift Container Platform cluster:

#### Example 8.96. 03\_iam.py Deployment Manager template

```
def GenerateConfig(context):
    resources = [{
```



```

    'name': context.properties['infra_id'] + '-master-node-sa',
    'type': 'iam.v1.serviceAccount',
    'properties': {
      'accountId': context.properties['infra_id'] + '-m',
      'displayName': context.properties['infra_id'] + '-master-node'
    }
  }, {
    'name': context.properties['infra_id'] + '-worker-node-sa',
    'type': 'iam.v1.serviceAccount',
    'properties': {
      'accountId': context.properties['infra_id'] + '-w',
      'displayName': context.properties['infra_id'] + '-worker-node'
    }
  }
]

return {'resources': resources}

```

### 8.12.14. Creating the RHCOS cluster image for the GCP infrastructure

You must use a valid Red Hat Enterprise Linux CoreOS (RHCOS) image for Google Cloud Platform (GCP) for your OpenShift Container Platform nodes.

#### Procedure

1. Obtain the RHCOS image from the [RHCOS image mirror](#) page.

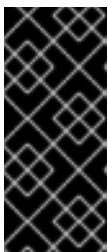

#### IMPORTANT

The RHCOS images might not change with every release of OpenShift Container Platform. You must download an image with the highest version that is less than or equal to the OpenShift Container Platform version that you install. Use the image version that matches your OpenShift Container Platform version if it is available.

The file name contains the OpenShift Container Platform version number in the format **rhcos-  
<version>-<arch>-gcp.<arch>.tar.gz**.

2. Create the Google storage bucket:

```
$ gsutil mb gs://<bucket_name>
```

3. Upload the RHCOS image to the Google storage bucket:

```
$ gsutil cp <downloaded_image_file_path>/rhcos-<version>-x86_64-gcp.x86_64.tar.gz
gs://<bucket_name>
```

4. Export the uploaded RHCOS image location as a variable:

```
$ export IMAGE_SOURCE=gs://<bucket_name>/rhcos-<version>-x86_64-gcp.x86_64.tar.gz
```

5. Create the cluster image:

```
$ gcloud compute images create "${INFRA_ID}-rhcos-image" \
  --source-uri="${IMAGE_SOURCE}"
```

### 8.12.15. Creating the bootstrap machine in GCP

You must create the bootstrap machine in Google Cloud Platform (GCP) to use during OpenShift Container Platform cluster initialization. One way to create this machine is to modify the provided Deployment Manager template.



#### NOTE

If you do not use the provided Deployment Manager template to create your bootstrap machine, you must review the provided information and manually create the infrastructure. If your cluster does not initialize correctly, you might have to contact Red Hat support with your installation logs.

#### Prerequisites

- Configure a GCP account.
- Generate the Ignition config files for your cluster.
- Create and configure a VPC and associated subnets in GCP.
- Create and configure networking and load balancers in GCP.
- Create control plane and compute roles.
- Ensure pyOpenSSL is installed.

#### Procedure

1. Copy the template from the **Deployment Manager template for the bootstrap machine** section of this topic and save it as **04\_bootstrap.py** on your computer. This template describes the bootstrap machine that your cluster requires.
2. Export the location of the Red Hat Enterprise Linux CoreOS (RHCOS) image that the installation program requires:

```
$ export CLUSTER_IMAGE=$(gcloud compute images describe ${INFRA_ID}-rhcos-image --
  format json | jq -r .selfLink)
```

3. Create a bucket and upload the **bootstrap.ign** file:

```
$ gsutil mb gs://${INFRA_ID}-bootstrap-ignition
```

```
$ gsutil cp <installation_directory>/bootstrap.ign gs://${INFRA_ID}-bootstrap-ignition/
```

4. Create a signed URL for the bootstrap instance to use to access the Ignition config. Export the URL from the output as a variable:

```
$ export BOOTSTRAP_IGN=`gsutil signurl -d 1h service-account-key.json gs://${INFRA_ID}-
  bootstrap-ignition/bootstrap.ign | grep "^gs:" | awk '{print $5}'`
```

5. Create a **04\_bootstrap.yaml** resource definition file:

```
$ cat <<EOF >04_bootstrap.yaml
imports:
- path: 04_bootstrap.py

resources:
- name: cluster-bootstrap
  type: 04_bootstrap.py
  properties:
    infra_id: '${INFRA_ID}' 1
    region: '${REGION}' 2
    zone: '${ZONE_0}' 3

    cluster_network: '${CLUSTER_NETWORK}' 4
    control_subnet: '${CONTROL_SUBNET}' 5
    image: '${CLUSTER_IMAGE}' 6
    machine_type: 'n1-standard-4' 7
    root_volume_size: '128' 8

    bootstrap_ign: '${BOOTSTRAP_IGN}' 9
EOF
```

- 1 **infra\_id** is the **INFRA\_ID** infrastructure name from the extraction step.
- 2 **region** is the region to deploy the cluster into, for example **us-central1**.
- 3 **zone** is the zone to deploy the bootstrap instance into, for example **us-central1-b**.
- 4 **cluster\_network** is the **selfLink** URL to the cluster network.
- 5 **control\_subnet** is the **selfLink** URL to the control subnet.
- 6 **image** is the **selfLink** URL to the RHCOS image.
- 7 **machine\_type** is the machine type of the instance, for example **n1-standard-4**.
- 8 **root\_volume\_size** is the boot disk size for the bootstrap machine.
- 9 **bootstrap\_ign** is the URL output when creating a signed URL.

6. Create the deployment by using the **gcloud** CLI:

```
$ gcloud deployment-manager deployments create ${INFRA_ID}-bootstrap --config
04_bootstrap.yaml
```

7. The templates do not manage load balancer membership due to limitations of Deployment Manager, so you must add the bootstrap machine manually.
- a. Add the bootstrap instance to the internal load balancer instance group:

```
$ gcloud compute instance-groups unmanaged add-instances \
  ${INFRA_ID}-bootstrap-ig --zone=${ZONE_0} --instances=${INFRA_ID}-bootstrap
```

- b. Add the bootstrap instance group to the internal load balancer backend service:

```
$ gcloud compute backend-services add-backend \
  ${INFRA_ID}-api-internal-backend-service --region=${REGION} --instance-
  group=${INFRA_ID}-bootstrap-ig --instance-group-zone=${ZONE_0}
```

### 8.12.15.1. Deployment Manager template for the bootstrap machine

You can use the following Deployment Manager template to deploy the bootstrap machine that you need for your OpenShift Container Platform cluster:

#### Example 8.97. 04\_bootstrap.py Deployment Manager template

```
def GenerateConfig(context):

    resources = [{
        'name': context.properties['infra_id'] + '-bootstrap-public-ip',
        'type': 'compute.v1.address',
        'properties': {
            'region': context.properties['region']
        }
    }, {
        'name': context.properties['infra_id'] + '-bootstrap',
        'type': 'compute.v1.instance',
        'properties': {
            'disks': [{
                'autoDelete': True,
                'boot': True,
                'initializeParams': {
                    'diskSizeGb': context.properties['root_volume_size'],
                    'sourceImage': context.properties['image']
                }
            }],
            'machineType': 'zones/' + context.properties['zone'] + '/machineTypes/' +
context.properties['machine_type'],
            'metadata': {
                'items': [{
                    'key': 'user-data',
                    'value': '{"ignition":{"config":{"replace":{"source":"' + context.properties['bootstrap_ign']
+ '"},"version":"3.2.0"}}}',
                }],
            },
            'networkInterfaces': [{
                'subnetwork': context.properties['control_subnet'],
                'accessConfigs': [{
                    'natIP': '${ref.' + context.properties['infra_id'] + '-bootstrap-public-ip.address}'
                }],
            }],
            'tags': {
                'items': [
                    context.properties['infra_id'] + '-master',
                    context.properties['infra_id'] + '-bootstrap'
                ]
            },
            'zone': context.properties['zone']
```

```

    }
  }, {
    'name': context.properties['infra_id'] + '-bootstrap-ig',
    'type': 'compute.v1.instanceGroup',
    'properties': {
      'namedPorts': [
        {
          'name': 'ignition',
          'port': 22623
        }, {
          'name': 'https',
          'port': 6443
        }
      ],
      'network': context.properties['cluster_network'],
      'zone': context.properties['zone']
    }
  }
]
}
]]

return {'resources': resources}

```

### 8.12.16. Creating the control plane machines in GCP

You must create the control plane machines in Google Cloud Platform (GCP) for your cluster to use. One way to create these machines is to modify the provided Deployment Manager template.



#### NOTE

If you do not use the provided Deployment Manager template to create your control plane machines, you must review the provided information and manually create the infrastructure. If your cluster does not initialize correctly, you might have to contact Red Hat support with your installation logs.

#### Prerequisites

- Configure a GCP account.
- Generate the Ignition config files for your cluster.
- Create and configure a VPC and associated subnets in GCP.
- Create and configure networking and load balancers in GCP.
- Create control plane and compute roles.
- Create the bootstrap machine.

#### Procedure

1. Copy the template from the **Deployment Manager template for control plane machines** section of this topic and save it as **05\_control\_plane.py** on your computer. This template describes the control plane machines that your cluster requires.
2. Export the following variable required by the resource definition:

```
$ export MASTER_IGNITION=`cat <installation_directory>/master.ign`
```

3. Create a **05\_control\_plane.yaml** resource definition file:

```
$ cat <<EOF >05_control_plane.yaml
imports:
- path: 05_control_plane.py

resources:
- name: cluster-control-plane
  type: 05_control_plane.py
  properties:
    infra_id: '${INFRA_ID}' 1
    zones: 2
    - '${ZONE_0}'
    - '${ZONE_1}'
    - '${ZONE_2}'

    control_subnet: '${CONTROL_SUBNET}' 3
    image: '${CLUSTER_IMAGE}' 4
    machine_type: 'n1-standard-4' 5
    root_volume_size: '128'
    service_account_email: '${MASTER_SERVICE_ACCOUNT}' 6

    ignition: '${MASTER_IGNITION}' 7
EOF
```

- 1** **infra\_id** is the **INFRA\_ID** infrastructure name from the extraction step.
- 2** **zones** are the zones to deploy the control plane instances into, for example **us-central1-a**, **us-central1-b**, and **us-central1-c**.
- 3** **control\_subnet** is the **selfLink** URL to the control subnet.
- 4** **image** is the **selfLink** URL to the RHCOS image.
- 5** **machine\_type** is the machine type of the instance, for example **n1-standard-4**.
- 6** **service\_account\_email** is the email address for the master service account that you created.
- 7** **ignition** is the contents of the **master.ign** file.

4. Create the deployment by using the **gcloud** CLI:

```
$ gcloud deployment-manager deployments create ${INFRA_ID}-control-plane --config
05_control_plane.yaml
```

5. The templates do not manage load balancer membership due to limitations of Deployment Manager, so you must add the control plane machines manually.

- Run the following commands to add the control plane machines to the appropriate instance groups:
  -

```
$ gcloud compute instance-groups unmanaged add-instances ${INFRA_ID}-master-
${ZONE_0}-ig --zone=${ZONE_0} --instances=${INFRA_ID}-master-0
```

```
$ gcloud compute instance-groups unmanaged add-instances ${INFRA_ID}-master-
${ZONE_1}-ig --zone=${ZONE_1} --instances=${INFRA_ID}-master-1
```

```
$ gcloud compute instance-groups unmanaged add-instances ${INFRA_ID}-master-
${ZONE_2}-ig --zone=${ZONE_2} --instances=${INFRA_ID}-master-2
```

- For an external cluster, you must also run the following commands to add the control plane machines to the target pools:

```
$ gcloud compute target-pools add-instances ${INFRA_ID}-api-target-pool --instances-
zone="${ZONE_0}" --instances=${INFRA_ID}-master-0
```

```
$ gcloud compute target-pools add-instances ${INFRA_ID}-api-target-pool --instances-
zone="${ZONE_1}" --instances=${INFRA_ID}-master-1
```

```
$ gcloud compute target-pools add-instances ${INFRA_ID}-api-target-pool --instances-
zone="${ZONE_2}" --instances=${INFRA_ID}-master-2
```

### 8.12.16.1. Deployment Manager template for control plane machines

You can use the following Deployment Manager template to deploy the control plane machines that you need for your OpenShift Container Platform cluster:

#### Example 8.98. 05\_control\_plane.py Deployment Manager template

```
def GenerateConfig(context):

    resources = [{
        'name': context.properties['infra_id'] + '-master-0',
        'type': 'compute.v1.instance',
        'properties': {
            'disks': [{
                'autoDelete': True,
                'boot': True,
                'initializeParams': {
                    'diskSizeGb': context.properties['root_volume_size'],
                    'diskType': 'zones/' + context.properties['zones'][0] + '/diskTypes/pd-ssd',
                    'sourceImage': context.properties['image']
                }
            }
        ],
        'machineType': 'zones/' + context.properties['zones'][0] + '/machineTypes/' +
context.properties['machine_type'],
        'metadata': {
            'items': [{
                'key': 'user-data',
                'value': context.properties['ignition']
            }
        ]
    },
    'networkInterfaces': [{
        'subnetwork': context.properties['control_subnet']
```

```

    }],
    'serviceAccounts': [{
      'email': context.properties['service_account_email'],
      'scopes': ['https://www.googleapis.com/auth/cloud-platform']
    }],
    'tags': {
      'items': [
        context.properties['infra_id'] + '-master',
      ]
    },
    'zone': context.properties['zones'][0]
  }
}, {
  'name': context.properties['infra_id'] + '-master-1',
  'type': 'compute.v1.instance',
  'properties': {
    'disks': [{
      'autoDelete': True,
      'boot': True,
      'initializeParams': {
        'diskSizeGb': context.properties['root_volume_size'],
        'diskType': 'zones/' + context.properties['zones'][1] + '/diskTypes/pd-ssd',
        'sourceImage': context.properties['image']
      }
    }
  ],
  'machineType': 'zones/' + context.properties['zones'][1] + '/machineTypes/' +
context.properties['machine_type'],
  'metadata': {
    'items': [{
      'key': 'user-data',
      'value': context.properties['ignition']
    }
  ]
},
  'networkInterfaces': [{
    'subnetwork': context.properties['control_subnet']
  }],
  'serviceAccounts': [{
    'email': context.properties['service_account_email'],
    'scopes': ['https://www.googleapis.com/auth/cloud-platform']
  }],
  'tags': {
    'items': [
      context.properties['infra_id'] + '-master',
    ]
  },
  'zone': context.properties['zones'][1]
}
}, {
  'name': context.properties['infra_id'] + '-master-2',
  'type': 'compute.v1.instance',
  'properties': {
    'disks': [{
      'autoDelete': True,
      'boot': True,
      'initializeParams': {
        'diskSizeGb': context.properties['root_volume_size'],

```



```

        'diskType': 'zones/' + context.properties['zones'][2] + '/diskTypes/pd-ssd',
        'sourceImage': context.properties['image']
    }
  ]],
  'machineType': 'zones/' + context.properties['zones'][2] + '/machineTypes/' +
context.properties['machine_type'],
  'metadata': {
    'items': [{
      'key': 'user-data',
      'value': context.properties['ignition']
    }]
  },
  'networkInterfaces': [{
    'subnetwork': context.properties['control_subnet']
  }],
  'serviceAccounts': [{
    'email': context.properties['service_account_email'],
    'scopes': ['https://www.googleapis.com/auth/cloud-platform']
  }],
  'tags': {
    'items': [
      context.properties['infra_id'] + '-master',
    ]
  },
  'zone': context.properties['zones'][2]
}
]]

return {'resources': resources}

```

### 8.12.17. Wait for bootstrap completion and remove bootstrap resources in GCP

After you create all of the required infrastructure in Google Cloud Platform (GCP), wait for the bootstrap process to complete on the machines that you provisioned by using the Ignition config files that you generated with the installation program.

#### Prerequisites

- Configure a GCP account.
- Generate the Ignition config files for your cluster.
- Create and configure a VPC and associated subnets in GCP.
- Create and configure networking and load balancers in GCP.
- Create control plane and compute roles.
- Create the bootstrap machine.
- Create the control plane machines.

#### Procedure

1. Change to the directory that contains the installation program and run the following command:

```
$ ./openshift-install wait-for bootstrap-complete --dir <installation_directory> \ 1
--log-level info 2
```

**1** For **<installation\_directory>**, specify the path to the directory that you stored the installation files in.

**2** To view different installation details, specify **warn**, **debug**, or **error** instead of **info**.

If the command exits without a **FATAL** warning, your production control plane has initialized.

2. Delete the bootstrap resources:

```
$ gcloud compute backend-services remove-backend ${INFRA_ID}-api-internal-backend-
service --region=${REGION} --instance-group=${INFRA_ID}-bootstrap-ig --instance-group-
zone=${ZONE_0}
```

```
$ gsutil rm gs://${INFRA_ID}-bootstrap-ignition/bootstrap.ign
```

```
$ gsutil rb gs://${INFRA_ID}-bootstrap-ignition
```

```
$ gcloud deployment-manager deployments delete ${INFRA_ID}-bootstrap
```

### 8.12.18. Creating additional worker machines in GCP

You can create worker machines in Google Cloud Platform (GCP) for your cluster to use by launching individual instances discretely or by automated processes outside the cluster, such as auto scaling groups. You can also take advantage of the built-in cluster scaling mechanisms and the machine API in OpenShift Container Platform.

In this example, you manually launch one instance by using the Deployment Manager template. Additional instances can be launched by including additional resources of type **06\_worker.py** in the file.



#### NOTE

If you do not use the provided Deployment Manager template to create your worker machines, you must review the provided information and manually create the infrastructure. If your cluster does not initialize correctly, you might have to contact Red Hat support with your installation logs.

#### Prerequisites

- Configure a GCP account.
- Generate the Ignition config files for your cluster.
- Create and configure a VPC and associated subnets in GCP.
- Create and configure networking and load balancers in GCP.
- Create control plane and compute roles.

- Create the bootstrap machine.
- Create the control plane machines.

## Procedure

1. Copy the template from the **Deployment Manager template for worker machines** section of this topic and save it as **06\_worker.py** on your computer. This template describes the worker machines that your cluster requires.
2. Export the variables that the resource definition uses.

- a. Export the subnet that hosts the compute machines:

```
$ export COMPUTE_SUBNET=$(gcloud compute networks subnets describe
${INFRA_ID}-worker-subnet --region=${REGION} --format json | jq -r .selfLink)
```

- b. Export the email address for your service account:

```
$ export WORKER_SERVICE_ACCOUNT=$(gcloud iam service-accounts list --filter
"email~^${INFRA_ID}-w@${PROJECT_NAME}." --format json | jq -r '[0].email')
```

- c. Export the location of the compute machine Ignition config file:

```
$ export WORKER_IGNITION=`cat <installation_directory>/worker.ign`
```

3. Create a **06\_worker.yaml** resource definition file:

```
$ cat <<EOF >06_worker.yaml
imports:
- path: 06_worker.py

resources:
- name: 'worker-0' 1
  type: 06_worker.py
  properties:
    infra_id: '${INFRA_ID}' 2
    zone: '${ZONE_0}' 3
    compute_subnet: '${COMPUTE_SUBNET}' 4
    image: '${CLUSTER_IMAGE}' 5
    machine_type: 'n1-standard-4' 6
    root_volume_size: '128'
    service_account_email: '${WORKER_SERVICE_ACCOUNT}' 7
    ignition: '${WORKER_IGNITION}' 8
- name: 'worker-1'
  type: 06_worker.py
  properties:
    infra_id: '${INFRA_ID}' 9
    zone: '${ZONE_1}' 10
    compute_subnet: '${COMPUTE_SUBNET}' 11
    image: '${CLUSTER_IMAGE}' 12
    machine_type: 'n1-standard-4' 13
    root_volume_size: '128'
```

```

service_account_email: '${WORKER_SERVICE_ACCOUNT}' 14
ignition: '${WORKER_IGNITION}' 15
EOF

```

- 1 **name** is the name of the worker machine, for example **worker-0**.
- 2 9 **infra\_id** is the **INFRA\_ID** infrastructure name from the extraction step.
- 3 10 **zone** is the zone to deploy the worker machine into, for example **us-central1-a**.
- 4 11 **compute\_subnet** is the **selfLink** URL to the compute subnet.
- 5 12 **image** is the **selfLink** URL to the RHCOS image. <sup>1</sup>
- 6 13 **machine\_type** is the machine type of the instance, for example **n1-standard-4**.
- 7 14 **service\_account\_email** is the email address for the worker service account that you created.
- 8 15 **ignition** is the contents of the **worker.ign** file.

4. Optional: If you want to launch additional instances, include additional resources of type **06\_worker.py** in your **06\_worker.yaml** resource definition file.
5. Create the deployment by using the **gcloud** CLI:

```

$ gcloud deployment-manager deployments create ${INFRA_ID}-worker --config
06_worker.yaml

```

1. To use a GCP Marketplace image, specify the offer to use:
  - OpenShift Container Platform:  
**<https://www.googleapis.com/compute/v1/projects/redhat-marketplace-public/global/images/redhat-coreos-ocp-48-x86-64-202210040145>**
  - OpenShift Platform Plus: **<https://www.googleapis.com/compute/v1/projects/redhat-marketplace-public/global/images/redhat-coreos-opp-48-x86-64-202206140145>**
  - OpenShift Kubernetes Engine:  
**<https://www.googleapis.com/compute/v1/projects/redhat-marketplace-public/global/images/redhat-coreos-oke-48-x86-64-202206140145>**

### 8.12.18.1. Deployment Manager template for worker machines

You can use the following Deployment Manager template to deploy the worker machines that you need for your OpenShift Container Platform cluster:

#### Example 8.99. 06\_worker.py Deployment Manager template

```

def GenerateConfig(context):

    resources = [{
        'name': context.properties['infra_id'] + '-' + context.env['name'],
        'type': 'compute.v1.instance',

```

```

'properties': {
  'disks': [{
    'autoDelete': True,
    'boot': True,
    'initializeParams': {
      'diskSizeGb': context.properties['root_volume_size'],
      'sourceImage': context.properties['image']
    }
  }],
  'machineType': 'zones/' + context.properties['zone'] + '/machineTypes/' +
context.properties['machine_type'],
  'metadata': {
    'items': [{
      'key': 'user-data',
      'value': context.properties['ignition']
    }]
  },
  'networkInterfaces': [{
    'subnetwork': context.properties['compute_subnet']
  }],
  'serviceAccounts': [{
    'email': context.properties['service_account_email'],
    'scopes': ['https://www.googleapis.com/auth/cloud-platform']
  }],
  'tags': {
    'items': [
      context.properties['infra_id'] + '-worker',
    ]
  },
  'zone': context.properties['zone']
}
}]

return {'resources': resources}

```

### 8.12.19. Logging in to the cluster by using the CLI

You can log in to your cluster as a default system user by exporting the cluster **kubeconfig** file. The **kubeconfig** file contains information about the cluster that is used by the CLI to connect a client to the correct cluster and API server. The file is specific to a cluster and is created during OpenShift Container Platform installation.

#### Prerequisites

- You deployed an OpenShift Container Platform cluster.
- You installed the **oc** CLI.

#### Procedure

1. Export the **kubeadmin** credentials:

```
$ export KUBECONFIG=<installation_directory>/auth/kubeconfig 1
```

- 1 For **<installation\_directory>**, specify the path to the directory that you stored the installation files in.

2. Verify you can run **oc** commands successfully using the exported configuration:

```
$ oc whoami
```

#### Example output

```
system:admin
```

## 8.12.20. Disabling the default OperatorHub sources

Operator catalogs that source content provided by Red Hat and community projects are configured for OperatorHub by default during an OpenShift Container Platform installation. In a restricted network environment, you must disable the default catalogs as a cluster administrator.

### Procedure

- Disable the sources for the default catalogs by adding **disableAllDefaultSources: true** to the **OperatorHub** object:

```
$ oc patch OperatorHub cluster --type json \
  -p '[{"op": "add", "path": "/spec/disableAllDefaultSources", "value": true}]'
```

### TIP

Alternatively, you can use the web console to manage catalog sources. From the **Administration** → **Cluster Settings** → **Configuration** → **OperatorHub** page, click the **Sources** tab, where you can create, delete, disable, and enable individual sources.

## 8.12.21. Approving the certificate signing requests for your machines

When you add machines to a cluster, two pending certificate signing requests (CSRs) are generated for each machine that you added. You must confirm that these CSRs are approved or, if necessary, approve them yourself. The client requests must be approved first, followed by the server requests.

### Prerequisites

- You added machines to your cluster.

### Procedure

1. Confirm that the cluster recognizes the machines:

```
$ oc get nodes
```

#### Example output

```
NAME      STATUS   ROLES    AGE   VERSION
master-0 Ready    master   63m   v1.23.0
```

```
master-1 Ready   master 63m v1.23.0
master-2 Ready   master 64m v1.23.0
```

The output lists all of the machines that you created.

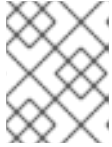

#### NOTE

The preceding output might not include the compute nodes, also known as worker nodes, until some CSRs are approved.

2. Review the pending CSRs and ensure that you see the client requests with the **Pending** or **Approved** status for each machine that you added to the cluster:

```
$ oc get csr
```

#### Example output

```
NAME      AGE   REQUESTOR                                     CONDITION
csr-8b2br 15m   system:serviceaccount:openshift-machine-config-operator:node-
bootstrapper Pending
csr-8vnps 15m   system:serviceaccount:openshift-machine-config-operator:node-
bootstrapper Pending
...
```

In this example, two machines are joining the cluster. You might see more approved CSRs in the list.

3. If the CSRs were not approved, after all of the pending CSRs for the machines you added are in **Pending** status, approve the CSRs for your cluster machines:

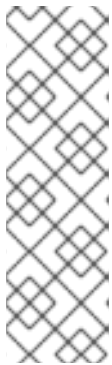

#### NOTE

Because the CSRs rotate automatically, approve your CSRs within an hour of adding the machines to the cluster. If you do not approve them within an hour, the certificates will rotate, and more than two certificates will be present for each node. You must approve all of these certificates. After the client CSR is approved, the Kubelet creates a secondary CSR for the serving certificate, which requires manual approval. Then, subsequent serving certificate renewal requests are automatically approved by the **machine-approver** if the Kubelet requests a new certificate with identical parameters.



#### NOTE

For clusters running on platforms that are not machine API enabled, such as bare metal and other user-provisioned infrastructure, you must implement a method of automatically approving the kubelet serving certificate requests (CSRs). If a request is not approved, then the **oc exec**, **oc rsh**, and **oc logs** commands cannot succeed, because a serving certificate is required when the API server connects to the kubelet. Any operation that contacts the Kubelet endpoint requires this certificate approval to be in place. The method must watch for new CSRs, confirm that the CSR was submitted by the **node-bootstrapper** service account in the **system:node** or **system:admin** groups, and confirm the identity of the node.

- To approve them individually, run the following command for each valid CSR:

```
$ oc adm certificate approve <csr_name> 1
```

- 1** **<csr\_name>** is the name of a CSR from the list of current CSRs.

- To approve all pending CSRs, run the following command:

```
$ oc get csr -o go-template='{{range .items}}{{if not .status}}{{.metadata.name}}{\n"}\n{{end}}' | xargs --no-run-if-empty oc adm certificate approve
```



#### NOTE

Some Operators might not become available until some CSRs are approved.

- Now that your client requests are approved, you must review the server requests for each machine that you added to the cluster:

```
$ oc get csr
```

#### Example output

```
NAME      AGE   REQUESTOR                                     CONDITION
csr-bfd72 5m26s system:node:ip-10-0-50-126.us-east-2.compute.internal
Pending
csr-c57lv 5m26s system:node:ip-10-0-95-157.us-east-2.compute.internal
Pending
...
```

- If the remaining CSRs are not approved, and are in the **Pending** status, approve the CSRs for your cluster machines:

- To approve them individually, run the following command for each valid CSR:

```
$ oc adm certificate approve <csr_name> 1
```

- 1** **<csr\_name>** is the name of a CSR from the list of current CSRs.

- To approve all pending CSRs, run the following command:

```
$ oc get csr -o go-template='{{range .items}}{{if not .status}}{{.metadata.name}}{\n"}\n{{end}}' | xargs oc adm certificate approve
```

- After all client and server CSRs have been approved, the machines have the **Ready** status. Verify this by running the following command:

```
$ oc get nodes
```

#### Example output



NAME	STATUS	ROLES	AGE	VERSION
master-0	Ready	master	73m	v1.23.0
master-1	Ready	master	73m	v1.23.0
master-2	Ready	master	74m	v1.23.0
worker-0	Ready	worker	11m	v1.23.0
worker-1	Ready	worker	11m	v1.23.0

**NOTE**

It can take a few minutes after approval of the server CSRs for the machines to transition to the **Ready** status.

**Additional information**

- For more information on CSRs, see [Certificate Signing Requests](#).

**8.12.22. Optional: Adding the ingress DNS records**

If you removed the DNS zone configuration when creating Kubernetes manifests and generating Ignition configs, you must manually create DNS records that point at the ingress load balancer. You can create either a wildcard **\*.apps.{baseDomain}**, or specific records. You can use A, CNAME, and other records per your requirements.

**Prerequisites**

- Configure a GCP account.
- Remove the DNS Zone configuration when creating Kubernetes manifests and generating Ignition configs.
- Create and configure a VPC and associated subnets in GCP.
- Create and configure networking and load balancers in GCP.
- Create control plane and compute roles.
- Create the bootstrap machine.
- Create the control plane machines.
- Create the worker machines.

**Procedure**

1. Wait for the Ingress router to create a load balancer and populate the **EXTERNAL-IP** field:

```
$ oc -n openshift-ingress get service router-default
```

**Example output**

NAME	TYPE	CLUSTER-IP	EXTERNAL-IP	PORT(S)	AGE
router-default	LoadBalancer	172.30.18.154	35.233.157.184	80:32288/TCP,443:31215/TCP	98

## 2. Add the A record to your zones:

- To use A records:
  - i. Export the variable for the router IP address:

```
$ export ROUTER_IP=`oc -n openshift-ingress get service router-default --no-headers | awk '{print $4}'`
```

- ii. Add the A record to the private zones:

```
$ if [ -f transaction.yaml ]; then rm transaction.yaml; fi
$ gcloud dns record-sets transaction start --zone ${INFRA_ID}-private-zone
$ gcloud dns record-sets transaction add ${ROUTER_IP} --name
\*.apps.${CLUSTER_NAME}.${BASE_DOMAIN}. --ttl 300 --type A --zone
${INFRA_ID}-private-zone
$ gcloud dns record-sets transaction execute --zone ${INFRA_ID}-private-zone
```

- iii. For an external cluster, also add the A record to the public zones:

```
$ if [ -f transaction.yaml ]; then rm transaction.yaml; fi
$ gcloud dns record-sets transaction start --zone ${BASE_DOMAIN_ZONE_NAME}
$ gcloud dns record-sets transaction add ${ROUTER_IP} --name
\*.apps.${CLUSTER_NAME}.${BASE_DOMAIN}. --ttl 300 --type A --zone
${BASE_DOMAIN_ZONE_NAME}
$ gcloud dns record-sets transaction execute --zone
${BASE_DOMAIN_ZONE_NAME}
```

- To add explicit domains instead of using a wildcard, create entries for each of the cluster's current routes:

```
$ oc get --all-namespaces -o jsonpath='{range .items[*]}{range .status.ingress[*]}{.host} {"\n"}{end}{end}' routes
```

### Example output

```
oauth-openshift.apps.your.cluster.domain.example.com
console-openshift-console.apps.your.cluster.domain.example.com
downloads-openshift-console.apps.your.cluster.domain.example.com
alertmanager-main-openshift-monitoring.apps.your.cluster.domain.example.com
grafana-openshift-monitoring.apps.your.cluster.domain.example.com
prometheus-k8s-openshift-monitoring.apps.your.cluster.domain.example.com
```

## 8.12.23. Completing a GCP installation on user-provisioned infrastructure

After you start the OpenShift Container Platform installation on Google Cloud Platform (GCP) user-provisioned infrastructure, you can monitor the cluster events until the cluster is ready.

### Prerequisites

- Deploy the bootstrap machine for an OpenShift Container Platform cluster on user-provisioned GCP infrastructure.
- Install the **oc** CLI and log in.

## Procedure

1. Complete the cluster installation:

```
$ ./openshift-install --dir <installation_directory> wait-for install-complete 1
```

### Example output

```
INFO Waiting up to 30m0s for the cluster to initialize...
```

- 1** For **<installation\_directory>**, specify the path to the directory that you stored the installation files in.

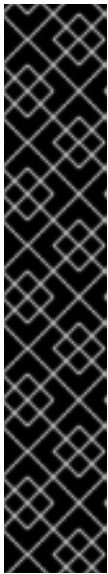

### IMPORTANT

- The Ignition config files that the installation program generates contain certificates that expire after 24 hours, which are then renewed at that time. If the cluster is shut down before renewing the certificates and the cluster is later restarted after the 24 hours have elapsed, the cluster automatically recovers the expired certificates. The exception is that you must manually approve the pending **node-bootstrapper** certificate signing requests (CSRs) to recover kubelet certificates. See the documentation for *Recovering from expired control plane certificates* for more information.
- It is recommended that you use Ignition config files within 12 hours after they are generated because the 24-hour certificate rotates from 16 to 22 hours after the cluster is installed. By using the Ignition config files within 12 hours, you can avoid installation failure if the certificate update runs during installation.

2. Observe the running state of your cluster.

- a. Run the following command to view the current cluster version and status:

```
$ oc get clusterversion
```

### Example output

```
NAME      VERSION  AVAILABLE  PROGRESSING  SINCE      STATUS
version   False    True        24m          Working towards 4.5.4: 99% complete
```

- b. Run the following command to view the Operators managed on the control plane by the Cluster Version Operator (CVO):

```
$ oc get clusteroperators
```

### Example output

```
NAME              VERSION  AVAILABLE  PROGRESSING  DEGRADED  SINCE
authentication    4.5.4   True        False        False     7m56s
cloud-credential  4.5.4   True        False        False     31m
```

cluster-autoscaler	4.5.4	True	False	False	16m
console	4.5.4	True	False	False	10m
csi-snapshot-controller	4.5.4	True	False	False	16m
dns	4.5.4	True	False	False	22m
etcd	4.5.4	False	False	False	25s
image-registry	4.5.4	True	False	False	16m
ingress	4.5.4	True	False	False	16m
insights	4.5.4	True	False	False	17m
kube-apiserver	4.5.4	True	False	False	19m
kube-controller-manager	4.5.4	True	False	False	20m
kube-scheduler	4.5.4	True	False	False	20m
kube-storage-version-migrator	4.5.4	True	False	False	16m
machine-api	4.5.4	True	False	False	22m
machine-config	4.5.4	True	False	False	22m
marketplace	4.5.4	True	False	False	16m
monitoring	4.5.4	True	False	False	10m
network	4.5.4	True	False	False	23m
node-tuning	4.5.4	True	False	False	23m
openshift-apiserver	4.5.4	True	False	False	17m
openshift-controller-manager	4.5.4	True	False	False	15m
openshift-samples	4.5.4	True	False	False	16m
operator-lifecycle-manager	4.5.4	True	False	False	22m
operator-lifecycle-manager-catalog	4.5.4	True	False	False	22m
operator-lifecycle-manager-packageserver	4.5.4	True	False	False	18m
service-ca	4.5.4	True	False	False	23m
service-catalog-apiserver	4.5.4	True	False	False	23m
service-catalog-controller-manager	4.5.4	True	False	False	23m
storage	4.5.4	True	False	False	17m

- c. Run the following command to view your cluster pods:

```
$ oc get pods --all-namespaces
```

### Example output

```

NAMESPACE                               NAME
READY  STATUS  RESTARTS  AGE
kube-system                               etcd-member-ip-10-0-3-111.us-east-
2.compute.internal                       1/1    Running   0    35m
kube-system                               etcd-member-ip-10-0-3-239.us-east-
2.compute.internal                       1/1    Running   0    37m
kube-system                               etcd-member-ip-10-0-3-24.us-east-
2.compute.internal                       1/1    Running   0    35m
openshift-apiserver-operator              openshift-apiserver-operator-6d6674f4f4-
h7t2t                                     1/1    Running   1    37m
openshift-apiserver                       apiserver-fm48r
1/1    Running   0    30m
openshift-apiserver                       apiserver-fxkvv
1/1    Running   0    29m
openshift-apiserver                       apiserver-q85nm
1/1    Running   0    29m
...
openshift-service-ca-operator             openshift-service-ca-operator-66ff6dc6cd-
9r257                                     1/1    Running   0    37m
openshift-service-ca                       apiservice-cabundle-injector-695b6bcbc-cl5hm

```

```

1/1    Running    0      35m
openshift-service-ca
25qn6                1/1    Running    0      35m
openshift-service-ca                configmap-cabundle-injector-8498544d7-
1/1    Running    0      35m                service-serving-cert-signer-6445fc9c6-wqdqn
openshift-service-catalog-apiserver-operator    openshift-service-catalog-apiserver-
operator-549f44668b-b5q2w    1/1    Running    0      32m
openshift-service-catalog-controller-manager-operator    openshift-service-catalog-
controller-manager-operator-b78cr2lnm    1/1    Running    0      31m

```

When the current cluster version is **AVAILABLE**, the installation is complete.

### 8.12.24. Telemetry access for OpenShift Container Platform

In OpenShift Container Platform 4.10, the Telemetry service, which runs by default to provide metrics about cluster health and the success of updates, requires internet access. If your cluster is connected to the internet, Telemetry runs automatically, and your cluster is registered to [OpenShift Cluster Manager](#).

After you confirm that your [OpenShift Cluster Manager](#) inventory is correct, either maintained automatically by Telemetry or manually by using OpenShift Cluster Manager, [use subscription watch](#) to track your OpenShift Container Platform subscriptions at the account or multi-cluster level.

#### Additional resources

- See [About remote health monitoring](#) for more information about the Telemetry service

### 8.12.25. Next steps

- [Customize your cluster](#).
- [Configure image streams](#) for the Cluster Samples Operator and the **must-gather** tool.
- Learn how to [use Operator Lifecycle Manager \(OLM\) on restricted networks](#).
- If the mirror registry that you used to install your cluster has a trusted CA, add it to the cluster by [configuring additional trust stores](#).
- If necessary, you can [opt out of remote health reporting](#).
- If necessary, see [Registering your disconnected cluster](#)

## 8.13. UNINSTALLING A CLUSTER ON GCP

You can remove a cluster that you deployed to Google Cloud Platform (GCP).

### 8.13.1. Removing a cluster that uses installer-provisioned infrastructure

You can remove a cluster that uses installer-provisioned infrastructure from your cloud.

**NOTE**

After uninstallation, check your cloud provider for any resources not removed properly, especially with User Provisioned Infrastructure (UPI) clusters. There might be resources that the installer did not create or that the installer is unable to access. For example, some Google Cloud resources require [IAM permissions](#) in shared VPC host projects, or there might be unused [health checks that must be deleted](#).

**Prerequisites**

- Have a copy of the installation program that you used to deploy the cluster.
- Have the files that the installation program generated when you created your cluster.

**Procedure**

1. From the directory that contains the installation program on the computer that you used to install the cluster, run the following command:

```
$ ./openshift-install destroy cluster \
--dir <installation_directory> --log-level info 1 2
```

- 1** For **<installation\_directory>**, specify the path to the directory that you stored the installation files in.
- 2** To view different details, specify **warn**, **debug**, or **error** instead of **info**.

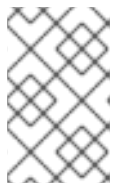
**NOTE**

You must specify the directory that contains the cluster definition files for your cluster. The installation program requires the **metadata.json** file in this directory to delete the cluster.

1. Optional: Delete the **<installation\_directory>** directory and the OpenShift Container Platform installation program.

**8.13.2. Deleting GCP resources with the Cloud Credential Operator utility**

To clean up resources after uninstalling an OpenShift Container Platform cluster with the Cloud Credential Operator (CCO) in manual mode with GCP Workload Identity, you can use the CCO utility (**ccoctl**) to remove the GCP resources that **ccoctl** created during installation.

**Prerequisites**

- Extract and prepare the **ccoctl** binary.
- Install an OpenShift Container Platform cluster with the CCO in manual mode with GCP Workload Identity.

**Procedure**

1. Obtain the OpenShift Container Platform release image by running the following command:

```
$ RELEASE_IMAGE=$(./openshift-install version | awk 'release image/ {print $3}')
```

2. Extract the list of **CredentialsRequest** custom resources (CRs) from the OpenShift Container Platform release image by running the following command:

```
$ oc adm release extract --credentials-requests \
  --cloud=gcp \
  --to=<path_to_directory_with_list_of_credentials_requests>/credrequests \ 1
$RELEASE_IMAGE
```

- 1** **credrequests** is the directory where the list of **CredentialsRequest** objects is stored. This command creates the directory if it does not exist.

3. Delete the GCP resources that **ccoctl** created:

```
$ ccoctl gcp delete \
  --name=<name> \ 1
  --project=<gcp_project_id> \ 2
  --credentials-requests-dir=
  <path_to_directory_with_list_of_credentials_requests>/credrequests
```

- 1** **<name>** matches the name that was originally used to create and tag the cloud resources.

- 2** **<gcp\_project\_id>** is the GCP project ID in which to delete cloud resources.

## Verification

- To verify that the resources are deleted, query GCP. For more information, refer to GCP documentation.

## CHAPTER 9. INSTALLING ON IBM CLOUD VPC

### 9.1. PREPARING TO INSTALL ON IBM CLOUD VPC

The installation workflows documented in this section are for IBM Cloud VPC infrastructure environments. IBM Cloud Classic is not supported at this time. For more information on the difference between Classic and VPC infrastructures, see IBM's [documentation](#).

#### 9.1.1. Prerequisites

- You reviewed details about the [OpenShift Container Platform installation and update](#) processes.
- You read the documentation on [selecting a cluster installation method and preparing it for users](#).



#### IMPORTANT

IBM Cloud using installer-provisioned infrastructure is a Technology Preview feature only. Technology Preview features are not supported with Red Hat production service level agreements (SLAs) and might not be functionally complete. Red Hat does not recommend using them in production. These features provide early access to upcoming product features, enabling customers to test functionality and provide feedback during the development process.

For more information about the support scope of Red Hat Technology Preview features, see [Technology Preview Features Support Scope](#).

#### 9.1.2. Requirements for installing OpenShift Container Platform on IBM Cloud VPC

Before installing OpenShift Container Platform on IBM Cloud VPC, you must create a service account and configure an IBM Cloud account. See [Configuring an IBM Cloud account](#) for details about creating an account, enabling API services, configuring DNS, IBM Cloud account limits, and supported IBM Cloud VPC regions.

You must manually manage your cloud credentials when installing a cluster to IBM Cloud VPC. Do this by configuring the Cloud Credential Operator (CCO) for manual mode before you install the cluster. For more information, see [Configuring IAM for IBM Cloud VPC](#).

#### 9.1.3. Choosing a method to install OpenShift Container Platform on IBM Cloud VPC

You can install OpenShift Container Platform on IBM Cloud VPC using installer-provisioned infrastructure. This process involves using an installation program to provision the underlying infrastructure for your cluster. Installing OpenShift Container Platform on IBM Cloud VPC using user-provisioned infrastructure is not supported at this time.

See [Installation process](#) for more information about installer-provisioned installation processes.

##### 9.1.3.1. Installing a cluster on installer-provisioned infrastructure

You can install a cluster on IBM Cloud VPC infrastructure that is provisioned by the OpenShift Container Platform installation program by using one of the following methods:

- [Installing a customized cluster on IBM Cloud VPC](#) You can install a customized cluster on IBM



Cloud VPC infrastructure that the installation program provisions. The installation program allows for some customization to be applied at the installation stage. Many other customization options are available [post-installation](#).

- **Installing a cluster on IBM Cloud VPC with network customizations** You can customize your OpenShift Container Platform network configuration during installation, so that your cluster can coexist with your existing IP address allocations and adhere to your network requirements.

### 9.1.4. Next steps

- [Configuring an IBM Cloud account](#)

## 9.2. CONFIGURING AN IBM CLOUD ACCOUNT

Before you can install OpenShift Container Platform, you must configure an IBM Cloud account.



### IMPORTANT

IBM Cloud VPC using installer-provisioned infrastructure is a Technology Preview feature only. Technology Preview features are not supported with Red Hat production service level agreements (SLAs) and might not be functionally complete. Red Hat does not recommend using them in production. These features provide early access to upcoming product features, enabling customers to test functionality and provide feedback during the development process.

For more information about the support scope of Red Hat Technology Preview features, see [Technology Preview Features Support Scope](#).

### 9.2.1. Prerequisites

- You have an IBM Cloud account with a subscription. You cannot install OpenShift Container Platform on a free or trial IBM Cloud account.

### 9.2.2. Quotas and limits on IBM Cloud VPC

The OpenShift Container Platform cluster uses a number of IBM Cloud VPC components, and the default quotas and limits affect your ability to install OpenShift Container Platform clusters. If you use certain cluster configurations, deploy your cluster in certain regions, or run multiple clusters from your account, you might need to request additional resources for your IBM Cloud account.

For a comprehensive list of the default IBM Cloud VPC quotas and service limits, see IBM Cloud's documentation for [Quotas and service limits](#).

#### Virtual Private Cloud (VPC)

Each OpenShift Container Platform cluster creates its own VPC. The default quota of VPCs per region is 10 and will allow 10 clusters. To have more than 10 clusters in a single region, you must increase this quota.

#### Application load balancer

By default, each cluster creates three application load balancers (ALBs):

- Internal load balancer for the master API server
- External load balancer for the master API server

- Load balancer for the router

You can create additional **LoadBalancer** service objects to create additional ALBs. The default quota of VPC ALBs are 50 per region. To have more than 50 ALBs, you must increase this quota.

VPC ALBs are supported. Classic ALBs are not supported for IBM Cloud VPC.

### Floating IP address

By default, the installation program distributes control plane and compute machines across all availability zones within a region to provision the cluster in a highly available configuration. In each availability zone, a public gateway is created and requires a separate floating IP address.

The default quota for a floating IP address is 20 addresses per availability zone. The default cluster configuration yields three floating IP addresses:

- Two floating IP addresses in the **us-east-1** primary zone. The IP address associated with the bootstrap node is removed after installation.
- One floating IP address in the **us-east-2** secondary zone.
- One floating IP address in the **us-east-3** secondary zone.

IBM Cloud VPC can support up to 19 clusters per region in an account. If you plan to have more than 19 default clusters, you must increase this quota.

### Virtual Server Instances (VSI)

By default, a cluster creates VSIs using **bx2-4x16** profiles, which includes the following resources by default:

- 4 vCPUs
- 16 GB RAM

The following nodes are created:

- One **bx2-4x16** bootstrap machine, which is removed after the installation is complete
- Three **bx2-4x16** control plane nodes
- Three **bx2-4x16** compute nodes

For more information, see IBM Cloud's documentation on [supported profiles](#).

**Table 9.1. VSI component quotas and limits**

VSI component	Default IBM Cloud VPC quota	Default cluster configuration	Maximum number of clusters
vCPU	200 vCPUs per region	28 vCPUs, or 24 vCPUs after bootstrap removal	8 per region
RAM	1600 GB per region	112 GB, or 96 GB after bootstrap removal	16 per region

VSI component	Default IBM Cloud VPC quota	Default cluster configuration	Maximum number of clusters
Storage	18 TB per region	1050 GB, or 900 GB after bootstrap removal	19 per region

If you plan to exceed the resources stated in the table, you must increase your IBM Cloud account quota.

### Block Storage Volumes

For each VPC machine, a block storage device is attached for its boot volume. The default cluster configuration creates seven VPC machines, resulting in seven block storage volumes. Additional Kubernetes persistent volume claims (PVCs) of the IBM Cloud VPC storage class create additional block storage volumes. The default quota of VPC block storage volumes are 300 per region. To have more than 300 volumes, you must increase this quota.

### 9.2.3. Configuring DNS resolution using Cloud Internet Services

IBM Cloud Internet Services (CIS) is used by the installation program to configure cluster DNS resolution and provide name lookup for the cluster to external resources. Only public DNS is supported with IBM Cloud VPC.



#### NOTE

IBM Cloud VPC does not support IPv6, so dual stack or IPv6 environments are not possible.

You must create a domain zone in CIS in the same account as your cluster. You must also ensure the zone is authoritative for the domain. You can do this using a root domain or subdomain.

#### Prerequisites

- You have installed the [IBM Cloud CLI](#).

#### Procedure

- If you do not already have an existing domain and registrar, you must acquire them. For more information, see IBM's [documentation](#).
- Create a CIS instance to use with your cluster.

- Install the CIS plugin:

```
$ ibmcloud plugin install cis
```

- Create the CIS instance:

```
$ ibmcloud cis instance-create <instance_name> standard 1
```

- At a minimum, a **Standard** plan is required for CIS to manage the cluster subdomain and its DNS records.

3. Connect an existing domain to your CIS instance.

a. Set the context instance for CIS:

```
$ ibmcloud cis instance-set <instance_name> 1
```

1 The instance cloud resource name.

b. Add the domain for CIS:

```
$ ibmcloud cis domain-add <domain_name> 1
```

1 The fully qualified domain name. You can use either the root domain or subdomain value as the domain name, depending on which you plan to configure.



#### NOTE

A root domain uses the form **openshiftcorp.com**. A subdomain uses the form **clusters.openshiftcorp.com**.

4. Open the [CIS web console](#), navigate to the **Overview** page, and note your CIS name servers. These name servers will be used in the next step.
5. Configure the name servers for your domains or subdomains at the domain's registrar or DNS provider. For more information, see IBM Cloud's [documentation](#).

## 9.2.4. IBM Cloud VPC IAM Policies and API Key

To install OpenShift Container Platform into your IBM Cloud account, the installation program requires an IAM API key, which provides authentication and authorization to access IBM Cloud service APIs. You can use an existing IAM API key that contains the required policies or create a new one.

For an IBM Cloud IAM overview, see the IBM Cloud [documentation](#).

### 9.2.4.1. Required access policies

You must assign the required access policies to your IBM Cloud account.

**Table 9.2. Required access policies**

Service type	Service	Access policy scope	Platform access	Service access
Account management	IAM Identity Service	All resources or a subset of resources <sup>[1]</sup>	Editor, Operator, Viewer, Administrator	Service ID creator

Service type	Service	Access policy scope	Platform access	Service access
Account management [2]	Identity and Access Management	All resources	Editor, Operator, Viewer, Administrator	
Account management	Resource group only	All resource groups in the account	Administrator	
IAM services	Cloud Object Storage	All resources or a subset of resources [1]	Editor, Operator, Viewer, Administrator	Reader, Writer, Manager, Content Reader, Object Reader, Object Writer
IAM services	Internet Services	All resources or a subset of resources [1]	Editor, Operator, Viewer, Administrator	Reader, Writer, Manager
IAM services	VPC Infrastructure Services	All resources or a subset of resources [1]	Editor, Operator, Viewer, Administrator	Reader, Writer, Manager

1. The policy access scope should be set based on how granular you want to assign access. The scope can be set to **All resources** or **Resources based on selected attributes**
2. Optional: This access policy is only required if you want the installation program to create a resource group. For more information on resource groups, see IBM Cloud's [documentation](#).

#### 9.2.4.2. Access policy assignment

In IBM Cloud VPC IAM, access policies can be attached to different subjects:

- Access group (Recommended)
- Service ID
- User

The recommended method is to define IAM access policies in an [access group](#). This helps organize all the access required for OpenShift Container Platform and enables you to onboard users and service IDs to this group. You can also assign access to [users and service IDs](#) directly, if desired.

#### 9.2.4.3. Creating an API key

You must create a user API key or a service ID API key for your IBM Cloud account.

## Prerequisites

- You have assigned the required access policies to your IBM Cloud account.
- You have attached your IAM access policies to an access group, or other appropriate resource.

## Procedure

- Create an API key, depending on how you defined your IAM access policies.  
For example, if you assigned your access policies to a user, you must create a [user API key](#). If you assigned your access policies to a service ID, you must create a [service ID API key](#). If your access policies are assigned to an access group, you can use either API key type. For more information on IBM Cloud VPC API keys, see [Understanding API keys](#).

## 9.2.5. Supported IBM Cloud VPC regions

You can deploy an OpenShift Container Platform cluster to the following regions:

- **au-syd** (Sydney, Australia)
- **ca-tor** (Toronto, Canada)
- **eu-de** (Frankfurt, Germany)
- **eu-gb** (London, United Kingdom)
- **jp-osa** (Osaka, Japan)
- **jp-tok** (Tokyo, Japan)
- **us-east** (Washington DC, United States)
- **us-south** (Dallas, United States)

## 9.2.6. Next steps

- [Configuring IAM for IBM Cloud VPC](#)

## 9.3. CONFIGURING IAM FOR IBM CLOUD VPC

In environments where the cloud identity and access management (IAM) APIs are not reachable, you must put the Cloud Credential Operator (CCO) into manual mode before you install the cluster.

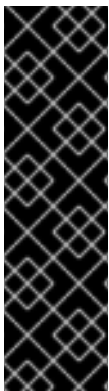

### IMPORTANT

IBM Cloud VPC using installer-provisioned infrastructure is a Technology Preview feature only. Technology Preview features are not supported with Red Hat production service level agreements (SLAs) and might not be functionally complete. Red Hat does not recommend using them in production. These features provide early access to upcoming product features, enabling customers to test functionality and provide feedback during the development process.

For more information about the support scope of Red Hat Technology Preview features, see [Technology Preview Features Support Scope](#).

### 9.3.1. Alternatives to storing administrator-level secrets in the kube-system project

The Cloud Credential Operator (CCO) manages cloud provider credentials as Kubernetes custom resource definitions (CRDs). You can configure the CCO to suit the security requirements of your organization by setting different values for the **credentialsMode** parameter in the **install-config.yaml** file.

Storing an administrator-level credential secret in the cluster **kube-system** project is not supported for IBM Cloud; therefore, you must set the **credentialsMode** parameter for the CCO to **Manual** when installing OpenShift Container Platform and manage your cloud credentials manually.

Using manual mode allows each cluster component to have only the permissions it requires, without storing an administrator-level credential in the cluster. You can also use this mode if your environment does not have connectivity to the cloud provider public IAM endpoint. However, you must manually reconcile permissions with new release images for every upgrade. You must also manually supply credentials for every component that requests them.

#### Additional resources

- [About the Cloud Credential Operator](#)

### 9.3.2. Configuring the Cloud Credential Operator utility

To create and manage cloud credentials from outside of the cluster when the Cloud Credential Operator (CCO) is operating in manual mode, extract and prepare the CCO utility (**ccoctl**) binary.

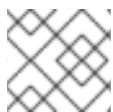

#### NOTE

The **ccoctl** utility is a Linux binary that must run in a Linux environment.

#### Prerequisites

- You have access to an OpenShift Container Platform account with cluster administrator access.
- You have installed the OpenShift CLI (**oc**).

#### Procedure

1. Obtain the OpenShift Container Platform release image:

```
$ RELEASE_IMAGE=$(./openshift-install version | awk '/release image/ {print $3}')
```

2. Get the CCO container image from the OpenShift Container Platform release image:

```
$ CCO_IMAGE=$(oc adm release info --image-for='cloud-credential-operator' $RELEASE_IMAGE)
```



#### NOTE

Ensure that the architecture of the **\$RELEASE\_IMAGE** matches the architecture of the environment in which you will use the **ccoctl** tool.

3. Extract the **ccoctl** binary from the CCO container image within the OpenShift Container Platform release image:

```
$ oc image extract $CCO_IMAGE --file="/usr/bin/ccoctl" -a ~/.pull-secret
```

4. Change the permissions to make **ccoctl** executable:

```
$ chmod 775 ccoctl
```

### Verification

- To verify that **ccoctl** is ready to use, display the help file:

```
$ ccoctl --help
```

#### Output of **ccoctl --help**

```
OpenShift credentials provisioning tool

Usage:
ccoctl [command]

Available Commands:
alibabacloud  Manage credentials objects for alibaba cloud
aws           Manage credentials objects for AWS cloud
gcp           Manage credentials objects for Google cloud
help          Help about any command
ibmcloud      Manage credentials objects for IBM Cloud

Flags:
-h, --help  help for ccoctl

Use "ccoctl [command] --help" for more information about a command.
```

### Additional resources

- [Rotating API keys for IBM Cloud VPC](#)

### 9.3.3. Next steps

- [Installing a cluster on IBM Cloud VPC with customizations](#)

### 9.3.4. Additional resources

- [Preparing to update a cluster with manually maintained credentials](#)

## 9.4. INSTALLING A CLUSTER ON IBM CLOUD VPC WITH CUSTOMIZATIONS

In OpenShift Container Platform version 4.10, you can install a customized cluster on infrastructure that the installation program provisions on IBM Cloud VPC. To customize the installation, you modify parameters in the **install-config.yaml** file before you install the cluster.





## IMPORTANT

IBM Cloud VPC using installer-provisioned infrastructure is a Technology Preview feature only. Technology Preview features are not supported with Red Hat production service level agreements (SLAs) and might not be functionally complete. Red Hat does not recommend using them in production. These features provide early access to upcoming product features, enabling customers to test functionality and provide feedback during the development process.

For more information about the support scope of Red Hat Technology Preview features, see [Technology Preview Features Support Scope](#).

### 9.4.1. Prerequisites

- You reviewed details about the [OpenShift Container Platform installation and update](#) processes.
- You read the documentation on [selecting a cluster installation method and preparing it for users](#).
- You [configured an IBM Cloud account](#) to host the cluster.
- If you use a firewall, you [configured it to allow the sites](#) that your cluster requires access to.
- You configured the **ccoctl** utility before you installed the cluster. For more information, see [Configuring IAM for IBM Cloud VPC](#).

### 9.4.2. Internet access for OpenShift Container Platform

In OpenShift Container Platform 4.10, you require access to the internet to install your cluster.

You must have internet access to:

- Access [OpenShift Cluster Manager](#) to download the installation program and perform subscription management. If the cluster has internet access and you do not disable Telemetry, that service automatically entitles your cluster.
- Access [Quay.io](#) to obtain the packages that are required to install your cluster.
- Obtain the packages that are required to perform cluster updates.

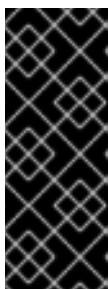

## IMPORTANT

If your cluster cannot have direct internet access, you can perform a restricted network installation on some types of infrastructure that you provision. During that process, you download the required content and use it to populate a mirror registry with the installation packages. With some installation types, the environment that you install your cluster in will not require internet access. Before you update the cluster, you update the content of the mirror registry.

### 9.4.3. Generating a key pair for cluster node SSH access

During an OpenShift Container Platform installation, you can provide an SSH public key to the installation program. The key is passed to the Red Hat Enterprise Linux CoreOS (RHCOS) nodes through their Ignition config files and is used to authenticate SSH access to the nodes. The key is added

to the `~/.ssh/authorized_keys` list for the **core** user on each node, which enables password-less authentication.

After the key is passed to the nodes, you can use the key pair to SSH in to the RHCOS nodes as the user **core**. To access the nodes through SSH, the private key identity must be managed by SSH for your local user.

If you want to SSH in to your cluster nodes to perform installation debugging or disaster recovery, you must provide the SSH public key during the installation process. The `./openshift-install gather` command also requires the SSH public key to be in place on the cluster nodes.



### IMPORTANT

Do not skip this procedure in production environments, where disaster recovery and debugging is required.



### NOTE

You must use a local key, not one that you configured with platform-specific approaches such as [AWS key pairs](#).

## Procedure

1. If you do not have an existing SSH key pair on your local machine to use for authentication onto your cluster nodes, create one. For example, on a computer that uses a Linux operating system, run the following command:

```
$ ssh-keygen -t ed25519 -N "" -f <path>/<file_name> 1
```

- 1 Specify the path and file name, such as `~/.ssh/id_ed25519`, of the new SSH key. If you have an existing key pair, ensure your public key is in the your `~/.ssh` directory.



### NOTE

If you plan to install an OpenShift Container Platform cluster that uses FIPS validated or Modules In Progress cryptographic libraries on the **x86\_64** architecture, do not create a key that uses the **ed25519** algorithm. Instead, create a key that uses the **rsa** or **ecdsa** algorithm.

2. View the public SSH key:

```
$ cat <path>/<file_name>.pub
```

For example, run the following to view the `~/.ssh/id_ed25519.pub` public key:

```
$ cat ~/.ssh/id_ed25519.pub
```

3. Add the SSH private key identity to the SSH agent for your local user, if it has not already been added. SSH agent management of the key is required for password-less SSH authentication onto your cluster nodes, or if you want to use the `./openshift-install gather` command.

**NOTE**

On some distributions, default SSH private key identities such as `~/.ssh/id_rsa` and `~/.ssh/id_dsa` are managed automatically.

- a. If the **ssh-agent** process is not already running for your local user, start it as a background task:

```
$ eval "$(ssh-agent -s)"
```

**Example output**

```
Agent pid 31874
```

**NOTE**

If your cluster is in FIPS mode, only use FIPS-compliant algorithms to generate the SSH key. The key must be either RSA or ECDSA.

4. Add your SSH private key to the **ssh-agent**:

```
$ ssh-add <path>/<file_name> 1
```

- 1** Specify the path and file name for your SSH private key, such as `~/.ssh/id_ed25519`

**Example output**

```
Identity added: /home/<you>/<path>/<file_name> (<computer_name>)
```

**Next steps**

- When you install OpenShift Container Platform, provide the SSH public key to the installation program.

**9.4.4. Obtaining the installation program**

Before you install OpenShift Container Platform, download the installation file on a local computer.

**Prerequisites**

- You have a computer that runs Linux or macOS, with 500 MB of local disk space

**Procedure**

1. Access the [Infrastructure Provider](#) page on the OpenShift Cluster Manager site. If you have a Red Hat account, log in with your credentials. If you do not, create an account.
2. Select your infrastructure provider.

3. Navigate to the page for your installation type, download the installation program that corresponds with your host operating system and architecture, and place the file in the directory where you will store the installation configuration files.

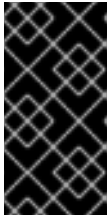

### IMPORTANT

The installation program creates several files on the computer that you use to install your cluster. You must keep the installation program and the files that the installation program creates after you finish installing the cluster. Both files are required to delete the cluster.

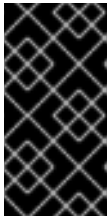

### IMPORTANT

Deleting the files created by the installation program does not remove your cluster, even if the cluster failed during installation. To remove your cluster, complete the OpenShift Container Platform uninstallation procedures for your specific cloud provider.

4. Extract the installation program. For example, on a computer that uses a Linux operating system, run the following command:

```
$ tar -xvf openshift-install-linux.tar.gz
```

5. Download your installation [pull secret from the Red Hat OpenShift Cluster Manager](#) . This pull secret allows you to authenticate with the services that are provided by the included authorities, including Quay.io, which serves the container images for OpenShift Container Platform components.

## 9.4.5. Exporting the IBM Cloud VPC API key

You must set the IBM Cloud VPC API key you created as a global variable; the installation program ingests the variable during startup to set the API key.

### Prerequisites

- You have created either a user API key or service ID API key for your IBM Cloud account.

### Procedure

- Export your IBM Cloud VPC API key as a global variable:

```
$ export IC_API_KEY=<api_key>
```

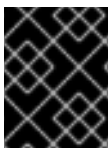

### IMPORTANT

You must set the variable name exactly as specified; the installation program expects the variable name to be present during startup.

## 9.4.6. Creating the installation configuration file

You can customize the OpenShift Container Platform cluster you install on IBM Cloud.

### Prerequisites

**Prerequisites**

- Obtain the OpenShift Container Platform installation program and the pull secret for your cluster.
- Obtain service principal permissions at the subscription level.

**Procedure**

1. Create the **install-config.yaml** file.
  - a. Change to the directory that contains the installation program and run the following command:

```
$ ./openshift-install create install-config --dir <installation_directory> 1
```

- 1** For **<installation\_directory>**, specify the directory name to store the files that the installation program creates.

**IMPORTANT**

Specify an empty directory. Some installation assets, like bootstrap X.509 certificates have short expiration intervals, so you must not reuse an installation directory. If you want to reuse individual files from another cluster installation, you can copy them into your directory. However, the file names for the installation assets might change between releases. Use caution when copying installation files from an earlier OpenShift Container Platform version.

- b. At the prompts, provide the configuration details for your cloud:
  - i. Optional: Select an SSH key to use to access your cluster machines.

**NOTE**

For production OpenShift Container Platform clusters on which you want to perform installation debugging or disaster recovery, specify an SSH key that your **ssh-agent** process uses.

- ii. Select **ibmcloud** as the platform to target.
  - iii. Select the region to deploy the cluster to.
  - iv. Select the base domain to deploy the cluster to. The base domain corresponds to the public DNS zone that you created for your cluster.
  - v. Enter a descriptive name for your cluster.
  - vi. Paste the [pull secret from the Red Hat OpenShift Cluster Manager](#) .
2. Modify the **install-config.yaml** file. You can find more information about the available parameters in the "Installation configuration parameters" section.
  3. Back up the **install-config.yaml** file so that you can use it to install multiple clusters.

**IMPORTANT**

The **install-config.yaml** file is consumed during the installation process. If you want to reuse the file, you must back it up now.

**9.4.6.1. Installation configuration parameters**

Before you deploy an OpenShift Container Platform cluster, you provide parameter values to describe your account on the cloud platform that hosts your cluster and optionally customize your cluster's platform. When you create the **install-config.yaml** installation configuration file, you provide values for the required parameters through the command line. If you customize your cluster, you can modify the **install-config.yaml** file to provide more details about the platform.

**NOTE**

After installation, you cannot modify these parameters in the **install-config.yaml** file.

**9.4.6.1.1. Required configuration parameters**

Required installation configuration parameters are described in the following table:

**Table 9.3. Required parameters**

Parameter	Description	Values
<b>apiVersion</b>	The API version for the <b>install-config.yaml</b> content. The current version is <b>v1</b> . The installer may also support older API versions.	String
<b>baseDomain</b>	The base domain of your cloud provider. The base domain is used to create routes to your OpenShift Container Platform cluster components. The full DNS name for your cluster is a combination of the <b>baseDomain</b> and <b>metadata.name</b> parameter values that uses the <b>&lt;metadata.name&gt;</b> . <b>&lt;baseDomain&gt;</b> format.	A fully-qualified domain or subdomain name, such as <b>example.com</b> .
<b>metadata</b>	Kubernetes resource <b>ObjectMeta</b> , from which only the <b>name</b> parameter is consumed.	Object

Parameter	Description	Values
<b>metadata.name</b>	The name of the cluster. DNS records for the cluster are all subdomains of <b>{{.metadata.name}}.{{.baseDomain}}</b> .	String of lowercase letters, hyphens (-), and periods (.), such as <b>dev</b> .
<b>platform</b>	The configuration for the specific platform upon which to perform the installation: <b>alibabacloud, aws, baremetal, azure, gcp, ibmcloud, openstack, ovirt, vsphere</b> , or <b>{}</b> . For additional information about <b>platform.&lt;platform&gt;</b> parameters, consult the table for your specific platform that follows.	Object
<b>pullSecret</b>	Get a <a href="#">pull secret from the Red Hat OpenShift Cluster Manager</a> to authenticate downloading container images for OpenShift Container Platform components from services such as Quay.io.	<pre>{   "auths":{     "cloud.openshift.com":{       "auth":"b3Blb=",       "email":"you@example.com"     },     "quay.io":{       "auth":"b3Blb=",       "email":"you@example.com"     }   } }</pre>

#### 9.4.6.1.2. Network configuration parameters

You can customize your installation configuration based on the requirements of your existing network infrastructure. For example, you can expand the IP address block for the cluster network or provide different IP address blocks than the defaults.

Only IPv4 addresses are supported.

Table 9.4. Network parameters

Parameter	Description	Values
-----------	-------------	--------

Parameter	Description	Values
<b>networking</b>	The configuration for the cluster network.	Object  <b>NOTE</b> You cannot modify parameters specified by the <b>networking</b> object after installation.
<b>networking.networkType</b>	The cluster network provider Container Network Interface (CNI) plugin to install.	Either <b>OpenShiftSDN</b> or <b>OVNKubernetes</b> . <b>OpenShiftSDN</b> is a CNI provider for all-Linux networks. <b>OVNKubernetes</b> is a CNI provider for Linux networks and hybrid networks that contain both Linux and Windows servers. The default value is <b>OpenShiftSDN</b> .
<b>networking.clusterNetwork</b>	The IP address blocks for pods.  The default value is <b>10.128.0.0/14</b> with a host prefix of <b>/23</b> .  If you specify multiple IP address blocks, the blocks must not overlap.	An array of objects. For example:  <pre>networking:   clusterNetwork:     - cidr: 10.128.0.0/14       hostPrefix: 23</pre>
<b>networking.clusterNetwork.cidr</b>	Required if you use <b>networking.clusterNetwork</b> . An IP address block.  An IPv4 network.	An IP address block in Classless Inter-Domain Routing (CIDR) notation. The prefix length for an IPv4 block is between <b>0</b> and <b>32</b> .
<b>networking.clusterNetwork.hostPrefix</b>	The subnet prefix length to assign to each individual node. For example, if <b>hostPrefix</b> is set to <b>23</b> then each node is assigned a <b>/23</b> subnet out of the given <b>cidr</b> . A <b>hostPrefix</b> value of <b>23</b> provides 510 ( $2^{(32 - 23)} - 2$ ) pod IP addresses.	A subnet prefix.  The default value is <b>23</b> .
<b>networking.serviceNetwork</b>	The IP address block for services. The default value is <b>172.30.0.0/16</b> .  The OpenShift SDN and OVN-Kubernetes network providers support only a single IP address block for the service network.	An array with an IP address block in CIDR format. For example:  <pre>networking:   serviceNetwork:     - 172.30.0.0/16</pre>



Parameter	Description	Values
<b>networking.machineNetwork</b>	The IP address blocks for machines.  If you specify multiple IP address blocks, the blocks must not overlap.	An array of objects. For example:  <pre>networking:   machineNetwork:   - cidr: 10.0.0.0/16</pre>
<b>networking.machineNetwork.cidr</b>	Required if you use <b>networking.machineNetwork</b> . An IP address block. The default value is <b>10.0.0.0/16</b> for all platforms other than libvirt. For libvirt, the default value is <b>192.168.126.0/24</b> .	An IP network block in CIDR notation.  For example, <b>10.0.0.0/16</b> .   <p><b>NOTE</b></p> <p>Set the <b>networking.machineNetwork</b> to match the CIDR that the preferred NIC resides in.</p>

#### 9.4.6.1.3. Optional configuration parameters



Optional installation configuration parameters are described in the following table:

Table 9.5. Optional parameters

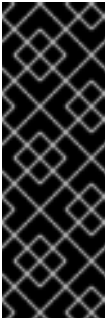

Parameter	Description	Values
<b>additionalTrustBundle</b>	A PEM-encoded X.509 certificate bundle that is added to the nodes' trusted certificate store. This trust bundle may also be used when a proxy has been configured.	String
<b>cgroupsV2</b>	Enables <a href="#">Linux control groups version 2</a> (cgroups v2) on specific nodes in your cluster. The OpenShift Container Platform process for enabling cgroups v2 disables all cgroup version 1 controllers and hierarchies. The OpenShift Container Platform cgroups version 2 feature is in Developer Preview and is not supported by Red Hat at this time.	<b>true</b>
<b>compute</b>	The configuration for the machines that comprise the compute nodes.	Array of <b>MachinePool</b> objects.

Parameter	Description	Values
<b>compute.architecture</b>	Determines the instruction set architecture of the machines in the pool. Currently, clusters with varied architectures are not supported. All pools must specify the same architecture. Valid values are <b>amd64</b> (the default).	String
<b>compute.hyperthreading</b>	Whether to enable or disable simultaneous multithreading, or <b>hyperthreading</b> , on compute machines. By default, simultaneous multithreading is enabled to increase the performance of your machines' cores.   <b>IMPORTANT</b> If you disable simultaneous multithreading, ensure that your capacity planning accounts for the dramatically decreased machine performance.	<b>Enabled</b> or <b>Disabled</b>
<b>compute.name</b>	Required if you use <b>compute</b> . The name of the machine pool.	<b>worker</b>
<b>compute.platform</b>	Required if you use <b>compute</b> . Use this parameter to specify the cloud provider to host the worker machines. This parameter value must match the <b>controlPlane.platform</b> parameter value.	<b>alibabacloud, aws, azure, gcp, ibmcloud, openstack, ovirt, vsphere</b> , or <b>{}</b>
<b>compute.replicas</b>	The number of compute machines, which are also known as worker machines, to provision.	A positive integer greater than or equal to <b>2</b> . The default value is <b>3</b> .
<b>controlPlane</b>	The configuration for the machines that comprise the control plane.	Array of <b>MachinePool</b> objects.

Parameter	Description	Values
<b>controlPlane.architecture</b>	Determines the instruction set architecture of the machines in the pool. Currently, clusters with varied architectures are not supported. All pools must specify the same architecture. Valid values are <b>amd64</b> (the default).	String
<b>controlPlane.hyperthreading</b>	<p>Whether to enable or disable simultaneous multithreading, or <b>hyperthreading</b>, on control plane machines. By default, simultaneous multithreading is enabled to increase the performance of your machines' cores.</p> <div style="display: flex; align-items: center;">  <div> <p><b>IMPORTANT</b></p> <p>If you disable simultaneous multithreading, ensure that your capacity planning accounts for the dramatically decreased machine performance.</p> </div> </div>	<b>Enabled</b> or <b>Disabled</b>
<b>controlPlane.name</b>	Required if you use <b>controlPlane</b> . The name of the machine pool.	<b>master</b>
<b>controlPlane.platform</b>	Required if you use <b>controlPlane</b> . Use this parameter to specify the cloud provider that hosts the control plane machines. This parameter value must match the <b>compute.platform</b> parameter value.	<b>alibabacloud, aws, azure, gcp, ibmcloud, openstack, ovirt, vsphere</b> , or <b>{}</b>
<b>controlPlane.replicas</b>	The number of control plane machines to provision.	The only supported value is <b>3</b> , which is the default value.

Parameter	Description	Values
<b>credentialsMode</b>	<p>The Cloud Credential Operator (CCO) mode. If no mode is specified, the CCO dynamically tries to determine the capabilities of the provided credentials, with a preference for mint mode on the platforms where multiple modes are supported.</p> <p> <b>NOTE</b></p> <p>Not all CCO modes are supported for all cloud providers. For more information on CCO modes, see the <i>Cloud Credential Operator</i> entry in the <i>Cluster Operators reference</i> content.</p> <p> <b>NOTE</b></p> <p>If your AWS account has service control policies (SCP) enabled, you must configure the <b>credentialsMode</b> parameter to <b>Mint</b>, <b>Passthrough</b> or <b>Manual</b>.</p>	<b>Mint, Passthrough, Manual</b> or an empty string ("").

Parameter	Description	Values
<b>fips</b>	<p>Enable or disable FIPS mode. The default is <b>false</b> (disabled). If FIPS mode is enabled, the Red Hat Enterprise Linux CoreOS (RHCOS) machines that OpenShift Container Platform runs on bypass the default Kubernetes cryptography suite and use the cryptography modules that are provided with RHCOS instead.</p> <div style="display: flex; align-items: flex-start;"> <div style="width: 20px; height: 100px; background: repeating-linear-gradient(45deg, transparent, transparent 2px, black 2px, black 4px); margin-right: 10px;"></div> <div> <p><b>IMPORTANT</b></p> <p>To enable FIPS mode for your cluster, you must run the installation program from a Red Hat Enterprise Linux (RHEL) computer configured to operate in FIPS mode. For more information about configuring FIPS mode on RHEL, see <a href="#">Installing the system in FIPS mode</a>. The use of FIPS validated or Modules In Process cryptographic libraries is only supported on OpenShift Container Platform deployments on the <b>x86_64</b> architecture.</p> </div> </div> <div style="display: flex; align-items: flex-start; margin-top: 20px;"> <div style="width: 20px; height: 100px; background: repeating-linear-gradient(45deg, transparent, transparent 2px, black 2px, black 4px); margin-right: 10px;"></div> <div> <p><b>NOTE</b></p> <p>If you are using Azure File storage, you cannot enable FIPS mode.</p> </div> </div>	<b>false</b> or <b>true</b>
<b>imageContentSources</b>	Sources and repositories for the release-image content.	Array of objects. Includes a <b>source</b> and, optionally, <b>mirrors</b> , as described in the following rows of this table.
<b>imageContentSources.source</b>	Required if you use <b>imageContentSources</b> . Specify the repository that users refer to, for example, in image pull specifications.	String
<b>imageContentSources.mirrors</b>	Specify one or more repositories that may also contain the same images.	Array of strings

Parameter	Description	Values
<b>publish</b>	How to publish or expose the user-facing endpoints of your cluster, such as the Kubernetes API, OpenShift routes.	<p><b>Internal</b> or <b>External</b>. The default value is <b>External</b>.</p> <p>Setting this field to <b>Internal</b> is not supported on non-cloud platforms and IBM Cloud VPC.</p> <div style="display: flex; align-items: flex-start;">  <div> <p><b>IMPORTANT</b></p> <p>If the value of the field is set to <b>Internal</b>, the cluster will become non-functional. For more information, refer to <a href="#">BZ#1953035</a>.</p> </div> </div>
<b>sshKey</b>	<p>The SSH key or keys to authenticate access your cluster machines.</p> <div style="display: flex; align-items: flex-start;">  <div> <p><b>NOTE</b></p> <p>For production OpenShift Container Platform clusters on which you want to perform installation debugging or disaster recovery, specify an SSH key that your <b>ssh-agent</b> process uses.</p> </div> </div>	<p>One or more keys. For example:</p> <pre>sshKey:   &lt;key1&gt;   &lt;key2&gt;   &lt;key3&gt;</pre>

#### 9.4.6.1.4. Additional IBM Cloud VPC configuration parameters

Additional IBM Cloud VPC configuration parameters are described in the following table:

Table 9.6. Additional IBM Cloud VPC parameters

Parameter	Description	Values
<b>platform.ibm.cloud.resourceGroupName</b>	The name of an existing resource group to install your cluster to. This resource group must only be used for this specific cluster because the cluster components assume ownership of all of the resources in the resource group. If undefined, a new resource group is created for the cluster. [1]	String, for example <b>existing_resource_group</b> .

Parameter	Description	Values
<b>platform.ibmcloud.dedicatedHosts.profile</b>	The new dedicated host to create. If you specify a value for <b>platform.ibmcloud.dedicatedHosts.name</b> , this parameter is not required.	Valid IBM Cloud VPC dedicated host profile, such as <b>cx2-host-152x304</b> . [2]
<b>platform.ibmcloud.dedicatedHosts.name</b>	An existing dedicated host. If you specify a value for <b>platform.ibmcloud.dedicatedHosts.profile</b> , this parameter is not required.	String, for example <b>my-dedicated-host-name</b> .
<b>platform.ibmcloud.type</b>	The instance type for all IBM Cloud VPC machines.	Valid IBM Cloud VPC instance type, such as <b>bx2-8x32</b> . [2]

1. Whether you define an existing resource group, or if the installer creates one, determines how the resource group is treated when the cluster is uninstalled. If you define a resource group, the installer removes all of the installer-provisioned resources, but leaves the resource group alone; if a resource group is created as part of the installation, the installer removes all of the installer-provisioned resources and the resource group.
2. To determine which profile best meets your needs, see [Instance Profiles](#) in the IBM documentation.

#### 9.4.6.2. Sample customized install-config.yaml file for IBM Cloud VPC

You can customize the **install-config.yaml** file to specify more details about your OpenShift Container Platform cluster's platform or modify the values of the required parameters.



#### IMPORTANT

This sample YAML file is provided for reference only. You must obtain your **install-config.yaml** file by using the installation program and modify it.

```

apiVersion: v1
baseDomain: example.com 1
controlPlane: 2 3
  hyperthreading: Enabled 4
  name: master
  platform:

```

```

  ibmcloud: {}
  replicas: 3
  compute: 5 6
- hyperthreading: Enabled 7
  name: worker
  platform:
    ibmcloud: {}
    replicas: 3
  metadata:
    name: test-cluster 8
  networking:
    clusterNetwork:
    - cidr: 10.128.0.0/14
      hostPrefix: 23
    machineNetwork:
    - cidr: 10.0.0.0/16
    networkType: OpenShiftSDN
    serviceNetwork:
    - 172.30.0.0/16
  platform:
    ibmcloud:
      region: us-south 9
  credentialsMode: Manual
  publish: External
  pullSecret: '{"auths": ...}' 10
  fips: false 11
  sshKey: ssh-ed25519 AAAA... 12

```

1 8 9 10 Required. The installation program prompts you for this value.

2 5 If you do not provide these parameters and values, the installation program provides the default value.

3 6 The **controlPlane** section is a single mapping, but the **compute** section is a sequence of mappings. To meet the requirements of the different data structures, the first line of the **compute** section must begin with a hyphen, -, and the first line of the **controlPlane** section must not. Only one control plane pool is used.

4 7 Whether to enable or disable simultaneous multithreading, or **hyperthreading**. By default, simultaneous multithreading is enabled to increase the performance of your machines' cores. You can disable it by setting the parameter value to **Disabled**. If you disable simultaneous multithreading in some cluster machines, you must disable it in all cluster machines.



### IMPORTANT

If you disable simultaneous multithreading, ensure that your capacity planning accounts for the dramatically decreased machine performance. Use larger machine types, such as **n1-standard-8**, for your machines if you disable simultaneous multithreading.

11 Whether to enable or disable FIPS mode. By default, FIPS mode is not enabled. If FIPS mode is enabled, the Red Hat Enterprise Linux CoreOS (RHCOS) machines that OpenShift Container Platform runs on bypass the default Kubernetes cryptography suite and use the cryptography modules that are provided with RHCOS instead.





## IMPORTANT

To enable FIPS mode for your cluster, you must run the installation program from a Red Hat Enterprise Linux (RHEL) computer configured to operate in FIPS mode. For more information about configuring FIPS mode on RHEL, see [Installing the system in FIPS mode](#). The use of FIPS Validated or Modules in Process cryptographic libraries is only supported on OpenShift Container Platform deployments on the **x86\_64** architecture.

- 12 You can optionally provide the **sshKey** value that you use to access the machines in your cluster.



## NOTE

For production OpenShift Container Platform clusters on which you want to perform installation debugging or disaster recovery, specify an SSH key that your **ssh-agent** process uses.

### 9.4.6.3. Configuring the cluster-wide proxy during installation

Production environments can deny direct access to the internet and instead have an HTTP or HTTPS proxy available. You can configure a new OpenShift Container Platform cluster to use a proxy by configuring the proxy settings in the **install-config.yaml** file.

#### Prerequisites

- You have an existing **install-config.yaml** file.
- You reviewed the sites that your cluster requires access to and determined whether any of them need to bypass the proxy. By default, all cluster egress traffic is proxied, including calls to hosting cloud provider APIs. You added sites to the **Proxy** object's **spec.noProxy** field to bypass the proxy if necessary.



## NOTE

The **Proxy** object **status.noProxy** field is populated with the values of the **networking.machineNetwork[].cidr**, **networking.clusterNetwork[].cidr**, and **networking.serviceNetwork[]** fields from your installation configuration.

For installations on Amazon Web Services (AWS), Google Cloud Platform (GCP), Microsoft Azure, and Red Hat OpenStack Platform (RHOSP), the **Proxy** object **status.noProxy** field is also populated with the instance metadata endpoint (**169.254.169.254**).

#### Procedure

- Edit your **install-config.yaml** file and add the proxy settings. For example:

```
apiVersion: v1
baseDomain: my.domain.com
proxy:
  httpProxy: http://<username>:<pswd>@<ip>:<port> 1
  httpsProxy: https://<username>:<pswd>@<ip>:<port> 2
  noProxy: example.com 3
```

```

additionalTrustBundle: | 4
-----BEGIN CERTIFICATE-----
<MY_TRUSTED_CA_CERT>
-----END CERTIFICATE-----
...

```

- 1 A proxy URL to use for creating HTTP connections outside the cluster. The URL scheme must be **http**.
- 2 A proxy URL to use for creating HTTPS connections outside the cluster.
- 3 A comma-separated list of destination domain names, IP addresses, or other network CIDRs to exclude from proxying. Preface a domain with **.** to match subdomains only. For example, **.y.com** matches **x.y.com**, but not **y.com**. Use **\*** to bypass the proxy for all destinations.
- 4 If provided, the installation program generates a config map that is named **user-ca-bundle** in the **openshift-config** namespace that contains one or more additional CA certificates that are required for proxying HTTPS connections. The Cluster Network Operator then creates a **trusted-ca-bundle** config map that merges these contents with the Red Hat Enterprise Linux CoreOS (RHCOS) trust bundle, and this config map is referenced in the **trustedCA** field of the **Proxy** object. The **additionalTrustBundle** field is required unless the proxy's identity certificate is signed by an authority from the RHCOS trust bundle.



#### NOTE

The installation program does not support the proxy **readinessEndpoints** field.



#### NOTE

If the installer times out, restart and then complete the deployment by using the **wait-for** command of the installer. For example:

```
$ ./openshift-install wait-for install-complete --log-level debug
```

2. Save the file and reference it when installing OpenShift Container Platform.

The installation program creates a cluster-wide proxy that is named **cluster** that uses the proxy settings in the provided **install-config.yaml** file. If no proxy settings are provided, a **cluster Proxy** object is still created, but it will have a nil **spec**.



#### NOTE

Only the **Proxy** object named **cluster** is supported, and no additional proxies can be created.

### 9.4.7. Manually creating IAM for IBM Cloud VPC

Installing the cluster requires that the Cloud Credential Operator (CCO) operate in manual mode. While the installation program configures the CCO for manual mode, you must specify the identity and access management secrets for your cloud provider.

You can use the Cloud Credential Operator (CCO) utility (**ccoctl**) to create the required IBM Cloud VPC resources.

## Prerequisites

- You have configured the **ccoctl** binary.
- You have an existing **install-config.yaml** file.

## Procedure

1. Edit the **install-config.yaml** configuration file so that it contains the **credentialsMode** parameter set to **Manual**.

### Example **install-config.yaml** configuration file

```
apiVersion: v1
baseDomain: cluster1.example.com
credentialsMode: Manual 1
compute:
- architecture: amd64
  hyperthreading: Enabled
...
```

- 1** This line is added to set the **credentialsMode** parameter to **Manual**.

2. To generate the manifests, run the following command from the directory that contains the installation program:

```
$ openshift-install create manifests --dir <installation_directory>
```

3. From the directory that contains the installation program, obtain the OpenShift Container Platform release image that your **openshift-install** binary is built to use:

```
$ RELEASE_IMAGE=$(./openshift-install version | awk '/release image/ {print $3}')
```

4. Extract the **CredentialsRequest** objects from the OpenShift Container Platform release image:

```
$ oc adm release extract --cloud=ibmcloud --credentials-requests $RELEASE_IMAGE \
--to=<path_to_credential_requests_directory> 1
```

- 1** The directory where the credential requests will be stored.

This command creates a YAML file for each **CredentialsRequest** object.

### Sample **CredentialsRequest** object

```
apiVersion: cloudcredential.openshift.io/v1
kind: CredentialsRequest
metadata:
  labels:
    controller-tools.k8s.io: "1.0"
```

```

name: openshift-image-registry-ibmcos
namespace: openshift-cloud-credential-operator
spec:
  secretRef:
    name: installer-cloud-credentials
    namespace: openshift-image-registry
  providerSpec:
    apiVersion: cloudcredential.openshift.io/v1
    kind: IBMCloudProviderSpec
    policies:
      - attributes:
          - name: serviceName
            value: cloud-object-storage
        roles:
          - crn:v1:bluemix:public:iam::::role:Viewer
          - crn:v1:bluemix:public:iam::::role:Operator
          - crn:v1:bluemix:public:iam::::role:Editor
          - crn:v1:bluemix:public:iam::::serviceRole:Reader
          - crn:v1:bluemix:public:iam::::serviceRole:Writer
        - attributes:
          - name: resourceType
            value: resource-group
        roles:
          - crn:v1:bluemix:public:iam::::role:Viewer

```

5. Create the service ID for each credential request, assign the policies defined, create an API key in IBM Cloud VPC, and generate the secret:

```

$ ccoctl ibmcloud create-service-id \
  --credentials-requests-dir <path_to_store_credential_request_templates> \ 1
  --name <cluster_name> \ 2
  --output-dir <installation_directory> \
  --resource-group-name <resource_group_name> 3

```

- 1** The directory where the credential requests are stored.
- 2** The name of the OpenShift Container Platform cluster.
- 3** Optional: The name of the resource group used for scoping the access policies.



## NOTE

If your cluster uses Technology Preview features that are enabled by the **TechPreviewNoUpgrade** feature set, you must include the **--enable-tech-preview** parameter.

If an incorrect resource group name is provided, the installation fails during the bootstrap phase. To find the correct resource group name, run the following command:

```

$ grep resourceGroupName <installation_directory>/manifests/cluster-
infrastructure-02-config.yml

```

## Verification

- Ensure that the appropriate secrets were generated in your cluster's **manifests** directory.

### 9.4.8. Deploying the cluster

You can install OpenShift Container Platform on a compatible cloud platform.



#### IMPORTANT

You can run the **create cluster** command of the installation program only once, during initial installation.

#### Prerequisites

- Configure an account with the cloud platform that hosts your cluster.
- Obtain the OpenShift Container Platform installation program and the pull secret for your cluster.

#### Procedure

1. Change to the directory that contains the installation program and initialize the cluster deployment:

```
$ ./openshift-install create cluster --dir <installation_directory> \ 1
--log-level=info 2
```

- 1 For **<installation\_directory>**, specify the location of your customized **./install-config.yaml** file.
- 2 To view different installation details, specify **warn**, **debug**, or **error** instead of **info**.



#### NOTE

If the cloud provider account that you configured on your host does not have sufficient permissions to deploy the cluster, the installation process stops, and the missing permissions are displayed.

When the cluster deployment completes, directions for accessing your cluster, including a link to its web console and credentials for the **kubeadmin** user, display in your terminal.

#### Example output

```
...
INFO Install complete!
INFO To access the cluster as the system:admin user when using 'oc', run 'export
KUBECONFIG=/home/myuser/install_dir/auth/kubeconfig'
INFO Access the OpenShift web-console here: https://console-openshift-
console.apps.mycluster.example.com
INFO Login to the console with user: "kubeadmin", and password: "4vYBz-Ee6gm-ymBZj-
Wt5AL"
INFO Time elapsed: 36m22s
```

**NOTE**

The cluster access and credential information also outputs to **<installation\_directory>/openshift\_install.log** when an installation succeeds.

**IMPORTANT**

- The Ignition config files that the installation program generates contain certificates that expire after 24 hours, which are then renewed at that time. If the cluster is shut down before renewing the certificates and the cluster is later restarted after the 24 hours have elapsed, the cluster automatically recovers the expired certificates. The exception is that you must manually approve the pending **node-bootstrapper** certificate signing requests (CSRs) to recover kubelet certificates. See the documentation for *Recovering from expired control plane certificates* for more information.
- It is recommended that you use Ignition config files within 12 hours after they are generated because the 24-hour certificate rotates from 16 to 22 hours after the cluster is installed. By using the Ignition config files within 12 hours, you can avoid installation failure if the certificate update runs during installation.

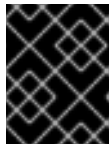
**IMPORTANT**

You must not delete the installation program or the files that the installation program creates. Both are required to delete the cluster.

### 9.4.9. Installing the OpenShift CLI by downloading the binary

You can install the OpenShift CLI (**oc**) to interact with OpenShift Container Platform from a command-line interface. You can install **oc** on Linux, Windows, or macOS.

**IMPORTANT**

If you installed an earlier version of **oc**, you cannot use it to complete all of the commands in OpenShift Container Platform 4.10. Download and install the new version of **oc**.

#### Installing the OpenShift CLI on Linux

You can install the OpenShift CLI (**oc**) binary on Linux by using the following procedure.

#### Procedure

1. Navigate to the [OpenShift Container Platform downloads page](#) on the Red Hat Customer Portal.
2. Select the appropriate version in the **Version** drop-down menu.
3. Click **Download Now** next to the **OpenShift v4.10 Linux Client** entry and save the file.
4. Unpack the archive:

```
$ tar xvf <file>
```

5. Place the **oc** binary in a directory that is on your **PATH**.

To check your **PATH**, execute the following command:

```
$ echo $PATH
```

After you install the OpenShift CLI, it is available using the **oc** command:

```
$ oc <command>
```

### Installing the OpenShift CLI on Windows

You can install the OpenShift CLI (**oc**) binary on Windows by using the following procedure.

#### Procedure

1. Navigate to the [OpenShift Container Platform downloads page](#) on the Red Hat Customer Portal.
2. Select the appropriate version in the **Version** drop-down menu.
3. Click **Download Now** next to the **OpenShift v4.10 Windows Client** entry and save the file.
4. Unzip the archive with a ZIP program.
5. Move the **oc** binary to a directory that is on your **PATH**.  
To check your **PATH**, open the command prompt and execute the following command:

```
C:\> path
```

After you install the OpenShift CLI, it is available using the **oc** command:

```
C:\> oc <command>
```

### Installing the OpenShift CLI on macOS

You can install the OpenShift CLI (**oc**) binary on macOS by using the following procedure.

#### Procedure

1. Navigate to the [OpenShift Container Platform downloads page](#) on the Red Hat Customer Portal.
2. Select the appropriate version in the **Version** drop-down menu.
3. Click **Download Now** next to the **OpenShift v4.10 MacOSX Client** entry and save the file.
4. Unpack and unzip the archive.
5. Move the **oc** binary to a directory on your **PATH**.  
To check your **PATH**, open a terminal and execute the following command:

```
$ echo $PATH
```

After you install the OpenShift CLI, it is available using the **oc** command:

```
$ oc <command>
```

### 9.4.10. Logging in to the cluster by using the CLI

You can log in to your cluster as a default system user by exporting the cluster **kubeconfig** file. The **kubeconfig** file contains information about the cluster that is used by the CLI to connect a client to the correct cluster and API server. The file is specific to a cluster and is created during OpenShift Container Platform installation.

#### Prerequisites

- You deployed an OpenShift Container Platform cluster.
- You installed the **oc** CLI.

#### Procedure

1. Export the **kubeadmin** credentials:

```
$ export KUBECONFIG=<installation_directory>/auth/kubeconfig 1
```

- 1** For **<installation\_directory>**, specify the path to the directory that you stored the installation files in.

2. Verify you can run **oc** commands successfully using the exported configuration:

```
$ oc whoami
```

#### Example output

```
system:admin
```

#### Additional resources

- [Accessing the web console](#)

### 9.4.11. Telemetry access for OpenShift Container Platform

In OpenShift Container Platform 4.10, the Telemetry service, which runs by default to provide metrics about cluster health and the success of updates, requires internet access. If your cluster is connected to the internet, Telemetry runs automatically, and your cluster is registered to [OpenShift Cluster Manager](#).

After you confirm that your [OpenShift Cluster Manager](#) inventory is correct, either maintained automatically by Telemetry or manually by using OpenShift Cluster Manager, [use subscription watch](#) to track your OpenShift Container Platform subscriptions at the account or multi-cluster level.

#### Additional resources

- [About remote health monitoring](#)

### 9.4.12. Next steps



- [Customize your cluster](#).
- If necessary, you can [opt out of remote health reporting](#).

## 9.5. INSTALLING A CLUSTER ON IBM CLOUD VPC WITH NETWORK CUSTOMIZATIONS

In OpenShift Container Platform version 4.10, you can install a cluster with a customized network configuration on infrastructure that the installation program provisions on IBM Cloud VPC. By customizing your network configuration, your cluster can coexist with existing IP address allocations in your environment and integrate with existing MTU and VXLAN configurations. To customize the installation, you modify parameters in the **install-config.yaml** file before you install the cluster.

You must set most of the network configuration parameters during installation, and you can modify only **kubeProxy** configuration parameters in a running cluster.



### IMPORTANT

IBM Cloud VPC using installer-provisioned infrastructure is a Technology Preview feature only. Technology Preview features are not supported with Red Hat production service level agreements (SLAs) and might not be functionally complete. Red Hat does not recommend using them in production. These features provide early access to upcoming product features, enabling customers to test functionality and provide feedback during the development process.

For more information about the support scope of Red Hat Technology Preview features, see [Technology Preview Features Support Scope](#).

### 9.5.1. Prerequisites

- You reviewed details about the [OpenShift Container Platform installation and update](#) processes.
- You read the documentation on [selecting a cluster installation method and preparing it for users](#).
- You [configured an IBM Cloud account](#) to host the cluster.
- If you use a firewall, you [configured it to allow the sites](#) that your cluster requires access to.
- You configured the **ccoctl** utility before you installed the cluster. For more information, see [Configuring IAM for IBM Cloud VPC](#).

### 9.5.2. Internet access for OpenShift Container Platform

In OpenShift Container Platform 4.10, you require access to the internet to install your cluster.

You must have internet access to:

- Access [OpenShift Cluster Manager](#) to download the installation program and perform subscription management. If the cluster has internet access and you do not disable Telemetry, that service automatically entitles your cluster.
- Access [Quay.io](#) to obtain the packages that are required to install your cluster.

- Obtain the packages that are required to perform cluster updates.



### IMPORTANT

If your cluster cannot have direct internet access, you can perform a restricted network installation on some types of infrastructure that you provision. During that process, you download the required content and use it to populate a mirror registry with the installation packages. With some installation types, the environment that you install your cluster in will not require internet access. Before you update the cluster, you update the content of the mirror registry.

### 9.5.3. Generating a key pair for cluster node SSH access

During an OpenShift Container Platform installation, you can provide an SSH public key to the installation program. The key is passed to the Red Hat Enterprise Linux CoreOS (RHCOS) nodes through their Ignition config files and is used to authenticate SSH access to the nodes. The key is added to the `~/.ssh/authorized_keys` list for the **core** user on each node, which enables password-less authentication.

After the key is passed to the nodes, you can use the key pair to SSH in to the RHCOS nodes as the user **core**. To access the nodes through SSH, the private key identity must be managed by SSH for your local user.

If you want to SSH in to your cluster nodes to perform installation debugging or disaster recovery, you must provide the SSH public key during the installation process. The `./openshift-install gather` command also requires the SSH public key to be in place on the cluster nodes.

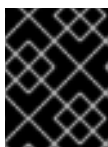

### IMPORTANT

Do not skip this procedure in production environments, where disaster recovery and debugging is required.



### NOTE

You must use a local key, not one that you configured with platform-specific approaches such as [AWS key pairs](#).

### Procedure

1. If you do not have an existing SSH key pair on your local machine to use for authentication onto your cluster nodes, create one. For example, on a computer that uses a Linux operating system, run the following command:

```
$ ssh-keygen -t ed25519 -N "" -f <path>/<file_name> 1
```

- 1 Specify the path and file name, such as `~/.ssh/id_ed25519`, of the new SSH key. If you have an existing key pair, ensure your public key is in the your `~/.ssh` directory.

**NOTE**

If you plan to install an OpenShift Container Platform cluster that uses FIPS validated or Modules In Process cryptographic libraries on the **x86\_64** architecture, do not create a key that uses the **ed25519** algorithm. Instead, create a key that uses the **rsa** or **ecdsa** algorithm.

2. View the public SSH key:

```
$ cat <path>/<file_name>.pub
```

For example, run the following to view the `~/.ssh/id_ed25519.pub` public key:

```
$ cat ~/.ssh/id_ed25519.pub
```

3. Add the SSH private key identity to the SSH agent for your local user, if it has not already been added. SSH agent management of the key is required for password-less SSH authentication onto your cluster nodes, or if you want to use the `./openshift-install gather` command.

**NOTE**

On some distributions, default SSH private key identities such as `~/.ssh/id_rsa` and `~/.ssh/id_dsa` are managed automatically.

- a. If the **ssh-agent** process is not already running for your local user, start it as a background task:

```
$ eval "$(ssh-agent -s)"
```

**Example output**

```
Agent pid 31874
```

**NOTE**

If your cluster is in FIPS mode, only use FIPS-compliant algorithms to generate the SSH key. The key must be either RSA or ECDSA.

4. Add your SSH private key to the **ssh-agent**:

```
$ ssh-add <path>/<file_name> 1
```

- 1** Specify the path and file name for your SSH private key, such as `~/.ssh/id_ed25519`

**Example output**

```
Identity added: /home/<you>/<path>/<file_name> (<computer_name>)
```

**Next steps**

- When you install OpenShift Container Platform, provide the SSH public key to the installation program.

### 9.5.4. Obtaining the installation program

Before you install OpenShift Container Platform, download the installation file on a local computer.

#### Prerequisites

- You have a computer that runs Linux or macOS, with 500 MB of local disk space

#### Procedure

1. Access the [Infrastructure Provider](#) page on the OpenShift Cluster Manager site. If you have a Red Hat account, log in with your credentials. If you do not, create an account.
2. Select your infrastructure provider.
3. Navigate to the page for your installation type, download the installation program that corresponds with your host operating system and architecture, and place the file in the directory where you will store the installation configuration files.

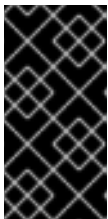

#### IMPORTANT

The installation program creates several files on the computer that you use to install your cluster. You must keep the installation program and the files that the installation program creates after you finish installing the cluster. Both files are required to delete the cluster.

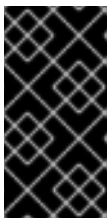

#### IMPORTANT

Deleting the files created by the installation program does not remove your cluster, even if the cluster failed during installation. To remove your cluster, complete the OpenShift Container Platform uninstallation procedures for your specific cloud provider.

4. Extract the installation program. For example, on a computer that uses a Linux operating system, run the following command:

```
$ tar -xvf openshift-install-linux.tar.gz
```

5. Download your installation [pull secret from the Red Hat OpenShift Cluster Manager](#) . This pull secret allows you to authenticate with the services that are provided by the included authorities, including Quay.io, which serves the container images for OpenShift Container Platform components.

### 9.5.5. Exporting the IBM Cloud VPC API key

You must set the IBM Cloud VPC API key you created as a global variable; the installation program ingests the variable during startup to set the API key.

#### Prerequisites

- You have created either a user API key or service ID API key for your IBM Cloud account.

### Procedure

- Export your IBM Cloud VPC API key as a global variable:

```
$ export IC_API_KEY=<api_key>
```



### IMPORTANT

You must set the variable name exactly as specified; the installation program expects the variable name to be present during startup.

## 9.5.6. Creating the installation configuration file

You can customize the OpenShift Container Platform cluster you install on IBM Cloud.

### Prerequisites

- Obtain the OpenShift Container Platform installation program and the pull secret for your cluster.
- Obtain service principal permissions at the subscription level.

### Procedure

1. Create the **install-config.yaml** file.
  - a. Change to the directory that contains the installation program and run the following command:

```
$ ./openshift-install create install-config --dir <installation_directory> 1
```

- 1** For **<installation\_directory>**, specify the directory name to store the files that the installation program creates.



### IMPORTANT

Specify an empty directory. Some installation assets, like bootstrap X.509 certificates have short expiration intervals, so you must not reuse an installation directory. If you want to reuse individual files from another cluster installation, you can copy them into your directory. However, the file names for the installation assets might change between releases. Use caution when copying installation files from an earlier OpenShift Container Platform version.

- b. At the prompts, provide the configuration details for your cloud:
  - i. Optional: Select an SSH key to use to access your cluster machines.

**NOTE**

For production OpenShift Container Platform clusters on which you want to perform installation debugging or disaster recovery, specify an SSH key that your **ssh-agent** process uses.

- ii. Select **ibmcloud** as the platform to target.
  - iii. Select the region to deploy the cluster to.
  - iv. Select the base domain to deploy the cluster to. The base domain corresponds to the public DNS zone that you created for your cluster.
  - v. Enter a descriptive name for your cluster.
  - vi. Paste the [pull secret from the Red Hat OpenShift Cluster Manager](#) .
2. Modify the **install-config.yaml** file. You can find more information about the available parameters in the "Installation configuration parameters" section.
  3. Back up the **install-config.yaml** file so that you can use it to install multiple clusters.

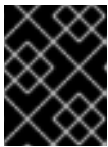
**IMPORTANT**

The **install-config.yaml** file is consumed during the installation process. If you want to reuse the file, you must back it up now.

**9.5.6.1. Installation configuration parameters**

Before you deploy an OpenShift Container Platform cluster, you provide parameter values to describe your account on the cloud platform that hosts your cluster and optionally customize your cluster's platform. When you create the **install-config.yaml** installation configuration file, you provide values for the required parameters through the command line. If you customize your cluster, you can modify the **install-config.yaml** file to provide more details about the platform.

**NOTE**

After installation, you cannot modify these parameters in the **install-config.yaml** file.

**9.5.6.1.1. Required configuration parameters**

Required installation configuration parameters are described in the following table:

**Table 9.7. Required parameters**

Parameter	Description	Values
<b>apiVersion</b>	The API version for the <b>install-config.yaml</b> content. The current version is <b>v1</b> . The installer may also support older API versions.	String

Parameter	Description	Values
<b>baseDomain</b>	The base domain of your cloud provider. The base domain is used to create routes to your OpenShift Container Platform cluster components. The full DNS name for your cluster is a combination of the <b>baseDomain</b> and <b>metadata.name</b> parameter values that uses the <b>&lt;metadata.name&gt;</b> . <b>&lt;baseDomain&gt;</b> format.	A fully-qualified domain or subdomain name, such as <b>example.com</b> .
<b>metadata</b>	Kubernetes resource <b>ObjectMeta</b> , from which only the <b>name</b> parameter is consumed.	Object
<b>metadata.name</b>	The name of the cluster. DNS records for the cluster are all subdomains of <b>{{.metadata.name}}</b> . <b>{{.baseDomain}}</b> .	String of lowercase letters, hyphens (-), and periods (.), such as <b>dev</b> .
<b>platform</b>	The configuration for the specific platform upon which to perform the installation: <b>alibabacloud</b> , <b>aws</b> , <b>baremetal</b> , <b>azure</b> , <b>gcp</b> , <b>ibmcloud</b> , <b>openstack</b> , <b>ovirt</b> , <b>vsphere</b> , or <b>{}</b> . For additional information about <b>platform.&lt;platform&gt;</b> parameters, consult the table for your specific platform that follows.	Object

Parameter	Description	Values
<b>pullSecret</b>	Get a <a href="#">pull secret from the Red Hat OpenShift Cluster Manager</a> to authenticate downloading container images for OpenShift Container Platform components from services such as Quay.io.	<pre>{   "auths":{     "cloud.openshift.com":{       "auth":"b3Blb=",       "email":"you@example.com"     },     "quay.io":{       "auth":"b3Blb=",       "email":"you@example.com"     }   } }</pre>

### 9.5.6.1.2. Network configuration parameters

You can customize your installation configuration based on the requirements of your existing network infrastructure. For example, you can expand the IP address block for the cluster network or provide different IP address blocks than the defaults.

Only IPv4 addresses are supported.

Table 9.8. Network parameters

Parameter	Description	Values
<b>networking</b>	The configuration for the cluster network.	Object <div style="display: flex; align-items: center; margin-top: 10px;">  <div> <p><b>NOTE</b></p> <p>You cannot modify parameters specified by the <b>networking</b> object after installation.</p> </div> </div>
<b>networking.networkType</b>	The cluster network provider Container Network Interface (CNI) plugin to install.	Either <b>OpenShiftSDN</b> or <b>OVNKubernetes</b> . <b>OpenShiftSDN</b> is a CNI provider for all-Linux networks. <b>OVNKubernetes</b> is a CNI provider for Linux networks and hybrid networks that contain both Linux and Windows servers. The default value is <b>OpenShiftSDN</b> .



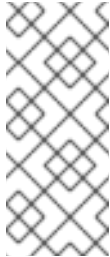

Parameter	Description	Values
<b>networking.clusterNetwork</b>	<p>The IP address blocks for pods.</p> <p>The default value is <b>10.128.0.0/14</b> with a host prefix of <b>/23</b>.</p> <p>If you specify multiple IP address blocks, the blocks must not overlap.</p>	<p>An array of objects. For example:</p> <pre>networking:   clusterNetwork:     - cidr: 10.128.0.0/14       hostPrefix: 23</pre>
<b>networking.clusterNetwork.cidr</b>	<p>Required if you use <b>networking.clusterNetwork</b>. An IP address block.</p> <p>An IPv4 network.</p>	<p>An IP address block in Classless Inter-Domain Routing (CIDR) notation. The prefix length for an IPv4 block is between <b>0</b> and <b>32</b>.</p>
<b>networking.clusterNetwork.hostPrefix</b>	<p>The subnet prefix length to assign to each individual node. For example, if <b>hostPrefix</b> is set to <b>23</b> then each node is assigned a <b>/23</b> subnet out of the given <b>cidr</b>. A <b>hostPrefix</b> value of <b>23</b> provides 510 (<math>2^{(32 - 23)} - 2</math>) pod IP addresses.</p>	<p>A subnet prefix.</p> <p>The default value is <b>23</b>.</p>
<b>networking.serviceNetwork</b>	<p>The IP address block for services. The default value is <b>172.30.0.0/16</b>.</p> <p>The OpenShift SDN and OVN-Kubernetes network providers support only a single IP address block for the service network.</p>	<p>An array with an IP address block in CIDR format. For example:</p> <pre>networking:   serviceNetwork:     - 172.30.0.0/16</pre>
<b>networking.machineNetwork</b>	<p>The IP address blocks for machines.</p> <p>If you specify multiple IP address blocks, the blocks must not overlap.</p>	<p>An array of objects. For example:</p> <pre>networking:   machineNetwork:     - cidr: 10.0.0.0/16</pre>
<b>networking.machineNetwork.cidr</b>	<p>Required if you use <b>networking.machineNetwork</b>. An IP address block. The default value is <b>10.0.0.0/16</b> for all platforms other than libvirt. For libvirt, the default value is <b>192.168.126.0/24</b>.</p>	<p>An IP network block in CIDR notation.</p> <p>For example, <b>10.0.0.0/16</b>.</p> <div style="display: flex; align-items: flex-start;">  <div> <p><b>NOTE</b></p> <p>Set the <b>networking.machineNetwork</b> to match the CIDR that the preferred NIC resides in.</p> </div> </div>



## 9.5.6.1.3. Optional configuration parameters

Optional installation configuration parameters are described in the following table:



Table 9.9. Optional parameters

Parameter	Description	Values
<b>additionalTrustBundle</b>	A PEM-encoded X.509 certificate bundle that is added to the nodes' trusted certificate store. This trust bundle may also be used when a proxy has been configured.	String
<b>cgroupsV2</b>	Enables <a href="#">Linux control groups version 2</a> (cgroups v2) on specific nodes in your cluster. The OpenShift Container Platform process for enabling cgroups v2 disables all cgroup version 1 controllers and hierarchies. The OpenShift Container Platform cgroups version 2 feature is in Developer Preview and is not supported by Red Hat at this time.	<b>true</b>
<b>compute</b>	The configuration for the machines that comprise the compute nodes.	Array of <b>MachinePool</b> objects.
<b>compute.architecture</b>	Determines the instruction set architecture of the machines in the pool. Currently, clusters with varied architectures are not supported. All pools must specify the same architecture. Valid values are <b>amd64</b> (the default).	String
<b>compute.hyperthreading</b>	Whether to enable or disable simultaneous multithreading, or <b>hyperthreading</b> , on compute machines. By default, simultaneous multithreading is enabled to increase the performance of your machines' cores.	<b>Enabled</b> or <b>Disabled</b>
	 <p><b>IMPORTANT</b></p> <p>If you disable simultaneous multithreading, ensure that your capacity planning accounts for the dramatically decreased machine performance.</p>	

Parameter	Description	Values
<b>compute.name</b>	Required if you use <b>compute</b> . The name of the machine pool.	<b>worker</b>
<b>compute.platform</b>	Required if you use <b>compute</b> . Use this parameter to specify the cloud provider to host the worker machines. This parameter value must match the <b>controlPlane.platform</b> parameter value.	<b>alibabacloud, aws, azure, gcp, ibmcloud, openstack, ovirt, vsphere</b> , or <b>{}</b>
<b>compute.replicas</b>	The number of compute machines, which are also known as worker machines, to provision.	A positive integer greater than or equal to <b>2</b> . The default value is <b>3</b> .
<b>controlPlane</b>	The configuration for the machines that comprise the control plane.	Array of <b>MachinePool</b> objects.
<b>controlPlane.architecture</b>	Determines the instruction set architecture of the machines in the pool. Currently, clusters with varied architectures are not supported. All pools must specify the same architecture. Valid values are <b>amd64</b> (the default).	String
<b>controlPlane.hyperthreading</b>	<p>Whether to enable or disable simultaneous multithreading, or <b>hyperthreading</b>, on control plane machines. By default, simultaneous multithreading is enabled to increase the performance of your machines' cores.</p> <div style="display: flex; align-items: center;">  <div> <p><b>IMPORTANT</b></p> <p>If you disable simultaneous multithreading, ensure that your capacity planning accounts for the dramatically decreased machine performance.</p> </div> </div>	<b>Enabled</b> or <b>Disabled</b>
<b>controlPlane.name</b>	Required if you use <b>controlPlane</b> . The name of the machine pool.	<b>master</b>

Parameter	Description	Values
<b>controlPlane.platform</b>	Required if you use <b>controlPlane</b> . Use this parameter to specify the cloud provider that hosts the control plane machines. This parameter value must match the <b>compute.platform</b> parameter value.	<b>alibabacloud, aws, azure, gcp, ibmcloud, openstack, ovirt, vsphere</b> , or {}
<b>controlPlane.replicas</b>	The number of control plane machines to provision.	The only supported value is <b>3</b> , which is the default value.
<b>credentialsMode</b>	<p>The Cloud Credential Operator (CCO) mode. If no mode is specified, the CCO dynamically tries to determine the capabilities of the provided credentials, with a preference for mint mode on the platforms where multiple modes are supported.</p> <div style="display: flex; align-items: flex-start;"> <div style="flex: 1;">  </div> <div style="flex: 2;"> <p><b>NOTE</b></p> <p>Not all CCO modes are supported for all cloud providers. For more information on CCO modes, see the <i>Cloud Credential Operator</i> entry in the <i>Cluster Operators reference</i> content.</p> </div> </div> <div style="display: flex; align-items: flex-start; margin-top: 10px;"> <div style="flex: 1;">  </div> <div style="flex: 2;"> <p><b>NOTE</b></p> <p>If your AWS account has service control policies (SCP) enabled, you must configure the <b>credentialsMode</b> parameter to <b>Mint, Passthrough</b> or <b>Manual</b>.</p> </div> </div>	<b>Mint, Passthrough, Manual</b> or an empty string ("").

Parameter	Description	Values
<p><b>fips</b></p>	<p>Enable or disable FIPS mode. The default is <b>false</b> (disabled). If FIPS mode is enabled, the Red Hat Enterprise Linux CoreOS (RHCOS) machines that OpenShift Container Platform runs on bypass the default Kubernetes cryptography suite and use the cryptography modules that are provided with RHCOS instead.</p> <div data-bbox="486 586 592 1361" style="background-color: black; color: white; padding: 5px; margin-bottom: 10px;"> <p><b>IMPORTANT</b></p> <p>To enable FIPS mode for your cluster, you must run the installation program from a Red Hat Enterprise Linux (RHEL) computer configured to operate in FIPS mode. For more information about configuring FIPS mode on RHEL, see <a href="#">Installing the system in FIPS mode</a>. The use of FIPS validated or Modules In Process cryptographic libraries is only supported on OpenShift Container Platform deployments on the <b>x86_64</b> architecture.</p> </div> <div data-bbox="486 1406 592 1608" style="background-color: #f0f0f0; padding: 5px;"> <p><b>NOTE</b></p> <p>If you are using Azure File storage, you cannot enable FIPS mode.</p> </div>	<p><b>false</b> or <b>true</b></p>

Parameter	Description	Values
<b>imageContentSources</b>	Sources and repositories for the release-image content.	Array of objects. Includes a <b>source</b> and, optionally, <b>mirrors</b> , as described in the following rows of this table.
<b>imageContentSources.source</b>	Required if you use <b>imageContentSources</b> . Specify the repository that users refer to, for example, in image pull specifications.	String
<b>imageContentSources.mirrors</b>	Specify one or more repositories that may also contain the same images.	Array of strings
<b>publish</b>	How to publish or expose the user-facing endpoints of your cluster, such as the Kubernetes API, OpenShift routes.	<p><b>Internal</b> or <b>External</b>. The default value is <b>External</b>.</p> <p>Setting this field to <b>Internal</b> is not supported on non-cloud platforms and IBM Cloud VPC.</p> <div style="display: flex; align-items: flex-start;">  <div> <p><b>IMPORTANT</b></p> <p>If the value of the field is set to <b>Internal</b>, the cluster will become non-functional. For more information, refer to <a href="#">BZ#1953035</a>.</p> </div> </div>
<b>sshKey</b>	<p>The SSH key or keys to authenticate access your cluster machines.</p> <div style="display: flex; align-items: flex-start;">  <div> <p><b>NOTE</b></p> <p>For production OpenShift Container Platform clusters on which you want to perform installation debugging or disaster recovery, specify an SSH key that your <b>ssh-agent</b> process uses.</p> </div> </div>	<p>One or more keys. For example:</p> <pre>sshKey:   &lt;key1&gt;   &lt;key2&gt;   &lt;key3&gt;</pre>

#### 9.5.6.1.4. Additional IBM Cloud VPC configuration parameters

Additional IBM Cloud VPC configuration parameters are described in the following table:

Table 9.10. Additional IBM Cloud VPC parameters

Parameter	Description	Values
<b>platform.ibmcloud.resourceGroupName</b>	The name of an existing resource group to install your cluster to. This resource group must only be used for this specific cluster because the cluster components assume ownership of all of the resources in the resource group. If undefined, a new resource group is created for the cluster. [1]	String, for example <b>existing_resource_group</b> .
<b>platform.ibmcloud.dedicatedHosts.profile</b>	The new dedicated host to create. If you specify a value for <b>platform.ibmcloud.dedicatedHosts.name</b> , this parameter is not required.	Valid IBM Cloud VPC dedicated host profile, such as <b>cx2-host-152x304</b> . [2]
<b>platform.ibmcloud.dedicatedHosts.name</b>	An existing dedicated host. If you specify a value for <b>platform.ibmcloud.dedicatedHosts.profile</b> , this parameter is not required.	String, for example <b>my-dedicated-host-name</b> .
<b>platform.ibmcloud.type</b>	The instance type for all IBM Cloud VPC machines.	Valid IBM Cloud VPC instance type, such as <b>bx2-8x32</b> . [2]

1. Whether you define an existing resource group, or if the installer creates one, determines how the resource group is treated when the cluster is uninstalled. If you define a resource group, the installer removes all of the installer-provisioned resources, but leaves the resource group alone; if a resource group is created as part of the installation, the installer removes all of the installer-provisioned resources and the resource group.
2. To determine which profile best meets your needs, see [Instance Profiles](#) in the IBM documentation.

### 9.5.6.2. Sample customized install-config.yaml file for IBM Cloud VPC

You can customize the **install-config.yaml** file to specify more details about your OpenShift Container Platform cluster's platform or modify the values of the required parameters.



#### IMPORTANT

This sample YAML file is provided for reference only. You must obtain your **install-config.yaml** file by using the installation program and modify it.

```

apiVersion: v1
baseDomain: example.com 1
controlPlane: 2 3
  hyperthreading: Enabled 4
  name: master
  platform:
    ibmcloud: {}
  replicas: 3
compute: 5 6
- hyperthreading: Enabled 7
  name: worker
  platform:
    ibmcloud: {}
  replicas: 3
metadata:
  name: test-cluster 8
networking:
networking: 9
  clusterNetwork:
  - cidr: 10.128.0.0/14
    hostPrefix: 23
  machineNetwork:
  - cidr: 10.0.0.0/16
  networkType: OpenShiftSDN
  serviceNetwork:
  - 172.30.0.0/16
platform:
  ibmcloud:
    region: us-south 10
credentialsMode: Manual
publish: External
pullSecret: '{"auths": ...}' 11
fips: false 12
sshKey: ssh-ed25519 AAAA... 13

```

1 8 10 11 Required. The installation program prompts you for this value.

2 5 9 If you do not provide these parameters and values, the installation program provides the default value.

3 6 The **controlPlane** section is a single mapping, but the **compute** section is a sequence of mappings. To meet the requirements of the different data structures, the first line of the **compute** section must begin with a hyphen, -, and the first line of the **controlPlane** section must not. Only one control plane pool is used.

4 7 Whether to enable or disable simultaneous multithreading, or **hyperthreading**. By default, simultaneous multithreading is enabled to increase the performance of your machines' cores. You can disable it by setting the parameter value to **Disabled**. If you disable simultaneous multithreading in some cluster machines, you must disable it in all cluster machines.



**IMPORTANT**

If you disable simultaneous multithreading, ensure that your capacity planning accounts for the dramatically decreased machine performance. Use larger machine types, such as **n1-standard-8**, for your machines if you disable simultaneous multithreading.

**12**

Whether to enable or disable FIPS mode. By default, FIPS mode is not enabled. If FIPS mode is enabled, the Red Hat Enterprise Linux CoreOS (RHCOS) machines that OpenShift Container Platform runs on bypass the default Kubernetes cryptography suite and use the cryptography modules that are provided with RHCOS instead.

**IMPORTANT**

To enable FIPS mode for your cluster, you must run the installation program from a Red Hat Enterprise Linux (RHEL) computer configured to operate in FIPS mode. For more information about configuring FIPS mode on RHEL, see [Installing the system in FIPS mode](#). The use of FIPS Validated or Modules in Process cryptographic libraries is only supported on OpenShift Container Platform deployments on the **x86\_64** architecture.

**13**

You can optionally provide the **sshKey** value that you use to access the machines in your cluster.

**NOTE**

For production OpenShift Container Platform clusters on which you want to perform installation debugging or disaster recovery, specify an SSH key that your **ssh-agent** process uses.

### 9.5.6.3. Configuring the cluster-wide proxy during installation

Production environments can deny direct access to the internet and instead have an HTTP or HTTPS proxy available. You can configure a new OpenShift Container Platform cluster to use a proxy by configuring the proxy settings in the **install-config.yaml** file.

#### Prerequisites

- You have an existing **install-config.yaml** file.
- You reviewed the sites that your cluster requires access to and determined whether any of them need to bypass the proxy. By default, all cluster egress traffic is proxied, including calls to hosting cloud provider APIs. You added sites to the **Proxy** object's **spec.noProxy** field to bypass the proxy if necessary.



## NOTE

The **Proxy** object **status.noProxy** field is populated with the values of the **networking.machineNetwork[].cidr**, **networking.clusterNetwork[].cidr**, and **networking.serviceNetwork[]** fields from your installation configuration.

For installations on Amazon Web Services (AWS), Google Cloud Platform (GCP), Microsoft Azure, and Red Hat OpenStack Platform (RHOSP), the **Proxy** object **status.noProxy** field is also populated with the instance metadata endpoint (**169.254.169.254**).

## Procedure

1. Edit your **install-config.yaml** file and add the proxy settings. For example:

```
apiVersion: v1
baseDomain: my.domain.com
proxy:
  httpProxy: http://<username>:<pswd>@<ip>:<port> 1
  httpsProxy: https://<username>:<pswd>@<ip>:<port> 2
  noProxy: example.com 3
  additionalTrustBundle: | 4
    -----BEGIN CERTIFICATE-----
    <MY_TRUSTED_CA_CERT>
    -----END CERTIFICATE-----
  ...
```

- 1 A proxy URL to use for creating HTTP connections outside the cluster. The URL scheme must be **http**.
- 2 A proxy URL to use for creating HTTPS connections outside the cluster.
- 3 A comma-separated list of destination domain names, IP addresses, or other network CIDRs to exclude from proxying. Preface a domain with **.** to match subdomains only. For example, **.y.com** matches **x.y.com**, but not **y.com**. Use **\*** to bypass the proxy for all destinations.
- 4 If provided, the installation program generates a config map that is named **user-ca-bundle** in the **openshift-config** namespace that contains one or more additional CA certificates that are required for proxying HTTPS connections. The Cluster Network Operator then creates a **trusted-ca-bundle** config map that merges these contents with the Red Hat Enterprise Linux CoreOS (RHCOS) trust bundle, and this config map is referenced in the **trustedCA** field of the **Proxy** object. The **additionalTrustBundle** field is required unless the proxy's identity certificate is signed by an authority from the RHCOS trust bundle.



## NOTE

The installation program does not support the proxy **readinessEndpoints** field.

**NOTE**

If the installer times out, restart and then complete the deployment by using the **wait-for** command of the installer. For example:

```
$ ./openshift-install wait-for install-complete --log-level debug
```

2. Save the file and reference it when installing OpenShift Container Platform.

The installation program creates a cluster-wide proxy that is named **cluster** that uses the proxy settings in the provided **install-config.yaml** file. If no proxy settings are provided, a **cluster Proxy** object is still created, but it will have a nil **spec**.

**NOTE**

Only the **Proxy** object named **cluster** is supported, and no additional proxies can be created.

### 9.5.7. Manually creating IAM for IBM Cloud VPC

Installing the cluster requires that the Cloud Credential Operator (CCO) operate in manual mode. While the installation program configures the CCO for manual mode, you must specify the identity and access management secrets for your cloud provider.

You can use the Cloud Credential Operator (CCO) utility (**ccoctl**) to create the required IBM Cloud VPC resources.

#### Prerequisites

- You have configured the **ccoctl** binary.
- You have an existing **install-config.yaml** file.

#### Procedure

1. Edit the **install-config.yaml** configuration file so that it contains the **credentialsMode** parameter set to **Manual**.

#### Example **install-config.yaml** configuration file

```
apiVersion: v1
baseDomain: cluster1.example.com
credentialsMode: Manual 1
compute:
- architecture: amd64
  hyperthreading: Enabled
...
```

- 1** This line is added to set the **credentialsMode** parameter to **Manual**.

2. To generate the manifests, run the following command from the directory that contains the installation program:



```
$ openshift-install create manifests --dir <installation_directory>
```

- From the directory that contains the installation program, obtain the OpenShift Container Platform release image that your **openshift-install** binary is built to use:

```
$ RELEASE_IMAGE=$(./openshift-install version | awk '/release image/ {print $3}')
```

- Extract the **CredentialsRequest** objects from the OpenShift Container Platform release image:

```
$ oc adm release extract --cloud=ibmcloud --credentials-requests $RELEASE_IMAGE \
  --to=<path_to_credential_requests_directory> 1
```

- The directory where the credential requests will be stored.

This command creates a YAML file for each **CredentialsRequest** object.

### Sample **CredentialsRequest** object

```
apiVersion: cloudcredential.openshift.io/v1
kind: CredentialsRequest
metadata:
  labels:
    controller-tools.k8s.io: "1.0"
  name: openshift-image-registry-ibmcos
  namespace: openshift-cloud-credential-operator
spec:
  secretRef:
    name: installer-cloud-credentials
    namespace: openshift-image-registry
  providerSpec:
    apiVersion: cloudcredential.openshift.io/v1
    kind: IBMCloudProviderSpec
    policies:
      - attributes:
          - name: serviceName
            value: cloud-object-storage
        roles:
          - crn:v1:bluemix:public:iam::::role:Viewer
          - crn:v1:bluemix:public:iam::::role:Operator
          - crn:v1:bluemix:public:iam::::role:Editor
          - crn:v1:bluemix:public:iam::::serviceRole:Reader
          - crn:v1:bluemix:public:iam::::serviceRole:Writer
      - attributes:
          - name: resourceType
            value: resource-group
        roles:
          - crn:v1:bluemix:public:iam::::role:Viewer
```

- Create the service ID for each credential request, assign the policies defined, create an API key in IBM Cloud VPC, and generate the secret:

```
$ ccoctl ibmcloud create-service-id \
  --credentials-requests-dir <path_to_store_credential_request_templates> \ 1
```

```
--name <cluster_name> \ 2
--output-dir <installation_directory> \
--resource-group-name <resource_group_name> 3
```

- 1 The directory where the credential requests are stored.
- 2 The name of the OpenShift Container Platform cluster.
- 3 Optional: The name of the resource group used for scoping the access policies.



#### NOTE

If your cluster uses Technology Preview features that are enabled by the **TechPreviewNoUpgrade** feature set, you must include the **--enable-tech-preview** parameter.

If an incorrect resource group name is provided, the installation fails during the bootstrap phase. To find the correct resource group name, run the following command:

```
$ grep resourceGroupName <installation_directory>/manifests/cluster-
infrastructure-02-config.yml
```

#### Verification

- Ensure that the appropriate secrets were generated in your cluster's **manifests** directory.

### 9.5.8. Network configuration phases

There are two phases prior to OpenShift Container Platform installation where you can customize the network configuration.

#### Phase 1

You can customize the following network-related fields in the **install-config.yaml** file before you create the manifest files:

- **networking.networkType**
- **networking.clusterNetwork**
- **networking.serviceNetwork**
- **networking.machineNetwork**

For more information on these fields, refer to *Installation configuration parameters*.

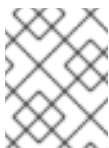

#### NOTE

Set the **networking.machineNetwork** to match the CIDR that the preferred NIC resides in.

**IMPORTANT**

The CIDR range **172.17.0.0/16** is reserved by libVirt. You cannot use this range or any range that overlaps with this range for any networks in your cluster.

**Phase 2**

After creating the manifest files by running **openshift-install create manifests**, you can define a customized Cluster Network Operator manifest with only the fields you want to modify. You can use the manifest to specify advanced network configuration.

You cannot override the values specified in phase 1 in the **install-config.yaml** file during phase 2. However, you can further customize the cluster network provider during phase 2.

**9.5.9. Specifying advanced network configuration**

You can use advanced network configuration for your cluster network provider to integrate your cluster into your existing network environment. You can specify advanced network configuration only before you install the cluster.

**IMPORTANT**

Customizing your network configuration by modifying the OpenShift Container Platform manifest files created by the installation program is not supported. Applying a manifest file that you create, as in the following procedure, is supported.

**Prerequisites**

- You have created the **install-config.yaml** file and completed any modifications to it.

**Procedure**

1. Change to the directory that contains the installation program and create the manifests:

```
$ ./openshift-install create manifests --dir <installation_directory> 1
```

- 1 **<installation\_directory>** specifies the name of the directory that contains the **install-config.yaml** file for your cluster.

2. Create a stub manifest file for the advanced network configuration that is named **cluster-network-03-config.yml** in the **<installation\_directory>/manifests/** directory:

```
apiVersion: operator.openshift.io/v1
kind: Network
metadata:
  name: cluster
spec:
```

3. Specify the advanced network configuration for your cluster in the **cluster-network-03-config.yml** file, such as in the following example:

**Specify a different VXLAN port for the OpenShift SDN network provider**

```

apiVersion: operator.openshift.io/v1
kind: Network
metadata:
  name: cluster
spec:
  defaultNetwork:
    openshiftSDNConfig:
      vxlanPort: 4800

```

- Optional: Back up the **manifests/cluster-network-03-config.yml** file. The installation program consumes the **manifests/** directory when you create the Ignition config files.

### 9.5.10. Cluster Network Operator configuration

The configuration for the cluster network is specified as part of the Cluster Network Operator (CNO) configuration and stored in a custom resource (CR) object that is named **cluster**. The CR specifies the fields for the **Network** API in the **operator.openshift.io** API group.

The CNO configuration inherits the following fields during cluster installation from the **Network** API in the **Network.config.openshift.io** API group and these fields cannot be changed:

#### **clusterNetwork**

IP address pools from which pod IP addresses are allocated.

#### **serviceNetwork**

IP address pool for services.

#### **defaultNetwork.type**

Cluster network provider, such as OpenShift SDN or OVN-Kubernetes.

You can specify the cluster network provider configuration for your cluster by setting the fields for the **defaultNetwork** object in the CNO object named **cluster**.

#### 9.5.10.1. Cluster Network Operator configuration object

The fields for the Cluster Network Operator (CNO) are described in the following table:

**Table 9.11. Cluster Network Operator configuration object**

Field	Type	Description
<b>metadata.name</b>	<b>string</b>	The name of the CNO object. This name is always <b>cluster</b> .

Field	Type	Description
<b>spec.clusterNetwork</b>	<b>array</b>	<p>A list specifying the blocks of IP addresses from which pod IP addresses are allocated and the subnet prefix length assigned to each individual node in the cluster. For example:</p> <pre>spec:   clusterNetwork:   - cidr: 10.128.0.0/19     hostPrefix: 23   - cidr: 10.128.32.0/19     hostPrefix: 23</pre> <p>You can customize this field only in the <b>install-config.yaml</b> file before you create the manifests. The value is read-only in the manifest file.</p>
<b>spec.serviceNetwork</b>	<b>array</b>	<p>A block of IP addresses for services. The OpenShift SDN and OVN-Kubernetes Container Network Interface (CNI) network providers support only a single IP address block for the service network. For example:</p> <pre>spec:   serviceNetwork:   - 172.30.0.0/14</pre> <p>You can customize this field only in the <b>install-config.yaml</b> file before you create the manifests. The value is read-only in the manifest file.</p>
<b>spec.defaultNetwork</b>	<b>object</b>	Configures the Container Network Interface (CNI) cluster network provider for the cluster network.
<b>spec.kubeProxyConfig</b>	<b>object</b>	The fields for this object specify the kube-proxy configuration. If you are using the OVN-Kubernetes cluster network provider, the kube-proxy configuration has no effect.

### defaultNetwork object configuration

The values for the **defaultNetwork** object are defined in the following table:

Table 9.12. **defaultNetwork** object

Field	Type	Description
-------	------	-------------



Field	Type	Description
<b>type</b>	<b>string</b>	<p>Either <b>OpenShiftSDN</b> or <b>OVNKubernetes</b>. The cluster network provider is selected during installation. This value cannot be changed after cluster installation.</p> <div style="display: flex; align-items: flex-start;"> <div style="flex: 1;">  </div> <div style="flex: 2;"> <p><b>NOTE</b></p> <p>OpenShift Container Platform uses the OpenShift SDN Container Network Interface (CNI) cluster network provider by default.</p> </div> </div>
<b>openshiftSDNConfig</b>	<b>object</b>	This object is only valid for the OpenShift SDN cluster network provider.
<b>ovnKubernetesConfig</b>	<b>object</b>	This object is only valid for the OVN-Kubernetes cluster network provider.

#### Configuration for the OpenShift SDN CNI cluster network provider

The following table describes the configuration fields for the OpenShift SDN Container Network Interface (CNI) cluster network provider.

Table 9.13. **openshiftSDNConfig** object

Field	Type	Description
<b>mode</b>	<b>string</b>	<p>Configures the network isolation mode for OpenShift SDN. The default value is <b>NetworkPolicy</b>.</p> <p>The values <b>Multitenant</b> and <b>Subnet</b> are available for backwards compatibility with OpenShift Container Platform 3.x but are not recommended. This value cannot be changed after cluster installation.</p>

Field	Type	Description
<b>mtu</b>	<b>integer</b>	<p>The maximum transmission unit (MTU) for the VXLAN overlay network. This is detected automatically based on the MTU of the primary network interface. You do not normally need to override the detected MTU.</p> <p>If the auto-detected value is not what you expect it to be, confirm that the MTU on the primary network interface on your nodes is correct. You cannot use this option to change the MTU value of the primary network interface on the nodes.</p> <p>If your cluster requires different MTU values for different nodes, you must set this value to <b>50</b> less than the lowest MTU value in your cluster. For example, if some nodes in your cluster have an MTU of <b>9001</b>, and some have an MTU of <b>1500</b>, you must set this value to <b>1450</b>.</p> <p>This value cannot be changed after cluster installation.</p>
<b>vxlanPort</b>	<b>integer</b>	<p>The port to use for all VXLAN packets. The default value is <b>4789</b>. This value cannot be changed after cluster installation.</p> <p>If you are running in a virtualized environment with existing nodes that are part of another VXLAN network, then you might be required to change this. For example, when running an OpenShift SDN overlay on top of VMware NSX-T, you must select an alternate port for the VXLAN, because both SDNs use the same default VXLAN port number.</p> <p>On Amazon Web Services (AWS), you can select an alternate port for the VXLAN between port <b>9000</b> and port <b>9999</b>.</p>

## Example OpenShift SDN configuration

```
defaultNetwork:
  type: OpenShiftSDN
  openshiftSDNConfig:
    mode: NetworkPolicy
    mtu: 1450
    vxlanPort: 4789
```

## Configuration for the OVN-Kubernetes CNI cluster network provider

The following table describes the configuration fields for the OVN-Kubernetes CNI cluster network provider.

Table 9.14. `ovnKubernetesConfig` object

Field	Type	Description
-------	------	-------------

Field	Type	Description
<b>mtu</b>	<b>integer</b>	<p>The maximum transmission unit (MTU) for the Geneve (Generic Network Virtualization Encapsulation) overlay network. This is detected automatically based on the MTU of the primary network interface. You do not normally need to override the detected MTU.</p> <p>If the auto-detected value is not what you expect it to be, confirm that the MTU on the primary network interface on your nodes is correct. You cannot use this option to change the MTU value of the primary network interface on the nodes.</p> <p>If your cluster requires different MTU values for different nodes, you must set this value to <b>100</b> less than the lowest MTU value in your cluster. For example, if some nodes in your cluster have an MTU of <b>9001</b>, and some have an MTU of <b>1500</b>, you must set this value to <b>1400</b>.</p>
<b>genevePort</b>	<b>integer</b>	The port to use for all Geneve packets. The default value is <b>6081</b> . This value cannot be changed after cluster installation.
<b>policyAuditConfig</b>	<b>object</b>	Specify a configuration object for customizing network policy audit logging. If unset, the defaults audit log settings are used.
<b>gatewayConfig</b>	<b>object</b>	<p>Optional: Specify a configuration object for customizing how egress traffic is sent to the node gateway.</p> <div style="display: flex; align-items: flex-start;">  <div> <p><b>NOTE</b></p> <p>While migrating egress traffic, you can expect some disruption to workloads and service traffic until the Cluster Network Operator (CNO) successfully rolls out the changes.</p> </div> </div>

**NOTE**

IPsec for the OVN-Kubernetes network provider is not supported when installing a cluster on IBM Cloud.

Table 9.15. **policyAuditConfig** object

Field	Type	Description
<b>rateLimit</b>	<b>integer</b>	The maximum number of messages to generate every second per node. The default value is <b>20</b> messages per second.

Field	Type	Description
<b>maxFileSize</b>	integer	The maximum size for the audit log in bytes. The default value is <b>50000000</b> or 50 MB.
<b>destination</b>	string	One of the following additional audit log targets:  <b>libc</b> The libc <b>syslog()</b> function of the journald process on the host. <b>udp:&lt;host&gt;:&lt;port&gt;</b> A syslog server. Replace <b>&lt;host&gt;:&lt;port&gt;</b> with the host and port of the syslog server. <b>unix:&lt;file&gt;</b> A Unix Domain Socket file specified by <b>&lt;file&gt;</b> . <b>null</b> Do not send the audit logs to any additional target.
<b>syslogFacility</b>	string	The syslog facility, such as <b>kern</b> , as defined by RFC5424. The default value is <b>local0</b> .

Table 9.16. gatewayConfig object

Field	Type	Description
<b>routingViaHost</b>	<b>boolean</b>	Set this field to <b>true</b> to send egress traffic from pods to the host networking stack. For highly-specialized installations and applications that rely on manually configured routes in the kernel routing table, you might want to route egress traffic to the host networking stack. By default, egress traffic is processed in OVN to exit the cluster and is not affected by specialized routes in the kernel routing table. The default value is <b>false</b> .  This field has an interaction with the Open vSwitch hardware offloading feature. If you set this field to <b>true</b> , you do not receive the performance benefits of the offloading because egress traffic is processed by the host networking stack.

### Example OVN-Kubernetes configuration with IPsec enabled

```
defaultNetwork:
  type: OVNKubernetes
  ovnKubernetesConfig:
    mtu: 1400
    genevePort: 6081
```

### kubeProxyConfig object configuration

The values for the **kubeProxyConfig** object are defined in the following table:

Table 9.17. kubeProxyConfig object

Field	Type	Description
<b>iptablesSyncPeriod</b>	<b>string</b>	<p>The refresh period for <b>iptables</b> rules. The default value is <b>30s</b>. Valid suffixes include <b>s</b>, <b>m</b>, and <b>h</b> and are described in the <a href="#">Go time package</a> documentation.</p> <div style="display: flex; align-items: flex-start;"> <div style="flex: 1;">  </div> <div style="flex: 2;"> <p><b>NOTE</b></p> <p>Because of performance improvements introduced in OpenShift Container Platform 4.3 and greater, adjusting the <b>iptablesSyncPeriod</b> parameter is no longer necessary.</p> </div> </div>
<b>proxyArguments.iptables-min-sync-period</b>	<b>array</b>	<p>The minimum duration before refreshing <b>iptables</b> rules. This field ensures that the refresh does not happen too frequently. Valid suffixes include <b>s</b>, <b>m</b>, and <b>h</b> and are described in the <a href="#">Go time package</a>. The default value is:</p> <pre>kubeProxyConfig:   proxyArguments:     iptables-min-sync-period:       - 0s</pre>

### 9.5.11. Deploying the cluster

You can install OpenShift Container Platform on a compatible cloud platform.

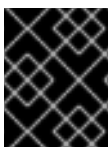

#### IMPORTANT

You can run the **create cluster** command of the installation program only once, during initial installation.

#### Prerequisites

- Configure an account with the cloud platform that hosts your cluster.
- Obtain the OpenShift Container Platform installation program and the pull secret for your cluster.

#### Procedure

1. Change to the directory that contains the installation program and initialize the cluster deployment:

```
$ ./openshift-install create cluster --dir <installation_directory> \ 1
--log-level=info 2
```

- 1 For `<installation_directory>`, specify the location of your customized `./install-config.yaml` file.
- 2 To view different installation details, specify **warn**, **debug**, or **error** instead of **info**.



#### NOTE

If the cloud provider account that you configured on your host does not have sufficient permissions to deploy the cluster, the installation process stops, and the missing permissions are displayed.

When the cluster deployment completes, directions for accessing your cluster, including a link to its web console and credentials for the **kubeadmin** user, display in your terminal.

#### Example output

```
...
INFO Install complete!
INFO To access the cluster as the system:admin user when using 'oc', run 'export
KUBECONFIG=/home/myuser/install_dir/auth/kubeconfig'
INFO Access the OpenShift web-console here: https://console-openshift-
console.apps.mycluster.example.com
INFO Login to the console with user: "kubeadmin", and password: "4vYBz-Ee6gm-ymBZj-
Wt5AL"
INFO Time elapsed: 36m22s
```



#### NOTE

The cluster access and credential information also outputs to `<installation_directory>/openshift_install.log` when an installation succeeds.



#### IMPORTANT

- The Ignition config files that the installation program generates contain certificates that expire after 24 hours, which are then renewed at that time. If the cluster is shut down before renewing the certificates and the cluster is later restarted after the 24 hours have elapsed, the cluster automatically recovers the expired certificates. The exception is that you must manually approve the pending **node-bootstrapper** certificate signing requests (CSRs) to recover kubelet certificates. See the documentation for *Recovering from expired control plane certificates* for more information.
- It is recommended that you use Ignition config files within 12 hours after they are generated because the 24-hour certificate rotates from 16 to 22 hours after the cluster is installed. By using the Ignition config files within 12 hours, you can avoid installation failure if the certificate update runs during installation.



#### IMPORTANT

You must not delete the installation program or the files that the installation program creates. Both are required to delete the cluster.

## 9.5.12. Installing the OpenShift CLI by downloading the binary

You can install the OpenShift CLI (**oc**) to interact with OpenShift Container Platform from a command-line interface. You can install **oc** on Linux, Windows, or macOS.



### IMPORTANT

If you installed an earlier version of **oc**, you cannot use it to complete all of the commands in OpenShift Container Platform 4.10. Download and install the new version of **oc**.

### Installing the OpenShift CLI on Linux

You can install the OpenShift CLI (**oc**) binary on Linux by using the following procedure.

#### Procedure

1. Navigate to the [OpenShift Container Platform downloads page](#) on the Red Hat Customer Portal.
2. Select the appropriate version in the **Version** drop-down menu.
3. Click **Download Now** next to the **OpenShift v4.10 Linux Client** entry and save the file.
4. Unpack the archive:

```
$ tar xvf <file>
```

5. Place the **oc** binary in a directory that is on your **PATH**.  
To check your **PATH**, execute the following command:

```
$ echo $PATH
```

After you install the OpenShift CLI, it is available using the **oc** command:

```
$ oc <command>
```

### Installing the OpenShift CLI on Windows

You can install the OpenShift CLI (**oc**) binary on Windows by using the following procedure.

#### Procedure

1. Navigate to the [OpenShift Container Platform downloads page](#) on the Red Hat Customer Portal.
2. Select the appropriate version in the **Version** drop-down menu.
3. Click **Download Now** next to the **OpenShift v4.10 Windows Client** entry and save the file.
4. Unzip the archive with a ZIP program.
5. Move the **oc** binary to a directory that is on your **PATH**.  
To check your **PATH**, open the command prompt and execute the following command:

```
C:\> path
```

After you install the OpenShift CLI, it is available using the **oc** command:

```
C:\> oc <command>
```

### Installing the OpenShift CLI on macOS

You can install the OpenShift CLI (**oc**) binary on macOS by using the following procedure.

#### Procedure

1. Navigate to the [OpenShift Container Platform downloads page](#) on the Red Hat Customer Portal.
2. Select the appropriate version in the **Version** drop-down menu.
3. Click **Download Now** next to the **OpenShift v4.10 MacOSX Client** entry and save the file.
4. Unpack and unzip the archive.
5. Move the **oc** binary to a directory on your PATH.  
To check your **PATH**, open a terminal and execute the following command:

```
$ echo $PATH
```

After you install the OpenShift CLI, it is available using the **oc** command:

```
$ oc <command>
```

### 9.5.13. Logging in to the cluster by using the CLI

You can log in to your cluster as a default system user by exporting the cluster **kubeconfig** file. The **kubeconfig** file contains information about the cluster that is used by the CLI to connect a client to the correct cluster and API server. The file is specific to a cluster and is created during OpenShift Container Platform installation.

#### Prerequisites

- You deployed an OpenShift Container Platform cluster.
- You installed the **oc** CLI.

#### Procedure

1. Export the **kubeadmin** credentials:

```
$ export KUBECONFIG=<installation_directory>/auth/kubeconfig 1
```

- 1** For **<installation\_directory>**, specify the path to the directory that you stored the installation files in.

2. Verify you can run **oc** commands successfully using the exported configuration:

```
$ oc whoami
```



## Example output

```
system:admin
```

### Additional resources

- [Accessing the web console](#)

## 9.5.14. Telemetry access for OpenShift Container Platform

In OpenShift Container Platform 4.10, the Telemetry service, which runs by default to provide metrics about cluster health and the success of updates, requires internet access. If your cluster is connected to the internet, Telemetry runs automatically, and your cluster is registered to [OpenShift Cluster Manager](#).

After you confirm that your [OpenShift Cluster Manager](#) inventory is correct, either maintained automatically by Telemetry or manually by using OpenShift Cluster Manager, [use subscription watch](#) to track your OpenShift Container Platform subscriptions at the account or multi-cluster level.

### Additional resources

- [About remote health monitoring](#)

## 9.5.15. Next steps

- [Customize your cluster.](#)
- If necessary, you can [opt out of remote health reporting](#).

## 9.6. UNINSTALLING A CLUSTER ON IBM CLOUD VPC

You can remove a cluster that you deployed to IBM Cloud VPC.

### 9.6.1. Removing a cluster that uses installer-provisioned infrastructure

You can remove a cluster that uses installer-provisioned infrastructure from your cloud.



#### NOTE

After uninstallation, check your cloud provider for any resources not removed properly, especially with User Provisioned Infrastructure (UPI) clusters. There might be resources that the installer did not create or that the installer is unable to access.

### Prerequisites

- Have a copy of the installation program that you used to deploy the cluster.
- Have the files that the installation program generated when you created your cluster.
- You have configured the **ccoctl** binary.
- You have installed the IBM Cloud CLI and installed or updated the VPC infrastructure service plugin. For more information see "Prerequisites" in the [IBM Cloud VPC CLI documentation](#).

## Procedure

- If the following conditions are met, this step is required:
  - The installer created a resource group as part of the installation process.
  - You or one of your applications created persistent volume claims (PVCs) after the cluster was deployed.

In which case, the PVCs are not removed when uninstalling the cluster, which might prevent the resource group from being successfully removed. To prevent a failure:

- Log in to the IBM Cloud using the CLI.
- To list the PVCs, run the following command:

```
$ ibmcloud is volumes --resource-group-name <infrastructure_id>
```

For more information about listing volumes, see the [IBM Cloud VPC CLI documentation](#).

- To delete the PVCs, run the following command:

```
$ ibmcloud is volume-delete --force <volume_id>
```

For more information about deleting volumes, see the [IBM Cloud VPC CLI documentation](#).

- Export the IBM Cloud API key that was created as part of the installation process.

```
$ export IC_API_KEY=<api_key>
```



### NOTE

You must set the variable name exactly as specified. The installation program expects the variable name to be present to remove the service IDs that were created when the cluster was installed.

- From the directory that contains the installation program on the computer that you used to install the cluster, run the following command:

```
$ ./openshift-install destroy cluster \  
--dir <installation_directory> --log-level info 1 2
```

- For **<installation\_directory>**, specify the path to the directory that you stored the installation files in.

- To view different details, specify **warn**, **debug**, or **error** instead of **info**.

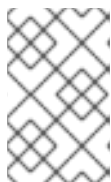

### NOTE

You must specify the directory that contains the cluster definition files for your cluster. The installation program requires the **metadata.json** file in this directory to delete the cluster.

4. Remove the manual CCO credentials that were created for the cluster:

```
$ ccoctl ibmcloud delete-service-id \  
  --credentials-requests-dir <path_to_credential_requests_directory> \  
  --name <cluster_name>
```



#### NOTE

If your cluster uses Technology Preview features that are enabled by the **TechPreviewNoUpgrade** feature set, you must include the **--enable-tech-preview** parameter.

5. Optional: Delete the **<installation\_directory>** directory and the OpenShift Container Platform installation program.

## CHAPTER 10. INSTALLING ON BARE METAL

### 10.1. PREPARING FOR BARE METAL CLUSTER INSTALLATION

#### 10.1.1. Prerequisites

- You reviewed details about the [OpenShift Container Platform installation and update](#) processes.
- You have read the documentation on [selecting a cluster installation method and preparing it for users](#).

#### 10.1.2. Planning a bare metal cluster for OpenShift Virtualization

If you will use OpenShift Virtualization, it is important to be aware of several requirements before you install your bare metal cluster.

- If you want to use live migration features, you must have multiple worker nodes *at the time of cluster installation*. This is because live migration requires the cluster-level high availability (HA) flag to be set to true. The HA flag is set when a cluster is installed and cannot be changed afterwards. If there are fewer than two worker nodes defined when you install your cluster, the HA flag is set to false for the life of the cluster.



#### NOTE

You can install OpenShift Virtualization on a single-node cluster, but single-node OpenShift does not support high availability.

- Live migration requires shared storage. Storage for OpenShift Virtualization must support and use the ReadWriteMany (RWX) access mode.
- If you plan to use Single Root I/O Virtualization (SR-IOV), ensure that your network interface controllers (NICs) are supported by OpenShift Container Platform.

#### Additional resources

- [Preparing your cluster for OpenShift Virtualization](#)
- [About Single Root I/O Virtualization \(SR-IOV\) hardware networks](#)
- [Connecting a virtual machine to an SR-IOV network](#)

#### 10.1.3. Choosing a method to install OpenShift Container Platform on bare metal

You can install OpenShift Container Platform on installer-provisioned or user-provisioned infrastructure. The default installation type uses installer-provisioned infrastructure, where the installation program provisions the underlying infrastructure for the cluster. You can also install OpenShift Container Platform on infrastructure that you provision. If you do not use infrastructure that the installation program provisions, you must manage and maintain the cluster resources yourself.

See [Installation process](#) for more information about installer-provisioned and user-provisioned installation processes.

### 10.1.3.1. Installing a cluster on installer-provisioned infrastructure

You can install a cluster on bare metal infrastructure that is provisioned by the OpenShift Container Platform installation program, by using the following method:

- **Installing an installer-provisioned cluster on bare metal** You can install OpenShift Container Platform on bare metal by using installer provisioning.

### 10.1.3.2. Installing a cluster on user-provisioned infrastructure

You can install a cluster on bare metal infrastructure that you provision, by using one of the following methods:

- **Installing a user-provisioned cluster on bare metal** You can install OpenShift Container Platform on bare metal infrastructure that you provision. For a cluster that contains user-provisioned infrastructure, you must deploy all of the required machines.
- **Installing a user-provisioned bare metal cluster with network customizations** You can install a bare metal cluster on user-provisioned infrastructure with network-customizations. By customizing your network configuration, your cluster can coexist with existing IP address allocations in your environment and integrate with existing MTU and VXLAN configurations. Most of the network customizations must be applied at the installation stage.
- **Installing a user-provisioned bare metal cluster on a restricted network** You can install a user-provisioned bare metal cluster on a restricted or disconnected network by using a mirror registry. You can also use this installation method to ensure that your clusters only use container images that satisfy your organizational controls on external content.

## 10.2. INSTALLING A USER-PROVISIONED CLUSTER ON BARE METAL

In OpenShift Container Platform 4.10, you can install a cluster on bare metal infrastructure that you provision.



### IMPORTANT

While you might be able to follow this procedure to deploy a cluster on virtualized or cloud environments, you must be aware of additional considerations for non-bare metal platforms. Review the information in the [guidelines for deploying OpenShift Container Platform on non-tested platforms](#) before you attempt to install an OpenShift Container Platform cluster in such an environment.

### 10.2.1. Prerequisites

- You reviewed details about the [OpenShift Container Platform installation and update](#) processes.
- You read the documentation on [selecting a cluster installation method and preparing it for users](#).
- If you use a firewall, you [configured it to allow the sites](#) that your cluster requires access to.



### NOTE

Be sure to also review this site list if you are configuring a proxy.

## 10.2.2. Internet access for OpenShift Container Platform

In OpenShift Container Platform 4.10, you require access to the internet to install your cluster.

You must have internet access to:

- Access [OpenShift Cluster Manager](#) to download the installation program and perform subscription management. If the cluster has internet access and you do not disable Telemetry, that service automatically entitles your cluster.
- Access [Quay.io](#) to obtain the packages that are required to install your cluster.
- Obtain the packages that are required to perform cluster updates.

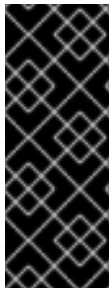

### IMPORTANT

If your cluster cannot have direct internet access, you can perform a restricted network installation on some types of infrastructure that you provision. During that process, you download the required content and use it to populate a mirror registry with the installation packages. With some installation types, the environment that you install your cluster in will not require internet access. Before you update the cluster, you update the content of the mirror registry.

### Additional resources

- See [Installing a user-provisioned bare metal cluster on a restricted network](#) for more information about performing a restricted network installation on bare metal infrastructure that you provision.

## 10.2.3. Requirements for a cluster with user-provisioned infrastructure

For a cluster that contains user-provisioned infrastructure, you must deploy all of the required machines.

This section describes the requirements for deploying OpenShift Container Platform on user-provisioned infrastructure.

### 10.2.3.1. Required machines for cluster installation

The smallest OpenShift Container Platform clusters require the following hosts:

**Table 10.1. Minimum required hosts**

Hosts	Description
One temporary bootstrap machine	The cluster requires the bootstrap machine to deploy the OpenShift Container Platform cluster on the three control plane machines. You can remove the bootstrap machine after you install the cluster.
Three control plane machines	The control plane machines run the Kubernetes and OpenShift Container Platform services that form the control plane.

Hosts	Description
At least two compute machines, which are also known as worker machines.	The workloads requested by OpenShift Container Platform users run on the compute machines.

**NOTE**

As an exception, you can run zero compute machines in a bare metal cluster that consists of three control plane machines only. This provides smaller, more resource efficient clusters for cluster administrators and developers to use for testing, development, and production. Running one compute machine is not supported.

**IMPORTANT**

To maintain high availability of your cluster, use separate physical hosts for these cluster machines.

The bootstrap and control plane machines must use Red Hat Enterprise Linux CoreOS (RHCOS) as the operating system. However, the compute machines can choose between Red Hat Enterprise Linux CoreOS (RHCOS), Red Hat Enterprise Linux (RHEL) 8.4, or RHEL 8.5.

Note that RHCOS is based on Red Hat Enterprise Linux (RHEL) 8 and inherits all of its hardware certifications and requirements. See [Red Hat Enterprise Linux technology capabilities and limits](#) .

### 10.2.3.2. Minimum resource requirements for cluster installation

Each cluster machine must meet the following minimum requirements:

**Table 10.2. Minimum resource requirements**

Machine	Operating System	CPU [1]	RAM	Storage	IOPS [2]
Bootstrap	RHCOS	4	16 GB	100 GB	300
Control plane	RHCOS	4	16 GB	100 GB	300
Compute	RHCOS, RHEL 8.4, or RHEL 8.5 [3]	2	8 GB	100 GB	300

1. One CPU is equivalent to one physical core when simultaneous multithreading (SMT), or hyperthreading, is not enabled. When enabled, use the following formula to calculate the corresponding ratio: (threads per core × cores) × sockets = CPUs.
2. OpenShift Container Platform and Kubernetes are sensitive to disk performance, and faster storage is recommended, particularly for etcd on the control plane nodes which require a 10 ms p99 fsync duration. Note that on many cloud platforms, storage size and IOPS scale together, so you might need to over-allocate storage volume to obtain sufficient performance.
3. As with all user-provisioned installations, if you choose to use RHEL compute machines in your

cluster, you take responsibility for all operating system life cycle management and maintenance, including performing system updates, applying patches, and completing all other required tasks. Use of RHEL 7 compute machines is deprecated and has been removed in OpenShift Container Platform 4.10 and later.

If an instance type for your platform meets the minimum requirements for cluster machines, it is supported to use in OpenShift Container Platform.

### 10.2.3.3. Certificate signing requests management

Because your cluster has limited access to automatic machine management when you use infrastructure that you provision, you must provide a mechanism for approving cluster certificate signing requests (CSRs) after installation. The **kube-controller-manager** only approves the kubelet client CSRs. The **machine-approver** cannot guarantee the validity of a serving certificate that is requested by using kubelet credentials because it cannot confirm that the correct machine issued the request. You must determine and implement a method of verifying the validity of the kubelet serving certificate requests and approving them.

#### Additional resources

- See [Configuring a three-node cluster](#) for details about deploying three-node clusters in bare metal environments.
- See [Approving the certificate signing requests for your machines](#) for more information about approving cluster certificate signing requests after installation.

### 10.2.3.4. Networking requirements for user-provisioned infrastructure

All the Red Hat Enterprise Linux CoreOS (RHCOS) machines require networking to be configured in **initramfs** during boot to fetch their Ignition config files.

During the initial boot, the machines require an IP address configuration that is set either through a DHCP server or statically by providing the required boot options. After a network connection is established, the machines download their Ignition config files from an HTTP or HTTPS server. The Ignition config files are then used to set the exact state of each machine. The Machine Config Operator completes more changes to the machines, such as the application of new certificates or keys, after installation.

It is recommended to use a DHCP server for long-term management of the cluster machines. Ensure that the DHCP server is configured to provide persistent IP addresses, DNS server information, and hostnames to the cluster machines.

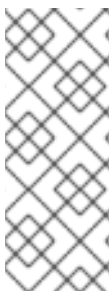

#### NOTE

If a DHCP service is not available for your user-provisioned infrastructure, you can instead provide the IP networking configuration and the address of the DNS server to the nodes at RHCOS install time. These can be passed as boot arguments if you are installing from an ISO image. See the *Installing RHCOS and starting the OpenShift Container Platform bootstrap process* section for more information about static IP provisioning and advanced networking options.

The Kubernetes API server must be able to resolve the node names of the cluster machines. If the API servers and worker nodes are in different zones, you can configure a default DNS search zone to allow the API server to resolve the node names. Another supported approach is to always refer to hosts by their fully-qualified domain names in both the node objects and all DNS requests.



### 10.2.3.4.1. Setting the cluster node hostnames through DHCP

On Red Hat Enterprise Linux CoreOS (RHCOS) machines, the hostname is set through NetworkManager. By default, the machines obtain their hostname through DHCP. If the hostname is not provided by DHCP, set statically through kernel arguments, or another method, it is obtained through a reverse DNS lookup. Reverse DNS lookup occurs after the network has been initialized on a node and can take time to resolve. Other system services can start prior to this and detect the hostname as **localhost** or similar. You can avoid this by using DHCP to provide the hostname for each cluster node.

Additionally, setting the hostnames through DHCP can bypass any manual DNS record name configuration errors in environments that have a DNS split-horizon implementation.

### 10.2.3.4.2. Network connectivity requirements

You must configure the network connectivity between machines to allow OpenShift Container Platform cluster components to communicate. Each machine must be able to resolve the hostnames of all other machines in the cluster.

This section provides details about the ports that are required.

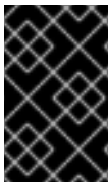

#### IMPORTANT

In connected OpenShift Container Platform environments, all nodes are required to have internet access to pull images for platform containers and provide telemetry data to Red Hat.

**Table 10.3. Ports used for all-machine to all-machine communications**

Protocol	Port	Description
ICMP	N/A	Network reachability tests
TCP	<b>1936</b>	Metrics
	<b>9000-9999</b>	Host level services, including the node exporter on ports <b>9100-9101</b> and the Cluster Version Operator on port <b>9099</b> .
	<b>10250-10259</b>	The default ports that Kubernetes reserves
	<b>10256</b>	openshift-sdn
UDP	<b>4789</b>	VXLAN
	<b>6081</b>	Geneve
	<b>9000-9999</b>	Host level services, including the node exporter on ports <b>9100-9101</b> .
	<b>500</b>	IPsec IKE packets
	<b>4500</b>	IPsec NAT-T packets

Protocol	Port	Description
TCP/UDP	<b>30000-32767</b>	Kubernetes node port
ESP	N/A	IPsec Encapsulating Security Payload (ESP)

Table 10.4. Ports used for all-machine to control plane communications

Protocol	Port	Description
TCP	<b>6443</b>	Kubernetes API

Table 10.5. Ports used for control plane machine to control plane machine communications

Protocol	Port	Description
TCP	<b>2379-2380</b>	etcd server and peer ports

### NTP configuration for user-provisioned infrastructure

OpenShift Container Platform clusters are configured to use a public Network Time Protocol (NTP) server by default. If you want to use a local enterprise NTP server, or if your cluster is being deployed in a disconnected network, you can configure the cluster to use a specific time server. For more information, see the documentation for *Configuring chrony time service*.

If a DHCP server provides NTP server information, the chrony time service on the Red Hat Enterprise Linux CoreOS (RHCOS) machines read the information and can sync the clock with the NTP servers.

### Additional resources

- [Configuring chrony time service](#)

### 10.2.3.5. User-provisioned DNS requirements

In OpenShift Container Platform deployments, DNS name resolution is required for the following components:

- The Kubernetes API
- The OpenShift Container Platform application wildcard
- The bootstrap, control plane, and compute machines

Reverse DNS resolution is also required for the Kubernetes API, the bootstrap machine, the control plane machines, and the compute machines.

DNS A/AAAA or CNAME records are used for name resolution and PTR records are used for reverse name resolution. The reverse records are important because Red Hat Enterprise Linux CoreOS (RHCOS) uses the reverse records to set the hostnames for all the nodes, unless the hostnames are provided by DHCP. Additionally, the reverse records are used to generate the certificate signing requests (CSR) that OpenShift Container Platform needs to operate.

**NOTE**

It is recommended to use a DHCP server to provide the hostnames to each cluster node. See the *DHCP recommendations for user-provisioned infrastructure* section for more information.

The following DNS records are required for a user-provisioned OpenShift Container Platform cluster and they must be in place before installation. In each record, **<cluster\_name>** is the cluster name and **<base\_domain>** is the base domain that you specify in the **install-config.yaml** file. A complete DNS record takes the form: **<component>.<cluster\_name>.<base\_domain>.**

**Table 10.6. Required DNS records**

Component	Record	Description
Kubernetes API	<b>api.&lt;cluster_name&gt;.&lt;base_domain&gt;.</b>	A DNS A/AAAA or CNAME record, and a DNS PTR record, to identify the API load balancer. These records must be resolvable by both clients external to the cluster and from all the nodes within the cluster.
	<b>api-int.&lt;cluster_name&gt;.&lt;base_domain&gt;.</b>	A DNS A/AAAA or CNAME record, and a DNS PTR record, to internally identify the API load balancer. These records must be resolvable from all the nodes within the cluster.
		 <p><b>IMPORTANT</b></p> <p>The API server must be able to resolve the worker nodes by the hostnames that are recorded in Kubernetes. If the API server cannot resolve the node names, then proxied API calls can fail, and you cannot retrieve logs from pods.</p>
Routes	<b>*.apps.&lt;cluster_name&gt;.&lt;base_domain&gt;.</b>	A wildcard DNS A/AAAA or CNAME record that refers to the application ingress load balancer. The application ingress load balancer targets the machines that run the Ingress Controller pods. The Ingress Controller pods run on the compute machines by default. These records must be resolvable by both clients external to the cluster and from all the nodes within the cluster.  For example, <b>console-openshift-console.apps.&lt;cluster_name&gt;.&lt;base_domain&gt;</b> is used as a wildcard route to the OpenShift Container Platform console.
Bootstrap machine	<b>bootstrap.&lt;cluster_name&gt;.&lt;base_domain&gt;.</b>	A DNS A/AAAA or CNAME record, and a DNS PTR record, to identify the bootstrap machine. These records must be resolvable by the nodes within the cluster.

Component	Record	Description
Control plane machines	<b>&lt;master&gt;&lt;n&gt;. &lt;cluster_name&gt;. &lt;base_domain&gt;.</b>	DNS A/AAAA or CNAME records and DNS PTR records to identify each machine for the control plane nodes. These records must be resolvable by the nodes within the cluster.
Compute machines	<b>&lt;worker&gt;&lt;n&gt;. &lt;cluster_name&gt;. &lt;base_domain&gt;.</b>	DNS A/AAAA or CNAME records and DNS PTR records to identify each machine for the worker nodes. These records must be resolvable by the nodes within the cluster.

**NOTE**

In OpenShift Container Platform 4.4 and later, you do not need to specify etcd host and SRV records in your DNS configuration.

**TIP**

You can use the **dig** command to verify name and reverse name resolution. See the section on *Validating DNS resolution for user-provisioned infrastructure* for detailed validation steps.

**10.2.3.5.1. Example DNS configuration for user-provisioned clusters**

This section provides A and PTR record configuration samples that meet the DNS requirements for deploying OpenShift Container Platform on user-provisioned infrastructure. The samples are not meant to provide advice for choosing one DNS solution over another.

In the examples, the cluster name is **ocp4** and the base domain is **example.com**.

**Example DNS A record configuration for a user-provisioned cluster**

The following example is a BIND zone file that shows sample A records for name resolution in a user-provisioned cluster.

**Example 10.1. Sample DNS zone database**

```
$TTL 1W
@ IN SOA ns1.example.com. root (
  2019070700 ; serial
  3H ; refresh (3 hours)
  30M ; retry (30 minutes)
  2W ; expiry (2 weeks)
  1W ) ; minimum (1 week)
IN NS ns1.example.com.
IN MX 10 smtp.example.com.
;
;
ns1.example.com. IN A 192.168.1.5
smtp.example.com. IN A 192.168.1.5
;
helper.example.com. IN A 192.168.1.5
```

```

helper.ocp4.example.com. IN A 192.168.1.5
;
api.ocp4.example.com. IN A 192.168.1.5 1
api-int.ocp4.example.com. IN A 192.168.1.5 2
;
*.apps.ocp4.example.com. IN A 192.168.1.5 3
;
bootstrap.ocp4.example.com. IN A 192.168.1.96 4
;
master0.ocp4.example.com. IN A 192.168.1.97 5
master1.ocp4.example.com. IN A 192.168.1.98 6
master2.ocp4.example.com. IN A 192.168.1.99 7
;
worker0.ocp4.example.com. IN A 192.168.1.11 8
worker1.ocp4.example.com. IN A 192.168.1.7 9
;
;EOF

```

- 1 Provides name resolution for the Kubernetes API. The record refers to the IP address of the API load balancer.
- 2 Provides name resolution for the Kubernetes API. The record refers to the IP address of the API load balancer and is used for internal cluster communications.
- 3 Provides name resolution for the wildcard routes. The record refers to the IP address of the application ingress load balancer. The application ingress load balancer targets the machines that run the Ingress Controller pods. The Ingress Controller pods run on the compute machines by default.



#### NOTE

In the example, the same load balancer is used for the Kubernetes API and application ingress traffic. In production scenarios, you can deploy the API and application ingress load balancers separately so that you can scale the load balancer infrastructure for each in isolation.

- 4 Provides name resolution for the bootstrap machine.
- 5 6 7 Provides name resolution for the control plane machines.
- 8 9 Provides name resolution for the compute machines.

### Example DNS PTR record configuration for a user-provisioned cluster

The following example BIND zone file shows sample PTR records for reverse name resolution in a user-provisioned cluster.

#### Example 10.2. Sample DNS zone database for reverse records

```

$TTL 1W
@ IN SOA ns1.example.com. root (
  2019070700 ; serial

```

```

3H ; refresh (3 hours)
30M ; retry (30 minutes)
2W ; expiry (2 weeks)
1W ) ; minimum (1 week)
IN NS ns1.example.com.
;
5.1.168.192.in-addr.arpa. IN PTR api.ocp4.example.com. 1
5.1.168.192.in-addr.arpa. IN PTR api-int.ocp4.example.com. 2
;
96.1.168.192.in-addr.arpa. IN PTR bootstrap.ocp4.example.com. 3
;
97.1.168.192.in-addr.arpa. IN PTR master0.ocp4.example.com. 4
98.1.168.192.in-addr.arpa. IN PTR master1.ocp4.example.com. 5
99.1.168.192.in-addr.arpa. IN PTR master2.ocp4.example.com. 6
;
11.1.168.192.in-addr.arpa. IN PTR worker0.ocp4.example.com. 7
7.1.168.192.in-addr.arpa. IN PTR worker1.ocp4.example.com. 8
;
;EOF

```

- 1 Provides reverse DNS resolution for the Kubernetes API. The PTR record refers to the record name of the API load balancer.
- 2 Provides reverse DNS resolution for the Kubernetes API. The PTR record refers to the record name of the API load balancer and is used for internal cluster communications.
- 3 Provides reverse DNS resolution for the bootstrap machine.
- 4 5 6 Provides reverse DNS resolution for the control plane machines.
- 7 8 Provides reverse DNS resolution for the compute machines.



#### NOTE

A PTR record is not required for the OpenShift Container Platform application wildcard.

#### Additional resources

- [Validating DNS resolution for user-provisioned infrastructure](#)

#### 10.2.3.6. Load balancing requirements for user-provisioned infrastructure

Before you install OpenShift Container Platform, you must provision the API and application ingress load balancing infrastructure. In production scenarios, you can deploy the API and application ingress load balancers separately so that you can scale the load balancer infrastructure for each in isolation.



#### NOTE

If you want to deploy the API and application Ingress load balancers with a Red Hat Enterprise Linux (RHEL) instance, you must purchase the RHEL subscription separately.

The load balancing infrastructure must meet the following requirements:

1. **API load balancer.** Provides a common endpoint for users, both human and machine, to interact with and configure the platform. Configure the following conditions:
  - Layer 4 load balancing only. This can be referred to as Raw TCP, SSL Passthrough, or SSL Bridge mode. If you use SSL Bridge mode, you must enable Server Name Indication (SNI) for the API routes.
  - A stateless load balancing algorithm. The options vary based on the load balancer implementation.

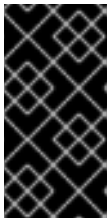

### IMPORTANT

Do not configure session persistence for an API load balancer. Configuring session persistence for a Kubernetes API server might cause performance issues from excess application traffic for your OpenShift Container Platform cluster and the Kubernetes API that runs inside the cluster.

Configure the following ports on both the front and back of the load balancers:

Table 10.7. API load balancer

Port	Back-end machines (pool members)	Internal	External	Description
<b>6443</b>	Bootstrap and control plane. You remove the bootstrap machine from the load balancer after the bootstrap machine initializes the cluster control plane. You must configure the <b>/readyz</b> endpoint for the API server health check probe.	X	X	Kubernetes API server
<b>22623</b>	Bootstrap and control plane. You remove the bootstrap machine from the load balancer after the bootstrap machine initializes the cluster control plane.	X		Machine config server



### NOTE

The load balancer must be configured to take a maximum of 30 seconds from the time the API server turns off the **/readyz** endpoint to the removal of the API server instance from the pool. Within the time frame after **/readyz** returns an error or becomes healthy, the endpoint must have been removed or added. Probing every 5 or 10 seconds, with two successful requests to become healthy and three to become unhealthy, are well-tested values.

2. **Application Ingress load balancer.** Provides an ingress point for application traffic flowing in from outside the cluster. A working configuration for the Ingress router is required for an OpenShift Container Platform cluster. Configure the following conditions:

- Layer 4 load balancing only. This can be referred to as Raw TCP, SSL Passthrough, or SSL Bridge mode. If you use SSL Bridge mode, you must enable Server Name Indication (SNI) for the ingress routes.
- A connection-based or session-based persistence is recommended, based on the options available and types of applications that will be hosted on the platform.

## TIP

If the true IP address of the client can be seen by the application Ingress load balancer, enabling source IP-based session persistence can improve performance for applications that use end-to-end TLS encryption.

Configure the following ports on both the front and back of the load balancers:

**Table 10.8. Application Ingress load balancer**

Port	Back-end machines (pool members)	Internal	External	Description
<b>443</b>	The machines that run the Ingress Controller pods, compute, or worker, by default.	X	X	HTTPS traffic
<b>80</b>	The machines that run the Ingress Controller pods, compute, or worker, by default.	X	X	HTTP traffic



## NOTE

If you are deploying a three-node cluster with zero compute nodes, the Ingress Controller pods run on the control plane nodes. In three-node cluster deployments, you must configure your application Ingress load balancer to route HTTP and HTTPS traffic to the control plane nodes.

### 10.2.3.6.1. Example load balancer configuration for user-provisioned clusters

This section provides an example API and application ingress load balancer configuration that meets the load balancing requirements for user-provisioned clusters. The sample is an `/etc/haproxy/haproxy.cfg` configuration for an HAProxy load balancer. The example is not meant to provide advice for choosing one load balancing solution over another.

In the example, the same load balancer is used for the Kubernetes API and application ingress traffic. In production scenarios, you can deploy the API and application ingress load balancers separately so that you can scale the load balancer infrastructure for each in isolation.



## NOTE

If you are using HAProxy as a load balancer and SELinux is set to **enforcing**, you must ensure that the HAProxy service can bind to the configured TCP port by running `setsebool -P haproxy_connect_any=1`.

### Example 10.3. Sample API and application Ingress load balancer configuration



```

global
log      127.0.0.1 local2
pidfile  /var/run/haproxy.pid
maxconn  4000
daemon

defaults
mode     http
log      global
option   dontlognull
option   http-server-close
option   redispatch
retries  3
timeout  http-request 10s
timeout  queue        1m
timeout  connect      10s
timeout  client       1m
timeout  server       1m
timeout  http-keep-alive 10s
timeout  check        10s
maxconn  3000

listen api-server-6443 1
bind *:6443
mode tcp
server bootstrap bootstrap.ocp4.example.com:6443 check inter 1s backup 2
server master0 master0.ocp4.example.com:6443 check inter 1s
server master1 master1.ocp4.example.com:6443 check inter 1s
server master2 master2.ocp4.example.com:6443 check inter 1s

listen machine-config-server-22623 3
bind *:22623
mode tcp
server bootstrap bootstrap.ocp4.example.com:22623 check inter 1s backup 4
server master0 master0.ocp4.example.com:22623 check inter 1s
server master1 master1.ocp4.example.com:22623 check inter 1s
server master2 master2.ocp4.example.com:22623 check inter 1s

listen ingress-router-443 5
bind *:443
mode tcp
balance source
server worker0 worker0.ocp4.example.com:443 check inter 1s
server worker1 worker1.ocp4.example.com:443 check inter 1s

listen ingress-router-80 6
bind *:80
mode tcp
balance source
server worker0 worker0.ocp4.example.com:80 check inter 1s
server worker1 worker1.ocp4.example.com:80 check inter 1s

```

- 1 Port **6443** handles the Kubernetes API traffic and points to the control plane machines.
- 2 4 The bootstrap entries must be in place before the OpenShift Container Platform cluster installation and they must be removed after the bootstrap process is complete.
- 3 Port **22623** handles the machine config server traffic and points to the control plane machines.
- 5 Port **443** handles the HTTPS traffic and points to the machines that run the Ingress Controller

- 6 Port **80** handles the HTTP traffic and points to the machines that run the Ingress Controller pods. The Ingress Controller pods run on the compute machines by default.



#### NOTE

If you are deploying a three-node cluster with zero compute nodes, the Ingress Controller pods run on the control plane nodes. In three-node cluster deployments, you must configure your application Ingress load balancer to route HTTP and HTTPS traffic to the control plane nodes.

#### TIP

If you are using HAProxy as a load balancer, you can check that the **haproxy** process is listening on ports **6443**, **22623**, **443**, and **80** by running **netstat -nltp** on the HAProxy node.

### 10.2.4. Preparing the user-provisioned infrastructure

Before you install OpenShift Container Platform on user-provisioned infrastructure, you must prepare the underlying infrastructure.

This section provides details about the high-level steps required to set up your cluster infrastructure in preparation for an OpenShift Container Platform installation. This includes configuring IP networking and network connectivity for your cluster nodes, enabling the required ports through your firewall, and setting up the required DNS and load balancing infrastructure.

After preparation, your cluster infrastructure must meet the requirements outlined in the *Requirements for a cluster with user-provisioned infrastructure* section.

#### Prerequisites

- You have reviewed the [OpenShift Container Platform 4.x Tested Integrations](#) page.
- You have reviewed the infrastructure requirements detailed in the *Requirements for a cluster with user-provisioned infrastructure* section.

#### Procedure

1. If you are using DHCP to provide the IP networking configuration to your cluster nodes, configure your DHCP service.
  - a. Add persistent IP addresses for the nodes to your DHCP server configuration. In your configuration, match the MAC address of the relevant network interface to the intended IP address for each node.
  - b. When you use DHCP to configure IP addressing for the cluster machines, the machines also obtain the DNS server information through DHCP. Define the persistent DNS server address that is used by the cluster nodes through your DHCP server configuration.

**NOTE**

If you are not using a DHCP service, you must provide the IP networking configuration and the address of the DNS server to the nodes at RHCOS install time. These can be passed as boot arguments if you are installing from an ISO image. See the *Installing RHCOS and starting the OpenShift Container Platform bootstrap process* section for more information about static IP provisioning and advanced networking options.

- c. Define the hostnames of your cluster nodes in your DHCP server configuration. See the *Setting the cluster node hostnames through DHCP* section for details about hostname considerations.

**NOTE**

If you are not using a DHCP service, the cluster nodes obtain their hostname through a reverse DNS lookup.

2. Ensure that your network infrastructure provides the required network connectivity between the cluster components. See the *Networking requirements for user-provisioned infrastructure* section for details about the requirements.
3. Configure your firewall to enable the ports required for the OpenShift Container Platform cluster components to communicate. See *Networking requirements for user-provisioned infrastructure* section for details about the ports that are required.

**IMPORTANT**

By default, port **1936** is accessible for an OpenShift Container Platform cluster, because each control plane node needs access to this port.

Avoid using the Ingress load balancer to expose this port, because doing so might result in the exposure of sensitive information, such as statistics and metrics, related to Ingress Controllers.

4. Setup the required DNS infrastructure for your cluster.
  - a. Configure DNS name resolution for the Kubernetes API, the application wildcard, the bootstrap machine, the control plane machines, and the compute machines.
  - b. Configure reverse DNS resolution for the Kubernetes API, the bootstrap machine, the control plane machines, and the compute machines.  
See the *User-provisioned DNS requirements* section for more information about the OpenShift Container Platform DNS requirements.
5. Validate your DNS configuration.
  - a. From your installation node, run DNS lookups against the record names of the Kubernetes API, the wildcard routes, and the cluster nodes. Validate that the IP addresses in the responses correspond to the correct components.
  - b. From your installation node, run reverse DNS lookups against the IP addresses of the load balancer and the cluster nodes. Validate that the record names in the responses correspond to the correct components.

See the *Validating DNS resolution for user-provisioned infrastructure* section for detailed DNS validation steps.

6. Provision the required API and application ingress load balancing infrastructure. See the *Load balancing requirements for user-provisioned infrastructure* section for more information about the requirements.



#### NOTE

Some load balancing solutions require the DNS name resolution for the cluster nodes to be in place before the load balancing is initialized.

#### Additional resources

- [Requirements for a cluster with user-provisioned infrastructure](#)
- [Installing RHCOS and starting the OpenShift Container Platform bootstrap process](#)
- [Setting the cluster node hostnames through DHCP](#)
- [Advanced RHCOS installation configuration](#)
- [Networking requirements for user-provisioned infrastructure](#)
- [User-provisioned DNS requirements](#)
- [Validating DNS resolution for user-provisioned infrastructure](#)
- [Load balancing requirements for user-provisioned infrastructure](#)

### 10.2.5. Validating DNS resolution for user-provisioned infrastructure

You can validate your DNS configuration before installing OpenShift Container Platform on user-provisioned infrastructure.



#### IMPORTANT

The validation steps detailed in this section must succeed before you install your cluster.

#### Prerequisites

- You have configured the required DNS records for your user-provisioned infrastructure.

#### Procedure

1. From your installation node, run DNS lookups against the record names of the Kubernetes API, the wildcard routes, and the cluster nodes. Validate that the IP addresses contained in the responses correspond to the correct components.
  - a. Perform a lookup against the Kubernetes API record name. Check that the result points to the IP address of the API load balancer:

```
$ dig +noall +answer @<nameserver_ip> api.<cluster_name>.<base_domain> 1
```

- 1 Replace `<nameserver_ip>` with the IP address of the nameserver, `<cluster_name>` with your cluster name, and `<base_domain>` with your base domain name.

### Example output

```
api.ocp4.example.com. 0 IN A 192.168.1.5
```

- b. Perform a lookup against the Kubernetes internal API record name. Check that the result points to the IP address of the API load balancer:

```
$ dig +noall +answer @<nameserver_ip> api-int.<cluster_name>.<base_domain>
```

### Example output

```
api-int.ocp4.example.com. 0 IN A 192.168.1.5
```

- c. Test an example `*.apps.<cluster_name>.<base_domain>` DNS wildcard lookup. All of the application wildcard lookups must resolve to the IP address of the application ingress load balancer:

```
$ dig +noall +answer @<nameserver_ip> random.apps.<cluster_name>.<base_domain>
```

### Example output

```
random.apps.ocp4.example.com. 0 IN A 192.168.1.5
```



### NOTE

In the example outputs, the same load balancer is used for the Kubernetes API and application ingress traffic. In production scenarios, you can deploy the API and application ingress load balancers separately so that you can scale the load balancer infrastructure for each in isolation.

You can replace **random** with another wildcard value. For example, you can query the route to the OpenShift Container Platform console:

```
$ dig +noall +answer @<nameserver_ip> console-openshift-console.apps.<cluster_name>.<base_domain>
```

### Example output

```
console-openshift-console.apps.ocp4.example.com. 0 IN A 192.168.1.5
```

- d. Run a lookup against the bootstrap DNS record name. Check that the result points to the IP address of the bootstrap node:

```
$ dig +noall +answer @<nameserver_ip> bootstrap.<cluster_name>.<base_domain>
```

### Example output

```
bootstrap.ocp4.example.com. 0 IN A 192.168.1.96
```

- e. Use this method to perform lookups against the DNS record names for the control plane and compute nodes. Check that the results correspond to the IP addresses of each node.
2. From your installation node, run reverse DNS lookups against the IP addresses of the load balancer and the cluster nodes. Validate that the record names contained in the responses correspond to the correct components.
    - a. Perform a reverse lookup against the IP address of the API load balancer. Check that the response includes the record names for the Kubernetes API and the Kubernetes internal API:

```
$ dig +noall +answer @<nameserver_ip> -x 192.168.1.5
```

### Example output

```
5.1.168.192.in-addr.arpa. 0 IN PTR api-int.ocp4.example.com. 1
5.1.168.192.in-addr.arpa. 0 IN PTR api.ocp4.example.com. 2
```

- 1** Provides the record name for the Kubernetes internal API.
- 2** Provides the record name for the Kubernetes API.



### NOTE

A PTR record is not required for the OpenShift Container Platform application wildcard. No validation step is needed for reverse DNS resolution against the IP address of the application ingress load balancer.

- b. Perform a reverse lookup against the IP address of the bootstrap node. Check that the result points to the DNS record name of the bootstrap node:

```
$ dig +noall +answer @<nameserver_ip> -x 192.168.1.96
```

### Example output

```
96.1.168.192.in-addr.arpa. 0 IN PTR bootstrap.ocp4.example.com.
```

- c. Use this method to perform reverse lookups against the IP addresses for the control plane and compute nodes. Check that the results correspond to the DNS record names of each node.

### Additional resources

- [User-provisioned DNS requirements](#)
- [Load balancing requirements for user-provisioned infrastructure](#)

## 10.2.6. Generating a key pair for cluster node SSH access

During an OpenShift Container Platform installation, you can provide an SSH public key to the installation program. The key is passed to the Red Hat Enterprise Linux CoreOS (RHCOS) nodes through their Ignition config files and is used to authenticate SSH access to the nodes. The key is added to the `~/.ssh/authorized_keys` list for the **core** user on each node, which enables password-less authentication.

After the key is passed to the nodes, you can use the key pair to SSH in to the RHCOS nodes as the user **core**. To access the nodes through SSH, the private key identity must be managed by SSH for your local user.

If you want to SSH in to your cluster nodes to perform installation debugging or disaster recovery, you must provide the SSH public key during the installation process. The `./openshift-install gather` command also requires the SSH public key to be in place on the cluster nodes.



### IMPORTANT

Do not skip this procedure in production environments, where disaster recovery and debugging is required.



### NOTE

You must use a local key, not one that you configured with platform-specific approaches such as [AWS key pairs](#).

## Procedure

1. If you do not have an existing SSH key pair on your local machine to use for authentication onto your cluster nodes, create one. For example, on a computer that uses a Linux operating system, run the following command:

```
$ ssh-keygen -t ed25519 -N "" -f <path>/<file_name> 1
```

- 1 Specify the path and file name, such as `~/.ssh/id_ed25519`, of the new SSH key. If you have an existing key pair, ensure your public key is in the your `~/.ssh` directory.



### NOTE

If you plan to install an OpenShift Container Platform cluster that uses FIPS validated or Modules In Process cryptographic libraries on the **x86\_64** architecture, do not create a key that uses the **ed25519** algorithm. Instead, create a key that uses the **rsa** or **ecdsa** algorithm.

2. View the public SSH key:

```
$ cat <path>/<file_name>.pub
```

For example, run the following to view the `~/.ssh/id_ed25519.pub` public key:

```
$ cat ~/.ssh/id_ed25519.pub
```

3. Add the SSH private key identity to the SSH agent for your local user, if it has not already been added. SSH agent management of the key is required for password-less SSH authentication onto your cluster nodes, or if you want to use the `./openshift-install gather` command.

**NOTE**

On some distributions, default SSH private key identities such as `~/.ssh/id_rsa` and `~/.ssh/id_dsa` are managed automatically.

- a. If the **ssh-agent** process is not already running for your local user, start it as a background task:

```
$ eval "$(ssh-agent -s)"
```

**Example output**

```
Agent pid 31874
```

**NOTE**

If your cluster is in FIPS mode, only use FIPS-compliant algorithms to generate the SSH key. The key must be either RSA or ECDSA.

4. Add your SSH private key to the **ssh-agent**:

```
$ ssh-add <path>/<file_name> 1
```

- 1** Specify the path and file name for your SSH private key, such as `~/.ssh/id_ed25519`

**Example output**

```
Identity added: /home/<you>/<path>/<file_name> (<computer_name>)
```

**Next steps**

- When you install OpenShift Container Platform, provide the SSH public key to the installation program. If you install a cluster on infrastructure that you provision, you must provide the key to the installation program.

**Additional resources**

- [Verifying node health](#)

**10.2.7. Obtaining the installation program**

Before you install OpenShift Container Platform, download the installation file on a local computer.

**Prerequisites**

- You have a computer that runs Linux or macOS, with 500 MB of local disk space



## Procedure

1. Access the [Infrastructure Provider](#) page on the OpenShift Cluster Manager site. If you have a Red Hat account, log in with your credentials. If you do not, create an account.
2. Select your infrastructure provider.
3. Navigate to the page for your installation type, download the installation program that corresponds with your host operating system and architecture, and place the file in the directory where you will store the installation configuration files.



### IMPORTANT

The installation program creates several files on the computer that you use to install your cluster. You must keep the installation program and the files that the installation program creates after you finish installing the cluster. Both files are required to delete the cluster.



### IMPORTANT

Deleting the files created by the installation program does not remove your cluster, even if the cluster failed during installation. To remove your cluster, complete the OpenShift Container Platform uninstallation procedures for your specific cloud provider.

4. Extract the installation program. For example, on a computer that uses a Linux operating system, run the following command:

```
$ tar -xvf openshift-install-linux.tar.gz
```

5. Download your installation [pull secret from the Red Hat OpenShift Cluster Manager](#). This pull secret allows you to authenticate with the services that are provided by the included authorities, including Quay.io, which serves the container images for OpenShift Container Platform components.

## 10.2.8. Installing the OpenShift CLI by downloading the binary

You can install the OpenShift CLI (**oc**) to interact with OpenShift Container Platform from a command-line interface. You can install **oc** on Linux, Windows, or macOS.



### IMPORTANT

If you installed an earlier version of **oc**, you cannot use it to complete all of the commands in OpenShift Container Platform 4.10. Download and install the new version of **oc**.

### Installing the OpenShift CLI on Linux

You can install the OpenShift CLI (**oc**) binary on Linux by using the following procedure.

## Procedure

1. Navigate to the [OpenShift Container Platform downloads page](#) on the Red Hat Customer Portal.
2. Select the appropriate version in the **Version** drop-down menu.

3. Click **Download Now** next to the **OpenShift v4.10 Linux Client** entry and save the file.
4. Unpack the archive:

```
$ tar xvf <file>
```

5. Place the **oc** binary in a directory that is on your **PATH**.  
To check your **PATH**, execute the following command:

```
$ echo $PATH
```

After you install the OpenShift CLI, it is available using the **oc** command:

```
$ oc <command>
```

### Installing the OpenShift CLI on Windows

You can install the OpenShift CLI (**oc**) binary on Windows by using the following procedure.

#### Procedure

1. Navigate to the [OpenShift Container Platform downloads page](#) on the Red Hat Customer Portal.
2. Select the appropriate version in the **Version** drop-down menu.
3. Click **Download Now** next to the **OpenShift v4.10 Windows Client** entry and save the file.
4. Unzip the archive with a ZIP program.
5. Move the **oc** binary to a directory that is on your **PATH**.  
To check your **PATH**, open the command prompt and execute the following command:

```
C:\> path
```

After you install the OpenShift CLI, it is available using the **oc** command:

```
C:\> oc <command>
```

### Installing the OpenShift CLI on macOS

You can install the OpenShift CLI (**oc**) binary on macOS by using the following procedure.

#### Procedure

1. Navigate to the [OpenShift Container Platform downloads page](#) on the Red Hat Customer Portal.
2. Select the appropriate version in the **Version** drop-down menu.
3. Click **Download Now** next to the **OpenShift v4.10 MacOSX Client** entry and save the file.
4. Unpack and unzip the archive.
5. Move the **oc** binary to a directory on your **PATH**.  
To check your **PATH**, open a terminal and execute the following command:

```
$ echo $PATH
```

After you install the OpenShift CLI, it is available using the **oc** command:

```
$ oc <command>
```

### 10.2.9. Manually creating the installation configuration file

For user-provisioned installations of OpenShift Container Platform, you manually generate your installation configuration file.

#### Prerequisites

- You have an SSH public key on your local machine to provide to the installation program. The key will be used for SSH authentication onto your cluster nodes for debugging and disaster recovery.
- You have obtained the OpenShift Container Platform installation program and the pull secret for your cluster.

#### Procedure

1. Create an installation directory to store your required installation assets in:

```
$ mkdir <installation_directory>
```

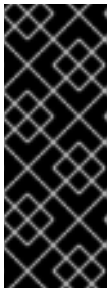

#### IMPORTANT

You must create a directory. Some installation assets, like bootstrap X.509 certificates have short expiration intervals, so you must not reuse an installation directory. If you want to reuse individual files from another cluster installation, you can copy them into your directory. However, the file names for the installation assets might change between releases. Use caution when copying installation files from an earlier OpenShift Container Platform version.

2. Customize the sample **install-config.yaml** file template that is provided and save it in the **<installation\_directory>**.



#### NOTE

You must name this configuration file **install-config.yaml**.



#### NOTE

For some platform types, you can alternatively run **./openshift-install create install-config --dir <installation\_directory>** to generate an **install-config.yaml** file. You can provide details about your cluster configuration at the prompts.

3. Back up the **install-config.yaml** file so that you can use it to install multiple clusters.

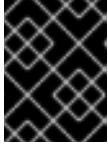
**IMPORTANT**

The **install-config.yaml** file is consumed during the next step of the installation process. You must back it up now.

**10.2.9.1. Installation configuration parameters**

Before you deploy an OpenShift Container Platform cluster, you provide a customized **install-config.yaml** installation configuration file that describes the details for your environment.

**NOTE**

After installation, you cannot modify these parameters in the **install-config.yaml** file.

**10.2.9.1.1. Required configuration parameters**

Required installation configuration parameters are described in the following table:

Table 10.9. Required parameters

Parameter	Description	Values
<b>apiVersion</b>	The API version for the <b>install-config.yaml</b> content. The current version is <b>v1</b> . The installer may also support older API versions.	String
<b>baseDomain</b>	The base domain of your cloud provider. The base domain is used to create routes to your OpenShift Container Platform cluster components. The full DNS name for your cluster is a combination of the <b>baseDomain</b> and <b>metadata.name</b> parameter values that uses the <b>&lt;metadata.name&gt;</b> . <b>&lt;baseDomain&gt;</b> format.	A fully-qualified domain or subdomain name, such as <b>example.com</b> .
<b>metadata</b>	Kubernetes resource <b>ObjectMeta</b> , from which only the <b>name</b> parameter is consumed.	Object
<b>metadata.name</b>	The name of the cluster. DNS records for the cluster are all subdomains of <b>{{.metadata.name}}</b> . <b>{{.baseDomain}}</b> .	String of lowercase letters and hyphens (-), such as <b>dev</b> .

Parameter	Description	Values
<b>platform</b>	The configuration for the specific platform upon which to perform the installation: <b>alibabacloud</b> , <b>aws</b> , <b>baremetal</b> , <b>azure</b> , <b>gcp</b> , <b>ibmcloud</b> , <b>openstack</b> , <b>ovirt</b> , <b>vsphere</b> , or <b>{}</b> . For additional information about <b>platform.&lt;platform&gt;</b> parameters, consult the table for your specific platform that follows.	Object
<b>pullSecret</b>	Get a <a href="#">pull secret from the Red Hat OpenShift Cluster Manager</a> to authenticate downloading container images for OpenShift Container Platform components from services such as Quay.io.	<pre>{   "auths":{     "cloud.openshift.com":{       "auth":"b3Blb=",       "email":"you@example.com"     },     "quay.io":{       "auth":"b3Blb=",       "email":"you@example.com"     }   } }</pre>

### 10.2.9.1.2. Network configuration parameters

You can customize your installation configuration based on the requirements of your existing network infrastructure. For example, you can expand the IP address block for the cluster network or provide different IP address blocks than the defaults.

Only IPv4 addresses are supported.

**Table 10.10. Network parameters**

Parameter	Description	Values
<b>networking</b>	The configuration for the cluster network.	<p>Object</p>  <p><b>NOTE</b></p> <p>You cannot modify parameters specified by the <b>networking</b> object after installation.</p>

Parameter	Description	Values
<b>networking.networkType</b>	The cluster network provider Container Network Interface (CNI) plugin to install.	Either <b>OpenShiftSDN</b> or <b>OVNKubernetes</b> . <b>OpenShiftSDN</b> is a CNI provider for all-Linux networks. <b>OVNKubernetes</b> is a CNI provider for Linux networks and hybrid networks that contain both Linux and Windows servers. The default value is <b>OpenShiftSDN</b> .
<b>networking.clusterNetwork</b>	The IP address blocks for pods.  The default value is <b>10.128.0.0/14</b> with a host prefix of <b>/23</b> .  If you specify multiple IP address blocks, the blocks must not overlap.	An array of objects. For example:  <pre>networking:   clusterNetwork:     - cidr: 10.128.0.0/14       hostPrefix: 23</pre>
<b>networking.clusterNetwork.cidr</b>	Required if you use <b>networking.clusterNetwork</b> . An IP address block.  An IPv4 network.	An IP address block in Classless Inter-Domain Routing (CIDR) notation. The prefix length for an IPv4 block is between <b>0</b> and <b>32</b> .
<b>networking.clusterNetwork.hostPrefix</b>	The subnet prefix length to assign to each individual node. For example, if <b>hostPrefix</b> is set to <b>23</b> then each node is assigned a <b>/23</b> subnet out of the given <b>cidr</b> . A <b>hostPrefix</b> value of <b>23</b> provides 510 ( $2^{(32 - 23)} - 2$ ) pod IP addresses.	A subnet prefix.  The default value is <b>23</b> .
<b>networking.serviceNetwork</b>	The IP address block for services. The default value is <b>172.30.0.0/16</b> .  The OpenShift SDN and OVN-Kubernetes network providers support only a single IP address block for the service network.	An array with an IP address block in CIDR format. For example:  <pre>networking:   serviceNetwork:     - 172.30.0.0/16</pre>
<b>networking.machineNetwork</b>	The IP address blocks for machines.  If you specify multiple IP address blocks, the blocks must not overlap.	An array of objects. For example:  <pre>networking:   machineNetwork:     - cidr: 10.0.0.0/16</pre>

Parameter	Description	Values
<b>networking.machineNetwork.cidr</b>	Required if you use <b>networking.machineNetwork</b> . An IP address block. The default value is <b>10.0.0.0/16</b> for all platforms other than libvirt. For libvirt, the default value is <b>192.168.126.0/24</b> .	An IP network block in CIDR notation. For example, <b>10.0.0.0/16</b> .  <b>NOTE</b> Set the <b>networking.machineNetwork</b> to match the CIDR that the preferred NIC resides in.

### 10.2.9.1.3. Optional configuration parameters

Optional installation configuration parameters are described in the following table:



Table 10.11. Optional parameters

Parameter	Description	Values
<b>additionalTrustBundle</b>	A PEM-encoded X.509 certificate bundle that is added to the nodes' trusted certificate store. This trust bundle may also be used when a proxy has been configured.	String
<b>cgroupsV2</b>	Enables <a href="#">Linux control groups version 2</a> (cgroups v2) on specific nodes in your cluster. The OpenShift Container Platform process for enabling cgroups v2 disables all cgroup version 1 controllers and hierarchies. The OpenShift Container Platform cgroups version 2 feature is in Developer Preview and is not supported by Red Hat at this time.	<b>true</b>
<b>compute</b>	The configuration for the machines that comprise the compute nodes.	Array of <b>MachinePool</b> objects.



Parameter	Description	Values
<b>compute.architecture</b>	Determines the instruction set architecture of the machines in the pool. Currently, clusters with varied architectures are not supported. All pools must specify the same architecture. Valid values are <b>amd64</b> and <b>arm64</b> .	String
<b>compute.hyperthreading</b>	Whether to enable or disable simultaneous multithreading, or <b>hyperthreading</b> , on compute machines. By default, simultaneous multithreading is enabled to increase the performance of your machines' cores.   <b>IMPORTANT</b>  If you disable simultaneous multithreading, ensure that your capacity planning accounts for the dramatically decreased machine performance.	<b>Enabled</b> or <b>Disabled</b>
<b>compute.name</b>	Required if you use <b>compute</b> . The name of the machine pool.	<b>worker</b>
<b>compute.platform</b>	Required if you use <b>compute</b> . Use this parameter to specify the cloud provider to host the worker machines. This parameter value must match the <b>controlPlane.platform</b> parameter value.	<b>alibabacloud, aws, azure, gcp, ibmcloud, openstack, ovirt, vsphere</b> , or <b>{}</b>
<b>compute.replicas</b>	The number of compute machines, which are also known as worker machines, to provision.	A positive integer greater than or equal to <b>2</b> . The default value is <b>3</b> .
<b>controlPlane</b>	The configuration for the machines that comprise the control plane.	Array of <b>MachinePool</b> objects.



Parameter	Description	Values
<b>controlPlane.architecture</b>	Determines the instruction set architecture of the machines in the pool. Currently, clusters with varied architectures are not supported. All pools must specify the same architecture. Valid values are <b>amd64</b> and <b>arm64</b> .	String
<b>controlPlane.hyperthreading</b>	Whether to enable or disable simultaneous multithreading, or <b>hyperthreading</b> , on control plane machines. By default, simultaneous multithreading is enabled to increase the performance of your machines' cores.   <b>IMPORTANT</b>  If you disable simultaneous multithreading, ensure that your capacity planning accounts for the dramatically decreased machine performance.	<b>Enabled</b> or <b>Disabled</b>
<b>controlPlane.name</b>	Required if you use <b>controlPlane</b> . The name of the machine pool.	<b>master</b>
<b>controlPlane.platform</b>	Required if you use <b>controlPlane</b> . Use this parameter to specify the cloud provider that hosts the control plane machines. This parameter value must match the <b>compute.platform</b> parameter value.	<b>alibabacloud, aws, azure, gcp, ibmcloud, openstack, ovirt, vsphere, or {}</b>
<b>controlPlane.replicas</b>	The number of control plane machines to provision.	The only supported value is <b>3</b> , which is the default value.

Parameter	Description	Values
<b>credentialsMode</b>	<p>The Cloud Credential Operator (CCO) mode. If no mode is specified, the CCO dynamically tries to determine the capabilities of the provided credentials, with a preference for mint mode on the platforms where multiple modes are supported.</p> <div data-bbox="485 510 596 864" style="border: 1px solid black; padding: 5px; margin-bottom: 10px;">  </div> <p><b>NOTE</b></p> <p>Not all CCO modes are supported for all cloud providers. For more information on CCO modes, see the <i>Cloud Credential Operator</i> entry in the <i>Cluster Operators reference content</i>.</p> <div data-bbox="485 904 596 1258" style="border: 1px solid black; padding: 5px;">  </div> <p><b>NOTE</b></p> <p>If your AWS account has service control policies (SCP) enabled, you must configure the <b>credentialsMode</b> parameter to <b>Mint</b>, <b>Passthrough</b> or <b>Manual</b>.</p>	<b>Mint, Passthrough, Manual</b> or an empty string ("").

Parameter	Description	Values
<b>fips</b>	<p>Enable or disable FIPS mode. The default is <b>false</b> (disabled). If FIPS mode is enabled, the Red Hat Enterprise Linux CoreOS (RHCOS) machines that OpenShift Container Platform runs on bypass the default Kubernetes cryptography suite and use the cryptography modules that are provided with RHCOS instead.</p> <div style="display: flex; align-items: flex-start;"> <div style="width: 60px; height: 100px; background: repeating-linear-gradient(45deg, transparent, transparent 2px, black 2px, black 4px); margin-right: 10px;"></div> <div> <p><b>IMPORTANT</b></p> <p>To enable FIPS mode for your cluster, you must run the installation program from a Red Hat Enterprise Linux (RHEL) computer configured to operate in FIPS mode. For more information about configuring FIPS mode on RHEL, see <a href="#">Installing the system in FIPS mode</a>. The use of FIPS validated or Modules In Process cryptographic libraries is only supported on OpenShift Container Platform deployments on the <b>x86_64</b> architecture.</p> </div> </div> <div style="display: flex; align-items: flex-start; margin-top: 10px;"> <div style="width: 60px; height: 60px; background: repeating-linear-gradient(45deg, transparent, transparent 2px, black 2px, black 4px); margin-right: 10px;"></div> <div> <p><b>NOTE</b></p> <p>If you are using Azure File storage, you cannot enable FIPS mode.</p> </div> </div>	<b>false</b> or <b>true</b>
<b>imageContentSources</b>	Sources and repositories for the release-image content.	Array of objects. Includes a <b>source</b> and, optionally, <b>mirrors</b> , as described in the following rows of this table.
<b>imageContentSources.source</b>	Required if you use <b>imageContentSources</b> . Specify the repository that users refer to, for example, in image pull specifications.	String
<b>imageContentSources.mirrors</b>	Specify one or more repositories that may also contain the same images.	Array of strings

Parameter	Description	Values
<b>publish</b>	How to publish or expose the user-facing endpoints of your cluster, such as the Kubernetes API, OpenShift routes.	<p><b>Internal</b> or <b>External</b>. The default value is <b>External</b>.</p> <p>Setting this field to <b>Internal</b> is not supported on non-cloud platforms and IBM Cloud VPC.</p> <div style="display: flex; align-items: flex-start;">  <div> <p><b>IMPORTANT</b></p> <p>If the value of the field is set to <b>Internal</b>, the cluster will become non-functional. For more information, refer to <a href="#">BZ#1953035</a>.</p> </div> </div>
<b>sshKey</b>	<p>The SSH key or keys to authenticate access your cluster machines.</p> <div style="display: flex; align-items: flex-start;">  <div> <p><b>NOTE</b></p> <p>For production OpenShift Container Platform clusters on which you want to perform installation debugging or disaster recovery, specify an SSH key that your <b>ssh-agent</b> process uses.</p> </div> </div>	<p>One or more keys. For example:</p> <pre>sshKey:   &lt;key1&gt;   &lt;key2&gt;   &lt;key3&gt;</pre>

### 10.2.9.2. Sample install-config.yaml file for bare metal

You can customize the **install-config.yaml** file to specify more details about your OpenShift Container Platform cluster's platform or modify the values of the required parameters.

```
apiVersion: v1
baseDomain: example.com 1
compute: 2
- hyperthreading: Enabled 3
  name: worker
  replicas: 0 4
controlPlane: 5
  hyperthreading: Enabled 6
  name: master
  replicas: 3 7
metadata:
  name: test 8
networking:
```

```

clusterNetwork:
- cidr: 10.128.0.0/14 9
  hostPrefix: 23 10
networkType: OpenShiftSDN
serviceNetwork: 11
- 172.30.0.0/16
platform:
  none: {} 12
fips: false 13
pullSecret: '{"auths": ...}' 14
sshKey: 'ssh-ed25519 AAAA...' 15

```

- 1** The base domain of the cluster. All DNS records must be sub-domains of this base and include the cluster name.
- 2** **5** The **controlPlane** section is a single mapping, but the **compute** section is a sequence of mappings. To meet the requirements of the different data structures, the first line of the **compute** section must begin with a hyphen, -, and the first line of the **controlPlane** section must not. Only one control plane pool is used.
- 3** **6** Specifies whether to enable or disable simultaneous multithreading (SMT), or hyperthreading. By default, SMT is enabled to increase the performance of the cores in your machines. You can disable it by setting the parameter value to **Disabled**. If you disable SMT, you must disable it in all cluster machines; this includes both control plane and compute machines.



#### NOTE

Simultaneous multithreading (SMT) is enabled by default. If SMT is not enabled in your BIOS settings, the **hyperthreading** parameter has no effect.



#### IMPORTANT

If you disable **hyperthreading**, whether in the BIOS or in the **install-config.yaml** file, ensure that your capacity planning accounts for the dramatically decreased machine performance.

- 4** You must set this value to **0** when you install OpenShift Container Platform on user-provisioned infrastructure. In installer-provisioned installations, the parameter controls the number of compute machines that the cluster creates and manages for you. In user-provisioned installations, you must manually deploy the compute machines before you finish installing the cluster.



#### NOTE

If you are installing a three-node cluster, do not deploy any compute machines when you install the Red Hat Enterprise Linux CoreOS (RHCOS) machines.

- 7** The number of control plane machines that you add to the cluster. Because the cluster uses these values as the number of etcd endpoints in the cluster, the value must match the number of control plane machines that you deploy.
- 8** The cluster name that you specified in your DNS records.
- 9** A block of IP addresses from which pod IP addresses are allocated. This block must not overlap

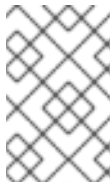
**NOTE**

Class E CIDR range is reserved for a future use. To use the Class E CIDR range, you must ensure your networking environment accepts the IP addresses within the Class E CIDR range.

- 10 The subnet prefix length to assign to each individual node. For example, if **hostPrefix** is set to **23**, then each node is assigned a **/23** subnet out of the given **cidr**, which allows for 510 ( $2^{(32 - 23)} - 2$ ) pod IP addresses. If you are required to provide access to nodes from an external network, configure load balancers and routers to manage the traffic.
- 11 The IP address pool to use for service IP addresses. You can enter only one IP address pool. This block must not overlap with existing physical networks. If you need to access the services from an external network, configure load balancers and routers to manage the traffic.
- 12 You must set the platform to **none**. You cannot provide additional platform configuration variables for your platform.

**IMPORTANT**

Clusters that are installed with the platform type **none** are unable to use some features, such as managing compute machines with the Machine API. This limitation applies even if the compute machines that are attached to the cluster are installed on a platform that would normally support the feature. This parameter cannot be changed after installation.

- 13 Whether to enable or disable FIPS mode. By default, FIPS mode is not enabled. If FIPS mode is enabled, the Red Hat Enterprise Linux CoreOS (RHCOS) machines that OpenShift Container Platform runs on bypass the default Kubernetes cryptography suite and use the cryptography modules that are provided with RHCOS instead.

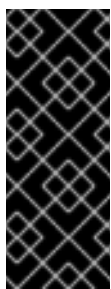
**IMPORTANT**

To enable FIPS mode for your cluster, you must run the installation program from a Red Hat Enterprise Linux (RHEL) computer configured to operate in FIPS mode. For more information about configuring FIPS mode on RHEL, see [Installing the system in FIPS mode](#). The use of FIPS validated or Modules In Process cryptographic libraries is only supported on OpenShift Container Platform deployments on the **x86\_64** architecture.

- 14 The [pull secret from the Red Hat OpenShift Cluster Manager](#) . This pull secret allows you to authenticate with the services that are provided by the included authorities, including Quay.io, which serves the container images for OpenShift Container Platform components.
- 15 The SSH public key for the **core** user in Red Hat Enterprise Linux CoreOS (RHCOS).

**NOTE**

For production OpenShift Container Platform clusters on which you want to perform installation debugging or disaster recovery, specify an SSH key that your **ssh-agent** process uses.

## Additional resources

- See [Load balancing requirements for user-provisioned infrastructure](#) for more information on the API and application ingress load balancing requirements.

### 10.2.9.3. Configuring the cluster-wide proxy during installation

Production environments can deny direct access to the internet and instead have an HTTP or HTTPS proxy available. You can configure a new OpenShift Container Platform cluster to use a proxy by configuring the proxy settings in the **install-config.yaml** file.

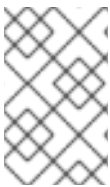

#### NOTE

For bare metal installations, if you do not assign node IP addresses from the range that is specified in the **networking.machineNetwork[].cidr** field in the **install-config.yaml** file, you must include them in the **proxy.noProxy** field.

## Prerequisites

- You have an existing **install-config.yaml** file.
- You reviewed the sites that your cluster requires access to and determined whether any of them need to bypass the proxy. By default, all cluster egress traffic is proxied, including calls to hosting cloud provider APIs. You added sites to the **Proxy** object's **spec.noProxy** field to bypass the proxy if necessary.



#### NOTE

The **Proxy** object **status.noProxy** field is populated with the values of the **networking.machineNetwork[].cidr**, **networking.clusterNetwork[].cidr**, and **networking.serviceNetwork[]** fields from your installation configuration.

For installations on Amazon Web Services (AWS), Google Cloud Platform (GCP), Microsoft Azure, and Red Hat OpenStack Platform (RHOSP), the **Proxy** object **status.noProxy** field is also populated with the instance metadata endpoint (**169.254.169.254**).

## Procedure

1. Edit your **install-config.yaml** file and add the proxy settings. For example:

```
apiVersion: v1
baseDomain: my.domain.com
proxy:
  httpProxy: http://<username>:<pswd>@<ip>:<port> 1
  httpsProxy: https://<username>:<pswd>@<ip>:<port> 2
  noProxy: example.com 3
  additionalTrustBundle: | 4
    -----BEGIN CERTIFICATE-----
    <MY_TRUSTED_CA_CERT>
    -----END CERTIFICATE-----
  ...
```

- 1 A proxy URL to use for creating HTTP connections outside the cluster. The URL scheme must be **http**.
- 2 A proxy URL to use for creating HTTPS connections outside the cluster.
- 3 A comma-separated list of destination domain names, IP addresses, or other network CIDRs to exclude from proxying. Preface a domain with **.** to match subdomains only. For example, **.y.com** matches **x.y.com**, but not **y.com**. Use **\*** to bypass the proxy for all destinations.
- 4 If provided, the installation program generates a config map that is named **user-ca-bundle** in the **openshift-config** namespace that contains one or more additional CA certificates that are required for proxying HTTPS connections. The Cluster Network Operator then creates a **trusted-ca-bundle** config map that merges these contents with the Red Hat Enterprise Linux CoreOS (RHCOS) trust bundle, and this config map is referenced in the **trustedCA** field of the **Proxy** object. The **additionalTrustBundle** field is required unless the proxy's identity certificate is signed by an authority from the RHCOS trust bundle.

**NOTE**

The installation program does not support the proxy **readinessEndpoints** field.

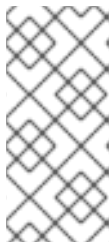
**NOTE**

If the installer times out, restart and then complete the deployment by using the **wait-for** command of the installer. For example:

```
$ ./openshift-install wait-for install-complete --log-level debug
```

2. Save the file and reference it when installing OpenShift Container Platform.

The installation program creates a cluster-wide proxy that is named **cluster** that uses the proxy settings in the provided **install-config.yaml** file. If no proxy settings are provided, a **cluster Proxy** object is still created, but it will have a nil **spec**.

**NOTE**

Only the **Proxy** object named **cluster** is supported, and no additional proxies can be created.

#### 10.2.9.4. Configuring a three-node cluster

Optionally, you can deploy zero compute machines in a bare metal cluster that consists of three control plane machines only. This provides smaller, more resource efficient clusters for cluster administrators and developers to use for testing, development, and production.

In three-node OpenShift Container Platform environments, the three control plane machines are schedulable, which means that your application workloads are scheduled to run on them.

#### Prerequisites

- You have an existing **install-config.yaml** file.



## Procedure

- Ensure that the number of compute replicas is set to **0** in your **install-config.yaml** file, as shown in the following **compute** stanza:

```
compute:
- name: worker
  platform: {}
  replicas: 0
```



### NOTE

You must set the value of the **replicas** parameter for the compute machines to **0** when you install OpenShift Container Platform on user-provisioned infrastructure, regardless of the number of compute machines you are deploying. In installer-provisioned installations, the parameter controls the number of compute machines that the cluster creates and manages for you. This does not apply to user-provisioned installations, where the compute machines are deployed manually.

For three-node cluster installations, follow these next steps:

- If you are deploying a three-node cluster with zero compute nodes, the Ingress Controller pods run on the control plane nodes. In three-node cluster deployments, you must configure your application ingress load balancer to route HTTP and HTTPS traffic to the control plane nodes. See the *Load balancing requirements for user-provisioned infrastructure* section for more information.
- When you create the Kubernetes manifest files in the following procedure, ensure that the **mastersSchedulable** parameter in the **<installation\_directory>/manifests/cluster-scheduler-02-config.yml** file is set to **true**. This enables your application workloads to run on the control plane nodes.
- Do not deploy any compute nodes when you create the Red Hat Enterprise Linux CoreOS (RHCOS) machines.

### 10.2.10. Creating the Kubernetes manifest and Ignition config files

Because you must modify some cluster definition files and manually start the cluster machines, you must generate the Kubernetes manifest and Ignition config files that the cluster needs to configure the machines.

The installation configuration file transforms into the Kubernetes manifests. The manifests wrap into the Ignition configuration files, which are later used to configure the cluster machines.



## IMPORTANT

- The Ignition config files that the OpenShift Container Platform installation program generates contain certificates that expire after 24 hours, which are then renewed at that time. If the cluster is shut down before renewing the certificates and the cluster is later restarted after the 24 hours have elapsed, the cluster automatically recovers the expired certificates. The exception is that you must manually approve the pending **node-bootstrapper** certificate signing requests (CSRs) to recover kubelet certificates. See the documentation for *Recovering from expired control plane certificates* for more information.
- It is recommended that you use Ignition config files within 12 hours after they are generated because the 24-hour certificate rotates from 16 to 22 hours after the cluster is installed. By using the Ignition config files within 12 hours, you can avoid installation failure if the certificate update runs during installation.

## Prerequisites

- You obtained the OpenShift Container Platform installation program.
- You created the **install-config.yaml** installation configuration file.

## Procedure

1. Change to the directory that contains the OpenShift Container Platform installation program and generate the Kubernetes manifests for the cluster:

```
$ ./openshift-install create manifests --dir <installation_directory> 1
```

- 1** For **<installation\_directory>**, specify the installation directory that contains the **install-config.yaml** file you created.



### WARNING

If you are installing a three-node cluster, skip the following step to allow the control plane nodes to be schedulable.



## IMPORTANT

When you configure control plane nodes from the default unschedulable to schedulable, additional subscriptions are required. This is because control plane nodes then become worker nodes.

2. Check that the **mastersSchedulable** parameter in the **<installation\_directory>/manifests/cluster-scheduler-02-config.yml** Kubernetes manifest file is set to **false**. This setting prevents pods from being scheduled on the control plane machines:
  - a. Open the **<installation\_directory>/manifests/cluster-scheduler-02-config.yml** file.

- b. Locate the **mastersSchedulable** parameter and ensure that it is set to **false**.
  - c. Save and exit the file.
3. To create the Ignition configuration files, run the following command from the directory that contains the installation program:

```
$ ./openshift-install create ignition-configs --dir <installation_directory> 1
```

- 1** For **<installation\_directory>**, specify the same installation directory.

Ignition config files are created for the bootstrap, control plane, and compute nodes in the installation directory. The **kubeadmin-password** and **kubeconfig** files are created in the **./<installation\_directory>/auth** directory:

```
.
├── auth
│   ├── kubeadmin-password
│   └── kubeconfig
├── bootstrap.ign
├── master.ign
├── metadata.json
└── worker.ign
```

#### Additional resources

- See [Recovering from expired control plane certificates](#) for more information about recovering kubelet certificates.

### 10.2.11. Installing RHCOS and starting the OpenShift Container Platform bootstrap process

To install OpenShift Container Platform on bare metal infrastructure that you provision, you must install Red Hat Enterprise Linux CoreOS (RHCOS) on the machines. When you install RHCOS, you must provide the Ignition config file that was generated by the OpenShift Container Platform installation program for the type of machine you are installing. If you have configured suitable networking, DNS, and load balancing infrastructure, the OpenShift Container Platform bootstrap process begins automatically after the RHCOS machines have rebooted.

To install RHCOS on the machines, follow either the steps to use an ISO image or network PXE booting.



#### NOTE

The compute node deployment steps included in this installation document are RHCOS-specific. If you choose instead to deploy RHEL-based compute nodes, you take responsibility for all operating system life cycle management and maintenance, including performing system updates, applying patches, and completing all other required tasks. Only RHEL 8 compute machines are supported.

You can configure RHCOS during ISO and PXE installations by using the following methods:

- Kernel arguments: You can use kernel arguments to provide installation-specific information. For example, you can specify the locations of the RHCOS installation files that you uploaded to

your HTTP server and the location of the Ignition config file for the type of node you are installing. For a PXE installation, you can use the **APPEND** parameter to pass the arguments to the kernel of the live installer. For an ISO installation, you can interrupt the live installation boot process to add the kernel arguments. In both installation cases, you can use special **coreos.inst.\*** arguments to direct the live installer, as well as standard installation boot arguments for turning standard kernel services on or off.

- Ignition configs: OpenShift Container Platform Ignition config files (**\*.ign**) are specific to the type of node you are installing. You pass the location of a bootstrap, control plane, or compute node Ignition config file during the RHCOS installation so that it takes effect on first boot. In special cases, you can create a separate, limited Ignition config to pass to the live system. That Ignition config could do a certain set of tasks, such as reporting success to a provisioning system after completing installation. This special Ignition config is consumed by the **coreos-installer** to be applied on first boot of the installed system. Do not provide the standard control plane and compute node Ignition configs to the live ISO directly.
- **coreos-installer**: You can boot the live ISO installer to a shell prompt, which allows you to prepare the permanent system in a variety of ways before first boot. In particular, you can run the **coreos-installer** command to identify various artifacts to include, work with disk partitions, and set up networking. In some cases, you can configure features on the live system and copy them to the installed system.

Whether to use an ISO or PXE install depends on your situation. A PXE install requires an available DHCP service and more preparation, but can make the installation process more automated. An ISO install is a more manual process and can be inconvenient if you are setting up more than a few machines.



#### NOTE

As of OpenShift Container Platform 4.6, the RHCOS ISO and other installation artifacts provide support for installation on disks with 4K sectors.

### 10.2.11.1. Installing RHCOS by using an ISO image

You can use an ISO image to install RHCOS on the machines.

#### Prerequisites

- You have created the Ignition config files for your cluster.
- You have configured suitable network, DNS and load balancing infrastructure.
- You have an HTTP server that can be accessed from your computer, and from the machines that you create.
- You have reviewed the *Advanced RHCOS installation configuration* section for different ways to configure features, such as networking and disk partitioning.

#### Procedure

1. Obtain the SHA512 digest for each of your Ignition config files. For example, you can use the following on a system running Linux to get the SHA512 digest for your **bootstrap.ign** Ignition config file:

```
$ sha512sum <installation_directory>/bootstrap.ign
```

The digests are provided to the **coreos-installer** in a later step to validate the authenticity of the Ignition config files on the cluster nodes.

2. Upload the bootstrap, control plane, and compute node Ignition config files that the installation program created to your HTTP server. Note the URLs of these files.



### IMPORTANT

You can add or change configuration settings in your Ignition configs before saving them to your HTTP server. If you plan to add more compute machines to your cluster after you finish installation, do not delete these files.

3. From the installation host, validate that the Ignition config files are available on the URLs. The following example gets the Ignition config file for the bootstrap node:

```
$ curl -k http://<HTTP_server>/bootstrap.ign 1
```

### Example output

```
% Total    % Received % Xferd Average Speed   Time    Time     Time  Current
           Dload  Upload   Total   Spent    Left    Speed
  0   0   0   0   0   0   0   0   0  --:--:-- --:--:-- --:--:--    0{"ignition":
{"version":"3.2.0"},"passwd":{"users":[{"name":"core","sshAuthorizedKeys":["ssh-rsa...
```

Replace **bootstrap.ign** with **master.ign** or **worker.ign** in the command to validate that the Ignition config files for the control plane and compute nodes are also available.

4. Although it is possible to obtain the RHCOS images that are required for your preferred method of installing operating system instances from the [RHCOS image mirror](#) page, the recommended way to obtain the correct version of your RHCOS images are from the output of **openshift-install** command:

```
$ openshift-install coreos print-stream-json | grep '\.iso[^\.]'
```

### Example output

```
"location": "<url>/art/storage/releases/rhcos-4.10-aarch64/<release>/aarch64/rhcos-
<release>-live.aarch64.iso",
"location": "<url>/art/storage/releases/rhcos-4.10-ppc64le/<release>/ppc64le/rhcos-
<release>-live.ppc64le.iso",
"location": "<url>/art/storage/releases/rhcos-4.10-s390x/<release>/s390x/rhcos-<release>-
live.s390x.iso",
"location": "<url>/art/storage/releases/rhcos-4.10/<release>/x86_64/rhcos-<release>-
live.x86_64.iso",
```



### IMPORTANT

The RHCOS images might not change with every release of OpenShift Container Platform. You must download images with the highest version that is less than or equal to the OpenShift Container Platform version that you install. Use the image versions that match your OpenShift Container Platform version if they are available. Use only ISO images for this procedure. RHCOS qcow2 images are not supported for this installation type.

ISO file names resemble the following example:

**rhcos-<version>-live.<architecture>.iso**

5. Use the ISO to start the RHCOS installation. Use one of the following installation options:
  - Burn the ISO image to a disk and boot it directly.
  - Use ISO redirection by using a lights-out management (LOM) interface.
6. Boot the RHCOS ISO image without specifying any options or interrupting the live boot sequence. Wait for the installer to boot into a shell prompt in the RHCOS live environment.

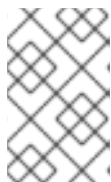

**NOTE**

It is possible to interrupt the RHCOS installation boot process to add kernel arguments. However, for this ISO procedure you should use the **coreos-installer** command as outlined in the following steps, instead of adding kernel arguments.

7. Run the **coreos-installer** command and specify the options that meet your installation requirements. At a minimum, you must specify the URL that points to the Ignition config file for the node type, and the device that you are installing to:

```
$ sudo coreos-installer install --ignition-url=http://<HTTP_server>/<node_type>.ign <device>
--ignition-hash=sha512-<digest> 1 2
```

- 1 1 You must run the **coreos-installer** command by using **sudo**, because the **core** user does not have the required root privileges to perform the installation.
- 2 The **--ignition-hash** option is required when the Ignition config file is obtained through an HTTP URL to validate the authenticity of the Ignition config file on the cluster node. **<digest>** is the Ignition config file SHA512 digest obtained in a preceding step.



**NOTE**

If you want to provide your Ignition config files through an HTTPS server that uses TLS, you can add the internal certificate authority (CA) to the system trust store before running **coreos-installer**.

The following example initializes a bootstrap node installation to the **/dev/sda** device. The Ignition config file for the bootstrap node is obtained from an HTTP web server with the IP address 192.168.1.2:

```
$ sudo coreos-installer install --ignition-
url=http://192.168.1.2:80/installation_directory/bootstrap.ign /dev/sda --ignition-hash=sha512-
a5a2d43879223273c9b60af66b44202a1d1248fc01cf156c46d4a79f552b6bad47bc8cc78ddf011
6e80c59d2ea9e32ba53bc807afbca581aa059311def2c3e3b
```

8. Monitor the progress of the RHCOS installation on the console of the machine.

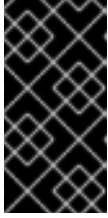

## IMPORTANT

Be sure that the installation is successful on each node before commencing with the OpenShift Container Platform installation. Observing the installation process can also help to determine the cause of RHCOS installation issues that might arise.

9. After RHCOS installs, you must reboot the system. During the system reboot, it applies the Ignition config file that you specified.
10. Check the console output to verify that Ignition ran.

### Example command

```
Ignition: ran on 2022/03/14 14:48:33 UTC (this boot)
Ignition: user-provided config was applied
```

11. Continue to create the other machines for your cluster.

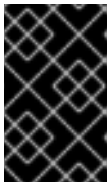

## IMPORTANT

You must create the bootstrap and control plane machines at this time. If the control plane machines are not made schedulable, also create at least two compute machines before you install OpenShift Container Platform.

If the required network, DNS, and load balancer infrastructure are in place, the OpenShift Container Platform bootstrap process begins automatically after the RHCOS nodes have rebooted.



## NOTE

RHCOS nodes do not include a default password for the **core** user. You can access the nodes by running **ssh core@<node>.<cluster\_name>.<base\_domain>** as a user with access to the SSH private key that is paired to the public key that you specified in your **install\_config.yaml** file. OpenShift Container Platform 4 cluster nodes running RHCOS are immutable and rely on Operators to apply cluster changes. Accessing cluster nodes by using SSH is not recommended. However, when investigating installation issues, if the OpenShift Container Platform API is not available, or the kubelet is not properly functioning on a target node, SSH access might be required for debugging or disaster recovery.

### 10.2.11.2. Installing RHCOS by using PXE or iPXE booting

You can use PXE or iPXE booting to install RHCOS on the machines.

#### Prerequisites

- You have created the Ignition config files for your cluster.
- You have configured suitable network, DNS and load balancing infrastructure.
- You have configured suitable PXE or iPXE infrastructure.

- You have an HTTP server that can be accessed from your computer, and from the machines that you create.
- You have reviewed the *Advanced RHCOS installation configuration* section for different ways to configure features, such as networking and disk partitioning.

## Procedure

1. Upload the bootstrap, control plane, and compute node Ignition config files that the installation program created to your HTTP server. Note the URLs of these files.



### IMPORTANT

You can add or change configuration settings in your Ignition configs before saving them to your HTTP server. If you plan to add more compute machines to your cluster after you finish installation, do not delete these files.

2. From the installation host, validate that the Ignition config files are available on the URLs. The following example gets the Ignition config file for the bootstrap node:

```
$ curl -k http://<HTTP_server>/bootstrap.ign 1
```

### Example output

```
% Total    % Received % Xferd Average Speed   Time    Time     Time  Current
           Dload  Upload Total   Spent   Left  Speed
  0  0  0    0    0    0    0    0  0  --:--:-- --:--:-- --:--:--    0{"ignition":
{"version":"3.2.0"},"passwd":{"users":[{"name":"core","sshAuthorizedKeys":["ssh-rsa...
```

Replace **bootstrap.ign** with **master.ign** or **worker.ign** in the command to validate that the Ignition config files for the control plane and compute nodes are also available.

3. Although it is possible to obtain the RHCOS **kernel**, **initramfs** and **rootfs** files that are required for your preferred method of installing operating system instances from the [RHCOS image mirror](#) page, the recommended way to obtain the correct version of your RHCOS files are from the output of **openshift-install** command:

```
$ openshift-install coreos print-stream-json | grep -Eo "https.*(kernel-|initramfs-|rootfs-)\w+(\.img)?"
```

### Example output

```
"<url>/art/storage/releases/rhcos-4.10-aarch64/<release>/aarch64/rhcos-<release>-live-
kernel-aarch64"
"<url>/art/storage/releases/rhcos-4.10-aarch64/<release>/aarch64/rhcos-<release>-live-
initramfs.aarch64.img"
"<url>/art/storage/releases/rhcos-4.10-aarch64/<release>/aarch64/rhcos-<release>-live-
rootfs.aarch64.img"
"<url>/art/storage/releases/rhcos-4.10-ppc64le/49.84.202110081256-0/ppc64le/rhcos-
<release>-live-kernel-ppc64le"
"<url>/art/storage/releases/rhcos-4.10-ppc64le/<release>/ppc64le/rhcos-<release>-live-
initramfs.ppc64le.img"
"<url>/art/storage/releases/rhcos-4.10-ppc64le/<release>/ppc64le/rhcos-<release>-live-
```



```

rootfs.ppc64le.img"
"<url>/art/storage/releases/rhcos-4.10-s390x/<release>/s390x/rhcos-<release>-live-kernel-
s390x"
"<url>/art/storage/releases/rhcos-4.10-s390x/<release>/s390x/rhcos-<release>-live-
initramfs.s390x.img"
"<url>/art/storage/releases/rhcos-4.10-s390x/<release>/s390x/rhcos-<release>-live-
rootfs.s390x.img"
"<url>/art/storage/releases/rhcos-4.10/<release>/x86_64/rhcos-<release>-live-kernel-
x86_64"
"<url>/art/storage/releases/rhcos-4.10/<release>/x86_64/rhcos-<release>-live-
initramfs.x86_64.img"
"<url>/art/storage/releases/rhcos-4.10/<release>/x86_64/rhcos-<release>-live-
rootfs.x86_64.img"

```

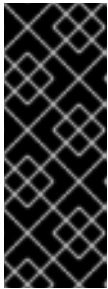

### IMPORTANT

The RHCOS artifacts might not change with every release of OpenShift Container Platform. You must download images with the highest version that is less than or equal to the OpenShift Container Platform version that you install. Only use the appropriate **kernel**, **initramfs**, and **rootfs** artifacts described below for this procedure. RHCOS QCOW2 images are not supported for this installation type.

The file names contain the OpenShift Container Platform version number. They resemble the following examples:

- **kernel:** `rhcos-<version>-live-kernel-<architecture>`
- **initramfs:** `rhcos-<version>-live-initramfs.<architecture>.img`
- **rootfs:** `rhcos-<version>-live-rootfs.<architecture>.img`

4. Upload the **rootfs**, **kernel**, and **initramfs** files to your HTTP server.

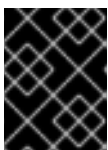

### IMPORTANT

If you plan to add more compute machines to your cluster after you finish installation, do not delete these files.

5. Configure the network boot infrastructure so that the machines boot from their local disks after RHCOS is installed on them.
6. Configure PXE or iPXE installation for the RHCOS images and begin the installation. Modify one of the following example menu entries for your environment and verify that the image and Ignition files are properly accessible:

- For PXE (**x86\_64**):

```

DEFAULT pxeboot
TIMEOUT 20
PROMPT 0
LABEL pxeboot
  KERNEL http://<HTTP_server>/rhcos-<version>-live-kernel-<architecture> 1
  APPEND initrd=http://<HTTP_server>/rhcos-<version>-live-initramfs.

```

```
<architecture>.img coreos.live.rootfs_url=http://<HTTP_server>/rhcos-<version>-live-  
rootfs.<architecture>.img coreos.inst.install_dev=/dev/sda  
coreos.inst.ignition_url=http://<HTTP_server>/bootstrap.ign
```

- 1 1 Specify the location of the live **kernel** file that you uploaded to your HTTP server. The URL must be HTTP, TFTP, or FTP; HTTPS and NFS are not supported.
- 2 If you use multiple NICs, specify a single interface in the **ip** option. For example, to use DHCP on a NIC that is named **eno1**, set **ip=eno1:dhcp**.
- 3 Specify the locations of the RHCOS files that you uploaded to your HTTP server. The **initrd** parameter value is the location of the **initramfs** file, the **coreos.live.rootfs\_url** parameter value is the location of the **rootfs** file, and the **coreos.inst.ignition\_url** parameter value is the location of the bootstrap Ignition config file. You can also add more kernel arguments to the **APPEND** line to configure networking or other boot options.



#### NOTE

This configuration does not enable serial console access on machines with a graphical console. To configure a different console, add one or more **console=** arguments to the **APPEND** line. For example, add **console=tty0 console=ttyS0** to set the first PC serial port as the primary console and the graphical console as a secondary console. For more information, see [How does one set up a serial terminal and/or console in Red Hat Enterprise Linux?](#)

- For iPXE (**x86\_64 + aarch64**):

```
kernel http://<HTTP_server>/rhcos-<version>-live-kernel-<architecture> initrd=main  
coreos.live.rootfs_url=http://<HTTP_server>/rhcos-<version>-live-rootfs.  
<architecture>.img coreos.inst.install_dev=/dev/sda  
coreos.inst.ignition_url=http://<HTTP_server>/bootstrap.ign  
initrd --name main http://<HTTP_server>/rhcos-<version>-live-initramfs.  
<architecture>.img  
boot
```

- 1 Specify the locations of the RHCOS files that you uploaded to your HTTP server. The **kernel** parameter value is the location of the **kernel** file, the **initrd=main** argument is needed for booting on UEFI systems, the **coreos.live.rootfs\_url** parameter value is the location of the **rootfs** file, and the **coreos.inst.ignition\_url** parameter value is the location of the bootstrap Ignition config file.
- 2 If you use multiple NICs, specify a single interface in the **ip** option. For example, to use DHCP on a NIC that is named **eno1**, set **ip=eno1:dhcp**.
- 3 Specify the location of the **initramfs** file that you uploaded to your HTTP server.

**NOTE**

This configuration does not enable serial console access on machines with a graphical console. To configure a different console, add one or more **console=** arguments to the **kernel** line. For example, add **console=tty0 console=ttyS0** to set the first PC serial port as the primary console and the graphical console as a secondary console. For more information, see [How does one set up a serial terminal and/or console in Red Hat Enterprise Linux?](#)

**NOTE**

To network boot the CoreOS **kernel** on **aarch64** architecture, you need to use a version of iPXE build with the **IMAGE\_GZIP** option enabled. See [IMAGE\\_GZIP option in iPXE](#).

- For PXE (with UEFI and Grub as second stage) on **aarch64**:

```
menuentry 'Install CoreOS' {
  linux rhcos-<version>-live-kernel-<architecture>
  coreos.live.rootfs_url=http://<HTTP_server>/rhcos-<version>-live-rootfs.
  <architecture>.img coreos.inst.install_dev=/dev/sda
  coreos.inst.ignition_url=http://<HTTP_server>/bootstrap.ign 1 2
  initrd rhcos-<version>-live-initramfs.<architecture>.img 3
}
```

- 1** Specify the locations of the RHCOS files that you uploaded to your HTTP/TFTP server. The **kernel** parameter value is the location of the **kernel** file on your TFTP server. The **coreos.live.rootfs\_url** parameter value is the location of the **rootfs** file, and the **coreos.inst.ignition\_url** parameter value is the location of the bootstrap Ignition config file on your HTTP Server.
- 2** If you use multiple NICs, specify a single interface in the **ip** option. For example, to use DHCP on a NIC that is named **eno1**, set **ip=eno1:dhcp**.
- 3** Specify the location of the **initramfs** file that you uploaded to your TFTP server.

7. Monitor the progress of the RHCOS installation on the console of the machine.

**IMPORTANT**

Be sure that the installation is successful on each node before commencing with the OpenShift Container Platform installation. Observing the installation process can also help to determine the cause of RHCOS installation issues that might arise.

8. After RHCOS installs, the system reboots. During reboot, the system applies the Ignition config file that you specified.
9. Check the console output to verify that Ignition ran.

**Example command**

Ignition: ran on 2022/03/14 14:48:33 UTC (this boot)  
 Ignition: user-provided config was applied

10. Continue to create the machines for your cluster.



### IMPORTANT

You must create the bootstrap and control plane machines at this time. If the control plane machines are not made schedulable, also create at least two compute machines before you install the cluster.

If the required network, DNS, and load balancer infrastructure are in place, the OpenShift Container Platform bootstrap process begins automatically after the RHCOS nodes have rebooted.



### NOTE

RHCOS nodes do not include a default password for the **core** user. You can access the nodes by running **ssh core@<node>.<cluster\_name>.<base\_domain>** as a user with access to the SSH private key that is paired to the public key that you specified in your **install\_config.yaml** file. OpenShift Container Platform 4 cluster nodes running RHCOS are immutable and rely on Operators to apply cluster changes. Accessing cluster nodes by using SSH is not recommended. However, when investigating installation issues, if the OpenShift Container Platform API is not available, or the kubelet is not properly functioning on a target node, SSH access might be required for debugging or disaster recovery.

### 10.2.11.3. Advanced RHCOS installation configuration

A key benefit for manually provisioning the Red Hat Enterprise Linux CoreOS (RHCOS) nodes for OpenShift Container Platform is to be able to do configuration that is not available through default OpenShift Container Platform installation methods. This section describes some of the configurations that you can do using techniques that include:

- Passing kernel arguments to the live installer
- Running **coreos-installer** manually from the live system
- Customizing a live ISO or PXE boot image

The advanced configuration topics for manual Red Hat Enterprise Linux CoreOS (RHCOS) installations detailed in this section relate to disk partitioning, networking, and using Ignition configs in different ways.

#### 10.2.11.3.1. Using advanced networking options for PXE and ISO installations

Networking for OpenShift Container Platform nodes uses DHCP by default to gather all necessary configuration settings. To set up static IP addresses or configure special settings, such as bonding, you can do one of the following:

- Pass special kernel parameters when you boot the live installer.
- Use a machine config to copy networking files to the installed system.

- Configure networking from a live installer shell prompt, then copy those settings to the installed system so that they take effect when the installed system first boots.

To configure a PXE or iPXE installation, use one of the following options:

- See the "Advanced RHCOS installation reference" tables.
- Use a machine config to copy networking files to the installed system.

To configure an ISO installation, use the following procedure.

### Procedure

1. Boot the ISO installer.
2. From the live system shell prompt, configure networking for the live system using available RHEL tools, such as **nmcli** or **nmtui**.
3. Run the **coreos-installer** command to install the system, adding the **--copy-network** option to copy networking configuration. For example:

```
$ sudo coreos-installer install --copy-network \
--ignition-url=http://host/worker.ign /dev/sda
```



### IMPORTANT

The **--copy-network** option only copies networking configuration found under **/etc/NetworkManager/system-connections**. In particular, it does not copy the system hostname.

4. Reboot into the installed system.

### Additional resources

- See [Getting started with nmcli](#) and [Getting started with nmtui](#) in the RHEL 8 documentation for more information about the **nmcli** and **nmtui** tools.

#### 10.2.11.3.2. Disk partitioning

The disk partitions are created on OpenShift Container Platform cluster nodes during the Red Hat Enterprise Linux CoreOS (RHCOS) installation. Each RHCOS node of a particular architecture uses the same partition layout, unless the default partitioning configuration is overridden. During the RHCOS installation, the size of the root file system is increased to use the remaining available space on the target device.

There are two cases where you might want to override the default partitioning when installing RHCOS on an OpenShift Container Platform cluster node:

- Creating separate partitions: For greenfield installations on an empty disk, you might want to add separate storage to a partition. This is officially supported for mounting **/var** or a subdirectory of **/var**, such as **/var/lib/etcd**, on a separate partition, but not both.

**IMPORTANT**

For disk sizes larger than 100GB, and especially disk sizes larger than 1TB, create a separate **/var** partition. See "Creating a separate **/var** partition" and this [Red Hat Knowledgebase article](#) for more information.

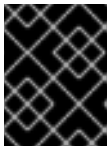
**IMPORTANT**

Kubernetes supports only two file system partitions. If you add more than one partition to the original configuration, Kubernetes cannot monitor all of them.

- Retaining existing partitions: For a brownfield installation where you are reinstalling OpenShift Container Platform on an existing node and want to retain data partitions installed from your previous operating system, there are both boot arguments and options to **coreos-installer** that allow you to retain existing data partitions.

**WARNING**

The use of custom partitions could result in those partitions not being monitored by OpenShift Container Platform or alerted on. If you are overriding the default partitioning, see [Understanding OpenShift File System Monitoring \(eviction conditions\)](#) for more information about how OpenShift Container Platform monitors your host file systems.

**10.2.11.3.2.1. Creating a separate /var partition**

In general, you should use the default disk partitioning that is created during the RHCOS installation. However, there are cases where you might want to create a separate partition for a directory that you expect to grow.

OpenShift Container Platform supports the addition of a single partition to attach storage to either the **/var** directory or a subdirectory of **/var**. For example:

- **/var/lib/containers**: Holds container-related content that can grow as more images and containers are added to a system.
- **/var/lib/etcd**: Holds data that you might want to keep separate for purposes such as performance optimization of etcd storage.
- **/var**: Holds data that you might want to keep separate for purposes such as auditing.

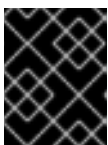
**IMPORTANT**

For disk sizes larger than 100GB, and especially larger than 1TB, create a separate **/var** partition.

Storing the contents of a **/var** directory separately makes it easier to grow storage for those areas as needed and reinstall OpenShift Container Platform at a later date and keep that data intact. With this method, you will not have to pull all your containers again, nor will you have to copy massive log files when you update systems.

The use of a separate partition for the **/var** directory or a subdirectory of **/var** also prevents data growth in the partitioned directory from filling up the root file system.

The following procedure sets up a separate **/var** partition by adding a machine config manifest that is wrapped into the Ignition config file for a node type during the preparation phase of an installation.

## Procedure

1. On your installation host, change to the directory that contains the OpenShift Container Platform installation program and generate the Kubernetes manifests for the cluster:

```
$ openshift-install create manifests --dir <installation_directory>
```

2. Create a Butane config that configures the additional partition. For example, name the file **\$HOME/clusterconfig/98-var-partition.bu**, change the disk device name to the name of the storage device on the **worker** systems, and set the storage size as appropriate. This example places the **/var** directory on a separate partition:

```
variant: openshift
version: 4.10.0
metadata:
  labels:
    machineconfiguration.openshift.io/role: worker
  name: 98-var-partition
storage:
  disks:
    - device: /dev/<device_name> 1
      partitions:
        - label: var
          start_mib: <partition_start_offset> 2
          size_mib: <partition_size> 3
      filesystems:
        - device: /dev/disk/by-partlabel/var
          path: /var
          format: xfs
          mount_options: [defaults, prjquota] 4
          with_mount_unit: true
```

- 1 The storage device name of the disk that you want to partition.
- 2 When adding a data partition to the boot disk, a minimum offset value of 25000 mebibytes is recommended. The root file system is automatically resized to fill all available space up to the specified offset. If no offset value is specified, or if the specified value is smaller than the recommended minimum, the resulting root file system will be too small, and future reinstalls of RHCOS might overwrite the beginning of the data partition.
- 3 The size of the data partition in mebibytes.
- 4 The **prjquota** mount option must be enabled for filesystems used for container storage.

**NOTE**

When creating a separate **/var** partition, you cannot use different instance types for compute nodes, if the different instance types do not have the same device name.

3. Create a manifest from the Butane config and save it to the **clusterconfig/openshift** directory. For example, run the following command:

```
$ butane $HOME/clusterconfig/98-var-partition.bu -o $HOME/clusterconfig/openshift/98-var-partition.yaml
```

4. Create the Ignition config files:

```
$ openshift-install create ignition-configs --dir <installation_directory> 1
```

- 1** For **<installation\_directory>**, specify the same installation directory.

Ignition config files are created for the bootstrap, control plane, and compute nodes in the installation directory:

```
.
├── auth
│   ├── kubeadmin-password
│   └── kubeconfig
├── bootstrap.ign
├── master.ign
├── metadata.json
└── worker.ign
```

The files in the **<installation\_directory>/manifest** and **<installation\_directory>/openshift** directories are wrapped into the Ignition config files, including the file that contains the **98-var-partition** custom **MachineConfig** object.

**Next steps**

- You can apply the custom disk partitioning by referencing the Ignition config files during the RHCOS installations.

**10.2.11.3.2.2. Retaining existing partitions**

For an ISO installation, you can add options to the **coreos-installer** command that cause the installer to maintain one or more existing partitions. For a PXE installation, you can add **coreos.inst.\*** options to the **APPEND** parameter to preserve partitions.

Saved partitions might be data partitions from an existing OpenShift Container Platform system. You can identify the disk partitions you want to keep either by partition label or by number.

**NOTE**

If you save existing partitions, and those partitions do not leave enough space for RHCOS, the installation will fail without damaging the saved partitions.



## Retaining existing partitions during an ISO installation

This example preserves any partition in which the partition label begins with **data** (**data\***):

```
# coreos-installer install --ignition-url http://10.0.2.2:8080/user.ign \
  --save-partlabel 'data*' /dev/sda
```

The following example illustrates running the **coreos-installer** in a way that preserves the sixth (6) partition on the disk:

```
# coreos-installer install --ignition-url http://10.0.2.2:8080/user.ign \
  --save-partindex 6 /dev/sda
```

This example preserves partitions 5 and higher:

```
# coreos-installer install --ignition-url http://10.0.2.2:8080/user.ign
  --save-partindex 5- /dev/sda
```

In the previous examples where partition saving is used, **coreos-installer** recreates the partition immediately.

## Retaining existing partitions during a PXE installation

This **APPEND** option preserves any partition in which the partition label begins with 'data' ('data\*'):

```
coreos.inst.save_partlabel=data*
```

This **APPEND** option preserves partitions 5 and higher:

```
coreos.inst.save_partindex=5-
```

This **APPEND** option preserves partition 6:

```
coreos.inst.save_partindex=6
```

### 10.2.11.3.3. Identifying Ignition configs

When doing an RHCOS manual installation, there are two types of Ignition configs that you can provide, with different reasons for providing each one:

- **Permanent install Ignition config:** Every manual RHCOS installation needs to pass one of the Ignition config files generated by **openshift-installer**, such as **bootstrap.ign**, **master.ign** and **worker.ign**, to carry out the installation.

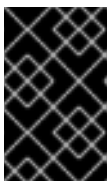

#### IMPORTANT

It is not recommended to modify these Ignition config files directly. You can update the manifest files that are wrapped into the Ignition config files, as outlined in examples in the preceding sections.

For PXE installations, you pass the Ignition configs on the **APPEND** line using the **coreos.inst.ignition\_url=** option. For ISO installations, after the ISO boots to the shell prompt, you identify the Ignition config on the **coreos-installer** command line with the **--ignition-url=**

option. In both cases, only HTTP and HTTPS protocols are supported.

- **Live install Ignition config:** This type can be created by using the **coreos-installer customize** subcommand and its various options. With this method, the Ignition config passes to the live install medium, runs immediately upon booting, and performs setup tasks before or after the RHCOS system installs to disk. This method should only be used for performing tasks that must be done once and not applied again later, such as with advanced partitioning that cannot be done using a machine config.

For PXE or ISO boots, you can create the Ignition config and **APPEND** the **ignition.config.url=** option to identify the location of the Ignition config. You also need to append **ignition.firstboot ignition.platform.id=metal** or the **ignition.config.url** option will be ignored.

### 10.2.11.3.3.1. Customizing a live RHCOS ISO or PXE install

You can use the live ISO image or PXE environment to install RHCOS by injecting an Ignition config file directly into the image. This creates a customized image that you can use to provision your system.

For an ISO image, the mechanism to do this is the **coreos-installer iso customize** subcommand, which modifies the **.iso** file with your configuration. Similarly, the mechanism for a PXE environment is the **coreos-installer pxe customize** subcommand, which creates a new **initramfs** file that includes your customizations.

The **customize** subcommand is a general purpose tool that can embed other types of customizations as well. The following tasks are examples of some of the more common customizations:

- Inject custom CA certificates for when corporate security policy requires their use.
- Configure network settings without the need for kernel arguments.
- Embed arbitrary pre-install and post-install scripts or binaries.

### 10.2.11.3.3.2. Customizing a live RHCOS ISO image

You can customize a live RHCOS ISO image directly with the **coreos-installer iso customize** subcommand. When you boot the ISO image, the customizations are applied automatically.

You can use this feature to configure the ISO image to automatically install RHCOS.

#### Procedure

1. Download the **coreos-installer** binary from the [coreos-installer image mirror](#) page.
2. Retrieve the RHCOS ISO image from the [RHCOS image mirror](#) page and the Ignition config file, and then run the following command to inject the Ignition config directly into the ISO image:

```
$ coreos-installer iso customize rhcos-<version>-live.x86_64.iso \
  --dest-ignition bootstrap.ign \ 1
  --dest-device /dev/sda 2
```

- 1 The Ignition config file that is generated from **openshift-installer**.
- 2 When you specify this option, the ISO image automatically runs an install. Otherwise, the image remains configured for installing, but does not do so automatically unless you specify the **coreos.inst.install\_dev** kernel argument.

Your customizations are applied and affect every subsequent boot of the ISO image.

1. To remove the ISO image customizations and return the image to its pristine state, run:

```
$ coreos-installer iso reset rhcos-<version>-live.x86_64.iso
```

You can now re-customize the live ISO image or use it in its pristine state.

#### 10.2.11.3.3.2.1. Modifying a live install ISO image to use a custom certificate authority

You can provide certificate authority (CA) certificates to Ignition with the **--ignition-ca** flag of the **customize** subcommand. You can use the CA certificates during both the installation boot and when provisioning the installed system.

##### Procedure

1. Download the **coreos-installer** binary from the [coreos-installer image mirror](#) page.
2. Retrieve the RHCOS ISO image from the [RHCOS image mirror](#) page and run the following command to customize the ISO image for use with a custom CA:

```
$ coreos-installer iso customize rhcos-<version>-live.x86_64.iso --ignition-ca cert.pem
```



##### IMPORTANT

The **coreos.inst.ignition\_url** kernel parameter does not work with the **--ignition-ca** flag. You must use the **--dest-ignition** flag to create a customized image for each cluster.



##### NOTE

Custom CA certificates affect how Ignition fetches remote resources but they do not affect the certificates installed onto the system.

Your CA certificate is applied and affects every subsequent boot of the ISO image.

#### 10.2.11.3.3.2.2. Modifying a live install ISO image with customized network settings

You can embed a NetworkManager keyfile into the live ISO image and pass it through to the installed system with the **--network-keyfile** flag of the **customize** subcommand.

##### Procedure

1. Download the **coreos-installer** binary from the [coreos-installer image mirror](#) page.
2. Create a connection profile for a bonded interface. For example, create the **bond0.nmconnection** file in your local directory with the following content:

```
[connection]
id=bond0
type=bond
interface-name=bond0
```

```

multi-connect=1
permissions=

[ethernet]
mac-address-blacklist=

[bond]
miimon=100
mode=active-backup

[ipv4]
method=auto

[ipv6]
method=auto

[proxy]

```

3. Create a connection profile for a secondary interface to add to the bond. For example, create the **bond0-proxy-em1.nmconnection** file in your local directory with the following content:

```

[connection]
id=em1
type=ethernet
interface-name=em1
master=bond0
multi-connect=1
permissions=
slave-type=bond

[ethernet]
mac-address-blacklist=

```

4. Create a connection profile for a secondary interface to add to the bond. For example, create the **bond0-proxy-em2.nmconnection** file in your local directory with the following content:

```

[connection]
id=em2
type=ethernet
interface-name=em2
master=bond0
multi-connect=1
permissions=
slave-type=bond

[ethernet]
mac-address-blacklist=

```

5. Retrieve the RHCOS ISO image from the [RHCOS image mirror](#) page and run the following command to customize the ISO image with your configured networking:

```

$ coreos-installer iso customize rhcos-<version>-live.x86_64.iso \
  --network-keyfile bond0.nmconnection \
  --network-keyfile bond0-proxy-em1.nmconnection \
  --network-keyfile bond0-proxy-em2.nmconnection

```

Network settings are applied to the live system and are carried over to the destination system.

### 10.2.11.3.3.3. Customizing a live RHCOS PXE environment

You can customize a live RHCOS PXE environment directly with the **coreos-installer pxe customize** subcommand. When you boot the PXE environment, the customizations are applied automatically.

You can use this feature to configure the PXE environment to automatically install RHCOS.

#### Procedure

1. Download the **coreos-installer** binary from the [coreos-installer image mirror](#) page.
2. Retrieve the RHCOS **kernel**, **initramfs** and **rootfs** files from the [RHCOS image mirror](#) page and the Ignition config file, and then run the following command to create a new **initramfs** file that contains the customizations from your Ignition config:

```
$ coreos-installer pxe customize rhcos-<version>-live-initramfs.x86_64.img \
  --dest-ignition bootstrap.ign \ 1
  --dest-device /dev/sda \ 2
  -o rhcos-<version>-custom-initramfs.x86_64.img
```

- 1 The Ignition config file that is generated from **openshift-installer**.
- 2 When you specify this option, the PXE environment automatically runs an install. Otherwise, the image remains configured for installing, but does not do so automatically unless you specify the **coreos.inst.install\_dev** kernel argument.

Your customizations are applied and affect every subsequent boot of the PXE environment.

#### 10.2.11.3.3.3.1. Modifying a live install PXE environment to use a custom certificate authority

You can provide certificate authority (CA) certificates to Ignition with the **--ignition-ca** flag of the **customize** subcommand. You can use the CA certificates during both the installation boot and when provisioning the installed system.

#### Procedure

1. Download the **coreos-installer** binary from the [coreos-installer image mirror](#) page.
2. Retrieve the RHCOS **kernel**, **initramfs** and **rootfs** files from the [RHCOS image mirror](#) page and run the following command to create a new customized **initramfs** file for use with a custom CA:

```
$ coreos-installer pxe customize rhcos-<version>-live-initramfs.x86_64.img \
  --ignition-ca cert.pem \
  -o rhcos-<version>-custom-initramfs.x86_64.img
```

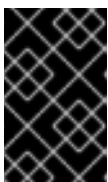

#### IMPORTANT

The **coreos.inst.ignition\_url** kernel parameter does not work with the **--ignition-ca** flag. You must use the **--dest-ignition** flag to create a customized image for each cluster.

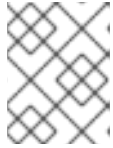
**NOTE**

Custom CA certificates affect how Ignition fetches remote resources but they do not affect the certificates installed onto the system.

Your CA certificate is applied and affects every subsequent boot of the PXE environment.

### 10.2.11.3.3.3.2. Modifying a live install PXE environment with customized network settings

You can embed a NetworkManager keyfile into the live PXE environment and pass it through to the installed system with the **--network-keyfile** flag of the **customize** subcommand.

#### Procedure

1. Download the **coreos-installer** binary from the [coreos-installer image mirror](#) page.
2. Create a connection profile for a bonded interface. For example, create the **bond0.nmconnection** file in your local directory with the following content:

```
[connection]
id=bond0
type=bond
interface-name=bond0
multi-connect=1
permissions=

[ethernet]
mac-address-blacklist=

[bond]
miimon=100
mode=active-backup

[ipv4]
method=auto

[ipv6]
method=auto

[proxy]
```

3. Create a connection profile for a secondary interface to add to the bond. For example, create the **bond0-proxy-em1.nmconnection** file in your local directory with the following content:

```
[connection]
id=em1
type=ethernet
interface-name=em1
master=bond0
multi-connect=1
permissions=
slave-type=bond

[ethernet]
mac-address-blacklist=
```

4. Create a connection profile for a secondary interface to add to the bond. For example, create the **bond0-proxy-em2.nmconnection** file in your local directory with the following content:

```
[connection]
id=em2
type=ethernet
interface-name=em2
master=bond0
multi-connect=1
permissions=
slave-type=bond

[ethernet]
mac-address-blacklist=
```

5. Retrieve the RHCOS **kernel**, **initramfs** and **rootfs** files from the [RHCOS image mirror](#) page and run the following command to create a new customized **initramfs** file that contains your configured networking:

```
$ coreos-installer pxe customize rhcos-<version>-live-initramfs.x86_64.img \
--network-keyfile bond0.nmconnection \
--network-keyfile bond0-proxy-em1.nmconnection \
--network-keyfile bond0-proxy-em2.nmconnection \
-o rhcos-<version>-custom-initramfs.x86_64.img
```

Network settings are applied to the live system and are carried over to the destination system.

#### 10.2.11.3.4. Advanced RHCOS installation reference

This section illustrates the networking configuration and other advanced options that allow you to modify the Red Hat Enterprise Linux CoreOS (RHCOS) manual installation process. The following tables describe the kernel arguments and command-line options you can use with the RHCOS live installer and the **coreos-installer** command.

##### 10.2.11.3.4.1. Networking and bonding options for ISO installations

If you install RHCOS from an ISO image, you can add kernel arguments manually when you boot the image to configure networking for a node. If no networking arguments are specified, DHCP is activated in the initramfs when RHCOS detects that networking is required to fetch the Ignition config file.

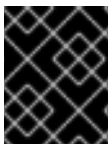

#### IMPORTANT

When adding networking arguments manually, you must also add the **rd.neednet=1** kernel argument to bring the network up in the initramfs.

The following table provides examples for configuring networking and bonding on your RHCOS nodes for ISO installations. The examples describe how to use the **ip=**, **nameserver=**, and **bond=** kernel arguments.



#### NOTE

Ordering is important when adding the kernel arguments: **ip=**, **nameserver=**, and then **bond=**.

The networking options are passed to the **dracut** tool during system boot. For more information about the networking options supported by **dracut**, see the **dracut.cmdline** manual page.

The following examples are the networking options for ISO installation.

#### Configuring DHCP or static IP addresses

To configure an IP address, either use DHCP (**ip=dhcp**) or set an individual static IP address (**ip=<host\_ip>**). If setting a static IP, you must then identify the DNS server IP address (**nameserver=<dns\_ip>**) on each node. The following example sets:

- The node's IP address to **10.10.10.2**
- The gateway address to **10.10.10.254**
- The netmask to **255.255.255.0**
- The hostname to **core0.example.com**
- The DNS server address to **4.4.4.41**
- The auto-configuration value to **none**. No auto-configuration is required when IP networking is configured statically.

```
ip=10.10.10.2::10.10.10.254:255.255.255.0:core0.example.com:enp1s0:none  
nameserver=4.4.4.41
```



#### NOTE

When you use DHCP to configure IP addressing for the RHCOS machines, the machines also obtain the DNS server information through DHCP. For DHCP-based deployments, you can define the DNS server address that is used by the RHCOS nodes through your DHCP server configuration.

#### Configuring an IP address without a static hostname

You can configure an IP address without assigning a static hostname. If a static hostname is not set by the user, it will be picked up and automatically set by a reverse DNS lookup. To configure an IP address without a static hostname refer to the following example:

- The node's IP address to **10.10.10.2**
- The gateway address to **10.10.10.254**
- The netmask to **255.255.255.0**
- The DNS server address to **4.4.4.41**
- The auto-configuration value to **none**. No auto-configuration is required when IP networking is configured statically.

```
ip=10.10.10.2::10.10.10.254:255.255.255.0::enp1s0:none  
nameserver=4.4.4.41
```

#### Specifying multiple network interfaces

You can specify multiple network interfaces by setting multiple **ip=** entries.



```
ip=10.10.10.2::10.10.10.254:255.255.255.0:core0.example.com:enp1s0:none
ip=10.10.10.3::10.10.10.254:255.255.255.0:core0.example.com:enp2s0:none
```

Configuring default gateway and route

Optional: You can configure routes to additional networks by setting an **rd.route=** value.



#### NOTE

When you configure one or multiple networks, one default gateway is required. If the additional network gateway is different from the primary network gateway, the default gateway must be the primary network gateway.

- Run the following command to configure the default gateway:

```
ip=::10.10.10.254:::
```

- Enter the following command to configure the route for the additional network:

```
rd.route=20.20.20.0/24:20.20.20.254:enp2s0
```

Disabling DHCP on a single interface

You can disable DHCP on a single interface, such as when there are two or more network interfaces and only one interface is being used. In the example, the **enp1s0** interface has a static networking configuration and DHCP is disabled for **enp2s0**, which is not used:

```
ip=10.10.10.2::10.10.10.254:255.255.255.0:core0.example.com:enp1s0:none
ip=::::core0.example.com:enp2s0:none
```

Combining DHCP and static IP configurations

You can combine DHCP and static IP configurations on systems with multiple network interfaces, for example:

```
ip=enp1s0:dhcp
ip=10.10.10.2::10.10.10.254:255.255.255.0:core0.example.com:enp2s0:none
```

Configuring VLANs on individual interfaces

Optional: You can configure VLANs on individual interfaces by using the **vlan=** parameter.

- To configure a VLAN on a network interface and use a static IP address, run the following command:

```
ip=10.10.10.2::10.10.10.254:255.255.255.0:core0.example.com:enp2s0.100:none
vlan=enp2s0.100:enp2s0
```

- To configure a VLAN on a network interface and to use DHCP, run the following command:

```
ip=enp2s0.100:dhcp
vlan=enp2s0.100:enp2s0
```

Providing multiple DNS servers

You can provide multiple DNS servers by adding a **nameserver=** entry for each server, for example:

```
nameserver=1.1.1.1
nameserver=8.8.8.8
```

Bonding multiple network interfaces to a single interface

Optional: You can bond multiple network interfaces to a single interface by using the **bond=** option. Refer to the following examples:

- The syntax for configuring a bonded interface is: **bond=name[:network\_interfaces][:options]** *name* is the bonding device name (**bond0**), *network\_interfaces* represents a comma-separated list of physical (ethernet) interfaces (**em1,em2**), and *options* is a comma-separated list of bonding options. Enter **modinfo bonding** to see available options.
- When you create a bonded interface using **bond=**, you must specify how the IP address is assigned and other information for the bonded interface.
- To configure the bonded interface to use DHCP, set the bond's IP address to **dhcp**. For example:

```
bond=bond0:em1,em2:mode=active-backup
ip=bond0:dhcp
```

- To configure the bonded interface to use a static IP address, enter the specific IP address you want and related information. For example:

```
bond=bond0:em1,em2:mode=active-backup
ip=10.10.10.2::10.10.10.254:255.255.255.0:core0.example.com:bond0:none
```

Bonding multiple network interfaces to a single interface

Optional: You can configure VLANs on bonded interfaces by using the **vlan=** parameter and to use DHCP, for example:

```
ip=bond0.100:dhcp
bond=bond0:em1,em2:mode=active-backup
vlan=bond0.100:bond0
```

Use the following example to configure the bonded interface with a VLAN and to use a static IP address:

```
ip=10.10.10.2::10.10.10.254:255.255.255.0:core0.example.com:bond0.100:none
bond=bond0:em1,em2:mode=active-backup
vlan=bond0.100:bond0
```

Using network teaming

Optional: You can use a network teaming as an alternative to bonding by using the **team=** parameter:

- The syntax for configuring a team interface is: **team=name[:network\_interfaces]** *name* is the team device name (**team0**) and *network\_interfaces* represents a comma-separated list of physical (ethernet) interfaces (**em1, em2**).

Teaming is planned to be deprecated when RHCOS switches to an upcoming version of RHEL. For more information, see this [Red Hat Knowledgebase Article](#) .

Use the following example to configure a network team:

```
team=team0:em1,em2
ip=team0:dhcp
```

#### 10.2.11.3.4.2. coreos-installer options for ISO and PXE installations

You can install RHCOS by running **coreos-installer install <options> <device>** at the command prompt, after booting into the RHCOS live environment from an ISO image.

The following table shows the subcommands, options, and arguments you can pass to the **coreos-installer** command.

**Table 10.12. coreos-installer subcommands, command-line options, and arguments**

coreos-installer install subcommand	
<i>Subcommand</i>	<i>Description</i>
<b>\$ coreos-installer install &lt;options&gt; &lt;device&gt;</b>	Embed an Ignition config in an ISO image.
coreos-installer install subcommand options	
<i>Option</i>	<i>Description</i>
<b>-u, --image-url &lt;url&gt;</b>	Specify the image URL manually.
<b>-f, --image-file &lt;path&gt;</b>	Specify a local image file manually. Used for debugging.
<b>-i, --ignition-file &lt;path&gt;</b>	Embed an Ignition config from a file.
<b>-l, --ignition-url &lt;URL&gt;</b>	Embed an Ignition config from a URL.
<b>--ignition-hash &lt;digest&gt;</b>	Digest <b>type-value</b> of the Ignition config.
<b>-p, --platform &lt;name&gt;</b>	Override the Ignition platform ID for the installed system.
<b>--append-karg &lt;arg&gt;...</b>	Append a default kernel argument to the installed system.
<b>--delete-karg &lt;arg&gt;...</b>	Delete a default kernel argument from the installed system.

<b>-n, --copy-network</b>	Copy the network configuration from the install environment.   <b>IMPORTANT</b> The <b>--copy-network</b> option only copies networking configuration found under <b>/etc/NetworkManager/system-connections</b> . In particular, it does not copy the system hostname.
<b>--network-dir &lt;path&gt;</b>	For use with <b>-n</b> . Default is <b>/etc/NetworkManager/system-connections/</b> .
<b>--save-partlabel &lt;lx&gt;..</b>	Save partitions with this label glob.
<b>--save-partindex &lt;id&gt;...</b>	Save partitions with this number or range.
<b>--insecure</b>	Skip RHCOS image signature verification.
<b>--insecure-ignition</b>	Allow Ignition URL without HTTPS or hash.
<b>--architecture &lt;name&gt;</b>	Target CPU architecture. Valid values are <b>x86_64</b> and <b>aarch64</b> .
<b>--preserve-on-error</b>	Do not clear partition table on error.
<b>-h, --help</b>	Print help information.
<b>coreos-installer install subcommand argument</b>	
<i>Argument</i>	<i>Description</i>
<b>&lt;device&gt;</b>	The destination device.
<b>coreos-installer ISO subcommands</b>	
<i>Subcommand</i>	<i>Description</i>
<b>\$ coreos-installer iso customize &lt;options&gt; &lt;ISO_image&gt;</b>	Customize a RHCOS live ISO image.

<b>coreos-installer iso reset &lt;options&gt; &lt;ISO_image&gt;</b>	Restore a RHCOS live ISO image to default settings.
<b>coreos-installer iso ignition remove &lt;options&gt; &lt;ISO_image&gt;</b>	Remove the embedded Ignition config from an ISO image.
coreos-installer ISO customize subcommand options	
<i>Option</i>	<i>Description</i>
<b>--dest-ignition &lt;path&gt;</b>	Merge the specified Ignition config file into a new configuration fragment for the destination system.
<b>--dest-device &lt;path&gt;</b>	Install and overwrite the specified destination device.
<b>--dest-karg-append &lt;arg&gt;</b>	Add a kernel argument to each boot of the destination system.
<b>--dest-karg-delete &lt;arg&gt;</b>	Delete a kernel argument from each boot of the destination system.
<b>--network-keyfile &lt;path&gt;</b>	Configure networking by using the specified NetworkManager keyfile for live and destination systems.
<b>--ignition-ca &lt;path&gt;</b>	Specify an additional TLS certificate authority to be trusted by Ignition.
<b>--pre-install &lt;path&gt;</b>	Run the specified script before installation.
<b>--post-install &lt;path&gt;</b>	Run the specified script after installation.
<b>--installer-config &lt;path&gt;</b>	Apply the specified installer configuration file.
<b>--live-ignition &lt;path&gt;</b>	Merge the specified Ignition config file into a new configuration fragment for the live environment.
<b>--live-karg-append &lt;arg&gt;</b>	Add a kernel argument to each boot of the live environment.
<b>--live-karg-delete &lt;arg&gt;</b>	Delete a kernel argument from each boot of the live environment.
<b>--live-karg-replace &lt;k=o=n&gt;</b>	Replace a kernel argument in each boot of the live environment, in the form <b>key=old=new</b> .
<b>-f, --force</b>	Overwrite an existing Ignition config.

<b>-o, --output &lt;path&gt;</b>	Write the ISO to a new output file.
<b>-h, --help</b>	Print help information.
coreos-installer PXE subcommands	
<i>Subcommand</i>	<i>Description</i>
Note that not all of these options are accepted by all subcommands.	
<b>coreos-installer pxe customize &lt;options&gt; &lt;path&gt;</b>	Customize a RHCOS live PXE boot config.
<b>coreos-installer pxe ignition wrap &lt;options&gt;</b>	Wrap an Ignition config in an image.
<b>coreos-installer pxe ignition unwrap &lt;options&gt; &lt;image_name&gt;</b>	Show the wrapped Ignition config in an image.
coreos-installer PXE customize subcommand options	
<i>Option</i>	<i>Description</i>
Note that not all of these options are accepted by all subcommands.	
<b>--dest-ignition &lt;path&gt;</b>	Merge the specified Ignition config file into a new configuration fragment for the destination system.
<b>--dest-device &lt;path&gt;</b>	Install and overwrite the specified destination device.
<b>--network-keyfile &lt;path&gt;</b>	Configure networking by using the specified NetworkManager keyfile for live and destination systems.
<b>--ignition-ca &lt;path&gt;</b>	Specify an additional TLS certificate authority to be trusted by Ignition.
<b>--pre-install &lt;path&gt;</b>	Run the specified script before installation.
<b>post-install &lt;path&gt;</b>	Run the specified script after installation.
<b>--installer-config &lt;path&gt;</b>	Apply the specified installer configuration file.
<b>--live-ignition &lt;path&gt;</b>	Merge the specified Ignition config file into a new configuration fragment for the live environment.

<b>-o, --output &lt;path&gt;</b>	Write the initramfs to a new output file.   <b>NOTE</b> This option is required for PXE environments.
<b>-h, --help</b>	Print help information.

#### 10.2.11.3.4.3. **coreos.inst** boot options for ISO or PXE installations

You can automatically invoke **coreos-installer** options at boot time by passing **coreos.inst** boot arguments to the RHCOS live installer. These are provided in addition to the standard boot arguments.

- For ISO installations, the **coreos.inst** options can be added by interrupting the automatic boot at the bootloader menu. You can interrupt the automatic boot by pressing **TAB** while the **RHEL CoreOS (Live)** menu option is highlighted.
- For PXE or iPXE installations, the **coreos.inst** options must be added to the **APPEND** line before the RHCOS live installer is booted.

The following table shows the RHCOS live installer **coreos.inst** boot options for ISO and PXE installations.

Table 10.13. **coreos.inst** boot options

Argument	Description
<b>coreos.inst.install_dev</b>	Required. The block device on the system to install to. It is recommended to use the full path, such as <b>/dev/sda</b> , although <b>sda</b> is allowed.
<b>coreos.inst.ignition_url</b>	Optional: The URL of the Ignition config to embed into the installed system. If no URL is specified, no Ignition config is embedded. Only HTTP and HTTPS protocols are supported.
<b>coreos.inst.save_partlabel</b>	Optional: Comma-separated labels of partitions to preserve during the install. Glob-style wildcards are permitted. The specified partitions do not need to exist.
<b>coreos.inst.save_partindex</b>	Optional: Comma-separated indexes of partitions to preserve during the install. Ranges <b>m-n</b> are permitted, and either <b>m</b> or <b>n</b> can be omitted. The specified partitions do not need to exist.
<b>coreos.inst.insecure</b>	Optional: Permits the OS image that is specified by <b>coreos.inst.image_url</b> to be unsigned.

Argument	Description
<b>coreos.inst.image_url</b>	<p>Optional: Download and install the specified RHCOS image.</p> <ul style="list-style-type: none"> <li>• This argument should not be used in production environments and is intended for debugging purposes only.</li> <li>• While this argument can be used to install a version of RHCOS that does not match the live media, it is recommended that you instead use the media that matches the version you want to install.</li> <li>• If you are using <b>coreos.inst.image_url</b>, you must also use <b>coreos.inst.insecure</b>. This is because the bare-metal media are not GPG-signed for OpenShift Container Platform.</li> <li>• Only HTTP and HTTPS protocols are supported.</li> </ul>
<b>coreos.inst.skip_reboot</b>	<p>Optional: The system will not reboot after installing. After the install finishes, you will receive a prompt that allows you to inspect what is happening during installation. This argument should not be used in production environments and is intended for debugging purposes only.</p>
<b>coreos.inst.platform_id</b>	<p>Optional: The Ignition platform ID of the platform the RHCOS image is being installed on. Default is <b>metal</b>. This option determines whether or not to request an Ignition config from the cloud provider, such as VMware. For example: <b>coreos.inst.platform_id=vmware</b>.</p>
<b>ignition.config.url</b>	<p>Optional: The URL of the Ignition config for the live boot. For example, this can be used to customize how <b>coreos-installer</b> is invoked, or to run code before or after the installation. This is different from <b>coreos.inst.ignition_url</b>, which is the Ignition config for the installed system.</p>

#### 10.2.11.4. Enabling multipathing with kernel arguments on RHCOS

RHCOS supports multipathing on the primary disk, allowing stronger resilience to hardware failure to achieve higher host availability.

You can enable multipathing at installation time for nodes that were provisioned in OpenShift Container Platform 4.8 or later. While post-installation support is available by activating multipathing via the machine config, enabling multipathing during installation is recommended.



In setups where any I/O to non-optimized paths results in I/O system errors, you must enable multipathing at installation time.

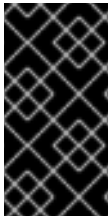

## IMPORTANT

On IBM Z and LinuxONE, you can enable multipathing only if you configured your cluster for it during installation. For more information, see "Installing RHCOS and starting the OpenShift Container Platform bootstrap process" in *Installing a cluster with z/VM on IBM Z and LinuxONE*.

The following procedure enables multipath at installation time and appends kernel arguments to the **coreos-installer install** command so that the installed system itself will use multipath beginning from the first boot.

## Prerequisites

- You have a running OpenShift Container Platform cluster that uses version 4.8 or later.



## NOTE

OpenShift Container Platform does not support enabling multipathing as a day-2 activity on nodes that have been upgraded from 4.6 or earlier.

- You are logged in to the cluster as a user with administrative privileges.

## Procedure

- To enable multipath and start the **multipathd** daemon, run the following command:

```
$ mpathconf --enable && systemctl start multipathd.service
```

- Optional: If booting the PXE or ISO, you can instead enable multipath by adding **rd.multipath=default** from the kernel command line.

- Append the kernel arguments by invoking the **coreos-installer** program:

- If there is only one multipath device connected to the machine, it should be available at path **/dev/mapper/mpatha**. For example:

```
$ coreos-installer install /dev/mapper/mpatha \ 1
--append-karg rd.multipath=default \
--append-karg root=/dev/disk/by-label/dm-mpath-root \
--append-karg rw
```

- 1 Indicates the path of the single multipathed device.

- If there are multiple multipath devices connected to the machine, or to be more explicit, instead of using **/dev/mapper/mpatha**, it is recommended to use the World Wide Name (WWN) symlink available in **/dev/disk/by-id**. For example:

```
$ coreos-installer install /dev/disk/by-id/wwn-<wwn_ID> \ 1
--append-karg rd.multipath=default \
--append-karg root=/dev/disk/by-label/dm-mpath-root \
```

```
--append-karg rw
```

- 1 Indicates the WWN ID of the target multipathed device. For example, **0xx194e957fcedb4841**.

This symlink can also be used as the **coreos.inst.install\_dev** kernel argument when using special **coreos.inst.\*** arguments to direct the live installer. For more information, see "Installing RHCOS and starting the OpenShift Container Platform bootstrap process".

3. Check that the kernel arguments worked by going to one of the worker nodes and listing the kernel command line arguments (in **/proc/cmdline** on the host):

```
$ oc debug node/ip-10-0-141-105.ec2.internal
```

### Example output

```
Starting pod/ip-10-0-141-105ec2internal-debug ...
To use host binaries, run `chroot /host`

sh-4.2# cat /host/proc/cmdline
...
rd.multipath=default root=/dev/disk/by-label/dm-mpath-root
...

sh-4.2# exit
```

You should see the added kernel arguments.

### Additional resources

- See [Installing RHCOS and starting the OpenShift Container Platform bootstrap process](#) for more information on using special **coreos.inst.\*** arguments to direct the live installer.

### 10.2.11.5. Updating the bootloader using bootupd

To update the bootloader by using **bootupd**, you must either install **bootupd** on RHCOS machines manually or provide a machine config with the enabled **systemd** unit. Unlike **grubby** or other bootloader tools, **bootupd** does not manage kernel space configuration such as passing kernel arguments.

After you have installed **bootupd**, you can manage it remotely from the OpenShift Container Platform cluster.



#### NOTE

It is recommended that you use **bootupd** only on bare metal or virtualized hypervisor installations, such as for protection against the BootHole vulnerability.

### Manual install method

You can manually install **bootupd** by using the **bootctl** command-line tool.

1. Inspect the system status:

■

```
# bootupctl status
```

### Example output for x86\_64

```
Component EFI
Installed: grub2-efi-x64-1:2.04-31.fc33.x86_64,shim-x64-15-8.x86_64
Update: At latest version
```

### Example output for aarch64

```
Component EFI
Installed: grub2-efi-aa64-1:2.02-99.el8_4.1.aarch64,shim-aa64-15.4-2.el8_1.aarch64
Update: At latest version
```

- RHCOS images created without **bootupd** installed on them require an explicit adoption phase. If the system status is **Adoptable**, perform the adoption:

```
# bootupctl adopt-and-update
```

### Example output

```
Updated: grub2-efi-x64-1:2.04-31.fc33.x86_64,shim-x64-15-8.x86_64
```

- If an update is available, apply the update so that the changes take effect on the next reboot:

```
# bootupctl update
```

### Example output

```
Updated: grub2-efi-x64-1:2.04-31.fc33.x86_64,shim-x64-15-8.x86_64
```

## Machine config method

Another way to enable **bootupd** is by providing a machine config.

- Provide a machine config file with the enabled **systemd** unit, as shown in the following example:

### Example output

```
variant: rhcos
version: 1.1.0
systemd:
  units:
    - name: custom-bootupd-auto.service
      enabled: true
      contents: |
        [Unit]
        Description=Bootupd automatic update

        [Service]
        ExecStart=/usr/bin/bootupctl update
        RemainAfterExit=yes
```

[Install]  
WantedBy=multi-user.target

## 10.2.12. Waiting for the bootstrap process to complete

The OpenShift Container Platform bootstrap process begins after the cluster nodes first boot into the persistent RHCOS environment that has been installed to disk. The configuration information provided through the Ignition config files is used to initialize the bootstrap process and install OpenShift Container Platform on the machines. You must wait for the bootstrap process to complete.

### Prerequisites

- You have created the Ignition config files for your cluster.
- You have configured suitable network, DNS and load balancing infrastructure.
- You have obtained the installation program and generated the Ignition config files for your cluster.
- You installed RHCOS on your cluster machines and provided the Ignition config files that the OpenShift Container Platform installation program generated.
- Your machines have direct internet access or have an HTTP or HTTPS proxy available.

### Procedure

1. Monitor the bootstrap process:

```
$ ./openshift-install --dir <installation_directory> wait-for bootstrap-complete \ 1
--log-level=info 2
```

1 For **<installation\_directory>**, specify the path to the directory that you stored the installation files in.

2 To view different installation details, specify **warn**, **debug**, or **error** instead of **info**.

### Example output

```
INFO Waiting up to 30m0s for the Kubernetes API at https://api.test.example.com:6443...
INFO API v1.23.0 up
INFO Waiting up to 30m0s for bootstrapping to complete...
INFO It is now safe to remove the bootstrap resources
```

The command succeeds when the Kubernetes API server signals that it has been bootstrapped on the control plane machines.

2. After bootstrap process is complete, remove the bootstrap machine from the load balancer.

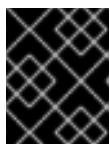

### IMPORTANT

You must remove the bootstrap machine from the load balancer at this point. You can also remove or reformat the bootstrap machine itself.

## Additional resources

- See [Monitoring installation progress](#) for more information about monitoring the installation logs and retrieving diagnostic data if installation issues arise.

### 10.2.13. Logging in to the cluster by using the CLI

You can log in to your cluster as a default system user by exporting the cluster **kubeconfig** file. The **kubeconfig** file contains information about the cluster that is used by the CLI to connect a client to the correct cluster and API server. The file is specific to a cluster and is created during OpenShift Container Platform installation.

#### Prerequisites

- You deployed an OpenShift Container Platform cluster.
- You installed the **oc** CLI.

#### Procedure

1. Export the **kubeadmin** credentials:

```
$ export KUBECONFIG=<installation_directory>/auth/kubeconfig 1
```

- 1** For **<installation\_directory>**, specify the path to the directory that you stored the installation files in.

2. Verify you can run **oc** commands successfully using the exported configuration:

```
$ oc whoami
```

#### Example output

```
system:admin
```

### 10.2.14. Approving the certificate signing requests for your machines

When you add machines to a cluster, two pending certificate signing requests (CSRs) are generated for each machine that you added. You must confirm that these CSRs are approved or, if necessary, approve them yourself. The client requests must be approved first, followed by the server requests.

#### Prerequisites

- You added machines to your cluster.

#### Procedure

1. Confirm that the cluster recognizes the machines:

```
$ oc get nodes
```

#### Example output

NAME	STATUS	ROLES	AGE	VERSION
master-0	Ready	master	63m	v1.23.0
master-1	Ready	master	63m	v1.23.0
master-2	Ready	master	64m	v1.23.0

The output lists all of the machines that you created.

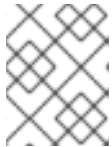

#### NOTE

The preceding output might not include the compute nodes, also known as worker nodes, until some CSRs are approved.

- Review the pending CSRs and ensure that you see the client requests with the **Pending** or **Approved** status for each machine that you added to the cluster:

```
$ oc get csr
```

#### Example output

NAME	AGE	REQUESTOR	CONDITION
csr-8b2br	15m	system:serviceaccount:openshift-machine-config-operator:node-bootstrapper	Pending
csr-8vnps	15m	system:serviceaccount:openshift-machine-config-operator:node-bootstrapper	Pending
...			

In this example, two machines are joining the cluster. You might see more approved CSRs in the list.

- If the CSRs were not approved, after all of the pending CSRs for the machines you added are in **Pending** status, approve the CSRs for your cluster machines:



#### NOTE

Because the CSRs rotate automatically, approve your CSRs within an hour of adding the machines to the cluster. If you do not approve them within an hour, the certificates will rotate, and more than two certificates will be present for each node. You must approve all of these certificates. After the client CSR is approved, the Kubelet creates a secondary CSR for the serving certificate, which requires manual approval. Then, subsequent serving certificate renewal requests are automatically approved by the **machine-approver** if the Kubelet requests a new certificate with identical parameters.

**NOTE**

For clusters running on platforms that are not machine API enabled, such as bare metal and other user-provisioned infrastructure, you must implement a method of automatically approving the kubelet serving certificate requests (CSRs). If a request is not approved, then the **oc exec**, **oc rsh**, and **oc logs** commands cannot succeed, because a serving certificate is required when the API server connects to the kubelet. Any operation that contacts the Kubelet endpoint requires this certificate approval to be in place. The method must watch for new CSRs, confirm that the CSR was submitted by the **node-bootstrap** service account in the **system:node** or **system:admin** groups, and confirm the identity of the node.

- To approve them individually, run the following command for each valid CSR:

```
$ oc adm certificate approve <csr_name> 1
```

- 1** **<csr\_name>** is the name of a CSR from the list of current CSRs.

- To approve all pending CSRs, run the following command:

```
$ oc get csr -o go-template='{{range .items}}{{if not .status}}{{.metadata.name}}{"\n"}\n{{end}}{{end}}' | xargs --no-run-if-empty oc adm certificate approve
```

**NOTE**

Some Operators might not become available until some CSRs are approved.

4. Now that your client requests are approved, you must review the server requests for each machine that you added to the cluster:

```
$ oc get csr
```

**Example output**

```
NAME      AGE   REQUESTOR                                     CONDITION
csr-bfd72 5m26s system:node:ip-10-0-50-126.us-east-2.compute.internal
Pending
csr-c57lv 5m26s system:node:ip-10-0-95-157.us-east-2.compute.internal
Pending
...
```

5. If the remaining CSRs are not approved, and are in the **Pending** status, approve the CSRs for your cluster machines:

- To approve them individually, run the following command for each valid CSR:

```
$ oc adm certificate approve <csr_name> 1
```

- 1** **<csr\_name>** is the name of a CSR from the list of current CSRs.

- To approve all pending CSRs, run the following command:

```
$ oc get csr -o go-template='{{range .items}}{{if not .status}}{{.metadata.name}}{\n"}\n{{end}}\n{{end}}' | xargs oc adm certificate approve
```

6. After all client and server CSRs have been approved, the machines have the **Ready** status. Verify this by running the following command:

```
$ oc get nodes
```

### Example output

```
NAME      STATUS  ROLES  AGE  VERSION
master-0  Ready   master 73m  v1.23.0
master-1  Ready   master 73m  v1.23.0
master-2  Ready   master 74m  v1.23.0
worker-0  Ready   worker 11m  v1.23.0
worker-1  Ready   worker 11m  v1.23.0
```

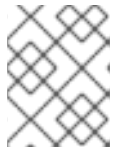

### NOTE

It can take a few minutes after approval of the server CSRs for the machines to transition to the **Ready** status.

### Additional information

- For more information on CSRs, see [Certificate Signing Requests](#).

## 10.2.15. Initial Operator configuration

After the control plane initializes, you must immediately configure some Operators so that they all become available.

### Prerequisites

- Your control plane has initialized.

### Procedure

1. Watch the cluster components come online:

```
$ watch -n5 oc get clusteroperators
```

### Example output

NAME	VERSION	AVAILABLE	PROGRESSING	DEGRADED	SINCE
authentication	4.10.0	True	False	False	19m
baremetal	4.10.0	True	False	False	37m
cloud-credential	4.10.0	True	False	False	40m
cluster-autoscaler	4.10.0	True	False	False	37m
config-operator	4.10.0	True	False	False	38m



console	4.10.0	True	False	False	26m
csi-snapshot-controller	4.10.0	True	False	False	37m
dns	4.10.0	True	False	False	37m
etcd	4.10.0	True	False	False	36m
image-registry	4.10.0	True	False	False	31m
ingress	4.10.0	True	False	False	30m
insights	4.10.0	True	False	False	31m
kube-apiserver	4.10.0	True	False	False	26m
kube-controller-manager	4.10.0	True	False	False	36m
kube-scheduler	4.10.0	True	False	False	36m
kube-storage-version-migrator	4.10.0	True	False	False	37m
machine-api	4.10.0	True	False	False	29m
machine-approver	4.10.0	True	False	False	37m
machine-config	4.10.0	True	False	False	36m
marketplace	4.10.0	True	False	False	37m
monitoring	4.10.0	True	False	False	29m
network	4.10.0	True	False	False	38m
node-tuning	4.10.0	True	False	False	37m
openshift-apiserver	4.10.0	True	False	False	32m
openshift-controller-manager	4.10.0	True	False	False	30m
openshift-samples	4.10.0	True	False	False	32m
operator-lifecycle-manager	4.10.0	True	False	False	37m
operator-lifecycle-manager-catalog	4.10.0	True	False	False	37m
operator-lifecycle-manager-packageserver	4.10.0	True	False	False	32m
service-ca	4.10.0	True	False	False	38m
storage	4.10.0	True	False	False	37m

2. Configure the Operators that are not available.

### Additional resources

- See [Gathering logs from a failed installation](#) for details about gathering data in the event of a failed OpenShift Container Platform installation.
- See [Troubleshooting Operator issues](#) for steps to check Operator pod health across the cluster and gather Operator logs for diagnosis.

#### 10.2.15.1. Image registry removed during installation

On platforms that do not provide shareable object storage, the OpenShift Image Registry Operator bootstraps itself as **Removed**. This allows **openshift-installer** to complete installations on these platform types.

After installation, you must edit the Image Registry Operator configuration to switch the **managementState** from **Removed** to **Managed**.

#### 10.2.15.2. Image registry storage configuration

The Image Registry Operator is not initially available for platforms that do not provide default storage. After installation, you must configure your registry to use storage so that the Registry Operator is made available.

Instructions are shown for configuring a persistent volume, which is required for production clusters. Where applicable, instructions are shown for configuring an empty directory as the storage location, which is available for only non-production clusters.

Additional instructions are provided for allowing the image registry to use block storage types by using the **Recreate** rollout strategy during upgrades.

### 10.2.15.2.1. Configuring registry storage for bare metal and other manual installations

As a cluster administrator, following installation you must configure your registry to use storage.

#### Prerequisites

- You have access to the cluster as a user with the **cluster-admin** role.
- You have a cluster that uses manually-provisioned Red Hat Enterprise Linux CoreOS (RHCOS) nodes, such as bare metal.
- You have provisioned persistent storage for your cluster, such as Red Hat OpenShift Data Foundation.

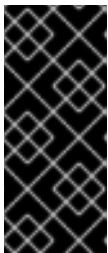

#### IMPORTANT

OpenShift Container Platform supports **ReadWriteOnce** access for image registry storage when you have only one replica. **ReadWriteOnce** access also requires that the registry uses the **Recreate** rollout strategy. To deploy an image registry that supports high availability with two or more replicas, **ReadWriteMany** access is required.

- Must have 100Gi capacity.

#### Procedure

1. To configure your registry to use storage, change the **spec.storage.pvc** in the **configs.imageregistry/cluster** resource.



#### NOTE

When using shared storage, review your security settings to prevent outside access.

2. Verify that you do not have a registry pod:

```
$ oc get pod -n openshift-image-registry -l docker-registry=default
```

#### Example output

```
No resources found in openshift-image-registry namespace
```



#### NOTE

If you do have a registry pod in your output, you do not need to continue with this procedure.

3. Check the registry configuration:

```
$ oc edit configs.imageregistry.operator.openshift.io
```

### Example output

```
storage:
  pvc:
    claim:
```

Leave the **claim** field blank to allow the automatic creation of an **image-registry-storage** PVC.

4. Check the **clusteroperator** status:

```
$ oc get clusteroperator image-registry
```

### Example output

NAME	VERSION	AVAILABLE	PROGRESSING	DEGRADED	SINCE
image-registry	4.10	True	False	False	6h50m

5. Ensure that your registry is set to managed to enable building and pushing of images.

- Run:

```
$ oc edit configs.imageregistry/cluster
```

Then, change the line

```
managementState: Removed
```

to

```
managementState: Managed
```

#### 10.2.15.2.2. Configuring storage for the image registry in non-production clusters

You must configure storage for the Image Registry Operator. For non-production clusters, you can set the image registry to an empty directory. If you do so, all images are lost if you restart the registry.

#### Procedure

- To set the image registry storage to an empty directory:

```
$ oc patch configs.imageregistry.operator.openshift.io cluster --type merge --patch '{"spec": {"storage":{"emptyDir":{}}}'
```

**WARNING**

Configure this option for only non-production clusters.

If you run this command before the Image Registry Operator initializes its components, the **oc patch** command fails with the following error:

```
Error from server (NotFound): configs.imageregistry.operator.openshift.io "cluster" not found
```

Wait a few minutes and run the command again.

**10.2.15.2.3. Configuring block registry storage**

To allow the image registry to use block storage types during upgrades as a cluster administrator, you can use the **Recreate** rollout strategy.

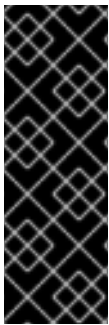
**IMPORTANT**

Block storage volumes, or block persistent volumes, are supported but not recommended for use with the image registry on production clusters. An installation where the registry is configured on block storage is not highly available because the registry cannot have more than one replica.

If you choose to use a block storage volume with the image registry, you must use a filesystem Persistent Volume Claim (PVC).

**Procedure**

1. To set the image registry storage as a block storage type, patch the registry so that it uses the **Recreate** rollout strategy and runs with only one ( **1** ) replica:

```
$ oc patch config.imageregistry.operator.openshift.io/cluster --type=merge -p '{"spec": {"rolloutStrategy": "Recreate", "replicas": 1}}'
```

2. Provision the PV for the block storage device, and create a PVC for that volume. The requested block volume uses the ReadWriteOnce (RWO) access mode.
3. Edit the registry configuration so that it references the correct PVC.

**10.2.16. Completing installation on user-provisioned infrastructure**

After you complete the Operator configuration, you can finish installing the cluster on infrastructure that you provide.

**Prerequisites**

- Your control plane has initialized.
- You have completed the initial Operator configuration.

## Procedure

1. Confirm that all the cluster components are online with the following command:

```
$ watch -n5 oc get clusteroperators
```

### Example output

NAME	VERSION	AVAILABLE	PROGRESSING	DEGRADED	SINCE
authentication	4.10.0	True	False	False	19m
baremetal	4.10.0	True	False	False	37m
cloud-credential	4.10.0	True	False	False	40m
cluster-autoscaler	4.10.0	True	False	False	37m
config-operator	4.10.0	True	False	False	38m
console	4.10.0	True	False	False	26m
csi-snapshot-controller	4.10.0	True	False	False	37m
dns	4.10.0	True	False	False	37m
etcd	4.10.0	True	False	False	36m
image-registry	4.10.0	True	False	False	31m
ingress	4.10.0	True	False	False	30m
insights	4.10.0	True	False	False	31m
kube-apiserver	4.10.0	True	False	False	26m
kube-controller-manager	4.10.0	True	False	False	36m
kube-scheduler	4.10.0	True	False	False	36m
kube-storage-version-migrator	4.10.0	True	False	False	37m
machine-api	4.10.0	True	False	False	29m
machine-approver	4.10.0	True	False	False	37m
machine-config	4.10.0	True	False	False	36m
marketplace	4.10.0	True	False	False	37m
monitoring	4.10.0	True	False	False	29m
network	4.10.0	True	False	False	38m
node-tuning	4.10.0	True	False	False	37m
openshift-apiserver	4.10.0	True	False	False	32m
openshift-controller-manager	4.10.0	True	False	False	30m
openshift-samples	4.10.0	True	False	False	32m
operator-lifecycle-manager	4.10.0	True	False	False	37m
operator-lifecycle-manager-catalog	4.10.0	True	False	False	37m
operator-lifecycle-manager-packageserver	4.10.0	True	False	False	32m
service-ca	4.10.0	True	False	False	38m
storage	4.10.0	True	False	False	37m

Alternatively, the following command notifies you when all of the clusters are available. It also retrieves and displays credentials:

```
$ ./openshift-install --dir <installation_directory> wait-for install-complete 1
```

- 1** For **<installation\_directory>**, specify the path to the directory that you stored the installation files in.

### Example output

```
INFO Waiting up to 30m0s for the cluster to initialize...
```

The command succeeds when the Cluster Version Operator finishes deploying the OpenShift Container Platform cluster from Kubernetes API server.



## IMPORTANT

- The Ignition config files that the installation program generates contain certificates that expire after 24 hours, which are then renewed at that time. If the cluster is shut down before renewing the certificates and the cluster is later restarted after the 24 hours have elapsed, the cluster automatically recovers the expired certificates. The exception is that you must manually approve the pending **node-bootstrapper** certificate signing requests (CSRs) to recover kubelet certificates. See the documentation for *Recovering from expired control plane certificates* for more information.
- It is recommended that you use Ignition config files within 12 hours after they are generated because the 24-hour certificate rotates from 16 to 22 hours after the cluster is installed. By using the Ignition config files within 12 hours, you can avoid installation failure if the certificate update runs during installation.

2. Confirm that the Kubernetes API server is communicating with the pods.

a. To view a list of all pods, use the following command:

```
$ oc get pods --all-namespaces
```

### Example output

```

NAMESPACE           NAME                                     READY  STATUS
RESTARTS  AGE
openshift-apiserver-operator  openshift-apiserver-operator-85cb746d55-zqhs8  1/1
Running   1    9m
openshift-apiserver          apiserver-67b9g                                1/1  Running  0
3m
openshift-apiserver          apiserver-ljcmx                                1/1  Running  0
1m
openshift-apiserver          apiserver-z25h4                                1/1  Running  0
2m
openshift-authentication-operator  authentication-operator-69d5d8bf84-vh2n8  1/1
Running   0    5m
...

```

b. View the logs for a pod that is listed in the output of the previous command by using the following command:

```
$ oc logs <pod_name> -n <namespace> 1
```

- 1** Specify the pod name and namespace, as shown in the output of the previous command.

If the pod logs display, the Kubernetes API server can communicate with the cluster machines.

3. For an installation with Fibre Channel Protocol (FCP), additional steps are required to enable multipathing. Do not enable multipathing during installation.  
See "Enabling multipathing with kernel arguments on RHCOS" in the *Post-installation machine configuration tasks* documentation for more information.

### 10.2.17. Telemetry access for OpenShift Container Platform

In OpenShift Container Platform 4.10, the Telemetry service, which runs by default to provide metrics about cluster health and the success of updates, requires internet access. If your cluster is connected to the internet, Telemetry runs automatically, and your cluster is registered to [OpenShift Cluster Manager](#).

After you confirm that your [OpenShift Cluster Manager](#) inventory is correct, either maintained automatically by Telemetry or manually by using OpenShift Cluster Manager, [use subscription watch](#) to track your OpenShift Container Platform subscriptions at the account or multi-cluster level.

#### Additional resources

- See [About remote health monitoring](#) for more information about the Telemetry service

### 10.2.18. Next steps

- [Validating an installation](#).
- [Customize your cluster](#).
- If necessary, you can [opt out of remote health reporting](#) .
- [Set up your registry and configure registry storage](#) .

## 10.3. INSTALLING A USER-PROVISIONED BARE METAL CLUSTER WITH NETWORK CUSTOMIZATIONS

In OpenShift Container Platform 4.10, you can install a cluster on bare metal infrastructure that you provision with customized network configuration options. By customizing your network configuration, your cluster can coexist with existing IP address allocations in your environment and integrate with existing MTU and VXLAN configurations.

When you customize OpenShift Container Platform networking, you must set most of the network configuration parameters during installation. You can modify only **kubeProxy** network configuration parameters in a running cluster.

### 10.3.1. Prerequisites

- You reviewed details about the [OpenShift Container Platform installation and update](#) processes.
- You read the documentation on [selecting a cluster installation method and preparing it for users](#).
- If you use a firewall and plan to use the Telemetry service, you [configured the firewall to allow the sites](#) that your cluster requires access to.

### 10.3.2. Internet access for OpenShift Container Platform

In OpenShift Container Platform 4.10, you require access to the internet to install your cluster.

You must have internet access to:

- Access [OpenShift Cluster Manager](#) to download the installation program and perform subscription management. If the cluster has internet access and you do not disable Telemetry, that service automatically entitles your cluster.
- Access [Quay.io](#) to obtain the packages that are required to install your cluster.
- Obtain the packages that are required to perform cluster updates.



### IMPORTANT

If your cluster cannot have direct internet access, you can perform a restricted network installation on some types of infrastructure that you provision. During that process, you download the required content and use it to populate a mirror registry with the installation packages. With some installation types, the environment that you install your cluster in will not require internet access. Before you update the cluster, you update the content of the mirror registry.

#### Additional resources

- See [Installing a user-provisioned bare metal cluster on a restricted network](#) for more information about performing a restricted network installation on bare metal infrastructure that you provision.

### 10.3.3. Requirements for a cluster with user-provisioned infrastructure

For a cluster that contains user-provisioned infrastructure, you must deploy all of the required machines.

This section describes the requirements for deploying OpenShift Container Platform on user-provisioned infrastructure.

#### 10.3.3.1. Required machines for cluster installation

The smallest OpenShift Container Platform clusters require the following hosts:

**Table 10.14. Minimum required hosts**

Hosts	Description
One temporary bootstrap machine	The cluster requires the bootstrap machine to deploy the OpenShift Container Platform cluster on the three control plane machines. You can remove the bootstrap machine after you install the cluster.
Three control plane machines	The control plane machines run the Kubernetes and OpenShift Container Platform services that form the control plane.
At least two compute machines, which are also known as worker machines.	The workloads requested by OpenShift Container Platform users run on the compute machines.



**NOTE**

As an exception, you can run zero compute machines in a bare metal cluster that consists of three control plane machines only. This provides smaller, more resource efficient clusters for cluster administrators and developers to use for testing, development, and production. Running one compute machine is not supported.

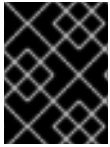
**IMPORTANT**

To maintain high availability of your cluster, use separate physical hosts for these cluster machines.

The bootstrap and control plane machines must use Red Hat Enterprise Linux CoreOS (RHCOS) as the operating system. However, the compute machines can choose between Red Hat Enterprise Linux CoreOS (RHCOS), Red Hat Enterprise Linux (RHEL) 8.4, or RHEL 8.5.

Note that RHCOS is based on Red Hat Enterprise Linux (RHEL) 8 and inherits all of its hardware certifications and requirements. See [Red Hat Enterprise Linux technology capabilities and limits](#).

### 10.3.3.2. Minimum resource requirements for cluster installation

Each cluster machine must meet the following minimum requirements:

**Table 10.15. Minimum resource requirements**

Machine	Operating System	CPU [1]	RAM	Storage	IOPS [2]
Bootstrap	RHCOS	4	16 GB	100 GB	300
Control plane	RHCOS	4	16 GB	100 GB	300
Compute	RHCOS, RHEL 8.4, or RHEL 8.5 [3]	2	8 GB	100 GB	300

1. One CPU is equivalent to one physical core when simultaneous multithreading (SMT), or hyperthreading, is not enabled. When enabled, use the following formula to calculate the corresponding ratio: (threads per core × cores) × sockets = CPUs.
2. OpenShift Container Platform and Kubernetes are sensitive to disk performance, and faster storage is recommended, particularly for etcd on the control plane nodes which require a 10 ms p99 fsync duration. Note that on many cloud platforms, storage size and IOPS scale together, so you might need to over-allocate storage volume to obtain sufficient performance.
3. As with all user-provisioned installations, if you choose to use RHEL compute machines in your cluster, you take responsibility for all operating system life cycle management and maintenance, including performing system updates, applying patches, and completing all other required tasks. Use of RHEL 7 compute machines is deprecated and has been removed in OpenShift Container Platform 4.10 and later.

If an instance type for your platform meets the minimum requirements for cluster machines, it is supported to use in OpenShift Container Platform.

### 10.3.3.3. Certificate signing requests management

Because your cluster has limited access to automatic machine management when you use infrastructure that you provision, you must provide a mechanism for approving cluster certificate signing requests (CSRs) after installation. The **kube-controller-manager** only approves the kubelet client CSRs. The **machine-approver** cannot guarantee the validity of a serving certificate that is requested by using kubelet credentials because it cannot confirm that the correct machine issued the request. You must determine and implement a method of verifying the validity of the kubelet serving certificate requests and approving them.

#### Additional resources

- See [Configuring a three-node cluster](#) for details about deploying three-node clusters in bare metal environments.
- See [Approving the certificate signing requests for your machines](#) for more information about approving cluster certificate signing requests after installation.

### 10.3.3.4. Networking requirements for user-provisioned infrastructure

All the Red Hat Enterprise Linux CoreOS (RHCOS) machines require networking to be configured in **inittamfs** during boot to fetch their Ignition config files.

During the initial boot, the machines require an IP address configuration that is set either through a DHCP server or statically by providing the required boot options. After a network connection is established, the machines download their Ignition config files from an HTTP or HTTPS server. The Ignition config files are then used to set the exact state of each machine. The Machine Config Operator completes more changes to the machines, such as the application of new certificates or keys, after installation.

It is recommended to use a DHCP server for long-term management of the cluster machines. Ensure that the DHCP server is configured to provide persistent IP addresses, DNS server information, and hostnames to the cluster machines.



#### NOTE

If a DHCP service is not available for your user-provisioned infrastructure, you can instead provide the IP networking configuration and the address of the DNS server to the nodes at RHCOS install time. These can be passed as boot arguments if you are installing from an ISO image. See the *Installing RHCOS and starting the OpenShift Container Platform bootstrap process* section for more information about static IP provisioning and advanced networking options.

The Kubernetes API server must be able to resolve the node names of the cluster machines. If the API servers and worker nodes are in different zones, you can configure a default DNS search zone to allow the API server to resolve the node names. Another supported approach is to always refer to hosts by their fully-qualified domain names in both the node objects and all DNS requests.

#### 10.3.3.4.1. Setting the cluster node hostnames through DHCP

On Red Hat Enterprise Linux CoreOS (RHCOS) machines, the hostname is set through NetworkManager. By default, the machines obtain their hostname through DHCP. If the hostname is not provided by DHCP, set statically through kernel arguments, or another method, it is obtained through a

reverse DNS lookup. Reverse DNS lookup occurs after the network has been initialized on a node and can take time to resolve. Other system services can start prior to this and detect the hostname as **localhost** or similar. You can avoid this by using DHCP to provide the hostname for each cluster node.

Additionally, setting the hostnames through DHCP can bypass any manual DNS record name configuration errors in environments that have a DNS split-horizon implementation.

#### 10.3.3.4.2. Network connectivity requirements

You must configure the network connectivity between machines to allow OpenShift Container Platform cluster components to communicate. Each machine must be able to resolve the hostnames of all other machines in the cluster.

This section provides details about the ports that are required.



#### IMPORTANT

In connected OpenShift Container Platform environments, all nodes are required to have internet access to pull images for platform containers and provide telemetry data to Red Hat.

Table 10.16. Ports used for all-machine to all-machine communications

Protocol	Port	Description
ICMP	N/A	Network reachability tests
TCP	<b>1936</b>	Metrics
	<b>9000-9999</b>	Host level services, including the node exporter on ports <b>9100-9101</b> and the Cluster Version Operator on port <b>9099</b> .
	<b>10250-10259</b>	The default ports that Kubernetes reserves
	<b>10256</b>	openshift-sdn
UDP	<b>4789</b>	VXLAN
	<b>6081</b>	Geneve
	<b>9000-9999</b>	Host level services, including the node exporter on ports <b>9100-9101</b> .
	<b>500</b>	IPsec IKE packets
	<b>4500</b>	IPsec NAT-T packets
TCP/UDP	<b>30000-32767</b>	Kubernetes node port
ESP	N/A	IPsec Encapsulating Security Payload (ESP)

Table 10.17. Ports used for all-machine to control plane communications

Protocol	Port	Description
TCP	<b>6443</b>	Kubernetes API

Table 10.18. Ports used for control plane machine to control plane machine communications

Protocol	Port	Description
TCP	<b>2379-2380</b>	etcd server and peer ports

### NTP configuration for user-provisioned infrastructure

OpenShift Container Platform clusters are configured to use a public Network Time Protocol (NTP) server by default. If you want to use a local enterprise NTP server, or if your cluster is being deployed in a disconnected network, you can configure the cluster to use a specific time server. For more information, see the documentation for *Configuring chrony time service*.

If a DHCP server provides NTP server information, the chrony time service on the Red Hat Enterprise Linux CoreOS (RHCOS) machines read the information and can sync the clock with the NTP servers.

### Additional resources

- [Configuring chrony time service](#)

### 10.3.3.5. User-provisioned DNS requirements

In OpenShift Container Platform deployments, DNS name resolution is required for the following components:

- The Kubernetes API
- The OpenShift Container Platform application wildcard
- The bootstrap, control plane, and compute machines

Reverse DNS resolution is also required for the Kubernetes API, the bootstrap machine, the control plane machines, and the compute machines.

DNS A/AAAA or CNAME records are used for name resolution and PTR records are used for reverse name resolution. The reverse records are important because Red Hat Enterprise Linux CoreOS (RHCOS) uses the reverse records to set the hostnames for all the nodes, unless the hostnames are provided by DHCP. Additionally, the reverse records are used to generate the certificate signing requests (CSR) that OpenShift Container Platform needs to operate.



#### NOTE

It is recommended to use a DHCP server to provide the hostnames to each cluster node. See the *DHCP recommendations for user-provisioned infrastructure* section for more information.

The following DNS records are required for a user-provisioned OpenShift Container Platform cluster

and they must be in place before installation. In each record, `<cluster_name>` is the cluster name and `<base_domain>` is the base domain that you specify in the `install-config.yaml` file. A complete DNS record takes the form: `<component>.<cluster_name>.<base_domain>.`

Table 10.19. Required DNS records

Component	Record	Description
Kubernetes API	<code>api.&lt;cluster_name&gt;.&lt;base_domain&gt;.</code>	A DNS A/AAAA or CNAME record, and a DNS PTR record, to identify the API load balancer. These records must be resolvable by both clients external to the cluster and from all the nodes within the cluster.
	<code>api-int.&lt;cluster_name&gt;.&lt;base_domain&gt;.</code>	<p>A DNS A/AAAA or CNAME record, and a DNS PTR record, to internally identify the API load balancer. These records must be resolvable from all the nodes within the cluster.</p> <div style="display: flex; align-items: flex-start;">  <div> <p><b>IMPORTANT</b></p> <p>The API server must be able to resolve the worker nodes by the hostnames that are recorded in Kubernetes. If the API server cannot resolve the node names, then proxied API calls can fail, and you cannot retrieve logs from pods.</p> </div> </div>
Routes	<code>*.apps.&lt;cluster_name&gt;.&lt;base_domain&gt;.</code>	<p>A wildcard DNS A/AAAA or CNAME record that refers to the application ingress load balancer. The application ingress load balancer targets the machines that run the Ingress Controller pods. The Ingress Controller pods run on the compute machines by default. These records must be resolvable by both clients external to the cluster and from all the nodes within the cluster.</p> <p>For example, <code>console-openshift-console.apps.&lt;cluster_name&gt;.&lt;base_domain&gt;</code> is used as a wildcard route to the OpenShift Container Platform console.</p>
Bootstrap machine	<code>bootstrap.&lt;cluster_name&gt;.&lt;base_domain&gt;.</code>	A DNS A/AAAA or CNAME record, and a DNS PTR record, to identify the bootstrap machine. These records must be resolvable by the nodes within the cluster.
Control plane machines	<code>&lt;master&gt;&lt;n&gt;.&lt;cluster_name&gt;.&lt;base_domain&gt;.</code>	DNS A/AAAA or CNAME records and DNS PTR records to identify each machine for the control plane nodes. These records must be resolvable by the nodes within the cluster.
Compute machines	<code>&lt;worker&gt;&lt;n&gt;.&lt;cluster_name&gt;.&lt;base_domain&gt;.</code>	DNS A/AAAA or CNAME records and DNS PTR records to identify each machine for the worker nodes. These records must be resolvable by the nodes within the cluster.

**NOTE**

In OpenShift Container Platform 4.4 and later, you do not need to specify etcd host and SRV records in your DNS configuration.

**TIP**

You can use the **dig** command to verify name and reverse name resolution. See the section on *Validating DNS resolution for user-provisioned infrastructure* for detailed validation steps.

**10.3.3.5.1. Example DNS configuration for user-provisioned clusters**

This section provides A and PTR record configuration samples that meet the DNS requirements for deploying OpenShift Container Platform on user-provisioned infrastructure. The samples are not meant to provide advice for choosing one DNS solution over another.

In the examples, the cluster name is **ocp4** and the base domain is **example.com**.

**Example DNS A record configuration for a user-provisioned cluster**

The following example is a BIND zone file that shows sample A records for name resolution in a user-provisioned cluster.

**Example 10.4. Sample DNS zone database**

```
$TTL 1W
@ IN SOA ns1.example.com. root (
    2019070700 ; serial
    3H ; refresh (3 hours)
    30M ; retry (30 minutes)
    2W ; expiry (2 weeks)
    1W ) ; minimum (1 week)
IN NS ns1.example.com.
IN MX 10 smtp.example.com.
;
;
ns1.example.com. IN A 192.168.1.5
smtp.example.com. IN A 192.168.1.5
;
helper.example.com. IN A 192.168.1.5
helper.ocp4.example.com. IN A 192.168.1.5
;
api.ocp4.example.com. IN A 192.168.1.5 1
api-int.ocp4.example.com. IN A 192.168.1.5 2
;
*.apps.ocp4.example.com. IN A 192.168.1.5 3
;
bootstrap.ocp4.example.com. IN A 192.168.1.96 4
;
master0.ocp4.example.com. IN A 192.168.1.97 5
master1.ocp4.example.com. IN A 192.168.1.98 6
master2.ocp4.example.com. IN A 192.168.1.99 7
;
worker0.ocp4.example.com. IN A 192.168.1.11 8
```

```
worker1.ocp4.example.com. IN A 192.168.1.7 9
```

```
;
;EOF
```

- 1 Provides name resolution for the Kubernetes API. The record refers to the IP address of the API load balancer.
- 2 Provides name resolution for the Kubernetes API. The record refers to the IP address of the API load balancer and is used for internal cluster communications.
- 3 Provides name resolution for the wildcard routes. The record refers to the IP address of the application ingress load balancer. The application ingress load balancer targets the machines that run the Ingress Controller pods. The Ingress Controller pods run on the compute machines by default.



#### NOTE

In the example, the same load balancer is used for the Kubernetes API and application ingress traffic. In production scenarios, you can deploy the API and application ingress load balancers separately so that you can scale the load balancer infrastructure for each in isolation.

- 4 Provides name resolution for the bootstrap machine.
- 5 6 7 Provides name resolution for the control plane machines.
- 8 9 Provides name resolution for the compute machines.

### Example DNS PTR record configuration for a user-provisioned cluster

The following example BIND zone file shows sample PTR records for reverse name resolution in a user-provisioned cluster.

#### Example 10.5. Sample DNS zone database for reverse records

```
$TTL 1W
@ IN SOA ns1.example.com. root (
  2019070700 ; serial
  3H ; refresh (3 hours)
  30M ; retry (30 minutes)
  2W ; expiry (2 weeks)
  1W ) ; minimum (1 week)
IN NS ns1.example.com.
;
5.1.168.192.in-addr.arpa. IN PTR api.ocp4.example.com. 1
5.1.168.192.in-addr.arpa. IN PTR api-int.ocp4.example.com. 2
;
96.1.168.192.in-addr.arpa. IN PTR bootstrap.ocp4.example.com. 3
;
97.1.168.192.in-addr.arpa. IN PTR master0.ocp4.example.com. 4
98.1.168.192.in-addr.arpa. IN PTR master1.ocp4.example.com. 5
99.1.168.192.in-addr.arpa. IN PTR master2.ocp4.example.com. 6
```

```

;
11.1.168.192.in-addr.arpa. IN PTR worker0.ocp4.example.com. 7
7.1.168.192.in-addr.arpa. IN PTR worker1.ocp4.example.com. 8
;
;EOF

```

- 1 Provides reverse DNS resolution for the Kubernetes API. The PTR record refers to the record name of the API load balancer.
- 2 Provides reverse DNS resolution for the Kubernetes API. The PTR record refers to the record name of the API load balancer and is used for internal cluster communications.
- 3 Provides reverse DNS resolution for the bootstrap machine.
- 4 5 6 Provides reverse DNS resolution for the control plane machines.
- 7 8 Provides reverse DNS resolution for the compute machines.



#### NOTE

A PTR record is not required for the OpenShift Container Platform application wildcard.

- [Validating DNS resolution for user-provisioned infrastructure](#)

### 10.3.3.6. Load balancing requirements for user-provisioned infrastructure

Before you install OpenShift Container Platform, you must provision the API and application ingress load balancing infrastructure. In production scenarios, you can deploy the API and application ingress load balancers separately so that you can scale the load balancer infrastructure for each in isolation.



#### NOTE

If you want to deploy the API and application Ingress load balancers with a Red Hat Enterprise Linux (RHEL) instance, you must purchase the RHEL subscription separately.

The load balancing infrastructure must meet the following requirements:

1. **API load balancer.** Provides a common endpoint for users, both human and machine, to interact with and configure the platform. Configure the following conditions:
  - Layer 4 load balancing only. This can be referred to as Raw TCP, SSL Passthrough, or SSL Bridge mode. If you use SSL Bridge mode, you must enable Server Name Indication (SNI) for the API routes.
  - A stateless load balancing algorithm. The options vary based on the load balancer implementation.



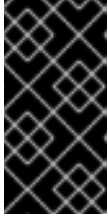

## IMPORTANT

Do not configure session persistence for an API load balancer. Configuring session persistence for a Kubernetes API server might cause performance issues from excess application traffic for your OpenShift Container Platform cluster and the Kubernetes API that runs inside the cluster.

Configure the following ports on both the front and back of the load balancers:

**Table 10.20. API load balancer**

Port	Back-end machines (pool members)	Internal	External	Description
<b>6443</b>	Bootstrap and control plane. You remove the bootstrap machine from the load balancer after the bootstrap machine initializes the cluster control plane. You must configure the <b>/readyz</b> endpoint for the API server health check probe.	X	X	Kubernetes API server
<b>22623</b>	Bootstrap and control plane. You remove the bootstrap machine from the load balancer after the bootstrap machine initializes the cluster control plane.	X		Machine config server



## NOTE

The load balancer must be configured to take a maximum of 30 seconds from the time the API server turns off the **/readyz** endpoint to the removal of the API server instance from the pool. Within the time frame after **/readyz** returns an error or becomes healthy, the endpoint must have been removed or added. Probing every 5 or 10 seconds, with two successful requests to become healthy and three to become unhealthy, are well-tested values.

2. **Application Ingress load balancer:** Provides an ingress point for application traffic flowing in from outside the cluster. A working configuration for the Ingress router is required for an OpenShift Container Platform cluster.

Configure the following conditions:

- Layer 4 load balancing only. This can be referred to as Raw TCP, SSL Passthrough, or SSL Bridge mode. If you use SSL Bridge mode, you must enable Server Name Indication (SNI) for the ingress routes.
- A connection-based or session-based persistence is recommended, based on the options available and types of applications that will be hosted on the platform.

## TIP

If the true IP address of the client can be seen by the application Ingress load balancer, enabling source IP-based session persistence can improve performance for applications that use end-to-end TLS encryption.

Configure the following ports on both the front and back of the load balancers:

**Table 10.21. Application Ingress load balancer**

Port	Back-end machines (pool members)	Internal	External	Description
<b>443</b>	The machines that run the Ingress Controller pods, compute, or worker, by default.	X	X	HTTPS traffic
<b>80</b>	The machines that run the Ingress Controller pods, compute, or worker, by default.	X	X	HTTP traffic



#### NOTE

If you are deploying a three-node cluster with zero compute nodes, the Ingress Controller pods run on the control plane nodes. In three-node cluster deployments, you must configure your application Ingress load balancer to route HTTP and HTTPS traffic to the control plane nodes.

#### 10.3.3.6.1. Example load balancer configuration for user-provisioned clusters

This section provides an example API and application ingress load balancer configuration that meets the load balancing requirements for user-provisioned clusters. The sample is an `/etc/haproxy/haproxy.cfg` configuration for an HAProxy load balancer. The example is not meant to provide advice for choosing one load balancing solution over another.

In the example, the same load balancer is used for the Kubernetes API and application ingress traffic. In production scenarios, you can deploy the API and application ingress load balancers separately so that you can scale the load balancer infrastructure for each in isolation.



#### NOTE

If you are using HAProxy as a load balancer and SELinux is set to **enforcing**, you must ensure that the HAProxy service can bind to the configured TCP port by running **setsebool -P haproxy\_connect\_any=1**.

#### Example 10.6. Sample API and application Ingress load balancer configuration

```
global
  log      127.0.0.1 local2
  pidfile  /var/run/haproxy.pid
  maxconn  4000
  daemon
defaults
  mode            http
  log             global
  option          dontlognull
  option http-server-close
  option          redispatch
  retries         3
  timeout http-request 10s
```

```

timeout queue      1m
timeout connect   10s
timeout client    1m
timeout server    1m
timeout http-keep-alive 10s
timeout check     10s
maxconn           3000
listen api-server-6443 1
bind *:6443
mode tcp
server bootstrap bootstrap.ocp4.example.com:6443 check inter 1s backup 2
server master0 master0.ocp4.example.com:6443 check inter 1s
server master1 master1.ocp4.example.com:6443 check inter 1s
server master2 master2.ocp4.example.com:6443 check inter 1s
listen machine-config-server-22623 3
bind *:22623
mode tcp
server bootstrap bootstrap.ocp4.example.com:22623 check inter 1s backup 4
server master0 master0.ocp4.example.com:22623 check inter 1s
server master1 master1.ocp4.example.com:22623 check inter 1s
server master2 master2.ocp4.example.com:22623 check inter 1s
listen ingress-router-443 5
bind *:443
mode tcp
balance source
server worker0 worker0.ocp4.example.com:443 check inter 1s
server worker1 worker1.ocp4.example.com:443 check inter 1s
listen ingress-router-80 6
bind *:80
mode tcp
balance source
server worker0 worker0.ocp4.example.com:80 check inter 1s
server worker1 worker1.ocp4.example.com:80 check inter 1s

```

- 1 Port **6443** handles the Kubernetes API traffic and points to the control plane machines.
- 2 4 The bootstrap entries must be in place before the OpenShift Container Platform cluster installation and they must be removed after the bootstrap process is complete.
- 3 Port **22623** handles the machine config server traffic and points to the control plane machines.
- 5 Port **443** handles the HTTPS traffic and points to the machines that run the Ingress Controller pods. The Ingress Controller pods run on the compute machines by default.
- 6 Port **80** handles the HTTP traffic and points to the machines that run the Ingress Controller pods. The Ingress Controller pods run on the compute machines by default.

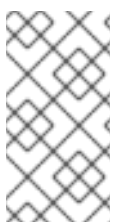

#### NOTE

If you are deploying a three-node cluster with zero compute nodes, the Ingress Controller pods run on the control plane nodes. In three-node cluster deployments, you must configure your application Ingress load balancer to route HTTP and HTTPS traffic to the control plane nodes.

-

## TIP

If you are using HAProxy as a load balancer, you can check that the **haproxy** process is listening on ports **6443**, **22623**, **443**, and **80** by running **netstat -nltp** on the HAProxy node.

### 10.3.4. Preparing the user-provisioned infrastructure

Before you install OpenShift Container Platform on user-provisioned infrastructure, you must prepare the underlying infrastructure.

This section provides details about the high-level steps required to set up your cluster infrastructure in preparation for an OpenShift Container Platform installation. This includes configuring IP networking and network connectivity for your cluster nodes, enabling the required ports through your firewall, and setting up the required DNS and load balancing infrastructure.

After preparation, your cluster infrastructure must meet the requirements outlined in the *Requirements for a cluster with user-provisioned infrastructure* section.

#### Prerequisites

- You have reviewed the [OpenShift Container Platform 4.x Tested Integrations](#) page.
- You have reviewed the infrastructure requirements detailed in the *Requirements for a cluster with user-provisioned infrastructure* section.

#### Procedure

1. If you are using DHCP to provide the IP networking configuration to your cluster nodes, configure your DHCP service.
  - a. Add persistent IP addresses for the nodes to your DHCP server configuration. In your configuration, match the MAC address of the relevant network interface to the intended IP address for each node.
  - b. When you use DHCP to configure IP addressing for the cluster machines, the machines also obtain the DNS server information through DHCP. Define the persistent DNS server address that is used by the cluster nodes through your DHCP server configuration.



#### NOTE

If you are not using a DHCP service, you must provide the IP networking configuration and the address of the DNS server to the nodes at RHCOS install time. These can be passed as boot arguments if you are installing from an ISO image. See the *Installing RHCOS and starting the OpenShift Container Platform bootstrap process* section for more information about static IP provisioning and advanced networking options.

- c. Define the hostnames of your cluster nodes in your DHCP server configuration. See the *Setting the cluster node hostnames through DHCP* section for details about hostname considerations.

**NOTE**

If you are not using a DHCP service, the cluster nodes obtain their hostname through a reverse DNS lookup.

2. Ensure that your network infrastructure provides the required network connectivity between the cluster components. See the *Networking requirements for user-provisioned infrastructure* section for details about the requirements.
3. Configure your firewall to enable the ports required for the OpenShift Container Platform cluster components to communicate. See *Networking requirements for user-provisioned infrastructure* section for details about the ports that are required.

**IMPORTANT**

By default, port **1936** is accessible for an OpenShift Container Platform cluster, because each control plane node needs access to this port.

Avoid using the Ingress load balancer to expose this port, because doing so might result in the exposure of sensitive information, such as statistics and metrics, related to Ingress Controllers.

4. Setup the required DNS infrastructure for your cluster.
  - a. Configure DNS name resolution for the Kubernetes API, the application wildcard, the bootstrap machine, the control plane machines, and the compute machines.
  - b. Configure reverse DNS resolution for the Kubernetes API, the bootstrap machine, the control plane machines, and the compute machines.  
See the *User-provisioned DNS requirements* section for more information about the OpenShift Container Platform DNS requirements.
5. Validate your DNS configuration.
  - a. From your installation node, run DNS lookups against the record names of the Kubernetes API, the wildcard routes, and the cluster nodes. Validate that the IP addresses in the responses correspond to the correct components.
  - b. From your installation node, run reverse DNS lookups against the IP addresses of the load balancer and the cluster nodes. Validate that the record names in the responses correspond to the correct components.  
See the *Validating DNS resolution for user-provisioned infrastructure* section for detailed DNS validation steps.
6. Provision the required API and application ingress load balancing infrastructure. See the *Load balancing requirements for user-provisioned infrastructure* section for more information about the requirements.

**NOTE**

Some load balancing solutions require the DNS name resolution for the cluster nodes to be in place before the load balancing is initialized.

**Additional resources**

- [Requirements for a cluster with user-provisioned infrastructure](#)
- [Installing RHCOS and starting the OpenShift Container Platform bootstrap process](#)
- [Setting the cluster node hostnames through DHCP](#)
- [Advanced RHCOS installation configuration](#)
- [Networking requirements for user-provisioned infrastructure](#)
- [User-provisioned DNS requirements](#)
- [Validating DNS resolution for user-provisioned infrastructure](#)
- [Load balancing requirements for user-provisioned infrastructure](#)

### 10.3.5. Validating DNS resolution for user-provisioned infrastructure

You can validate your DNS configuration before installing OpenShift Container Platform on user-provisioned infrastructure.

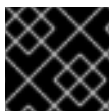

#### IMPORTANT

The validation steps detailed in this section must succeed before you install your cluster.

#### Prerequisites

- You have configured the required DNS records for your user-provisioned infrastructure.

#### Procedure

1. From your installation node, run DNS lookups against the record names of the Kubernetes API, the wildcard routes, and the cluster nodes. Validate that the IP addresses contained in the responses correspond to the correct components.
  - a. Perform a lookup against the Kubernetes API record name. Check that the result points to the IP address of the API load balancer:

```
$ dig +noall +answer @<nameserver_ip> api.<cluster_name>.<base_domain> 1
```

- 1** Replace **<nameserver\_ip>** with the IP address of the nameserver, **<cluster\_name>** with your cluster name, and **<base\_domain>** with your base domain name.

#### Example output

```
api.ocp4.example.com. 0 IN A 192.168.1.5
```

- b. Perform a lookup against the Kubernetes internal API record name. Check that the result points to the IP address of the API load balancer:

```
$ dig +noall +answer @<nameserver_ip> api-int.<cluster_name>.<base_domain>
```

#### Example output

```
api-int.ocp4.example.com. 0 IN A 192.168.1.5
```

- c. Test an example `*.apps.<cluster_name>.<base_domain>` DNS wildcard lookup. All of the application wildcard lookups must resolve to the IP address of the application ingress load balancer:

```
$ dig +noall +answer @<nameserver_ip> random.apps.<cluster_name>.<base_domain>
```

### Example output

```
random.apps.ocp4.example.com. 0 IN A 192.168.1.5
```



### NOTE

In the example outputs, the same load balancer is used for the Kubernetes API and application ingress traffic. In production scenarios, you can deploy the API and application ingress load balancers separately so that you can scale the load balancer infrastructure for each in isolation.

You can replace **random** with another wildcard value. For example, you can query the route to the OpenShift Container Platform console:

```
$ dig +noall +answer @<nameserver_ip> console-openshift-console.apps.<cluster_name>.<base_domain>
```

### Example output

```
console-openshift-console.apps.ocp4.example.com. 0 IN A 192.168.1.5
```

- d. Run a lookup against the bootstrap DNS record name. Check that the result points to the IP address of the bootstrap node:

```
$ dig +noall +answer @<nameserver_ip> bootstrap.<cluster_name>.<base_domain>
```

### Example output

```
bootstrap.ocp4.example.com. 0 IN A 192.168.1.96
```

- e. Use this method to perform lookups against the DNS record names for the control plane and compute nodes. Check that the results correspond to the IP addresses of each node.
2. From your installation node, run reverse DNS lookups against the IP addresses of the load balancer and the cluster nodes. Validate that the record names contained in the responses correspond to the correct components.
- a. Perform a reverse lookup against the IP address of the API load balancer. Check that the response includes the record names for the Kubernetes API and the Kubernetes internal API:

```
$ dig +noall +answer @<nameserver_ip> -x 192.168.1.5
```

### Example output

```
5.1.168.192.in-addr.arpa. 0 IN PTR api-int.ocp4.example.com. 1
5.1.168.192.in-addr.arpa. 0 IN PTR api.ocp4.example.com. 2
```

- 1 Provides the record name for the Kubernetes internal API.
- 2 Provides the record name for the Kubernetes API.



### NOTE

A PTR record is not required for the OpenShift Container Platform application wildcard. No validation step is needed for reverse DNS resolution against the IP address of the application ingress load balancer.

- b. Perform a reverse lookup against the IP address of the bootstrap node. Check that the result points to the DNS record name of the bootstrap node:

```
$ dig +noall +answer @<nameserver_ip> -x 192.168.1.96
```

### Example output

```
96.1.168.192.in-addr.arpa. 0 IN PTR bootstrap.ocp4.example.com.
```

- c. Use this method to perform reverse lookups against the IP addresses for the control plane and compute nodes. Check that the results correspond to the DNS record names of each node.

### Additional resources

- [User-provisioned DNS requirements](#)
- [Load balancing requirements for user-provisioned infrastructure](#)

## 10.3.6. Generating a key pair for cluster node SSH access

During an OpenShift Container Platform installation, you can provide an SSH public key to the installation program. The key is passed to the Red Hat Enterprise Linux CoreOS (RHCOS) nodes through their Ignition config files and is used to authenticate SSH access to the nodes. The key is added to the `~/.ssh/authorized_keys` list for the **core** user on each node, which enables password-less authentication.

After the key is passed to the nodes, you can use the key pair to SSH in to the RHCOS nodes as the user **core**. To access the nodes through SSH, the private key identity must be managed by SSH for your local user.

If you want to SSH in to your cluster nodes to perform installation debugging or disaster recovery, you must provide the SSH public key during the installation process. The `./openshift-install gather` command also requires the SSH public key to be in place on the cluster nodes.



**IMPORTANT**

Do not skip this procedure in production environments, where disaster recovery and debugging is required.

**NOTE**

You must use a local key, not one that you configured with platform-specific approaches such as [AWS key pairs](#).

**Procedure**

1. If you do not have an existing SSH key pair on your local machine to use for authentication onto your cluster nodes, create one. For example, on a computer that uses a Linux operating system, run the following command:

```
$ ssh-keygen -t ed25519 -N "" -f <path>/<file_name> 1
```

- 1 Specify the path and file name, such as `~/.ssh/id_ed25519`, of the new SSH key. If you have an existing key pair, ensure your public key is in the your `~/.ssh` directory.

**NOTE**

If you plan to install an OpenShift Container Platform cluster that uses FIPS validated or Modules In Process cryptographic libraries on the **x86\_64** architecture, do not create a key that uses the **ed25519** algorithm. Instead, create a key that uses the **rsa** or **ecdsa** algorithm.

2. View the public SSH key:

```
$ cat <path>/<file_name>.pub
```

For example, run the following to view the `~/.ssh/id_ed25519.pub` public key:

```
$ cat ~/.ssh/id_ed25519.pub
```

3. Add the SSH private key identity to the SSH agent for your local user, if it has not already been added. SSH agent management of the key is required for password-less SSH authentication onto your cluster nodes, or if you want to use the `./openshift-install gather` command.

**NOTE**

On some distributions, default SSH private key identities such as `~/.ssh/id_rsa` and `~/.ssh/id_dsa` are managed automatically.

- a. If the **ssh-agent** process is not already running for your local user, start it as a background task:

```
$ eval "$(ssh-agent -s)"
```

**Example output**

Agent pid 31874



#### NOTE

If your cluster is in FIPS mode, only use FIPS-compliant algorithms to generate the SSH key. The key must be either RSA or ECDSA.

4. Add your SSH private key to the **ssh-agent**:

```
$ ssh-add <path>/<file_name> 1
```

- 1** Specify the path and file name for your SSH private key, such as `~/.ssh/id_ed25519`

#### Example output

```
Identity added: /home/<you>/<path>/<file_name> (<computer_name>)
```

#### Next steps

- When you install OpenShift Container Platform, provide the SSH public key to the installation program.

#### Additional resources

- [Verifying node health](#)

### 10.3.7. Obtaining the installation program

Before you install OpenShift Container Platform, download the installation file on a local computer.

#### Prerequisites

- You have a computer that runs Linux or macOS, with 500 MB of local disk space

#### Procedure

1. Access the [Infrastructure Provider](#) page on the OpenShift Cluster Manager site. If you have a Red Hat account, log in with your credentials. If you do not, create an account.
2. Select your infrastructure provider.
3. Navigate to the page for your installation type, download the installation program that corresponds with your host operating system and architecture, and place the file in the directory where you will store the installation configuration files.



#### IMPORTANT

The installation program creates several files on the computer that you use to install your cluster. You must keep the installation program and the files that the installation program creates after you finish installing the cluster. Both files are required to delete the cluster.

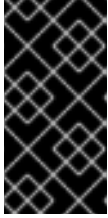

## IMPORTANT

Deleting the files created by the installation program does not remove your cluster, even if the cluster failed during installation. To remove your cluster, complete the OpenShift Container Platform uninstallation procedures for your specific cloud provider.

4. Extract the installation program. For example, on a computer that uses a Linux operating system, run the following command:

```
$ tar -xvf openshift-install-linux.tar.gz
```

5. Download your installation [pull secret from the Red Hat OpenShift Cluster Manager](#). This pull secret allows you to authenticate with the services that are provided by the included authorities, including Quay.io, which serves the container images for OpenShift Container Platform components.

### 10.3.8. Installing the OpenShift CLI by downloading the binary

You can install the OpenShift CLI (**oc**) to interact with OpenShift Container Platform from a command-line interface. You can install **oc** on Linux, Windows, or macOS.

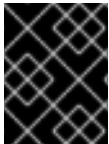

## IMPORTANT

If you installed an earlier version of **oc**, you cannot use it to complete all of the commands in OpenShift Container Platform 4.10. Download and install the new version of **oc**.

#### Installing the OpenShift CLI on Linux

You can install the OpenShift CLI (**oc**) binary on Linux by using the following procedure.

#### Procedure

1. Navigate to the [OpenShift Container Platform downloads page](#) on the Red Hat Customer Portal.
2. Select the appropriate version in the **Version** drop-down menu.
3. Click **Download Now** next to the **OpenShift v4.10 Linux Client** entry and save the file.
4. Unpack the archive:

```
$ tar xvf <file>
```

5. Place the **oc** binary in a directory that is on your **PATH**. To check your **PATH**, execute the following command:

```
$ echo $PATH
```

After you install the OpenShift CLI, it is available using the **oc** command:

```
$ oc <command>
```

#### Installing the OpenShift CLI on Windows

You can install the OpenShift CLI (**oc**) binary on Windows by using the following procedure.

### Procedure

1. Navigate to the [OpenShift Container Platform downloads page](#) on the Red Hat Customer Portal.
2. Select the appropriate version in the **Version** drop-down menu.
3. Click **Download Now** next to the **OpenShift v4.10 Windows Client** entry and save the file.
4. Unzip the archive with a ZIP program.
5. Move the **oc** binary to a directory that is on your **PATH**.  
To check your **PATH**, open the command prompt and execute the following command:

```
C:\> path
```

After you install the OpenShift CLI, it is available using the **oc** command:

```
C:\> oc <command>
```

### Installing the OpenShift CLI on macOS

You can install the OpenShift CLI (**oc**) binary on macOS by using the following procedure.

### Procedure

1. Navigate to the [OpenShift Container Platform downloads page](#) on the Red Hat Customer Portal.
2. Select the appropriate version in the **Version** drop-down menu.
3. Click **Download Now** next to the **OpenShift v4.10 MacOSX Client** entry and save the file.
4. Unpack and unzip the archive.
5. Move the **oc** binary to a directory on your **PATH**.  
To check your **PATH**, open a terminal and execute the following command:

```
$ echo $PATH
```

After you install the OpenShift CLI, it is available using the **oc** command:

```
$ oc <command>
```

## 10.3.9. Manually creating the installation configuration file

For user-provisioned installations of OpenShift Container Platform, you manually generate your installation configuration file.

### Prerequisites

- You have an SSH public key on your local machine to provide to the installation program. The key will be used for SSH authentication onto your cluster nodes for debugging and disaster recovery.
- You have obtained the OpenShift Container Platform installation program and the pull secret for your cluster.

## Procedure

1. Create an installation directory to store your required installation assets in:

```
$ mkdir <installation_directory>
```

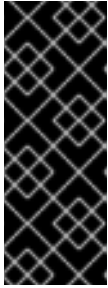

### IMPORTANT

You must create a directory. Some installation assets, like bootstrap X.509 certificates have short expiration intervals, so you must not reuse an installation directory. If you want to reuse individual files from another cluster installation, you can copy them into your directory. However, the file names for the installation assets might change between releases. Use caution when copying installation files from an earlier OpenShift Container Platform version.

2. Customize the sample **install-config.yaml** file template that is provided and save it in the **<installation\_directory>**.



### NOTE

You must name this configuration file **install-config.yaml**.



### NOTE

For some platform types, you can alternatively run **./openshift-install create install-config --dir <installation\_directory>** to generate an **install-config.yaml** file. You can provide details about your cluster configuration at the prompts.

3. Back up the **install-config.yaml** file so that you can use it to install multiple clusters.



### IMPORTANT

The **install-config.yaml** file is consumed during the next step of the installation process. You must back it up now.

## 10.3.9.1. Installation configuration parameters

Before you deploy an OpenShift Container Platform cluster, you provide a customized **install-config.yaml** installation configuration file that describes the details for your environment.



### NOTE

After installation, you cannot modify these parameters in the **install-config.yaml** file.

### 10.3.9.1.1. Required configuration parameters

Required installation configuration parameters are described in the following table:

**Table 10.22. Required parameters**

Parameter	Description	Values
<b>apiVersion</b>	The API version for the <b>install-config.yaml</b> content. The current version is <b>v1</b> . The installer may also support older API versions.	String
<b>baseDomain</b>	The base domain of your cloud provider. The base domain is used to create routes to your OpenShift Container Platform cluster components. The full DNS name for your cluster is a combination of the <b>baseDomain</b> and <b>metadata.name</b> parameter values that uses the <b>&lt;metadata.name&gt;</b> . <b>&lt;baseDomain&gt;</b> format.	A fully-qualified domain or subdomain name, such as <b>example.com</b> .
<b>metadata</b>	Kubernetes resource <b>ObjectMeta</b> , from which only the <b>name</b> parameter is consumed.	Object
<b>metadata.name</b>	The name of the cluster. DNS records for the cluster are all subdomains of <b>{{.metadata.name}}</b> . <b>{{.baseDomain}}</b> .	String of lowercase letters and hyphens (-), such as <b>dev</b> .
<b>platform</b>	The configuration for the specific platform upon which to perform the installation: <b>alibabacloud</b> , <b>aws</b> , <b>baremetal</b> , <b>azure</b> , <b>gcp</b> , <b>ibmcloud</b> , <b>openstack</b> , <b>ovirt</b> , <b>vsphere</b> , or <b>{}</b> . For additional information about <b>platform.&lt;platform&gt;</b> parameters, consult the table for your specific platform that follows.	Object

Parameter	Description	Values
<b>pullSecret</b>	Get a <a href="#">pull secret from the Red Hat OpenShift Cluster Manager</a> to authenticate downloading container images for OpenShift Container Platform components from services such as Quay.io.	<pre>{   "auths":{     "cloud.openshift.com":{       "auth":"b3Blb=",       "email":"you@example.com"     },     "quay.io":{       "auth":"b3Blb=",       "email":"you@example.com"     }   } }</pre>

### 10.3.9.1.2. Network configuration parameters

You can customize your installation configuration based on the requirements of your existing network infrastructure. For example, you can expand the IP address block for the cluster network or provide different IP address blocks than the defaults.

Only IPv4 addresses are supported.

Table 10.23. Network parameters

Parameter	Description	Values
<b>networking</b>	The configuration for the cluster network.	Object <div style="display: flex; align-items: center; margin-top: 10px;">  <div> <p><b>NOTE</b></p> <p>You cannot modify parameters specified by the <b>networking</b> object after installation.</p> </div> </div>
<b>networking.network Type</b>	The cluster network provider Container Network Interface (CNI) plugin to install.	Either <b>OpenShiftSDN</b> or <b>OVNKubernetes</b> . <b>OpenShiftSDN</b> is a CNI provider for all-Linux networks. <b>OVNKubernetes</b> is a CNI provider for Linux networks and hybrid networks that contain both Linux and Windows servers. The default value is <b>OpenShiftSDN</b> .

Parameter	Description	Values
<b>networking.clusterNetwork</b>	<p>The IP address blocks for pods.</p> <p>The default value is <b>10.128.0.0/14</b> with a host prefix of <b>/23</b>.</p> <p>If you specify multiple IP address blocks, the blocks must not overlap.</p>	<p>An array of objects. For example:</p> <pre>networking:   clusterNetwork:     - cidr: 10.128.0.0/14       hostPrefix: 23</pre>
<b>networking.clusterNetwork.cidr</b>	<p>Required if you use <b>networking.clusterNetwork</b>. An IP address block.</p> <p>An IPv4 network.</p>	<p>An IP address block in Classless Inter-Domain Routing (CIDR) notation. The prefix length for an IPv4 block is between <b>0</b> and <b>32</b>.</p>
<b>networking.clusterNetwork.hostPrefix</b>	<p>The subnet prefix length to assign to each individual node. For example, if <b>hostPrefix</b> is set to <b>23</b> then each node is assigned a <b>/23</b> subnet out of the given <b>cidr</b>. A <b>hostPrefix</b> value of <b>23</b> provides 510 (<math>2^{(32 - 23)} - 2</math>) pod IP addresses.</p>	<p>A subnet prefix.</p> <p>The default value is <b>23</b>.</p>
<b>networking.serviceNetwork</b>	<p>The IP address block for services. The default value is <b>172.30.0.0/16</b>.</p> <p>The OpenShift SDN and OVN-Kubernetes network providers support only a single IP address block for the service network.</p>	<p>An array with an IP address block in CIDR format. For example:</p> <pre>networking:   serviceNetwork:     - 172.30.0.0/16</pre>
<b>networking.machineNetwork</b>	<p>The IP address blocks for machines.</p> <p>If you specify multiple IP address blocks, the blocks must not overlap.</p>	<p>An array of objects. For example:</p> <pre>networking:   machineNetwork:     - cidr: 10.0.0.0/16</pre>
<b>networking.machineNetwork.cidr</b>	<p>Required if you use <b>networking.machineNetwork</b>. An IP address block. The default value is <b>10.0.0.0/16</b> for all platforms other than libvirt. For libvirt, the default value is <b>192.168.126.0/24</b>.</p>	<p>An IP network block in CIDR notation.</p> <p>For example, <b>10.0.0.0/16</b>.</p> <div style="display: flex; align-items: flex-start;">  <div> <p><b>NOTE</b></p> <p>Set the <b>networking.machineNetwork</b> to match the CIDR that the preferred NIC resides in.</p> </div> </div>





## 10.3.9.1.3. Optional configuration parameters

Optional installation configuration parameters are described in the following table:



Table 10.24. Optional parameters

Parameter	Description	Values
<b>additionalTrustBundle</b>	A PEM-encoded X.509 certificate bundle that is added to the nodes' trusted certificate store. This trust bundle may also be used when a proxy has been configured.	String
<b>cgroupsV2</b>	Enables <a href="#">Linux control groups version 2</a> (cgroups v2) on specific nodes in your cluster. The OpenShift Container Platform process for enabling cgroups v2 disables all cgroup version 1 controllers and hierarchies. The OpenShift Container Platform cgroups version 2 feature is in Developer Preview and is not supported by Red Hat at this time.	<b>true</b>
<b>compute</b>	The configuration for the machines that comprise the compute nodes.	Array of <b>MachinePool</b> objects.
<b>compute.architecture</b>	Determines the instruction set architecture of the machines in the pool. Currently, clusters with varied architectures are not supported. All pools must specify the same architecture. Valid values are <b>amd64</b> and <b>arm64</b> .	String
<b>compute.hyperthreading</b>	Whether to enable or disable simultaneous multithreading, or <b>hyperthreading</b> , on compute machines. By default, simultaneous multithreading is enabled to increase the performance of your machines' cores.	<b>Enabled</b> or <b>Disabled</b>
	 <p><b>IMPORTANT</b></p> <p>If you disable simultaneous multithreading, ensure that your capacity planning accounts for the dramatically decreased machine performance.</p>	

Parameter	Description	Values
<b>compute.name</b>	Required if you use <b>compute</b> . The name of the machine pool.	<b>worker</b>
<b>compute.platform</b>	Required if you use <b>compute</b> . Use this parameter to specify the cloud provider to host the worker machines. This parameter value must match the <b>controlPlane.platform</b> parameter value.	<b>alibabacloud, aws, azure, gcp, ibmcloud, openstack, ovirt, vsphere</b> , or <b>{}</b>
<b>compute.replicas</b>	The number of compute machines, which are also known as worker machines, to provision.	A positive integer greater than or equal to <b>2</b> . The default value is <b>3</b> .
<b>controlPlane</b>	The configuration for the machines that comprise the control plane.	Array of <b>MachinePool</b> objects.
<b>controlPlane.architecture</b>	Determines the instruction set architecture of the machines in the pool. Currently, clusters with varied architectures are not supported. All pools must specify the same architecture. Valid values are <b>amd64</b> and <b>arm64</b> .	String
<b>controlPlane.hyperthreading</b>	<p>Whether to enable or disable simultaneous multithreading, or <b>hyperthreading</b>, on control plane machines. By default, simultaneous multithreading is enabled to increase the performance of your machines' cores.</p> <div style="display: flex; align-items: center;">  <div> <p><b>IMPORTANT</b></p> <p>If you disable simultaneous multithreading, ensure that your capacity planning accounts for the dramatically decreased machine performance.</p> </div> </div>	<b>Enabled</b> or <b>Disabled</b>
<b>controlPlane.name</b>	Required if you use <b>controlPlane</b> . The name of the machine pool.	<b>master</b>

Parameter	Description	Values
<b>controlPlane.platform</b>	Required if you use <b>controlPlane</b> . Use this parameter to specify the cloud provider that hosts the control plane machines. This parameter value must match the <b>compute.platform</b> parameter value.	<b>alibabacloud, aws, azure, gcp, ibmcloud, openstack, ovirt, vsphere</b> , or {}
<b>controlPlane.replicas</b>	The number of control plane machines to provision.	The only supported value is <b>3</b> , which is the default value.
<b>credentialsMode</b>	<p>The Cloud Credential Operator (CCO) mode. If no mode is specified, the CCO dynamically tries to determine the capabilities of the provided credentials, with a preference for mint mode on the platforms where multiple modes are supported.</p> <div style="display: flex; align-items: flex-start;"> <div style="width: 2em; height: 2em; border: 1px solid black; margin-right: 1em;">  </div> <div> <p><b>NOTE</b></p> <p>Not all CCO modes are supported for all cloud providers. For more information on CCO modes, see the <i>Cloud Credential Operator</i> entry in the <i>Cluster Operators reference</i> content.</p> </div> </div> <div style="display: flex; align-items: flex-start; margin-top: 1em;"> <div style="width: 2em; height: 2em; border: 1px solid black; margin-right: 1em;">  </div> <div> <p><b>NOTE</b></p> <p>If your AWS account has service control policies (SCP) enabled, you must configure the <b>credentialsMode</b> parameter to <b>Mint</b>, <b>Passthrough</b> or <b>Manual</b>.</p> </div> </div>	<b>Mint, Passthrough, Manual</b> or an empty string ("").

Parameter	Description	Values
<b>fips</b>	<p>Enable or disable FIPS mode. The default is <b>false</b> (disabled). If FIPS mode is enabled, the Red Hat Enterprise Linux CoreOS (RHCOS) machines that OpenShift Container Platform runs on bypass the default Kubernetes cryptography suite and use the cryptography modules that are provided with RHCOS instead.</p> <div data-bbox="488 584 593 1361" style="background-color: black; color: white; padding: 5px; margin-bottom: 10px;"> <p><b>IMPORTANT</b></p> <p>To enable FIPS mode for your cluster, you must run the installation program from a Red Hat Enterprise Linux (RHEL) computer configured to operate in FIPS mode. For more information about configuring FIPS mode on RHEL, see <a href="#">Installing the system in FIPS mode</a>. The use of FIPS validated or Modules In Process cryptographic libraries is only supported on OpenShift Container Platform deployments on the <b>x86_64</b> architecture.</p> </div> <div data-bbox="488 1408 593 1603" style="background-color: black; color: white; padding: 5px;"> <p><b>NOTE</b></p> <p>If you are using Azure File storage, you cannot enable FIPS mode.</p> </div>	<b>false</b> or <b>true</b>

Parameter	Description	Values
<b>imageContentSources</b>	Sources and repositories for the release-image content.	Array of objects. Includes a <b>source</b> and, optionally, <b>mirrors</b> , as described in the following rows of this table.
<b>imageContentSources.source</b>	Required if you use <b>imageContentSources</b> . Specify the repository that users refer to, for example, in image pull specifications.	String
<b>imageContentSources.mirrors</b>	Specify one or more repositories that may also contain the same images.	Array of strings
<b>publish</b>	How to publish or expose the user-facing endpoints of your cluster, such as the Kubernetes API, OpenShift routes.	<p><b>Internal</b> or <b>External</b>. The default value is <b>External</b>.</p> <p>Setting this field to <b>Internal</b> is not supported on non-cloud platforms and IBM Cloud VPC.</p> <div style="display: flex; align-items: flex-start;">  <div> <p><b>IMPORTANT</b></p> <p>If the value of the field is set to <b>Internal</b>, the cluster will become non-functional. For more information, refer to <a href="#">BZ#1953035</a>.</p> </div> </div>
<b>sshKey</b>	<p>The SSH key or keys to authenticate access your cluster machines.</p> <div style="display: flex; align-items: flex-start;">  <div> <p><b>NOTE</b></p> <p>For production OpenShift Container Platform clusters on which you want to perform installation debugging or disaster recovery, specify an SSH key that your <b>ssh-agent</b> process uses.</p> </div> </div>	<p>One or more keys. For example:</p> <pre>sshKey:   &lt;key1&gt;   &lt;key2&gt;   &lt;key3&gt;</pre>

### 10.3.9.2. Sample install-config.yaml file for bare metal

You can customize the **install-config.yaml** file to specify more details about your OpenShift Container Platform cluster's platform or modify the values of the required parameters.

```

apiVersion: v1
baseDomain: example.com 1
compute: 2
- hyperthreading: Enabled 3
  name: worker
  replicas: 0 4
controlPlane: 5
  hyperthreading: Enabled 6
  name: master
  replicas: 3 7
metadata:
  name: test 8
networking:
  clusterNetwork:
  - cidr: 10.128.0.0/14 9
    hostPrefix: 23 10
  networkType: OpenShiftSDN
  serviceNetwork: 11
  - 172.30.0.0/16
platform:
  none: {} 12
fips: false 13
pullSecret: '{"auths": ...}' 14
sshKey: 'ssh-ed25519 AAAA...' 15

```

- 1 The base domain of the cluster. All DNS records must be sub-domains of this base and include the cluster name.
- 2 5 The **controlPlane** section is a single mapping, but the **compute** section is a sequence of mappings. To meet the requirements of the different data structures, the first line of the **compute** section must begin with a hyphen, -, and the first line of the **controlPlane** section must not. Only one control plane pool is used.
- 3 6 Specifies whether to enable or disable simultaneous multithreading (SMT), or hyperthreading. By default, SMT is enabled to increase the performance of the cores in your machines. You can disable it by setting the parameter value to **Disabled**. If you disable SMT, you must disable it in all cluster machines; this includes both control plane and compute machines.



#### NOTE

Simultaneous multithreading (SMT) is enabled by default. If SMT is not enabled in your BIOS settings, the **hyperthreading** parameter has no effect.



#### IMPORTANT

If you disable **hyperthreading**, whether in the BIOS or in the **install-config.yaml** file, ensure that your capacity planning accounts for the dramatically decreased machine performance.

- 4 You must set this value to **0** when you install OpenShift Container Platform on user-provisioned infrastructure. In installer-provisioned installations, the parameter controls the number of compute

infrastructure. In installer-provisioned installations, the parameter controls the number of compute machines that the cluster creates and manages for you. In user-provisioned installations, you must manually deploy the compute machines before you finish installing the cluster.



#### NOTE

If you are installing a three-node cluster, do not deploy any compute machines when you install the Red Hat Enterprise Linux CoreOS (RHCOS) machines.

- 7 The number of control plane machines that you add to the cluster. Because the cluster uses these values as the number of etcd endpoints in the cluster, the value must match the number of control plane machines that you deploy.
- 8 The cluster name that you specified in your DNS records.
- 9 A block of IP addresses from which pod IP addresses are allocated. This block must not overlap with existing physical networks. These IP addresses are used for the pod network. If you need to access the pods from an external network, you must configure load balancers and routers to manage the traffic.

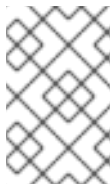

#### NOTE

Class E CIDR range is reserved for a future use. To use the Class E CIDR range, you must ensure your networking environment accepts the IP addresses within the Class E CIDR range.

- 10 The subnet prefix length to assign to each individual node. For example, if **hostPrefix** is set to **23**, then each node is assigned a **/23** subnet out of the given **cidr**, which allows for 510 ( $2^{(32 - 23)} - 2$ ) pod IP addresses. If you are required to provide access to nodes from an external network, configure load balancers and routers to manage the traffic.
- 11 The IP address pool to use for service IP addresses. You can enter only one IP address pool. This block must not overlap with existing physical networks. If you need to access the services from an external network, configure load balancers and routers to manage the traffic.
- 12 You must set the platform to **none**. You cannot provide additional platform configuration variables for your platform.



#### IMPORTANT

Clusters that are installed with the platform type **none** are unable to use some features, such as managing compute machines with the Machine API. This limitation applies even if the compute machines that are attached to the cluster are installed on a platform that would normally support the feature. This parameter cannot be changed after installation.

- 13 Whether to enable or disable FIPS mode. By default, FIPS mode is not enabled. If FIPS mode is enabled, the Red Hat Enterprise Linux CoreOS (RHCOS) machines that OpenShift Container Platform runs on bypass the default Kubernetes cryptography suite and use the cryptography modules that are provided with RHCOS instead.



### IMPORTANT

To enable FIPS mode for your cluster, you must run the installation program from a Red Hat Enterprise Linux (RHEL) computer configured to operate in FIPS mode. For more information about configuring FIPS mode on RHEL, see [Installing the system in FIPS mode](#). The use of FIPS validated or Modules In Process cryptographic libraries is only supported on OpenShift Container Platform deployments on the **x86\_64** architecture.

- 14 The [pull secret from the Red Hat OpenShift Cluster Manager](#) . This pull secret allows you to authenticate with the services that are provided by the included authorities, including Quay.io, which serves the container images for OpenShift Container Platform components.
- 15 The SSH public key for the **core** user in Red Hat Enterprise Linux CoreOS (RHCOS).



### NOTE

For production OpenShift Container Platform clusters on which you want to perform installation debugging or disaster recovery, specify an SSH key that your **ssh-agent** process uses.

#### Additional resources

- See [Load balancing requirements for user-provisioned infrastructure](#) for more information on the API and application ingress load balancing requirements.

### 10.3.10. Network configuration phases

There are two phases prior to OpenShift Container Platform installation where you can customize the network configuration.

#### Phase 1

You can customize the following network-related fields in the **install-config.yaml** file before you create the manifest files:

- **networking.networkType**
- **networking.clusterNetwork**
- **networking.serviceNetwork**
- **networking.machineNetwork**

For more information on these fields, refer to *Installation configuration parameters*.



### NOTE

Set the **networking.machineNetwork** to match the CIDR that the preferred NIC resides in.





## IMPORTANT

The CIDR range **172.17.0.0/16** is reserved by libVirt. You cannot use this range or any range that overlaps with this range for any networks in your cluster.

### Phase 2

After creating the manifest files by running **openshift-install create manifests**, you can define a customized Cluster Network Operator manifest with only the fields you want to modify. You can use the manifest to specify advanced network configuration.

You cannot override the values specified in phase 1 in the **install-config.yaml** file during phase 2. However, you can further customize the cluster network provider during phase 2.

### 10.3.11. Specifying advanced network configuration

You can use advanced network configuration for your cluster network provider to integrate your cluster into your existing network environment. You can specify advanced network configuration only before you install the cluster.



## IMPORTANT

Customizing your network configuration by modifying the OpenShift Container Platform manifest files created by the installation program is not supported. Applying a manifest file that you create, as in the following procedure, is supported.

### Prerequisites

- You have created the **install-config.yaml** file and completed any modifications to it.

### Procedure

1. Change to the directory that contains the installation program and create the manifests:

```
$ ./openshift-install create manifests --dir <installation_directory> 1
```

- 1 **<installation\_directory>** specifies the name of the directory that contains the **install-config.yaml** file for your cluster.

2. Create a stub manifest file for the advanced network configuration that is named **cluster-network-03-config.yml** in the **<installation\_directory>/manifests/** directory:

```
apiVersion: operator.openshift.io/v1
kind: Network
metadata:
  name: cluster
spec:
```

3. Specify the advanced network configuration for your cluster in the **cluster-network-03-config.yml** file, such as in the following examples:

**Specify a different VXLAN port for the OpenShift SDN network provider**

```

apiVersion: operator.openshift.io/v1
kind: Network
metadata:
  name: cluster
spec:
  defaultNetwork:
    openshiftSDNConfig:
      vxlanPort: 4800

```

### Enable IPsec for the OVN-Kubernetes network provider

```

apiVersion: operator.openshift.io/v1
kind: Network
metadata:
  name: cluster
spec:
  defaultNetwork:
    ovnKubernetesConfig:
      ipsecConfig: {}

```

- Optional: Back up the **manifests/cluster-network-03-config.yml** file. The installation program consumes the **manifests/** directory when you create the Ignition config files.

## 10.3.12. Cluster Network Operator configuration

The configuration for the cluster network is specified as part of the Cluster Network Operator (CNO) configuration and stored in a custom resource (CR) object that is named **cluster**. The CR specifies the fields for the **Network** API in the **operator.openshift.io** API group.

The CNO configuration inherits the following fields during cluster installation from the **Network** API in the **Network.config.openshift.io** API group and these fields cannot be changed:

### **clusterNetwork**

IP address pools from which pod IP addresses are allocated.

### **serviceNetwork**

IP address pool for services.

### **defaultNetwork.type**

Cluster network provider, such as OpenShift SDN or OVN-Kubernetes.

You can specify the cluster network provider configuration for your cluster by setting the fields for the **defaultNetwork** object in the CNO object named **cluster**.

### 10.3.12.1. Cluster Network Operator configuration object

The fields for the Cluster Network Operator (CNO) are described in the following table:

**Table 10.25. Cluster Network Operator configuration object**

Field	Type	Description
<b>metadata.name</b>	<b>string</b>	The name of the CNO object. This name is always <b>cluster</b> .

Field	Type	Description
<b>spec.clusterNetwork</b>	<b>array</b>	<p>A list specifying the blocks of IP addresses from which pod IP addresses are allocated and the subnet prefix length assigned to each individual node in the cluster. For example:</p> <pre>spec:   clusterNetwork:   - cidr: 10.128.0.0/19     hostPrefix: 23   - cidr: 10.128.32.0/19     hostPrefix: 23</pre> <p>You can customize this field only in the <b>install-config.yaml</b> file before you create the manifests. The value is read-only in the manifest file.</p>
<b>spec.serviceNetwork</b>	<b>array</b>	<p>A block of IP addresses for services. The OpenShift SDN and OVN-Kubernetes Container Network Interface (CNI) network providers support only a single IP address block for the service network. For example:</p> <pre>spec:   serviceNetwork:   - 172.30.0.0/14</pre> <p>You can customize this field only in the <b>install-config.yaml</b> file before you create the manifests. The value is read-only in the manifest file.</p>
<b>spec.defaultNetwork</b>	<b>object</b>	Configures the Container Network Interface (CNI) cluster network provider for the cluster network.
<b>spec.kubeProxyConfig</b>	<b>object</b>	The fields for this object specify the kube-proxy configuration. If you are using the OVN-Kubernetes cluster network provider, the kube-proxy configuration has no effect.

### defaultNetwork object configuration

The values for the **defaultNetwork** object are defined in the following table:

Table 10.26. **defaultNetwork** object

Field	Type	Description
-------	------	-------------

Field	Type	Description
<b>type</b>	<b>string</b>	<p>Either <b>OpenShiftSDN</b> or <b>OVNKubernetes</b>. The cluster network provider is selected during installation. This value cannot be changed after cluster installation.</p> <div style="display: flex; align-items: flex-start;"> <div style="flex: 1;">  </div> <div style="flex: 2;"> <p><b>NOTE</b></p> <p>OpenShift Container Platform uses the OpenShift SDN Container Network Interface (CNI) cluster network provider by default.</p> </div> </div>
<b>openshiftSDNConfig</b>	<b>object</b>	This object is only valid for the OpenShift SDN cluster network provider.
<b>ovnKubernetesConfig</b>	<b>object</b>	This object is only valid for the OVN-Kubernetes cluster network provider.

### Configuration for the OpenShift SDN CNI cluster network provider

The following table describes the configuration fields for the OpenShift SDN Container Network Interface (CNI) cluster network provider.

**Table 10.27. openshiftSDNConfig object**

Field	Type	Description
<b>mode</b>	<b>string</b>	<p>Configures the network isolation mode for OpenShift SDN. The default value is <b>NetworkPolicy</b>.</p> <p>The values <b>Multitenant</b> and <b>Subnet</b> are available for backwards compatibility with OpenShift Container Platform 3.x but are not recommended. This value cannot be changed after cluster installation.</p>

Field	Type	Description
<b>mtu</b>	<b>integer</b>	<p>The maximum transmission unit (MTU) for the VXLAN overlay network. This is detected automatically based on the MTU of the primary network interface. You do not normally need to override the detected MTU.</p> <p>If the auto-detected value is not what you expect it to be, confirm that the MTU on the primary network interface on your nodes is correct. You cannot use this option to change the MTU value of the primary network interface on the nodes.</p> <p>If your cluster requires different MTU values for different nodes, you must set this value to <b>50</b> less than the lowest MTU value in your cluster. For example, if some nodes in your cluster have an MTU of <b>9001</b>, and some have an MTU of <b>1500</b>, you must set this value to <b>1450</b>.</p> <p>This value cannot be changed after cluster installation.</p>
<b>vxlanPort</b>	<b>integer</b>	<p>The port to use for all VXLAN packets. The default value is <b>4789</b>. This value cannot be changed after cluster installation.</p> <p>If you are running in a virtualized environment with existing nodes that are part of another VXLAN network, then you might be required to change this. For example, when running an OpenShift SDN overlay on top of VMware NSX-T, you must select an alternate port for the VXLAN, because both SDNs use the same default VXLAN port number.</p> <p>On Amazon Web Services (AWS), you can select an alternate port for the VXLAN between port <b>9000</b> and port <b>9999</b>.</p>

### Example OpenShift SDN configuration

```
defaultNetwork:
  type: OpenShiftSDN
  openshiftSDNConfig:
    mode: NetworkPolicy
    mtu: 1450
    vxlanPort: 4789
```

### Configuration for the OVN-Kubernetes CNI cluster network provider

The following table describes the configuration fields for the OVN-Kubernetes CNI cluster network provider.

**Table 10.28. ovnKubernetesConfig object**

Field	Type	Description
-------	------	-------------

Field	Type	Description
<b>mtu</b>	<b>integer</b>	<p>The maximum transmission unit (MTU) for the Geneve (Generic Network Virtualization Encapsulation) overlay network. This is detected automatically based on the MTU of the primary network interface. You do not normally need to override the detected MTU.</p> <p>If the auto-detected value is not what you expect it to be, confirm that the MTU on the primary network interface on your nodes is correct. You cannot use this option to change the MTU value of the primary network interface on the nodes.</p> <p>If your cluster requires different MTU values for different nodes, you must set this value to <b>100</b> less than the lowest MTU value in your cluster. For example, if some nodes in your cluster have an MTU of <b>9001</b>, and some have an MTU of <b>1500</b>, you must set this value to <b>1400</b>.</p>
<b>genevePort</b>	<b>integer</b>	The port to use for all Geneve packets. The default value is <b>6081</b> . This value cannot be changed after cluster installation.
<b>ipsecConfig</b>	<b>object</b>	Specify an empty object to enable IPsec encryption. This value cannot be changed after cluster installation.
<b>policyAuditConfig</b>	<b>object</b>	Specify a configuration object for customizing network policy audit logging. If unset, the defaults audit log settings are used.
<b>gatewayConfig</b>	<b>object</b>	<p>Optional: Specify a configuration object for customizing how egress traffic is sent to the node gateway.</p> <div style="display: flex; align-items: flex-start;">  <div> <p><b>NOTE</b></p> <p>While migrating egress traffic, you can expect some disruption to workloads and service traffic until the Cluster Network Operator (CNO) successfully rolls out the changes.</p> </div> </div>

Table 10.29. **policyAuditConfig** object

Field	Type	Description
<b>rateLimit</b>	integer	The maximum number of messages to generate every second per node. The default value is <b>20</b> messages per second.
<b>maxFileSize</b>	integer	The maximum size for the audit log in bytes. The default value is <b>50000000</b> or 50 MB.

Field	Type	Description
<b>destination</b>	string	<p>One of the following additional audit log targets:</p> <p><b>libc</b> The libc <b>syslog()</b> function of the journald process on the host.</p> <p><b>udp:&lt;host&gt;:&lt;port&gt;</b> A syslog server. Replace <b>&lt;host&gt;:&lt;port&gt;</b> with the host and port of the syslog server.</p> <p><b>unix:&lt;file&gt;</b> A Unix Domain Socket file specified by <b>&lt;file&gt;</b>.</p> <p><b>null</b> Do not send the audit logs to any additional target.</p>
<b>syslogFacility</b>	string	The syslog facility, such as <b>kern</b> , as defined by RFC5424. The default value is <b>local0</b> .

Table 10.30. gatewayConfig object

Field	Type	Description
<b>routingViaHost</b>	<b>boolean</b>	<p>Set this field to <b>true</b> to send egress traffic from pods to the host networking stack. For highly-specialized installations and applications that rely on manually configured routes in the kernel routing table, you might want to route egress traffic to the host networking stack. By default, egress traffic is processed in OVN to exit the cluster and is not affected by specialized routes in the kernel routing table. The default value is <b>false</b>.</p> <p>This field has an interaction with the Open vSwitch hardware offloading feature. If you set this field to <b>true</b>, you do not receive the performance benefits of the offloading because egress traffic is processed by the host networking stack.</p>

### Example OVN-Kubernetes configuration with IPsec enabled

```

defaultNetwork:
  type: OVNKubernetes
  ovnKubernetesConfig:
    mtu: 1400
    genevePort: 6081
    ipsecConfig: {}

```

### kubeProxyConfig object configuration

The values for the **kubeProxyConfig** object are defined in the following table:

Table 10.31. kubeProxyConfig object

Field	Type	Description
<b>iptablesSyncPeriod</b>	<b>string</b>	<p>The refresh period for <b>iptables</b> rules. The default value is <b>30s</b>. Valid suffixes include <b>s</b>, <b>m</b>, and <b>h</b> and are described in the <a href="#">Go time package</a> documentation.</p> <div style="display: flex; align-items: flex-start;">  <div> <p><b>NOTE</b></p> <p>Because of performance improvements introduced in OpenShift Container Platform 4.3 and greater, adjusting the <b>iptablesSyncPeriod</b> parameter is no longer necessary.</p> </div> </div>
<b>proxyArguments.iptables-min-sync-period</b>	<b>array</b>	<p>The minimum duration before refreshing <b>iptables</b> rules. This field ensures that the refresh does not happen too frequently. Valid suffixes include <b>s</b>, <b>m</b>, and <b>h</b> and are described in the <a href="#">Go time package</a>. The default value is:</p> <pre>kubeProxyConfig:   proxyArguments:     iptables-min-sync-period:       - 0s</pre>

### 10.3.13. Creating the Ignition config files

Because you must manually start the cluster machines, you must generate the Ignition config files that the cluster needs to make its machines.



#### IMPORTANT

- The Ignition config files that the installation program generates contain certificates that expire after 24 hours, which are then renewed at that time. If the cluster is shut down before renewing the certificates and the cluster is later restarted after the 24 hours have elapsed, the cluster automatically recovers the expired certificates. The exception is that you must manually approve the pending **node-bootstrapper** certificate signing requests (CSRs) to recover kubelet certificates. See the documentation for *Recovering from expired control plane certificates* for more information.
- It is recommended that you use Ignition config files within 12 hours after they are generated because the 24-hour certificate rotates from 16 to 22 hours after the cluster is installed. By using the Ignition config files within 12 hours, you can avoid installation failure if the certificate update runs during installation.

#### Prerequisites

- Obtain the OpenShift Container Platform installation program and the pull secret for your cluster.



## Procedure

- Obtain the Ignition config files:

```
$ ./openshift-install create ignition-configs --dir <installation_directory> 1
```

- 1 For **<installation\_directory>**, specify the directory name to store the files that the installation program creates.

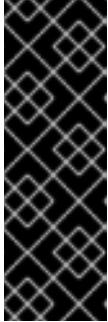

### IMPORTANT

If you created an **install-config.yaml** file, specify the directory that contains it. Otherwise, specify an empty directory. Some installation assets, like bootstrap X.509 certificates have short expiration intervals, so you must not reuse an installation directory. If you want to reuse individual files from another cluster installation, you can copy them into your directory. However, the file names for the installation assets might change between releases. Use caution when copying installation files from an earlier OpenShift Container Platform version.

The following files are generated in the directory:

```
.
├── auth
│   ├── kubeadmin-password
│   └── kubeconfig
├── bootstrap.ign
├── master.ign
├── metadata.json
└── worker.ign
```

### 10.3.14. Installing RHCOS and starting the OpenShift Container Platform bootstrap process

To install OpenShift Container Platform on bare metal infrastructure that you provision, you must install Red Hat Enterprise Linux CoreOS (RHCOS) on the machines. When you install RHCOS, you must provide the Ignition config file that was generated by the OpenShift Container Platform installation program for the type of machine you are installing. If you have configured suitable networking, DNS, and load balancing infrastructure, the OpenShift Container Platform bootstrap process begins automatically after the RHCOS machines have rebooted.

To install RHCOS on the machines, follow either the steps to use an ISO image or network PXE booting.



### NOTE

The compute node deployment steps included in this installation document are RHCOS-specific. If you choose instead to deploy RHEL-based compute nodes, you take responsibility for all operating system life cycle management and maintenance, including performing system updates, applying patches, and completing all other required tasks. Only RHEL 8 compute machines are supported.

You can configure RHCOS during ISO and PXE installations by using the following methods:

- **Kernel arguments:** You can use kernel arguments to provide installation-specific information. For example, you can specify the locations of the RHCOS installation files that you uploaded to your HTTP server and the location of the Ignition config file for the type of node you are installing. For a PXE installation, you can use the **APPEND** parameter to pass the arguments to the kernel of the live installer. For an ISO installation, you can interrupt the live installation boot process to add the kernel arguments. In both installation cases, you can use special **coreos.inst.\*** arguments to direct the live installer, as well as standard installation boot arguments for turning standard kernel services on or off.
- **Ignition configs:** OpenShift Container Platform Ignition config files (**\*.ign**) are specific to the type of node you are installing. You pass the location of a bootstrap, control plane, or compute node Ignition config file during the RHCOS installation so that it takes effect on first boot. In special cases, you can create a separate, limited Ignition config to pass to the live system. That Ignition config could do a certain set of tasks, such as reporting success to a provisioning system after completing installation. This special Ignition config is consumed by the **coreos-installer** to be applied on first boot of the installed system. Do not provide the standard control plane and compute node Ignition configs to the live ISO directly.
- **coreos-installer:** You can boot the live ISO installer to a shell prompt, which allows you to prepare the permanent system in a variety of ways before first boot. In particular, you can run the **coreos-installer** command to identify various artifacts to include, work with disk partitions, and set up networking. In some cases, you can configure features on the live system and copy them to the installed system.

Whether to use an ISO or PXE install depends on your situation. A PXE install requires an available DHCP service and more preparation, but can make the installation process more automated. An ISO install is a more manual process and can be inconvenient if you are setting up more than a few machines.



#### NOTE

As of OpenShift Container Platform 4.6, the RHCOS ISO and other installation artifacts provide support for installation on disks with 4K sectors.

### 10.3.14.1. Installing RHCOS by using an ISO image

You can use an ISO image to install RHCOS on the machines.

#### Prerequisites

- You have created the Ignition config files for your cluster.
- You have configured suitable network, DNS and load balancing infrastructure.
- You have an HTTP server that can be accessed from your computer, and from the machines that you create.
- You have reviewed the *Advanced RHCOS installation configuration* section for different ways to configure features, such as networking and disk partitioning.

#### Procedure

1. Obtain the SHA512 digest for each of your Ignition config files. For example, you can use the following on a system running Linux to get the SHA512 digest for your **bootstrap.ign** Ignition config file:

```
$ sha512sum <installation_directory>/bootstrap.ign
```

The digests are provided to the **coreos-installer** in a later step to validate the authenticity of the Ignition config files on the cluster nodes.

2. Upload the bootstrap, control plane, and compute node Ignition config files that the installation program created to your HTTP server. Note the URLs of these files.

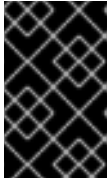

### IMPORTANT

You can add or change configuration settings in your Ignition configs before saving them to your HTTP server. If you plan to add more compute machines to your cluster after you finish installation, do not delete these files.

3. From the installation host, validate that the Ignition config files are available on the URLs. The following example gets the Ignition config file for the bootstrap node:

```
$ curl -k http://<HTTP_server>/bootstrap.ign 1
```

### Example output

```
% Total % Received % Xferd Average Speed Time Time Time Current
          Dload Upload Total Spent Left Speed
 0  0  0  0  0  0  0  0  --:--:-- --:--:-- --:--:-- 0{"ignition":
{"version":"3.2.0"},"passwd":{"users":[{"name":"core","sshAuthorizedKeys":["ssh-rsa...
```

Replace **bootstrap.ign** with **master.ign** or **worker.ign** in the command to validate that the Ignition config files for the control plane and compute nodes are also available.

4. Although it is possible to obtain the RHCOS images that are required for your preferred method of installing operating system instances from the [RHCOS image mirror](#) page, the recommended way to obtain the correct version of your RHCOS images are from the output of **openshift-install** command:

```
$ openshift-install coreos print-stream-json | grep '\.iso[^\.]'
```

### Example output

```
"location": "<url>/art/storage/releases/rhcos-4.10-aarch64/<release>/aarch64/rhcos-
<release>-live.aarch64.iso",
"location": "<url>/art/storage/releases/rhcos-4.10-ppc64le/<release>/ppc64le/rhcos-
<release>-live.ppc64le.iso",
"location": "<url>/art/storage/releases/rhcos-4.10-s390x/<release>/s390x/rhcos-<release>-
live.s390x.iso",
"location": "<url>/art/storage/releases/rhcos-4.10/<release>/x86_64/rhcos-<release>-
live.x86_64.iso",
```

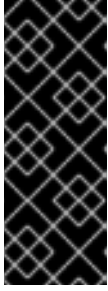

## IMPORTANT

The RHCOS images might not change with every release of OpenShift Container Platform. You must download images with the highest version that is less than or equal to the OpenShift Container Platform version that you install. Use the image versions that match your OpenShift Container Platform version if they are available. Use only ISO images for this procedure. RHCOS qcow2 images are not supported for this installation type.

ISO file names resemble the following example:

**rhcos-<version>-live.<architecture>.iso**

5. Use the ISO to start the RHCOS installation. Use one of the following installation options:
  - Burn the ISO image to a disk and boot it directly.
  - Use ISO redirection by using a lights-out management (LOM) interface.
6. Boot the RHCOS ISO image without specifying any options or interrupting the live boot sequence. Wait for the installer to boot into a shell prompt in the RHCOS live environment.



## NOTE

It is possible to interrupt the RHCOS installation boot process to add kernel arguments. However, for this ISO procedure you should use the **coreos-installer** command as outlined in the following steps, instead of adding kernel arguments.

7. Run the **coreos-installer** command and specify the options that meet your installation requirements. At a minimum, you must specify the URL that points to the Ignition config file for the node type, and the device that you are installing to:

```
$ sudo coreos-installer install --ignition-url=http://<HTTP_server>/<node_type>.ign <device>
--ignition-hash=sha512-<digest> 1 2
```

- 1** You must run the **coreos-installer** command by using **sudo**, because the **core** user does not have the required root privileges to perform the installation.
- 2** The **--ignition-hash** option is required when the Ignition config file is obtained through an HTTP URL to validate the authenticity of the Ignition config file on the cluster node. **<digest>** is the Ignition config file SHA512 digest obtained in a preceding step.



## NOTE

If you want to provide your Ignition config files through an HTTPS server that uses TLS, you can add the internal certificate authority (CA) to the system trust store before running **coreos-installer**.

The following example initializes a bootstrap node installation to the **/dev/sda** device. The Ignition config file for the bootstrap node is obtained from an HTTP web server with the IP address 192.168.1.2:

```
$ sudo coreos-installer install --ignition-
```

```
url=http://192.168.1.2:80/installation_directory/bootstrap.ign /dev/sda --ignition-hash=sha512-
a5a2d43879223273c9b60af66b44202a1d1248fc01cf156c46d4a79f552b6bad47bc8cc78ddf011
6e80c59d2ea9e32ba53bc807afbca581aa059311def2c3e3b
```

- Monitor the progress of the RHCOS installation on the console of the machine.



### IMPORTANT

Be sure that the installation is successful on each node before commencing with the OpenShift Container Platform installation. Observing the installation process can also help to determine the cause of RHCOS installation issues that might arise.

- After RHCOS installs, you must reboot the system. During the system reboot, it applies the Ignition config file that you specified.
- Check the console output to verify that Ignition ran.

### Example command

```
Ignition: ran on 2022/03/14 14:48:33 UTC (this boot)
Ignition: user-provided config was applied
```

- Continue to create the other machines for your cluster.



### IMPORTANT

You must create the bootstrap and control plane machines at this time. If the control plane machines are not made schedulable, also create at least two compute machines before you install OpenShift Container Platform.

If the required network, DNS, and load balancer infrastructure are in place, the OpenShift Container Platform bootstrap process begins automatically after the RHCOS nodes have rebooted.



### NOTE

RHCOS nodes do not include a default password for the **core** user. You can access the nodes by running **ssh core@<node>.<cluster\_name>.<base\_domain>** as a user with access to the SSH private key that is paired to the public key that you specified in your **install\_config.yaml** file. OpenShift Container Platform 4 cluster nodes running RHCOS are immutable and rely on Operators to apply cluster changes. Accessing cluster nodes by using SSH is not recommended. However, when investigating installation issues, if the OpenShift Container Platform API is not available, or the kubelet is not properly functioning on a target node, SSH access might be required for debugging or disaster recovery.

#### 10.3.14.2. Installing RHCOS by using PXE or iPXE booting

You can use PXE or iPXE booting to install RHCOS on the machines.

#### Prerequisites

- You have created the Ignition config files for your cluster.
- You have configured suitable network, DNS and load balancing infrastructure.
- You have configured suitable PXE or iPXE infrastructure.
- You have an HTTP server that can be accessed from your computer, and from the machines that you create.
- You have reviewed the *Advanced RHCOS installation configuration* section for different ways to configure features, such as networking and disk partitioning.

## Procedure

1. Upload the bootstrap, control plane, and compute node Ignition config files that the installation program created to your HTTP server. Note the URLs of these files.

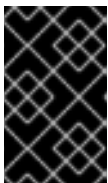

### IMPORTANT

You can add or change configuration settings in your Ignition configs before saving them to your HTTP server. If you plan to add more compute machines to your cluster after you finish installation, do not delete these files.

2. From the installation host, validate that the Ignition config files are available on the URLs. The following example gets the Ignition config file for the bootstrap node:

```
$ curl -k http://<HTTP_server>/bootstrap.ign 1
```

### Example output

```
% Total    % Received % Xferd Average Speed   Time    Time     Time  Current
           Dload  Upload   Total   Spent    Left  Speed
  0  0  0    0    0    0    0    0  --:--:-- --:--:-- --:--:--    0{"ignition":
{"version":"3.2.0"},"passwd":{"users":[{"name":"core","sshAuthorizedKeys":["ssh-rsa...
```

Replace **bootstrap.ign** with **master.ign** or **worker.ign** in the command to validate that the Ignition config files for the control plane and compute nodes are also available.

3. Although it is possible to obtain the RHCOS **kernel**, **initramfs** and **rootfs** files that are required for your preferred method of installing operating system instances from the [RHCOS image mirror](#) page, the recommended way to obtain the correct version of your RHCOS files are from the output of **openshift-install** command:

```
$ openshift-install coreos print-stream-json | grep -Eo "https.*(kernel-|initramfs-|rootfs-)|w+(\.img)?"
```

### Example output

```
"<url>/art/storage/releases/rhcos-4.10-aarch64/<release>/aarch64/rhcos-<release>-live-kernel-aarch64"
"<url>/art/storage/releases/rhcos-4.10-aarch64/<release>/aarch64/rhcos-<release>-live-initramfs.aarch64.img"
"<url>/art/storage/releases/rhcos-4.10-aarch64/<release>/aarch64/rhcos-<release>-live-
```

```

rootfs.aarch64.img"
"<url>/art/storage/releases/rhcos-4.10-ppc64le/49.84.202110081256-0/ppc64le/rhcos-
<release>-live-kernel-ppc64le"
"<url>/art/storage/releases/rhcos-4.10-ppc64le/<release>/ppc64le/rhcos-<release>-live-
initramfs.ppc64le.img"
"<url>/art/storage/releases/rhcos-4.10-ppc64le/<release>/ppc64le/rhcos-<release>-live-
rootfs.ppc64le.img"
"<url>/art/storage/releases/rhcos-4.10-s390x/<release>/s390x/rhcos-<release>-live-kernel-
s390x"
"<url>/art/storage/releases/rhcos-4.10-s390x/<release>/s390x/rhcos-<release>-live-
initramfs.s390x.img"
"<url>/art/storage/releases/rhcos-4.10-s390x/<release>/s390x/rhcos-<release>-live-
rootfs.s390x.img"
"<url>/art/storage/releases/rhcos-4.10/<release>/x86_64/rhcos-<release>-live-kernel-
x86_64"
"<url>/art/storage/releases/rhcos-4.10/<release>/x86_64/rhcos-<release>-live-
initramfs.x86_64.img"
"<url>/art/storage/releases/rhcos-4.10/<release>/x86_64/rhcos-<release>-live-
rootfs.x86_64.img"

```

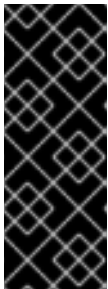

### IMPORTANT

The RHCOS artifacts might not change with every release of OpenShift Container Platform. You must download images with the highest version that is less than or equal to the OpenShift Container Platform version that you install. Only use the appropriate **kernel**, **initramfs**, and **rootfs** artifacts described below for this procedure. RHCOS QCOW2 images are not supported for this installation type.

The file names contain the OpenShift Container Platform version number. They resemble the following examples:

- **kernel:** rhcos-<version>-live-kernel-<architecture>
- **initramfs:** rhcos-<version>-live-initramfs.<architecture>.img
- **rootfs:** rhcos-<version>-live-rootfs.<architecture>.img

4. Upload the **rootfs**, **kernel**, and **initramfs** files to your HTTP server.



### IMPORTANT

If you plan to add more compute machines to your cluster after you finish installation, do not delete these files.

5. Configure the network boot infrastructure so that the machines boot from their local disks after RHCOS is installed on them.

6. Configure PXE or iPXE installation for the RHCOS images and begin the installation. Modify one of the following example menu entries for your environment and verify that the image and Ignition files are properly accessible:

- For PXE (**x86\_64**):

```

DEFAULT pxeboot
TIMEOUT 20
PROMPT 0
LABEL pxeboot
  KERNEL http://<HTTP_server>/rhcos-<version>-live-kernel-<architecture> 1
  APPEND initrd=http://<HTTP_server>/rhcos-<version>-live-initramfs.
<architecture>.img coreos.live.rootfs_url=http://<HTTP_server>/rhcos-<version>-live-
rootfs.<architecture>.img coreos.inst.install_dev=/dev/sda
coreos.inst.ignition_url=http://<HTTP_server>/bootstrap.ign 2 3

```

- 1 1** Specify the location of the live **kernel** file that you uploaded to your HTTP server. The URL must be HTTP, TFTP, or FTP; HTTPS and NFS are not supported.
- 2** If you use multiple NICs, specify a single interface in the **ip** option. For example, to use DHCP on a NIC that is named **eno1**, set **ip=eno1:dhcp**.
- 3** Specify the locations of the RHCOS files that you uploaded to your HTTP server. The **initrd** parameter value is the location of the **initramfs** file, the **coreos.live.rootfs\_url** parameter value is the location of the **rootfs** file, and the **coreos.inst.ignition\_url** parameter value is the location of the bootstrap Ignition config file. You can also add more kernel arguments to the **APPEND** line to configure networking or other boot options.



#### NOTE

This configuration does not enable serial console access on machines with a graphical console. To configure a different console, add one or more **console=** arguments to the **APPEND** line. For example, add **console=tty0 console=ttyS0** to set the first PC serial port as the primary console and the graphical console as a secondary console. For more information, see [How does one set up a serial terminal and/or console in Red Hat Enterprise Linux?](#)

- For iPXE (**x86\_64 + aarch64**):

```

kernel http://<HTTP_server>/rhcos-<version>-live-kernel-<architecture> initrd=main
coreos.live.rootfs_url=http://<HTTP_server>/rhcos-<version>-live-rootfs.
<architecture>.img coreos.inst.install_dev=/dev/sda
coreos.inst.ignition_url=http://<HTTP_server>/bootstrap.ign 1 2
initrd --name main http://<HTTP_server>/rhcos-<version>-live-initramfs.
<architecture>.img 3
boot

```

- 1** Specify the locations of the RHCOS files that you uploaded to your HTTP server. The **kernel** parameter value is the location of the **kernel** file, the **initrd=main** argument is needed for booting on UEFI systems, the **coreos.live.rootfs\_url** parameter value is the location of the **rootfs** file, and the **coreos.inst.ignition\_url** parameter value is the location of the bootstrap Ignition config file.
- 2** If you use multiple NICs, specify a single interface in the **ip** option. For example, to use DHCP on a NIC that is named **eno1**, set **ip=eno1:dhcp**.
- 3** Specify the location of the **initramfs** file that you uploaded to your HTTP server.



**NOTE**

This configuration does not enable serial console access on machines with a graphical console. To configure a different console, add one or more **console=** arguments to the **kernel** line. For example, add **console=tty0 console=ttyS0** to set the first PC serial port as the primary console and the graphical console as a secondary console. For more information, see [How does one set up a serial terminal and/or console in Red Hat Enterprise Linux?](#)

**NOTE**

To network boot the CoreOS **kernel** on **aarch64** architecture, you need to use a version of iPXE build with the **IMAGE\_GZIP** option enabled. See [IMAGE\\_GZIP option in iPXE](#).

- For PXE (with UEFI and Grub as second stage) on **aarch64**:

```

menuentry 'Install CoreOS' {
  linux rhcos-<version>-live-kernel-<architecture>
  coreos.live.rootfs_url=http://<HTTP_server>/rhcos-<version>-live-rootfs.
  <architecture>.img coreos.inst.install_dev=/dev/sda
  coreos.inst.ignition_url=http://<HTTP_server>/bootstrap.ign 1 2
  initrd rhcos-<version>-live-initramfs.<architecture>.img 3
}

```

- 1** Specify the locations of the RHCOS files that you uploaded to your HTTP/TFTP server. The **kernel** parameter value is the location of the **kernel** file on your TFTP server. The **coreos.live.rootfs\_url** parameter value is the location of the **rootfs** file, and the **coreos.inst.ignition\_url** parameter value is the location of the bootstrap Ignition config file on your HTTP Server.
- 2** If you use multiple NICs, specify a single interface in the **ip** option. For example, to use DHCP on a NIC that is named **eno1**, set **ip=eno1:dhcp**.
- 3** Specify the location of the **initramfs** file that you uploaded to your TFTP server.

7. Monitor the progress of the RHCOS installation on the console of the machine.

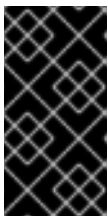
**IMPORTANT**

Be sure that the installation is successful on each node before commencing with the OpenShift Container Platform installation. Observing the installation process can also help to determine the cause of RHCOS installation issues that might arise.

8. After RHCOS installs, the system reboots. During reboot, the system applies the Ignition config file that you specified.
9. Check the console output to verify that Ignition ran.

**Example command**

Ignition: ran on 2022/03/14 14:48:33 UTC (this boot)  
 Ignition: user-provided config was applied

10. Continue to create the machines for your cluster.

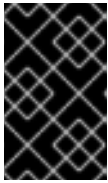

### IMPORTANT

You must create the bootstrap and control plane machines at this time. If the control plane machines are not made schedulable, also create at least two compute machines before you install the cluster.

If the required network, DNS, and load balancer infrastructure are in place, the OpenShift Container Platform bootstrap process begins automatically after the RHCOS nodes have rebooted.



### NOTE

RHCOS nodes do not include a default password for the **core** user. You can access the nodes by running **ssh core@<node>.<cluster\_name>.<base\_domain>** as a user with access to the SSH private key that is paired to the public key that you specified in your **install\_config.yaml** file. OpenShift Container Platform 4 cluster nodes running RHCOS are immutable and rely on Operators to apply cluster changes. Accessing cluster nodes by using SSH is not recommended. However, when investigating installation issues, if the OpenShift Container Platform API is not available, or the kubelet is not properly functioning on a target node, SSH access might be required for debugging or disaster recovery.

#### 10.3.14.3. Advanced RHCOS installation configuration

A key benefit for manually provisioning the Red Hat Enterprise Linux CoreOS (RHCOS) nodes for OpenShift Container Platform is to be able to do configuration that is not available through default OpenShift Container Platform installation methods. This section describes some of the configurations that you can do using techniques that include:

- Passing kernel arguments to the live installer
- Running **coreos-installer** manually from the live system
- Customizing a live ISO or PXE boot image

The advanced configuration topics for manual Red Hat Enterprise Linux CoreOS (RHCOS) installations detailed in this section relate to disk partitioning, networking, and using Ignition configs in different ways.

##### 10.3.14.3.1. Using advanced networking options for PXE and ISO installations

Networking for OpenShift Container Platform nodes uses DHCP by default to gather all necessary configuration settings. To set up static IP addresses or configure special settings, such as bonding, you can do one of the following:

- Pass special kernel parameters when you boot the live installer.
- Use a machine config to copy networking files to the installed system.

- Configure networking from a live installer shell prompt, then copy those settings to the installed system so that they take effect when the installed system first boots.

To configure a PXE or iPXE installation, use one of the following options:

- See the "Advanced RHCOS installation reference" tables.
- Use a machine config to copy networking files to the installed system.

To configure an ISO installation, use the following procedure.

### Procedure

1. Boot the ISO installer.
2. From the live system shell prompt, configure networking for the live system using available RHEL tools, such as **nmcli** or **nmtui**.
3. Run the **coreos-installer** command to install the system, adding the **--copy-network** option to copy networking configuration. For example:

```
$ sudo coreos-installer install --copy-network \
--ignition-url=http://host/worker.ign /dev/sda
```

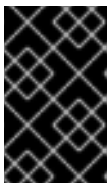

### IMPORTANT

The **--copy-network** option only copies networking configuration found under **/etc/NetworkManager/system-connections**. In particular, it does not copy the system hostname.

4. Reboot into the installed system.

### Additional resources

- See [Getting started with nmcli](#) and [Getting started with nmtui](#) in the RHEL 8 documentation for more information about the **nmcli** and **nmtui** tools.

#### 10.3.14.3.2. Disk partitioning

The disk partitions are created on OpenShift Container Platform cluster nodes during the Red Hat Enterprise Linux CoreOS (RHCOS) installation. Each RHCOS node of a particular architecture uses the same partition layout, unless the default partitioning configuration is overridden. During the RHCOS installation, the size of the root file system is increased to use the remaining available space on the target device.

There are two cases where you might want to override the default partitioning when installing RHCOS on an OpenShift Container Platform cluster node:

- Creating separate partitions: For greenfield installations on an empty disk, you might want to add separate storage to a partition. This is officially supported for mounting **/var** or a subdirectory of **/var**, such as **/var/lib/etcd**, on a separate partition, but not both.

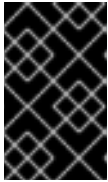
**IMPORTANT**

For disk sizes larger than 100GB, and especially disk sizes larger than 1TB, create a separate **/var** partition. See "Creating a separate **/var** partition" and this [Red Hat Knowledgebase article](#) for more information.

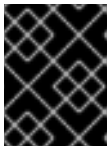
**IMPORTANT**

Kubernetes supports only two file system partitions. If you add more than one partition to the original configuration, Kubernetes cannot monitor all of them.

- Retaining existing partitions: For a brownfield installation where you are reinstalling OpenShift Container Platform on an existing node and want to retain data partitions installed from your previous operating system, there are both boot arguments and options to **coreos-installer** that allow you to retain existing data partitions.

**WARNING**

The use of custom partitions could result in those partitions not being monitored by OpenShift Container Platform or alerted on. If you are overriding the default partitioning, see [Understanding OpenShift File System Monitoring \(eviction conditions\)](#) for more information about how OpenShift Container Platform monitors your host file systems.

**10.3.14.3.2.1. Creating a separate /var partition**

In general, you should use the default disk partitioning that is created during the RHCOS installation. However, there are cases where you might want to create a separate partition for a directory that you expect to grow.

OpenShift Container Platform supports the addition of a single partition to attach storage to either the **/var** directory or a subdirectory of **/var**. For example:

- **/var/lib/containers**: Holds container-related content that can grow as more images and containers are added to a system.
- **/var/lib/etcd**: Holds data that you might want to keep separate for purposes such as performance optimization of etcd storage.
- **/var**: Holds data that you might want to keep separate for purposes such as auditing.

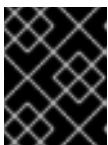
**IMPORTANT**

For disk sizes larger than 100GB, and especially larger than 1TB, create a separate **/var** partition.

Storing the contents of a **/var** directory separately makes it easier to grow storage for those areas as needed and reinstall OpenShift Container Platform at a later date and keep that data intact. With this method, you will not have to pull all your containers again, nor will you have to copy massive log files when you update systems.

The use of a separate partition for the **/var** directory or a subdirectory of **/var** also prevents data growth in the partitioned directory from filling up the root file system.

The following procedure sets up a separate **/var** partition by adding a machine config manifest that is wrapped into the Ignition config file for a node type during the preparation phase of an installation.

## Procedure

1. On your installation host, change to the directory that contains the OpenShift Container Platform installation program and generate the Kubernetes manifests for the cluster:

```
$ openshift-install create manifests --dir <installation_directory>
```

2. Create a Butane config that configures the additional partition. For example, name the file **\$HOME/clusterconfig/98-var-partition.bu**, change the disk device name to the name of the storage device on the **worker** systems, and set the storage size as appropriate. This example places the **/var** directory on a separate partition:

```
variant: openshift
version: 4.10.0
metadata:
  labels:
    machineconfiguration.openshift.io/role: worker
  name: 98-var-partition
storage:
  disks:
    - device: /dev/<device_name> 1
      partitions:
        - label: var
          start_mib: <partition_start_offset> 2
          size_mib: <partition_size> 3
      filesystems:
        - device: /dev/disk/by-partlabel/var
          path: /var
          format: xfs
          mount_options: [defaults, prjquota] 4
          with_mount_unit: true
```

- 1 The storage device name of the disk that you want to partition.
- 2 When adding a data partition to the boot disk, a minimum offset value of 25000 mebibytes is recommended. The root file system is automatically resized to fill all available space up to the specified offset. If no offset value is specified, or if the specified value is smaller than the recommended minimum, the resulting root file system will be too small, and future reinstalls of RHCOS might overwrite the beginning of the data partition.
- 3 The size of the data partition in mebibytes.
- 4 The **prjquota** mount option must be enabled for filesystems used for container storage.

**NOTE**

When creating a separate **/var** partition, you cannot use different instance types for compute nodes, if the different instance types do not have the same device name.

3. Create a manifest from the Butane config and save it to the **clusterconfig/openshift** directory. For example, run the following command:

```
$ butane $HOME/clusterconfig/98-var-partition.bu -o $HOME/clusterconfig/openshift/98-var-partition.yaml
```

4. Create the Ignition config files:

```
$ openshift-install create ignition-configs --dir <installation_directory> 1
```

- 1** For **<installation\_directory>**, specify the same installation directory.

Ignition config files are created for the bootstrap, control plane, and compute nodes in the installation directory:

```
.
├── auth
│   ├── kubeadmin-password
│   └── kubeconfig
├── bootstrap.ign
├── master.ign
├── metadata.json
└── worker.ign
```

The files in the **<installation\_directory>/manifest** and **<installation\_directory>/openshift** directories are wrapped into the Ignition config files, including the file that contains the **98-var-partition** custom **MachineConfig** object.

**Next steps**

- You can apply the custom disk partitioning by referencing the Ignition config files during the RHCOS installations.

**10.3.14.3.2.2. Retaining existing partitions**

For an ISO installation, you can add options to the **coreos-installer** command that cause the installer to maintain one or more existing partitions. For a PXE installation, you can add **coreos.inst.\*** options to the **APPEND** parameter to preserve partitions.

Saved partitions might be data partitions from an existing OpenShift Container Platform system. You can identify the disk partitions you want to keep either by partition label or by number.

**NOTE**

If you save existing partitions, and those partitions do not leave enough space for RHCOS, the installation will fail without damaging the saved partitions.

## Retaining existing partitions during an ISO installation

This example preserves any partition in which the partition label begins with **data** (**data\***):

```
# coreos-installer install --ignition-url http://10.0.2.2:8080/user.ign \
  --save-partlabel 'data*' /dev/sda
```

The following example illustrates running the **coreos-installer** in a way that preserves the sixth (6) partition on the disk:

```
# coreos-installer install --ignition-url http://10.0.2.2:8080/user.ign \
  --save-partindex 6 /dev/sda
```

This example preserves partitions 5 and higher:

```
# coreos-installer install --ignition-url http://10.0.2.2:8080/user.ign
  --save-partindex 5- /dev/sda
```

In the previous examples where partition saving is used, **coreos-installer** recreates the partition immediately.

## Retaining existing partitions during a PXE installation

This **APPEND** option preserves any partition in which the partition label begins with 'data' ('data\*'):

```
coreos.inst.save_partlabel=data*
```

This **APPEND** option preserves partitions 5 and higher:

```
coreos.inst.save_partindex=5-
```

This **APPEND** option preserves partition 6:

```
coreos.inst.save_partindex=6
```

### 10.3.14.3.3. Identifying Ignition configs

When doing an RHCOS manual installation, there are two types of Ignition configs that you can provide, with different reasons for providing each one:

- **Permanent install Ignition config:** Every manual RHCOS installation needs to pass one of the Ignition config files generated by **openshift-installer**, such as **bootstrap.ign**, **master.ign** and **worker.ign**, to carry out the installation.



#### IMPORTANT

It is not recommended to modify these Ignition config files directly. You can update the manifest files that are wrapped into the Ignition config files, as outlined in examples in the preceding sections.

For PXE installations, you pass the Ignition configs on the **APPEND** line using the **coreos.inst.ignition\_url=** option. For ISO installations, after the ISO boots to the shell prompt, you identify the Ignition config on the **coreos-installer** command line with the **--ignition-url=**

option. In both cases, only HTTP and HTTPS protocols are supported.

- **Live install Ignition config:** This type can be created by using the **coreos-installer customize** subcommand and its various options. With this method, the Ignition config passes to the live install medium, runs immediately upon booting, and performs setup tasks before or after the RHCOS system installs to disk. This method should only be used for performing tasks that must be done once and not applied again later, such as with advanced partitioning that cannot be done using a machine config.

For PXE or ISO boots, you can create the Ignition config and **APPEND** the **ignition.config.url=** option to identify the location of the Ignition config. You also need to append **ignition.firstboot ignition.platform.id=metal** or the **ignition.config.url** option will be ignored.

#### 10.3.14.3.3.1. Customizing a live RHCOS ISO or PXE install

You can use the live ISO image or PXE environment to install RHCOS by injecting an Ignition config file directly into the image. This creates a customized image that you can use to provision your system.

For an ISO image, the mechanism to do this is the **coreos-installer iso customize** subcommand, which modifies the **.iso** file with your configuration. Similarly, the mechanism for a PXE environment is the **coreos-installer pxe customize** subcommand, which creates a new **initramfs** file that includes your customizations.

The **customize** subcommand is a general purpose tool that can embed other types of customizations as well. The following tasks are examples of some of the more common customizations:

- Inject custom CA certificates for when corporate security policy requires their use.
- Configure network settings without the need for kernel arguments.
- Embed arbitrary pre-install and post-install scripts or binaries.

#### 10.3.14.3.3.2. Customizing a live RHCOS ISO image

You can customize a live RHCOS ISO image directly with the **coreos-installer iso customize** subcommand. When you boot the ISO image, the customizations are applied automatically.

You can use this feature to configure the ISO image to automatically install RHCOS.

#### Procedure

1. Download the **coreos-installer** binary from the [coreos-installer image mirror](#) page.
2. Retrieve the RHCOS ISO image from the [RHCOS image mirror](#) page and the Ignition config file, and then run the following command to inject the Ignition config directly into the ISO image:

```
$ coreos-installer iso customize rhcos-<version>-live.x86_64.iso \
  --dest-ignition bootstrap.ign \ 1
  --dest-device /dev/sda 2
```

- 1 The Ignition config file that is generated from **openshift-installer**.
- 2 When you specify this option, the ISO image automatically runs an install. Otherwise, the image remains configured for installing, but does not do so automatically unless you specify the **coreos.inst.install\_dev** kernel argument.



Your customizations are applied and affect every subsequent boot of the ISO image.

1. To remove the ISO image customizations and return the image to its pristine state, run:

```
$ coreos-installer iso reset rhcos-<version>-live.x86_64.iso
```

You can now re-customize the live ISO image or use it in its pristine state.

#### 10.3.14.3.3.2.1. Modifying a live install ISO image to use a custom certificate authority

You can provide certificate authority (CA) certificates to Ignition with the **--ignition-ca** flag of the **customize** subcommand. You can use the CA certificates during both the installation boot and when provisioning the installed system.

##### Procedure

1. Download the **coreos-installer** binary from the [coreos-installer image mirror](#) page.
2. Retrieve the RHCOS ISO image from the [RHCOS image mirror](#) page and run the following command to customize the ISO image for use with a custom CA:

```
$ coreos-installer iso customize rhcos-<version>-live.x86_64.iso --ignition-ca cert.pem
```

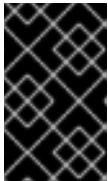

##### IMPORTANT

The **coreos.inst.ignition\_url** kernel parameter does not work with the **--ignition-ca** flag. You must use the **--dest-ignition** flag to create a customized image for each cluster.



##### NOTE

Custom CA certificates affect how Ignition fetches remote resources but they do not affect the certificates installed onto the system.

Your CA certificate is applied and affects every subsequent boot of the ISO image.

#### 10.3.14.3.3.2.2. Modifying a live install ISO image with customized network settings

You can embed a NetworkManager keyfile into the live ISO image and pass it through to the installed system with the **--network-keyfile** flag of the **customize** subcommand.

##### Procedure

1. Download the **coreos-installer** binary from the [coreos-installer image mirror](#) page.
2. Create a connection profile for a bonded interface. For example, create the **bond0.nmconnection** file in your local directory with the following content:

```
[connection]
id=bond0
type=bond
interface-name=bond0
```

```

multi-connect=1
permissions=

[ethernet]
mac-address-blacklist=

[bond]
miimon=100
mode=active-backup

[ipv4]
method=auto

[ipv6]
method=auto

[proxy]

```

3. Create a connection profile for a secondary interface to add to the bond. For example, create the **bond0-proxy-em1.nmconnection** file in your local directory with the following content:

```

[connection]
id=em1
type=ethernet
interface-name=em1
master=bond0
multi-connect=1
permissions=
slave-type=bond

[ethernet]
mac-address-blacklist=

```

4. Create a connection profile for a secondary interface to add to the bond. For example, create the **bond0-proxy-em2.nmconnection** file in your local directory with the following content:

```

[connection]
id=em2
type=ethernet
interface-name=em2
master=bond0
multi-connect=1
permissions=
slave-type=bond

[ethernet]
mac-address-blacklist=

```

5. Retrieve the RHCOS ISO image from the [RHCOS image mirror](#) page and run the following command to customize the ISO image with your configured networking:

```

$ coreos-installer iso customize rhcos-<version>-live.x86_64.iso \
  --network-keyfile bond0.nmconnection \
  --network-keyfile bond0-proxy-em1.nmconnection \
  --network-keyfile bond0-proxy-em2.nmconnection

```

Network settings are applied to the live system and are carried over to the destination system.

### 10.3.14.3.3.3. Customizing a live RHCOS PXE environment

You can customize a live RHCOS PXE environment directly with the **coreos-installer pxe customize** subcommand. When you boot the PXE environment, the customizations are applied automatically.

You can use this feature to configure the PXE environment to automatically install RHCOS.

#### Procedure

1. Download the **coreos-installer** binary from the [coreos-installer image mirror](#) page.
2. Retrieve the RHCOS **kernel**, **initramfs** and **rootfs** files from the [RHCOS image mirror](#) page and the Ignition config file, and then run the following command to create a new **initramfs** file that contains the customizations from your Ignition config:

```
$ coreos-installer pxe customize rhcos-<version>-live-initramfs.x86_64.img \
  --dest-ignition bootstrap.ign \ 1
  --dest-device /dev/sda \ 2
  -o rhcos-<version>-custom-initramfs.x86_64.img
```

- 1 The Ignition config file that is generated from **openshift-installer**.
- 2 When you specify this option, the PXE environment automatically runs an install. Otherwise, the image remains configured for installing, but does not do so automatically unless you specify the **coreos.inst.install\_dev** kernel argument.

Your customizations are applied and affect every subsequent boot of the PXE environment.

### 10.3.14.3.3.3.1. Modifying a live install PXE environment to use a custom certificate authority

You can provide certificate authority (CA) certificates to Ignition with the **--ignition-ca** flag of the **customize** subcommand. You can use the CA certificates during both the installation boot and when provisioning the installed system.

#### Procedure

1. Download the **coreos-installer** binary from the [coreos-installer image mirror](#) page.
2. Retrieve the RHCOS **kernel**, **initramfs** and **rootfs** files from the [RHCOS image mirror](#) page and run the following command to create a new customized **initramfs** file for use with a custom CA:

```
$ coreos-installer pxe customize rhcos-<version>-live-initramfs.x86_64.img \
  --ignition-ca cert.pem \
  -o rhcos-<version>-custom-initramfs.x86_64.img
```



#### IMPORTANT

The **coreos.inst.ignition\_url** kernel parameter does not work with the **--ignition-ca** flag. You must use the **--dest-ignition** flag to create a customized image for each cluster.

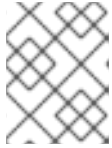
**NOTE**

Custom CA certificates affect how Ignition fetches remote resources but they do not affect the certificates installed onto the system.

Your CA certificate is applied and affects every subsequent boot of the PXE environment.

### 10.3.14.3.3.3.2. Modifying a live install PXE environment with customized network settings

You can embed a NetworkManager keyfile into the live PXE environment and pass it through to the installed system with the **--network-keyfile** flag of the **customize** subcommand.

#### Procedure

1. Download the **coreos-installer** binary from the [coreos-installer image mirror](#) page.
2. Create a connection profile for a bonded interface. For example, create the **bond0.nmconnection** file in your local directory with the following content:

```
[connection]
id=bond0
type=bond
interface-name=bond0
multi-connect=1
permissions=

[ethernet]
mac-address-blacklist=

[bond]
miimon=100
mode=active-backup

[ipv4]
method=auto

[ipv6]
method=auto

[proxy]
```

3. Create a connection profile for a secondary interface to add to the bond. For example, create the **bond0-proxy-em1.nmconnection** file in your local directory with the following content:

```
[connection]
id=em1
type=ethernet
interface-name=em1
master=bond0
multi-connect=1
permissions=
slave-type=bond

[ethernet]
mac-address-blacklist=
```

4. Create a connection profile for a secondary interface to add to the bond. For example, create the **bond0-proxy-em2.nmconnection** file in your local directory with the following content:

```
[connection]
id=em2
type=ethernet
interface-name=em2
master=bond0
multi-connect=1
permissions=
slave-type=bond

[ethernet]
mac-address-blacklist=
```

5. Retrieve the RHCOS **kernel**, **initramfs** and **rootfs** files from the [RHCOS image mirror](#) page and run the following command to create a new customized **initramfs** file that contains your configured networking:

```
$ coreos-installer pxe customize rhcos-<version>-live-initramfs.x86_64.img \
--network-keyfile bond0.nmconnection \
--network-keyfile bond0-proxy-em1.nmconnection \
--network-keyfile bond0-proxy-em2.nmconnection \
-o rhcos-<version>-custom-initramfs.x86_64.img
```

Network settings are applied to the live system and are carried over to the destination system.

#### 10.3.14.3.4. Advanced RHCOS installation reference

This section illustrates the networking configuration and other advanced options that allow you to modify the Red Hat Enterprise Linux CoreOS (RHCOS) manual installation process. The following tables describe the kernel arguments and command-line options you can use with the RHCOS live installer and the **coreos-installer** command.

##### 10.3.14.3.4.1. Networking and bonding options for ISO installations

If you install RHCOS from an ISO image, you can add kernel arguments manually when you boot the image to configure networking for a node. If no networking arguments are specified, DHCP is activated in the **initramfs** when RHCOS detects that networking is required to fetch the Ignition config file.



#### IMPORTANT

When adding networking arguments manually, you must also add the **rd.neednet=1** kernel argument to bring the network up in the **initramfs**.

The following table provides examples for configuring networking and bonding on your RHCOS nodes for ISO installations. The examples describe how to use the **ip=**, **nameserver=**, and **bond=** kernel arguments.



#### NOTE

Ordering is important when adding the kernel arguments: **ip=**, **nameserver=**, and then **bond=**.

The networking options are passed to the **dracut** tool during system boot. For more information about the networking options supported by **dracut**, see the **dracut.cmdline** manual page.

The following examples are the networking options for ISO installation.

#### Configuring DHCP or static IP addresses

To configure an IP address, either use DHCP (**ip=dhcp**) or set an individual static IP address (**ip=<host\_ip>**). If setting a static IP, you must then identify the DNS server IP address (**nameserver=<dns\_ip>**) on each node. The following example sets:

- The node's IP address to **10.10.10.2**
- The gateway address to **10.10.10.254**
- The netmask to **255.255.255.0**
- The hostname to **core0.example.com**
- The DNS server address to **4.4.4.41**
- The auto-configuration value to **none**. No auto-configuration is required when IP networking is configured statically.

```
ip=10.10.10.2::10.10.10.254:255.255.255.0:core0.example.com:enp1s0:none  
nameserver=4.4.4.41
```



#### NOTE

When you use DHCP to configure IP addressing for the RHCOS machines, the machines also obtain the DNS server information through DHCP. For DHCP-based deployments, you can define the DNS server address that is used by the RHCOS nodes through your DHCP server configuration.

#### Configuring an IP address without a static hostname

You can configure an IP address without assigning a static hostname. If a static hostname is not set by the user, it will be picked up and automatically set by a reverse DNS lookup. To configure an IP address without a static hostname refer to the following example:

- The node's IP address to **10.10.10.2**
- The gateway address to **10.10.10.254**
- The netmask to **255.255.255.0**
- The DNS server address to **4.4.4.41**
- The auto-configuration value to **none**. No auto-configuration is required when IP networking is configured statically.

```
ip=10.10.10.2::10.10.10.254:255.255.255.0::enp1s0:none  
nameserver=4.4.4.41
```

#### Specifying multiple network interfaces

You can specify multiple network interfaces by setting multiple **ip=** entries.

```
ip=10.10.10.2::10.10.10.254:255.255.255.0:core0.example.com:enp1s0:none
ip=10.10.10.3::10.10.10.254:255.255.255.0:core0.example.com:enp2s0:none
```

Configuring default gateway and route

Optional: You can configure routes to additional networks by setting an **rd.route=** value.



#### NOTE

When you configure one or multiple networks, one default gateway is required. If the additional network gateway is different from the primary network gateway, the default gateway must be the primary network gateway.

- Run the following command to configure the default gateway:

```
ip=::10.10.10.254:::
```

- Enter the following command to configure the route for the additional network:

```
rd.route=20.20.20.0/24:20.20.20.254:enp2s0
```

Disabling DHCP on a single interface

You can disable DHCP on a single interface, such as when there are two or more network interfaces and only one interface is being used. In the example, the **enp1s0** interface has a static networking configuration and DHCP is disabled for **enp2s0**, which is not used:

```
ip=10.10.10.2::10.10.10.254:255.255.255.0:core0.example.com:enp1s0:none
ip=::::core0.example.com:enp2s0:none
```

Combining DHCP and static IP configurations

You can combine DHCP and static IP configurations on systems with multiple network interfaces, for example:

```
ip=enp1s0:dhcp
ip=10.10.10.2::10.10.10.254:255.255.255.0:core0.example.com:enp2s0:none
```

Configuring VLANs on individual interfaces

Optional: You can configure VLANs on individual interfaces by using the **vlan=** parameter.

- To configure a VLAN on a network interface and use a static IP address, run the following command:

```
ip=10.10.10.2::10.10.10.254:255.255.255.0:core0.example.com:enp2s0.100:none
vlan=enp2s0.100:enp2s0
```

- To configure a VLAN on a network interface and to use DHCP, run the following command:

```
ip=enp2s0.100:dhcp
vlan=enp2s0.100:enp2s0
```

Providing multiple DNS servers

You can provide multiple DNS servers by adding a **nameserver=** entry for each server, for example:

```
nameserver=1.1.1.1
nameserver=8.8.8.8
```

Bonding multiple network interfaces to a single interface

Optional: You can bond multiple network interfaces to a single interface by using the **bond=** option. Refer to the following examples:

- The syntax for configuring a bonded interface is: **bond=name[:network\_interfaces][:options]** *name* is the bonding device name (**bond0**), *network\_interfaces* represents a comma-separated list of physical (ethernet) interfaces (**em1,em2**), and *options* is a comma-separated list of bonding options. Enter **modinfo bonding** to see available options.
- When you create a bonded interface using **bond=**, you must specify how the IP address is assigned and other information for the bonded interface.
- To configure the bonded interface to use DHCP, set the bond's IP address to **dhcp**. For example:

```
bond=bond0:em1,em2:mode=active-backup
ip=bond0:dhcp
```

- To configure the bonded interface to use a static IP address, enter the specific IP address you want and related information. For example:

```
bond=bond0:em1,em2:mode=active-backup
ip=10.10.10.2::10.10.10.254:255.255.255.0:core0.example.com:bond0:none
```

Bonding multiple network interfaces to a single interface

Optional: You can configure VLANs on bonded interfaces by using the **vlan=** parameter and to use DHCP, for example:

```
ip=bond0.100:dhcp
bond=bond0:em1,em2:mode=active-backup
vlan=bond0.100:bond0
```

Use the following example to configure the bonded interface with a VLAN and to use a static IP address:

```
ip=10.10.10.2::10.10.10.254:255.255.255.0:core0.example.com:bond0.100:none
bond=bond0:em1,em2:mode=active-backup
vlan=bond0.100:bond0
```

Using network teaming

Optional: You can use a network teaming as an alternative to bonding by using the **team=** parameter:

- The syntax for configuring a team interface is: **team=name[:network\_interfaces]** *name* is the team device name (**team0**) and *network\_interfaces* represents a comma-separated list of physical (ethernet) interfaces (**em1, em2**).

Teaming is planned to be deprecated when RHCOS switches to an upcoming version of RHEL. For more information, see this [Red Hat Knowledgebase Article](#) .

Use the following example to configure a network team:



```
team=team0:em1,em2
ip=team0:dhcp
```

#### 10.3.14.3.4.2. coreos-installer options for ISO and PXE installations

You can install RHCOS by running **coreos-installer install <options> <device>** at the command prompt, after booting into the RHCOS live environment from an ISO image.

The following table shows the subcommands, options, and arguments you can pass to the **coreos-installer** command.

**Table 10.32. coreos-installer subcommands, command-line options, and arguments**

coreos-installer install subcommand	
<i>Subcommand</i>	<i>Description</i>
<b>\$ coreos-installer install &lt;options&gt; &lt;device&gt;</b>	Embed an Ignition config in an ISO image.
coreos-installer install subcommand options	
<i>Option</i>	<i>Description</i>
<b>-u, --image-url &lt;url&gt;</b>	Specify the image URL manually.
<b>-f, --image-file &lt;path&gt;</b>	Specify a local image file manually. Used for debugging.
<b>-i, --ignition-file &lt;path&gt;</b>	Embed an Ignition config from a file.
<b>-l, --ignition-url &lt;URL&gt;</b>	Embed an Ignition config from a URL.
<b>--ignition-hash &lt;digest&gt;</b>	Digest <b>type-value</b> of the Ignition config.
<b>-p, --platform &lt;name&gt;</b>	Override the Ignition platform ID for the installed system.
<b>--append-karg &lt;arg&gt;...</b>	Append a default kernel argument to the installed system.
<b>--delete-karg &lt;arg&gt;...</b>	Delete a default kernel argument from the installed system.

<b>-n, --copy-network</b>	Copy the network configuration from the install environment.
	 <p><b>IMPORTANT</b></p> <p>The <b>--copy-network</b> option only copies networking configuration found under <b>/etc/NetworkManager/system-connections</b>. In particular, it does not copy the system hostname.</p>
<b>--network-dir &lt;path&gt;</b>	For use with <b>-n</b> . Default is <b>/etc/NetworkManager/system-connections/</b> .
<b>--save-partlabel &lt;lx&gt;..</b>	Save partitions with this label glob.
<b>--save-partindex &lt;id&gt;...</b>	Save partitions with this number or range.
<b>--insecure</b>	Skip RHCOS image signature verification.
<b>--insecure-ignition</b>	Allow Ignition URL without HTTPS or hash.
<b>--architecture &lt;name&gt;</b>	Target CPU architecture. Valid values are <b>x86_64</b> and <b>aarch64</b> .
<b>--preserve-on-error</b>	Do not clear partition table on error.
<b>-h, --help</b>	Print help information.
<b>coreos-installer install subcommand argument</b>	
<i>Argument</i>	<i>Description</i>
<b>&lt;device&gt;</b>	The destination device.
<b>coreos-installer ISO subcommands</b>	
<i>Subcommand</i>	<i>Description</i>
<b>\$ coreos-installer iso customize &lt;options&gt; &lt;ISO_image&gt;</b>	Customize a RHCOS live ISO image.

<b>coreos-installer iso reset &lt;options&gt; &lt;ISO_image&gt;</b>	Restore a RHCOS live ISO image to default settings.
<b>coreos-installer iso ignition remove &lt;options&gt; &lt;ISO_image&gt;</b>	Remove the embedded Ignition config from an ISO image.
<b>coreos-installer ISO customize subcommand options</b>	
<i>Option</i>	<i>Description</i>
<b>--dest-ignition &lt;path&gt;</b>	Merge the specified Ignition config file into a new configuration fragment for the destination system.
<b>--dest-device &lt;path&gt;</b>	Install and overwrite the specified destination device.
<b>--dest-karg-append &lt;arg&gt;</b>	Add a kernel argument to each boot of the destination system.
<b>--dest-karg-delete &lt;arg&gt;</b>	Delete a kernel argument from each boot of the destination system.
<b>--network-keyfile &lt;path&gt;</b>	Configure networking by using the specified NetworkManager keyfile for live and destination systems.
<b>--ignition-ca &lt;path&gt;</b>	Specify an additional TLS certificate authority to be trusted by Ignition.
<b>--pre-install &lt;path&gt;</b>	Run the specified script before installation.
<b>--post-install &lt;path&gt;</b>	Run the specified script after installation.
<b>--installer-config &lt;path&gt;</b>	Apply the specified installer configuration file.
<b>--live-ignition &lt;path&gt;</b>	Merge the specified Ignition config file into a new configuration fragment for the live environment.
<b>--live-karg-append &lt;arg&gt;</b>	Add a kernel argument to each boot of the live environment.
<b>--live-karg-delete &lt;arg&gt;</b>	Delete a kernel argument from each boot of the live environment.
<b>--live-karg-replace &lt;k=o=n&gt;</b>	Replace a kernel argument in each boot of the live environment, in the form <b>key=old=new</b> .
<b>-f, --force</b>	Overwrite an existing Ignition config.

<b>-o, --output &lt;path&gt;</b>	Write the ISO to a new output file.
<b>-h, --help</b>	Print help information.
coreos-installer PXE subcommands	
<i>Subcommand</i>	<i>Description</i>
Note that not all of these options are accepted by all subcommands.	
<b>coreos-installer pxe customize &lt;options&gt; &lt;path&gt;</b>	Customize a RHCOS live PXE boot config.
<b>coreos-installer pxe ignition wrap &lt;options&gt;</b>	Wrap an Ignition config in an image.
<b>coreos-installer pxe ignition unwrap &lt;options&gt; &lt;image_name&gt;</b>	Show the wrapped Ignition config in an image.
coreos-installer PXE customize subcommand options	
<i>Option</i>	<i>Description</i>
Note that not all of these options are accepted by all subcommands.	
<b>--dest-ignition &lt;path&gt;</b>	Merge the specified Ignition config file into a new configuration fragment for the destination system.
<b>--dest-device &lt;path&gt;</b>	Install and overwrite the specified destination device.
<b>--network-keyfile &lt;path&gt;</b>	Configure networking by using the specified NetworkManager keyfile for live and destination systems.
<b>--ignition-ca &lt;path&gt;</b>	Specify an additional TLS certificate authority to be trusted by Ignition.
<b>--pre-install &lt;path&gt;</b>	Run the specified script before installation.
<b>post-install &lt;path&gt;</b>	Run the specified script after installation.
<b>--installer-config &lt;path&gt;</b>	Apply the specified installer configuration file.
<b>--live-ignition &lt;path&gt;</b>	Merge the specified Ignition config file into a new configuration fragment for the live environment.

<b>-o, --output &lt;path&gt;</b>	Write the initramfs to a new output file.   <b>NOTE</b> This option is required for PXE environments.
<b>-h, --help</b>	Print help information.

#### 10.3.14.3.4.3. **coreos.inst** boot options for ISO or PXE installations

You can automatically invoke **coreos-installer** options at boot time by passing **coreos.inst** boot arguments to the RHCOS live installer. These are provided in addition to the standard boot arguments.

- For ISO installations, the **coreos.inst** options can be added by interrupting the automatic boot at the bootloader menu. You can interrupt the automatic boot by pressing **TAB** while the **RHEL CoreOS (Live)** menu option is highlighted.
- For PXE or iPXE installations, the **coreos.inst** options must be added to the **APPEND** line before the RHCOS live installer is booted.

The following table shows the RHCOS live installer **coreos.inst** boot options for ISO and PXE installations.

Table 10.33. **coreos.inst** boot options

Argument	Description
<b>coreos.inst.install_dev</b>	Required. The block device on the system to install to. It is recommended to use the full path, such as <b>/dev/sda</b> , although <b>sda</b> is allowed.
<b>coreos.inst.ignition_url</b>	Optional: The URL of the Ignition config to embed into the installed system. If no URL is specified, no Ignition config is embedded. Only HTTP and HTTPS protocols are supported.
<b>coreos.inst.save_partlabel</b>	Optional: Comma-separated labels of partitions to preserve during the install. Glob-style wildcards are permitted. The specified partitions do not need to exist.
<b>coreos.inst.save_partindex</b>	Optional: Comma-separated indexes of partitions to preserve during the install. Ranges <b>m-n</b> are permitted, and either <b>m</b> or <b>n</b> can be omitted. The specified partitions do not need to exist.
<b>coreos.inst.insecure</b>	Optional: Permits the OS image that is specified by <b>coreos.inst.image_url</b> to be unsigned.

Argument	Description
<b>coreos.inst.image_url</b>	<p>Optional: Download and install the specified RHCOS image.</p> <ul style="list-style-type: none"> <li>• This argument should not be used in production environments and is intended for debugging purposes only.</li> <li>• While this argument can be used to install a version of RHCOS that does not match the live media, it is recommended that you instead use the media that matches the version you want to install.</li> <li>• If you are using <b>coreos.inst.image_url</b>, you must also use <b>coreos.inst.insecure</b>. This is because the bare-metal media are not GPG-signed for OpenShift Container Platform.</li> <li>• Only HTTP and HTTPS protocols are supported.</li> </ul>
<b>coreos.inst.skip_reboot</b>	<p>Optional: The system will not reboot after installing. After the install finishes, you will receive a prompt that allows you to inspect what is happening during installation. This argument should not be used in production environments and is intended for debugging purposes only.</p>
<b>coreos.inst.platform_id</b>	<p>Optional: The Ignition platform ID of the platform the RHCOS image is being installed on. Default is <b>metal</b>. This option determines whether or not to request an Ignition config from the cloud provider, such as VMware. For example: <b>coreos.inst.platform_id=vmware</b>.</p>
<b>ignition.config.url</b>	<p>Optional: The URL of the Ignition config for the live boot. For example, this can be used to customize how <b>coreos-installer</b> is invoked, or to run code before or after the installation. This is different from <b>coreos.inst.ignition_url</b>, which is the Ignition config for the installed system.</p>

#### 10.3.14.4. Enabling multipathing with kernel arguments on RHCOS

RHCOS supports multipathing on the primary disk, allowing stronger resilience to hardware failure to achieve higher host availability.

You can enable multipathing at installation time for nodes that were provisioned in OpenShift Container Platform 4.8 or later. While post-installation support is available by activating multipathing via the machine config, enabling multipathing during installation is recommended.

In setups where any I/O to non-optimized paths results in I/O system errors, you must enable multipathing at installation time.



### IMPORTANT

On IBM Z and LinuxONE, you can enable multipathing only if you configured your cluster for it during installation. For more information, see "Installing RHCOS and starting the OpenShift Container Platform bootstrap process" in *Installing a cluster with z/VM on IBM Z and LinuxONE*.

The following procedure enables multipath at installation time and appends kernel arguments to the **coreos-installer install** command so that the installed system itself will use multipath beginning from the first boot.

### Prerequisites

- You have a running OpenShift Container Platform cluster that uses version 4.8 or later.

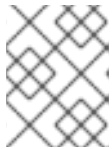

### NOTE

OpenShift Container Platform does not support enabling multipathing as a day-2 activity on nodes that have been upgraded from 4.6 or earlier.

- You are logged in to the cluster as a user with administrative privileges.

### Procedure

- To enable multipath and start the **multipathd** daemon, run the following command:

```
$ mpathconf --enable && systemctl start multipathd.service
```

- Optional: If booting the PXE or ISO, you can instead enable multipath by adding **rd.multipath=default** from the kernel command line.

- Append the kernel arguments by invoking the **coreos-installer** program:

- If there is only one multipath device connected to the machine, it should be available at path **/dev/mapper/mpatha**. For example:

```
$ coreos-installer install /dev/mapper/mpatha \ 1
--append-karg rd.multipath=default \
--append-karg root=/dev/disk/by-label/dm-mpath-root \
--append-karg rw
```

- 1 Indicates the path of the single multipathed device.

- If there are multiple multipath devices connected to the machine, or to be more explicit, instead of using **/dev/mapper/mpatha**, it is recommended to use the World Wide Name (WWN) symlink available in **/dev/disk/by-id**. For example:

```
$ coreos-installer install /dev/disk/by-id/wwn-<wwn_ID> \ 1
--append-karg rd.multipath=default \
--append-karg root=/dev/disk/by-label/dm-mpath-root \
```

```
--append-karg rw
```

- 1 Indicates the WWN ID of the target multipathed device. For example, **0xx194e957fcedb4841**.

This symlink can also be used as the **coreos.inst.install\_dev** kernel argument when using special **coreos.inst.\*** arguments to direct the live installer. For more information, see "Installing RHCOS and starting the OpenShift Container Platform bootstrap process".

3. Check that the kernel arguments worked by going to one of the worker nodes and listing the kernel command line arguments (in **/proc/cmdline** on the host):

```
$ oc debug node/ip-10-0-141-105.ec2.internal
```

### Example output

```
Starting pod/ip-10-0-141-105ec2internal-debug ...
To use host binaries, run `chroot /host`

sh-4.2# cat /host/proc/cmdline
...
rd.multipath=default root=/dev/disk/by-label/dm-mpath-root
...

sh-4.2# exit
```

You should see the added kernel arguments.

### 10.3.14.5. Updating the bootloader using **bootupd**

To update the bootloader by using **bootupd**, you must either install **bootupd** on RHCOS machines manually or provide a machine config with the enabled **systemd** unit. Unlike **grubby** or other bootloader tools, **bootupd** does not manage kernel space configuration such as passing kernel arguments.

After you have installed **bootupd**, you can manage it remotely from the OpenShift Container Platform cluster.

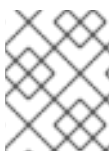

#### NOTE

It is recommended that you use **bootupd** only on bare metal or virtualized hypervisor installations, such as for protection against the BootHole vulnerability.

### Manual install method

You can manually install **bootupd** by using the **bootctl** command-line tool.

1. Inspect the system status:

```
# bootupctl status
```

#### Example output for x86\_64



```
Component EFI
```

```
Installed: grub2-efi-x64-1:2.04-31.fc33.x86_64,shim-x64-15-8.x86_64
```

```
Update: At latest version
```

### Example output for aarch64

```
Component EFI
```

```
Installed: grub2-efi-aa64-1:2.02-99.el8_4.1.aarch64,shim-aa64-15.4-2.el8_1.aarch64
```

```
Update: At latest version
```

- RHCOS images created without **bootupd** installed on them require an explicit adoption phase. If the system status is **Adoptable**, perform the adoption:

```
# bootupctl adopt-and-update
```

### Example output

```
Updated: grub2-efi-x64-1:2.04-31.fc33.x86_64,shim-x64-15-8.x86_64
```

- If an update is available, apply the update so that the changes take effect on the next reboot:

```
# bootupctl update
```

### Example output

```
Updated: grub2-efi-x64-1:2.04-31.fc33.x86_64,shim-x64-15-8.x86_64
```

## Machine config method

Another way to enable **bootupd** is by providing a machine config.

- Provide a machine config file with the enabled **systemd** unit, as shown in the following example:

### Example output

```
variant: rhcos
version: 1.1.0
systemd:
  units:
    - name: custom-bootupd-auto.service
      enabled: true
      contents: |
        [Unit]
        Description=Bootupd automatic update

        [Service]
        ExecStart=/usr/bin/bootupctl update
        RemainAfterExit=yes

        [Install]
        WantedBy=multi-user.target
```

### 10.3.15. Waiting for the bootstrap process to complete

The OpenShift Container Platform bootstrap process begins after the cluster nodes first boot into the persistent RHCOS environment that has been installed to disk. The configuration information provided through the Ignition config files is used to initialize the bootstrap process and install OpenShift Container Platform on the machines. You must wait for the bootstrap process to complete.

#### Prerequisites

- You have created the Ignition config files for your cluster.
- You have configured suitable network, DNS and load balancing infrastructure.
- You have obtained the installation program and generated the Ignition config files for your cluster.
- You installed RHCOS on your cluster machines and provided the Ignition config files that the OpenShift Container Platform installation program generated.
- Your machines have direct internet access or have an HTTP or HTTPS proxy available.

#### Procedure

1. Monitor the bootstrap process:

```
$ ./openshift-install --dir <installation_directory> wait-for bootstrap-complete \ 1
--log-level=info 2
```

1 For **<installation\_directory>**, specify the path to the directory that you stored the installation files in.

2 To view different installation details, specify **warn**, **debug**, or **error** instead of **info**.

#### Example output

```
INFO Waiting up to 30m0s for the Kubernetes API at https://api.test.example.com:6443...
INFO API v1.23.0 up
INFO Waiting up to 30m0s for bootstrapping to complete...
INFO It is now safe to remove the bootstrap resources
```

The command succeeds when the Kubernetes API server signals that it has been bootstrapped on the control plane machines.

2. After bootstrap process is complete, remove the bootstrap machine from the load balancer.



#### IMPORTANT

You must remove the bootstrap machine from the load balancer at this point. You can also remove or reformat the bootstrap machine itself.

#### Additional resources

- See [Monitoring installation progress](#) for more information about monitoring the installation logs and retrieving diagnostic data if installation issues arise.

### 10.3.16. Logging in to the cluster by using the CLI

You can log in to your cluster as a default system user by exporting the cluster **kubeconfig** file. The **kubeconfig** file contains information about the cluster that is used by the CLI to connect a client to the correct cluster and API server. The file is specific to a cluster and is created during OpenShift Container Platform installation.

#### Prerequisites

- You deployed an OpenShift Container Platform cluster.
- You installed the **oc** CLI.

#### Procedure

1. Export the **kubeadmin** credentials:

```
$ export KUBECONFIG=<installation_directory>/auth/kubeconfig 1
```

- 1** For **<installation\_directory>**, specify the path to the directory that you stored the installation files in.

2. Verify you can run **oc** commands successfully using the exported configuration:

```
$ oc whoami
```

#### Example output

```
system:admin
```

### 10.3.17. Approving the certificate signing requests for your machines

When you add machines to a cluster, two pending certificate signing requests (CSRs) are generated for each machine that you added. You must confirm that these CSRs are approved or, if necessary, approve them yourself. The client requests must be approved first, followed by the server requests.

#### Prerequisites

- You added machines to your cluster.

#### Procedure

1. Confirm that the cluster recognizes the machines:

```
$ oc get nodes
```

#### Example output

```
NAME      STATUS    ROLES    AGE   VERSION
master-0  Ready    master   63m   v1.23.0
master-1  Ready    master   63m   v1.23.0
master-2  Ready    master   64m   v1.23.0
```

The output lists all of the machines that you created.



### NOTE

The preceding output might not include the compute nodes, also known as worker nodes, until some CSRs are approved.

- Review the pending CSRs and ensure that you see the client requests with the **Pending** or **Approved** status for each machine that you added to the cluster:

```
$ oc get csr
```

### Example output

```
NAME      AGE  REQUESTOR                                     CONDITION
csr-8b2br 15m  system:serviceaccount:openshift-machine-config-operator:node-
bootstrapper Pending
csr-8vnps 15m  system:serviceaccount:openshift-machine-config-operator:node-
bootstrapper Pending
...
```

In this example, two machines are joining the cluster. You might see more approved CSRs in the list.

- If the CSRs were not approved, after all of the pending CSRs for the machines you added are in **Pending** status, approve the CSRs for your cluster machines:



### NOTE

Because the CSRs rotate automatically, approve your CSRs within an hour of adding the machines to the cluster. If you do not approve them within an hour, the certificates will rotate, and more than two certificates will be present for each node. You must approve all of these certificates. After the client CSR is approved, the Kubelet creates a secondary CSR for the serving certificate, which requires manual approval. Then, subsequent serving certificate renewal requests are automatically approved by the **machine-approver** if the Kubelet requests a new certificate with identical parameters.



### NOTE

For clusters running on platforms that are not machine API enabled, such as bare metal and other user-provisioned infrastructure, you must implement a method of automatically approving the kubelet serving certificate requests (CSRs). If a request is not approved, then the **oc exec**, **oc rsh**, and **oc logs** commands cannot succeed, because a serving certificate is required when the API server connects to the kubelet. Any operation that contacts the Kubelet endpoint requires this certificate approval to be in place. The method must watch for new CSRs, confirm that the CSR was submitted by the **node-bootstrapper** service account in the **system:node** or **system:admin** groups, and confirm the identity of the node.

- To approve them individually, run the following command for each valid CSR:

```
$ oc adm certificate approve <csr_name> 1
```

**1** **<csr\_name>** is the name of a CSR from the list of current CSRs.

- To approve all pending CSRs, run the following command:

```
$ oc get csr -o go-template='{{range .items}}{{if not .status}}{{.metadata.name}}{\n"}\n{{end}}' | xargs --no-run-if-empty oc adm certificate approve
```



#### NOTE

Some Operators might not become available until some CSRs are approved.

- Now that your client requests are approved, you must review the server requests for each machine that you added to the cluster:

```
$ oc get csr
```

#### Example output

```
NAME      AGE   REQUESTOR                                     CONDITION
csr-bfd72 5m26s system:node:ip-10-0-50-126.us-east-2.compute.internal
Pending
csr-c57lv 5m26s system:node:ip-10-0-95-157.us-east-2.compute.internal
Pending
...
```

- If the remaining CSRs are not approved, and are in the **Pending** status, approve the CSRs for your cluster machines:

- To approve them individually, run the following command for each valid CSR:

```
$ oc adm certificate approve <csr_name> 1
```

**1** **<csr\_name>** is the name of a CSR from the list of current CSRs.

- To approve all pending CSRs, run the following command:

```
$ oc get csr -o go-template='{{range .items}}{{if not .status}}{{.metadata.name}}{\n"}\n{{end}}' | xargs oc adm certificate approve
```

- After all client and server CSRs have been approved, the machines have the **Ready** status. Verify this by running the following command:

```
$ oc get nodes
```

#### Example output

```
NAME      STATUS   ROLES    AGE   VERSION
master-0 Ready    master   73m   v1.23.0
```

```

master-1 Ready   master 73m v1.23.0
master-2 Ready   master 74m v1.23.0
worker-0 Ready   worker 11m v1.23.0
worker-1 Ready   worker 11m v1.23.0

```

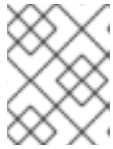
**NOTE**

It can take a few minutes after approval of the server CSRs for the machines to transition to the **Ready** status.

**Additional information**

- For more information on CSRs, see [Certificate Signing Requests](#).

**10.3.18. Initial Operator configuration**

After the control plane initializes, you must immediately configure some Operators so that they all become available.

**Prerequisites**

- Your control plane has initialized.

**Procedure**

1. Watch the cluster components come online:

```
$ watch -n5 oc get clusteroperators
```

**Example output**

NAME	VERSION	AVAILABLE	PROGRESSING	DEGRADED	SINCE
authentication	4.10.0	True	False	False	19m
baremetal	4.10.0	True	False	False	37m
cloud-credential	4.10.0	True	False	False	40m
cluster-autoscaler	4.10.0	True	False	False	37m
config-operator	4.10.0	True	False	False	38m
console	4.10.0	True	False	False	26m
csi-snapshot-controller	4.10.0	True	False	False	37m
dns	4.10.0	True	False	False	37m
etcd	4.10.0	True	False	False	36m
image-registry	4.10.0	True	False	False	31m
ingress	4.10.0	True	False	False	30m
insights	4.10.0	True	False	False	31m
kube-apiserver	4.10.0	True	False	False	26m
kube-controller-manager	4.10.0	True	False	False	36m
kube-scheduler	4.10.0	True	False	False	36m
kube-storage-version-migrator	4.10.0	True	False	False	37m
machine-api	4.10.0	True	False	False	29m
machine-approver	4.10.0	True	False	False	37m
machine-config	4.10.0	True	False	False	36m
marketplace	4.10.0	True	False	False	37m
monitoring	4.10.0	True	False	False	29m

network	4.10.0	True	False	False	38m
node-tuning	4.10.0	True	False	False	37m
openshift-apiserver	4.10.0	True	False	False	32m
openshift-controller-manager	4.10.0	True	False	False	30m
openshift-samples	4.10.0	True	False	False	32m
operator-lifecycle-manager	4.10.0	True	False	False	37m
operator-lifecycle-manager-catalog	4.10.0	True	False	False	37m
operator-lifecycle-manager-packageserver	4.10.0	True	False	False	32m
service-ca	4.10.0	True	False	False	38m
storage	4.10.0	True	False	False	37m

2. Configure the Operators that are not available.

### Additional resources

- See [Gathering logs from a failed installation](#) for details about gathering data in the event of a failed OpenShift Container Platform installation.
- See [Troubleshooting Operator issues](#) for steps to check Operator pod health across the cluster and gather Operator logs for diagnosis.

#### 10.3.18.1. Image registry removed during installation

On platforms that do not provide shareable object storage, the OpenShift Image Registry Operator bootstraps itself as **Removed**. This allows **openshift-installer** to complete installations on these platform types.

After installation, you must edit the Image Registry Operator configuration to switch the **managementState** from **Removed** to **Managed**.

#### 10.3.18.2. Image registry storage configuration

The Image Registry Operator is not initially available for platforms that do not provide default storage. After installation, you must configure your registry to use storage so that the Registry Operator is made available.

Instructions are shown for configuring a persistent volume, which is required for production clusters. Where applicable, instructions are shown for configuring an empty directory as the storage location, which is available for only non-production clusters.

Additional instructions are provided for allowing the image registry to use block storage types by using the **Recreate** rollout strategy during upgrades.

#### 10.3.18.3. Configuring block registry storage

To allow the image registry to use block storage types during upgrades as a cluster administrator, you can use the **Recreate** rollout strategy.



## IMPORTANT

Block storage volumes, or block persistent volumes, are supported but not recommended for use with the image registry on production clusters. An installation where the registry is configured on block storage is not highly available because the registry cannot have more than one replica.

If you choose to use a block storage volume with the image registry, you must use a filesystem Persistent Volume Claim (PVC).

### Procedure

1. To set the image registry storage as a block storage type, patch the registry so that it uses the **Recreate** rollout strategy and runs with only one ( **1** ) replica:

```
$ oc patch config.imageregistry.operator.openshift.io/cluster --type=merge -p '{"spec": {"rolloutStrategy":"Recreate","replicas":1}}'
```

2. Provision the PV for the block storage device, and create a PVC for that volume. The requested block volume uses the ReadWriteOnce (RWO) access mode.
3. Edit the registry configuration so that it references the correct PVC.

### 10.3.19. Completing installation on user-provisioned infrastructure

After you complete the Operator configuration, you can finish installing the cluster on infrastructure that you provide.

#### Prerequisites

- Your control plane has initialized.
- You have completed the initial Operator configuration.

#### Procedure

1. Confirm that all the cluster components are online with the following command:

```
$ watch -n5 oc get clusteroperators
```

#### Example output

NAME	VERSION	AVAILABLE	PROGRESSING	DEGRADED	SINCE
authentication	4.10.0	True	False	False	19m
baremetal	4.10.0	True	False	False	37m
cloud-credential	4.10.0	True	False	False	40m
cluster-autoscaler	4.10.0	True	False	False	37m
config-operator	4.10.0	True	False	False	38m
console	4.10.0	True	False	False	26m
csi-snapshot-controller	4.10.0	True	False	False	37m
dns	4.10.0	True	False	False	37m
etcd	4.10.0	True	False	False	36m
image-registry	4.10.0	True	False	False	31m



ingress	4.10.0	True	False	False	30m
insights	4.10.0	True	False	False	31m
kube-apiserver	4.10.0	True	False	False	26m
kube-controller-manager	4.10.0	True	False	False	36m
kube-scheduler	4.10.0	True	False	False	36m
kube-storage-version-migrator	4.10.0	True	False	False	37m
machine-api	4.10.0	True	False	False	29m
machine-approver	4.10.0	True	False	False	37m
machine-config	4.10.0	True	False	False	36m
marketplace	4.10.0	True	False	False	37m
monitoring	4.10.0	True	False	False	29m
network	4.10.0	True	False	False	38m
node-tuning	4.10.0	True	False	False	37m
openshift-apiserver	4.10.0	True	False	False	32m
openshift-controller-manager	4.10.0	True	False	False	30m
openshift-samples	4.10.0	True	False	False	32m
operator-lifecycle-manager	4.10.0	True	False	False	37m
operator-lifecycle-manager-catalog	4.10.0	True	False	False	37m
operator-lifecycle-manager-packageserver	4.10.0	True	False	False	32m
service-ca	4.10.0	True	False	False	38m
storage	4.10.0	True	False	False	37m

Alternatively, the following command notifies you when all of the clusters are available. It also retrieves and displays credentials:

```
$ ./openshift-install --dir <installation_directory> wait-for install-complete 1
```

- 1** For **<installation\_directory>**, specify the path to the directory that you stored the installation files in.

### Example output

```
INFO Waiting up to 30m0s for the cluster to initialize...
```

The command succeeds when the Cluster Version Operator finishes deploying the OpenShift Container Platform cluster from Kubernetes API server.

### IMPORTANT

- The Ignition config files that the installation program generates contain certificates that expire after 24 hours, which are then renewed at that time. If the cluster is shut down before renewing the certificates and the cluster is later restarted after the 24 hours have elapsed, the cluster automatically recovers the expired certificates. The exception is that you must manually approve the pending **node-bootstrapper** certificate signing requests (CSRs) to recover kubelet certificates. See the documentation for *Recovering from expired control plane certificates* for more information.
- It is recommended that you use Ignition config files within 12 hours after they are generated because the 24-hour certificate rotates from 16 to 22 hours after the cluster is installed. By using the Ignition config files within 12 hours, you can avoid installation failure if the certificate update runs during installation.

2. Confirm that the Kubernetes API server is communicating with the pods.

a. To view a list of all pods, use the following command:

```
$ oc get pods --all-namespaces
```

#### Example output

```

NAMESPACE           NAME                                     READY  STATUS
RESTARTS  AGE
openshift-apiserver-operator  openshift-apiserver-operator-85cb746d55-zqhs8  1/1
Running   1    9m
openshift-apiserver          apiserver-67b9g                                1/1  Running  0
3m
openshift-apiserver          apiserver-ljcmx                                1/1  Running  0
1m
openshift-apiserver          apiserver-z25h4                                1/1  Running  0
2m
openshift-authentication-operator  authentication-operator-69d5d8bf84-vh2n8    1/1
Running   0    5m
...

```

b. View the logs for a pod that is listed in the output of the previous command by using the following command:

```
$ oc logs <pod_name> -n <namespace> 1
```

**1** Specify the pod name and namespace, as shown in the output of the previous command.

If the pod logs display, the Kubernetes API server can communicate with the cluster machines.

3. For an installation with Fibre Channel Protocol (FCP), additional steps are required to enable multipathing. Do not enable multipathing during installation. See "Enabling multipathing with kernel arguments on RHCOS" in the *Post-installation machine configuration tasks* documentation for more information.

### 10.3.20. Telemetry access for OpenShift Container Platform

In OpenShift Container Platform 4.10, the Telemetry service, which runs by default to provide metrics about cluster health and the success of updates, requires internet access. If your cluster is connected to the internet, Telemetry runs automatically, and your cluster is registered to [OpenShift Cluster Manager](#).

After you confirm that your [OpenShift Cluster Manager](#) inventory is correct, either maintained automatically by Telemetry or manually by using OpenShift Cluster Manager, [use subscription watch](#) to track your OpenShift Container Platform subscriptions at the account or multi-cluster level.

#### Additional resources

- See [About remote health monitoring](#) for more information about the Telemetry service

### 10.3.21. Next steps

- [Validating an installation.](#)
- [Customize your cluster.](#)
- If necessary, you can [opt out of remote health reporting](#) .
- [Set up your registry and configure registry storage](#) .

## 10.4. INSTALLING A USER-PROVISIONED BARE METAL CLUSTER ON A RESTRICTED NETWORK

In OpenShift Container Platform 4.10, you can install a cluster on bare metal infrastructure that you provision in a restricted network.

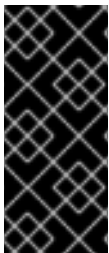

### IMPORTANT

While you might be able to follow this procedure to deploy a cluster on virtualized or cloud environments, you must be aware of additional considerations for non-bare metal platforms. Review the information in the [guidelines for deploying OpenShift Container Platform on non-tested platforms](#) before you attempt to install an OpenShift Container Platform cluster in such an environment.

### 10.4.1. Prerequisites

- You reviewed details about the [OpenShift Container Platform installation and update](#) processes.
- You read the documentation on [selecting a cluster installation method and preparing it for users](#).
- You [created a registry on your mirror host](#) and obtained the **imageContentSources** data for your version of OpenShift Container Platform.

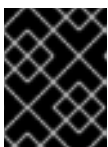

### IMPORTANT

Because the installation media is on the mirror host, you can use that computer to complete all installation steps.

- You provisioned [persistent storage](#) for your cluster. To deploy a private image registry, your storage must provide ReadWriteMany access modes.
- If you use a firewall and plan to use the Telemetry service, you [configured the firewall to allow the sites](#) that your cluster requires access to.

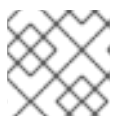

### NOTE

Be sure to also review this site list if you are configuring a proxy.

### 10.4.2. About installations in restricted networks

In OpenShift Container Platform 4.10, you can perform an installation that does not require an active connection to the internet to obtain software components. Restricted network installations can be completed using installer-provisioned infrastructure or user-provisioned infrastructure, depending on

the cloud platform to which you are installing the cluster.

If you choose to perform a restricted network installation on a cloud platform, you still require access to its cloud APIs. Some cloud functions, like Amazon Web Service's Route 53 DNS and IAM services, require internet access. Depending on your network, you might require less internet access for an installation on bare metal hardware or on VMware vSphere.

To complete a restricted network installation, you must create a registry that mirrors the contents of the OpenShift image registry and contains the installation media. You can create this registry on a mirror host, which can access both the internet and your closed network, or by using other methods that meet your restrictions.



### IMPORTANT

Because of the complexity of the configuration for user-provisioned installations, consider completing a standard user-provisioned infrastructure installation before you attempt a restricted network installation using user-provisioned infrastructure. Completing this test installation might make it easier to isolate and troubleshoot any issues that might arise during your installation in a restricted network.

#### 10.4.2.1. Additional limits

Clusters in restricted networks have the following additional limitations and restrictions:

- The **ClusterVersion** status includes an **Unable to retrieve available updates** error.
- By default, you cannot use the contents of the Developer Catalog because you cannot access the required image stream tags.

#### 10.4.3. Internet access for OpenShift Container Platform

In OpenShift Container Platform 4.10, you require access to the internet to obtain the images that are necessary to install your cluster.

You must have internet access to:

- Access [OpenShift Cluster Manager](#) to download the installation program and perform subscription management. If the cluster has internet access and you do not disable Telemetry, that service automatically entitles your cluster.
- Access [Quay.io](#) to obtain the packages that are required to install your cluster.
- Obtain the packages that are required to perform cluster updates.

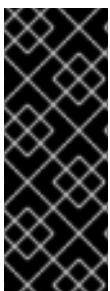

### IMPORTANT

If your cluster cannot have direct internet access, you can perform a restricted network installation on some types of infrastructure that you provision. During that process, you download the required content and use it to populate a mirror registry with the installation packages. With some installation types, the environment that you install your cluster in will not require internet access. Before you update the cluster, you update the content of the mirror registry.

#### 10.4.4. Requirements for a cluster with user-provisioned infrastructure

For a cluster that contains user-provisioned infrastructure, you must deploy all of the required machines.

This section describes the requirements for deploying OpenShift Container Platform on user-provisioned infrastructure.

#### 10.4.4.1. Required machines for cluster installation

The smallest OpenShift Container Platform clusters require the following hosts:

**Table 10.34. Minimum required hosts**

Hosts	Description
One temporary bootstrap machine	The cluster requires the bootstrap machine to deploy the OpenShift Container Platform cluster on the three control plane machines. You can remove the bootstrap machine after you install the cluster.
Three control plane machines	The control plane machines run the Kubernetes and OpenShift Container Platform services that form the control plane.
At least two compute machines, which are also known as worker machines.	The workloads requested by OpenShift Container Platform users run on the compute machines.



#### NOTE

As an exception, you can run zero compute machines in a bare metal cluster that consists of three control plane machines only. This provides smaller, more resource efficient clusters for cluster administrators and developers to use for testing, development, and production. Running one compute machine is not supported.

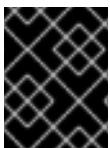

#### IMPORTANT

To maintain high availability of your cluster, use separate physical hosts for these cluster machines.

The bootstrap and control plane machines must use Red Hat Enterprise Linux CoreOS (RHCOS) as the operating system. However, the compute machines can choose between Red Hat Enterprise Linux CoreOS (RHCOS), Red Hat Enterprise Linux (RHEL) 8.4, or RHEL 8.5.

Note that RHCOS is based on Red Hat Enterprise Linux (RHEL) 8 and inherits all of its hardware certifications and requirements. See [Red Hat Enterprise Linux technology capabilities and limits](#) .

#### 10.4.4.2. Minimum resource requirements for cluster installation

Each cluster machine must meet the following minimum requirements:

**Table 10.35. Minimum resource requirements**

Machine	Operating System	CPU [1]	RAM	Storage	IOPS [2]
Bootstrap	RHCOS	4	16 GB	100 GB	300
Control plane	RHCOS	4	16 GB	100 GB	300
Compute	RHCOS, RHEL 8.4, or RHEL 8.5 [3]	2	8 GB	100 GB	300

1. One CPU is equivalent to one physical core when simultaneous multithreading (SMT), or hyperthreading, is not enabled. When enabled, use the following formula to calculate the corresponding ratio: (threads per core × cores) × sockets = CPUs.
2. OpenShift Container Platform and Kubernetes are sensitive to disk performance, and faster storage is recommended, particularly for etcd on the control plane nodes which require a 10 ms p99 fsync duration. Note that on many cloud platforms, storage size and IOPS scale together, so you might need to over-allocate storage volume to obtain sufficient performance.
3. As with all user-provisioned installations, if you choose to use RHEL compute machines in your cluster, you take responsibility for all operating system life cycle management and maintenance, including performing system updates, applying patches, and completing all other required tasks. Use of RHEL 7 compute machines is deprecated and has been removed in OpenShift Container Platform 4.10 and later.

If an instance type for your platform meets the minimum requirements for cluster machines, it is supported to use in OpenShift Container Platform.

#### 10.4.4.3. Certificate signing requests management

Because your cluster has limited access to automatic machine management when you use infrastructure that you provision, you must provide a mechanism for approving cluster certificate signing requests (CSRs) after installation. The **kube-controller-manager** only approves the kubelet client CSRs. The **machine-approver** cannot guarantee the validity of a serving certificate that is requested by using kubelet credentials because it cannot confirm that the correct machine issued the request. You must determine and implement a method of verifying the validity of the kubelet serving certificate requests and approving them.

#### Additional resources

- See [Configuring a three-node cluster](#) for details about deploying three-node clusters in bare metal environments.
- See [Approving the certificate signing requests for your machines](#) for more information about approving cluster certificate signing requests after installation.

#### 10.4.4.4. Networking requirements for user-provisioned infrastructure

All the Red Hat Enterprise Linux CoreOS (RHCOS) machines require networking to be configured in **initramfs** during boot to fetch their Ignition config files.

During the initial boot, the machines require an IP address configuration that is set either through a

DHCP server or statically by providing the required boot options. After a network connection is established, the machines download their Ignition config files from an HTTP or HTTPS server. The Ignition config files are then used to set the exact state of each machine. The Machine Config Operator completes more changes to the machines, such as the application of new certificates or keys, after installation.

It is recommended to use a DHCP server for long-term management of the cluster machines. Ensure that the DHCP server is configured to provide persistent IP addresses, DNS server information, and hostnames to the cluster machines.



#### NOTE

If a DHCP service is not available for your user-provisioned infrastructure, you can instead provide the IP networking configuration and the address of the DNS server to the nodes at RHCOS install time. These can be passed as boot arguments if you are installing from an ISO image. See the *Installing RHCOS and starting the OpenShift Container Platform bootstrap process* section for more information about static IP provisioning and advanced networking options.

The Kubernetes API server must be able to resolve the node names of the cluster machines. If the API servers and worker nodes are in different zones, you can configure a default DNS search zone to allow the API server to resolve the node names. Another supported approach is to always refer to hosts by their fully-qualified domain names in both the node objects and all DNS requests.

#### 10.4.4.4.1. Setting the cluster node hostnames through DHCP

On Red Hat Enterprise Linux CoreOS (RHCOS) machines, the hostname is set through NetworkManager. By default, the machines obtain their hostname through DHCP. If the hostname is not provided by DHCP, set statically through kernel arguments, or another method, it is obtained through a reverse DNS lookup. Reverse DNS lookup occurs after the network has been initialized on a node and can take time to resolve. Other system services can start prior to this and detect the hostname as **localhost** or similar. You can avoid this by using DHCP to provide the hostname for each cluster node.

Additionally, setting the hostnames through DHCP can bypass any manual DNS record name configuration errors in environments that have a DNS split-horizon implementation.

#### 10.4.4.4.2. Network connectivity requirements

You must configure the network connectivity between machines to allow OpenShift Container Platform cluster components to communicate. Each machine must be able to resolve the hostnames of all other machines in the cluster.

This section provides details about the ports that are required.

**Table 10.36. Ports used for all-machine to all-machine communications**

Protocol	Port	Description
ICMP	N/A	Network reachability tests
TCP	<b>1936</b>	Metrics

Protocol	Port	Description
	<b>9000-9999</b>	Host level services, including the node exporter on ports <b>9100-9101</b> and the Cluster Version Operator on port <b>9099</b> .
	<b>10250-10259</b>	The default ports that Kubernetes reserves
	<b>10256</b>	openshift-sdn
UDP	<b>4789</b>	VXLAN
	<b>6081</b>	Geneve
	<b>9000-9999</b>	Host level services, including the node exporter on ports <b>9100-9101</b> .
	<b>500</b>	IPsec IKE packets
	<b>4500</b>	IPsec NAT-T packets
TCP/UDP	<b>30000-32767</b>	Kubernetes node port
ESP	N/A	IPsec Encapsulating Security Payload (ESP)

Table 10.37. Ports used for all-machine to control plane communications

Protocol	Port	Description
TCP	<b>6443</b>	Kubernetes API

Table 10.38. Ports used for control plane machine to control plane machine communications

Protocol	Port	Description
TCP	<b>2379-2380</b>	etcd server and peer ports

### NTP configuration for user-provisioned infrastructure

OpenShift Container Platform clusters are configured to use a public Network Time Protocol (NTP) server by default. If you want to use a local enterprise NTP server, or if your cluster is being deployed in a disconnected network, you can configure the cluster to use a specific time server. For more information, see the documentation for *Configuring chrony time service*.

If a DHCP server provides NTP server information, the chrony time service on the Red Hat Enterprise Linux CoreOS (RHCOS) machines read the information and can sync the clock with the NTP servers.

### Additional resources



- [Configuring chrony time service](#)

#### 10.4.4.5. User-provisioned DNS requirements

In OpenShift Container Platform deployments, DNS name resolution is required for the following components:

- The Kubernetes API
- The OpenShift Container Platform application wildcard
- The bootstrap, control plane, and compute machines

Reverse DNS resolution is also required for the Kubernetes API, the bootstrap machine, the control plane machines, and the compute machines.

DNS A/AAAA or CNAME records are used for name resolution and PTR records are used for reverse name resolution. The reverse records are important because Red Hat Enterprise Linux CoreOS (RHCOS) uses the reverse records to set the hostnames for all the nodes, unless the hostnames are provided by DHCP. Additionally, the reverse records are used to generate the certificate signing requests (CSR) that OpenShift Container Platform needs to operate.



#### NOTE

It is recommended to use a DHCP server to provide the hostnames to each cluster node. See the *DHCP recommendations for user-provisioned infrastructure* section for more information.

The following DNS records are required for a user-provisioned OpenShift Container Platform cluster and they must be in place before installation. In each record, **<cluster\_name>** is the cluster name and **<base\_domain>** is the base domain that you specify in the **install-config.yaml** file. A complete DNS record takes the form: **<component>.<cluster\_name>.<base\_domain>..**

Table 10.39. Required DNS records

Component	Record	Description
Kubernetes API	<b>api.&lt;cluster_name&gt;.&lt;base_domain&gt;..</b>	A DNS A/AAAA or CNAME record, and a DNS PTR record, to identify the API load balancer. These records must be resolvable by both clients external to the cluster and from all the nodes within the cluster.

Component	Record	Description
	<b>api-int.&lt;cluster_name&gt;.&lt;base_domain&gt;</b>	<p>A DNS A/AAAA or CNAME record, and a DNS PTR record, to internally identify the API load balancer. These records must be resolvable from all the nodes within the cluster.</p> <div style="display: flex; align-items: flex-start;">  <div> <p><b>IMPORTANT</b></p> <p>The API server must be able to resolve the worker nodes by the hostnames that are recorded in Kubernetes. If the API server cannot resolve the node names, then proxied API calls can fail, and you cannot retrieve logs from pods.</p> </div> </div>
Routes	<b>*.apps.&lt;cluster_name&gt;.&lt;base_domain&gt;</b>	<p>A wildcard DNS A/AAAA or CNAME record that refers to the application ingress load balancer. The application ingress load balancer targets the machines that run the Ingress Controller pods. The Ingress Controller pods run on the compute machines by default. These records must be resolvable by both clients external to the cluster and from all the nodes within the cluster.</p> <p>For example, <b>console-openshift-console.apps.&lt;cluster_name&gt;.&lt;base_domain&gt;</b> is used as a wildcard route to the OpenShift Container Platform console.</p>
Bootstrap machine	<b>bootstrap.&lt;cluster_name&gt;.&lt;base_domain&gt;</b>	A DNS A/AAAA or CNAME record, and a DNS PTR record, to identify the bootstrap machine. These records must be resolvable by the nodes within the cluster.
Control plane machines	<b>&lt;master&gt;&lt;n&gt;.&lt;cluster_name&gt;.&lt;base_domain&gt;</b>	DNS A/AAAA or CNAME records and DNS PTR records to identify each machine for the control plane nodes. These records must be resolvable by the nodes within the cluster.
Compute machines	<b>&lt;worker&gt;&lt;n&gt;.&lt;cluster_name&gt;.&lt;base_domain&gt;</b>	DNS A/AAAA or CNAME records and DNS PTR records to identify each machine for the worker nodes. These records must be resolvable by the nodes within the cluster.

**NOTE**

In OpenShift Container Platform 4.4 and later, you do not need to specify etcd host and SRV records in your DNS configuration.

**TIP**

You can use the **dig** command to verify name and reverse name resolution. See the section on *Validating DNS resolution for user-provisioned infrastructure* for detailed validation steps.

### 10.4.4.5.1. Example DNS configuration for user-provisioned clusters

This section provides A and PTR record configuration samples that meet the DNS requirements for deploying OpenShift Container Platform on user-provisioned infrastructure. The samples are not meant to provide advice for choosing one DNS solution over another.

In the examples, the cluster name is **ocp4** and the base domain is **example.com**.

#### Example DNS A record configuration for a user-provisioned cluster

The following example is a BIND zone file that shows sample A records for name resolution in a user-provisioned cluster.

##### Example 10.7. Sample DNS zone database

```
$TTL 1W
@ IN SOA ns1.example.com. root (
  2019070700 ; serial
  3H ; refresh (3 hours)
  30M ; retry (30 minutes)
  2W ; expiry (2 weeks)
  1W ) ; minimum (1 week)
IN NS ns1.example.com.
IN MX 10 smtp.example.com.
;
;
ns1.example.com. IN A 192.168.1.5
smtp.example.com. IN A 192.168.1.5
;
helper.example.com. IN A 192.168.1.5
helper.ocp4.example.com. IN A 192.168.1.5
;
api.ocp4.example.com. IN A 192.168.1.5 ①
api-int.ocp4.example.com. IN A 192.168.1.5 ②
;
*.apps.ocp4.example.com. IN A 192.168.1.5 ③
;
bootstrap.ocp4.example.com. IN A 192.168.1.96 ④
;
master0.ocp4.example.com. IN A 192.168.1.97 ⑤
master1.ocp4.example.com. IN A 192.168.1.98 ⑥
master2.ocp4.example.com. IN A 192.168.1.99 ⑦
;
worker0.ocp4.example.com. IN A 192.168.1.11 ⑧
worker1.ocp4.example.com. IN A 192.168.1.7 ⑨
;
;EOF
```

- ① Provides name resolution for the Kubernetes API. The record refers to the IP address of the API load balancer.
- ② Provides name resolution for the Kubernetes API. The record refers to the IP address of the API load balancer and is used for internal cluster communications.
- ③ Provides name resolution for the wildcard routes. The record refers to the IP address of the application ingress load balancer. The application ingress load balancer targets the machines

application ingress load balancer. The application ingress load balancer targets the machines that run the Ingress Controller pods. The Ingress Controller pods run on the compute machines by default.



## NOTE

In the example, the same load balancer is used for the Kubernetes API and application ingress traffic. In production scenarios, you can deploy the API and application ingress load balancers separately so that you can scale the load balancer infrastructure for each in isolation.

- 4 Provides name resolution for the bootstrap machine.
- 5 6 7 Provides name resolution for the control plane machines.
- 8 9 Provides name resolution for the compute machines.

## Example DNS PTR record configuration for a user-provisioned cluster

The following example BIND zone file shows sample PTR records for reverse name resolution in a user-provisioned cluster.

### Example 10.8. Sample DNS zone database for reverse records

```
$TTL 1W
@ IN SOA ns1.example.com. root (
    2019070700 ; serial
    3H ; refresh (3 hours)
    30M ; retry (30 minutes)
    2W ; expiry (2 weeks)
    1W ) ; minimum (1 week)
IN NS ns1.example.com.
;
5.1.168.192.in-addr.arpa. IN PTR api.ocp4.example.com. 1
5.1.168.192.in-addr.arpa. IN PTR api-int.ocp4.example.com. 2
;
96.1.168.192.in-addr.arpa. IN PTR bootstrap.ocp4.example.com. 3
;
97.1.168.192.in-addr.arpa. IN PTR master0.ocp4.example.com. 4
98.1.168.192.in-addr.arpa. IN PTR master1.ocp4.example.com. 5
99.1.168.192.in-addr.arpa. IN PTR master2.ocp4.example.com. 6
;
11.1.168.192.in-addr.arpa. IN PTR worker0.ocp4.example.com. 7
7.1.168.192.in-addr.arpa. IN PTR worker1.ocp4.example.com. 8
;
;EOF
```

- 1 Provides reverse DNS resolution for the Kubernetes API. The PTR record refers to the record name of the API load balancer.
- 2 Provides reverse DNS resolution for the Kubernetes API. The PTR record refers to the record name of the API load balancer and is used for internal cluster communications.

- 3 Provides reverse DNS resolution for the bootstrap machine.
- 4 5 6 Provides reverse DNS resolution for the control plane machines.
- 7 8 Provides reverse DNS resolution for the compute machines.

**NOTE**

A PTR record is not required for the OpenShift Container Platform application wildcard.

**Additional resources**

- [Validating DNS resolution for user-provisioned infrastructure](#)

**10.4.4.6. Load balancing requirements for user-provisioned infrastructure**

Before you install OpenShift Container Platform, you must provision the API and application ingress load balancing infrastructure. In production scenarios, you can deploy the API and application ingress load balancers separately so that you can scale the load balancer infrastructure for each in isolation.

**NOTE**

If you want to deploy the API and application Ingress load balancers with a Red Hat Enterprise Linux (RHEL) instance, you must purchase the RHEL subscription separately.

The load balancing infrastructure must meet the following requirements:

1. **API load balancer.** Provides a common endpoint for users, both human and machine, to interact with and configure the platform. Configure the following conditions:
  - Layer 4 load balancing only. This can be referred to as Raw TCP, SSL Passthrough, or SSL Bridge mode. If you use SSL Bridge mode, you must enable Server Name Indication (SNI) for the API routes.
  - A stateless load balancing algorithm. The options vary based on the load balancer implementation.

**IMPORTANT**

Do not configure session persistence for an API load balancer. Configuring session persistence for a Kubernetes API server might cause performance issues from excess application traffic for your OpenShift Container Platform cluster and the Kubernetes API that runs inside the cluster.

Configure the following ports on both the front and back of the load balancers:

**Table 10.40. API load balancer**

Port	Back-end machines (pool members)	Internal	External	Description
------	----------------------------------	----------	----------	-------------

Port	Back-end machines (pool members)	Internal	External	Description
<b>6443</b>	Bootstrap and control plane. You remove the bootstrap machine from the load balancer after the bootstrap machine initializes the cluster control plane. You must configure the <b>/readyz</b> endpoint for the API server health check probe.	X	X	Kubernetes API server
<b>22623</b>	Bootstrap and control plane. You remove the bootstrap machine from the load balancer after the bootstrap machine initializes the cluster control plane.	X		Machine config server



### NOTE

The load balancer must be configured to take a maximum of 30 seconds from the time the API server turns off the **/readyz** endpoint to the removal of the API server instance from the pool. Within the time frame after **/readyz** returns an error or becomes healthy, the endpoint must have been removed or added. Probing every 5 or 10 seconds, with two successful requests to become healthy and three to become unhealthy, are well-tested values.

2. **Application Ingress load balancer.** Provides an ingress point for application traffic flowing in from outside the cluster. A working configuration for the Ingress router is required for an OpenShift Container Platform cluster.

Configure the following conditions:

- Layer 4 load balancing only. This can be referred to as Raw TCP, SSL Passthrough, or SSL Bridge mode. If you use SSL Bridge mode, you must enable Server Name Indication (SNI) for the ingress routes.
- A connection-based or session-based persistence is recommended, based on the options available and types of applications that will be hosted on the platform.

### TIP

If the true IP address of the client can be seen by the application Ingress load balancer, enabling source IP-based session persistence can improve performance for applications that use end-to-end TLS encryption.

Configure the following ports on both the front and back of the load balancers:

**Table 10.41. Application Ingress load balancer**

Port	Back-end machines (pool members)	Internal	External	Description
<b>443</b>	The machines that run the Ingress Controller pods, compute, or worker, by default.	X	X	HTTPS traffic
<b>80</b>	The machines that run the Ingress Controller pods, compute, or worker, by default.	X	X	HTTP traffic

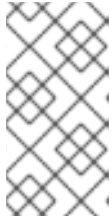
**NOTE**

If you are deploying a three-node cluster with zero compute nodes, the Ingress Controller pods run on the control plane nodes. In three-node cluster deployments, you must configure your application Ingress load balancer to route HTTP and HTTPS traffic to the control plane nodes.

#### 10.4.4.6.1. Example load balancer configuration for user-provisioned clusters

This section provides an example API and application ingress load balancer configuration that meets the load balancing requirements for user-provisioned clusters. The sample is an **/etc/haproxy/haproxy.cfg** configuration for an HAProxy load balancer. The example is not meant to provide advice for choosing one load balancing solution over another.

In the example, the same load balancer is used for the Kubernetes API and application ingress traffic. In production scenarios, you can deploy the API and application ingress load balancers separately so that you can scale the load balancer infrastructure for each in isolation.

**NOTE**

If you are using HAProxy as a load balancer and SELinux is set to **enforcing**, you must ensure that the HAProxy service can bind to the configured TCP port by running **setsebool -P haproxy\_connect\_any=1**.

#### Example 10.9. Sample API and application Ingress load balancer configuration

```
global
log      127.0.0.1 local2
pidfile  /var/run/haproxy.pid
maxconn  4000
daemon
defaults
mode     http
log      global
option   dontlognull
option   http-server-close
option   redispatch
retries  3
timeout  http-request 10s
timeout  queue       1m
timeout  connect     10s
```

```

timeout client      1m
timeout server     1m
timeout http-keep-alive 10s
timeout check      10s
maxconn            3000
listen api-server-6443 1
bind *:6443
mode tcp
server bootstrap bootstrap.ocp4.example.com:6443 check inter 1s backup 2
server master0 master0.ocp4.example.com:6443 check inter 1s
server master1 master1.ocp4.example.com:6443 check inter 1s
server master2 master2.ocp4.example.com:6443 check inter 1s
listen machine-config-server-22623 3
bind *:22623
mode tcp
server bootstrap bootstrap.ocp4.example.com:22623 check inter 1s backup 4
server master0 master0.ocp4.example.com:22623 check inter 1s
server master1 master1.ocp4.example.com:22623 check inter 1s
server master2 master2.ocp4.example.com:22623 check inter 1s
listen ingress-router-443 5
bind *:443
mode tcp
balance source
server worker0 worker0.ocp4.example.com:443 check inter 1s
server worker1 worker1.ocp4.example.com:443 check inter 1s
listen ingress-router-80 6
bind *:80
mode tcp
balance source
server worker0 worker0.ocp4.example.com:80 check inter 1s
server worker1 worker1.ocp4.example.com:80 check inter 1s

```

- 1** Port **6443** handles the Kubernetes API traffic and points to the control plane machines.
- 2** **4** The bootstrap entries must be in place before the OpenShift Container Platform cluster installation and they must be removed after the bootstrap process is complete.
- 3** Port **22623** handles the machine config server traffic and points to the control plane machines.
- 5** Port **443** handles the HTTPS traffic and points to the machines that run the Ingress Controller pods. The Ingress Controller pods run on the compute machines by default.
- 6** Port **80** handles the HTTP traffic and points to the machines that run the Ingress Controller pods. The Ingress Controller pods run on the compute machines by default.

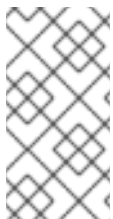

#### NOTE

If you are deploying a three-node cluster with zero compute nodes, the Ingress Controller pods run on the control plane nodes. In three-node cluster deployments, you must configure your application Ingress load balancer to route HTTP and HTTPS traffic to the control plane nodes.



**TIP**

If you are using HAProxy as a load balancer, you can check that the **haproxy** process is listening on ports **6443**, **22623**, **443**, and **80** by running **netstat -nltp** on the HAProxy node.

**10.4.5. Preparing the user-provisioned infrastructure**

Before you install OpenShift Container Platform on user-provisioned infrastructure, you must prepare the underlying infrastructure.

This section provides details about the high-level steps required to set up your cluster infrastructure in preparation for an OpenShift Container Platform installation. This includes configuring IP networking and network connectivity for your cluster nodes, enabling the required ports through your firewall, and setting up the required DNS and load balancing infrastructure.

After preparation, your cluster infrastructure must meet the requirements outlined in the *Requirements for a cluster with user-provisioned infrastructure* section.

**Prerequisites**

- You have reviewed the [OpenShift Container Platform 4.x Tested Integrations](#) page.
- You have reviewed the infrastructure requirements detailed in the *Requirements for a cluster with user-provisioned infrastructure* section.

**Procedure**

1. If you are using DHCP to provide the IP networking configuration to your cluster nodes, configure your DHCP service.
  - a. Add persistent IP addresses for the nodes to your DHCP server configuration. In your configuration, match the MAC address of the relevant network interface to the intended IP address for each node.
  - b. When you use DHCP to configure IP addressing for the cluster machines, the machines also obtain the DNS server information through DHCP. Define the persistent DNS server address that is used by the cluster nodes through your DHCP server configuration.

**NOTE**

If you are not using a DHCP service, you must provide the IP networking configuration and the address of the DNS server to the nodes at RHCOS install time. These can be passed as boot arguments if you are installing from an ISO image. See the *Installing RHCOS and starting the OpenShift Container Platform bootstrap process* section for more information about static IP provisioning and advanced networking options.

- c. Define the hostnames of your cluster nodes in your DHCP server configuration. See the *Setting the cluster node hostnames through DHCP* section for details about hostname considerations.

**NOTE**

If you are not using a DHCP service, the cluster nodes obtain their hostname through a reverse DNS lookup.

2. Ensure that your network infrastructure provides the required network connectivity between the cluster components. See the *Networking requirements for user-provisioned infrastructure* section for details about the requirements.
3. Configure your firewall to enable the ports required for the OpenShift Container Platform cluster components to communicate. See *Networking requirements for user-provisioned infrastructure* section for details about the ports that are required.



### IMPORTANT

By default, port **1936** is accessible for an OpenShift Container Platform cluster, because each control plane node needs access to this port.

Avoid using the Ingress load balancer to expose this port, because doing so might result in the exposure of sensitive information, such as statistics and metrics, related to Ingress Controllers.

4. Setup the required DNS infrastructure for your cluster.
  - a. Configure DNS name resolution for the Kubernetes API, the application wildcard, the bootstrap machine, the control plane machines, and the compute machines.
  - b. Configure reverse DNS resolution for the Kubernetes API, the bootstrap machine, the control plane machines, and the compute machines.  
See the *User-provisioned DNS requirements* section for more information about the OpenShift Container Platform DNS requirements.
5. Validate your DNS configuration.
  - a. From your installation node, run DNS lookups against the record names of the Kubernetes API, the wildcard routes, and the cluster nodes. Validate that the IP addresses in the responses correspond to the correct components.
  - b. From your installation node, run reverse DNS lookups against the IP addresses of the load balancer and the cluster nodes. Validate that the record names in the responses correspond to the correct components.  
See the *Validating DNS resolution for user-provisioned infrastructure* section for detailed DNS validation steps.
6. Provision the required API and application ingress load balancing infrastructure. See the *Load balancing requirements for user-provisioned infrastructure* section for more information about the requirements.



### NOTE

Some load balancing solutions require the DNS name resolution for the cluster nodes to be in place before the load balancing is initialized.

### Additional resources

- [Requirements for a cluster with user-provisioned infrastructure](#)
- [Installing RHCOS and starting the OpenShift Container Platform bootstrap process](#)
- [Setting the cluster node hostnames through DHCP](#)

- [Advanced RHCOS installation configuration](#)
- [Networking requirements for user-provisioned infrastructure](#)
- [User-provisioned DNS requirements](#)
- [Validating DNS resolution for user-provisioned infrastructure](#)
- [Load balancing requirements for user-provisioned infrastructure](#)

### 10.4.6. Validating DNS resolution for user-provisioned infrastructure

You can validate your DNS configuration before installing OpenShift Container Platform on user-provisioned infrastructure.



#### IMPORTANT

The validation steps detailed in this section must succeed before you install your cluster.

#### Prerequisites

- You have configured the required DNS records for your user-provisioned infrastructure.

#### Procedure

1. From your installation node, run DNS lookups against the record names of the Kubernetes API, the wildcard routes, and the cluster nodes. Validate that the IP addresses contained in the responses correspond to the correct components.
  - a. Perform a lookup against the Kubernetes API record name. Check that the result points to the IP address of the API load balancer:

```
$ dig +noall +answer @<nameserver_ip> api.<cluster_name>.<base_domain> 1
```

- 1 Replace **<nameserver\_ip>** with the IP address of the nameserver, **<cluster\_name>** with your cluster name, and **<base\_domain>** with your base domain name.

#### Example output

```
api.ocp4.example.com. 0 IN A 192.168.1.5
```

- b. Perform a lookup against the Kubernetes internal API record name. Check that the result points to the IP address of the API load balancer:

```
$ dig +noall +answer @<nameserver_ip> api-int.<cluster_name>.<base_domain>
```

#### Example output

```
api-int.ocp4.example.com. 0 IN A 192.168.1.5
```

- c. Test an example `*.apps.<cluster_name>.<base_domain>` DNS wildcard lookup. All of the application wildcard lookups must resolve to the IP address of the application ingress load balancer:

```
$ dig +noall +answer @<nameserver_ip> random.apps.<cluster_name>.<base_domain>
```

### Example output

```
random.apps.ocp4.example.com. 0 IN A 192.168.1.5
```



### NOTE

In the example outputs, the same load balancer is used for the Kubernetes API and application ingress traffic. In production scenarios, you can deploy the API and application ingress load balancers separately so that you can scale the load balancer infrastructure for each in isolation.

You can replace **random** with another wildcard value. For example, you can query the route to the OpenShift Container Platform console:

```
$ dig +noall +answer @<nameserver_ip> console-openshift-console.apps.<cluster_name>.<base_domain>
```

### Example output

```
console-openshift-console.apps.ocp4.example.com. 0 IN A 192.168.1.5
```

- d. Run a lookup against the bootstrap DNS record name. Check that the result points to the IP address of the bootstrap node:

```
$ dig +noall +answer @<nameserver_ip> bootstrap.<cluster_name>.<base_domain>
```

### Example output

```
bootstrap.ocp4.example.com. 0 IN A 192.168.1.96
```

- e. Use this method to perform lookups against the DNS record names for the control plane and compute nodes. Check that the results correspond to the IP addresses of each node.
2. From your installation node, run reverse DNS lookups against the IP addresses of the load balancer and the cluster nodes. Validate that the record names contained in the responses correspond to the correct components.

- a. Perform a reverse lookup against the IP address of the API load balancer. Check that the response includes the record names for the Kubernetes API and the Kubernetes internal API:

```
$ dig +noall +answer @<nameserver_ip> -x 192.168.1.5
```

### Example output

```
5.1.168.192.in-addr.arpa. 0 IN PTR api-int.ocp4.example.com. 1
```

```
5.1.168.192.in-addr.arpa. 0 IN PTR api.ocp4.example.com. 2
```

- 1 Provides the record name for the Kubernetes internal API.
- 2 Provides the record name for the Kubernetes API.



#### NOTE

A PTR record is not required for the OpenShift Container Platform application wildcard. No validation step is needed for reverse DNS resolution against the IP address of the application ingress load balancer.

- b. Perform a reverse lookup against the IP address of the bootstrap node. Check that the result points to the DNS record name of the bootstrap node:

```
$ dig +noall +answer @<nameserver_ip> -x 192.168.1.96
```

#### Example output

```
96.1.168.192.in-addr.arpa. 0 IN PTR bootstrap.ocp4.example.com.
```

- c. Use this method to perform reverse lookups against the IP addresses for the control plane and compute nodes. Check that the results correspond to the DNS record names of each node.

#### Additional resources

- [User-provisioned DNS requirements](#)
- [Load balancing requirements for user-provisioned infrastructure](#)

### 10.4.7. Generating a key pair for cluster node SSH access

During an OpenShift Container Platform installation, you can provide an SSH public key to the installation program. The key is passed to the Red Hat Enterprise Linux CoreOS (RHCOS) nodes through their Ignition config files and is used to authenticate SSH access to the nodes. The key is added to the `~/.ssh/authorized_keys` list for the **core** user on each node, which enables password-less authentication.

After the key is passed to the nodes, you can use the key pair to SSH in to the RHCOS nodes as the user **core**. To access the nodes through SSH, the private key identity must be managed by SSH for your local user.

If you want to SSH in to your cluster nodes to perform installation debugging or disaster recovery, you must provide the SSH public key during the installation process. The `./openshift-install gather` command also requires the SSH public key to be in place on the cluster nodes.

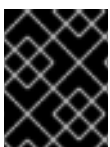

#### IMPORTANT

Do not skip this procedure in production environments, where disaster recovery and debugging is required.

**NOTE**

You must use a local key, not one that you configured with platform-specific approaches such as [AWS key pairs](#).

**Procedure**

1. If you do not have an existing SSH key pair on your local machine to use for authentication onto your cluster nodes, create one. For example, on a computer that uses a Linux operating system, run the following command:

```
$ ssh-keygen -t ed25519 -N "" -f <path>/<file_name> 1
```

- 1 Specify the path and file name, such as `~/.ssh/id_ed25519`, of the new SSH key. If you have an existing key pair, ensure your public key is in the your `~/.ssh` directory.

**NOTE**

If you plan to install an OpenShift Container Platform cluster that uses FIPS validated or Modules In Process cryptographic libraries on the **x86\_64** architecture, do not create a key that uses the **ed25519** algorithm. Instead, create a key that uses the **rsa** or **ecdsa** algorithm.

2. View the public SSH key:

```
$ cat <path>/<file_name>.pub
```

For example, run the following to view the `~/.ssh/id_ed25519.pub` public key:

```
$ cat ~/.ssh/id_ed25519.pub
```

3. Add the SSH private key identity to the SSH agent for your local user, if it has not already been added. SSH agent management of the key is required for password-less SSH authentication onto your cluster nodes, or if you want to use the `./openshift-install gather` command.

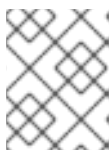
**NOTE**

On some distributions, default SSH private key identities such as `~/.ssh/id_rsa` and `~/.ssh/id_dsa` are managed automatically.

- a. If the **ssh-agent** process is not already running for your local user, start it as a background task:

```
$ eval "$(ssh-agent -s)"
```

**Example output**

```
Agent pid 31874
```

**NOTE**

If your cluster is in FIPS mode, only use FIPS-compliant algorithms to generate the SSH key. The key must be either RSA or ECDSA.

4. Add your SSH private key to the **ssh-agent**:

```
$ ssh-add <path>/<file_name> 1
```

- 1** Specify the path and file name for your SSH private key, such as `~/.ssh/id_ed25519`

**Example output**

```
Identity added: /home/<you>/<path>/<file_name> (<computer_name>)
```

**Next steps**

- When you install OpenShift Container Platform, provide the SSH public key to the installation program. If you install a cluster on infrastructure that you provision, you must provide the key to the installation program.

**Additional resources**

- [Verifying node health](#)

**10.4.8. Manually creating the installation configuration file**

For user-provisioned installations of OpenShift Container Platform, you manually generate your installation configuration file.

**Prerequisites**

- You have an SSH public key on your local machine to provide to the installation program. The key will be used for SSH authentication onto your cluster nodes for debugging and disaster recovery.
- You have obtained the OpenShift Container Platform installation program and the pull secret for your cluster.
- Obtain the **imageContentSources** section from the output of the command to mirror the repository.
- Obtain the contents of the certificate for your mirror registry.

**Procedure**

1. Create an installation directory to store your required installation assets in:

```
$ mkdir <installation_directory>
```

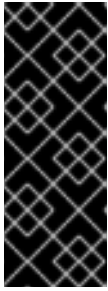
**IMPORTANT**

You must create a directory. Some installation assets, like bootstrap X.509 certificates have short expiration intervals, so you must not reuse an installation directory. If you want to reuse individual files from another cluster installation, you can copy them into your directory. However, the file names for the installation assets might change between releases. Use caution when copying installation files from an earlier OpenShift Container Platform version.

2. Customize the sample **install-config.yaml** file template that is provided and save it in the **<installation\_directory>**.

**NOTE**

You must name this configuration file **install-config.yaml**.

- Unless you use a registry that RHCOS trusts by default, such as **docker.io**, you must provide the contents of the certificate for your mirror repository in the **additionalTrustBundle** section. In most cases, you must provide the certificate for your mirror.
- You must include the **imageContentSources** section from the output of the command to mirror the repository.

**NOTE**

For some platform types, you can alternatively run **./openshift-install create install-config --dir <installation\_directory>** to generate an **install-config.yaml** file. You can provide details about your cluster configuration at the prompts.

3. Back up the **install-config.yaml** file so that you can use it to install multiple clusters.

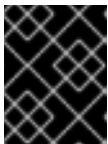
**IMPORTANT**

The **install-config.yaml** file is consumed during the next step of the installation process. You must back it up now.

**10.4.8.1. Installation configuration parameters**

Before you deploy an OpenShift Container Platform cluster, you provide a customized **install-config.yaml** installation configuration file that describes the details for your environment.

**NOTE**

After installation, you cannot modify these parameters in the **install-config.yaml** file.

**10.4.8.1.1. Required configuration parameters**

Required installation configuration parameters are described in the following table:

**Table 10.42. Required parameters**



Parameter	Description	Values
<b>apiVersion</b>	The API version for the <b>install-config.yaml</b> content. The current version is <b>v1</b> . The installer may also support older API versions.	String
<b>baseDomain</b>	The base domain of your cloud provider. The base domain is used to create routes to your OpenShift Container Platform cluster components. The full DNS name for your cluster is a combination of the <b>baseDomain</b> and <b>metadata.name</b> parameter values that uses the <b>&lt;metadata.name&gt;.&lt;baseDomain&gt;</b> format.	A fully-qualified domain or subdomain name, such as <b>example.com</b> .
<b>metadata</b>	Kubernetes resource <b>ObjectMeta</b> , from which only the <b>name</b> parameter is consumed.	Object
<b>metadata.name</b>	The name of the cluster. DNS records for the cluster are all subdomains of <b>{{.metadata.name}}</b> . <b>{{.baseDomain}}</b> .	String of lowercase letters and hyphens (-), such as <b>dev</b> .
<b>platform</b>	The configuration for the specific platform upon which to perform the installation: <b>alibabacloud</b> , <b>aws</b> , <b>baremetal</b> , <b>azure</b> , <b>gcp</b> , <b>ibmcloud</b> , <b>openstack</b> , <b>ovirt</b> , <b>vsphere</b> , or <b>{}</b> . For additional information about <b>platform.&lt;platform&gt;</b> parameters, consult the table for your specific platform that follows.	Object

Parameter	Description	Values
<b>pullSecret</b>	Get a <a href="#">pull secret from the Red Hat OpenShift Cluster Manager</a> to authenticate downloading container images for OpenShift Container Platform components from services such as Quay.io.	<pre>{   "auths":{     "cloud.openshift.com":{       "auth":"b3Blb=",       "email":"you@example.com"     },     "quay.io":{       "auth":"b3Blb=",       "email":"you@example.com"     }   } }</pre>

#### 10.4.8.1.2. Network configuration parameters

You can customize your installation configuration based on the requirements of your existing network infrastructure. For example, you can expand the IP address block for the cluster network or provide different IP address blocks than the defaults.

Only IPv4 addresses are supported.

Table 10.43. Network parameters

Parameter	Description	Values
<b>networking</b>	The configuration for the cluster network.	Object  <div style="margin-left: 20px;"> <p><b>NOTE</b></p> <p>You cannot modify parameters specified by the <b>networking</b> object after installation.</p> </div>
<b>networking.networkType</b>	The cluster network provider Container Network Interface (CNI) plugin to install.	Either <b>OpenShiftSDN</b> or <b>OVNKubernetes</b> . <b>OpenShiftSDN</b> is a CNI provider for all-Linux networks. <b>OVNKubernetes</b> is a CNI provider for Linux networks and hybrid networks that contain both Linux and Windows servers. The default value is <b>OpenShiftSDN</b> .

Parameter	Description	Values
<b>networking.clusterNetwork</b>	<p>The IP address blocks for pods.</p> <p>The default value is <b>10.128.0.0/14</b> with a host prefix of <b>/23</b>.</p> <p>If you specify multiple IP address blocks, the blocks must not overlap.</p>	<p>An array of objects. For example:</p> <pre>networking:   clusterNetwork:     - cidr: 10.128.0.0/14       hostPrefix: 23</pre>
<b>networking.clusterNetwork.cidr</b>	<p>Required if you use <b>networking.clusterNetwork</b>. An IP address block.</p> <p>An IPv4 network.</p>	<p>An IP address block in Classless Inter-Domain Routing (CIDR) notation. The prefix length for an IPv4 block is between <b>0</b> and <b>32</b>.</p>
<b>networking.clusterNetwork.hostPrefix</b>	<p>The subnet prefix length to assign to each individual node. For example, if <b>hostPrefix</b> is set to <b>23</b> then each node is assigned a <b>/23</b> subnet out of the given <b>cidr</b>. A <b>hostPrefix</b> value of <b>23</b> provides 510 (<math>2^{(32 - 23)} - 2</math>) pod IP addresses.</p>	<p>A subnet prefix.</p> <p>The default value is <b>23</b>.</p>
<b>networking.serviceNetwork</b>	<p>The IP address block for services. The default value is <b>172.30.0.0/16</b>.</p> <p>The OpenShift SDN and OVN-Kubernetes network providers support only a single IP address block for the service network.</p>	<p>An array with an IP address block in CIDR format. For example:</p> <pre>networking:   serviceNetwork:     - 172.30.0.0/16</pre>
<b>networking.machineNetwork</b>	<p>The IP address blocks for machines.</p> <p>If you specify multiple IP address blocks, the blocks must not overlap.</p>	<p>An array of objects. For example:</p> <pre>networking:   machineNetwork:     - cidr: 10.0.0.0/16</pre>
<b>networking.machineNetwork.cidr</b>	<p>Required if you use <b>networking.machineNetwork</b>. An IP address block. The default value is <b>10.0.0.0/16</b> for all platforms other than libvirt. For libvirt, the default value is <b>192.168.126.0/24</b>.</p>	<p>An IP network block in CIDR notation.</p> <p>For example, <b>10.0.0.0/16</b>.</p> <div style="display: flex; align-items: flex-start;">  <div> <p><b>NOTE</b></p> <p>Set the <b>networking.machineNetwork</b> to match the CIDR that the preferred NIC resides in.</p> </div> </div>



## 10.4.8.1.3. Optional configuration parameters

Optional installation configuration parameters are described in the following table:

Table 10.44. Optional parameters

Parameter	Description	Values
<b>additionalTrustBundle</b>	A PEM-encoded X.509 certificate bundle that is added to the nodes' trusted certificate store. This trust bundle may also be used when a proxy has been configured.	String
<b>cgroupsV2</b>	Enables <a href="#">Linux control groups version 2</a> (cgroups v2) on specific nodes in your cluster. The OpenShift Container Platform process for enabling cgroups v2 disables all cgroup version 1 controllers and hierarchies. The OpenShift Container Platform cgroups version 2 feature is in Developer Preview and is not supported by Red Hat at this time.	<b>true</b>
<b>compute</b>	The configuration for the machines that comprise the compute nodes.	Array of <b>MachinePool</b> objects.
<b>compute.architecture</b>	Determines the instruction set architecture of the machines in the pool. Currently, clusters with varied architectures are not supported. All pools must specify the same architecture. Valid values are <b>amd64</b> and <b>arm64</b> .	String
<b>compute.hyperthreading</b>	Whether to enable or disable simultaneous multithreading, or <b>hyperthreading</b> , on compute machines. By default, simultaneous multithreading is enabled to increase the performance of your machines' cores.	<b>Enabled</b> or <b>Disabled</b>
	 <p><b>IMPORTANT</b></p> <p>If you disable simultaneous multithreading, ensure that your capacity planning accounts for the dramatically decreased machine performance.</p>	

Parameter	Description	Values
<b>compute.name</b>	Required if you use <b>compute</b> . The name of the machine pool.	<b>worker</b>
<b>compute.platform</b>	Required if you use <b>compute</b> . Use this parameter to specify the cloud provider to host the worker machines. This parameter value must match the <b>controlPlane.platform</b> parameter value.	<b>alibabacloud, aws, azure, gcp, ibmcloud, openstack, ovirt, vsphere</b> , or <b>{}</b>
<b>compute.replicas</b>	The number of compute machines, which are also known as worker machines, to provision.	A positive integer greater than or equal to <b>2</b> . The default value is <b>3</b> .
<b>controlPlane</b>	The configuration for the machines that comprise the control plane.	Array of <b>MachinePool</b> objects.
<b>controlPlane.architecture</b>	Determines the instruction set architecture of the machines in the pool. Currently, clusters with varied architectures are not supported. All pools must specify the same architecture. Valid values are <b>amd64</b> and <b>arm64</b> .	String
<b>controlPlane.hyperthreading</b>	<p>Whether to enable or disable simultaneous multithreading, or <b>hyperthreading</b>, on control plane machines. By default, simultaneous multithreading is enabled to increase the performance of your machines' cores.</p> <div data-bbox="485 1469 592 1787" style="background-color: black; width: 67px; height: 142px; margin-bottom: 10px;"></div> <p><b>IMPORTANT</b></p> <p>If you disable simultaneous multithreading, ensure that your capacity planning accounts for the dramatically decreased machine performance.</p>	<b>Enabled</b> or <b>Disabled</b>
<b>controlPlane.name</b>	Required if you use <b>controlPlane</b> . The name of the machine pool.	<b>master</b>

Parameter	Description	Values
<b>controlPlane.platform</b>	Required if you use <b>controlPlane</b> . Use this parameter to specify the cloud provider that hosts the control plane machines. This parameter value must match the <b>compute.platform</b> parameter value.	<b>alibabacloud, aws, azure, gcp, ibmcloud, openstack, ovirt, vsphere</b> , or {}
<b>controlPlane.replicas</b>	The number of control plane machines to provision.	The only supported value is <b>3</b> , which is the default value.
<b>credentialsMode</b>	<p>The Cloud Credential Operator (CCO) mode. If no mode is specified, the CCO dynamically tries to determine the capabilities of the provided credentials, with a preference for mint mode on the platforms where multiple modes are supported.</p> <div style="display: flex; align-items: flex-start;"> <div style="flex: 1;">  </div> <div style="flex: 2;"> <p><b>NOTE</b></p> <p>Not all CCO modes are supported for all cloud providers. For more information on CCO modes, see the <i>Cloud Credential Operator</i> entry in the <i>Cluster Operators reference</i> content.</p> </div> </div> <div style="display: flex; align-items: flex-start; margin-top: 10px;"> <div style="flex: 1;">  </div> <div style="flex: 2;"> <p><b>NOTE</b></p> <p>If your AWS account has service control policies (SCP) enabled, you must configure the <b>credentialsMode</b> parameter to <b>Mint, Passthrough</b> or <b>Manual</b>.</p> </div> </div>	<b>Mint, Passthrough, Manual</b> or an empty string ("").

Parameter	Description	Values
<b>fips</b>	<p>Enable or disable FIPS mode. The default is <b>false</b> (disabled). If FIPS mode is enabled, the Red Hat Enterprise Linux CoreOS (RHCOS) machines that OpenShift Container Platform runs on bypass the default Kubernetes cryptography suite and use the cryptography modules that are provided with RHCOS instead.</p> <div data-bbox="486 586 592 1361" style="background-color: black; color: white; padding: 5px; margin-bottom: 10px;"> <p><b>IMPORTANT</b></p> <p>To enable FIPS mode for your cluster, you must run the installation program from a Red Hat Enterprise Linux (RHEL) computer configured to operate in FIPS mode. For more information about configuring FIPS mode on RHEL, see <a href="#">Installing the system in FIPS mode</a>. The use of FIPS validated or Modules In Process cryptographic libraries is only supported on OpenShift Container Platform deployments on the <b>x86_64</b> architecture.</p> </div> <div data-bbox="486 1406 592 1608" style="background-color: #f0f0f0; padding: 5px;"> <p><b>NOTE</b></p> <p>If you are using Azure File storage, you cannot enable FIPS mode.</p> </div>	<b>false</b> or <b>true</b>

Parameter	Description	Values
<b>imageContentSources</b>	Sources and repositories for the release-image content.	Array of objects. Includes a <b>source</b> and, optionally, <b>mirrors</b> , as described in the following rows of this table.
<b>imageContentSources.source</b>	Required if you use <b>imageContentSources</b> . Specify the repository that users refer to, for example, in image pull specifications.	String
<b>imageContentSources.mirrors</b>	Specify one or more repositories that may also contain the same images.	Array of strings
<b>publish</b>	How to publish or expose the user-facing endpoints of your cluster, such as the Kubernetes API, OpenShift routes.	<p><b>Internal</b> or <b>External</b>. The default value is <b>External</b>.</p> <p>Setting this field to <b>Internal</b> is not supported on non-cloud platforms and IBM Cloud VPC.</p> <div style="display: flex; align-items: flex-start;"> <div style="width: 60px; height: 100px; background: repeating-linear-gradient(45deg, transparent, transparent 2px, black 2px, black 4px); margin-right: 10px;"></div> <div> <p><b>IMPORTANT</b></p> <p>If the value of the field is set to <b>Internal</b>, the cluster will become non-functional. For more information, refer to <a href="#">BZ#1953035</a>.</p> </div> </div>
<b>sshKey</b>	<p>The SSH key or keys to authenticate access your cluster machines.</p> <div style="display: flex; align-items: flex-start;"> <div style="width: 60px; height: 100px; background: repeating-linear-gradient(45deg, transparent, transparent 2px, black 2px, black 4px); margin-right: 10px;"></div> <div> <p><b>NOTE</b></p> <p>For production OpenShift Container Platform clusters on which you want to perform installation debugging or disaster recovery, specify an SSH key that your <b>ssh-agent</b> process uses.</p> </div> </div>	<p>One or more keys. For example:</p> <pre>sshKey:   &lt;key1&gt;   &lt;key2&gt;   &lt;key3&gt;</pre>

#### 10.4.8.2. Sample install-config.yaml file for bare metal



You can customize the **install-config.yaml** file to specify more details about your OpenShift Container Platform cluster's platform or modify the values of the required parameters.

```

apiVersion: v1
baseDomain: example.com ①
compute: ②
- hyperthreading: Enabled ③
  name: worker
  replicas: 0 ④
controlPlane: ⑤
  hyperthreading: Enabled ⑥
  name: master
  replicas: 3 ⑦
metadata:
  name: test ⑧
networking:
  clusterNetwork:
  - cidr: 10.128.0.0/14 ⑨
    hostPrefix: 23 ⑩
  networkType: OpenShiftSDN
  serviceNetwork: ⑪
  - 172.30.0.0/16
platform:
  none: {} ⑫
fips: false ⑬
pullSecret: '{"auths":{"<local_registry>":{"auth": "<credentials>","email": "you@example.com"}}}' ⑭
sshKey: 'ssh-ed25519 AAAA...' ⑮
additionalTrustBundle: | ⑯
-----BEGIN CERTIFICATE-----
////////////////////////////////////
-----END CERTIFICATE-----
imageContentSources: ⑰
- mirrors:
  - <local_registry>/<local_repository_name>/release
  source: quay.io/openshift-release-dev/ocp-release
- mirrors:
  - <local_registry>/<local_repository_name>/release
  source: quay.io/openshift-release-dev/ocp-v4.0-art-dev

```

- ① The base domain of the cluster. All DNS records must be sub-domains of this base and include the cluster name.
- ② ⑤ The **controlPlane** section is a single mapping, but the **compute** section is a sequence of mappings. To meet the requirements of the different data structures, the first line of the **compute** section must begin with a hyphen, -, and the first line of the **controlPlane** section must not. Only one control plane pool is used.
- ③ ⑥ Specifies whether to enable or disable simultaneous multithreading (SMT), or hyperthreading. By default, SMT is enabled to increase the performance of the cores in your machines. You can disable it by setting the parameter value to **Disabled**. If you disable SMT, you must disable it in all cluster machines; this includes both control plane and compute machines.

**NOTE**

Simultaneous multithreading (SMT) is enabled by default. If SMT is not enabled in your BIOS settings, the **hyperthreading** parameter has no effect.

**IMPORTANT**

If you disable **hyperthreading**, whether in the BIOS or in the **install-config.yaml** file, ensure that your capacity planning accounts for the dramatically decreased machine performance.

- 4 You must set this value to **0** when you install OpenShift Container Platform on user-provisioned infrastructure. In installer-provisioned installations, the parameter controls the number of compute machines that the cluster creates and manages for you. In user-provisioned installations, you must manually deploy the compute machines before you finish installing the cluster.

**NOTE**

If you are installing a three-node cluster, do not deploy any compute machines when you install the Red Hat Enterprise Linux CoreOS (RHCOS) machines.

- 7 The number of control plane machines that you add to the cluster. Because the cluster uses these values as the number of etcd endpoints in the cluster, the value must match the number of control plane machines that you deploy.
- 8 The cluster name that you specified in your DNS records.
- 9 A block of IP addresses from which pod IP addresses are allocated. This block must not overlap with existing physical networks. These IP addresses are used for the pod network. If you need to access the pods from an external network, you must configure load balancers and routers to manage the traffic.

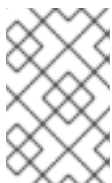
**NOTE**

Class E CIDR range is reserved for a future use. To use the Class E CIDR range, you must ensure your networking environment accepts the IP addresses within the Class E CIDR range.

- 10 The subnet prefix length to assign to each individual node. For example, if **hostPrefix** is set to **23**, then each node is assigned a **/23** subnet out of the given **cidr**, which allows for 510 ( $2^{(32 - 23)} - 2$ ) pod IP addresses. If you are required to provide access to nodes from an external network, configure load balancers and routers to manage the traffic.
- 11 The IP address pool to use for service IP addresses. You can enter only one IP address pool. This block must not overlap with existing physical networks. If you need to access the services from an external network, configure load balancers and routers to manage the traffic.
- 12 You must set the platform to **none**. You cannot provide additional platform configuration variables for your platform.



## IMPORTANT

Clusters that are installed with the platform type **none** are unable to use some features, such as managing compute machines with the Machine API. This limitation applies even if the compute machines that are attached to the cluster are installed on a platform that would normally support the feature. This parameter cannot be changed after installation.

- 13 Whether to enable or disable FIPS mode. By default, FIPS mode is not enabled. If FIPS mode is enabled, the Red Hat Enterprise Linux CoreOS (RHCOS) machines that OpenShift Container Platform runs on bypass the default Kubernetes cryptography suite and use the cryptography modules that are provided with RHCOS instead.



## IMPORTANT

To enable FIPS mode for your cluster, you must run the installation program from a Red Hat Enterprise Linux (RHEL) computer configured to operate in FIPS mode. For more information about configuring FIPS mode on RHEL, see [Installing the system in FIPS mode](#). The use of FIPS validated or Modules In Process cryptographic libraries is only supported on OpenShift Container Platform deployments on the **x86\_64** architecture.

- 14 For **<local\_registry>**, specify the registry domain name, and optionally the port, that your mirror registry uses to serve content. For example, **registry.example.com** or **registry.example.com:5000**. For **<credentials>**, specify the base64-encoded user name and password for your mirror registry.
- 15 The SSH public key for the **core** user in Red Hat Enterprise Linux CoreOS (RHCOS).

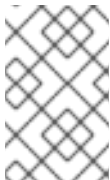

## NOTE

For production OpenShift Container Platform clusters on which you want to perform installation debugging or disaster recovery, specify an SSH key that your **ssh-agent** process uses.

- 16 Provide the contents of the certificate file that you used for your mirror registry.
- 17 Provide the **imageContentSources** section from the output of the command to mirror the repository.

### Additional resources

- See [Load balancing requirements for user-provisioned infrastructure](#) for more information on the API and application ingress load balancing requirements.

### 10.4.8.3. Configuring the cluster-wide proxy during installation

Production environments can deny direct access to the internet and instead have an HTTP or HTTPS proxy available. You can configure a new OpenShift Container Platform cluster to use a proxy by configuring the proxy settings in the **install-config.yaml** file.

**NOTE**

For bare metal installations, if you do not assign node IP addresses from the range that is specified in the **networking.machineNetwork[].cidr** field in the **install-config.yaml** file, you must include them in the **proxy.noProxy** field.

**Prerequisites**

- You have an existing **install-config.yaml** file.
- You reviewed the sites that your cluster requires access to and determined whether any of them need to bypass the proxy. By default, all cluster egress traffic is proxied, including calls to hosting cloud provider APIs. You added sites to the **Proxy** object's **spec.noProxy** field to bypass the proxy if necessary.

**NOTE**

The **Proxy** object **status.noProxy** field is populated with the values of the **networking.machineNetwork[].cidr**, **networking.clusterNetwork[].cidr**, and **networking.serviceNetwork[]** fields from your installation configuration.

For installations on Amazon Web Services (AWS), Google Cloud Platform (GCP), Microsoft Azure, and Red Hat OpenStack Platform (RHOSP), the **Proxy** object **status.noProxy** field is also populated with the instance metadata endpoint (**169.254.169.254**).

**Procedure**

1. Edit your **install-config.yaml** file and add the proxy settings. For example:

```
apiVersion: v1
baseDomain: my.domain.com
proxy:
  httpProxy: http://<username>:<pswd>@<ip>:<port> 1
  httpsProxy: https://<username>:<pswd>@<ip>:<port> 2
  noProxy: example.com 3
  additionalTrustBundle: | 4
    -----BEGIN CERTIFICATE-----
    <MY_TRUSTED_CA_CERT>
    -----END CERTIFICATE-----
  ...
```

- 1 A proxy URL to use for creating HTTP connections outside the cluster. The URL scheme must be **http**.
- 2 A proxy URL to use for creating HTTPS connections outside the cluster.
- 3 A comma-separated list of destination domain names, IP addresses, or other network CIDRs to exclude from proxying. Preface a domain with **.** to match subdomains only. For example, **.y.com** matches **x.y.com**, but not **y.com**. Use **\*** to bypass the proxy for all destinations.
- 4 If provided, the installation program generates a config map that is named **user-ca-bundle** in the **openshift-config** namespace that contains one or more additional CA certificates that are required for proxying HTTPS connections. The Cluster Network Operator then

creates a **trusted-ca-bundle** config map that merges these contents with the Red Hat Enterprise Linux CoreOS (RHCOS) trust bundle, and this config map is referenced in the **trustedCA** field of the **Proxy** object. The **additionalTrustBundle** field is required unless the proxy's identity certificate is signed by an authority from the RHCOS trust bundle.

**NOTE**

The installation program does not support the proxy **readinessEndpoints** field.

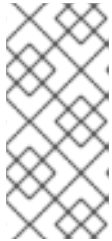
**NOTE**

If the installer times out, restart and then complete the deployment by using the **wait-for** command of the installer. For example:

```
$ ./openshift-install wait-for install-complete --log-level debug
```

2. Save the file and reference it when installing OpenShift Container Platform.

The installation program creates a cluster-wide proxy that is named **cluster** that uses the proxy settings in the provided **install-config.yaml** file. If no proxy settings are provided, a **cluster Proxy** object is still created, but it will have a nil **spec**.

**NOTE**

Only the **Proxy** object named **cluster** is supported, and no additional proxies can be created.

#### 10.4.8.4. Configuring a three-node cluster

Optionally, you can deploy zero compute machines in a bare metal cluster that consists of three control plane machines only. This provides smaller, more resource efficient clusters for cluster administrators and developers to use for testing, development, and production.

In three-node OpenShift Container Platform environments, the three control plane machines are schedulable, which means that your application workloads are scheduled to run on them.

#### Prerequisites

- You have an existing **install-config.yaml** file.

#### Procedure

- Ensure that the number of compute replicas is set to **0** in your **install-config.yaml** file, as shown in the following **compute** stanza:

```
compute:
- name: worker
  platform: {}
  replicas: 0
```



## NOTE

You must set the value of the **replicas** parameter for the compute machines to **0** when you install OpenShift Container Platform on user-provisioned infrastructure, regardless of the number of compute machines you are deploying. In installer-provisioned installations, the parameter controls the number of compute machines that the cluster creates and manages for you. This does not apply to user-provisioned installations, where the compute machines are deployed manually.

For three-node cluster installations, follow these next steps:

- If you are deploying a three-node cluster with zero compute nodes, the Ingress Controller pods run on the control plane nodes. In three-node cluster deployments, you must configure your application ingress load balancer to route HTTP and HTTPS traffic to the control plane nodes. See the *Load balancing requirements for user-provisioned infrastructure* section for more information.
- When you create the Kubernetes manifest files in the following procedure, ensure that the **mastersSchedulable** parameter in the `<installation_directory>/manifests/cluster-scheduler-02-config.yml` file is set to **true**. This enables your application workloads to run on the control plane nodes.
- Do not deploy any compute nodes when you create the Red Hat Enterprise Linux CoreOS (RHCOS) machines.

### 10.4.9. Creating the Kubernetes manifest and Ignition config files

Because you must modify some cluster definition files and manually start the cluster machines, you must generate the Kubernetes manifest and Ignition config files that the cluster needs to configure the machines.

The installation configuration file transforms into the Kubernetes manifests. The manifests wrap into the Ignition configuration files, which are later used to configure the cluster machines.



## IMPORTANT

- The Ignition config files that the OpenShift Container Platform installation program generates contain certificates that expire after 24 hours, which are then renewed at that time. If the cluster is shut down before renewing the certificates and the cluster is later restarted after the 24 hours have elapsed, the cluster automatically recovers the expired certificates. The exception is that you must manually approve the pending **node-bootstrapper** certificate signing requests (CSRs) to recover kubelet certificates. See the documentation for *Recovering from expired control plane certificates* for more information.
- It is recommended that you use Ignition config files within 12 hours after they are generated because the 24-hour certificate rotates from 16 to 22 hours after the cluster is installed. By using the Ignition config files within 12 hours, you can avoid installation failure if the certificate update runs during installation.

### Prerequisites

- You obtained the OpenShift Container Platform installation program. For a restricted network installation, these files are on your mirror host.

- You created the **install-config.yaml** installation configuration file.

## Procedure

- Change to the directory that contains the OpenShift Container Platform installation program and generate the Kubernetes manifests for the cluster:

```
$ ./openshift-install create manifests --dir <installation_directory> 1
```

- For **<installation\_directory>**, specify the installation directory that contains the **install-config.yaml** file you created.



### WARNING

If you are installing a three-node cluster, skip the following step to allow the control plane nodes to be schedulable.

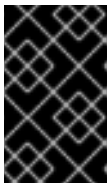

### IMPORTANT

When you configure control plane nodes from the default unschedulable to schedulable, additional subscriptions are required. This is because control plane nodes then become worker nodes.

- Check that the **mastersSchedulable** parameter in the **<installation\_directory>/manifests/cluster-scheduler-02-config.yml** Kubernetes manifest file is set to **false**. This setting prevents pods from being scheduled on the control plane machines:
  - Open the **<installation\_directory>/manifests/cluster-scheduler-02-config.yml** file.
  - Locate the **mastersSchedulable** parameter and ensure that it is set to **false**.
  - Save and exit the file.
- To create the Ignition configuration files, run the following command from the directory that contains the installation program:

```
$ ./openshift-install create ignition-configs --dir <installation_directory> 1
```

- For **<installation\_directory>**, specify the same installation directory.

Ignition config files are created for the bootstrap, control plane, and compute nodes in the installation directory. The **kubeadmin-password** and **kubeconfig** files are created in the **./<installation\_directory>/auth** directory:

```
.
├── auth
│   ├── kubeadmin-password
```

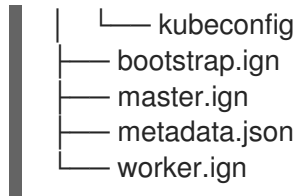

### Additional resources

- See [Recovering from expired control plane certificates](#) for more information about recovering kubelet certificates.

## 10.4.10. Configuring chrony time service

You must set the time server and related settings used by the chrony time service (**chronyd**) by modifying the contents of the **chrony.conf** file and passing those contents to your nodes as a machine config.

### Procedure

1. Create a Butane config including the contents of the **chrony.conf** file. For example, to configure chrony on worker nodes, create a **99-worker-chrony.bu** file.



### NOTE

See "Creating machine configs with Butane" for information about Butane.

```

variant: openshift
version: 4.10.0
metadata:
  name: 99-worker-chrony 1
  labels:
    machineconfiguration.openshift.io/role: worker 2
storage:
  files:
  - path: /etc/chrony.conf
    mode: 0644 3
    overwrite: true
  contents:
    inline: |
      pool 0.rhel.pool.ntp.org iburst 4
      driftfile /var/lib/chrony/drift
      makestep 1.0 3
      rtsync
      logdir /var/log/chrony

```

- 1** **2** On control plane nodes, substitute **master** for **worker** in both of these locations.
- 3** Specify an octal value mode for the **mode** field in the machine config file. After creating the file and applying the changes, the **mode** is converted to a decimal value. You can check the YAML file with the command **oc get mc <mc-name> -o yaml**.
- 4** Specify any valid, reachable time source, such as the one provided by your DHCP server.



- Use Butane to generate a **MachineConfig** object file, **99-worker-chrony.yaml**, containing the configuration to be delivered to the nodes:

```
$ butane 99-worker-chrony.bu -o 99-worker-chrony.yaml
```

- Apply the configurations in one of two ways:

- If the cluster is not running yet, after you generate manifest files, add the **MachineConfig** object file to the **<installation\_directory>/openshift** directory, and then continue to create the cluster.
- If the cluster is already running, apply the file:

```
$ oc apply -f ./99-worker-chrony.yaml
```

### 10.4.11. Installing RHCOS and starting the OpenShift Container Platform bootstrap process

To install OpenShift Container Platform on bare metal infrastructure that you provision, you must install Red Hat Enterprise Linux CoreOS (RHCOS) on the machines. When you install RHCOS, you must provide the Ignition config file that was generated by the OpenShift Container Platform installation program for the type of machine you are installing. If you have configured suitable networking, DNS, and load balancing infrastructure, the OpenShift Container Platform bootstrap process begins automatically after the RHCOS machines have rebooted.

To install RHCOS on the machines, follow either the steps to use an ISO image or network PXE booting.



#### NOTE

The compute node deployment steps included in this installation document are RHCOS-specific. If you choose instead to deploy RHEL-based compute nodes, you take responsibility for all operating system life cycle management and maintenance, including performing system updates, applying patches, and completing all other required tasks. Only RHEL 8 compute machines are supported.

You can configure RHCOS during ISO and PXE installations by using the following methods:

- Kernel arguments:** You can use kernel arguments to provide installation-specific information. For example, you can specify the locations of the RHCOS installation files that you uploaded to your HTTP server and the location of the Ignition config file for the type of node you are installing. For a PXE installation, you can use the **APPEND** parameter to pass the arguments to the kernel of the live installer. For an ISO installation, you can interrupt the live installation boot process to add the kernel arguments. In both installation cases, you can use special **coreos.inst.\*** arguments to direct the live installer, as well as standard installation boot arguments for turning standard kernel services on or off.
- Ignition configs:** OpenShift Container Platform Ignition config files (**\*.ign**) are specific to the type of node you are installing. You pass the location of a bootstrap, control plane, or compute node Ignition config file during the RHCOS installation so that it takes effect on first boot. In special cases, you can create a separate, limited Ignition config to pass to the live system. That Ignition config could do a certain set of tasks, such as reporting success to a provisioning system after completing installation. This special Ignition config is consumed by the **coreos-installer** to be applied on first boot of the installed system. Do not provide the standard control plane and compute node Ignition configs to the live ISO directly.

- **coreos-installer:** You can boot the live ISO installer to a shell prompt, which allows you to prepare the permanent system in a variety of ways before first boot. In particular, you can run the **coreos-installer** command to identify various artifacts to include, work with disk partitions, and set up networking. In some cases, you can configure features on the live system and copy them to the installed system.

Whether to use an ISO or PXE install depends on your situation. A PXE install requires an available DHCP service and more preparation, but can make the installation process more automated. An ISO install is a more manual process and can be inconvenient if you are setting up more than a few machines.



#### NOTE

As of OpenShift Container Platform 4.6, the RHCOS ISO and other installation artifacts provide support for installation on disks with 4K sectors.

### 10.4.11.1. Installing RHCOS by using an ISO image

You can use an ISO image to install RHCOS on the machines.

#### Prerequisites

- You have created the Ignition config files for your cluster.
- You have configured suitable network, DNS and load balancing infrastructure.
- You have an HTTP server that can be accessed from your computer, and from the machines that you create.
- You have reviewed the *Advanced RHCOS installation configuration* section for different ways to configure features, such as networking and disk partitioning.

#### Procedure

1. Obtain the SHA512 digest for each of your Ignition config files. For example, you can use the following on a system running Linux to get the SHA512 digest for your **bootstrap.ign** Ignition config file:

```
$ sha512sum <installation_directory>/bootstrap.ign
```

The digests are provided to the **coreos-installer** in a later step to validate the authenticity of the Ignition config files on the cluster nodes.

2. Upload the bootstrap, control plane, and compute node Ignition config files that the installation program created to your HTTP server. Note the URLs of these files.



#### IMPORTANT

You can add or change configuration settings in your Ignition configs before saving them to your HTTP server. If you plan to add more compute machines to your cluster after you finish installation, do not delete these files.

3. From the installation host, validate that the Ignition config files are available on the URLs. The following example gets the Ignition config file for the bootstrap node:

```
$ curl -k http://<HTTP_server>/bootstrap.ign 1
```

### Example output

```
% Total % Received % Xferd Average Speed Time Time Time Current
          Dload Upload Total Spent Left Speed
0 0 0 0 0 0 0 0 --:--:-- --:--:-- --:--:-- 0{"ignition":
{"version":"3.2.0"},"passwd":{"users":[{"name":"core","sshAuthorizedKeys":["ssh-rsa...
```

Replace **bootstrap.ign** with **master.ign** or **worker.ign** in the command to validate that the Ignition config files for the control plane and compute nodes are also available.

- Although it is possible to obtain the RHCOS images that are required for your preferred method of installing operating system instances from the [RHCOS image mirror](#) page, the recommended way to obtain the correct version of your RHCOS images are from the output of **openshift-install** command:

```
$ openshift-install coreos print-stream-json | grep '\.iso[^\.]'
```

### Example output

```
"location": "<url>/art/storage/releases/rhcos-4.10-aarch64/<release>/aarch64/rhcos-
<release>-live.aarch64.iso",
"location": "<url>/art/storage/releases/rhcos-4.10-ppc64le/<release>/ppc64le/rhcos-
<release>-live.ppc64le.iso",
"location": "<url>/art/storage/releases/rhcos-4.10-s390x/<release>/s390x/rhcos-<release>-
live.s390x.iso",
"location": "<url>/art/storage/releases/rhcos-4.10/<release>/x86_64/rhcos-<release>-
live.x86_64.iso",
```

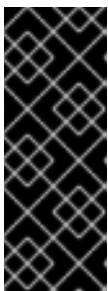

### IMPORTANT

The RHCOS images might not change with every release of OpenShift Container Platform. You must download images with the highest version that is less than or equal to the OpenShift Container Platform version that you install. Use the image versions that match your OpenShift Container Platform version if they are available. Use only ISO images for this procedure. RHCOS qcow2 images are not supported for this installation type.

ISO file names resemble the following example:

**rhcos-<version>-live.<architecture>.iso**

- Use the ISO to start the RHCOS installation. Use one of the following installation options:
  - Burn the ISO image to a disk and boot it directly.
  - Use ISO redirection by using a lights-out management (LOM) interface.
- Boot the RHCOS ISO image without specifying any options or interrupting the live boot sequence. Wait for the installer to boot into a shell prompt in the RHCOS live environment.

**NOTE**

It is possible to interrupt the RHCOS installation boot process to add kernel arguments. However, for this ISO procedure you should use the **coreos-installer** command as outlined in the following steps, instead of adding kernel arguments.

7. Run the **coreos-installer** command and specify the options that meet your installation requirements. At a minimum, you must specify the URL that points to the Ignition config file for the node type, and the device that you are installing to:

```
$ sudo coreos-installer install --ignition-url=http://<HTTP_server>/<node_type>.ign <device>
--ignition-hash=sha512-<digest> 1 2
```

- 1 1 You must run the **coreos-installer** command by using **sudo**, because the **core** user does not have the required root privileges to perform the installation.
- 2 The **--ignition-hash** option is required when the Ignition config file is obtained through an HTTP URL to validate the authenticity of the Ignition config file on the cluster node. **<digest>** is the Ignition config file SHA512 digest obtained in a preceding step.

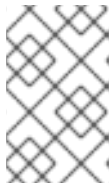
**NOTE**

If you want to provide your Ignition config files through an HTTPS server that uses TLS, you can add the internal certificate authority (CA) to the system trust store before running **coreos-installer**.

The following example initializes a bootstrap node installation to the **/dev/sda** device. The Ignition config file for the bootstrap node is obtained from an HTTP web server with the IP address 192.168.1.2:

```
$ sudo coreos-installer install --ignition-
url=http://192.168.1.2:80/installation_directory/bootstrap.ign /dev/sda --ignition-hash=sha512-
a5a2d43879223273c9b60af66b44202a1d1248fc01cf156c46d4a79f552b6bad47bc8cc78ddf011
6e80c59d2ea9e32ba53bc807afbca581aa059311def2c3e3b
```

8. Monitor the progress of the RHCOS installation on the console of the machine.

**IMPORTANT**

Be sure that the installation is successful on each node before commencing with the OpenShift Container Platform installation. Observing the installation process can also help to determine the cause of RHCOS installation issues that might arise.

9. After RHCOS installs, you must reboot the system. During the system reboot, it applies the Ignition config file that you specified.
10. Check the console output to verify that Ignition ran.

**Example command**

```
Ignition: ran on 2022/03/14 14:48:33 UTC (this boot)
Ignition: user-provided config was applied
```

- Continue to create the other machines for your cluster.

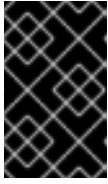

### IMPORTANT

You must create the bootstrap and control plane machines at this time. If the control plane machines are not made schedulable, also create at least two compute machines before you install OpenShift Container Platform.

If the required network, DNS, and load balancer infrastructure are in place, the OpenShift Container Platform bootstrap process begins automatically after the RHCOS nodes have rebooted.



### NOTE

RHCOS nodes do not include a default password for the **core** user. You can access the nodes by running **ssh core@<node>.<cluster\_name>.<base\_domain>** as a user with access to the SSH private key that is paired to the public key that you specified in your **install\_config.yaml** file. OpenShift Container Platform 4 cluster nodes running RHCOS are immutable and rely on Operators to apply cluster changes. Accessing cluster nodes by using SSH is not recommended. However, when investigating installation issues, if the OpenShift Container Platform API is not available, or the kubelet is not properly functioning on a target node, SSH access might be required for debugging or disaster recovery.

#### 10.4.11.2. Installing RHCOS by using PXE or iPXE booting

You can use PXE or iPXE booting to install RHCOS on the machines.

##### Prerequisites

- You have created the Ignition config files for your cluster.
- You have configured suitable network, DNS and load balancing infrastructure.
- You have configured suitable PXE or iPXE infrastructure.
- You have an HTTP server that can be accessed from your computer, and from the machines that you create.
- You have reviewed the *Advanced RHCOS installation configuration* section for different ways to configure features, such as networking and disk partitioning.

##### Procedure

- Upload the bootstrap, control plane, and compute node Ignition config files that the installation program created to your HTTP server. Note the URLs of these files.

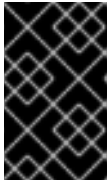

## IMPORTANT

You can add or change configuration settings in your Ignition configs before saving them to your HTTP server. If you plan to add more compute machines to your cluster after you finish installation, do not delete these files.

- From the installation host, validate that the Ignition config files are available on the URLs. The following example gets the Ignition config file for the bootstrap node:

```
$ curl -k http://<HTTP_server>/bootstrap.ign 1
```

### Example output

```
% Total    % Received % Xferd Average Speed   Time    Time     Time  Current
           Dload  Upload   Total   Spent    Left  Speed
  0   0   0   0   0   0   0   0   0  --:--:-- --:--:-- --:--:--    0{"ignition":
{"version":"3.2.0"},"passwd":{"users":[{"name":"core","sshAuthorizedKeys":["ssh-rsa...
```

Replace **bootstrap.ign** with **master.ign** or **worker.ign** in the command to validate that the Ignition config files for the control plane and compute nodes are also available.

- Although it is possible to obtain the RHCOS **kernel**, **initramfs** and **rootfs** files that are required for your preferred method of installing operating system instances from the [RHCOS image mirror](#) page, the recommended way to obtain the correct version of your RHCOS files are from the output of **openshift-install** command:

```
$ openshift-install coreos print-stream-json | grep -Eo "https.*(kernel-|initramfs-|rootfs-)\w+(\.img)?"
```

### Example output

```
"<url>/art/storage/releases/rhcos-4.10-aarch64/<release>/aarch64/rhcos-<release>-live-
kernel-aarch64"
"<url>/art/storage/releases/rhcos-4.10-aarch64/<release>/aarch64/rhcos-<release>-live-
initramfs.aarch64.img"
"<url>/art/storage/releases/rhcos-4.10-aarch64/<release>/aarch64/rhcos-<release>-live-
rootfs.aarch64.img"
"<url>/art/storage/releases/rhcos-4.10-ppc64le/49.84.202110081256-0/ppc64le/rhcos-
<release>-live-kernel-ppc64le"
"<url>/art/storage/releases/rhcos-4.10-ppc64le/<release>/ppc64le/rhcos-<release>-live-
initramfs.ppc64le.img"
"<url>/art/storage/releases/rhcos-4.10-ppc64le/<release>/ppc64le/rhcos-<release>-live-
rootfs.ppc64le.img"
"<url>/art/storage/releases/rhcos-4.10-s390x/<release>/s390x/rhcos-<release>-live-kernel-
s390x"
"<url>/art/storage/releases/rhcos-4.10-s390x/<release>/s390x/rhcos-<release>-live-
initramfs.s390x.img"
"<url>/art/storage/releases/rhcos-4.10-s390x/<release>/s390x/rhcos-<release>-live-
rootfs.s390x.img"
"<url>/art/storage/releases/rhcos-4.10/<release>/x86_64/rhcos-<release>-live-kernel-
x86_64"
"<url>/art/storage/releases/rhcos-4.10/<release>/x86_64/rhcos-<release>-live-
```

```
initramfs.x86_64.img"
"<url>/art/storage/releases/rhcos-4.10/<release>/x86_64/rhcos-<release>-live-
rootfs.x86_64.img"
```

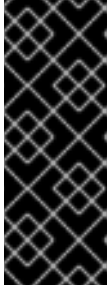

## IMPORTANT

The RHCOS artifacts might not change with every release of OpenShift Container Platform. You must download images with the highest version that is less than or equal to the OpenShift Container Platform version that you install. Only use the appropriate **kernel**, **initramfs**, and **rootfs** artifacts described below for this procedure. RHCOS QCOW2 images are not supported for this installation type.

The file names contain the OpenShift Container Platform version number. They resemble the following examples:

- **kernel:** rhcos-<version>-live-kernel-<architecture>
- **initramfs:** rhcos-<version>-live-initramfs.<architecture>.img
- **rootfs:** rhcos-<version>-live-rootfs.<architecture>.img

4. Upload the **rootfs**, **kernel**, and **initramfs** files to your HTTP server.

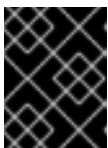

## IMPORTANT

If you plan to add more compute machines to your cluster after you finish installation, do not delete these files.

5. Configure the network boot infrastructure so that the machines boot from their local disks after RHCOS is installed on them.
6. Configure PXE or iPXE installation for the RHCOS images and begin the installation. Modify one of the following example menu entries for your environment and verify that the image and Ignition files are properly accessible:

- For PXE (**x86\_64**):

```
DEFAULT pxeboot
TIMEOUT 20
PROMPT 0
LABEL pxeboot
  KERNEL http://<HTTP_server>/rhcos-<version>-live-kernel-<architecture> 1
  APPEND initrd=http://<HTTP_server>/rhcos-<version>-live-initramfs.
<architecture>.img coreos.live.rootfs_url=http://<HTTP_server>/rhcos-<version>-live-
rootfs.<architecture>.img coreos.inst.install_dev=/dev/sda
coreos.inst.ignition_url=http://<HTTP_server>/bootstrap.ign 2 3
```

- 1** Specify the location of the live **kernel** file that you uploaded to your HTTP server. The URL must be HTTP, TFTP, or FTP; HTTPS and NFS are not supported.
- 2** If you use multiple NICs, specify a single interface in the **ip** option. For example, to use DHCP on a NIC that is named **eno1**, set **ip=eno1:dhcp**.

- 3 Specify the locations of the RHCOS files that you uploaded to your HTTP server. The **initrd** parameter value is the location of the **initramfs** file, the **coreos.live.rootfs\_url**



#### NOTE

This configuration does not enable serial console access on machines with a graphical console. To configure a different console, add one or more **console=** arguments to the **APPEND** line. For example, add **console=tty0 console=ttyS0** to set the first PC serial port as the primary console and the graphical console as a secondary console. For more information, see [How does one set up a serial terminal and/or console in Red Hat Enterprise Linux?](#)

- For iPXE (**x86\_64 + aarch64**):

```
kernel http://<HTTP_server>/rhcos-<version>-live-kernel-<architecture> initrd=main
coreos.live.rootfs_url=http://<HTTP_server>/rhcos-<version>-live-rootfs.
<architecture>.img coreos.inst.install_dev=/dev/sda
coreos.inst.ignition_url=http://<HTTP_server>/bootstrap.ign 1 2
initrd --name main http://<HTTP_server>/rhcos-<version>-live-initramfs.
<architecture>.img 3
boot
```

- 1 Specify the locations of the RHCOS files that you uploaded to your HTTP server. The **kernel** parameter value is the location of the **kernel** file, the **initrd=main** argument is needed for booting on UEFI systems, the **coreos.live.rootfs\_url** parameter value is the location of the **rootfs** file, and the **coreos.inst.ignition\_url** parameter value is the location of the bootstrap Ignition config file.
- 2 If you use multiple NICs, specify a single interface in the **ip** option. For example, to use DHCP on a NIC that is named **eno1**, set **ip=eno1:dhcp**.
- 3 Specify the location of the **initramfs** file that you uploaded to your HTTP server.



#### NOTE

This configuration does not enable serial console access on machines with a graphical console. To configure a different console, add one or more **console=** arguments to the **kernel** line. For example, add **console=tty0 console=ttyS0** to set the first PC serial port as the primary console and the graphical console as a secondary console. For more information, see [How does one set up a serial terminal and/or console in Red Hat Enterprise Linux?](#)

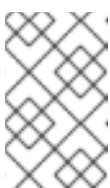

#### NOTE

To network boot the CoreOS **kernel** on **aarch64** architecture, you need to use a version of iPXE build with the **IMAGE\_GZIP** option enabled. See [IMAGE\\_GZIP option in iPXE](#).

- For PXE (with UEFI and Grub as second stage) on **aarch64**:



```

menuentry 'Install CoreOS' {
  linux rhcos-<version>-live-kernel-<architecture>
  coreos.live.rootfs_url=http://<HTTP_server>/rhcos-<version>-live-rootfs.
  <architecture>.img coreos.inst.install_dev=/dev/sda
  coreos.inst.ignition_url=http://<HTTP_server>/bootstrap.ign 1 2
  initrd rhcos-<version>-live-initramfs.<architecture>.img 3
}

```

- 1** Specify the locations of the RHCOS files that you uploaded to your HTTP/TFTP server. The **kernel** parameter value is the location of the **kernel** file on your TFTP server. The **coreos.live.rootfs\_url** parameter value is the location of the **rootfs** file, and the **coreos.inst.ignition\_url** parameter value is the location of the bootstrap Ignition config file on your HTTP Server.
- 2** If you use multiple NICs, specify a single interface in the **ip** option. For example, to use DHCP on a NIC that is named **eno1**, set **ip=eno1:dhcp**.
- 3** Specify the location of the **initramfs** file that you uploaded to your TFTP server.

7. Monitor the progress of the RHCOS installation on the console of the machine.

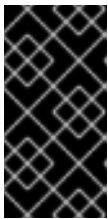

### IMPORTANT

Be sure that the installation is successful on each node before commencing with the OpenShift Container Platform installation. Observing the installation process can also help to determine the cause of RHCOS installation issues that might arise.

8. After RHCOS installs, the system reboots. During reboot, the system applies the Ignition config file that you specified.
9. Check the console output to verify that Ignition ran.

### Example command

```

Ignition: ran on 2022/03/14 14:48:33 UTC (this boot)
Ignition: user-provided config was applied

```

10. Continue to create the machines for your cluster.



### IMPORTANT

You must create the bootstrap and control plane machines at this time. If the control plane machines are not made schedulable, also create at least two compute machines before you install the cluster.

If the required network, DNS, and load balancer infrastructure are in place, the OpenShift Container Platform bootstrap process begins automatically after the RHCOS nodes have rebooted.



## NOTE

RHCOS nodes do not include a default password for the **core** user. You can access the nodes by running **ssh core@<node>.<cluster\_name>.<base\_domain>** as a user with access to the SSH private key that is paired to the public key that you specified in your **install\_config.yaml** file. OpenShift Container Platform 4 cluster nodes running RHCOS are immutable and rely on Operators to apply cluster changes. Accessing cluster nodes by using SSH is not recommended. However, when investigating installation issues, if the OpenShift Container Platform API is not available, or the kubelet is not properly functioning on a target node, SSH access might be required for debugging or disaster recovery.

### 10.4.11.3. Advanced RHCOS installation configuration

A key benefit for manually provisioning the Red Hat Enterprise Linux CoreOS (RHCOS) nodes for OpenShift Container Platform is to be able to do configuration that is not available through default OpenShift Container Platform installation methods. This section describes some of the configurations that you can do using techniques that include:

- Passing kernel arguments to the live installer
- Running **coreos-installer** manually from the live system
- Customizing a live ISO or PXE boot image

The advanced configuration topics for manual Red Hat Enterprise Linux CoreOS (RHCOS) installations detailed in this section relate to disk partitioning, networking, and using Ignition configs in different ways.

#### 10.4.11.3.1. Using advanced networking options for PXE and ISO installations

Networking for OpenShift Container Platform nodes uses DHCP by default to gather all necessary configuration settings. To set up static IP addresses or configure special settings, such as bonding, you can do one of the following:

- Pass special kernel parameters when you boot the live installer.
- Use a machine config to copy networking files to the installed system.
- Configure networking from a live installer shell prompt, then copy those settings to the installed system so that they take effect when the installed system first boots.

To configure a PXE or iPXE installation, use one of the following options:

- See the "Advanced RHCOS installation reference" tables.
- Use a machine config to copy networking files to the installed system.

To configure an ISO installation, use the following procedure.

#### Procedure

1. Boot the ISO installer.
2. From the live system shell prompt, configure networking for the live system using available RHEL tools, such as **nmcli** or **nmtui**.

- Run the **coreos-installer** command to install the system, adding the **--copy-network** option to copy networking configuration. For example:

```
$ sudo coreos-installer install --copy-network \
  --ignition-url=http://host/worker.ign /dev/sda
```



### IMPORTANT

The **--copy-network** option only copies networking configuration found under **/etc/NetworkManager/system-connections**. In particular, it does not copy the system hostname.

- Reboot into the installed system.

### Additional resources

- See [Getting started with nmcli](#) and [Getting started with nmtui](#) in the RHEL 8 documentation for more information about the **nmcli** and **nmtui** tools.

#### 10.4.11.3.2. Disk partitioning

The disk partitions are created on OpenShift Container Platform cluster nodes during the Red Hat Enterprise Linux CoreOS (RHCOS) installation. Each RHCOS node of a particular architecture uses the same partition layout, unless the default partitioning configuration is overridden. During the RHCOS installation, the size of the root file system is increased to use the remaining available space on the target device.

There are two cases where you might want to override the default partitioning when installing RHCOS on an OpenShift Container Platform cluster node:

- Creating separate partitions: For greenfield installations on an empty disk, you might want to add separate storage to a partition. This is officially supported for mounting **/var** or a subdirectory of **/var**, such as **/var/lib/etcd**, on a separate partition, but not both.

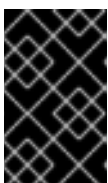

### IMPORTANT

For disk sizes larger than 100GB, and especially disk sizes larger than 1TB, create a separate **/var** partition. See "Creating a separate **/var** partition" and this [Red Hat Knowledgebase article](#) for more information.

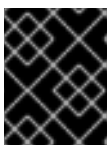

### IMPORTANT

Kubernetes supports only two file system partitions. If you add more than one partition to the original configuration, Kubernetes cannot monitor all of them.

- Retaining existing partitions: For a brownfield installation where you are reinstalling OpenShift Container Platform on an existing node and want to retain data partitions installed from your previous operating system, there are both boot arguments and options to **coreos-installer** that allow you to retain existing data partitions.

**WARNING**

The use of custom partitions could result in those partitions not being monitored by OpenShift Container Platform or alerted on. If you are overriding the default partitioning, see [Understanding OpenShift File System Monitoring \(eviction conditions\)](#) for more information about how OpenShift Container Platform monitors your host file systems.

**10.4.11.3.2.1. Creating a separate `/var` partition**

In general, you should use the default disk partitioning that is created during the RHCOS installation. However, there are cases where you might want to create a separate partition for a directory that you expect to grow.

OpenShift Container Platform supports the addition of a single partition to attach storage to either the `/var` directory or a subdirectory of `/var`. For example:

- **`/var/lib/containers`**: Holds container-related content that can grow as more images and containers are added to a system.
- **`/var/lib/etcd`**: Holds data that you might want to keep separate for purposes such as performance optimization of etcd storage.
- **`/var`**: Holds data that you might want to keep separate for purposes such as auditing.

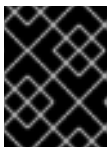
**IMPORTANT**

For disk sizes larger than 100GB, and especially larger than 1TB, create a separate `/var` partition.

Storing the contents of a `/var` directory separately makes it easier to grow storage for those areas as needed and reinstall OpenShift Container Platform at a later date and keep that data intact. With this method, you will not have to pull all your containers again, nor will you have to copy massive log files when you update systems.

The use of a separate partition for the `/var` directory or a subdirectory of `/var` also prevents data growth in the partitioned directory from filling up the root file system.

The following procedure sets up a separate `/var` partition by adding a machine config manifest that is wrapped into the Ignition config file for a node type during the preparation phase of an installation.

**Procedure**

1. On your installation host, change to the directory that contains the OpenShift Container Platform installation program and generate the Kubernetes manifests for the cluster:

```
$ openshift-install create manifests --dir <installation_directory>
```

2. Create a Butane config that configures the additional partition. For example, name the file **`$HOME/clusterconfig/98-var-partition.bu`**, change the disk device name to the name of the storage device on the **worker** systems, and set the storage size as appropriate. This example

places the **/var** directory on a separate partition:

```
variant: openshift
version: 4.10.0
metadata:
  labels:
    machineconfiguration.openshift.io/role: worker
  name: 98-var-partition
storage:
  disks:
    - device: /dev/<device_name> ❶
      partitions:
        - label: var
          start_mib: <partition_start_offset> ❷
          size_mib: <partition_size> ❸
      filesystems:
        - device: /dev/disk/by-partlabel/var
          path: /var
          format: xfs
          mount_options: [defaults, prjquota] ❹
          with_mount_unit: true
```

- ❶ The storage device name of the disk that you want to partition.
- ❷ When adding a data partition to the boot disk, a minimum offset value of 25000 mebibytes is recommended. The root file system is automatically resized to fill all available space up to the specified offset. If no offset value is specified, or if the specified value is smaller than the recommended minimum, the resulting root file system will be too small, and future reinstalls of RHCOS might overwrite the beginning of the data partition.
- ❸ The size of the data partition in mebibytes.
- ❹ The **prjquota** mount option must be enabled for filesystems used for container storage.



#### NOTE

When creating a separate **/var** partition, you cannot use different instance types for compute nodes, if the different instance types do not have the same device name.

3. Create a manifest from the Butane config and save it to the **clusterconfig/openshift** directory. For example, run the following command:

```
$ butane $HOME/clusterconfig/98-var-partition.bu -o $HOME/clusterconfig/openshift/98-var-partition.yaml
```

4. Create the Ignition config files:

```
$ openshift-install create ignition-configs --dir <installation_directory> ❶
```

- ❶ For **<installation\_directory>**, specify the same installation directory.

Ignition config files are created for the bootstrap, control plane, and compute nodes in the installation directory:

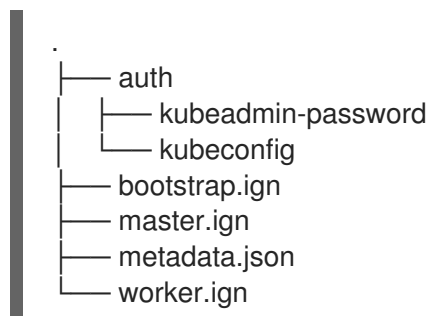

The files in the `<installation_directory>/manifest` and `<installation_directory>/openshift` directories are wrapped into the Ignition config files, including the file that contains the **98-var-partition** custom **MachineConfig** object.

### Next steps

- You can apply the custom disk partitioning by referencing the Ignition config files during the RHCOS installations.

#### 10.4.11.3.2.2. Retaining existing partitions

For an ISO installation, you can add options to the **coreos-installer** command that cause the installer to maintain one or more existing partitions. For a PXE installation, you can add **coreos.inst.\*** options to the **APPEND** parameter to preserve partitions.

Saved partitions might be data partitions from an existing OpenShift Container Platform system. You can identify the disk partitions you want to keep either by partition label or by number.



#### NOTE

If you save existing partitions, and those partitions do not leave enough space for RHCOS, the installation will fail without damaging the saved partitions.

### Retaining existing partitions during an ISO installation

This example preserves any partition in which the partition label begins with **data** (**data\***):

```
# coreos-installer install --ignition-url http://10.0.2.2:8080/user.ign \
  --save-partlabel 'data*' /dev/sda
```

The following example illustrates running the **coreos-installer** in a way that preserves the sixth (6) partition on the disk:

```
# coreos-installer install --ignition-url http://10.0.2.2:8080/user.ign \
  --save-partindex 6 /dev/sda
```

This example preserves partitions 5 and higher:

```
# coreos-installer install --ignition-url http://10.0.2.2:8080/user.ign \
  --save-partindex 5- /dev/sda
```

In the previous examples where partition saving is used, **coreos-installer** recreates the partition immediately.

### Retaining existing partitions during a PXE installation

This **APPEND** option preserves any partition in which the partition label begins with 'data' ('data\*'):

```
coreos.inst.save_partlabel=data*
```

This **APPEND** option preserves partitions 5 and higher:

```
coreos.inst.save_partindex=5-
```

This **APPEND** option preserves partition 6:

```
coreos.inst.save_partindex=6
```

#### 10.4.11.3.3. Identifying Ignition configs

When doing an RHCOS manual installation, there are two types of Ignition configs that you can provide, with different reasons for providing each one:

- **Permanent install Ignition config:** Every manual RHCOS installation needs to pass one of the Ignition config files generated by **openshift-installer**, such as **bootstrap.ign**, **master.ign** and **worker.ign**, to carry out the installation.



#### IMPORTANT

It is not recommended to modify these Ignition config files directly. You can update the manifest files that are wrapped into the Ignition config files, as outlined in examples in the preceding sections.

For PXE installations, you pass the Ignition configs on the **APPEND** line using the **coreos.inst.ignition\_url=** option. For ISO installations, after the ISO boots to the shell prompt, you identify the Ignition config on the **coreos-installer** command line with the **--ignition-url=** option. In both cases, only HTTP and HTTPS protocols are supported.

- **Live install Ignition config:** This type can be created by using the **coreos-installer customize** subcommand and its various options. With this method, the Ignition config passes to the live install medium, runs immediately upon booting, and performs setup tasks before or after the RHCOS system installs to disk. This method should only be used for performing tasks that must be done once and not applied again later, such as with advanced partitioning that cannot be done using a machine config.

For PXE or ISO boots, you can create the Ignition config and **APPEND** the **ignition.config.url=** option to identify the location of the Ignition config. You also need to append **ignition.firstboot** **ignition.platform.id=metal** or the **ignition.config.url** option will be ignored.

##### 10.4.11.3.3.1. Customizing a live RHCOS ISO or PXE install

You can use the live ISO image or PXE environment to install RHCOS by injecting an Ignition config file directly into the image. This creates a customized image that you can use to provision your system.

For an ISO image, the mechanism to do this is the **coreos-installer iso customize** subcommand, which modifies the **.iso** file with your configuration. Similarly, the mechanism for a PXE environment is the

**coreos-installer pxe customize** subcommand, which creates a new **initramfs** file that includes your customizations.

The **customize** subcommand is a general purpose tool that can embed other types of customizations as well. The following tasks are examples of some of the more common customizations:

- Inject custom CA certificates for when corporate security policy requires their use.
- Configure network settings without the need for kernel arguments.
- Embed arbitrary pre-install and post-install scripts or binaries.

#### 10.4.11.3.3.2. Customizing a live RHCOS ISO image

You can customize a live RHCOS ISO image directly with the **coreos-installer iso customize** subcommand. When you boot the ISO image, the customizations are applied automatically.

You can use this feature to configure the ISO image to automatically install RHCOS.

#### Procedure

1. Download the **coreos-installer** binary from the [coreos-installer image mirror](#) page.
2. Retrieve the RHCOS ISO image from the [RHCOS image mirror](#) page and the Ignition config file, and then run the following command to inject the Ignition config directly into the ISO image:

```
$ coreos-installer iso customize rhcos-<version>-live.x86_64.iso \  
--dest-ignition bootstrap.ign \ 1  
--dest-device /dev/sda 2
```

- 1 The Ignition config file that is generated from **openshift-installer**.
- 2 When you specify this option, the ISO image automatically runs an install. Otherwise, the image remains configured for installing, but does not do so automatically unless you specify the **coreos.inst.install\_dev** kernel argument.

Your customizations are applied and affect every subsequent boot of the ISO image.

1. To remove the ISO image customizations and return the image to its pristine state, run:

```
$ coreos-installer iso reset rhcos-<version>-live.x86_64.iso
```

You can now re-customize the live ISO image or use it in its pristine state.

#### 10.4.11.3.3.2.1. Modifying a live install ISO image to use a custom certificate authority

You can provide certificate authority (CA) certificates to Ignition with the **--ignition-ca** flag of the **customize** subcommand. You can use the CA certificates during both the installation boot and when provisioning the installed system.

#### Procedure

1. Download the **coreos-installer** binary from the [coreos-installer image mirror](#) page.



- Retrieve the RHCOS ISO image from the [RHCOS image mirror](#) page and run the following command to customize the ISO image for use with a custom CA:

```
$ coreos-installer iso customize rhcos-<version>-live.x86_64.iso --ignition-ca cert.pem
```

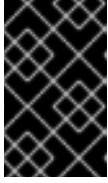

### IMPORTANT

The `coreos.inst.ignition_url` kernel parameter does not work with the `--ignition-ca` flag. You must use the `--dest-ignition` flag to create a customized image for each cluster.



### NOTE

Custom CA certificates affect how Ignition fetches remote resources but they do not affect the certificates installed onto the system.

Your CA certificate is applied and affects every subsequent boot of the ISO image.

#### 10.4.11.3.3.2.2. Modifying a live install ISO image with customized network settings

You can embed a NetworkManager keyfile into the live ISO image and pass it through to the installed system with the `--network-keyfile` flag of the `customize` subcommand.

#### Procedure

- Download the `coreos-installer` binary from the [coreos-installer image mirror](#) page.
- Create a connection profile for a bonded interface. For example, create the `bond0.nmconnection` file in your local directory with the following content:

```
[connection]
id=bond0
type=bond
interface-name=bond0
multi-connect=1
permissions=

[ethernet]
mac-address-blacklist=

[bond]
miimon=100
mode=active-backup

[ipv4]
method=auto

[ipv6]
method=auto

[proxy]
```

- Create a connection profile for a secondary interface to add to the bond. For example, create the `bond0-proxy-em1.nmconnection` file in your local directory with the following content:

```
[connection]
id=em1
type=ethernet
interface-name=em1
master=bond0
multi-connect=1
permissions=
slave-type=bond

[ethernet]
mac-address-blacklist=
```

4. Create a connection profile for a secondary interface to add to the bond. For example, create the **bond0-proxy-em2.nmconnection** file in your local directory with the following content:

```
[connection]
id=em2
type=ethernet
interface-name=em2
master=bond0
multi-connect=1
permissions=
slave-type=bond

[ethernet]
mac-address-blacklist=
```

5. Retrieve the RHCOS ISO image from the [RHCOS image mirror](#) page and run the following command to customize the ISO image with your configured networking:

```
$ coreos-installer iso customize rhcos-<version>-live.x86_64.iso \
  --network-keyfile bond0.nmconnection \
  --network-keyfile bond0-proxy-em1.nmconnection \
  --network-keyfile bond0-proxy-em2.nmconnection
```

Network settings are applied to the live system and are carried over to the destination system.

#### 10.4.11.3.3.3. Customizing a live RHCOS PXE environment

You can customize a live RHCOS PXE environment directly with the **coreos-installer pxe customize** subcommand. When you boot the PXE environment, the customizations are applied automatically.

You can use this feature to configure the PXE environment to automatically install RHCOS.

#### Procedure

1. Download the **coreos-installer** binary from the [coreos-installer image mirror](#) page.
2. Retrieve the RHCOS **kernel**, **initramfs** and **rootfs** files from the [RHCOS image mirror](#) page and the Ignition config file, and then run the following command to create a new **initramfs** file that contains the customizations from your Ignition config:

```
$ coreos-installer pxe customize rhcos-<version>-live-initramfs.x86_64.img \
  --dest-ignition bootstrap.ign \ 1
```

```
--dest-device /dev/sda \ 2
-o rhcos-<version>-custom-initramfs.x86_64.img
```

- 1 The Ignition config file that is generated from **openshift-installer**.
- 2 When you specify this option, the PXE environment automatically runs an install. Otherwise, the image remains configured for installing, but does not do so automatically unless you specify the **coreos.inst.install\_dev** kernel argument.

Your customizations are applied and affect every subsequent boot of the PXE environment.

#### 10.4.11.3.3.3.1. Modifying a live install PXE environment to use a custom certificate authority

You can provide certificate authority (CA) certificates to Ignition with the **--ignition-ca** flag of the **customize** subcommand. You can use the CA certificates during both the installation boot and when provisioning the installed system.

##### Procedure

1. Download the **coreos-installer** binary from the [coreos-installer image mirror](#) page.
2. Retrieve the RHCOS **kernel**, **initramfs** and **rootfs** files from the [RHCOS image mirror](#) page and run the following command to create a new customized **initramfs** file for use with a custom CA:

```
$ coreos-installer pxe customize rhcos-<version>-live-initramfs.x86_64.img \
--ignition-ca cert.pem \
-o rhcos-<version>-custom-initramfs.x86_64.img
```

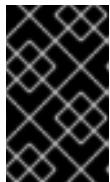

##### IMPORTANT

The **coreos.inst.ignition\_url** kernel parameter does not work with the **--ignition-ca** flag. You must use the **--dest-ignition** flag to create a customized image for each cluster.



##### NOTE

Custom CA certificates affect how Ignition fetches remote resources but they do not affect the certificates installed onto the system.

Your CA certificate is applied and affects every subsequent boot of the PXE environment.

#### 10.4.11.3.3.3.2. Modifying a live install PXE environment with customized network settings

You can embed a NetworkManager keyfile into the live PXE environment and pass it through to the installed system with the **--network-keyfile** flag of the **customize** subcommand.

##### Procedure

1. Download the **coreos-installer** binary from the [coreos-installer image mirror](#) page.
2. Create a connection profile for a bonded interface. For example, create the **bond0.nmconnection** file in your local directory with the following content:

```
[connection]
id=bond0
type=bond
interface-name=bond0
multi-connect=1
permissions=

[ethernet]
mac-address-blacklist=

[bond]
miimon=100
mode=active-backup

[ipv4]
method=auto

[ipv6]
method=auto

[proxy]
```

3. Create a connection profile for a secondary interface to add to the bond. For example, create the **bond0-proxy-em1.nmconnection** file in your local directory with the following content:

```
[connection]
id=em1
type=ethernet
interface-name=em1
master=bond0
multi-connect=1
permissions=
slave-type=bond

[ethernet]
mac-address-blacklist=
```

4. Create a connection profile for a secondary interface to add to the bond. For example, create the **bond0-proxy-em2.nmconnection** file in your local directory with the following content:

```
[connection]
id=em2
type=ethernet
interface-name=em2
master=bond0
multi-connect=1
permissions=
slave-type=bond

[ethernet]
mac-address-blacklist=
```

5. Retrieve the RHCOS **kernel**, **initramfs** and **rootfs** files from the [RHCOS image mirror](#) page and run the following command to create a new customized **initramfs** file that contains your configured networking:

```
$ coreos-installer pxe customize rhcos-<version>-live-initramfs.x86_64.img \
--network-keyfile bond0.nmconnection \
--network-keyfile bond0-proxy-em1.nmconnection \
--network-keyfile bond0-proxy-em2.nmconnection \
-o rhcos-<version>-custom-initramfs.x86_64.img
```

Network settings are applied to the live system and are carried over to the destination system.

#### 10.4.11.3.4. Advanced RHCOS installation reference

This section illustrates the networking configuration and other advanced options that allow you to modify the Red Hat Enterprise Linux CoreOS (RHCOS) manual installation process. The following tables describe the kernel arguments and command-line options you can use with the RHCOS live installer and the **coreos-installer** command.

##### 10.4.11.3.4.1. Networking and bonding options for ISO installations

If you install RHCOS from an ISO image, you can add kernel arguments manually when you boot the image to configure networking for a node. If no networking arguments are specified, DHCP is activated in the initramfs when RHCOS detects that networking is required to fetch the Ignition config file.



#### IMPORTANT

When adding networking arguments manually, you must also add the **rd.neednet=1** kernel argument to bring the network up in the initramfs.

The following table provides examples for configuring networking and bonding on your RHCOS nodes for ISO installations. The examples describe how to use the **ip=**, **nameserver=**, and **bond=** kernel arguments.



#### NOTE

Ordering is important when adding the kernel arguments: **ip=**, **nameserver=**, and then **bond=**.

The networking options are passed to the **dracut** tool during system boot. For more information about the networking options supported by **dracut**, see the **dracut.cmdline** manual page.

The following examples are the networking options for ISO installation.

Configuring DHCP or static IP addresses

To configure an IP address, either use DHCP (**ip=dhcp**) or set an individual static IP address (**ip=<host\_ip>**). If setting a static IP, you must then identify the DNS server IP address (**nameserver=<dns\_ip>**) on each node. The following example sets:

- The node's IP address to **10.10.10.2**
- The gateway address to **10.10.10.254**
- The netmask to **255.255.255.0**
- The hostname to **core0.example.com**
- The DNS server address to **4.4.4.41**

- The auto-configuration value to **none**. No auto-configuration is required when IP networking is configured statically.

```
ip=10.10.10.2::10.10.10.254:255.255.255.0:core0.example.com:enp1s0:none
nameserver=4.4.4.41
```

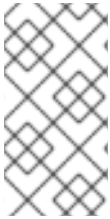

#### NOTE

When you use DHCP to configure IP addressing for the RHCOS machines, the machines also obtain the DNS server information through DHCP. For DHCP-based deployments, you can define the DNS server address that is used by the RHCOS nodes through your DHCP server configuration.

#### Configuring an IP address without a static hostname

You can configure an IP address without assigning a static hostname. If a static hostname is not set by the user, it will be picked up and automatically set by a reverse DNS lookup. To configure an IP address without a static hostname refer to the following example:

- The node's IP address to **10.10.10.2**
- The gateway address to **10.10.10.254**
- The netmask to **255.255.255.0**
- The DNS server address to **4.4.4.41**
- The auto-configuration value to **none**. No auto-configuration is required when IP networking is configured statically.

```
ip=10.10.10.2::10.10.10.254:255.255.255.0::enp1s0:none
nameserver=4.4.4.41
```

#### Specifying multiple network interfaces

You can specify multiple network interfaces by setting multiple **ip=** entries.

```
ip=10.10.10.2::10.10.10.254:255.255.255.0:core0.example.com:enp1s0:none
ip=10.10.10.3::10.10.10.254:255.255.255.0:core0.example.com:enp2s0:none
```

#### Configuring default gateway and route

Optional: You can configure routes to additional networks by setting an **rd.route=** value.



#### NOTE

When you configure one or multiple networks, one default gateway is required. If the additional network gateway is different from the primary network gateway, the default gateway must be the primary network gateway.

- Run the following command to configure the default gateway:

```
ip=::10.10.10.254:::
```

- Enter the following command to configure the route for the additional network:

```
rd.route=20.20.20.0/24:20.20.20.254:enp2s0
```

### Disabling DHCP on a single interface

You can disable DHCP on a single interface, such as when there are two or more network interfaces and only one interface is being used. In the example, the **enp1s0** interface has a static networking configuration and DHCP is disabled for **enp2s0**, which is not used:

```
ip=10.10.10.2::10.10.10.254:255.255.255.0:core0.example.com:enp1s0:none
ip=::::core0.example.com:enp2s0:none
```

### Combining DHCP and static IP configurations

You can combine DHCP and static IP configurations on systems with multiple network interfaces, for example:

```
ip=enp1s0:dhcp
ip=10.10.10.2::10.10.10.254:255.255.255.0:core0.example.com:enp2s0:none
```

### Configuring VLANs on individual interfaces

Optional: You can configure VLANs on individual interfaces by using the **vlan=** parameter.

- To configure a VLAN on a network interface and use a static IP address, run the following command:

```
ip=10.10.10.2::10.10.10.254:255.255.255.0:core0.example.com:enp2s0.100:none
vlan=enp2s0.100:enp2s0
```

- To configure a VLAN on a network interface and to use DHCP, run the following command:

```
ip=enp2s0.100:dhcp
vlan=enp2s0.100:enp2s0
```

### Providing multiple DNS servers

You can provide multiple DNS servers by adding a **nameserver=** entry for each server, for example:

```
nameserver=1.1.1.1
nameserver=8.8.8.8
```

### Bonding multiple network interfaces to a single interface

Optional: You can bond multiple network interfaces to a single interface by using the **bond=** option. Refer to the following examples:

- The syntax for configuring a bonded interface is: **bond=name[:network\_interfaces][:options]** *name* is the bonding device name (**bond0**), *network\_interfaces* represents a comma-separated list of physical (ethernet) interfaces (**em1,em2**), and *options* is a comma-separated list of bonding options. Enter **modinfo bonding** to see available options.
- When you create a bonded interface using **bond=**, you must specify how the IP address is assigned and other information for the bonded interface.
- To configure the bonded interface to use DHCP, set the bond's IP address to **dhcp**. For example:

```
bond=bond0:em1,em2:mode=active-backup
ip=bond0:dhcp
```

- To configure the bonded interface to use a static IP address, enter the specific IP address you want and related information. For example:

```
bond=bond0:em1,em2:mode=active-backup
ip=10.10.10.2::10.10.10.254:255.255.255.0:core0.example.com:bond0:none
```

Bonding multiple network interfaces to a single interface

Optional: You can configure VLANs on bonded interfaces by using the **vlan=** parameter and to use DHCP, for example:

```
ip=bond0.100:dhcp
bond=bond0:em1,em2:mode=active-backup
vlan=bond0.100:bond0
```

Use the following example to configure the bonded interface with a VLAN and to use a static IP address:

```
ip=10.10.10.2::10.10.10.254:255.255.255.0:core0.example.com:bond0.100:none
bond=bond0:em1,em2:mode=active-backup
vlan=bond0.100:bond0
```

Using network teaming

Optional: You can use a network teaming as an alternative to bonding by using the **team=** parameter:

- The syntax for configuring a team interface is: **team=name[:network\_interfaces]**  
*name* is the team device name (**team0**) and *network\_interfaces* represents a comma-separated list of physical (ethernet) interfaces (**em1, em2**).

Teaming is planned to be deprecated when RHCOS switches to an upcoming version of RHEL. For more information, see this [Red Hat Knowledgebase Article](#) .

Use the following example to configure a network team:

```
team=team0:em1,em2
ip=team0:dhcp
```

#### 10.4.11.3.4.2. coreos-installer options for ISO and PXE installations

You can install RHCOS by running **coreos-installer install <options> <device>** at the command prompt, after booting into the RHCOS live environment from an ISO image.

The following table shows the subcommands, options, and arguments you can pass to the **coreos-installer** command.

**Table 10.45. coreos-installer subcommands, command-line options, and arguments**

coreos-installer install subcommand	
<i>Subcommand</i>	<i>Description</i>



<b>\$ coreos-installer install &lt;options&gt; &lt;device&gt;</b>	Embed an Ignition config in an ISO image.
coreos-installer install subcommand options	
<i>Option</i>	<i>Description</i>
<b>-u, --image-url &lt;url&gt;</b>	Specify the image URL manually.
<b>-f, --image-file &lt;path&gt;</b>	Specify a local image file manually. Used for debugging.
<b>-i, --ignition-file &lt;path&gt;</b>	Embed an Ignition config from a file.
<b>-l, --ignition-url &lt;URL&gt;</b>	Embed an Ignition config from a URL.
<b>--ignition-hash &lt;digest&gt;</b>	Digest <b>type-value</b> of the Ignition config.
<b>-p, --platform &lt;name&gt;</b>	Override the Ignition platform ID for the installed system.
<b>--append-karg &lt;arg&gt;...</b>	Append a default kernel argument to the installed system.
<b>--delete-karg &lt;arg&gt;...</b>	Delete a default kernel argument from the installed system.
<b>-n, --copy-network</b>	Copy the network configuration from the install environment.  <div data-bbox="815 1319 922 1576" data-label="Image"></div> <div data-bbox="991 1321 1192 1357" data-label="Section-Header"><b>IMPORTANT</b></div> <div data-bbox="991 1388 1418 1576" data-label="Text"> <p>The <b>--copy-network</b> option only copies networking configuration found under <b>/etc/NetworkManager/system-connections</b>. In particular, it does not copy the system hostname.</p> </div>
<b>--network-dir &lt;path&gt;</b>	For use with <b>-n</b> . Default is <b>/etc/NetworkManager/system-connections/</b> .
<b>--save-partlabel &lt;lx&gt;..</b>	Save partitions with this label glob.
<b>--save-partindex &lt;id&gt;...</b>	Save partitions with this number or range.
<b>--insecure</b>	Skip RHCOS image signature verification.
<b>--insecure-ignition</b>	Allow Ignition URL without HTTPS or hash.

<b>--architecture &lt;name&gt;</b>	Target CPU architecture. Valid values are <b>x86_64</b> and <b>aarch64</b> .
<b>--preserve-on-error</b>	Do not clear partition table on error.
<b>-h, --help</b>	Print help information.
coreos-installer install subcommand argument	
<i>Argument</i>	<i>Description</i>
<b>&lt;device&gt;</b>	The destination device.
coreos-installer ISO subcommands	
<i>Subcommand</i>	<i>Description</i>
<b>\$ coreos-installer iso customize &lt;options&gt; &lt;ISO_image&gt;</b>	Customize a RHCOS live ISO image.
<b>coreos-installer iso reset &lt;options&gt; &lt;ISO_image&gt;</b>	Restore a RHCOS live ISO image to default settings.
<b>coreos-installer iso ignition remove &lt;options&gt; &lt;ISO_image&gt;</b>	Remove the embedded Ignition config from an ISO image.
coreos-installer ISO customize subcommand options	
<i>Option</i>	<i>Description</i>
<b>--dest-ignition &lt;path&gt;</b>	Merge the specified Ignition config file into a new configuration fragment for the destination system.
<b>--dest-device &lt;path&gt;</b>	Install and overwrite the specified destination device.
<b>--dest-karg-append &lt;arg&gt;</b>	Add a kernel argument to each boot of the destination system.
<b>--dest-karg-delete &lt;arg&gt;</b>	Delete a kernel argument from each boot of the destination system.
<b>--network-keyfile &lt;path&gt;</b>	Configure networking by using the specified NetworkManager keyfile for live and destination systems.
<b>--ignition-ca &lt;path&gt;</b>	Specify an additional TLS certificate authority to be trusted by Ignition.

<b>--pre-install &lt;path&gt;</b>	Run the specified script before installation.
<b>--post-install &lt;path&gt;</b>	Run the specified script after installation.
<b>--installer-config &lt;path&gt;</b>	Apply the specified installer configuration file.
<b>--live-ignition &lt;path&gt;</b>	Merge the specified Ignition config file into a new configuration fragment for the live environment.
<b>--live-karg-append &lt;arg&gt;</b>	Add a kernel argument to each boot of the live environment.
<b>--live-karg-delete &lt;arg&gt;</b>	Delete a kernel argument from each boot of the live environment.
<b>--live-karg-replace &lt;k=o=n&gt;</b>	Replace a kernel argument in each boot of the live environment, in the form <b>key=old=new</b> .
<b>-f, --force</b>	Overwrite an existing Ignition config.
<b>-o, --output &lt;path&gt;</b>	Write the ISO to a new output file.
<b>-h, --help</b>	Print help information.
coreos-installer PXE subcommands	
<i>Subcommand</i>	<i>Description</i>
Note that not all of these options are accepted by all subcommands.	
<b>coreos-installer pxe customize &lt;options&gt; &lt;path&gt;</b>	Customize a RHCOS live PXE boot config.
<b>coreos-installer pxe ignition wrap &lt;options&gt;</b>	Wrap an Ignition config in an image.
<b>coreos-installer pxe ignition unwrap &lt;options&gt; &lt;image_name&gt;</b>	Show the wrapped Ignition config in an image.
coreos-installer PXE customize subcommand options	
<i>Option</i>	<i>Description</i>
Note that not all of these options are accepted by all subcommands.	
<b>--dest-ignition &lt;path&gt;</b>	Merge the specified Ignition config file into a new configuration fragment for the destination system.

<b>--dest-device &lt;path&gt;</b>	Install and overwrite the specified destination device.
<b>--network-keyfile &lt;path&gt;</b>	Configure networking by using the specified NetworkManager keyfile for live and destination systems.
<b>--ignition-ca &lt;path&gt;</b>	Specify an additional TLS certificate authority to be trusted by Ignition.
<b>--pre-install &lt;path&gt;</b>	Run the specified script before installation.
<b>post-install &lt;path&gt;</b>	Run the specified script after installation.
<b>--installer-config &lt;path&gt;</b>	Apply the specified installer configuration file.
<b>--live-ignition &lt;path&gt;</b>	Merge the specified Ignition config file into a new configuration fragment for the live environment.
<b>-o, --output &lt;path&gt;</b>	Write the initramfs to a new output file.   <b>NOTE</b> This option is required for PXE environments.
<b>-h, --help</b>	Print help information.

#### 10.4.11.3.4.3. **coreos.inst** boot options for ISO or PXE installations

You can automatically invoke **coreos-installer** options at boot time by passing **coreos.inst** boot arguments to the RHCOS live installer. These are provided in addition to the standard boot arguments.

- For ISO installations, the **coreos.inst** options can be added by interrupting the automatic boot at the bootloader menu. You can interrupt the automatic boot by pressing **TAB** while the **RHEL CoreOS (Live)** menu option is highlighted.
- For PXE or iPXE installations, the **coreos.inst** options must be added to the **APPEND** line before the RHCOS live installer is booted.

The following table shows the RHCOS live installer **coreos.inst** boot options for ISO and PXE installations.

**Table 10.46. coreos.inst boot options**

Argument	Description
<b>coreos.inst.install_dev</b>	Required. The block device on the system to install to. It is recommended to use the full path, such as <b>/dev/sda</b> , although <b>sda</b> is allowed.

Argument	Description
<b>coreos.inst.ignition_url</b>	Optional: The URL of the Ignition config to embed into the installed system. If no URL is specified, no Ignition config is embedded. Only HTTP and HTTPS protocols are supported.
<b>coreos.inst.save_partlabel</b>	Optional: Comma-separated labels of partitions to preserve during the install. Glob-style wildcards are permitted. The specified partitions do not need to exist.
<b>coreos.inst.save_partindex</b>	Optional: Comma-separated indexes of partitions to preserve during the install. Ranges <b>m-n</b> are permitted, and either <b>m</b> or <b>n</b> can be omitted. The specified partitions do not need to exist.
<b>coreos.inst.insecure</b>	Optional: Permits the OS image that is specified by <b>coreos.inst.image_url</b> to be unsigned.
<b>coreos.inst.image_url</b>	<p>Optional: Download and install the specified RHCOS image.</p> <ul style="list-style-type: none"> <li>● This argument should not be used in production environments and is intended for debugging purposes only.</li> <li>● While this argument can be used to install a version of RHCOS that does not match the live media, it is recommended that you instead use the media that matches the version you want to install.</li> <li>● If you are using <b>coreos.inst.image_url</b>, you must also use <b>coreos.inst.insecure</b>. This is because the bare-metal media are not GPG-signed for OpenShift Container Platform.</li> <li>● Only HTTP and HTTPS protocols are supported.</li> </ul>
<b>coreos.inst.skip_reboot</b>	Optional: The system will not reboot after installing. After the install finishes, you will receive a prompt that allows you to inspect what is happening during installation. This argument should not be used in production environments and is intended for debugging purposes only.

Argument	Description
<b>coreos.inst.platform_id</b>	Optional: The Ignition platform ID of the platform the RHCOS image is being installed on. Default is <b>metal</b> . This option determines whether or not to request an Ignition config from the cloud provider, such as VMware. For example: <b>coreos.inst.platform_id=vmware.</b>
<b>ignition.config.url</b>	Optional: The URL of the Ignition config for the live boot. For example, this can be used to customize how <b>coreos-installer</b> is invoked, or to run code before or after the installation. This is different from <b>coreos.inst.ignition_url</b> , which is the Ignition config for the installed system.

#### 10.4.11.4. Enabling multipathing with kernel arguments on RHCOS

RHCOS supports multipathing on the primary disk, allowing stronger resilience to hardware failure to achieve higher host availability.

You can enable multipathing at installation time for nodes that were provisioned in OpenShift Container Platform 4.8 or later. While post-installation support is available by activating multipathing via the machine config, enabling multipathing during installation is recommended.

In setups where any I/O to non-optimized paths results in I/O system errors, you must enable multipathing at installation time.



#### IMPORTANT

On IBM Z and LinuxONE, you can enable multipathing only if you configured your cluster for it during installation. For more information, see "Installing RHCOS and starting the OpenShift Container Platform bootstrap process" in *Installing a cluster with z/VM on IBM Z and LinuxONE*.

The following procedure enables multipath at installation time and appends kernel arguments to the **coreos-installer install** command so that the installed system itself will use multipath beginning from the first boot.

#### Prerequisites

- You have a running OpenShift Container Platform cluster that uses version 4.8 or later.

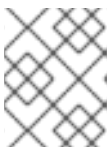

#### NOTE

OpenShift Container Platform does not support enabling multipathing as a day-2 activity on nodes that have been upgraded from 4.6 or earlier.

- You are logged in to the cluster as a user with administrative privileges.

## Procedure

1. To enable multipath and start the **multipathd** daemon, run the following command:

```
$ multipathconf --enable && systemctl start multipathd.service
```

- Optional: If booting the PXE or ISO, you can instead enable multipath by adding **rd.multipath=default** from the kernel command line.

2. Append the kernel arguments by invoking the **coreos-installer** program:

- If there is only one multipath device connected to the machine, it should be available at path **/dev/mapper/mpatha**. For example:

```
$ coreos-installer install /dev/mapper/mpatha \ 1
--append-karg rd.multipath=default \
--append-karg root=/dev/disk/by-label/dm-mpath-root \
--append-karg rw
```

- 1 Indicates the path of the single multipathed device.

- If there are multiple multipath devices connected to the machine, or to be more explicit, instead of using **/dev/mapper/mpatha**, it is recommended to use the World Wide Name (WWN) symlink available in **/dev/disk/by-id**. For example:

```
$ coreos-installer install /dev/disk/by-id/wwn-<wwn_ID> \ 1
--append-karg rd.multipath=default \
--append-karg root=/dev/disk/by-label/dm-mpath-root \
--append-karg rw
```

- 1 Indicates the WWN ID of the target multipathed device. For example, **0xx194e957fcedb4841**.

This symlink can also be used as the **coreos.inst.install\_dev** kernel argument when using special **coreos.inst.\*** arguments to direct the live installer. For more information, see "Installing RHCOS and starting the OpenShift Container Platform bootstrap process".

3. Check that the kernel arguments worked by going to one of the worker nodes and listing the kernel command line arguments (in **/proc/cmdline** on the host):

```
$ oc debug node/ip-10-0-141-105.ec2.internal
```

### Example output

```
Starting pod/ip-10-0-141-105ec2internal-debug ...
To use host binaries, run `chroot /host`

sh-4.2# cat /host/proc/cmdline
...
rd.multipath=default root=/dev/disk/by-label/dm-mpath-root
...

sh-4.2# exit
```

You should see the added kernel arguments.

### 10.4.11.5. Updating the bootloader using `bootupd`

To update the bootloader by using `bootupd`, you must either install `bootupd` on RHCOS machines manually or provide a machine config with the enabled `systemd` unit. Unlike `grubby` or other bootloader tools, `bootupd` does not manage kernel space configuration such as passing kernel arguments.

After you have installed `bootupd`, you can manage it remotely from the OpenShift Container Platform cluster.



#### NOTE

It is recommended that you use `bootupd` only on bare metal or virtualized hypervisor installations, such as for protection against the BootHole vulnerability.

### Manual install method

You can manually install `bootupd` by using the `bootctl` command-line tool.

1. Inspect the system status:

```
# bootupctl status
```

#### Example output for x86\_64

```
Component EFI
Installed: grub2-efi-x64-1:2.04-31.fc33.x86_64,shim-x64-15-8.x86_64
Update: At latest version
```

#### Example output for aarch64

```
Component EFI
Installed: grub2-efi-aa64-1:2.02-99.el8_4.1.aarch64,shim-aa64-15.4-2.el8_1.aarch64
Update: At latest version
```

2. RHCOS images created without `bootupd` installed on them require an explicit adoption phase. If the system status is **Adoptable**, perform the adoption:

```
# bootupctl adopt-and-update
```

#### Example output

```
Updated: grub2-efi-x64-1:2.04-31.fc33.x86_64,shim-x64-15-8.x86_64
```

3. If an update is available, apply the update so that the changes take effect on the next reboot:

```
# bootupctl update
```

#### Example output



Updated: grub2-efi-x64-1:2.04-31.fc33.x86\_64,shim-x64-15-8.x86\_64

## Machine config method

Another way to enable **bootupd** is by providing a machine config.

- Provide a machine config file with the enabled **systemd** unit, as shown in the following example:

### Example output

```
variant: rhcos
version: 1.1.0
systemd:
  units:
    - name: custom-bootupd-auto.service
      enabled: true
      contents: |
        [Unit]
        Description=Bootupd automatic update

        [Service]
        ExecStart=/usr/bin/bootupctl update
        RemainAfterExit=yes

        [Install]
        WantedBy=multi-user.target
```

## 10.4.12. Waiting for the bootstrap process to complete

The OpenShift Container Platform bootstrap process begins after the cluster nodes first boot into the persistent RHCOS environment that has been installed to disk. The configuration information provided through the Ignition config files is used to initialize the bootstrap process and install OpenShift Container Platform on the machines. You must wait for the bootstrap process to complete.

### Prerequisites

- You have created the Ignition config files for your cluster.
- You have configured suitable network, DNS and load balancing infrastructure.
- You have obtained the installation program and generated the Ignition config files for your cluster.
- You installed RHCOS on your cluster machines and provided the Ignition config files that the OpenShift Container Platform installation program generated.

### Procedure

1. Monitor the bootstrap process:

```
$ ./openshift-install --dir <installation_directory> wait-for bootstrap-complete \ 1
--log-level=info 2
```

- 1 For **<installation\_directory>**, specify the path to the directory that you stored the installation files in.
- 2 To view different installation details, specify **warn**, **debug**, or **error** instead of **info**.

### Example output

```
INFO Waiting up to 30m0s for the Kubernetes API at https://api.test.example.com:6443...
INFO API v1.23.0 up
INFO Waiting up to 30m0s for bootstrapping to complete...
INFO It is now safe to remove the bootstrap resources
```

The command succeeds when the Kubernetes API server signals that it has been bootstrapped on the control plane machines.

2. After bootstrap process is complete, remove the bootstrap machine from the load balancer.



### IMPORTANT

You must remove the bootstrap machine from the load balancer at this point. You can also remove or reformat the bootstrap machine itself.

### Additional resources

- See [Monitoring installation progress](#) for more information about monitoring the installation logs and retrieving diagnostic data if installation issues arise.

## 10.4.13. Logging in to the cluster by using the CLI

You can log in to your cluster as a default system user by exporting the cluster **kubeconfig** file. The **kubeconfig** file contains information about the cluster that is used by the CLI to connect a client to the correct cluster and API server. The file is specific to a cluster and is created during OpenShift Container Platform installation.

### Prerequisites

- You deployed an OpenShift Container Platform cluster.
- You installed the **oc** CLI.

### Procedure

1. Export the **kubeadmin** credentials:

```
$ export KUBECONFIG=<installation_directory>/auth/kubeconfig 1
```

- 1 For **<installation\_directory>**, specify the path to the directory that you stored the installation files in.

2. Verify you can run **oc** commands successfully using the exported configuration:

```
$ oc whoami
```

## Example output

```
system:admin
```

### 10.4.14. Approving the certificate signing requests for your machines

When you add machines to a cluster, two pending certificate signing requests (CSRs) are generated for each machine that you added. You must confirm that these CSRs are approved or, if necessary, approve them yourself. The client requests must be approved first, followed by the server requests.

#### Prerequisites

- You added machines to your cluster.

#### Procedure

- Confirm that the cluster recognizes the machines:

```
$ oc get nodes
```

#### Example output

```
NAME      STATUS    ROLES    AGE    VERSION
master-0  Ready    master   63m    v1.23.0
master-1  Ready    master   63m    v1.23.0
master-2  Ready    master   64m    v1.23.0
```

The output lists all of the machines that you created.



#### NOTE

The preceding output might not include the compute nodes, also known as worker nodes, until some CSRs are approved.

- Review the pending CSRs and ensure that you see the client requests with the **Pending** or **Approved** status for each machine that you added to the cluster:

```
$ oc get csr
```

#### Example output

```
NAME      AGE    REQUESTOR                                     CONDITION
csr-8b2br  15m    system:serviceaccount:openshift-machine-config-operator:node-
bootstrapper  Pending
csr-8vnps  15m    system:serviceaccount:openshift-machine-config-operator:node-
bootstrapper  Pending
...
```

In this example, two machines are joining the cluster. You might see more approved CSRs in the list.

- If the CSRs were not approved, after all of the pending CSRs for the machines you added are in **Pending** status, approve the CSRs for your cluster machines:



#### NOTE

Because the CSRs rotate automatically, approve your CSRs within an hour of adding the machines to the cluster. If you do not approve them within an hour, the certificates will rotate, and more than two certificates will be present for each node. You must approve all of these certificates. After the client CSR is approved, the Kubelet creates a secondary CSR for the serving certificate, which requires manual approval. Then, subsequent serving certificate renewal requests are automatically approved by the **machine-approver** if the Kubelet requests a new certificate with identical parameters.



#### NOTE

For clusters running on platforms that are not machine API enabled, such as bare metal and other user-provisioned infrastructure, you must implement a method of automatically approving the kubelet serving certificate requests (CSRs). If a request is not approved, then the **oc exec**, **oc rsh**, and **oc logs** commands cannot succeed, because a serving certificate is required when the API server connects to the kubelet. Any operation that contacts the Kubelet endpoint requires this certificate approval to be in place. The method must watch for new CSRs, confirm that the CSR was submitted by the **node-bootstrap** service account in the **system:node** or **system:admin** groups, and confirm the identity of the node.

- To approve them individually, run the following command for each valid CSR:

```
$ oc adm certificate approve <csr_name> 1
```

- 1** **<csr\_name>** is the name of a CSR from the list of current CSRs.

- To approve all pending CSRs, run the following command:

```
$ oc get csr -o go-template='{{range .items}}{{if not .status}}{{.metadata.name}}{"\n"}{{end}}{{end}}' | xargs --no-run-if-empty oc adm certificate approve
```



#### NOTE

Some Operators might not become available until some CSRs are approved.

- Now that your client requests are approved, you must review the server requests for each machine that you added to the cluster:

```
$ oc get csr
```

#### Example output

```
NAME      AGE   REQUESTOR                                     CONDITION
csr-bfd72 5m26s system:node:ip-10-0-50-126.us-east-2.compute.internal
Pending
```

```
csr-c57lv 5m26s system:node:ip-10-0-95-157.us-east-2.compute.internal
Pending
...
```

- If the remaining CSRs are not approved, and are in the **Pending** status, approve the CSRs for your cluster machines:

- To approve them individually, run the following command for each valid CSR:

```
$ oc adm certificate approve <csr_name> 1
```

- 1** `<csr_name>` is the name of a CSR from the list of current CSRs.

- To approve all pending CSRs, run the following command:

```
$ oc get csr -o go-template='{{range .items}}{{if not .status}}{{.metadata.name}}{\n"}\n{{end}}' | xargs oc adm certificate approve
```

- After all client and server CSRs have been approved, the machines have the **Ready** status. Verify this by running the following command:

```
$ oc get nodes
```

### Example output

```
NAME      STATUS  ROLES  AGE  VERSION
master-0  Ready   master 73m  v1.23.0
master-1  Ready   master 73m  v1.23.0
master-2  Ready   master 74m  v1.23.0
worker-0  Ready   worker 11m  v1.23.0
worker-1  Ready   worker 11m  v1.23.0
```



### NOTE

It can take a few minutes after approval of the server CSRs for the machines to transition to the **Ready** status.

### Additional information

- For more information on CSRs, see [Certificate Signing Requests](#).

## 10.4.15. Initial Operator configuration

After the control plane initializes, you must immediately configure some Operators so that they all become available.

### Prerequisites

- Your control plane has initialized.

### Procedure

1. Watch the cluster components come online:

```
$ watch -n5 oc get clusteroperators
```

### Example output

NAME	VERSION	AVAILABLE	PROGRESSING	DEGRADED	SINCE
authentication	4.10.0	True	False	False	19m
baremetal	4.10.0	True	False	False	37m
cloud-credential	4.10.0	True	False	False	40m
cluster-autoscaler	4.10.0	True	False	False	37m
config-operator	4.10.0	True	False	False	38m
console	4.10.0	True	False	False	26m
csi-snapshot-controller	4.10.0	True	False	False	37m
dns	4.10.0	True	False	False	37m
etcd	4.10.0	True	False	False	36m
image-registry	4.10.0	True	False	False	31m
ingress	4.10.0	True	False	False	30m
insights	4.10.0	True	False	False	31m
kube-apiserver	4.10.0	True	False	False	26m
kube-controller-manager	4.10.0	True	False	False	36m
kube-scheduler	4.10.0	True	False	False	36m
kube-storage-version-migrator	4.10.0	True	False	False	37m
machine-api	4.10.0	True	False	False	29m
machine-approver	4.10.0	True	False	False	37m
machine-config	4.10.0	True	False	False	36m
marketplace	4.10.0	True	False	False	37m
monitoring	4.10.0	True	False	False	29m
network	4.10.0	True	False	False	38m
node-tuning	4.10.0	True	False	False	37m
openshift-apiserver	4.10.0	True	False	False	32m
openshift-controller-manager	4.10.0	True	False	False	30m
openshift-samples	4.10.0	True	False	False	32m
operator-lifecycle-manager	4.10.0	True	False	False	37m
operator-lifecycle-manager-catalog	4.10.0	True	False	False	37m
operator-lifecycle-manager-packageserver	4.10.0	True	False	False	32m
service-ca	4.10.0	True	False	False	38m
storage	4.10.0	True	False	False	37m

2. Configure the Operators that are not available.

### Additional resources

- See [Gathering logs from a failed installation](#) for details about gathering data in the event of a failed OpenShift Container Platform installation.
- See [Troubleshooting Operator issues](#) for steps to check Operator pod health across the cluster and gather Operator logs for diagnosis.

#### 10.4.15.1. Disabling the default OperatorHub sources

Operator catalogs that source content provided by Red Hat and community projects are configured for OperatorHub by default during an OpenShift Container Platform installation. In a restricted network environment, you must disable the default catalogs as a cluster administrator.

## Procedure

- Disable the sources for the default catalogs by adding **disableAllDefaultSources: true** to the **OperatorHub** object:

```
$ oc patch OperatorHub cluster --type json \
  -p '[{"op": "add", "path": "/spec/disableAllDefaultSources", "value": true}]'
```

## TIP

Alternatively, you can use the web console to manage catalog sources. From the **Administration** → **Cluster Settings** → **Configuration** → **OperatorHub** page, click the **Sources** tab, where you can create, delete, disable, and enable individual sources.

### 10.4.15.2. Image registry storage configuration

The Image Registry Operator is not initially available for platforms that do not provide default storage. After installation, you must configure your registry to use storage so that the Registry Operator is made available.

Instructions are shown for configuring a persistent volume, which is required for production clusters. Where applicable, instructions are shown for configuring an empty directory as the storage location, which is available for only non-production clusters.

Additional instructions are provided for allowing the image registry to use block storage types by using the **Recreate** rollout strategy during upgrades.

#### 10.4.15.2.1. Changing the image registry's management state

To start the image registry, you must change the Image Registry Operator configuration's **managementState** from **Removed** to **Managed**.

## Procedure

- Change **managementState** Image Registry Operator configuration from **Removed** to **Managed**. For example:

```
$ oc patch configs.imageregistry.operator.openshift.io cluster --type merge --patch '{"spec": {"managementState": "Managed"}}'
```

#### 10.4.15.2.2. Configuring registry storage for bare metal and other manual installations

As a cluster administrator, following installation you must configure your registry to use storage.

## Prerequisites

- You have access to the cluster as a user with the **cluster-admin** role.
- You have a cluster that uses manually-provisioned Red Hat Enterprise Linux CoreOS (RHCOS) nodes, such as bare metal.
- You have provisioned persistent storage for your cluster, such as Red Hat OpenShift Data Foundation.

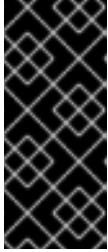
**IMPORTANT**

OpenShift Container Platform supports **ReadWriteOnce** access for image registry storage when you have only one replica. **ReadWriteOnce** access also requires that the registry uses the **Recreate** rollout strategy. To deploy an image registry that supports high availability with two or more replicas, **ReadWriteMany** access is required.

- Must have 100Gi capacity.

**Procedure**

1. To configure your registry to use storage, change the **spec.storage.pvc** in the **configs.imageregistry/cluster** resource.

**NOTE**

When using shared storage, review your security settings to prevent outside access.

2. Verify that you do not have a registry pod:

```
$ oc get pod -n openshift-image-registry -l docker-registry=default
```

**Example output**

```
No resources found in openshift-image-registry namespace
```

**NOTE**

If you do have a registry pod in your output, you do not need to continue with this procedure.

3. Check the registry configuration:

```
$ oc edit configs.imageregistry.operator.openshift.io
```

**Example output**

```
storage:
  pvc:
    claim:
```

Leave the **claim** field blank to allow the automatic creation of an **image-registry-storage** PVC.

4. Check the **clusteroperator** status:

```
$ oc get clusteroperator image-registry
```

**Example output**



NAME	VERSION	AVAILABLE	PROGRESSING	DEGRADED	SINCE
image-registry	4.10	True	False	False	6h50m

5. Ensure that your registry is set to managed to enable building and pushing of images.

- Run:

```
$ oc edit configs.imageregistry/cluster
```

Then, change the line

```
managementState: Removed
```

to

```
managementState: Managed
```

#### 10.4.15.2.3. Configuring storage for the image registry in non-production clusters

You must configure storage for the Image Registry Operator. For non-production clusters, you can set the image registry to an empty directory. If you do so, all images are lost if you restart the registry.

#### Procedure

- To set the image registry storage to an empty directory:

```
$ oc patch configs.imageregistry.operator.openshift.io cluster --type merge --patch '{"spec": {"storage":{"emptyDir":{}}}'
```



#### WARNING

Configure this option for only non-production clusters.

If you run this command before the Image Registry Operator initializes its components, the **oc patch** command fails with the following error:

```
Error from server (NotFound): configs.imageregistry.operator.openshift.io "cluster" not found
```

Wait a few minutes and run the command again.

#### 10.4.15.2.4. Configuring block registry storage

To allow the image registry to use block storage types during upgrades as a cluster administrator, you can use the **Recreate** rollout strategy.



## IMPORTANT

Block storage volumes, or block persistent volumes, are supported but not recommended for use with the image registry on production clusters. An installation where the registry is configured on block storage is not highly available because the registry cannot have more than one replica.

If you choose to use a block storage volume with the image registry, you must use a filesystem Persistent Volume Claim (PVC).

### Procedure

1. To set the image registry storage as a block storage type, patch the registry so that it uses the **Recreate** rollout strategy and runs with only one ( **1** ) replica:

```
$ oc patch config.imageregistry.operator.openshift.io/cluster --type=merge -p '{"spec": {"rolloutStrategy":"Recreate","replicas":1}}'
```

2. Provision the PV for the block storage device, and create a PVC for that volume. The requested block volume uses the ReadWriteOnce (RWO) access mode.
3. Edit the registry configuration so that it references the correct PVC.

## 10.4.16. Completing installation on user-provisioned infrastructure

After you complete the Operator configuration, you can finish installing the cluster on infrastructure that you provide.

### Prerequisites

- Your control plane has initialized.
- You have completed the initial Operator configuration.

### Procedure

1. Confirm that all the cluster components are online with the following command:

```
$ watch -n5 oc get clusteroperators
```

### Example output

NAME	VERSION	AVAILABLE	PROGRESSING	DEGRADED	SINCE
authentication	4.10.0	True	False	False	19m
baremetal	4.10.0	True	False	False	37m
cloud-credential	4.10.0	True	False	False	40m
cluster-autoscaler	4.10.0	True	False	False	37m
config-operator	4.10.0	True	False	False	38m
console	4.10.0	True	False	False	26m
csi-snapshot-controller	4.10.0	True	False	False	37m
dns	4.10.0	True	False	False	37m
etcd	4.10.0	True	False	False	36m
image-registry	4.10.0	True	False	False	31m

ingress	4.10.0	True	False	False	30m
insights	4.10.0	True	False	False	31m
kube-apiserver	4.10.0	True	False	False	26m
kube-controller-manager	4.10.0	True	False	False	36m
kube-scheduler	4.10.0	True	False	False	36m
kube-storage-version-migrator	4.10.0	True	False	False	37m
machine-api	4.10.0	True	False	False	29m
machine-approver	4.10.0	True	False	False	37m
machine-config	4.10.0	True	False	False	36m
marketplace	4.10.0	True	False	False	37m
monitoring	4.10.0	True	False	False	29m
network	4.10.0	True	False	False	38m
node-tuning	4.10.0	True	False	False	37m
openshift-apiserver	4.10.0	True	False	False	32m
openshift-controller-manager	4.10.0	True	False	False	30m
openshift-samples	4.10.0	True	False	False	32m
operator-lifecycle-manager	4.10.0	True	False	False	37m
operator-lifecycle-manager-catalog	4.10.0	True	False	False	37m
operator-lifecycle-manager-packageserver	4.10.0	True	False	False	32m
service-ca	4.10.0	True	False	False	38m
storage	4.10.0	True	False	False	37m

Alternatively, the following command notifies you when all of the clusters are available. It also retrieves and displays credentials:

```
$ ./openshift-install --dir <installation_directory> wait-for install-complete 1
```

- 1** For **<installation\_directory>**, specify the path to the directory that you stored the installation files in.

### Example output

```
INFO Waiting up to 30m0s for the cluster to initialize...
```

The command succeeds when the Cluster Version Operator finishes deploying the OpenShift Container Platform cluster from Kubernetes API server.

### IMPORTANT

- The Ignition config files that the installation program generates contain certificates that expire after 24 hours, which are then renewed at that time. If the cluster is shut down before renewing the certificates and the cluster is later restarted after the 24 hours have elapsed, the cluster automatically recovers the expired certificates. The exception is that you must manually approve the pending **node-bootstrapper** certificate signing requests (CSRs) to recover kubelet certificates. See the documentation for *Recovering from expired control plane certificates* for more information.
- It is recommended that you use Ignition config files within 12 hours after they are generated because the 24-hour certificate rotates from 16 to 22 hours after the cluster is installed. By using the Ignition config files within 12 hours, you can avoid installation failure if the certificate update runs during installation.

2. Confirm that the Kubernetes API server is communicating with the pods.

a. To view a list of all pods, use the following command:

```
$ oc get pods --all-namespaces
```

#### Example output

```

NAMESPACE           NAME                                     READY  STATUS
RESTARTS  AGE
openshift-apiserver-operator  openshift-apiserver-operator-85cb746d55-zqhs8  1/1
Running    1    9m
openshift-apiserver          apiserver-67b9g                                1/1  Running  0
3m
openshift-apiserver          apiserver-ljcmx                                1/1  Running  0
1m
openshift-apiserver          apiserver-z25h4                                1/1  Running  0
2m
openshift-authentication-operator  authentication-operator-69d5d8bf84-vh2n8    1/1
Running    0    5m
...

```

b. View the logs for a pod that is listed in the output of the previous command by using the following command:

```
$ oc logs <pod_name> -n <namespace> 1
```

**1** Specify the pod name and namespace, as shown in the output of the previous command.

If the pod logs display, the Kubernetes API server can communicate with the cluster machines.

3. For an installation with Fibre Channel Protocol (FCP), additional steps are required to enable multipathing. Do not enable multipathing during installation. See "Enabling multipathing with kernel arguments on RHCOS" in the *Post-installation machine configuration tasks* documentation for more information.

4. Register your cluster on the [Cluster registration](#) page.

### 10.4.17. Telemetry access for OpenShift Container Platform

In OpenShift Container Platform 4.10, the Telemetry service, which runs by default to provide metrics about cluster health and the success of updates, requires internet access. If your cluster is connected to the internet, Telemetry runs automatically, and your cluster is registered to [OpenShift Cluster Manager](#).

After you confirm that your [OpenShift Cluster Manager](#) inventory is correct, either maintained automatically by Telemetry or manually by using OpenShift Cluster Manager, [use subscription watch](#) to track your OpenShift Container Platform subscriptions at the account or multi-cluster level.

#### Additional resources

- See [About remote health monitoring](#) for more information about the Telemetry service

### 10.4.18. Next steps

- [Validating an installation.](#)
- [Customize your cluster.](#)
- [Configure image streams](#) for the Cluster Samples Operator and the **must-gather** tool.
- Learn how to [use Operator Lifecycle Manager \(OLM\) on restricted networks](#) .
- If the mirror registry that you used to install your cluster has a trusted CA, add it to the cluster by [configuring additional trust stores](#).
- If necessary, you can [opt out of remote health reporting](#) .
- If necessary, see [Registering your disconnected cluster](#)

# CHAPTER 11. INSTALLING ON-PREMISE WITH ASSISTED INSTALLER

## 11.1. INSTALLING AN ON-PREMISE CLUSTER USING THE ASSISTED INSTALLER

You can install OpenShift Container Platform on on-premise hardware or on-premise VMs using the Assisted Installer. Installing OpenShift Container Platform using the Assisted Installer supports both x86\_64 and AArch64 CPU architectures.

### 11.1.1. Using the Assisted Installer

The OpenShift Container Platform [Assisted Installer](#) is a user-friendly installation solution offered on the [Red Hat Hybrid Cloud Console](#). The Assisted Installer supports the various deployment platforms with a focus on bare metal and vSphere infrastructures.

The Assisted Installer provides installation functionality as a service. This software-as-a-service (SaaS) approach has the following advantages:

- **Web user interface:** The web user interface performs cluster installation without the user having to create the installation configuration files manually.
- **No bootstrap node:** A bootstrap node is not required when installing with the Assisted Installer. The bootstrapping process executes on a node within the cluster.
- **Hosting:** The Assisted Installer hosts:
  - Ignition files
  - The installation configuration
  - A discovery ISO
  - The installer
- **Streamlined installation workflow:** Deployment does not require in-depth knowledge of OpenShift Container Platform. The Assisted Installer provides reasonable defaults and provides the installer as a service, which:
  - Eliminates the need to install and run the OpenShift Container Platform installer locally.
  - Ensures the latest version of the installer up to the latest tested z-stream releases. Older versions remain available, if needed.
  - Enables building automation by using the API without the need to run the OpenShift Container Platform installer locally.
- **Advanced networking:** The Assisted Installer supports IPv4/IPv6 dual stack networking, NMState-based static IP addressing, and an HTTP/S proxy.
- **Pre-installation validation:** The Assisted Installer validates the configuration before installation to ensure a high probability of success. Validation includes:
  - Ensuring network connectivity

- Ensuring sufficient network bandwidth
  - Ensuring connectivity to the registry
  - Ensuring time synchronization between cluster nodes
  - Verifying that the cluster nodes meet the minimum hardware requirements
  - Validating the installation configuration parameters
- **REST API:** The Assisted Installer has a REST API, enabling automation.

The Assisted Installer supports installing OpenShift Container Platform on premises in a connected environment, including with an optional HTTP/S proxy. It can install the following:

- Highly available OpenShift Container Platform or Single Node OpenShift (SNO)
- OpenShift Container Platform on bare metal or vSphere with full platform integration, or other virtualization platforms without integration
- Optionally OpenShift Virtualization and OpenShift Data Foundation (formerly OpenShift Container Storage)

The user interface provides an intuitive interactive workflow where automation does not exist or is not required. Users may also automate installations using the REST API.

See [Install OpenShift with the Assisted Installer](#) to create an OpenShift Container Platform cluster with the Assisted Installer.

### 11.1.2. API support for the Assisted Installer

Supported APIs for the Assisted Installer are stable for a minimum of three months from the announcement of deprecation.

## 11.2. PREPARING TO INSTALL WITH THE ASSISTED INSTALLER

Before installing a cluster, you must ensure the cluster nodes and network meet the requirements.

### 11.2.1. Prerequisites

- You reviewed details about the [OpenShift Container Platform installation and update](#) processes.
- You read the documentation on [selecting a cluster installation method and preparing it for users](#).
- If you use a firewall, you must [configure it](#) so that Assisted Installer can access the resources it requires to function.

### 11.2.2. Assisted Installer prerequisites

The Assisted Installer validates the following prerequisites to ensure successful installation.

#### 11.2.2.1. Hardware

For control plane nodes or the single-node OpenShift node, nodes must have at least the following resources:

- 8 CPU cores
- 16.00 GiB RAM
- 100 GB storage
- 10ms write speed or less for etcd **wal\_fsync\_duration\_seconds**

For worker nodes, each node must have at least the following resources:

- 4 CPU cores
- 16.00 GiB RAM
- 100 GB storage

### 11.2.2.2. Networking

The network must meet the following requirements:

- A DHCP server unless using static IP addressing.
- A base domain name. You must ensure that the following requirements are met:
  - There is no wildcard, such as **\*.<cluster\_name>.<base\_domain>**, or the installation will not proceed.
  - A DNS A/AAAA record for **api.<cluster\_name>.<base\_domain>**.
  - A DNS A/AAAA record with a wildcard for **\*.apps.<cluster\_name>.<base\_domain>**.
- Port **6443** is open for the API URL if you intend to allow users outside the firewall to access the cluster via the **oc** CLI tool.
- Port **443** is open for the console if you intend to allow users outside the firewall to access the console.

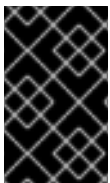

#### IMPORTANT

DNS A/AAAA record settings at top-level domain registrars can take significant time to update. Ensure the A/AAAA record DNS settings are working before installation to prevent installation delays.

The OpenShift Container Platform cluster's network must also meet the following requirements:

- Connectivity between all cluster nodes
- Connectivity for each node to the internet
- Access to an NTP server for time synchronization between the cluster nodes

### 11.2.2.3. Preflight validations



The Assisted Installer ensures the cluster meets the prerequisites before installation, because it eliminates complex post-installation troubleshooting, thereby saving significant amounts of time and effort. Before installing software on the nodes, the Assisted Installer conducts the following validations:

- Ensures network connectivity
- Ensures sufficient network bandwidth
- Ensures connectivity to the registry
- Ensures time synchronization between cluster nodes
- Verifies that the cluster nodes meet the minimum hardware requirements
- Validates the installation configuration parameters

If the Assisted Installer does not successfully validate the foregoing requirements, installation will not proceed.

### 11.2.3. Additional resources

- [Firmware requirements for installing with virtual media](#)
- [Increase the network MTU](#)

## 11.3. INSTALLING WITH THE ASSISTED INSTALLER

After you ensure the cluster nodes and network requirements are met, you can begin installing the cluster.

### 11.3.1. Pre-installation considerations

Before installing OpenShift Container Platform with the Assisted Installer, you must consider the following configuration choices:

- Which base domain to use
- Which OpenShift Container Platform product version to install
- Whether to install a full cluster or single-node OpenShift
- Whether to use a DHCP server or a static network configuration
- Whether to use IPv4 or dual-stack networking
- Whether to install OpenShift Virtualization
- Whether to install Red Hat OpenShift Data Foundation
- Whether to integrate with vSphere when installing on vSphere

### 11.3.2. Setting the cluster details

To create a cluster with the Assisted Installer web user interface, use the following procedure.

## Procedure

1. Log in to the [RedHat Hybrid Cloud Console](#).
2. In the menu, click **OpenShift**.
3. Click **Create cluster**.
4. Click the **Datacenter** tab.
5. Under the **Assisted Installer** section, select **Create cluster**.
6. Enter a name for the cluster in the **Cluster name** field.
7. Enter a base domain for the cluster in the **Base domain** field. All subdomains for the cluster will use this base domain.



### NOTE

The base domain must be a valid DNS name. You must not have a wild card domain set up for the base domain.

8. Select the version of OpenShift Container Platform to install.
9. Optional: Select **Install single node Openshift (SNO)** if you want to install OpenShift Container Platform on a single node.
10. Optional: The Assisted Installer already has the pull secret associated to your account. If you want to use a different pull secret, select **Edit pull secret**.
11. Optional: Assisted Installer defaults to using x86\_64 CPU architecture. If you are installing OpenShift Container Platform on 64-bit ARM CPUs, select **Use arm64 CPU architecture**. Keep in mind, some features are not available with AArch64 CPU architectures.
12. Optional: If you are using a static IP configuration for the cluster nodes instead of DHCP reservations, select **Static network configuration**.
13. Optional: If you want to enable encryption of the installation disks, select **Enable encryption of installation disks**. For multi-node clusters, you can choose to encrypt the control plane and worker node installation disks separately.



### IMPORTANT

You cannot change the base domain, the SNO checkbox, the CPU architecture, the host's network configuration, or the disk-encryption after installation begins.

### 11.3.3. Optional: Configuring host network interfaces

The Assisted Installer supports IPv4 networking and dual stack networking. The Assisted Installer also supports configuring host network interfaces with the NMState library, a declarative network manager API for hosts. You can use NMState to deploy hosts with static IP addressing, bonds, VLANs and other advanced networking features. If you chose to configure host network interfaces, you must set network-wide configurations. Then, you must create a host-specific configuration for each host and generate the discovery ISO with the host-specific settings.

## Procedure

1. Select the internet protocol version. Valid options are **IPv4** and **Dual stack**.
2. If the cluster hosts are on a shared VLAN, enter the VLAN ID.
3. Enter the network-wide IP addresses. If you selected **Dual stack** networking, you must enter both IPv4 and IPv6 addresses.
  - a. Enter the cluster network's IP address range in CIDR notation.
  - b. Enter the default gateway IP address.
  - c. Enter the DNS server IP addresses.
4. Enter the host-specific configuration.
  - a. If you are only setting a static IP address that uses a single network interface, use the form view to enter the IP address and the MAC address for the host.
  - b. If you are using multiple interfaces, bonding, or other advanced networking features, use the YAML view and enter the desired network state for the host using NMState syntax.
  - c. Add the MAC address and interface name for each interface used in your network configuration.

## Additional resources

- [NMState version 2.1.4](#)

### 11.3.4. Adding hosts to the cluster

You must add one or more hosts to the cluster. Adding a host to the cluster involves generating a discovery ISO. The discovery ISO runs Red Hat Enterprise Linux CoreOS (RHCOS) in-memory with an agent. Perform the following procedure for each host on the cluster.

## Procedure

1. Click the **Add hosts** button and select the installation media.
  - a. Select **Minimal image file: Provision with virtual media** to download a smaller image that will fetch the data needed to boot. The nodes must have virtual media capability. This is the recommended method.
  - b. Select **Full image file: Provision with physical media** to download the larger full image.
2. Add an SSH public key so that you can connect to the cluster nodes as the **core** user. Having a login to the cluster nodes can provide you with debugging information during the installation.
3. Optional: If the cluster hosts are behind a firewall that requires the use of a proxy, select **Configure cluster-wide proxy settings**. Enter the username, password, IP address and port for the HTTP and HTTPS URLs of the proxy server.
4. Click **Generate Discovery ISO**.
5. Download the discovery ISO.

### 11.3.5. Creating an ISO image on a USB drive

You can install software using a USB drive that contains an ISO image. Starting the server with the USB drive prepares the server for the software installation.

#### Procedure

1. On the administration host, insert a USB drive into a USB port.
2. Create an ISO image on the USB drive, for example:

```
# dd if=<path_to_iso> of=<path_to_usb> status=progress
```

where:

**<path\_to\_iso>**

is the relative path to the downloaded ISO file, for example, **rhcos-live.iso**.

**<path\_to\_usb>**

is the location of the connected USB drive, for example, **/dev/sdb**.

After the ISO is copied to the USB drive, you can use the USB drive to install software on the server.

### 11.3.6. Booting with a USB drive

To register nodes with the Assisted Installer using a bootable USB drive, use the following procedure.

#### Procedure

1. Attach the RHCOS discovery ISO to the target host.
2. Configure the boot drive order in the server BIOS settings to boot from the attached discovery ISO, and then reboot the server.
3. On the administration host, return to the browser. Wait for the host to appear in the list of discovered hosts.

### 11.3.7. Booting from an HTTP-hosted ISO image using the Redfish API

You can provision hosts in your network using ISOs that you install using the Redfish Baseboard Management Controller (BMC) API.

#### Prerequisites

1. Download the installation Red Hat Enterprise Linux CoreOS (RHCOS) ISO.

#### Procedure

1. Copy the ISO file to an HTTP server accessible in your network.
2. Boot the host from the hosted ISO file, for example:
  - a. Call the redfish API to set the hosted ISO as the **VirtualMedia** boot media by running the following command:

```
$ curl -k -u <bmc_username>:<bmc_password> -d '{"Image": "<hosted_iso_file>",
"Inserted": true}' -H "Content-Type: application/json" -X POST
<host_bmc_address>/redfish/v1/Managers/iDRAC.Embedded.1/VirtualMedia/CD/Actions/Vi
rtualMedia.InsertMedia
```

Where:

**<bmc\_username>:<bmc\_password>**

Is the username and password for the target host BMC.

**<hosted\_iso\_file>**

Is the URL for the hosted installation ISO, for example:

<http://webserver.example.com/rhcos-live-minimal.iso>. The ISO must be accessible from the target host machine.

**<host\_bmc\_address>**

Is the BMC IP address of the target host machine.

- b. Set the host to boot from the **VirtualMedia** device by running the following command:

```
$ curl -k -u <bmc_username>:<bmc_password> -X PATCH -H 'Content-Type:
application/json' -d '{"Boot": {"BootSourceOverrideTarget": "Cd",
"BootSourceOverrideMode": "UEFI", "BootSourceOverrideEnabled": "Once"}}'
<host_bmc_address>/redfish/v1/Systems/System.Embedded.1
```

- c. Reboot the host:

```
$ curl -k -u <bmc_username>:<bmc_password> -d '{"ResetType": "ForceRestart"}' -H
'Content-type: application/json' -X POST
<host_bmc_address>/redfish/v1/Systems/System.Embedded.1/Actions/ComputerSystem.R
eset
```

- d. Optional: If the host is powered off, you can boot it using the **{"ResetType": "On"}** switch. Run the following command:

```
$ curl -k -u <bmc_username>:<bmc_password> -d '{"ResetType": "On"}' -H 'Content-
type: application/json' -X POST
<host_bmc_address>/redfish/v1/Systems/System.Embedded.1/Actions/ComputerSystem.R
eset
```

#### Additional resources

- [BMC addressing](#).
- [Firmware requirements for installing with virtual media](#)

### 11.3.8. Configuring hosts

After booting the hosts with the discovery ISO, the hosts will appear in the table at the bottom of the page. You can configure the hostname, role, and installation disk for each host.

#### Procedure

1. Select a host.

2. From the **Actions** list, select **Change hostname**. You must ensure each host has a valid and unique hostname. If necessary, enter a new name for the host and click **Change**.
3. For multi-host clusters, in the **Role** column next to the host name, you can click on the menu to change the role of the host.  
If you do not select a role, the Assisted Installer will assign the role automatically. The minimum hardware requirements for control plane nodes exceed that of worker nodes. If you assign a role to a host, ensure that you assign the control plane role to hosts that meet the minimum hardware requirements.
4. To the left of the checkbox next to a host name, click to expand the host details. If you have multiple disk drives, you can select a different disk drive to act as the installation disk.
5. Repeat this procedure for each host.

Once all cluster hosts appear with a status of **Ready**, proceed to the next step.

### 11.3.9. Configuring networking

Before installing OpenShift Container Platform, you must configure the cluster network.

#### Procedure

1. In the **Networking** page, select one of the following if it is not already selected for you:
  - **Cluster-Managed Networking:** Selecting cluster-managed networking means that the Assisted Installer will configure a standard network topology, including **keepalived** and Virtual Router Redundancy Protocol (VRRP) for managing the API and Ingress VIP addresses.
  - **User-Managed Networking:** Selecting user-managed networking allows you to deploy OpenShift Container Platform with a non-standard network topology. For example, if you want to deploy with an external load balancer instead of **keepalived** and VRRP, or if you intend to deploy the cluster nodes across many distinct L2 network segments.
2. For cluster-managed networking, configure the following settings:
  - a. Define the **Machine network**. You can use the default network or select a subnet.
  - b. Define an **API virtual IP**. An API virtual IP provides an endpoint for all users to interact with, and configure the platform.
  - c. Define an **Ingress virtual IP**. An Ingress virtual IP provides an endpoint for application traffic flowing from outside the cluster.
3. For user-managed networking, configure the following settings:
  - a. Select your **Networking stack type**:
    - **IPv4:** Select this type when your hosts are only using IPv4.
    - **Dual-stack:** You can select dual-stack when your hosts are using IPv4 together with IPv6.
  - b. Define the **Machine network**. You can use the default network or select a subnet.

- c. Define an **API virtual IP**. An API virtual IP provides an endpoint for all users to interact with, and configure the platform.
  - d. Define an **Ingress virtual IP**. An Ingress virtual IP provides an endpoint for application traffic flowing from outside the cluster.
  - e. Optional: You can select **Allocate IPs via DHCP server** to automatically allocate the **API IP** and **Ingress IP** using the DHCP server.
4. Optional: Select **Use advanced networking** to configure the following advanced networking properties:
- **Cluster network CIDR**: Define an IP address block from which Pod IP addresses are allocated.
  - **Cluster network host prefix**: Define a subnet prefix length to assign to each node.
  - **Service network CIDR**: Define an IP address to use for service IP addresses.
  - **Network type**: Select either **Software-Defined Networking (SDN)** for standard networking or **Open Virtual Networking (OVN)** for telco features.

### 11.3.10. Installing the cluster

After you have completed the configuration and all the nodes are **Ready**, you can begin installation. The installation process takes a considerable amount of time, and you can monitor the installation from the Assisted Installer web console. Nodes will reboot during the installation, and they will initialize after installation.

#### Procedure

- Press **Begin installation**.
  1. Click on the link in the **Status** column of the **Host Inventory** list to see the installation status of a particular host.

### 11.3.11. Completing the installation

After the cluster is installed and initialized, the Assisted Installer indicates that the installation is finished. The Assisted Installer provides the console URL, the **kubeadmin** username and password, and the **kubeconfig** file. Additionally, the Assisted Installer provides cluster details including the OpenShift Container Platform version, base domain, CPU architecture, API and Ingress IP addresses, and the cluster and service network IP addresses.

#### Prerequisites

- You have installed the **oc** CLI tool.

#### Procedure

1. Make a copy of the **kubeadmin** username and password.
2. Download the **kubeconfig** file and copy it to the **auth** directory under your working directory:

```
$ mkdir -p <working_directory>/auth
-
```

```
$ cp kubeadmin <working_directory>/auth
```

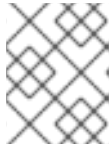
**NOTE**

The **kubeconfig** file is available for download for 24 hours after completing the installation.

3. Add the **kubeconfig** file to your environment:

```
$ export KUBECONFIG=<your working directory>/auth/kubeconfig
```

4. Login with the **oc** CLI tool:

```
$ oc login -u kubeadmin -p <password>
```

Replace **<password>** with the password of the **kubeadmin** user.

5. Click on the web console URL or click **Launch OpenShift Console** to open the console.
6. Enter the **kubeadmin** username and password. Follow the instructions in the OpenShift Container Platform console to configure an identity provider and configure alert receivers.
7. Add a bookmark of the OpenShift Container Platform console.

### 11.3.12. Additional resources

- [Installing the OpenShift CLI.](#)
- [Logging in to the OpenShift CLI](#)
- [Creating a cluster admin](#)
- [Removing the kubeadmin user](#)



## CHAPTER 12. INSTALLING ON A SINGLE NODE

### 12.1. PREPARING TO INSTALL ON A SINGLE NODE

#### 12.1.1. Prerequisites

- You reviewed details about the [OpenShift Container Platform installation and update](#) processes.
- You have read the documentation on [selecting a cluster installation method and preparing it for users](#).

#### 12.1.2. About OpenShift on a single node

You can create a single-node cluster with standard installation methods. OpenShift Container Platform on a single node is a specialized installation that requires the creation of a special ignition configuration ISO. The primary use case is for edge computing workloads, including intermittent connectivity, portable clouds, and 5G radio access networks (RAN) close to a base station. The major tradeoff with an installation on a single node is the lack of high availability.



#### IMPORTANT

The use of OpenShiftSDN with single-node OpenShift is deprecated. OVN-Kubernetes is the default networking solution for single-node OpenShift deployments.

#### 12.1.3. Requirements for installing OpenShift on a single node

Installing OpenShift Container Platform on a single node alleviates some of the requirements for high availability and large scale clusters. However, you must address the following requirements:

- **Administration host:** You must have a computer to prepare the ISO, to create the USB boot drive, and to monitor the installation.
- **Supported platforms:** Installing OpenShift Container Platform on a single node is supported on bare metal and [Certified third-party hypervisors](#). In all cases, you must specify the **platform.none: {}** parameter in the **install-config.yaml** configuration file.
- **Production-grade server:** Installing OpenShift Container Platform on a single node requires a server with sufficient resources to run OpenShift Container Platform services and a production workload.

Table 12.1. Minimum resource requirements

Profile	vCPU	Memory	Storage
Minimum	8 vCPU cores	16GB of RAM	120GB

**NOTE**

One vCPU is equivalent to one physical core when simultaneous multithreading (SMT), or hyperthreading, is not enabled. When enabled, use the following formula to calculate the corresponding ratio:

$$(\text{threads per core} \times \text{cores}) \times \text{sockets} = \text{vCPUs}$$

The server must have a Baseboard Management Controller (BMC) when booting with virtual media.

- **Networking:** The server must have access to the internet or access to a local registry if it is not connected to a routable network. The server must have a DHCP reservation or a static IP address for the Kubernetes API, Ingress route, and cluster node domain names. You must configure the DNS to resolve the IP address to each of the following fully qualified domain names (FQDN):

**Table 12.2. Required DNS records**

Usage	FQDN	Description
Kubernetes API	<b>api.&lt;cluster_name&gt;.&lt;base_domain&gt;</b>	Add a DNS A/AAAA or CNAME record. This record must be resolvable by clients external to the cluster.
Internal API	<b>api-int.&lt;cluster_name&gt;.&lt;base_domain&gt;</b>	Add a DNS A/AAAA or CNAME record when creating the ISO manually. This record must be resolvable by nodes within the cluster.
Ingress route	<b>*.apps.&lt;cluster_name&gt;.&lt;base_domain&gt;</b>	Add a wildcard DNS A/AAAA or CNAME record that targets the node. This record must be resolvable by clients external to the cluster.

Without persistent IP addresses, communications between the **apiserver** and **etcd** might fail.

## 12.2. INSTALLING OPENSIFT ON A SINGLE NODE

### 12.2.1. Generating the discovery ISO with the Assisted Installer

Installing OpenShift Container Platform on a single node requires a discovery ISO, which the Assisted Installer (AI) can generate with the cluster name, base domain, Secure Shell (SSH) public key, and pull secret.

#### Procedure

1. On the administration node, open a browser and navigate to [Install OpenShift with the Assisted Installer](#).

2. Click **Create Cluster** to create a new cluster.
3. In the **Cluster name** field, enter a name for the cluster.
4. In the **Base domain** field, enter a base domain. For example:

example.com

All DNS records must be subdomains of this base domain and include the cluster name. You cannot change the base domain after cluster installation. For example:

<cluster-name>.example.com

5. Select **Install single node OpenShift (SNO)**.
6. Read the 4.10 release notes, which outline some of the limitations for installing OpenShift Container Platform on a single node.
7. Select the OpenShift Container Platform version.
8. Optional: Edit the pull secret.
9. Click **Next**.
10. Click **Generate Discovery ISO**.
11. Select **Full image file** to boot with a USB drive or PXE. Select **Minimal image file** to boot with virtual media.
12. Add SSH public key of the administration node to the **Public key** field.
13. Click **Generate Discovery ISO**.
14. Download the discovery ISO.
15. Make a note of the discovery ISO URL for installing with virtual media.



#### NOTE

If you enable OpenShift Virtualization during this process, you must have a second local storage device of at least 50GiB for your virtual machines.

#### Additional resources

- [What you can do with OpenShift Virtualization](#)

### 12.2.2. Generating the discovery ISO manually

Installing OpenShift Container Platform on a single node requires a discovery ISO, which you can generate with the following procedure.

#### Procedure

1. Download the OpenShift Container Platform client (**oc**) and make it available for use by entering the following command:

```
$ curl -k https://mirror.openshift.com/pub/openshift-v4/clients/ocp/latest/openshift-client-linux.tar.gz > oc.tar.gz
```

```
$ tar zxf oc.tar.gz
```

```
$ chmod +x oc
```

2. Set the OpenShift Container Platform version:

```
$ OCP_VERSION=<ocp_version> 1
```

- 1** Replace **<ocp\_version>** with the current version. For example, **latest-4.10**

3. Download the OpenShift Container Platform installer and make it available for use by entering the following commands:

```
$ curl -k https://mirror.openshift.com/pub/openshift-v4/clients/ocp/$OCP_VERSION/openshift-install-linux.tar.gz > openshift-install-linux.tar.gz
```

```
$ tar zxvf openshift-install-linux.tar.gz
```

```
$ chmod +x openshift-install
```

4. Retrieve the RHCOS ISO URL:

```
$ ISO_URL=$(./openshift-install coreos print-stream-json | grep location | grep x86_64 | grep iso | cut -d\" -f4)
```

5. Download the RHCOS ISO:

```
$ curl -L $ISO_URL > rhcos-live.x86_64.iso
```

6. Prepare the **install-config.yaml** file:

```
apiVersion: v1
baseDomain: <domain> 1
compute:
- name: worker
  replicas: 0 2
controlPlane:
  name: master
  replicas: 1 3
metadata:
  name: <name> 4
networking:
  networkType: OVNKubernetes
  clusterNetwork:
  - cidr: <IP_address>/<prefix> 5
    hostPrefix: <prefix> 6
  serviceNetwork:
```

```

- <IP_address>/<prefix> 7
platform:
  none: {}
bootstrapInPlace:
  installationDisk: <path_to_install_drive> 8
pullSecret: '<pull_secret>' 9
sshKey: |
  <ssh_key> 10

```

- 1 Add the cluster domain name.
- 2 Set the **compute** replicas to **0**. This makes the control plane node schedulable.
- 3 Set the **controlPlane** replicas to **1**. In conjunction with the previous **compute** setting, this setting ensures the cluster runs on a single node.
- 4 Set the **metadata** name to the cluster name.
- 5 Set the **clusterNetwork** CIDR.
- 6 Set the **clusterNetwork** host prefix. Pods receive their IP addresses from this pool.
- 7 Set the **serviceNetwork** CIDR. Services receive their IP addresses from this pool.
- 8 Set the path to the installation disk drive.
- 9 Copy the [pull secret from the Red Hat OpenShift Cluster Manager](#) . In step 1, click **Download pull secret** and add the contents to this configuration setting.
- 10 Add the public SSH key from the administration host so that you can log in to the cluster after installation.

#### 7. Generate OpenShift Container Platform assets:

```

$ mkdir ocp

$ cp install-config.yaml ocp

$ ./openshift-install --dir=ocp create single-node-ignition-config

```

#### 8. Embed the ignition data into the RHCOS ISO:

```

$ alias coreos-installer='podman run --privileged --pull always --rm \
  -v /dev:/dev -v /run/udev:/run/udev -v $PWD:/data \
  -w /data quay.io/coreos/coreos-installer:release'

$ cp ocp/bootstrap-in-place-for-live-iso.ign iso.ign

$ coreos-installer iso ignition embed -fi iso.ign rhcos-live.x86_64.iso

```

### 12.2.3. Installing with USB media

Installing with USB media involves creating a bootable USB drive with the discovery ISO on the administration node. Booting the server with the USB drive prepares the node for a single node installation.

### Procedure

1. On the administration node, insert a USB drive into a USB port.
2. Create a bootable USB drive:

```
# dd if=<path-to-iso> of=<path/to/usb> status=progress
```

For example:

```
# dd if=discovery_image_sno.iso of=/dev/sdb status=progress
```

After the ISO is copied to the USB drive, you can use the USB drive to install OpenShift Container Platform.

3. On the server, insert the USB drive into a USB port.
4. Reboot the server and enter the BIOS settings upon reboot.
5. Change boot drive order to make the USB drive boot first.
6. Save and exit the BIOS settings. The server will boot with the discovery image.

### 12.2.4. Monitoring the installation with the Assisted Installer

If you created the ISO using the Assisted Installer, use this procedure to monitor the installation.

#### Procedure

1. On the administration host, return to the browser and refresh the page. If necessary, reload the [Install OpenShift with the Assisted Installer](#) page and select the cluster name.
2. Click **Next** until you reach step 3, **Networking**.
3. Select a subnet from the available subnets.
4. Keep **Use the same host discovery SSH key** checked. You can change the SSH public key, if necessary.
5. Click **Next** to proceed to the **Review and Create** step.
6. Click **Install cluster**.
7. Monitor the installation's progress. Watch the cluster events. After the installation process finishes writing the discovery image to the server's drive, the server will restart. Remove the USB drive and reset the BIOS to boot to the server's local media rather than the USB drive.

The server will restart several times, deploying the control plane.

### 12.2.5. Monitoring the installation manually

If you created the ISO manually, use this procedure to monitor the installation.

### Procedure

1. Monitor the installation:

```
█ $ ./openshift-install --dir=ocp wait-for install-complete
```

The server will restart several times while deploying the control plane.

2. Optional: After the installation is complete, check the environment:

```
█ $ export KUBECONFIG=ocp/auth/kubeconfig
```

```
█ $ oc get nodes
```

```
█ $ oc get clusterversion
```

# CHAPTER 13. DEPLOYING INSTALLER-PROVISIONED CLUSTERS ON BARE METAL

## 13.1. OVERVIEW

Installer-provisioned installation on bare metal nodes deploys and configures the infrastructure that an OpenShift Container Platform cluster runs on. This guide provides a methodology to achieving a successful installer-provisioned bare-metal installation. The following diagram illustrates the installation environment in phase 1 of deployment:

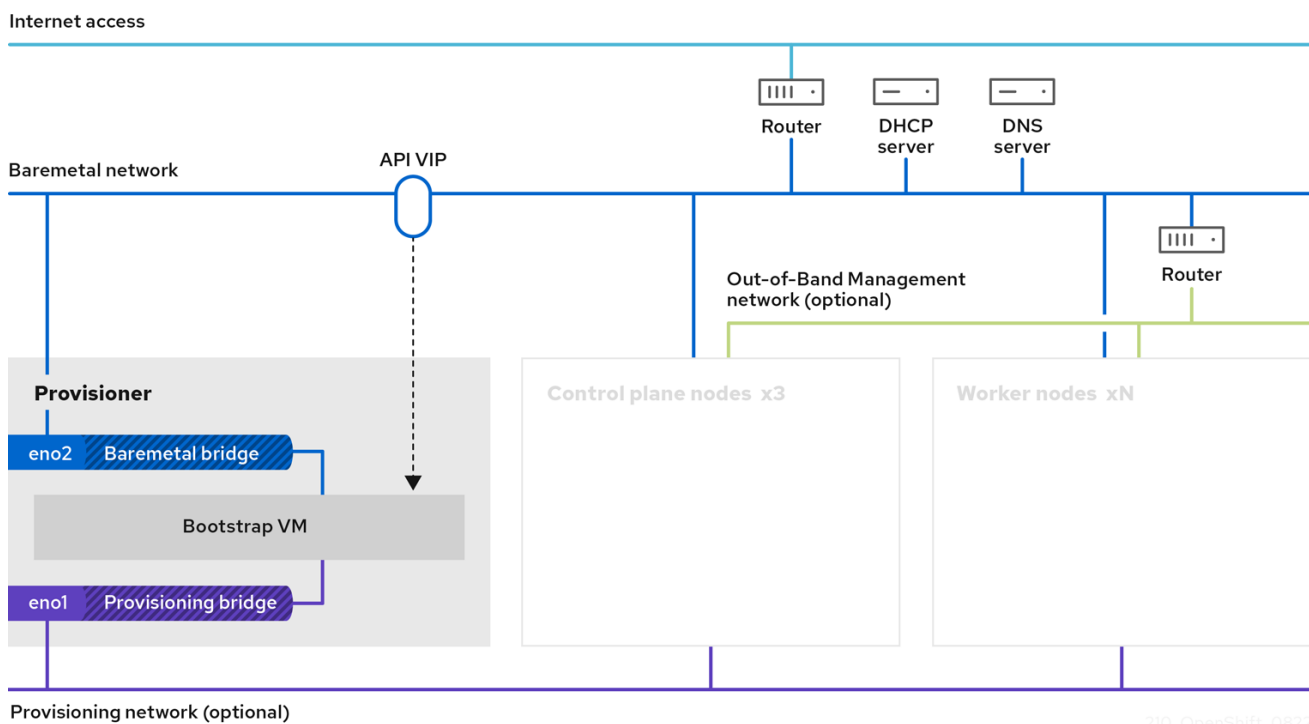

For the installation, the key elements in the previous diagram are:

- **Provisioner:** A physical machine that runs the installation program and hosts the bootstrap VM that deploys the control plane of a new OpenShift Container Platform cluster.
- **Bootstrap VM:** A virtual machine used in the process of deploying an OpenShift Container Platform cluster.
- **Network bridges:** The bootstrap VM connects to the bare metal network and to the provisioning network, if present, via network bridges, **eno1** and **eno2**.
- **API VIP:** An API virtual IP address (VIP) is used to provide failover of the API server across the control plane nodes. The API VIP first resides on the bootstrap VM. A script generates the **keepalived.conf** configuration file before launching the service. The VIP moves to one of the control plane nodes after the bootstrap process has completed and the bootstrap VM stops.

In phase 2 of the deployment, the provisioner destroys the bootstrap VM automatically and moves the virtual IP addresses (VIPs) to the appropriate nodes.

The **keepalived.conf** file sets the control plane machines with a lower Virtual Router Redundancy Protocol (VRRP) priority than the bootstrap VM, which ensures that the API on the control plane machines is fully functional before the API VIP moves from the bootstrap VM to the control plane. Once



the API VIP moves to one of the control plane nodes, traffic sent from external clients to the API VIP routes to an **haproxy** load balancer running on that control plane node. This instance of **haproxy** load balances the API VIP traffic across the control plane nodes.

The Ingress VIP moves to the worker nodes. The **keepalived** instance also manages the Ingress VIP.

The following diagram illustrates phase 2 of deployment:

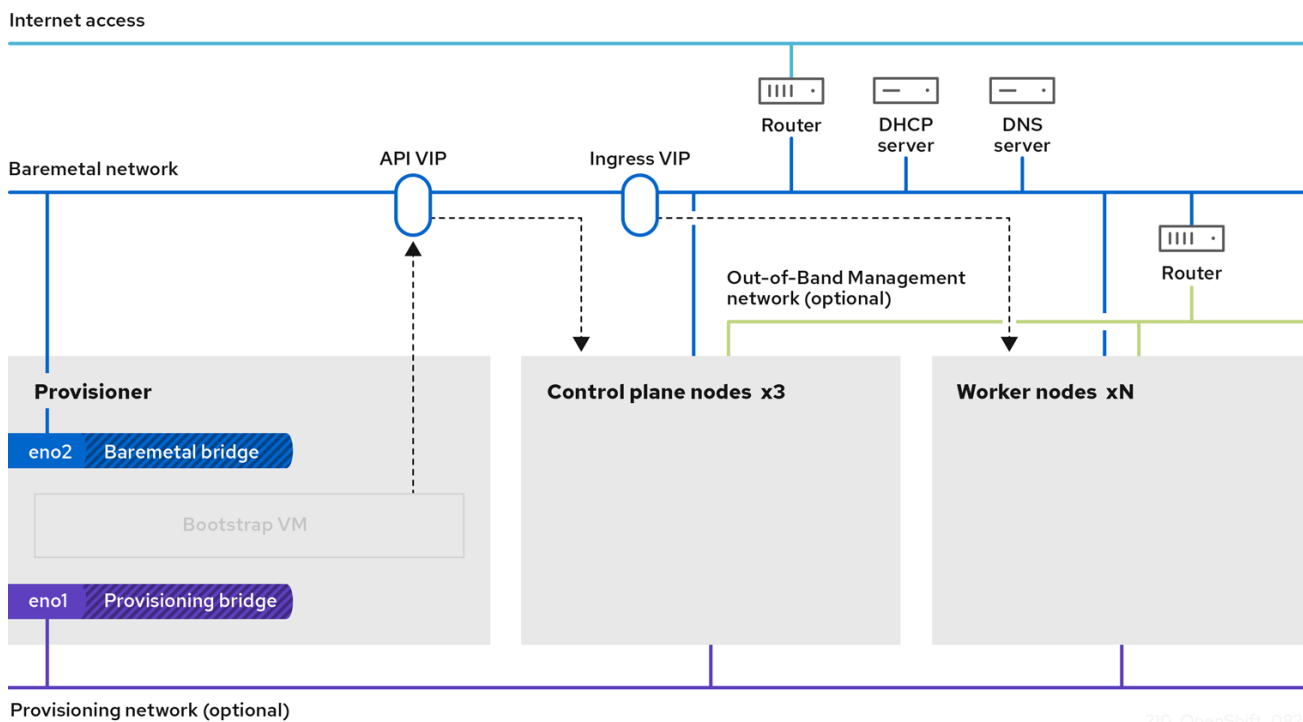

After this point, the node used by the provisioner can be removed or repurposed. From here, all additional provisioning tasks are carried out by the control plane.



### IMPORTANT

The provisioning network is optional, but it is required for PXE booting. If you deploy without a provisioning network, you must use a virtual media baseboard management controller (BMC) addressing option such as **redfish-virtualmedia** or **idrac-virtualmedia**.

## 13.2. PREREQUISITES

Installer-provisioned installation of OpenShift Container Platform requires:

1. One provisioner node with Red Hat Enterprise Linux (RHEL) 8.x installed. The provisioner can be removed after installation.
2. Three control plane nodes
3. Baseboard management controller (BMC) access to each node
4. At least one network:
  - a. One required routable network
  - b. One optional provisioning network

- c. One optional management network

Before starting an installer-provisioned installation of OpenShift Container Platform, ensure the hardware environment meets the following requirements.

### 13.2.1. Node requirements

Installer-provisioned installation involves a number of hardware node requirements:

- **CPU architecture:** All nodes must use **x86\_64** CPU architecture.
- **Similar nodes:** Red Hat recommends nodes have an identical configuration per role. That is, Red Hat recommends nodes be the same brand and model with the same CPU, memory, and storage configuration.
- **Baseboard Management Controller:** The **provisioner** node must be able to access the baseboard management controller (BMC) of each OpenShift Container Platform cluster node. You may use IPMI, Redfish, or a proprietary protocol.
- **Latest generation:** Nodes must be of the most recent generation. Installer-provisioned installation relies on BMC protocols, which must be compatible across nodes. Additionally, RHEL 8 ships with the most recent drivers for RAID controllers. Ensure that the nodes are recent enough to support RHEL 8 for the **provisioner** node and RHCOS 8 for the control plane and worker nodes.
- **Registry node:** (Optional) If setting up a disconnected mirrored registry, it is recommended the registry reside in its own node.
- **Provisioner node:** Installer-provisioned installation requires one **provisioner** node.
- **Control plane:** Installer-provisioned installation requires three control plane nodes for high availability. You can deploy an OpenShift Container Platform cluster with only three control plane nodes, making the control plane nodes schedulable as worker nodes. Smaller clusters are more resource efficient for administrators and developers during development, production, and testing.
- **Worker nodes:** While not required, a typical production cluster has two or more worker nodes.

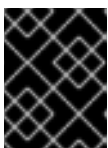

#### IMPORTANT

Do not deploy a cluster with only one worker node, because the cluster will deploy with routers and ingress traffic in a degraded state.

- **Network interfaces:** Each node must have at least one network interface for the routable **baremetal** network. Each node must have one network interface for a **provisioning** network when using the **provisioning** network for deployment. Using the **provisioning** network is the default configuration.
- **Unified Extensible Firmware Interface (UEFI):** Installer-provisioned installation requires UEFI boot on all OpenShift Container Platform nodes when using IPv6 addressing on the **provisioning** network. In addition, UEFI Device PXE Settings must be set to use the IPv6 protocol on the **provisioning** network NIC, but omitting the **provisioning** network removes this requirement.

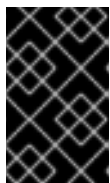
**IMPORTANT**

When starting the installation from virtual media such as an ISO image, delete all old UEFI boot table entries. If the boot table includes entries that are not generic entries provided by the firmware, the installation might fail.

- **Secure Boot:** Many production scenarios require nodes with Secure Boot enabled to verify the node only boots with trusted software, such as UEFI firmware drivers, EFI applications, and the operating system. You may deploy with Secure Boot manually or managed.
  1. **Manually:** To deploy an OpenShift Container Platform cluster with Secure Boot manually, you must enable UEFI boot mode and Secure Boot on each control plane node and each worker node. Red Hat supports Secure Boot with manually enabled UEFI and Secure Boot only when installer-provisioned installations use Redfish virtual media. See "Configuring nodes for Secure Boot manually" in the "Configuring nodes" section for additional details.
  2. **Managed:** To deploy an OpenShift Container Platform cluster with managed Secure Boot, you must set the **bootMode** value to **UEFISecureBoot** in the **install-config.yaml** file. Red Hat only supports installer-provisioned installation with managed Secure Boot on 10th generation HPE hardware and 13th generation Dell hardware running firmware version **2.75.75.75** or greater. Deploying with managed Secure Boot does not require Redfish virtual media. See "Configuring managed Secure Boot" in the "Setting up the environment for an OpenShift installation" section for details.

**NOTE**

Red Hat does not support Secure Boot with self-generated keys.

### 13.2.2. Planning a bare metal cluster for OpenShift Virtualization

If you will use OpenShift Virtualization, it is important to be aware of several requirements before you install your bare metal cluster.

- If you want to use live migration features, you must have multiple worker nodes *at the time of cluster installation*. This is because live migration requires the cluster-level high availability (HA) flag to be set to true. The HA flag is set when a cluster is installed and cannot be changed afterwards. If there are fewer than two worker nodes defined when you install your cluster, the HA flag is set to false for the life of the cluster.

**NOTE**

You can install OpenShift Virtualization on a single-node cluster, but single-node OpenShift does not support high availability.

- Live migration requires shared storage. Storage for OpenShift Virtualization must support and use the ReadWriteMany (RWX) access mode.
- If you plan to use Single Root I/O Virtualization (SR-IOV), ensure that your network interface controllers (NICs) are supported by OpenShift Container Platform.

#### Additional resources

- [Preparing your cluster for OpenShift Virtualization](#)
- [About Single Root I/O Virtualization \(SR-IOV\) hardware networks](#)

- [Connecting a virtual machine to an SR-IOV network](#)

### 13.2.3. Firmware requirements for installing with virtual media

The installation program for installer-provisioned OpenShift Container Platform clusters validates the hardware and firmware compatibility with Redfish virtual media. The installation program does not begin installation on a node if the node firmware is not compatible. The following tables list the minimum firmware versions tested and verified to work for installer-provisioned OpenShift Container Platform clusters deployed by using Redfish virtual media.



#### NOTE

Red Hat does not test every combination of firmware, hardware, or other third-party components. For further information about third-party support, see [Red Hat third-party support policy](#). For information about updating the firmware, see the hardware documentation for the nodes or contact the hardware vendor.

**Table 13.1. Firmware compatibility for HP hardware with Redfish virtual media**

Model	Management	Firmware versions
10th Generation	iLO5	2.63 or later

**Table 13.2. Firmware compatibility for Dell hardware with Redfish virtual media**

Model	Management	Firmware versions
15th Generation	iDRAC 9	v5.10.00.00 - v5.10.50.00 only
14th Generation	iDRAC 9	v5.10.00.00 - v5.10.50.00 only
13th Generation	iDRAC 8	v2.75.75.75 or later



#### NOTE

For Dell servers, ensure the OpenShift Container Platform cluster nodes have **AutoAttach** enabled through the iDRAC console. The menu path is **Configuration → Virtual Media → Attach Mode → AutoAttach**. With iDRAC 9 firmware version **04.40.00.00** and all releases up to including the **5.xx** series, the virtual console plugin defaults to eHTML5, an enhanced version of HTML5, which causes problems with the **InsertVirtualMedia** workflow. Set the plugin to use HTML5 to avoid this issue. The menu path is **Configuration → Virtual console → Plug-in Type → HTML5**.

### 13.2.4. Network requirements

Installer-provisioned installation of OpenShift Container Platform involves several network requirements. First, installer-provisioned installation involves an optional non-routable **provisioning** network for provisioning the operating system on each bare metal node. Second, installer-provisioned installation involves a routable **baremetal** network.

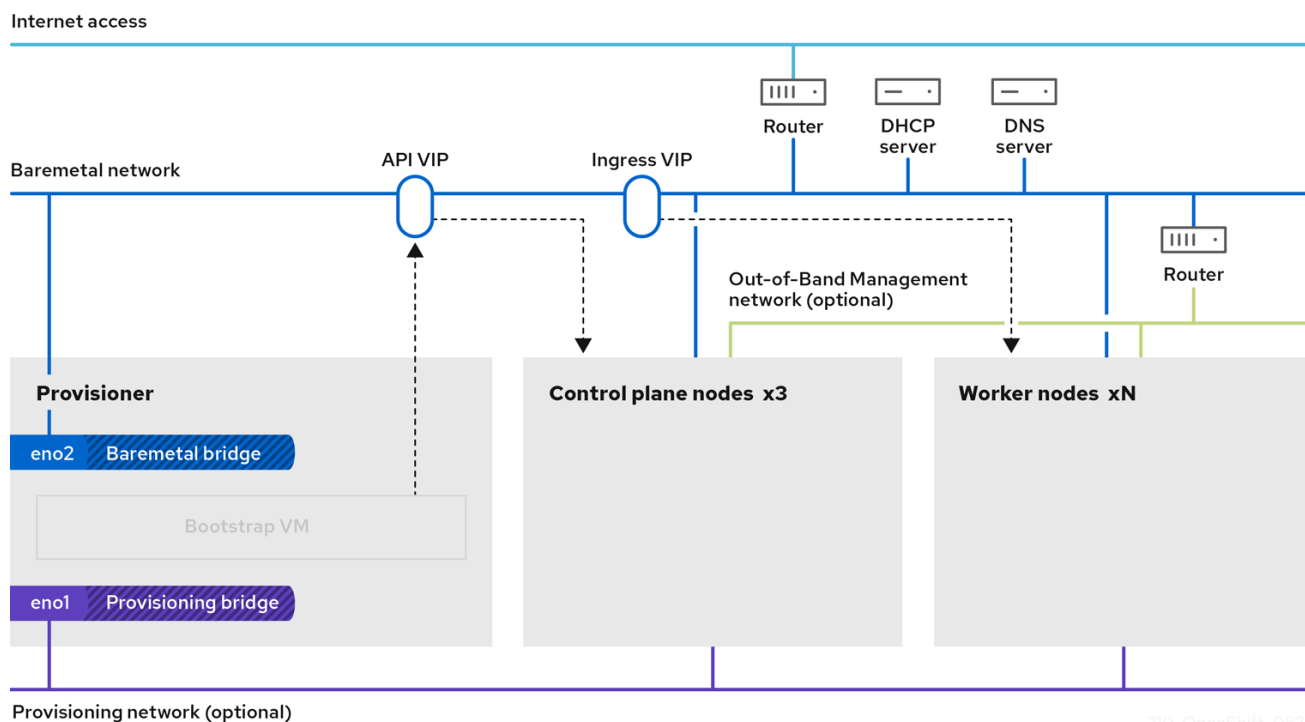

210\_OpenShift\_0822

### 13.2.4.1. Increase the network MTU

Before deploying OpenShift Container Platform, increase the network maximum transmission unit (MTU) to 1500 or more. If the MTU is lower than 1500, the Ironic image that is used to boot the node might fail to communicate with the Ironic inspector pod, and inspection will fail. If this occurs, installation stops because the nodes are not available for installation.

### 13.2.4.2. Configuring NICs

OpenShift Container Platform deploys with two networks:

- **provisioning**: The **provisioning** network is an optional non-routable network used for provisioning the underlying operating system on each node that is a part of the OpenShift Container Platform cluster. The network interface for the **provisioning** network on each cluster node must have the BIOS or UEFI configured to PXE boot.

The **provisioningNetworkInterface** configuration setting specifies the **provisioning** network NIC name on the control plane nodes, which must be identical on the control plane nodes. The **bootMACAddress** configuration setting provides a means to specify a particular NIC on each node for the **provisioning** network.

The **provisioning** network is optional, but it is required for PXE booting. If you deploy without a **provisioning** network, you must use a virtual media BMC addressing option such as **redfish-virtualmedia** or **idrac-virtualmedia**.

- **baremetal**: The **baremetal** network is a routable network. You can use any NIC to interface with the **baremetal** network provided the NIC is not configured to use the **provisioning** network.



#### IMPORTANT

When using a VLAN, each NIC must be on a separate VLAN corresponding to the appropriate network.

### 13.2.4.3. DNS requirements

Clients access the OpenShift Container Platform cluster nodes over the **baremetal** network. A network administrator must configure a subdomain or subzone where the canonical name extension is the cluster name.

```
<cluster_name>.<base_domain>
```

For example:

```
test-cluster.example.com
```

OpenShift Container Platform includes functionality that uses cluster membership information to generate A/AAAA records. This resolves the node names to their IP addresses. After the nodes are registered with the API, the cluster can disperse node information without using CoreDNS-mDNS. This eliminates the network traffic associated with multicast DNS.

In OpenShift Container Platform deployments, DNS name resolution is required for the following components:

- The Kubernetes API
- The OpenShift Container Platform application wildcard ingress API

A/AAAA records are used for name resolution and PTR records are used for reverse name resolution. Red Hat Enterprise Linux CoreOS (RHCOS) uses the reverse records or DHCP to set the hostnames for all the nodes.

Installer-provisioned installation includes functionality that uses cluster membership information to generate A/AAAA records. This resolves the node names to their IP addresses. In each record, **<cluster\_name>** is the cluster name and **<base\_domain>** is the base domain that you specify in the **install-config.yaml** file. A complete DNS record takes the form: **<component>.<cluster\_name>.<base\_domain>.**

Table 13.3. Required DNS records

Component	Record	Description
Kubernetes API	<b>api.&lt;cluster_name&gt;.&lt;base_domain&gt;.</b>	An A/AAAA record and a PTR record identify the API load balancer. These records must be resolvable by both clients external to the cluster and from all the nodes within the cluster.
Routes	<b>*.apps.&lt;cluster_name&gt;.&lt;base_domain&gt;.</b>	The wildcard A/AAAA record refers to the application ingress load balancer. The application ingress load balancer targets the nodes that run the Ingress Controller pods. The Ingress Controller pods run on the worker nodes by default. These records must be resolvable by both clients external to the cluster and from all the nodes within the cluster.  For example, <b>console-openshift-console.apps.&lt;cluster_name&gt;.&lt;base_domain&gt;</b> is used as a wildcard route to the OpenShift Container Platform console.

**TIP**

You can use the **dig** command to verify DNS resolution.

**13.2.4.4. Dynamic Host Configuration Protocol (DHCP) requirements**

By default, installer-provisioned installation deploys **ironic-dnsmasq** with DHCP enabled for the **provisioning** network. No other DHCP servers should be running on the **provisioning** network when the **provisioningNetwork** configuration setting is set to **managed**, which is the default value. If you have a DHCP server running on the **provisioning** network, you must set the **provisioningNetwork** configuration setting to **unmanaged** in the **install-config.yaml** file.

Network administrators must reserve IP addresses for each node in the OpenShift Container Platform cluster for the **baremetal** network on an external DHCP server.

**13.2.4.5. Reserving IP addresses for nodes with the DHCP server**

For the **baremetal** network, a network administrator must reserve a number of IP addresses, including:

1. Two unique virtual IP addresses.
  - One virtual IP address for the API endpoint.
  - One virtual IP address for the wildcard ingress endpoint.
2. One IP address for the provisioner node.
3. One IP address for each control plane node.
4. One IP address for each worker node, if applicable.

**RESERVING IP ADDRESSES SO THEY BECOME STATIC IP ADDRESSES**

Some administrators prefer to use static IP addresses so that each node's IP address remains constant in the absence of a DHCP server. To configure static IP addresses with NMState, see "(Optional) Configuring host network interfaces" in the "Setting up the environment for an OpenShift installation" section.

**NETWORKING BETWEEN EXTERNAL LOAD BALANCERS AND CONTROL PLANE NODES**

External load balancing services and the control plane nodes must run on the same L2 network, and on the same VLAN when using VLANs to route traffic between the load balancing services and the control plane nodes.

**IMPORTANT**

The storage interface requires a DHCP reservation or a static IP.

The following table provides an exemplary embodiment of fully qualified domain names. The API and Nameserver addresses begin with canonical name extensions. The hostnames of the control plane and worker nodes are exemplary, so you can use any host naming convention you prefer.

Usage	Host Name	IP
API	<b>api.&lt;cluster_name&gt;.&lt;base_domain&gt;</b>	<b>&lt;ip&gt;</b>
Ingress LB (apps)	<b>*.apps.&lt;cluster_name&gt;.&lt;base_domain&gt;</b>	<b>&lt;ip&gt;</b>
Provisioner node	<b>provisioner.&lt;cluster_name&gt;.&lt;base_domain&gt;</b>	<b>&lt;ip&gt;</b>
Control-plane-0	<b>openshift-control-plane-0.&lt;cluster_name&gt;.&lt;base_domain&gt;</b>	<b>&lt;ip&gt;</b>
Control-plane-1	<b>openshift-control-plane-1.&lt;cluster_name&gt;.&lt;base_domain&gt;</b>	<b>&lt;ip&gt;</b>
Control-plane-2	<b>openshift-control-plane-2.&lt;cluster_name&gt;.&lt;base_domain&gt;</b>	<b>&lt;ip&gt;</b>
Worker-0	<b>openshift-worker-0.&lt;cluster_name&gt;.&lt;base_domain&gt;</b>	<b>&lt;ip&gt;</b>
Worker-1	<b>openshift-worker-1.&lt;cluster_name&gt;.&lt;base_domain&gt;</b>	<b>&lt;ip&gt;</b>
Worker-n	<b>openshift-worker-n.&lt;cluster_name&gt;.&lt;base_domain&gt;</b>	<b>&lt;ip&gt;</b>

**NOTE**

If you do not create DHCP reservations, the installer requires reverse DNS resolution to set the hostnames for the Kubernetes API node, the provisioner node, the control plane nodes, and the worker nodes.

**13.2.4.6. Network Time Protocol (NTP)**

Each OpenShift Container Platform node in the cluster must have access to an NTP server. OpenShift Container Platform nodes use NTP to synchronize their clocks. For example, cluster nodes use SSL certificates that require validation, which might fail if the date and time between the nodes are not in sync.

**IMPORTANT**

Define a consistent clock date and time format in each cluster node's BIOS settings, or installation might fail.

You can reconfigure the control plane nodes to act as NTP servers on disconnected clusters, and reconfigure worker nodes to retrieve time from the control plane nodes.

**13.2.4.7. Port access for the out-of-band management IP address**

The out-of-band management IP address is on a separate network from the node. To ensure that the



out-of-band management can communicate with the provisioner during installation, the out-of-band management IP address must be granted access to port **80** on the bootstrap host and port **6180** on the OpenShift Container Platform control plane hosts. TLS port **6183** is required for virtual media installation, for example, via Redfish.

### 13.2.5. Configuring nodes

#### Configuring nodes when using the provisioning network

Each node in the cluster requires the following configuration for proper installation.



#### WARNING

A mismatch between nodes will cause an installation failure.

While the cluster nodes can contain more than two NICs, the installation process only focuses on the first two NICs. In the following table, NIC1 is a non-routable network (**provisioning**) that is only used for the installation of the OpenShift Container Platform cluster.

NIC	Network	VLAN
NIC1	<b>provisioning</b>	<provisioning_vlan>
NIC2	<b>baremetal</b>	<baremetal_vlan>

The Red Hat Enterprise Linux (RHEL) 8.x installation process on the provisioner node might vary. To install Red Hat Enterprise Linux (RHEL) 8.x using a local Satellite server or a PXE server, PXE-enable NIC2.

PXE	Boot order
NIC1 PXE-enabled <b>provisioning</b> network	1
NIC2 <b>baremetal</b> network. PXE-enabled is optional.	2

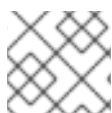

#### NOTE

Ensure PXE is disabled on all other NICs.

Configure the control plane and worker nodes as follows:

PXE	Boot order
NIC1 PXE-enabled (provisioning network)	1

### Configuring nodes without the provisioning network

The installation process requires one NIC:

NIC	Network	VLAN
NICx	<b>baremetal</b>	<b>&lt;baremetal_vlan&gt;</b>

NICx is a routable network (**baremetal**) that is used for the installation of the OpenShift Container Platform cluster, and routable to the internet.



#### IMPORTANT

The **provisioning** network is optional, but it is required for PXE booting. If you deploy without a **provisioning** network, you must use a virtual media BMC addressing option such as **redfish-virtualmedia** or **idrac-virtualmedia**.

### Configuring nodes for Secure Boot manually

Secure Boot prevents a node from booting unless it verifies the node is using only trusted software, such as UEFI firmware drivers, EFI applications, and the operating system.



#### NOTE

Red Hat only supports manually configured Secure Boot when deploying with Redfish virtual media.

To enable Secure Boot manually, refer to the hardware guide for the node and execute the following:

#### Procedure

1. Boot the node and enter the BIOS menu.
2. Set the node's boot mode to **UEFI Enabled**.
3. Enable Secure Boot.



#### IMPORTANT

Red Hat does not support Secure Boot with self-generated keys.

### Configuring the Compatibility Support Module for Fujitsu iRMC

The Compatibility Support Module (CSM) configuration provides support for legacy BIOS backward compatibility with UEFI systems. You must configure the CSM when you deploy a cluster with Fujitsu iRMC, otherwise the installation might fail.



#### NOTE

For information about configuring the CSM for your specific node type, refer to the hardware guide for the node.

#### Prerequisites

- Ensure that you have disabled Secure Boot Control. You can disable the feature under **Security** → **Secure Boot Configuration** → **Secure Boot Control**

### Procedure

1. Boot the node and select the BIOS menu.
2. Under the **Advanced** tab, select **CSM Configuration** from the list.
3. Enable the **Launch CSM** option and set the following values:

Item	Value
Boot option filter	UEFI and Legacy
Launch PXE OpROM Policy	UEFI only
Launch Storage OpROM policy	UEFI only
Other PCI device ROM priority	UEFI only

### 13.2.6. Out-of-band management

Nodes typically have an additional NIC used by the baseboard management controllers (BMCs). These BMCs must be accessible from the provisioner node.

Each node must be accessible via out-of-band management. When using an out-of-band management network, the provisioner node requires access to the out-of-band management network for a successful OpenShift Container Platform installation.

The out-of-band management setup is out of scope for this document. Using a separate management network for out-of-band management can enhance performance and improve security. However, using the provisioning network or the bare metal network are valid options.



#### NOTE

The bootstrap VM features a maximum of two network interfaces. If you configure a separate management network for out-of-band management, and you are using a provisioning network, the bootstrap VM requires routing access to the management network through one of the network interfaces. In this scenario, the bootstrap VM can then access three networks:

- the bare metal network
- the provisioning network
- the management network routed through one of the network interfaces

### 13.2.7. Required data for installation

Prior to the installation of the OpenShift Container Platform cluster, gather the following information from all cluster nodes:

- Out-of-band management IP
  - Examples
    - Dell (iDRAC) IP
    - HP (iLO) IP
    - Fujitsu (iRMC) IP

#### When using the **provisioning** network

- NIC (**provisioning**) MAC address
- NIC (**baremetal**) MAC address

#### When omitting the **provisioning** network

- NIC (**baremetal**) MAC address

### 13.2.8. Validation checklist for nodes

#### When using the **provisioning** network

- NIC1 VLAN is configured for the **provisioning** network.
- NIC1 for the **provisioning** network is PXE-enabled on the provisioner, control plane, and worker nodes.
- NIC2 VLAN is configured for the **baremetal** network.
- PXE has been disabled on all other NICs.
- DNS is configured with API and Ingress endpoints.
- Control plane and worker nodes are configured.
- All nodes accessible via out-of-band management.
- (Optional) A separate management network has been created.
- Required data for installation.

#### When omitting the **provisioning** network

- NIC1 VLAN is configured for the **baremetal** network.
- DNS is configured with API and Ingress endpoints.
- Control plane and worker nodes are configured.
- All nodes accessible via out-of-band management.
- (Optional) A separate management network has been created.
- Required data for installation.

## 13.3. SETTING UP THE ENVIRONMENT FOR AN OPENSIFT INSTALLATION

### 13.3.1. Installing RHEL on the provisioner node

With the configuration of the prerequisites complete, the next step is to install RHEL 8.x on the provisioner node. The installer uses the provisioner node as the orchestrator while installing the OpenShift Container Platform cluster. For the purposes of this document, installing RHEL on the provisioner node is out of scope. However, options include but are not limited to using a RHEL Satellite server, PXE, or installation media.

### 13.3.2. Preparing the provisioner node for OpenShift Container Platform installation

Perform the following steps to prepare the environment.

#### Procedure

1. Log in to the provisioner node via **ssh**.
2. Create a non-root user (**kni**) and provide that user with **sudo** privileges:

```
# useradd kni
```

```
# passwd kni
```

```
# echo "kni ALL=(root) NOPASSWD:ALL" | tee -a /etc/sudoers.d/kni
```

```
# chmod 0440 /etc/sudoers.d/kni
```

3. Create an **ssh** key for the new user:

```
# su - kni -c "ssh-keygen -t ed25519 -f /home/kni/.ssh/id_rsa -N ""
```

4. Log in as the new user on the provisioner node:

```
# su - kni
```

5. Use Red Hat Subscription Manager to register the provisioner node:

```
$ sudo subscription-manager register --username=<user> --password=<pass> --auto-attach
$ sudo subscription-manager repos --enable=rhel-8-for-x86_64-appstream-rpms --
enable=rhel-8-for-x86_64-baseos-rpms
```



#### NOTE

For more information about Red Hat Subscription Manager, see [Using and Configuring Red Hat Subscription Manager](#).

6. Install the following packages:

```
$ sudo dnf install -y libvirt qemu-kvm mkisofs python3-devel jq ipmitool
```

7. Modify the user to add the **libvirt** group to the newly created user:

```
$ sudo usermod --append --groups libvirt <user>
```

8. Restart **firewalld** and enable the **http** service:

```
$ sudo systemctl start firewalld
```

```
$ sudo firewall-cmd --zone=public --add-service=http --permanent
```

```
$ sudo firewall-cmd --reload
```

9. Start and enable the **libvirtd** service:

```
$ sudo systemctl enable libvirtd --now
```

10. Create the **default** storage pool and start it:

```
$ sudo virsh pool-define-as --name default --type dir --target /var/lib/libvirt/images
```

```
$ sudo virsh pool-start default
```

```
$ sudo virsh pool-autostart default
```

11. Configure networking.

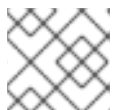

#### NOTE

You can also configure networking from the web console.

Export the **baremetal** network NIC name:

```
$ export PUB_CONN=<baremetal_nic_name>
```

Configure the **baremetal** network:

```
$ sudo nohup bash -c "
  nmcli con down \"\$PUB_CONN\"
  nmcli con delete \"\$PUB_CONN\"
  # RHEL 8.1 appends the word \"System\" in front of the connection, delete in case it exists
  nmcli con down \"System \$PUB_CONN\"
  nmcli con delete \"System \$PUB_CONN\"
  nmcli connection add ifname baremetal type bridge con-name baremetal bridge.stp no
  nmcli con add type bridge-slave ifname \"\$PUB_CONN\" master baremetal
  pkill dhclient;dhclient baremetal
"
```

If you are deploying with a **provisioning** network, export the **provisioning** network NIC name:

```
$ export PROV_CONN=<prov_nic_name>
```

If you are deploying with a **provisioning** network, configure the **provisioning** network:

```
$ sudo nohup bash -c "
  nmcli con down \"$PROV_CONN\"
  nmcli con delete \"$PROV_CONN\"
  nmcli connection add ifname provisioning type bridge con-name provisioning
  nmcli con add type bridge-slave ifname \"$PROV_CONN\" master provisioning
  nmcli connection modify provisioning ipv6.addresses fd00:1101::1/64 ipv6.method manual
  nmcli con down provisioning
  nmcli con up provisioning
"
```



#### NOTE

The **ssh** connection might disconnect after executing these steps.

The IPv6 address can be any address as long as it is not routable via the **baremetal** network.

Ensure that UEFI is enabled and UEFI PXE settings are set to the IPv6 protocol when using IPv6 addressing.

- Configure the IPv4 address on the **provisioning** network connection:

```
$ nmcli connection modify provisioning ipv4.addresses 172.22.0.254/24 ipv4.method manual
```

- ssh** back into the **provisioner** node (if required):

```
# ssh kni@provisioner.<cluster-name>.<domain>
```

- Verify the connection bridges have been properly created:

```
$ sudo nmcli con show
```

NAME	UUID	TYPE	DEVICE
baremetal	4d5133a5-8351-4bb9-bfd4-3af264801530	bridge	baremetal
provisioning	43942805-017f-4d7d-a2c2-7cb3324482ed	bridge	provisioning
virbr0	d9bca40f-eee1-410b-8879-a2d4bb0465e7	bridge	virbr0
bridge-slave-eno1	76a8ed50-c7e5-4999-b4f6-6d9014dd0812	ethernet	eno1
bridge-slave-eno2	f31c3353-54b7-48de-893a-02d2b34c4736	ethernet	eno2

- Create a **pull-secret.txt** file:

```
$ vim pull-secret.txt
```

In a web browser, navigate to [Install OpenShift on Bare Metal with installer-provisioned infrastructure](#). Click **Copy pull secret**. Paste the contents into the **pull-secret.txt** file and save the contents in the **kni** user's home directory.

### 13.3.3. Establishing communication between subnets

In a typical OpenShift Container Platform cluster setup, all nodes, including the control plane and worker nodes, reside in the same network. However, for edge computing scenarios, it can be beneficial to locate worker nodes closer to the edge. This often involves using different network segments or subnets for the remote worker nodes than the subnet used by the control plane and local worker nodes. Such a setup can reduce latency for the edge and allow for enhanced scalability. However, the network must be configured properly before installing OpenShift Container Platform to ensure that the edge subnets containing the remote worker nodes can reach the subnet containing the control plane nodes and receive traffic from the control plane too.



## IMPORTANT

All control plane nodes must run in the same subnet. When using more than one subnet, you can also configure the Ingress VIP to run on the control plane nodes by using a manifest. See "Configuring network components to run on the control plane" for details.

Deploying a cluster with multiple subnets requires using virtual media.

This procedure details the network configuration required to allow the remote worker nodes in the second subnet to communicate effectively with the control plane nodes in the first subnet and to allow the control plane nodes in the first subnet to communicate effectively with the remote worker nodes in the second subnet.

In this procedure, the cluster spans two subnets:

- The first subnet (**10.0.0.0**) contains the control plane and local worker nodes.
- The second subnet (**192.168.0.0**) contains the edge worker nodes.

## Procedure

1. Configure the first subnet to communicate with the second subnet:

- a. Log in as **root** to a control plane node by running the following command:

```
$ sudo su -
```

- b. Get the name of the network interface:

```
# nmcli dev status
```

- c. Add a route to the second subnet (**192.168.0.0**) via the gateway: s+

```
# nmcli connection modify <interface_name> +ipv4.routes "192.168.0.0/24 via <gateway>"
```

+ Replace **<interface\_name>** with the interface name. Replace **<gateway>** with the IP address of the actual gateway.

+ .Example

+

```
# nmcli connection modify eth0 +ipv4.routes "192.168.0.0/24 via 192.168.0.1"
```

- a. Apply the changes:



```
# nmcli connection up <interface_name>
```

Replace **<interface\_name>** with the interface name.

- b. Verify the routing table to ensure the route has been added successfully:

```
# ip route
```

- c. Repeat the previous steps for each control plane node in the first subnet.

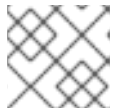

#### NOTE

Adjust the commands to match your actual interface names and gateway.

1. Configure the second subnet to communicate with the first subnet:

- d. Log in as **root** to a remote worker node:

```
$ sudo su -
```

- e. Get the name of the network interface:

```
# nmcli dev status
```

- f. Add a route to the first subnet (**10.0.0.0**) via the gateway:

```
# nmcli connection modify <interface_name> +ipv4.routes "10.0.0.0/24 via <gateway>"
```

Replace **<interface\_name>** with the interface name. Replace **<gateway>** with the IP address of the actual gateway.

#### Example

```
# nmcli connection modify eth0 +ipv4.routes "10.0.0.0/24 via 10.0.0.1"
```

- g. Apply the changes:

```
# nmcli connection up <interface_name>
```

Replace **<interface\_name>** with the interface name.

- h. Verify the routing table to ensure the route has been added successfully:

```
# ip route
```

- i. Repeat the previous steps for each worker node in the second subnet.

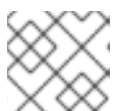

#### NOTE

Adjust the commands to match your actual interface names and gateway.

1. Once you have configured the networks, test the connectivity to ensure the remote worker nodes can reach the control plane nodes and the control plane nodes can reach the remote worker nodes.
- j. From the control plane nodes in the first subnet, ping a remote worker node in the second subnet:

```
$ ping <remote_worker_node_ip_address>
```

If the ping is successful, it means the control plane nodes in the first subnet can reach the remote worker nodes in the second subnet. If you don't receive a response, review the network configurations and repeat the procedure for the node.

- k. From the remote worker nodes in the second subnet, ping a control plane node in the first subnet:

```
$ ping <control_plane_node_ip_address>
```

If the ping is successful, it means the remote worker nodes in the second subnet can reach the control plane in the first subnet. If you don't receive a response, review the network configurations and repeat the procedure for the node.

#### 13.3.4. Retrieving the OpenShift Container Platform installer

Use the **stable-4.x** version of the installer to deploy the generally available stable version of OpenShift Container Platform:

```
$ export VERSION=stable-4.10
export RELEASE_IMAGE=$(curl -s https://mirror.openshift.com/pub/openshift-
v4/clients/ocp/$VERSION/release.txt | grep 'Pull From: quay.io' | awk -F ' ' '{print $3}')
```

#### 13.3.5. Extracting the OpenShift Container Platform installer

After retrieving the installer, the next step is to extract it.

##### Procedure

1. Set the environment variables:

```
$ export cmd=openshift-baremetal-install
```

```
$ export pullsecret_file=~/.pull-secret.txt
```

```
$ export extract_dir=$(pwd)
```

2. Get the **oc** binary:

```
$ curl -s https://mirror.openshift.com/pub/openshift-v4/clients/ocp/$VERSION/openshift-client-
linux.tar.gz | tar zxvf - oc
```

3. Extract the installer:

```
$ sudo cp oc /usr/local/bin
```

```
$ oc adm release extract --registry-config "${pullsecret_file}" --command=$cmd --to
"${extract_dir}" ${RELEASE_IMAGE}
```

```
$ sudo cp openshift-baremetal-install /usr/local/bin
```

### 13.3.6. (Optional) Creating an RHCOS images cache

To employ image caching, you must download the Red Hat Enterprise Linux CoreOS (RHCOS) image used by the bootstrap VM to provision the cluster nodes. Image caching is optional, but it is especially useful when running the installation program on a network with limited bandwidth.



#### NOTE

The installation program no longer needs the **clusterOSImage** RHCOS image because the correct image is in the release payload.

If you are running the installation program on a network with limited bandwidth and the RHCOS images download takes more than 15 to 20 minutes, the installation program will timeout. Caching images on a web server will help in such scenarios.

Install a container that contains the images.

#### Procedure

1. Install **podman**:

```
$ sudo dnf install -y podman
```

2. Open firewall port **8080** to be used for RHCOS image caching:

```
$ sudo firewall-cmd --add-port=8080/tcp --zone=public --permanent
```

```
$ sudo firewall-cmd --reload
```

3. Create a directory to store the **bootstraposimage**:

```
$ mkdir /home/kni/rhcos_image_cache
```

4. Set the appropriate SELinux context for the newly created directory:

```
$ sudo semanage fcontext -a -t httpd_sys_content_t "/home/kni/rhcos_image_cache(/.*)?"
```

```
$ sudo restorecon -Rv /home/kni/rhcos_image_cache/
```

5. Get the URI for the RHCOS image that the installation program will deploy on the bootstrap VM:

```
$ export RHCOS_QEMU_URI=$(/usr/local/bin/openshift-baremetal-install coreos print-stream-json | jq -r --arg ARCH "$(arch)"
'.architectures[$ARCH].artifacts.qemu.formats["qcow2.gz"].disk.location')
```

- Get the name of the image that the installation program will deploy on the bootstrap VM:

```
$ export RHCOS_QEMU_NAME=${RHCOS_QEMU_URI##*/}
```

- Get the SHA hash for the RHCOS image that will be deployed on the bootstrap VM:

```
$ export RHCOS_QEMU_UNCOMPRESSED_SHA256=$(/usr/local/bin/openshift-baremetal-install coreos print-stream-json | jq -r --arg ARCH "$(arch)"
'.architectures[$ARCH].artifacts.qemu.formats["qcow2.gz"].disk["uncompressed-sha256"]')
```

- Download the image and place it in the `/home/kni/rhcos_image_cache` directory:

```
$ curl -L ${RHCOS_QEMU_URI} -o
/home/kni/rhcos_image_cache/${RHCOS_QEMU_NAME}
```

- Confirm SELinux type is of `httpd_sys_content_t` for the new file:

```
$ ls -Z /home/kni/rhcos_image_cache
```

- Create the pod:

```
$ podman run -d --name rhcos_image_cache \ 1
-v /home/kni/rhcos_image_cache:/var/www/html \
-p 8080:8080/tcp \
quay.io/centos7/httpd-24-centos7:latest
```

- 1** Creates a caching webserver with the name `rhcos_image_cache`. This pod serves the `bootstrapOSImage` image in the `install-config.yaml` file for deployment.

- Generate the `bootstrapOSImage` configuration:

```
$ export BAREMETAL_IP=$(ip addr show dev baremetal | awk '/inet /{print $2}' | cut -d"/" -f1)
```

```
$ export
BOOTSTRAP_OS_IMAGE="http://${BAREMETAL_IP}:8080/${RHCOS_QEMU_NAME}?
sha256=${RHCOS_QEMU_UNCOMPRESSED_SHA256}"
```

```
$ echo " bootstrapOSImage=${BOOTSTRAP_OS_IMAGE}"
```

- Add the required configuration to the `install-config.yaml` file under `platform.baremetal`:

```
platform:
  baremetal:
    bootstrapOSImage: <bootstrap_os_image> 1
```

- 1** Replace `<bootstrap_os_image>` with the value of `$BOOTSTRAP_OS_IMAGE`.

See the "Configuring the install-config.yaml file" section for additional details.

## 13.3.7. Configuring the install-config.yaml file

### 13.3.7.1. Configuring the install-config.yaml file

The **install-config.yaml** file requires some additional details. Most of the information teaches the installation program and the resulting cluster enough about the available hardware that it is able to fully manage it.



#### NOTE

The installation program no longer needs the **clusterOSImage** RHCOS image because the correct image is in the release payload.

1. Configure **install-config.yaml**. Change the appropriate variables to match the environment, including **pullSecret** and **sshKey**.

```

apiVersion: v1
baseDomain: <domain>
metadata:
  name: <cluster-name>
networking:
  machineNetwork:
    - cidr: <public-cidr>
    networkType: OVNKubernetes
compute:
  - name: worker
    replicas: 2 1
controlPlane:
  name: master
  replicas: 3
  platform:
    baremetal: {}
platform:
  baremetal:
    apiVIP: <api-ip>
    ingressVIP: <wildcard-ip>
    provisioningNetworkCIDR: <CIDR>
  hosts:
    - name: openshift-master-0
      role: master
      bmc:
        address: ipmi://<out-of-band-ip> 2
        username: <user>
        password: <password>
        bootMACAddress: <NIC1-mac-address>
        rootDeviceHints:
          deviceName: "<installation_disk_drive_path>" 3
    - name: <openshift_master_1>
      role: master
      bmc:
        address: ipmi://<out-of-band-ip> 4
        username: <user>

```

```

    password: <password>
    bootMACAddress: <NIC1-mac-address>
    rootDeviceHints:
      deviceName: "<installation_disk_drive_path>" 5
- name: <openshift_master_2>
  role: master
  bmc:
    address: ipmi://<out-of-band-ip> 6
    username: <user>
    password: <password>
    bootMACAddress: <NIC1-mac-address>
    rootDeviceHints:
      deviceName: "<installation_disk_drive_path>" 7
- name: <openshift_worker_0>
  role: worker
  bmc:
    address: ipmi://<out-of-band-ip> 8
    username: <user>
    password: <password>
    bootMACAddress: <NIC1-mac-address>
- name: <openshift-worker-1>
  role: worker
  bmc:
    address: ipmi://<out-of-band-ip>
    username: <user>
    password: <password>
    bootMACAddress: <NIC1-mac-address>
    rootDeviceHints:
      deviceName: "<installation_disk_drive_path>" 9
pullSecret: '<pull_secret>'
sshKey: '<ssh_pub_key>'

```

- 1 Scale the worker machines based on the number of worker nodes that are part of the OpenShift Container Platform cluster. Valid options for the **replicas** value are **0** and integers greater than or equal to **2**. Set the number of replicas to **0** to deploy a three-node cluster, which contains only three control plane machines. A three-node cluster is a smaller, more resource-efficient cluster that can be used for testing, development, and production. You cannot install the cluster with only one worker.

2 4 6 8 See the BMC addressing sections for more options.

3 5 7 9 To set the path to the installation disk drive, enter the kernel name of the disk. For example, **/dev/sda**.



## IMPORTANT

Because the disk discovery order is not guaranteed, the kernel name of the disk can change across booting options for machines with multiple disks. For instance, `/dev/sda` becomes `/dev/sdb` and vice versa. To avoid this issue, you must use persistent disk attributes, such as the disk World Wide Name (WWN). To use the disk WWN, replace the `deviceName` parameter with the `wwnWithExtension` parameter. Depending on the parameter that you use, enter the disk name, for example, `/dev/sda` or the disk WWN, for example, `"0x64cd98f04fde100024684cf3034da5c2"`. Ensure that you enter the disk WWN value within quotes so that it is used as a string value and not a hexadecimal value.

Failure to meet these requirements for the `rootDeviceHints` parameter might result in the following error:

```
ironic-inspector inspection failed: No disks satisfied root device hints
```

2. Create a directory to store cluster configs:

```
$ mkdir ~/clusterconfigs
```

3. Copy the `install-config.yaml` file to the new directory:

```
$ cp install-config.yaml ~/clusterconfigs
```

4. Ensure all bare metal nodes are powered off prior to installing the OpenShift Container Platform cluster:

```
$ ipmitool -I lanplus -U <user> -P <password> -H <management-server-ip> power off
```

5. Remove old bootstrap resources if any are left over from a previous deployment attempt:

```
for i in $(sudo virsh list | tail -n +3 | grep bootstrap | awk {'print $2'});
do
  sudo virsh destroy $i;
  sudo virsh undefine $i;
  sudo virsh vol-delete $i --pool $i;
  sudo virsh vol-delete $i.ign --pool $i;
  sudo virsh pool-destroy $i;
  sudo virsh pool-undefine $i;
done
```

### 13.3.7.2. Additional `install-config` parameters

See the following tables for the required parameters, the `hosts` parameter, and the `bmc` parameter for the `install-config.yaml` file.

Table 13.4. Required parameters

Parameters	Default	Description
<b>baseDomain</b>		The domain name for the cluster. For example, <b>example.com</b> .
<b>bootMode</b>	<b>UEFI</b>	The boot mode for a node. Options are <b>legacy</b> , <b>UEFI</b> , and <b>UEFISecureBoot</b> . If <b>bootMode</b> is not set, Ironic sets it while inspecting the node.
<b>sshKey</b>		The <b>sshKey</b> configuration setting contains the key in the <code>~/.ssh/id_rsa.pub</code> file required to access the control plane nodes and worker nodes. Typically, this key is from the <b>provisioner</b> node.
<b>pullSecret</b>		The <b>pullSecret</b> configuration setting contains a copy of the pull secret downloaded from the <a href="#">Install OpenShift on Bare Metal</a> page when preparing the provisioner node.
<b>metadata:</b> name:		The name to be given to the OpenShift Container Platform cluster. For example, <b>openshift</b> .
<b>networking:</b> machineNetwork: - cidr:		The public CIDR (Classless Inter-Domain Routing) of the external network. For example, <b>10.0.0.0/24</b> .
<b>compute:</b> - name: worker		The OpenShift Container Platform cluster requires a name be provided for worker (or compute) nodes even if there are zero nodes.
<b>compute:</b> replicas: 2		Replicas sets the number of worker (or compute) nodes in the OpenShift Container Platform cluster.
<b>controlPlane:</b> name: master		The OpenShift Container Platform cluster requires a name for control plane (master) nodes.



Parameters	Default	Description
<code>controlPlane: replicas: 3</code>		Replicas sets the number of control plane (master) nodes included as part of the OpenShift Container Platform cluster.
<code>provisioningNetworkInterface</code>		The name of the network interface on nodes connected to the provisioning network. For OpenShift Container Platform 4.9 and later releases, use the <b>bootMACAddress</b> configuration setting to enable Ironic to identify the IP address of the NIC instead of using the <b>provisioningNetworkInterface</b> configuration setting to identify the name of the NIC.
<code>defaultMachinePlatform</code>		The default configuration used for machine pools without a platform configuration.
<code>apiVIP</code>		(Optional) The virtual IP address for Kubernetes API communication.  This setting must either be provided in the <b>install-config.yaml</b> file as a reserved IP from the MachineNetwork or pre-configured in the DNS so that the default name resolves correctly. Use the virtual IP address and not the FQDN when adding a value to the <b>apiVIP</b> configuration setting in the <b>install-config.yaml</b> file. The IP address must be from the primary IPv4 network when using dual stack networking. If not set, the installer uses <b>api.&lt;cluster_name&gt;.&lt;base_domain&gt;</b> to derive the IP address from the DNS.
<code>disableCertificateVerification</code>	<b>False</b>	<b>redfish</b> and <b>redfish-virtualmedia</b> need this parameter to manage BMC addresses. The value should be <b>True</b> when using a self-signed certificate for BMC addresses.

Parameters	Default	Description
<b>ingressVIP</b>		<p>(Optional) The virtual IP address for ingress traffic.</p> <p>This setting must either be provided in the <b>install-config.yaml</b> file as a reserved IP from the MachineNetwork or pre-configured in the DNS so that the default name resolves correctly. Use the virtual IP address and not the FQDN when adding a value to the <b>ingressVIP</b> configuration setting in the <b>install-config.yaml</b> file. The IP address must be from the primary IPv4 network when using dual stack networking. If not set, the installer uses <b>test.apps.&lt;cluster_name&gt;.&lt;base_domain&gt;</b> to derive the IP address from the DNS.</p>

Table 13.5. Optional Parameters

Parameters	Default	Description
<b>provisioningDHCPRange</b>	<b>172.22.0.10,172.22.0.100</b>	Defines the IP range for nodes on the provisioning network.
<b>provisioningNetworkCIDR</b>	<b>172.22.0.0/24</b>	The CIDR for the network to use for provisioning. This option is required when not using the default address range on the provisioning network.
<b>clusterProvisioningIP</b>	The third IP address of the <b>provisioningNetworkCIDR</b> .	The IP address within the cluster where the provisioning services run. Defaults to the third IP address of the provisioning subnet. For example, <b>172.22.0.3</b> .
<b>bootstrapProvisioningIP</b>	The second IP address of the <b>provisioningNetworkCIDR</b> .	The IP address on the bootstrap VM where the provisioning services run while the installer is deploying the control plane (master) nodes. Defaults to the second IP address of the provisioning subnet. For example, <b>172.22.0.2</b> or <b>2620:52:0:1307::2</b> .
<b>externalBridge</b>	<b>baremetal</b>	The name of the bare-metal bridge of the hypervisor attached to the bare-metal network.

Parameters	Default	Description
<b>provisioningBridge</b>	<b>provisioning</b>	The name of the provisioning bridge on the <b>provisioner</b> host attached to the provisioning network.
<b>defaultMachinePlatform</b>		The default configuration used for machine pools without a platform configuration.
<b>bootstrapOSImage</b>		A URL to override the default operating system image for the bootstrap node. The URL must contain a SHA-256 hash of the image. For example: <a href="https://mirror.openshift.com/rhcos-&lt;version&gt;-qemu.qcow2.gz?sha256=&lt;uncompressed_sha256&gt;">https://mirror.openshift.com/rhcos-&lt;version&gt;-qemu.qcow2.gz?sha256=&lt;uncompressed_sha256&gt;</a> .
<b>provisioningNetwork</b>		<p>The <b>provisioningNetwork</b> configuration setting determines whether the cluster uses the provisioning network. If it does, the configuration setting also determines if the cluster manages the network.</p> <p><b>Disabled:</b> Set this parameter to <b>Disabled</b> to disable the requirement for a provisioning network. When set to <b>Disabled</b>, you must only use virtual media based provisioning, or bring up the cluster using the assisted installer. If <b>Disabled</b> and using power management, BMCs must be accessible from the bare-metal network. If <b>Disabled</b>, you must provide two IP addresses on the bare-metal network that are used for the provisioning services.</p> <p><b>Managed:</b> Set this parameter to <b>Managed</b>, which is the default, to fully manage the provisioning network, including DHCP, TFTP, and so on.</p> <p><b>Unmanaged:</b> Set this parameter to <b>Unmanaged</b> to enable the provisioning network but take care of manual configuration of DHCP. Virtual media provisioning is recommended but PXE is still available if required.</p>
<b>httpProxy</b>		Set this parameter to the appropriate HTTP proxy used within your environment.
<b>httpsProxy</b>		Set this parameter to the appropriate HTTPS proxy used within your environment.
<b>noProxy</b>		Set this parameter to the appropriate list of exclusions for proxy usage within your environment.

## Hosts

The **hosts** parameter is a list of separate bare metal assets used to build the cluster.

Table 13.6. Hosts

Name	Default	Description
<b>name</b>		The name of the <b>BareMetalHost</b> resource to associate with the details. For example, <b>openshift-master-0</b> .
<b>role</b>		The role of the bare metal node. Either <b>master</b> or <b>worker</b> .
<b>bmc</b>		Connection details for the baseboard management controller. See the BMC addressing section for additional details.
<b>bootMACAddress</b>		<p>The MAC address of the NIC that the host uses for the provisioning network. Ironic retrieves the IP address using the <b>bootMACAddress</b> configuration setting. Then, it binds to the host.</p> <div style="display: flex; align-items: flex-start;"> <div style="flex: 1;">  </div> <div style="flex: 2;"> <p><b>NOTE</b></p> <p>You must provide a valid MAC address from the host if you disabled the provisioning network.</p> </div> </div>
<b>networkConfig</b>		Set this optional parameter to configure the network interface of a host. See "(Optional) Configuring host network interfaces" for additional details.

### 13.3.7.3. BMC addressing

Most vendors support Baseboard Management Controller (BMC) addressing with the Intelligent Platform Management Interface (IPMI). IPMI does not encrypt communications. It is suitable for use within a data center over a secured or dedicated management network. Check with your vendor to see if they support Redfish network boot. Redfish delivers simple and secure management for converged, hybrid IT and the Software Defined Data Center (SDDC). Redfish is human readable and machine capable, and leverages common internet and web services standards to expose information directly to the modern tool chain. If your hardware does not support Redfish network boot, use IPMI.

#### IPMI

Hosts using IPMI use the **ipmi://<out-of-band-ip>:<port>** address format, which defaults to port **623** if not specified. The following example demonstrates an IPMI configuration within the **install-config.yaml** file.

```
platform:
  baremetal:
    hosts:
      - name: openshift-master-0
        role: master
    bmc:
      address: ipmi://<out-of-band-ip>
      username: <user>
      password: <password>
```



## IMPORTANT

The **provisioning** network is required when PXE booting using IPMI for BMC addressing. It is not possible to PXE boot hosts without a **provisioning** network. If you deploy without a **provisioning** network, you must use a virtual media BMC addressing option such as **redfish-virtualmedia** or **idrac-virtualmedia**. See "Redfish virtual media for HPE iLO" in the "BMC addressing for HPE iLO" section or "Redfish virtual media for Dell iDRAC" in the "BMC addressing for Dell iDRAC" section for additional details.

### Redfish network boot

To enable Redfish, use **redfish://** or **redfish+http://** to disable TLS. The installer requires both the hostname or the IP address and the path to the system ID. The following example demonstrates a Redfish configuration within the **install-config.yaml** file.

```
platform:
  baremetal:
    hosts:
      - name: openshift-master-0
        role: master
    bmc:
      address: redfish://<out-of-band-ip>/redfish/v1/Systems/1
      username: <user>
      password: <password>
```

While it is recommended to have a certificate of authority for the out-of-band management addresses, you must include **disableCertificateVerification: True** in the **bmc** configuration if using self-signed certificates. The following example demonstrates a Redfish configuration using the **disableCertificateVerification: True** configuration parameter within the **install-config.yaml** file.

```
platform:
  baremetal:
    hosts:
      - name: openshift-master-0
        role: master
    bmc:
      address: redfish://<out-of-band-ip>/redfish/v1/Systems/1
      username: <user>
      password: <password>
      disableCertificateVerification: True
```

#### 13.3.7.4. BMC addressing for Dell iDRAC

The **address** field for each **bmc** entry is a URL for connecting to the OpenShift Container Platform cluster nodes, including the type of controller in the URL scheme and its location on the network.

```
platform:
  baremetal:
    hosts:
      - name: <hostname>
        role: <master | worker>
    bmc:
```

```
address: <address> 1
username: <user>
password: <password>
```

- 1** The **address** configuration setting specifies the protocol.

For Dell hardware, Red Hat supports integrated Dell Remote Access Controller (iDRAC) virtual media, Redfish network boot, and IPMI.

### BMC address formats for Dell iDRAC

Protocol	Address Format
iDRAC virtual media	<b>idrac-virtualmedia://&lt;out-of-band-ip&gt;/redfish/v1/Systems/System.Embedded.1</b>
Redfish network boot	<b>redfish://&lt;out-of-band-ip&gt;/redfish/v1/Systems/System.Embedded.1</b>
IPMI	<b>ipmi://&lt;out-of-band-ip&gt;</b>

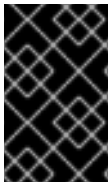

### IMPORTANT

Use **idrac-virtualmedia** as the protocol for Redfish virtual media. **redfish-virtualmedia** will not work on Dell hardware. Dell's **idrac-virtualmedia** uses the Redfish standard with Dell's OEM extensions.

See the following sections for additional details.

### Redfish virtual media for Dell iDRAC

For Redfish virtual media on Dell servers, use **idrac-virtualmedia://** in the **address** setting. Using **redfish-virtualmedia://** will not work.

The following example demonstrates using iDRAC virtual media within the **install-config.yaml** file.

```
platform:
  baremetal:
    hosts:
      - name: openshift-master-0
        role: master
    bmc:
      address: idrac-virtualmedia://<out-of-band-ip>/redfish/v1/Systems/System.Embedded.1
      username: <user>
      password: <password>
```

While it is recommended to have a certificate of authority for the out-of-band management addresses, you must include **disableCertificateVerification: True** in the **bmc** configuration if using self-signed certificates. The following example demonstrates a Redfish configuration using the **disableCertificateVerification: True** configuration parameter within the **install-config.yaml** file.

```
platform:
  baremetal:
    hosts:
```

```

- name: openshift-master-0
  role: master
  bmc:
    address: idrac-virtualmedia://<out-of-band-ip>/redfish/v1/Systems/System.Embedded.1
    username: <user>
    password: <password>
    disableCertificateVerification: True

```

## NOTE

There is a known issue on Dell iDRAC 9 with firmware version **04.40.00.00** or later for installer-provisioned installations on bare metal deployments. The Virtual Console plugin defaults to eHTML5, an enhanced version of HTML5, which causes problems with the **InsertVirtualMedia** workflow. Set the plugin to use HTML5 to avoid this issue. The menu path is **Configuration → Virtual console → Plug-in Type → HTML5**.

Ensure the OpenShift Container Platform cluster nodes have **AutoAttach** enabled through the iDRAC console. The menu path is: **Configuration → Virtual Media → Attach Mode → AutoAttach**.

Use **idrac-virtualmedia://** as the protocol for Redfish virtual media. Using **redfish-virtualmedia://** will not work on Dell hardware, because the **idrac-virtualmedia://** protocol corresponds to the **idrac** hardware type and the Redfish protocol in Ironic. Dell's **idrac-virtualmedia://** protocol uses the Redfish standard with Dell's OEM extensions. Ironic also supports the **idrac** type with the WSMAN protocol. Therefore, you must specify **idrac-virtualmedia://** to avoid unexpected behavior when electing to use Redfish with virtual media on Dell hardware.

## Redfish network boot for iDRAC

To enable Redfish, use **redfish://** or **redfish+http://** to disable transport layer security (TLS). The installer requires both the hostname or the IP address and the path to the system ID. The following example demonstrates a Redfish configuration within the **install-config.yaml** file.

```

platform:
  baremetal:
    hosts:
      - name: openshift-master-0
        role: master
        bmc:
          address: redfish://<out-of-band-ip>/redfish/v1/Systems/System.Embedded.1
          username: <user>
          password: <password>

```

While it is recommended to have a certificate of authority for the out-of-band management addresses, you must include **disableCertificateVerification: True** in the **bmc** configuration if using self-signed certificates. The following example demonstrates a Redfish configuration using the **disableCertificateVerification: True** configuration parameter within the **install-config.yaml** file.

```

platform:
  baremetal:
    hosts:
      - name: openshift-master-0
        role: master
        bmc:

```

```
address: redfish://<out-of-band-ip>/redfish/v1/Systems/System.Embedded.1
username: <user>
password: <password>
disableCertificateVerification: True
```

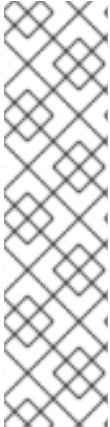

## NOTE

There is a known issue on Dell iDRAC 9 with firmware version **04.40.00.00** and all releases up to including the **5.xx** series for installer-provisioned installations on bare metal deployments. The virtual console plugin defaults to eHTML5, an enhanced version of HTML5, which causes problems with the **InsertVirtualMedia** workflow. Set the plugin to use HTML5 to avoid this issue. The menu path is **Configuration → Virtual console → Plug-in Type → HTML5**.

Ensure the OpenShift Container Platform cluster nodes have **AutoAttach** enabled through the iDRAC console. The menu path is: **Configuration → Virtual Media → Attach Mode → AutoAttach**.

### 13.3.7.5. BMC addressing for HPE iLO

The **address** field for each **bmc** entry is a URL for connecting to the OpenShift Container Platform cluster nodes, including the type of controller in the URL scheme and its location on the network.

```
platform:
  baremetal:
    hosts:
      - name: <hostname>
        role: <master | worker>
    bmc:
      address: <address> 1
      username: <user>
      password: <password>
```

**1** The **address** configuration setting specifies the protocol.

For HPE integrated Lights Out (iLO), Red Hat supports Redfish virtual media, Redfish network boot, and IPMI.

**Table 13.7. BMC address formats for HPE iLO**

Protocol	Address Format
Redfish virtual media	<b>redfish-virtualmedia://&lt;out-of-band-ip&gt;/redfish/v1/Systems/1</b>
Redfish network boot	<b>redfish://&lt;out-of-band-ip&gt;/redfish/v1/Systems/1</b>
IPMI	<b>ipmi://&lt;out-of-band-ip&gt;</b>

See the following sections for additional details.

#### Redfish virtual media for HPE iLO



To enable Redfish virtual media for HPE servers, use **redfish-virtualmedia://** in the **address** setting. The following example demonstrates using Redfish virtual media within the **install-config.yaml** file.

```
platform:
  baremetal:
    hosts:
      - name: openshift-master-0
        role: master
    bmc:
      address: redfish-virtualmedia://<out-of-band-ip>/redfish/v1/Systems/1
      username: <user>
      password: <password>
```

While it is recommended to have a certificate of authority for the out-of-band management addresses, you must include **disableCertificateVerification: True** in the **bmc** configuration if using self-signed certificates. The following example demonstrates a Redfish configuration using the **disableCertificateVerification: True** configuration parameter within the **install-config.yaml** file.

```
platform:
  baremetal:
    hosts:
      - name: openshift-master-0
        role: master
    bmc:
      address: redfish-virtualmedia://<out-of-band-ip>/redfish/v1/Systems/1
      username: <user>
      password: <password>
      disableCertificateVerification: True
```



#### NOTE

Redfish virtual media is not supported on 9th generation systems running iLO4, because Ironic does not support iLO4 with virtual media.

#### Redfish network boot for HPE iLO

To enable Redfish, use **redfish://** or **redfish+http://** to disable TLS. The installer requires both the hostname or the IP address and the path to the system ID. The following example demonstrates a Redfish configuration within the **install-config.yaml** file.

```
platform:
  baremetal:
    hosts:
      - name: openshift-master-0
        role: master
    bmc:
      address: redfish://<out-of-band-ip>/redfish/v1/Systems/1
      username: <user>
      password: <password>
```

While it is recommended to have a certificate of authority for the out-of-band management addresses, you must include **disableCertificateVerification: True** in the **bmc** configuration if using self-signed certificates. The following example demonstrates a Redfish configuration using the **disableCertificateVerification: True** configuration parameter within the **install-config.yaml** file.

```
platform:
  baremetal:
    hosts:
      - name: openshift-master-0
        role: master
    bmc:
      address: redfish://<out-of-band-ip>/redfish/v1/Systems/1
      username: <user>
      password: <password>
      disableCertificateVerification: True
```

### 13.3.7.6. BMC addressing for Fujitsu iRMC

The **address** field for each **bmc** entry is a URL for connecting to the OpenShift Container Platform cluster nodes, including the type of controller in the URL scheme and its location on the network.

```
platform:
  baremetal:
    hosts:
      - name: <hostname>
        role: <master | worker>
    bmc:
      address: <address> 1
      username: <user>
      password: <password>
```

1 The **address** configuration setting specifies the protocol.

For Fujitsu hardware, Red Hat supports integrated Remote Management Controller (iRMC) and IPMI.

Table 13.8. BMC address formats for Fujitsu iRMC

Protocol	Address Format
iRMC	<b>irmc://&lt;out-of-band-ip&gt;</b>
IPMI	<b>ipmi://&lt;out-of-band-ip&gt;</b>

### iRMC

Fujitsu nodes can use **irmc://<out-of-band-ip>** and defaults to port **443**. The following example demonstrates an iRMC configuration within the **install-config.yaml** file.

```
platform:
  baremetal:
    hosts:
      - name: openshift-master-0
        role: master
    bmc:
      address: irmc://<out-of-band-ip>
      username: <user>
      password: <password>
```

**NOTE**

Currently Fujitsu supports iRMC S5 firmware version 3.05P and above for installer-provisioned installation on bare metal.

**13.3.7.7. Root device hints**

The **rootDeviceHints** parameter enables the installer to provision the Red Hat Enterprise Linux CoreOS (RHCOS) image to a particular device. The installer examines the devices in the order it discovers them, and compares the discovered values with the hint values. The installer uses the first discovered device that matches the hint value. The configuration can combine multiple hints, but a device must match all hints for the installer to select it.

**Table 13.9. Subfields**

Subfield	Description
<b>deviceName</b>	A string containing a Linux device name like <b>/dev/vda</b> . The hint must match the actual value exactly.
<b>hctl</b>	A string containing a SCSI bus address like <b>0:0:0:0</b> . The hint must match the actual value exactly.
<b>model</b>	A string containing a vendor-specific device identifier. The hint can be a substring of the actual value.
<b>vendor</b>	A string containing the name of the vendor or manufacturer of the device. The hint can be a substring of the actual value.
<b>serialNumber</b>	A string containing the device serial number. The hint must match the actual value exactly.
<b>minSizeGigabytes</b>	An integer representing the minimum size of the device in gigabytes.
<b>wwn</b>	A string containing the unique storage identifier. The hint must match the actual value exactly.
<b>wwnWithExtension</b>	A string containing the unique storage identifier with the vendor extension appended. The hint must match the actual value exactly.
<b>wwnVendorExtension</b>	A string containing the unique vendor storage identifier. The hint must match the actual value exactly.
<b>rotational</b>	A boolean indicating whether the device should be a rotating disk (true) or not (false).

## Example usage

```
- name: master-0
  role: master
  bmc:
    address: ipmi://10.10.0.3:6203
    username: admin
    password: redhat
    bootMACAddress: de:ad:be:ef:00:40
  rootDeviceHints:
    deviceName: "/dev/sda"
```

### 13.3.7.8. (Optional) Setting proxy settings

To deploy an OpenShift Container Platform cluster using a proxy, make the following changes to the **install-config.yaml** file.

```
apiVersion: v1
baseDomain: <domain>
proxy:
  httpProxy: http://USERNAME:PASSWORD@proxy.example.com:PORT
  httpsProxy: https://USERNAME:PASSWORD@proxy.example.com:PORT
  noProxy: <WILDCARD_OF_DOMAIN>,<PROVISIONING_NETWORK/CIDR>,
  <BMC_ADDRESS_RANGE/CIDR>
```

The following is an example of **noProxy** with values.

```
noProxy: .example.com,172.22.0.0/24,10.10.0.0/24
```

With a proxy enabled, set the appropriate values of the proxy in the corresponding key/value pair.

Key considerations:

- If the proxy does not have an HTTPS proxy, change the value of **httpsProxy** from **https://** to **http://**.
- If using a provisioning network, include it in the **noProxy** setting, otherwise the installer will fail.
- Set all of the proxy settings as environment variables within the provisioner node. For example, **HTTP\_PROXY**, **HTTPS\_PROXY**, and **NO\_PROXY**.



#### NOTE

When provisioning with IPv6, you cannot define a CIDR address block in the **noProxy** settings. You must define each address separately.

### 13.3.7.9. (Optional) Deploying with no provisioning network

To deploy an OpenShift Container Platform cluster without a **provisioning** network, make the following changes to the **install-config.yaml** file.

```
platform:
  baremetal:
    apiVIP: <api_VIP>
```

```
ingressVIP: <ingress_VIP>
provisioningNetwork: "Disabled" 1
```

- 1 Add the **provisioningNetwork** configuration setting, if needed, and set it to **Disabled**.



### IMPORTANT

The **provisioning** network is required for PXE booting. If you deploy without a **provisioning** network, you must use a virtual media BMC addressing option such as **redfish-virtualmedia** or **idrac-virtualmedia**. See "Redfish virtual media for HPE iLO" in the "BMC addressing for HPE iLO" section or "Redfish virtual media for Dell iDRAC" in the "BMC addressing for Dell iDRAC" section for additional details.

#### 13.3.7.10. (Optional) Deploying with dual-stack networking

To deploy an OpenShift Container Platform cluster with dual-stack networking, edit the **machineNetwork**, **clusterNetwork**, and **serviceNetwork** configuration settings in the **install-config.yaml** file. Each setting must have two CIDR entries each. Ensure the first CIDR entry is the IPv4 setting and the second CIDR entry is the IPv6 setting.

```
machineNetwork:
- cidr: {{ extcidrnet }}
- cidr: {{ extcidrnet6 }}
clusterNetwork:
- cidr: 10.128.0.0/14
  hostPrefix: 23
- cidr: fd02::/48
  hostPrefix: 64
serviceNetwork:
- 172.30.0.0/16
- fd03::/112
```



### IMPORTANT

The API VIP IP address and the Ingress VIP address must be of the primary IP address family when using dual-stack networking. Currently, Red Hat does not support dual-stack VIPs or dual-stack networking with IPv6 as the primary IP address family. However, Red Hat does support dual-stack networking with IPv4 as the primary IP address family. Therefore, the IPv4 entries must go **before** the IPv6 entries.

#### 13.3.7.11. (Optional) Configuring host network interfaces

Before installation, you can set the **networkConfig** configuration setting in the **install-config.yaml** file to configure host network interfaces using NMState.

The most common use case for this functionality is to specify a static IP address on the bare-metal network, but you can also configure other networks such as a storage network. This functionality supports other NMState features such as VLAN, VXLAN, bridges, bonds, routes, MTU, and DNS resolver settings.

#### Prerequisites

- Configure a **PTR** DNS record with a valid hostname for each node with a static IP address.

- Install the NMState CLI (**nmstate**).

## Procedure

1. Optional: Consider testing the NMState syntax with **nmstatectl gc** before including it in the **install-config.yaml** file, because the installer will not check the NMState YAML syntax.



### NOTE

Errors in the YAML syntax might result in a failure to apply the network configuration. Additionally, maintaining the validated YAML syntax is useful when applying changes using Kubernetes NMState after deployment or when expanding the cluster.

- a. Create an NMState YAML file:

```

interfaces:
- name: <nic1_name> 1
  type: ethernet
  state: up
  ipv4:
    address:
      - ip: <ip_address> 2
        prefix-length: 24
    enabled: true
  dns-resolver:
    config:
      server:
        - <dns_ip_address> 3
  routes:
    config:
      - destination: 0.0.0.0/0
        next-hop-address: <next_hop_ip_address> 4
        next-hop-interface: <next_hop_nic1_name> 5

```

- 1 2 3 4 5 Replace **<nic1\_name>**, **<ip\_address>**, **<dns\_ip\_address>**, **<next\_hop\_ip\_address>** and **<next\_hop\_nic1\_name>** with appropriate values.

- b. Test the configuration file by running the following command:

```
$ nmstatectl gc <nmstate_yaml_file>
```

Replace **<nmstate\_yaml\_file>** with the configuration file name.

2. Use the **networkConfig** configuration setting by adding the NMState configuration to hosts within the **install-config.yaml** file:

```

hosts:
- name: openshift-master-0
  role: master
  bmc:
    address: redfish+http://<out_of_band_ip>/redfish/v1/Systems/

```

```

username: <user>
password: <password>
disableCertificateVerification: null
bootMACAddress: <NIC1_mac_address>
bootMode: UEFI
rootDeviceHints:
  deviceName: "/dev/sda"
networkConfig: ❶
  interfaces:
    - name: <nic1_name> ❷
      type: ethernet
      state: up
      ipv4:
        address:
          - ip: <ip_address> ❸
            prefix-length: 24
          enabled: true
      dns-resolver:
        config:
          server:
            - <dns_ip_address> ❹
      routes:
        config:
          - destination: 0.0.0.0/0
            next-hop-address: <next_hop_ip_address> ❺
            next-hop-interface: <next_hop_nic1_name> ❻

```

❶ Add the NMState YAML syntax to configure the host interfaces.

❷ ❸ ❹ ❺ ❻ Replace `<nic1_name>`, `<ip_address>`, `<dns_ip_address>`, `<next_hop_ip_address>` and `<next_hop_nic1_name>` with appropriate values.



### IMPORTANT

After deploying the cluster, you cannot modify the **networkConfig** configuration setting of **install-config.yaml** file to make changes to the host network interface. Use the Kubernetes NMState Operator to make changes to the host network interface after deployment.

#### Additional resources

- See [the NMState documentation](#) for additional examples of NMState syntax.
- [OpenShift Container Platform 4.10 release notes](#)

#### 13.3.7.12. Configuring host network interfaces for subnets

For edge computing scenarios, it can be beneficial to locate worker nodes closer to the edge. To locate remote worker nodes in subnets, you might use different network segments or subnets for the remote worker nodes than you used for the control plane subnet and local worker nodes. You can reduce latency for the edge and allow for enhanced scalability by setting up subnets for edge computing scenarios.

If you have established different network segments or subnets for remote worker nodes as described in the section on "Establishing communication between subnets", you must specify the subnets in the

**machineNetwork** configuration setting if the workers are using static IP addresses, bonds or other advanced networking. When setting the node IP address in the **networkConfig** parameter for each remote worker node, you must also specify the gateway and the DNS server for the subnet containing the control plane nodes when using static IP addresses. This ensures the remote worker nodes can reach the subnet containing the control plane nodes and that they can receive network traffic from the control plane.

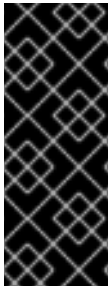

## IMPORTANT

All control plane nodes must run in the same subnet. When using more than one subnet, you can also configure the Ingress VIP to run on the control plane nodes by using a manifest. See "Configuring network components to run on the control plane" for details.

Deploying a cluster with multiple subnets requires using virtual media, such as **redfish-virtualmedia** and **idrac-virtualmedia**.

## Procedure

1. Add the subnets to the **machineNetwork** in the **install-config.yaml** file when using static IP addresses:

```
networking:
  machineNetwork:
    - cidr: 10.0.0.0/24
    - cidr: 192.168.0.0/24
  networkType: OVNKubernetes
```

2. Add the gateway and DNS configuration to the **networkConfig** parameter of each edge worker node using NMState syntax when using a static IP address or advanced networking such as bonds:

```
networkConfig:
  nmstate:
    interfaces:
      - name: <interface_name> 1
        type: ethernet
        state: up
        ipv4:
          enabled: true
          dhcp: false
          address:
            - ip: <node_ip> 2
              prefix-length: 24
          gateway: <gateway_ip> 3
        dns-resolver:
          config:
            server:
              - <dns_ip> 4
```

- 1 Replace **<interface\_name>** with the interface name.
- 2 Replace **<node\_ip>** with the IP address of the node.
- 3 Replace **<gateway\_ip>** with the IP address of the gateway.



- 4 Replace `<dns_ip>` with the IP address of the DNS server.

### 13.3.7.13. Configuring multiple cluster nodes

You can simultaneously configure OpenShift Container Platform cluster nodes with identical settings. Configuring multiple cluster nodes avoids adding redundant information for each node to the **install-config.yaml** file. This file contains specific parameters to apply an identical configuration to multiple nodes in the cluster.

Compute nodes are configured separately from the controller node. However, configurations for both node types use the highlighted parameters in the **install-config.yaml** file to enable multi-node configuration. Set the **networkConfig** parameters to **BOND**, as shown in the following example:

```
hosts:
- name: otest-master-0
  [...]
  networkConfig: &BOND
  interfaces:
  - name: bond0
    type: bond
    state: up
    ipv4:
      dhcp: true
      enabled: true
    link-aggregation:
      mode: active-backup
      port:
      - enp2s0
      - enp3s0
- name: otest-master-1
  [...]
  networkConfig: *BOND
- name: otest-master-2
  [...]
  networkConfig: *BOND
```



#### NOTE

Configuration of multiple cluster nodes is only available for initial deployments on installer-provisioned infrastructure.

### 13.3.7.14. (Optional) Configuring managed Secure Boot

You can enable managed Secure Boot when deploying an installer-provisioned cluster using Redfish BMC addressing, such as **redfish**, **redfish-virtualmedia**, or **idrac-virtualmedia**. To enable managed Secure Boot, add the **bootMode** configuration setting to each node:

#### Example

```
hosts:
- name: openshift-master-0
  role: master
  bmc:
```

```

address: redfish://<out_of_band_ip> 1
username: <username>
password: <password>
bootMACAddress: <NIC1_mac_address>
rootDeviceHints:
  deviceName: "/dev/sda"
bootMode: UEFISecureBoot 2

```

- 1** Ensure the **bmc.address** setting uses **redfish**, **redfish-virtualmedia**, or **idrac-virtualmedia** as the protocol. See "BMC addressing for HPE iLO" or "BMC addressing for Dell iDRAC" for additional details.
- 2** The **bootMode** setting is **UEFI** by default. Change it to **UEFISecureBoot** to enable managed Secure Boot.



#### NOTE

See "Configuring nodes" in the "Prerequisites" to ensure the nodes can support managed Secure Boot. If the nodes do not support managed Secure Boot, see "Configuring nodes for Secure Boot manually" in the "Configuring nodes" section. Configuring Secure Boot manually requires Redfish virtual media.



#### NOTE

Red Hat does not support Secure Boot with IPMI, because IPMI does not provide Secure Boot management facilities.

### 13.3.8. Manifest configuration files

#### 13.3.8.1. Creating the OpenShift Container Platform manifests

1. Create the OpenShift Container Platform manifests.

```
$ ./openshift-baremetal-install --dir ~/clusterconfigs create manifests
```

```

INFO Consuming Install Config from target directory
WARNING Making control-plane schedulable by setting MastersSchedulable to true for
Scheduler cluster settings
WARNING Discarding the OpenShift Manifest that was provided in the target directory
because its dependencies are dirty and it needs to be regenerated

```

#### 13.3.8.2. (Optional) Configuring NTP for disconnected clusters

OpenShift Container Platform installs the **chrony** Network Time Protocol (NTP) service on the cluster nodes.

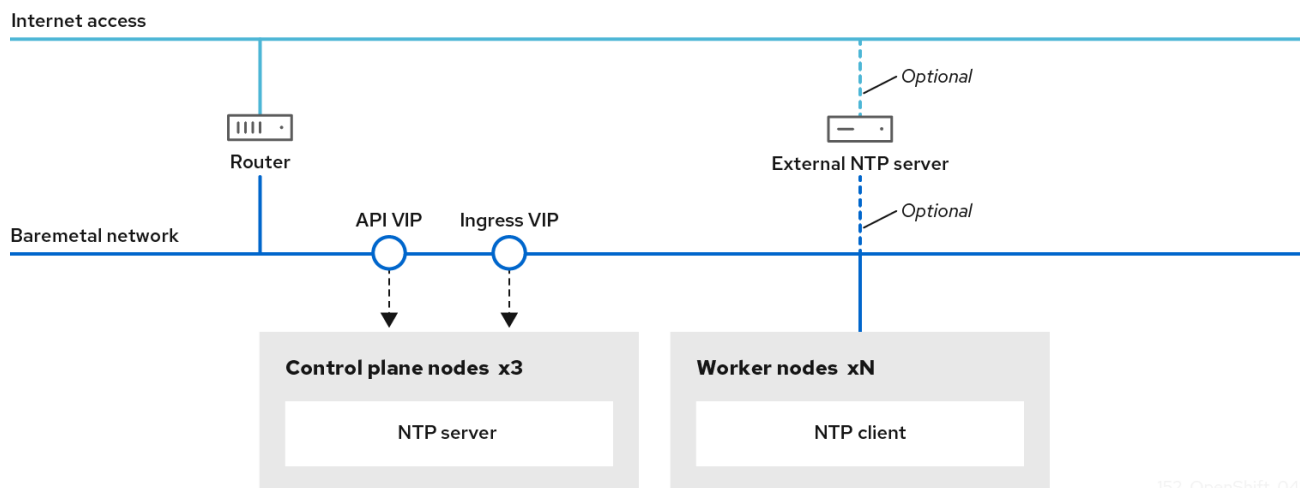

152\_OpenShift\_0421

OpenShift Container Platform nodes must agree on a date and time to run properly. When worker nodes retrieve the date and time from the NTP servers on the control plane nodes, it enables the installation and operation of clusters that are not connected to a routable network and thereby do not have access to a higher stratum NTP server.

## Procedure

1. Create a Butane config, **99-master-chrony-conf-override.bu**, including the contents of the **chrony.conf** file for the control plane nodes.



### NOTE

See "Creating machine configs with Butane" for information about Butane.

## Butane config example

```
variant: openshift
version: 4.10.0
metadata:
  name: 99-master-chrony-conf-override
  labels:
    machineconfiguration.openshift.io/role: master
storage:
files:
  - path: /etc/chrony.conf
    mode: 0644
    overwrite: true
  contents:
    inline: |
      # Use public servers from the pool.ntp.org project.
      # Please consider joining the pool (https://www.pool.ntp.org/join.html).

      # The Machine Config Operator manages this file
      server openshift-master-0.<cluster-name>.<domain> iburst 1
      server openshift-master-1.<cluster-name>.<domain> iburst
      server openshift-master-2.<cluster-name>.<domain> iburst

stratumweight 0
```

```

driftfile /var/lib/chrony/drift
rtcsync
makestep 10 3
bindcmdaddress 127.0.0.1
bindcmdaddress ::1
keyfile /etc/chrony.keys
commandkey 1
generatecommandkey
noclientlog
logchange 0.5
logdir /var/log/chrony

# Configure the control plane nodes to serve as local NTP servers
# for all worker nodes, even if they are not in sync with an
# upstream NTP server.

# Allow NTP client access from the local network.
allow all
# Serve time even if not synchronized to a time source.
local stratum 3 orphan

```

- 1 You must replace **<cluster-name>** with the name of the cluster and replace **<domain>** with the fully qualified domain name.
2. Use Butane to generate a **MachineConfig** object file, **99-master-chrony-conf-override.yaml**, containing the configuration to be delivered to the control plane nodes:

```
$ butane 99-master-chrony-conf-override.bu -o 99-master-chrony-conf-override.yaml
```

3. Create a Butane config, **99-worker-chrony-conf-override.bu**, including the contents of the **chrony.conf** file for the worker nodes that references the NTP servers on the control plane nodes.

### Butane config example

```

variant: openshift
version: 4.10.0
metadata:
  name: 99-worker-chrony-conf-override
  labels:
    machineconfiguration.openshift.io/role: worker
storage:
  files:
    - path: /etc/chrony.conf
      mode: 0644
      overwrite: true
      contents:
        inline: |
          # The Machine Config Operator manages this file.
          server openshift-master-0.<cluster-name>.<domain> iburst 1
          server openshift-master-1.<cluster-name>.<domain> iburst
          server openshift-master-2.<cluster-name>.<domain> iburst

          stratumweight 0

```

```
driftfile /var/lib/chrony/drift
rtcsync
makestep 10 3
bindcmdaddress 127.0.0.1
bindcmdaddress ::1
keyfile /etc/chrony.keys
commandkey 1
generatecommandkey
noclientlog
logchange 0.5
logdir /var/log/chrony
```

- 1 You must replace **<cluster-name>** with the name of the cluster and replace **<domain>** with the fully qualified domain name.

4. Use Butane to generate a **MachineConfig** object file, **99-worker-chrony-conf-override.yaml**, containing the configuration to be delivered to the worker nodes:

```
$ butane 99-worker-chrony-conf-override.bu -o 99-worker-chrony-conf-override.yaml
```

### 13.3.8.3. (Optional) Configuring network components to run on the control plane

You can configure networking components to run exclusively on the control plane nodes. By default, OpenShift Container Platform allows any node in the machine config pool to host the **ingressVIP** virtual IP address. However, some environments deploy worker nodes in separate subnets from the control plane nodes. When deploying remote workers in separate subnets, you must place the **ingressVIP** virtual IP address exclusively with the control plane nodes.

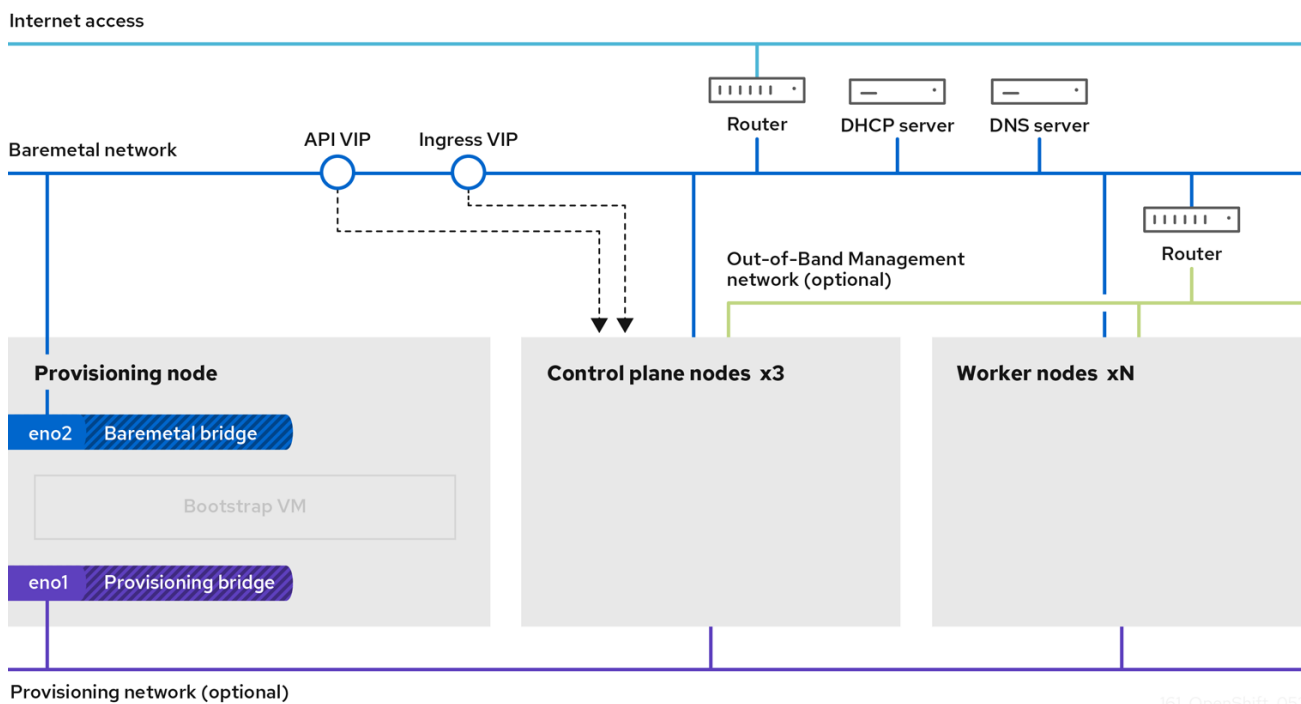

161\_OpenShift\_0521

### Procedure

1. Change to the directory storing the **install-config.yaml** file:

```
$ cd ~/clusterconfigs
```

2. Switch to the **manifests** subdirectory:

```
$ cd manifests
```

3. Create a file named **cluster-network-avoid-workers-99-config.yaml**:

```
$ touch cluster-network-avoid-workers-99-config.yaml
```

4. Open the **cluster-network-avoid-workers-99-config.yaml** file in an editor and enter a custom resource (CR) that describes the Operator configuration:

```
apiVersion: machineconfiguration.openshift.io/v1
kind: MachineConfig
metadata:
  name: 50-worker-fix-ipi-rwn
  labels:
    machineconfiguration.openshift.io/role: worker
spec:
  config:
    ignition:
      version: 3.2.0
    storage:
      files:
        - path: /etc/kubernetes/manifests/keepalived.yaml
          mode: 0644
          contents:
            source: data;
```

This manifest places the **ingressVIP** virtual IP address on the control plane nodes. Additionally, this manifest deploys the following processes on the control plane nodes only:

- **openshift-ingress-operator**
- **keepalived**

5. Save the **cluster-network-avoid-workers-99-config.yaml** file.
6. Create a **manifests/cluster-ingress-default-ingresscontroller.yaml** file:

```
apiVersion: operator.openshift.io/v1
kind: IngressController
metadata:
  name: default
  namespace: openshift-ingress-operator
spec:
  nodePlacement:
    nodeSelector:
      matchLabels:
        node-role.kubernetes.io/master: ""
```

7. Consider backing up the **manifests** directory. The installer deletes the **manifests/** directory when creating the cluster.

- Modify the **cluster-scheduler-02-config.yml** manifest to make the control plane nodes schedulable by setting the **mastersSchedulable** field to **true**. Control plane nodes are not schedulable by default. For example:

```
$ sed -i "s;mastersSchedulable: false;mastersSchedulable: true;g"
clusterconfigs/manifests/cluster-scheduler-02-config.yml
```



#### NOTE

If control plane nodes are not schedulable after completing this procedure, deploying the cluster will fail.

#### 13.3.8.4. (Optional) Deploying routers on worker nodes

During installation, the installer deploys router pods on worker nodes. By default, the installer installs two router pods. If a deployed cluster requires additional routers to handle external traffic loads destined for services within the OpenShift Container Platform cluster, you can create a **yaml** file to set an appropriate number of router replicas.



#### IMPORTANT

Deploying a cluster with only one worker node is not supported. While modifying the router replicas will address issues with the **degraded** state when deploying with one worker, the cluster loses high availability for the ingress API, which is not suitable for production environments.



#### NOTE

By default, the installer deploys two routers. If the cluster has no worker nodes, the installer deploys the two routers on the control plane nodes by default.

#### Procedure

- Create a **router-replicas.yaml** file:

```
apiVersion: operator.openshift.io/v1
kind: IngressController
metadata:
  name: default
  namespace: openshift-ingress-operator
spec:
  replicas: <num-of-router-pods>
  endpointPublishingStrategy:
    type: HostNetwork
  nodePlacement:
    nodeSelector:
      matchLabels:
        node-role.kubernetes.io/worker: ""
```

**NOTE**

Replace **<num-of-router-pods>** with an appropriate value. If working with just one worker node, set **replicas:** to **1**. If working with more than 3 worker nodes, you can increase **replicas:** from the default value **2** as appropriate.

2. Save and copy the **router-replicas.yaml** file to the **clusterconfigs/openshift** directory:

```
$ cp ~/router-replicas.yaml clusterconfigs/openshift/99_router-replicas.yaml
```

### 13.3.8.5. (Optional) Configuring the BIOS for worker nodes

The following procedure configures the BIOS for a worker node during the installation process.

#### Procedure

1. Create the manifests.
2. Modify the BMH file corresponding to the worker:

```
$ vim clusterconfigs/openshift/99_openshift-cluster-api_hosts-3.yaml
```

3. Add the BIOS configuration to the **spec** section of the BMH file:

```
spec:
  firmware:
    simultaneousMultithreadingEnabled: true
    sriovEnabled: true
    virtualizationEnabled: true
```

**NOTE**

1. Red Hat supports three BIOS configurations. See the [BMH documentation](#) for details. Only servers with BMC type **irmc** are supported. Other types of servers are currently not supported.

4. Create the cluster.

#### Additional resources

- [Bare metal configuration](#)

### 13.3.8.6. (Optional) Configuring RAID for worker nodes

The following procedure configures a redundant array of independent disks (RAID) for the worker node during the installation process.





## NOTE

1. OpenShift Container Platform supports hardware RAID for baseboard management controllers (BMCs) using the iRMC protocol only. OpenShift Container Platform 4.10 does not support software RAID.
2. If you want to configure a hardware RAID for the node, verify that the node has a RAID controller.

## Procedure

1. Create the manifests.
2. Modify the BMH (Bare Metal Host) file corresponding to the worker:

```
$ vim clusterconfigs/openshift/99_openshift-cluster-api_hosts-3.yaml
```



## NOTE

The following example uses a hardware RAID configuration because OpenShift Container Platform 4.10 does not support software RAID.

- a. If you added a specific RAID configuration to the **spec** section, this causes the worker node to delete the original RAID configuration in the **preparing** phase and perform a specified configuration on the RAID. For example:

```
spec:
  raid:
    hardwareRAIDVolumes:
      - level: "0" 1
        name: "sda"
        numberOfPhysicalDisks: 1
        rotational: true
        sizeGibibytes: 0
```

- 1** **level** is a required field, and the others are optional fields.

- b. If you added an empty RAID configuration to the **spec** section, this empty configuration causes the worker node to delete the original RAID configuration during the **preparing** phase, but does not perform a new configuration. For example:

```
spec:
  raid:
    hardwareRAIDVolumes: []
```

- c. If you do not add a **raid** field in the **spec** section, the original RAID configuration is not deleted, and no new configuration will be performed.
3. Create the cluster.

## Additional resources

- [Bare metal configuration](#)

### 13.3.9. Creating a disconnected registry

In some cases, you might want to install an OpenShift Container Platform cluster using a local copy of the installation registry. This could be for enhancing network efficiency because the cluster nodes are on a network that does not have access to the internet.

A local, or mirrored, copy of the registry requires the following:

- A certificate for the registry node. This can be a self-signed certificate.
- A web server that a container on a system will serve.
- An updated pull secret that contains the certificate and local repository information.



#### NOTE

Creating a disconnected registry on a registry node is optional. If you need to create a disconnected registry on a registry node, you must complete all of the following sub-sections.

#### Prerequisites

- If you have already prepared a mirror registry for [Mirroring images for a disconnected installation](#), you can skip directly to [Modify the install-config.yaml file to use the disconnected registry](#).

#### 13.3.9.1. Preparing the registry node to host the mirrored registry

The following steps must be completed prior to hosting a mirrored registry on bare metal.

#### Procedure

1. Open the firewall port on the registry node:

```
$ sudo firewall-cmd --add-port=5000/tcp --zone=libvirt --permanent
```

```
$ sudo firewall-cmd --add-port=5000/tcp --zone=public --permanent
```

```
$ sudo firewall-cmd --reload
```

2. Install the required packages for the registry node:

```
$ sudo yum -y install python3 podman httpd httpd-tools jq
```

3. Create the directory structure where the repository information will be held:

```
$ sudo mkdir -p /opt/registry/{auth,certs,data}
```

#### 13.3.9.2. Mirroring the OpenShift Container Platform image repository for a disconnected registry

Complete the following steps to mirror the OpenShift Container Platform image repository for a disconnected registry.

## Prerequisites

- Your mirror host has access to the internet.
- You configured a mirror registry to use in your restricted network and can access the certificate and credentials that you configured.
- You downloaded the [pull secret from the Red Hat OpenShift Cluster Manager](#) and modified it to include authentication to your mirror repository.

## Procedure

1. Review the [OpenShift Container Platform downloads page](#) to determine the version of OpenShift Container Platform that you want to install and determine the corresponding tag on the [Repository Tags](#) page.
2. Set the required environment variables:

- a. Export the release version:

```
$ OCP_RELEASE=<release_version>
```

For **<release\_version>**, specify the tag that corresponds to the version of OpenShift Container Platform to install, such as **4.5.4**.

- b. Export the local registry name and host port:

```
$ LOCAL_REGISTRY='<local_registry_host_name>:<local_registry_host_port>'
```

For **<local\_registry\_host\_name>**, specify the registry domain name for your mirror repository, and for **<local\_registry\_host\_port>**, specify the port that it serves content on.

- c. Export the local repository name:

```
$ LOCAL_REPOSITORY='<local_repository_name>'
```

For **<local\_repository\_name>**, specify the name of the repository to create in your registry, such as **ocp4/openshift4**.

- d. Export the name of the repository to mirror:

```
$ PRODUCT_REPO='openshift-release-dev'
```

For a production release, you must specify **openshift-release-dev**.

- e. Export the path to your registry pull secret:

```
$ LOCAL_SECRET_JSON='<path_to_pull_secret>'
```

For **<path\_to\_pull\_secret>**, specify the absolute path to and file name of the pull secret for your mirror registry that you created.

- f. Export the release mirror:

```
$ RELEASE_NAME="ocp-release"
```

For a production release, you must specify **ocp-release**.

- g. Export the type of architecture for your server, such as **x86\_64**:

```
$ ARCHITECTURE=<server_architecture>
```

- h. Export the path to the directory to host the mirrored images:

```
$ REMOVABLE_MEDIA_PATH=<path> 1
```

- 1** Specify the full path, including the initial forward slash (/) character.

3. Mirror the version images to the mirror registry:

- If your mirror host does not have internet access, take the following actions:
  - i. Connect the removable media to a system that is connected to the internet.
  - ii. Review the images and configuration manifests to mirror:

```
$ oc adm release mirror -a ${LOCAL_SECRET_JSON} \
  --from=quay.io/${PRODUCT_REPO}/${RELEASE_NAME}:${OCP_RELEASE}-
  ${ARCHITECTURE} \
  --to=${LOCAL_REGISTRY}/${LOCAL_REPOSITORY} \
  --to-release-
  image=${LOCAL_REGISTRY}/${LOCAL_REPOSITORY}:${OCP_RELEASE}-
  ${ARCHITECTURE} --dry-run
```

- iii. Record the entire **imageContentSources** section from the output of the previous command. The information about your mirrors is unique to your mirrored repository, and you must add the **imageContentSources** section to the **install-config.yaml** file during installation.
- iv. Mirror the images to a directory on the removable media:

```
$ oc adm release mirror -a ${LOCAL_SECRET_JSON} --to-
  dir=${REMOVABLE_MEDIA_PATH}/mirror
  quay.io/${PRODUCT_REPO}/${RELEASE_NAME}:${OCP_RELEASE}-
  ${ARCHITECTURE}
```

- v. Take the media to the restricted network environment and upload the images to the local container registry.

```
$ oc image mirror -a ${LOCAL_SECRET_JSON} --from-
  dir=${REMOVABLE_MEDIA_PATH}/mirror
  "file://openshift/release:${OCP_RELEASE}*"
  ${LOCAL_REGISTRY}/${LOCAL_REPOSITORY} 1
```

- 1** For **REMOVABLE\_MEDIA\_PATH**, you must use the same path that you specified when you mirrored the images.

- If the local container registry is connected to the mirror host, take the following actions:

- i. Directly push the release images to the local registry by using following command:

```
$ oc adm release mirror -a ${LOCAL_SECRET_JSON} \
  --from=quay.io/${PRODUCT_REPO}/${RELEASE_NAME}:${OCP_RELEASE}-
  ${ARCHITECTURE} \
  --to=${LOCAL_REGISTRY}/${LOCAL_REPOSITORY} \
  --to-release-
  image=${LOCAL_REGISTRY}/${LOCAL_REPOSITORY}:${OCP_RELEASE}-
  ${ARCHITECTURE}
```

This command pulls the release information as a digest, and its output includes the **imageContentSources** data that you require when you install your cluster.

- ii. Record the entire **imageContentSources** section from the output of the previous command. The information about your mirrors is unique to your mirrored repository, and you must add the **imageContentSources** section to the **install-config.yaml** file during installation.



#### NOTE

The image name gets patched to Quay.io during the mirroring process, and the podman images will show Quay.io in the registry on the bootstrap virtual machine.

4. To create the installation program that is based on the content that you mirrored, extract it and pin it to the release:

- If your mirror host does not have internet access, run the following command:

```
$ oc adm release extract -a ${LOCAL_SECRET_JSON} --command=openshift-install
"${LOCAL_REGISTRY}/${LOCAL_REPOSITORY}:${OCP_RELEASE}"
```

- If the local container registry is connected to the mirror host, run the following command:

```
$ oc adm release extract -a ${LOCAL_SECRET_JSON} --command=openshift-install
"${LOCAL_REGISTRY}/${LOCAL_REPOSITORY}:${OCP_RELEASE}-
${ARCHITECTURE}"
```



#### IMPORTANT

To ensure that you use the correct images for the version of OpenShift Container Platform that you selected, you must extract the installation program from the mirrored content.

You must perform this step on a machine with an active internet connection.

If you are in a disconnected environment, use the **--image** flag as part of **must-gather** and point to the payload image.

5. For clusters using installer-provisioned infrastructure, run the following command:

```
$ openshift-install
```

### 13.3.9.3. Modify the `install-config.yaml` file to use the disconnected registry

On the provisioner node, the `install-config.yaml` file should use the newly created pull-secret from the `pull-secret-update.txt` file. The `install-config.yaml` file must also contain the disconnected registry node's certificate and registry information.

#### Procedure

1. Add the disconnected registry node's certificate to the `install-config.yaml` file:

```
$ echo "additionalTrustBundle: |" >> install-config.yaml
```

The certificate should follow the `"additionalTrustBundle: |"` line and be properly indented, usually by two spaces.

```
$ sed -e 's/^/ /' /opt/registry/certs/domain.crt >> install-config.yaml
```

2. Add the mirror information for the registry to the `install-config.yaml` file:

```
$ echo "imageContentSources:" >> install-config.yaml
```

```
$ echo "- mirrors:" >> install-config.yaml
```

```
$ echo "  - registry.example.com:5000/ocp4/openshift4" >> install-config.yaml
```

Replace `registry.example.com` with the registry's fully qualified domain name.

```
$ echo "  source: quay.io/openshift-release-dev/ocp-release" >> install-config.yaml
```

```
$ echo "- mirrors:" >> install-config.yaml
```

```
$ echo "  - registry.example.com:5000/ocp4/openshift4" >> install-config.yaml
```

Replace `registry.example.com` with the registry's fully qualified domain name.

```
$ echo "  source: quay.io/openshift-release-dev/ocp-v4.0-art-dev" >> install-config.yaml
```

### 13.3.10. Assigning a static IP address to the bootstrap VM

If you are deploying OpenShift Container Platform without a DHCP server on the `baremetal` network, you must configure a static IP address for the bootstrap VM using Ignition.

#### Procedure

1. Create the ignition configuration files:

```
$ ./openshift-baremetal-install --dir <cluster_configs> create ignition-configs
```

Replace `<cluster_configs>` with the path to your cluster configuration files.

2. Create the `bootstrap_config.sh` file:

```
#!/bin/bash

BOOTSTRAP_CONFIG="[connection]
type=ethernet
interface-name=ens3
[ethernet]
[ipv4]
method=manual
addresses=<ip_address>/<cidr>
gateway=<gateway_ip_address>
dns=<dns_ip_address>"

cat <<_EOF_> bootstrap_network_config.ign
{
  "path": "/etc/NetworkManager/system-connections/ens3.nmconnection",
  "mode": 384,
  "contents": {
    "source": "data:text/plain;charset=utf-8;base64,$(echo "${BOOTSTRAP_CONFIG}" |
base64 -w 0)"
  }
}
_EOF_

mv <cluster_configs>/bootstrap.ign <cluster_configs>/bootstrap.ign.orig

jq '.storage.files += $input' <cluster_configs>/bootstrap.ign.orig --slurpfile input
bootstrap_network_config.ign > <cluster_configs>/bootstrap.ign
```

Replace **<ip\_address>** and **<cidr>** with the IP address and CIDR of the address range. Replace **<gateway\_ip\_address>** with the IP address of the gateway on the **baremetal** network. Replace **<dns\_ip\_address>** with the IP address of the DNS server on the **baremetal** network. Replace **<cluster\_configs>** with the path to your cluster configuration files.

3. Make the **bootstrap\_config.sh** file executable:

```
$ chmod 755 bootstrap_config.sh
```

4. Run the **bootstrap\_config.sh** script to create the **bootstrap\_network\_config.ign** file:

```
$ ./bootstrap_config.sh
```

### 13.3.11. Validation checklist for installation

- OpenShift Container Platform installer has been retrieved.
- OpenShift Container Platform installer has been extracted.
- Required parameters for the **install-config.yaml** have been configured.
- The **hosts** parameter for the **install-config.yaml** has been configured.
- The **bmc** parameter for the **install-config.yaml** has been configured.
- Conventions for the values configured in the **bmc address** field have been applied.

- Created the OpenShift Container Platform manifests.
- (Optional) Deployed routers on worker nodes.
- (Optional) Created a disconnected registry.
- (Optional) Validate disconnected registry settings if in use.

### 13.3.12. Deploying the cluster via the OpenShift Container Platform installer

Run the OpenShift Container Platform installer:

```
$. /openshift-baremetal-install --dir ~/clusterconfigs --log-level debug create cluster
```

### 13.3.13. Following the installation

During the deployment process, you can check the installation's overall status by issuing the **tail** command to the **.openshift\_install.log** log file in the install directory folder:

```
$. tail -f /path/to/install-dir/.openshift_install.log
```

### 13.3.14. Verifying static IP address configuration

If the DHCP reservation for a cluster node specifies an infinite lease, after the installer successfully provisions the node, the dispatcher script checks the node's network configuration. If the script determines that the network configuration contains an infinite DHCP lease, it creates a new connection using the IP address of the DHCP lease as a static IP address.



#### NOTE

The dispatcher script might run on successfully provisioned nodes while the provisioning of other nodes in the cluster is ongoing.

Verify the network configuration is working properly.

#### Procedure

1. Check the network interface configuration on the node.
2. Turn off the DHCP server and reboot the OpenShift Container Platform node and ensure that the network configuration works properly.

### 13.3.15. Additional resources

- [Creating the Kubernetes manifest and Ignition config files](#)
- [Understanding update channels and releases](#)

## 13.4. INSTALLER-PROVISIONED POST-INSTALLATION CONFIGURATION



After successfully deploying an installer-provisioned cluster, consider the following post-installation procedures.

### 13.4.1. (Optional) Configuring NTP for disconnected clusters

OpenShift Container Platform installs the **chrony** Network Time Protocol (NTP) service on the cluster nodes. Use the following procedure to configure NTP servers on the control plane nodes and configure worker nodes as NTP clients of the control plane nodes after a successful deployment.

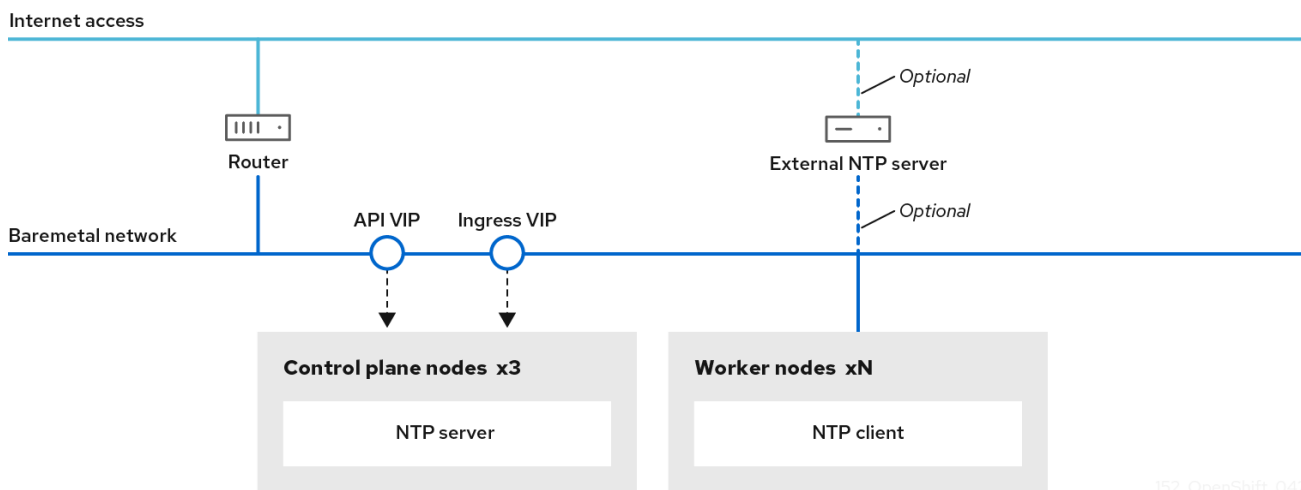

152\_OpenShift\_0421

OpenShift Container Platform nodes must agree on a date and time to run properly. When worker nodes retrieve the date and time from the NTP servers on the control plane nodes, it enables the installation and operation of clusters that are not connected to a routable network and thereby do not have access to a higher stratum NTP server.

#### Procedure

1. Create a Butane config, **99-master-chrony-conf-override.bu**, including the contents of the **chrony.conf** file for the control plane nodes.

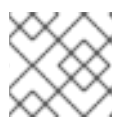

#### NOTE

See "Creating machine configs with Butane" for information about Butane.

#### Butane config example

```
variant: openshift
version: 4.10.0
metadata:
  name: 99-master-chrony-conf-override
  labels:
    machineconfiguration.openshift.io/role: master
storage:
  files:
    - path: /etc/chrony.conf
      mode: 0644
      overwrite: true
      contents:
        inline: |
```

```

# Use public servers from the pool.ntp.org project.
# Please consider joining the pool (https://www.pool.ntp.org/join.html).

# The Machine Config Operator manages this file
server openshift-master-0.<cluster-name>.<domain> iburst 1
server openshift-master-1.<cluster-name>.<domain> iburst
server openshift-master-2.<cluster-name>.<domain> iburst

stratumweight 0
driftfile /var/lib/chrony/drift
rtcsync
makestep 10 3
bindcmdaddress 127.0.0.1
bindcmdaddress ::1
keyfile /etc/chrony.keys
commandkey 1
generatecommandkey
noclientlog
logchange 0.5
logdir /var/log/chrony

# Configure the control plane nodes to serve as local NTP servers
# for all worker nodes, even if they are not in sync with an
# upstream NTP server.

# Allow NTP client access from the local network.
allow all
# Serve time even if not synchronized to a time source.
local stratum 3 orphan

```

1 You must replace **<cluster-name>** with the name of the cluster and replace **<domain>** with the fully qualified domain name.

2. Use Butane to generate a **MachineConfig** object file, **99-master-chrony-conf-override.yaml**, containing the configuration to be delivered to the control plane nodes:

```
$ butane 99-master-chrony-conf-override.bu -o 99-master-chrony-conf-override.yaml
```

3. Create a Butane config, **99-worker-chrony-conf-override.bu**, including the contents of the **chrony.conf** file for the worker nodes that references the NTP servers on the control plane nodes.

### Butane config example

```

variant: openshift
version: 4.10.0
metadata:
  name: 99-worker-chrony-conf-override
labels:
  machineconfiguration.openshift.io/role: worker
storage:
  files:
    - path: /etc/chrony.conf
      mode: 0644

```

```

overwrite: true
contents:
  inline: |
    # The Machine Config Operator manages this file.
    server openshift-master-0.<cluster-name>.<domain> iburst 1
    server openshift-master-1.<cluster-name>.<domain> iburst
    server openshift-master-2.<cluster-name>.<domain> iburst

    stratumweight 0
    driftfile /var/lib/chrony/drift
    rtcsync
    makestep 10 3
    bindcmdaddress 127.0.0.1
    bindcmdaddress ::1
    keyfile /etc/chrony.keys
    commandkey 1
    generatecommandkey
    noclientlog
    logchange 0.5
    logdir /var/log/chrony

```

- 1 You must replace **<cluster-name>** with the name of the cluster and replace **<domain>** with the fully qualified domain name.

4. Use Butane to generate a **MachineConfig** object file, **99-worker-chrony-conf-override.yaml**, containing the configuration to be delivered to the worker nodes:

```
$ butane 99-worker-chrony-conf-override.bu -o 99-worker-chrony-conf-override.yaml
```

5. Apply the **99-master-chrony-conf-override.yaml** policy to the control plane nodes.

```
$ oc apply -f 99-master-chrony-conf-override.yaml
```

#### Example output

```
machineconfig.machineconfiguration.openshift.io/99-master-chrony-conf-override created
```

6. Apply the **99-worker-chrony-conf-override.yaml** policy to the worker nodes.

```
$ oc apply -f 99-worker-chrony-conf-override.yaml
```

#### Example output

```
machineconfig.machineconfiguration.openshift.io/99-worker-chrony-conf-override created
```

7. Check the status of the applied NTP settings.

```
$ oc describe machineconfigpool
```

### 13.4.2. Enabling a provisioning network after installation

The assisted installer and installer-provisioned installation for bare metal clusters provide the ability to deploy a cluster without a **provisioning** network. This capability is for scenarios such as proof-of-concept clusters or deploying exclusively with Redfish virtual media when each node's baseboard management controller is routable via the **baremetal** network.

You can enable a **provisioning** network after installation using the Cluster Baremetal Operator (CBO).

## Prerequisites

- A dedicated physical network must exist, connected to all worker and control plane nodes.
- You must isolate the native, untagged physical network.
- The network cannot have a DHCP server when the **provisioningNetwork** configuration setting is set to **Managed**.
- You can omit the **provisioningInterface** setting in OpenShift Container Platform 4.10 to use the **bootMACAddress** configuration setting.

## Procedure

1. When setting the **provisioningInterface** setting, first identify the provisioning interface name for the cluster nodes. For example, **eth0** or **eno1**.
2. Enable the Preboot eXecution Environment (PXE) on the **provisioning** network interface of the cluster nodes.
3. Retrieve the current state of the **provisioning** network and save it to a provisioning custom resource (CR) file:

```
$ oc get provisioning -o yaml > enable-provisioning-nw.yaml
```

4. Modify the provisioning CR file:

```
$ vim ~/enable-provisioning-nw.yaml
```

Scroll down to the **provisioningNetwork** configuration setting and change it from **Disabled** to **Managed**. Then, add the **provisioningIP**, **provisioningNetworkCIDR**, **provisioningDHCPRange**, **provisioningInterface**, and **watchAllNameSpaces** configuration settings after the **provisioningNetwork** setting. Provide appropriate values for each setting.

```
apiVersion: v1
items:
- apiVersion: metal3.io/v1alpha1
  kind: Provisioning
  metadata:
    name: provisioning-configuration
  spec:
    provisioningNetwork: 1
    provisioningIP: 2
    provisioningNetworkCIDR: 3
    provisioningDHCPRange: 4
    provisioningInterface: 5
    watchAllNameSpaces: 6
```

- 1 The **provisioningNetwork** is one of **Managed**, **Unmanaged**, or **Disabled**. When set to **Managed**, Metal3 manages the provisioning network and the CBO deploys the Metal3 pod with a configured DHCP server. When set to **Unmanaged**, the system administrator configures the DHCP server manually.
- 2 The **provisioningIP** is the static IP address that the DHCP server and ironic use to provision the network. This static IP address must be within the **provisioning** subnet, and outside of the DHCP range. If you configure this setting, it must have a valid IP address even if the **provisioning** network is **Disabled**. The static IP address is bound to the metal3 pod. If the metal3 pod fails and moves to another server, the static IP address also moves to the new server.
- 3 The Classless Inter-Domain Routing (CIDR) address. If you configure this setting, it must have a valid CIDR address even if the **provisioning** network is **Disabled**. For example: **192.168.0.1/24**.
- 4 The DHCP range. This setting is only applicable to a **Managed** provisioning network. Omit this configuration setting if the **provisioning** network is **Disabled**. For example: **192.168.0.64, 192.168.0.253**.
- 5 The NIC name for the **provisioning** interface on cluster nodes. The **provisioningInterface** setting is only applicable to **Managed** and **Unmanaged** provisioning networks. Omit the **provisioningInterface** configuration setting if the **provisioning** network is **Disabled**. Omit the **provisioningInterface** configuration setting to use the **bootMACAddress** configuration setting instead.
- 6 Set this setting to **true** if you want metal3 to watch namespaces other than the default **openshift-machine-api** namespace. The default value is **false**.

5. Save the changes to the provisioning CR file.

6. Apply the provisioning CR file to the cluster:

```
$ oc apply -f enable-provisioning-nw.yaml
```

### 13.4.3. Configuring an external load balancer

You can configure an OpenShift Container Platform cluster to use an external load balancer in place of the default load balancer.

#### Prerequisites

- On your load balancer, TCP over ports 6443, 443, and 80 must be available to any users of your system.
- Load balance the API port, 6443, between each of the control plane nodes.
- Load balance the application ports, 443 and 80, between all of the compute nodes.
- On your load balancer, port 22623, which is used to serve ignition startup configurations to nodes, is not exposed outside of the cluster.
- Your load balancer must be able to access every machine in your cluster. Methods to allow this access include:

- Attaching the load balancer to the cluster's machine subnet.
- Attaching floating IP addresses to machines that use the load balancer.

## Procedure

1. Enable access to the cluster from your load balancer on ports 6443, 443, and 80. As an example, note this HAProxy configuration:

### A section of a sample HAProxy configuration

```
...
listen my-cluster-api-6443
  bind 0.0.0.0:6443
  mode tcp
  balance roundrobin
  server my-cluster-master-2 192.0.2.2:6443 check
  server my-cluster-master-0 192.0.2.3:6443 check
  server my-cluster-master-1 192.0.2.1:6443 check
listen my-cluster-apps-443
  bind 0.0.0.0:443
  mode tcp
  balance roundrobin
  server my-cluster-worker-0 192.0.2.6:443 check
  server my-cluster-worker-1 192.0.2.5:443 check
  server my-cluster-worker-2 192.0.2.4:443 check
listen my-cluster-apps-80
  bind 0.0.0.0:80
  mode tcp
  balance roundrobin
  server my-cluster-worker-0 192.0.2.7:80 check
  server my-cluster-worker-1 192.0.2.9:80 check
  server my-cluster-worker-2 192.0.2.8:80 check
```

2. Add records to your DNS server for the cluster API and apps over the load balancer. For example:

```
<load_balancer_ip_address> api.<cluster_name>.<base_domain>
<load_balancer_ip_address> apps.<cluster_name>.<base_domain>
```

3. From a command line, use **curl** to verify that the external load balancer and DNS configuration are operational.
  - a. Verify that the cluster API is accessible:

```
$ curl https://<loadbalancer_ip_address>:6443/version --insecure
```

If the configuration is correct, you receive a JSON object in response:

```
{
  "major": "1",
  "minor": "11+",
  "gitVersion": "v1.11.0+ad103ed",
  "gitCommit": "ad103ed",
  "gitTreeState": "clean",
```

```

    "buildDate": "2019-01-09T06:44:10Z",
    "goVersion": "go1.10.3",
    "compiler": "gc",
    "platform": "linux/amd64"
  }

```

- b. Verify that cluster applications are accessible:

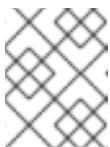

#### NOTE

You can also verify application accessibility by opening the OpenShift Container Platform console in a web browser.

```

$ curl http://console-openshift-console.apps.<cluster_name>.<base_domain> -I -L --insecure

```

If the configuration is correct, you receive an HTTP response:

```

HTTP/1.1 302 Found
content-length: 0
location: https://console-openshift-console.apps.<cluster-name>.<base domain>/
cache-control: no-cacheHTTP/1.1 200 OK
referrer-policy: strict-origin-when-cross-origin
set-cookie: csrf-
token=39HoZgztDnzjJkq/JuLJMeoKNXlfiVv2YgZc09c3TBOBU4NI6kDXaJH1LdicNhN1UsQ
Wzon4Dor9GWGfopaTEQ==; Path=/; Secure
x-content-type-options: nosniff
x-dns-prefetch-control: off
x-frame-options: DENY
x-xss-protection: 1; mode=block
date: Tue, 17 Nov 2020 08:42:10 GMT
content-type: text/html; charset=utf-8
set-cookie:
1e2670d92730b515ce3a1bb65da45062=9b714eb87e93cf34853e87a92d6894be; path=/;
HttpOnly; Secure; SameSite=None
cache-control: private

```

### 13.4.4. Manual migration to new customDeploy install method

A new deployment method introduced in OpenShift Container Platform 4.10 allows you to customize the network configuration (**networkConfig**) in the **install-config.yaml** file by host during the installation and provisioning process. You can also set static IPs per host and additional advanced network configurations.

When you upgrade to version 4.10, OpenShift Container Platform is not automatically upgraded to the new deployment method and you need to perform the following manual steps. Although the functioning of OpenShift Container Platform is not affected, this change is necessary before trying to scale up the cluster.

#### Procedure

1. Log in to **oc** as a user with **cluster-admin** permission.
2. Find out what machineSets exists:

```
$ oc get machinesets -A
```

3. Edit each machineSet:

```
$ oc edit machineset <machineset> -n openshift-machine-api
```

- a. Change to include the following:

```
spec:
  providerSpec:
    value:
      customDeploy:
        method: install_coreos
      image:
        checksum: ""
        url: ""
```



#### NOTE

The change removes the image **checksum/url** and adds the **customDeploy** field.

### 13.4.5. Additional resources

- [Modifying a machine set.](#)

## 13.5. EXPANDING THE CLUSTER

After deploying an installer-provisioned OpenShift Container Platform cluster, you can use the following procedures to expand the number of worker nodes. Ensure that each prospective worker node meets the prerequisites.



#### NOTE

Expanding the cluster using RedFish Virtual Media involves meeting minimum firmware requirements. See **Firmware requirements for installing with virtual media** in the **Prerequisites** section for additional details when expanding the cluster using RedFish Virtual Media.

### 13.5.1. Preparing the bare metal node

To expand your cluster, you must provide the node with the relevant IP address. This can be done with a static configuration, or with a DHCP (Dynamic Host Configuration protocol) server. When expanding the cluster using a DHCP server, each node must have a DHCP reservation.

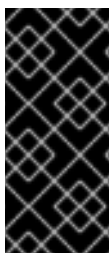

#### RESERVING IP ADDRESSES SO THEY BECOME STATIC IP ADDRESSES

Some administrators prefer to use static IP addresses so that each node's IP address remains constant in the absence of a DHCP server. To configure static IP addresses with NMState, see "Optional: Configuring host network interfaces in the **install-config.yaml** file" in the "Setting up the environment for an OpenShift installation" section for additional details.



Preparing the bare metal node requires executing the following procedure from the provisioner node.

## Procedure

1. Get the **oc** binary:

```
$ curl -s https://mirror.openshift.com/pub/openshift-v4/clients/ocp/$VERSION/openshift-client-linux-$VERSION.tar.gz | tar zxvf - oc
```

```
$ sudo cp oc /usr/local/bin
```

2. Power off the bare metal node by using the baseboard management controller (BMC), and ensure it is off.
3. Retrieve the user name and password of the bare metal node's baseboard management controller. Then, create **base64** strings from the user name and password:

```
$ echo -ne "root" | base64
```

```
$ echo -ne "password" | base64
```

4. Create a configuration file for the bare metal node. Depending on whether you are using a static configuration or a DHCP server, use one of the following example **bmh.yaml** files, replacing values in the YAML to match your environment:

```
$ vim bmh.yaml
```

- **Static configuration bmh.yaml:**

```
---
apiVersion: v1 1
kind: Secret
metadata:
  name: openshift-worker-<num>-network-config-secret 2
  namespace: openshift-machine-api
type: Opaque
stringData:
  nmstate: | 3
  interfaces:
  - name: <nic1_name> 4
    type: ethernet
    state: up
    ipv4:
      address:
      - ip: <ip_address> 5
        prefix-length: 24
        enabled: true
  dns-resolver:
  config:
  server:
  - <dns_ip_address> 6
  routes:
  config:
```

```

- destination: 0.0.0.0/0
  next-hop-address: <next_hop_ip_address> 7
  next-hop-interface: <next_hop_nic1_name> 8
---
apiVersion: v1
kind: Secret
metadata:
  name: openshift-worker-<num>-bmc-secret 9
  namespace: openshift-machine-api
type: Opaque
data:
  username: <base64_of_uid> 10
  password: <base64_of_pwd> 11
---
apiVersion: metal3.io/v1alpha1
kind: BareMetalHost
metadata:
  name: openshift-worker-<num> 12
  namespace: openshift-machine-api
spec:
  online: True
  bootMACAddress: <nic1_mac_address> 13
  bmc:
    address: <protocol>://<bmc_url> 14
    credentialsName: openshift-worker-<num>-bmc-secret 15
    disableCertificateVerification: True 16
    username: <bmc_username> 17
    password: <bmc_password> 18
  rootDeviceHints:
    deviceName: <root_device_hint> 19
  preprovisioningNetworkDataName: openshift-worker-<num>-network-config-secret 20

```

- 1 To configure the network interface for a newly created node, specify the name of the secret that contains the network configuration. Follow the **nmstate** syntax to define the network configuration for your node. See "Optional: Configuring host network interfaces in the install-config.yaml file" for details on configuring NMState syntax.
- 2 9 12 15 Replace **<num>** for the worker number of the bare metal node in the **name** fields, the **credentialsName** field, and the **preprovisioningNetworkDataName** field.
- 3 Add the NMState YAML syntax to configure the host interfaces.
- 4 5 6 7 8 Replace **<nic1\_name>**, **<ip\_address>**, **<dns\_ip\_address>**, **<next\_hop\_ip\_address>** and **<next\_hop\_nic1\_name>** with appropriate values.
- 10 11 Replace **<base64\_of\_uid>** and **<base64\_of\_pwd>** with the base64 string of the user name and password.
- 13 Replace **<nic1\_mac\_address>** with the MAC address of the bare metal node's first NIC. See the "BMC addressing" section for additional BMC configuration options.
- 14 Replace **<protocol>** with the BMC protocol, such as IPMI, RedFish, or others. Replace **<bmc\_url>** with the URL of the bare metal node's baseboard management controller.

- 16 To skip certificate validation, set **disableCertificateVerification** to true.
- 17 18 Replace **<bmc\_username>** and **<bmc\_password>** with the string of the BMC user name and password.
- 19 Optional: Replace **<root\_device\_hint>** with a device path if you specify a root device hint.
- 20 Optional: If you have configured the network interface for the newly created node, provide the network configuration secret name in the **preprovisioningNetworkDataName** of the BareMetalHost CR.

- DHCP configuration **bmh.yaml**:

```

---
apiVersion: v1
kind: Secret
metadata:
  name: openshift-worker-<num>-bmc-secret 1
  namespace: openshift-machine-api
type: Opaque
data:
  username: <base64_of_uid> 2
  password: <base64_of_pwd> 3
---
apiVersion: metal3.io/v1alpha1
kind: BareMetalHost
metadata:
  name: openshift-worker-<num> 4
  namespace: openshift-machine-api
spec:
  online: True
  bootMACAddress: <nic1_mac_address> 5
  bmc:
    address: <protocol>://<bmc_url> 6
    credentialsName: openshift-worker-<num>-bmc-secret 7
    disableCertificateVerification: True 8
    username: <bmc_username> 9
    password: <bmc_password> 10
  rootDeviceHints:
    deviceName: <root_device_hint> 11
  preprovisioningNetworkDataName: openshift-worker-<num>-network-config-secret 12

```

- 1 4 7 Replace **<num>** for the worker number of the bare metal node in the **name** fields, the **credentialsName** field, and the **preprovisioningNetworkDataName** field.
- 2 3 Replace **<base64\_of\_uid>** and **<base64\_of\_pwd>** with the base64 string of the user name and password.
- 5 Replace **<nic1\_mac\_address>** with the MAC address of the bare metal node's first NIC. See the "BMC addressing" section for additional BMC configuration options.

6

Replace **<protocol>** with the BMC protocol, such as IPMI, RedFish, or others. Replace **<bmc\_url>** with the URL of the bare metal node's baseboard management controller.

- 8 To skip certificate validation, set **disableCertificateVerification** to true.
- 9 10 Replace **<bmc\_username>** and **<bmc\_password>** with the string of the BMC user name and password.
- 11 Optional: Replace **<root\_device\_hint>** with a device path if you specify a root device hint.
- 12 Optional: If you have configured the network interface for the newly created node, provide the network configuration secret name in the **provisioningNetworkDataName** of the BareMetalHost CR.

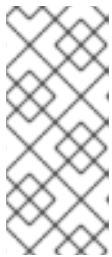

#### NOTE

If the MAC address of an existing bare metal node matches the MAC address of a bare metal host that you are attempting to provision, then the Ironic installation will fail. If the host enrollment, inspection, cleaning, or other Ironic steps fail, the Bare Metal Operator retries the installation continuously. See "Diagnosing a host duplicate MAC address" for more information.

5. Create the bare metal node:

```
$ oc -n openshift-machine-api create -f bmh.yaml
```

#### Example output

```
secret/openshift-worker-<num>-network-config-secret created
secret/openshift-worker-<num>-bmc-secret created
baremetalhost.metal3.io/openshift-worker-<num> created
```

Where **<num>** will be the worker number.

6. Power up and inspect the bare metal node:

```
$ oc -n openshift-machine-api get bmh openshift-worker-<num>
```

Where **<num>** is the worker node number.

#### Example output

```
NAME                STATE    CONSUMER  ONLINE  ERROR
openshift-worker-<num> available      true
```



#### NOTE

To allow the worker node to join the cluster, scale the **machineset** object to the number of the **BareMetalHost** objects. You can scale nodes either manually or automatically. To scale nodes automatically, use the **metal3.io/autoscale-to-hosts** annotation for **machineset**.

## Additional resources

- See [Optional: Configuring host network interfaces in the install-config.yaml file](#) for details on configuring the NMState syntax.
- See [Automatically scaling machines to the number of available bare metal hosts](#) for details on automatically scaling machines.

### 13.5.2. Replacing a bare-metal control plane node

Use the following procedure to replace an installer-provisioned OpenShift Container Platform control plane node.



#### IMPORTANT

If you reuse the **BareMetalHost** object definition from an existing control plane host, do not leave the **externallyProvisioned** field set to **true**.

Existing control plane **BareMetalHost** objects may have the **externallyProvisioned** flag set to **true** if they were provisioned by the OpenShift Container Platform installation program.

#### Prerequisites

- You have access to the cluster as a user with the **cluster-admin** role.
- You have taken an etcd backup.

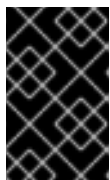

#### IMPORTANT

Take an etcd backup before performing this procedure so that you can restore your cluster if you encounter any issues. For more information about taking an etcd backup, see the *Additional resources* section.

#### Procedure

1. Ensure that the Bare Metal Operator is available:

```
$ oc get clusteroperator baremetal
```

#### Example output

```
NAME      VERSION  AVAILABLE  PROGRESSING  DEGRADED  SINCE  MESSAGE
baremetal 4.10.12  True       False        False     3d15h
```

2. Remove the old **BareMetalHost** and **Machine** objects:

```
$ oc delete bmh -n openshift-machine-api <host_name>
$ oc delete machine -n openshift-machine-api <machine_name>
```

Replace **<host\_name>** with the name of the host and **<machine\_name>** with the name of the machine. The machine name appears under the **CONSUMER** field.

After you remove the **BareMetalHost** and **Machine** objects, then the machine controller automatically deletes the **Node** object.

3. Create the new **BareMetalHost** object and the secret to store the BMC credentials:

```
$ cat <<EOF | oc apply -f -
apiVersion: v1
kind: Secret
metadata:
  name: control-plane-<num>-bmc-secret 1
  namespace: openshift-machine-api
data:
  username: <base64_of_uid> 2
  password: <base64_of_pwd> 3
type: Opaque
---
apiVersion: metal3.io/v1alpha1
kind: BareMetalHost
metadata:
  name: control-plane-<num> 4
  namespace: openshift-machine-api
spec:
  automatedCleaningMode: disabled
  bmc:
    address: <protocol>://<bmc_ip> 5
    credentialsName: control-plane-<num>-bmc-secret 6
  bootMACAddress: <NIC1_mac_address> 7
  bootMode: UEFI
  externallyProvisioned: false
  hardwareProfile: unknown
  online: true
EOF
```

- 1 4 6 Replace **<num>** for the control plane number of the bare metal node in the **name** fields and the **credentialsName** field.
- 2 Replace **<base64\_of\_uid>** with the **base64** string of the user name.
- 3 Replace **<base64\_of\_pwd>** with the **base64** string of the password.
- 5 Replace **<protocol>** with the BMC protocol, such as **redfish**, **redfish-virtualmedia**, **idrac-virtualmedia**, or others. Replace **<bmc\_ip>** with the IP address of the bare metal node's baseboard management controller. For additional BMC configuration options, see "BMC addressing" in the *Additional resources* section.
- 7 Replace **<NIC1\_mac\_address>** with the MAC address of the bare metal node's first NIC.

After the inspection is complete, the **BareMetalHost** object is created and available to be provisioned.

4. View available **BareMetalHost** objects:

```
$ oc get bmh -n openshift-machine-api
```

**Example output**

NAME	STATE	CONSUMER	ONLINE	ERROR	AGE
control-plane-1.example.com	available	control-plane-1	true		1h10m
control-plane-2.example.com	externally provisioned	control-plane-2		true	4h53m
control-plane-3.example.com	externally provisioned	control-plane-3		true	4h53m
compute-1.example.com	provisioned	compute-1-ktmmx		true	4h53m
compute-1.example.com	provisioned	compute-2-l2zmb		true	4h53m

There are no **MachineSet** objects for control plane nodes, so you must create a **Machine** object instead. You can copy the **providerSpec** from another control plane **Machine** object.

5. Create a **Machine** object:

```
$ cat <<EOF | oc apply -f -
apiVersion: machine.openshift.io/v1beta1
kind: Machine
metadata:
  annotations:
    metal3.io/BareMetalHost: openshift-machine-api/control-plane-<num> 1
  labels:
    machine.openshift.io/cluster-api-cluster: control-plane-<num> 2
    machine.openshift.io/cluster-api-machine-role: master
    machine.openshift.io/cluster-api-machine-type: master
  name: control-plane-<num> 3
  namespace: openshift-machine-api
spec:
  metadata: {}
  providerSpec:
    value:
      apiVersion: baremetal.cluster.k8s.io/v1alpha1
      customDeploy:
        method: install_coreos
      hostSelector: {}
      image:
        checksum: ""
        url: ""
      kind: BareMetalMachineProviderSpec
      metadata:
        creationTimestamp: null
      userData:
        name: master-user-data-managed
EOF
```

- 1 2 3 Replace **<num>** for the control plane number of the bare metal node in the **name**, **labels** and **annotations** fields.

6. To view the **BareMetalHost** objects, run the following command:

```
$ oc get bmh -A
```

### Example output

NAME	STATE	CONSUMER	ONLINE	ERROR	AGE
control-plane-1.example.com	provisioned	control-plane-1	true		2h53m
control-plane-2.example.com	externally provisioned	control-plane-2		true	5h53m
control-plane-3.example.com	externally provisioned	control-plane-3		true	5h53m
compute-1.example.com	provisioned	compute-1-ktmmx		true	5h53m
compute-2.example.com	provisioned	compute-2-l2zmb		true	5h53m

7. After the RHCOS installation, verify that the **BareMetalHost** is added to the cluster:

```
$ oc get nodes
```

### Example output

NAME	STATUS	ROLES	AGE	VERSION
control-plane-1.example.com	available	master	4m2s	v1.18.2
control-plane-2.example.com	available	master	141m	v1.18.2
control-plane-3.example.com	available	master	141m	v1.18.2
compute-1.example.com	available	worker	87m	v1.18.2
compute-2.example.com	available	worker	87m	v1.18.2



### NOTE

After replacement of the new control plane node, the etcd pod running in the new node is in **crashloopback** status. See "Replacing an unhealthy etcd member" in the *Additional resources* section for more information.

### Additional resources

- [Replacing an unhealthy etcd member](#)
- [Backing up etcd](#)
- [Bare metal configuration](#)
- [BMC addressing](#)

### 13.5.3. Preparing to deploy with Virtual Media on the baremetal network

If the **provisioning** network is enabled and you want to expand the cluster using Virtual Media on the **baremetal** network, use the following procedure.

#### Prerequisites

- There is an existing cluster with a **baremetal** network and a **provisioning** network.

#### Procedure



1. Edit the **provisioning** custom resource (CR) to enable deploying with Virtual Media on the **baremetal** network:

```
oc edit provisioning
```

```
apiVersion: metal3.io/v1alpha1
kind: Provisioning
metadata:
  creationTimestamp: "2021-08-05T18:51:50Z"
  finalizers:
  - provisioning.metal3.io
  generation: 8
  name: provisioning-configuration
  resourceVersion: "551591"
  uid: f76e956f-24c6-4361-aa5b-feaf72c5b526
spec:
  provisioningDHCPRange: 172.22.0.10,172.22.0.254
  provisioningIP: 172.22.0.3
  provisioningInterface: enp1s0
  provisioningNetwork: Managed
  provisioningNetworkCIDR: 172.22.0.0/24
  virtualMediaViaExternalNetwork: true 1
status:
  generations:
  - group: apps
    hash: ""
    lastGeneration: 7
    name: metal3
    namespace: openshift-machine-api
    resource: deployments
  - group: apps
    hash: ""
    lastGeneration: 1
    name: metal3-image-cache
    namespace: openshift-machine-api
    resource: daemonsets
  observedGeneration: 8
  readyReplicas: 0
```

- 1** Add **virtualMediaViaExternalNetwork: true** to the **provisioning** CR.

2. If the image URL exists, edit the **machineset** to use the API VIP address. This step only applies to clusters installed in versions 4.9 or earlier.

```
oc edit machineset
```

```
apiVersion: machine.openshift.io/v1beta1
kind: MachineSet
metadata:
  creationTimestamp: "2021-08-05T18:51:52Z"
  generation: 11
  labels:
    machine.openshift.io/cluster-api-cluster: ostest-hwmdt
    machine.openshift.io/cluster-api-machine-role: worker
```

```

machine.openshift.io/cluster-api-machine-type: worker
name: ostest-hwmdt-worker-0
namespace: openshift-machine-api
resourceVersion: "551513"
uid: fad1c6e0-b9da-4d4a-8d73-286f78788931
spec:
  replicas: 2
  selector:
    matchLabels:
      machine.openshift.io/cluster-api-cluster: ostest-hwmdt
      machine.openshift.io/cluster-api-machineset: ostest-hwmdt-worker-0
  template:
    metadata:
      labels:
        machine.openshift.io/cluster-api-cluster: ostest-hwmdt
        machine.openshift.io/cluster-api-machine-role: worker
        machine.openshift.io/cluster-api-machine-type: worker
        machine.openshift.io/cluster-api-machineset: ostest-hwmdt-worker-0
    spec:
      metadata: {}
      providerSpec:
        value:
          apiVersion: baremetal.cluster.k8s.io/v1alpha1
          hostSelector: {}
          image:
            checksum: http://172.22.0.3:6181/images/rhcos-<version>.x86_64.qcow2.<md5sum>
            url: http://172.22.0.3:6181/images/rhcos-<version>.x86_64.qcow2
          kind: BareMetalMachineProviderSpec
          metadata:
            creationTimestamp: null
          userData:
            name: worker-user-data
      status:
        availableReplicas: 2
        fullyLabeledReplicas: 2
        observedGeneration: 11
        readyReplicas: 2
        replicas: 2

```

1

1

Edit the **checksum** URL to use the API VIP address.

2

Edit the **url** URL to use the API VIP address.

#### 13.5.4. Diagnosing a duplicate MAC address when provisioning a new host in the cluster

If the MAC address of an existing bare-metal node in the cluster matches the MAC address of a bare-metal host you are attempting to add to the cluster, the Bare Metal Operator associates the host with the existing node. If the host enrollment, inspection, cleaning, or other Ironiic steps fail, the Bare Metal Operator retries the installation continuously. A registration error is displayed for the failed bare-metal host.

You can diagnose a duplicate MAC address by examining the bare-metal hosts that are running in the **openshift-machine-api** namespace.

### Prerequisites

- Install an OpenShift Container Platform cluster on bare metal.
- Install the OpenShift Container Platform CLI **oc**.
- Log in as a user with **cluster-admin** privileges.

### Procedure

To determine whether a bare-metal host that fails provisioning has the same MAC address as an existing node, do the following:

1. Get the bare-metal hosts running in the **openshift-machine-api** namespace:

```
$ oc get bmh -n openshift-machine-api
```

#### Example output

NAME	STATUS	PROVISIONING STATUS	CONSUMER
openshift-master-0	OK	externally provisioned	openshift-zpwpq-master-0
openshift-master-1	OK	externally provisioned	openshift-zpwpq-master-1
openshift-master-2	OK	externally provisioned	openshift-zpwpq-master-2
openshift-worker-0	OK	provisioned	openshift-zpwpq-worker-0-lv84n
openshift-worker-1	OK	provisioned	openshift-zpwpq-worker-0-zd8lm
openshift-worker-2	error	registering	

2. To see more detailed information about the status of the failing host, run the following command replacing **<bare\_metal\_host\_name>** with the name of the host:

```
$ oc get -n openshift-machine-api bmh <bare_metal_host_name> -o yaml
```

#### Example output

```
...
status:
  errorCount: 12
  errorMessage: MAC address b4:96:91:1d:7c:20 conflicts with existing node openshift-
worker-1
  errorType: registration error
...
```

### 13.5.5. Provisioning the bare metal node

Provisioning the bare metal node requires executing the following procedure from the provisioner node.

#### Procedure

1. Ensure the **STATE** is **available** before provisioning the bare metal node.

```
$ oc -n openshift-machine-api get bmh openshift-worker-<num>
```

-

Where **<num>** is the worker node number.

NAME	STATE	ONLINE	ERROR	AGE
openshift-worker	available	true		34h

- Get a count of the number of worker nodes.

```
$ oc get nodes
```

NAME	STATUS	ROLES	AGE	VERSION
openshift-master-1.openshift.example.com	Ready	master	30h	v1.23.0
openshift-master-2.openshift.example.com	Ready	master	30h	v1.23.0
openshift-master-3.openshift.example.com	Ready	master	30h	v1.23.0
openshift-worker-0.openshift.example.com	Ready	worker	30h	v1.23.0
openshift-worker-1.openshift.example.com	Ready	worker	30h	v1.23.0

- Get the machine set.

```
$ oc get machinesets -n openshift-machine-api
```

NAME	DESIRED	CURRENT	READY	AVAILABLE	AGE
...					
openshift-worker-0.example.com	1	1	1	1	55m
openshift-worker-1.example.com	1	1	1	1	55m

- Increase the number of worker nodes by one.

```
$ oc scale --replicas=<num> machineset <machineset> -n openshift-machine-api
```

Replace **<num>** with the new number of worker nodes. Replace **<machineset>** with the name of the machine set from the previous step.

- Check the status of the bare metal node.

```
$ oc -n openshift-machine-api get bmh openshift-worker-<num>
```

Where **<num>** is the worker node number. The STATE changes from **ready** to **provisioning**.

NAME	STATE	CONSUMER	ONLINE	ERROR
openshift-worker-<num>	provisioning	openshift-worker-<num>-65tjz		true

The **provisioning** status remains until the OpenShift Container Platform cluster provisions the node. This can take 30 minutes or more. After the node is provisioned, the state will change to **provisioned**.

NAME	STATE	CONSUMER	ONLINE	ERROR
openshift-worker-<num>	provisioned	openshift-worker-<num>-65tjz		true

- After provisioning completes, ensure the bare metal node is ready.

```
$ oc get nodes
```

NAME	STATUS	ROLES	AGE	VERSION
openshift-master-1.openshift.example.com	Ready	master	30h	v1.23.0
openshift-master-2.openshift.example.com	Ready	master	30h	v1.23.0
openshift-master-3.openshift.example.com	Ready	master	30h	v1.23.0
openshift-worker-0.openshift.example.com	Ready	worker	30h	v1.23.0
openshift-worker-1.openshift.example.com	Ready	worker	30h	v1.23.0
openshift-worker-<num>.openshift.example.com	Ready	worker	3m27s	v1.23.0

You can also check the kubelet.

```
$ ssh openshift-worker-<num>
```

```
[kni@openshift-worker-<num>]$ journalctl -fu kubelet
```

## 13.6. TROUBLESHOOTING

### 13.6.1. Troubleshooting the installer workflow

Prior to troubleshooting the installation environment, it is critical to understand the overall flow of the installer-provisioned installation on bare metal. The diagrams below provide a troubleshooting flow with a step-by-step breakdown for the environment.

Workflow 1 of 4

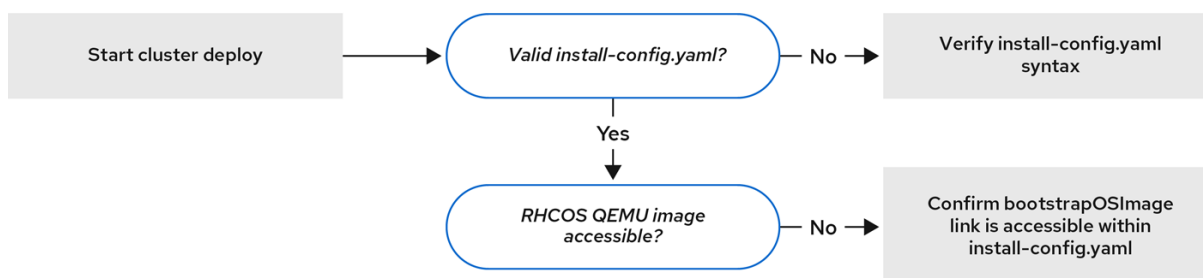

82\_OpenShift\_0420

*Workflow 1 of 4* illustrates a troubleshooting workflow when the **install-config.yaml** file has errors or the Red Hat Enterprise Linux CoreOS (RHCOS) images are inaccessible. Troubleshooting suggestions can be found at [Troubleshooting install-config.yaml](#).

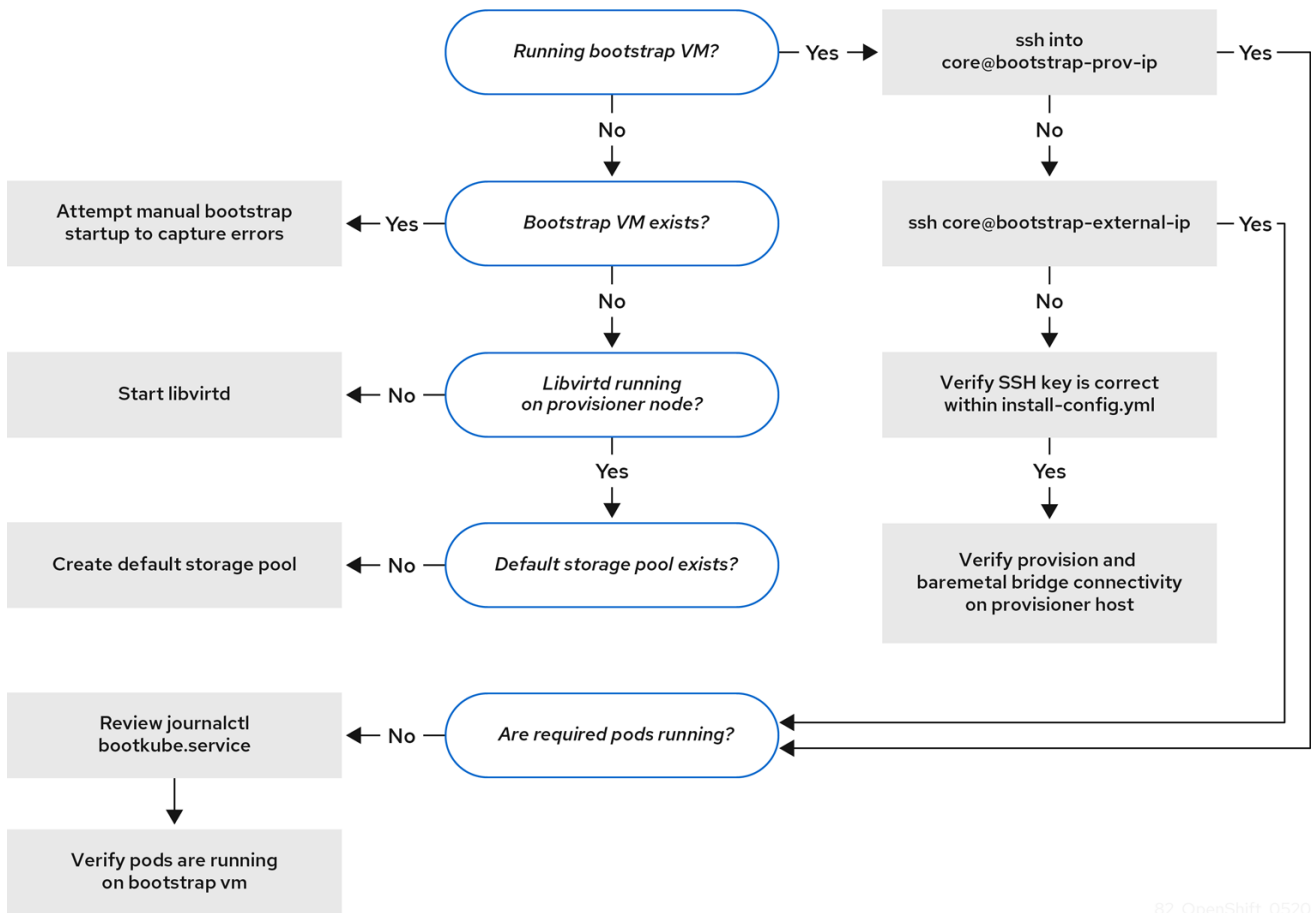

82\_OpenShift\_0520

Workflow 2 of 4 illustrates a troubleshooting workflow for [bootstrap VM issues](#), [bootstrap VMs that cannot boot up the cluster nodes](#), and [inspecting logs](#). When installing an OpenShift Container Platform cluster without the **provisioning** network, this workflow does not apply.

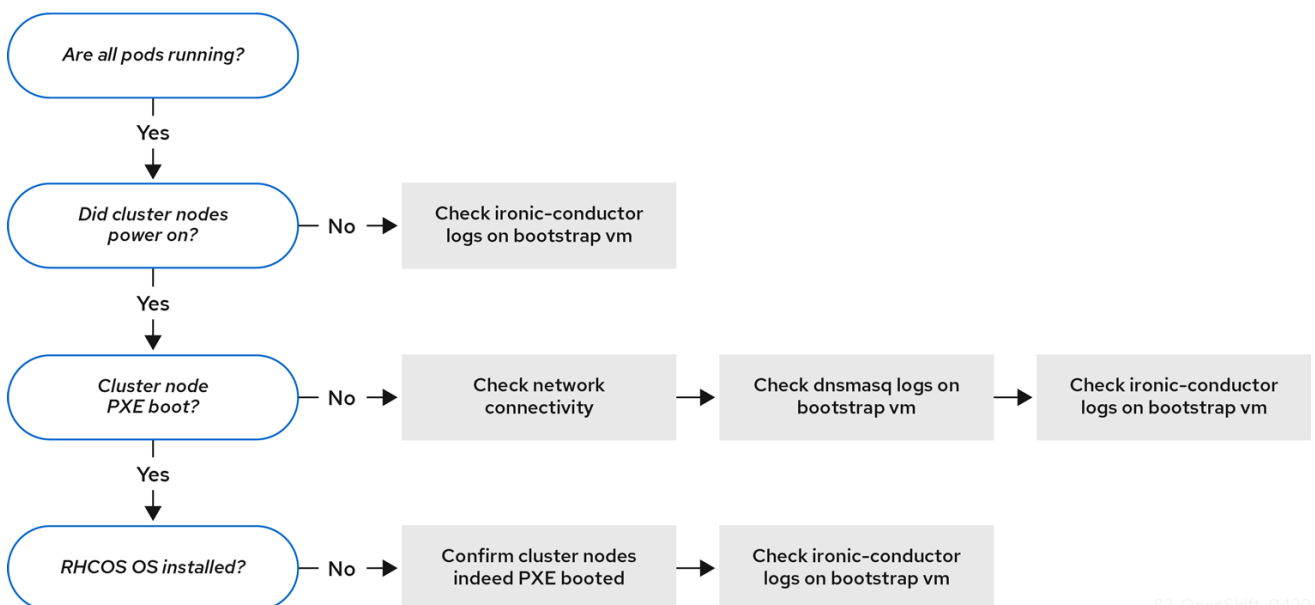

82\_OpenShift\_0420

Workflow 3 of 4 illustrates a troubleshooting workflow for [cluster nodes that will not PXE boot](#). If installing using RedFish Virtual Media, each node must meet minimum firmware requirements for the installer to deploy the node. See **Firmware requirements for installing with virtual media** in the **Prerequisites** section for additional details.

Workflow 4 of 4

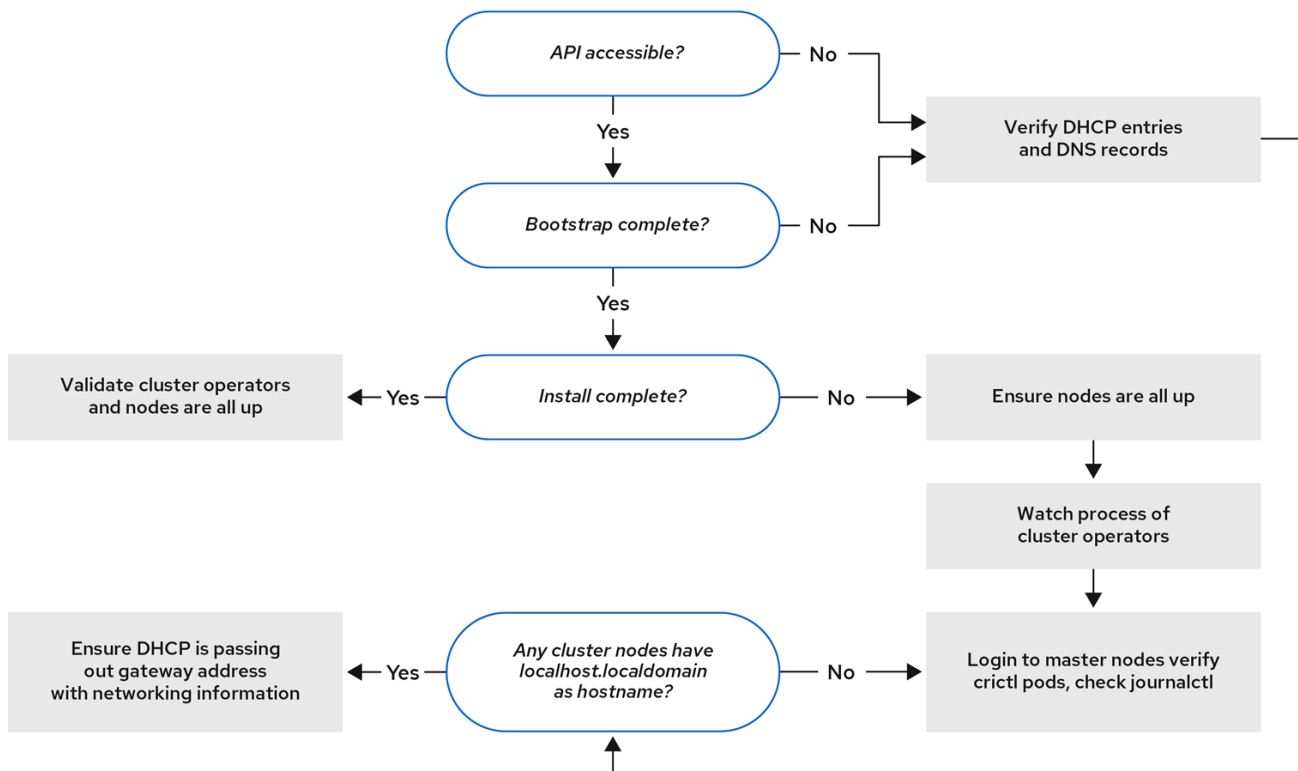

82\_OpenShift\_0420

Workflow 4 of 4 illustrates a troubleshooting workflow from [a non-accessible API](#) to a [validated installation](#).

### 13.6.2. Troubleshooting install-config.yaml

The **install-config.yaml** configuration file represents all of the nodes that are part of the OpenShift Container Platform cluster. The file contains the necessary options consisting of but not limited to **apiVersion**, **baseDomain**, **imageContentSources** and virtual IP addresses. If errors occur early in the deployment of the OpenShift Container Platform cluster, the errors are likely in the **install-config.yaml** configuration file.

#### Procedure

1. Use the guidelines in [YAML-tips](#).
2. Verify the YAML syntax is correct using [syntax-check](#).
3. Verify the Red Hat Enterprise Linux CoreOS (RHCOS) QEMU images are properly defined and accessible via the URL provided in the **install-config.yaml**. For example:

```
$ curl -s -o /dev/null -I -w "%{http_code}\n" http://webserver.example.com:8080/rhcos-44.81.202004250133-0-qemu.x86_64.qcow2.gz?sha256=7d884b46ee54fe87bbc3893bf2aa99af3b2d31f2e19ab5529c60636fbd0f1ce7
```

If the output is **200**, there is a valid response from the webserver storing the bootstrap VM image.

### 13.6.3. Bootstrap VM issues

The OpenShift Container Platform installation program spawns a bootstrap node virtual machine, which handles provisioning the OpenShift Container Platform cluster nodes.

#### Procedure

1. About 10 to 15 minutes after triggering the installation program, check to ensure the bootstrap VM is operational using the **virsh** command:

```
$ sudo virsh list
```

Id	Name	State
12	openshift-xf6fq-bootstrap	running



#### NOTE

The name of the bootstrap VM is always the cluster name followed by a random set of characters and ending in the word "bootstrap."

If the bootstrap VM is not running after 10–15 minutes, troubleshoot why it is not running. Possible issues include:

2. Verify **libvirtd** is running on the system:

```
$ systemctl status libvirtd
```

```
● libvirtd.service - Virtualization daemon
   Loaded: loaded (/usr/lib/systemd/system/libvirtd.service; enabled; vendor preset: enabled)
   Active: active (running) since Tue 2020-03-03 21:21:07 UTC; 3 weeks 5 days ago
     Docs: man:libvirtd(8)
           https://libvirt.org
   Main PID: 9850 (libvirtd)
    Tasks: 20 (limit: 32768)
   Memory: 74.8M
   CGroup: /system.slice/libvirtd.service
           └─ 9850 /usr/sbin/libvirtd
```

If the bootstrap VM is operational, log in to it.

3. Use the **virsh console** command to find the IP address of the bootstrap VM:

```
$ sudo virsh console example.com
```



```

Connected to domain example.com
Escape character is ^]
Red Hat Enterprise Linux CoreOS 43.81.202001142154.0 (Ootpa) 4.3
SSH host key: SHA256:BRWJktXZgQQRY5zjuAV0IKZ4WM7i4TiUyMVAnqu9Pqg (ED25519)
SSH host key: SHA256:7+iKGA7VtG5szmk2jB5gl/5EZ+SNcJ3a2g23o0Inlio (ECDSA)
SSH host key: SHA256:DH5VWhvhvagOTaLsYiVNse9ca+ZSW/30OOMed8rIGOc (RSA)
ens3: fd35:919d:4042:2:c7ed:9a9f:a9ec:7
ens4: 172.22.0.2 fe80::1d05:e52e:be5d:263f
localhost login:

```



### IMPORTANT

When deploying an OpenShift Container Platform cluster without the **provisioning** network, you must use a public IP address and not a private IP address like **172.22.0.2**.

4. After you obtain the IP address, log in to the bootstrap VM using the **ssh** command:



### NOTE

In the console output of the previous step, you can use the IPv6 IP address provided by **ens3** or the IPv4 IP provided by **ens4**.

```
$ ssh core@172.22.0.2
```

If you are not successful logging in to the bootstrap VM, you have likely encountered one of the following scenarios:

- You cannot reach the **172.22.0.0/24** network. Verify the network connectivity between the provisioner and the **provisioning** network bridge. This issue might occur if you are using a **provisioning** network.
- You cannot reach the bootstrap VM through the public network. When attempting to SSH via **baremetal** network, verify connectivity on the **provisioner** host specifically around the **baremetal** network bridge.
- You encountered **Permission denied (publickey,password,keyboard-interactive)**. When attempting to access the bootstrap VM, a **Permission denied** error might occur. Verify that the SSH key for the user attempting to log in to the VM is set within the **install-config.yaml** file.

#### 13.6.3.1. Bootstrap VM cannot boot up the cluster nodes

During the deployment, it is possible for the bootstrap VM to fail to boot the cluster nodes, which prevents the VM from provisioning the nodes with the RHCOS image. This scenario can arise due to:

- A problem with the **install-config.yaml** file.
- Issues with out-of-band network access when using the baremetal network.

To verify the issue, there are three containers related to **ironic**:

- **ironic-api**
- **ironic-conductor**

- **ironic-inspector**

### Procedure

1. Log in to the bootstrap VM:

```
$ ssh core@172.22.0.2
```

2. To check the container logs, execute the following:

```
[core@localhost ~]$ sudo podman logs -f <container_name>
```

Replace **<container\_name>** with one of **ironic** or **ironic-inspector**. If you encounter an issue where the control plane nodes are not booting up from PXE, check the **ironic** pod. The **ironic** pod contains information about the attempt to boot the cluster nodes, because it attempts to log in to the node over IPMI.

### Potential reason

The cluster nodes might be in the **ON** state when deployment started.

### Solution

Power off the OpenShift Container Platform cluster nodes before you begin the installation over IPMI:

```
$ ipmitool -I lanplus -U root -P <password> -H <out_of_band_ip> power off
```

### 13.6.3.2. Inspecting logs

When experiencing issues downloading or accessing the RHCOS images, first verify that the URL is correct in the **install-config.yaml** configuration file.

### Example of internal webserver hosting RHCOS images

```
bootstrapOSImage: http://<ip:port>/rhcos-43.81.202001142154.0-qemu.x86_64.qcow2.gz?
sha256=9d999f55ff1d44f7ed7c106508e5deecd04dc3c06095d34d36bf1cd127837e0c
clusterOSImage: http://<ip:port>/rhcos-43.81.202001142154.0-openstack.x86_64.qcow2.gz?
sha256=a1bda656fa0892f7b936fdc6b6a6086bddaed5dafacedcd7a1e811abb78fe3b0
```

The **coreos-downloader** container downloads resources from a webserver or from the external [quay.io](https://quay.io) registry, whichever the **install-config.yaml** configuration file specifies. Verify that the **coreos-downloader** container is up and running and inspect its logs as needed.

### Procedure

1. Log in to the bootstrap VM:

```
$ ssh core@172.22.0.2
```

2. Check the status of the **coreos-downloader** container within the bootstrap VM by running the following command:

```
[core@localhost ~]$ sudo podman logs -f coreos-downloader
```

If the bootstrap VM cannot access the URL to the images, use the **curl** command to verify that the VM can access the images.

3. To inspect the **bootkube** logs that indicate if all the containers launched during the deployment phase, execute the following:

```
[core@localhost ~]$ journalctl -xe
```

```
[core@localhost ~]$ journalctl -b -f -u bootkube.service
```

4. Verify all the pods, including **dnsmasq**, **mariadb**, **httpd**, and **ironic**, are running:

```
[core@localhost ~]$ sudo podman ps
```

5. If there are issues with the pods, check the logs of the containers with issues. To check the log of the **ironic-api**, execute the following:

```
[core@localhost ~]$ sudo podman logs <ironic-api>
```

#### 13.6.4. Cluster nodes will not PXE boot

When OpenShift Container Platform cluster nodes will not PXE boot, execute the following checks on the cluster nodes that will not PXE boot. This procedure does not apply when installing an OpenShift Container Platform cluster without the **provisioning** network.

##### Procedure

1. Check the network connectivity to the **provisioning** network.
2. Ensure PXE is enabled on the NIC for the **provisioning** network and PXE is disabled for all other NICs.
3. Verify that the **install-config.yaml** configuration file has the proper hardware profile and boot MAC address for the NIC connected to the **provisioning** network. For example:

##### control plane node settings

```
bootMACAddress: 24:6E:96:1B:96:90 # MAC of bootable provisioning NIC
hardwareProfile: default          #control plane node settings
```

##### Worker node settings

```
bootMACAddress: 24:6E:96:1B:96:90 # MAC of bootable provisioning NIC
hardwareProfile: unknown          #worker node settings
```

#### 13.6.5. The API is not accessible

When the cluster is running and clients cannot access the API, domain name resolution issues might impede access to the API.

##### Procedure

1. **Hostname Resolution:** Check the cluster nodes to ensure they have a fully qualified domain name, and not just **localhost.localdomain**. For example:

```
$ hostname
```

If a hostname is not set, set the correct hostname. For example:

```
$ hostnamectl set-hostname <hostname>
```

2. **Incorrect Name Resolution:** Ensure that each node has the correct name resolution in the DNS server using **dig** and **nslookup**. For example:

```
$ dig api.<cluster_name>.example.com
```

```
; <<>> DiG 9.11.4-P2-RedHat-9.11.4-26.P2.el8 <<>> api.<cluster_name>.example.com
;; global options: +cmd
;; Got answer:
;; ->>HEADER<<- opcode: QUERY, status: NOERROR, id: 37551
;; flags: qr aa rd ra; QUERY: 1, ANSWER: 1, AUTHORITY: 1, ADDITIONAL: 2

;; OPT PSEUDOSECTION:
;; EDNS: version: 0, flags:; udp: 4096
;; COOKIE: 866929d2f8e8563582af23f05ec44203d313e50948d43f60 (good)
;; QUESTION SECTION:
;api.<cluster_name>.example.com. IN A

;; ANSWER SECTION:
api.<cluster_name>.example.com. 10800 IN A 10.19.13.86

;; AUTHORITY SECTION:
<cluster_name>.example.com. 10800 IN NS <cluster_name>.example.com.

;; ADDITIONAL SECTION:
<cluster_name>.example.com. 10800 IN A 10.19.14.247

;; Query time: 0 msec
;; SERVER: 10.19.14.247#53(10.19.14.247)
;; WHEN: Tue May 19 20:30:59 UTC 2020
;; MSG SIZE rcvd: 140
```

The output in the foregoing example indicates that the appropriate IP address for the **api.<cluster\_name>.example.com** VIP is **10.19.13.86**. This IP address should reside on the **baremetal** network.

### 13.6.6. Troubleshooting worker nodes that cannot join the cluster

Installer-provisioned clusters deploy with a DNS server that includes a DNS entry for the **api-int.<cluster\_name>.<base\_domain>** URL. If the nodes within the cluster use an external or upstream DNS server to resolve the **api-int.<cluster\_name>.<base\_domain>** URL and there is no such entry, worker nodes might fail to join the cluster. Ensure that all nodes in the cluster can resolve the domain name.

#### Procedure

1. Add a DNS A/AAAA or CNAME record to internally identify the API load balancer. For example, when using dnsmasq, modify the **dnsmasq.conf** configuration file:

```
$ sudo nano /etc/dnsmasq.conf
```

```
address=/api-int.<cluster_name>.<base_domain>/<IP_address>
address=/api-int.mycluster.example.com/192.168.1.10
address=/api-int.mycluster.example.com/2001:0db8:85a3:0000:0000:8a2e:0370:7334
```

2. Add a DNS PTR record to internally identify the API load balancer. For example, when using dnsmasq, modify the **dnsmasq.conf** configuration file:

```
$ sudo nano /etc/dnsmasq.conf
```

```
ptr-record=<IP_address>.in-addr.arpa,api-int.<cluster_name>.<base_domain>
ptr-record=10.1.168.192.in-addr.arpa,api-int.mycluster.example.com
```

3. Restart the DNS server. For example, when using dnsmasq, execute the following command:

```
$ sudo systemctl restart dnsmasq
```

These records must be resolvable from all the nodes within the cluster.

### 13.6.7. Cleaning up previous installations

In the event of a previous failed deployment, remove the artifacts from the failed attempt before attempting to deploy OpenShift Container Platform again.

#### Procedure

1. Power off all bare metal nodes prior to installing the OpenShift Container Platform cluster:

```
$ ipmitool -I lanplus -U <user> -P <password> -H <management_server_ip> power off
```

2. Remove all old bootstrap resources if any are left over from a previous deployment attempt:

```
for i in $(sudo virsh list | tail -n +3 | grep bootstrap | awk {'print $2'});
do
  sudo virsh destroy $i;
  sudo virsh undefine $i;
  sudo virsh vol-delete $i --pool $i;
  sudo virsh vol-delete $i.ign --pool $i;
  sudo virsh pool-destroy $i;
  sudo virsh pool-undefine $i;
done
```

3. Remove the following from the **clusterconfigs** directory to prevent Terraform from failing:

```
$ rm -rf ~/clusterconfigs/auth ~/clusterconfigs/terraform* ~/clusterconfigs/tls
~/clusterconfigs/metadata.json
```

### 13.6.8. Issues with creating the registry

When creating a disconnected registry, you might encounter a "User Not Authorized" error when attempting to mirror the registry. This error might occur if you fail to append the new authentication to the existing **pull-secret.txt** file.

## Procedure

1. Check to ensure authentication is successful:

```
$ /usr/local/bin/oc adm release mirror \
-a pull-secret-update.json
--from=$UPSTREAM_REPO \
--to-release-image=$LOCAL_REG/$LOCAL_REPO:${VERSION} \
--to=$LOCAL_REG/$LOCAL_REPO
```



### NOTE

Example output of the variables used to mirror the install images:

```
UPSTREAM_REPO=${RELEASE_IMAGE}
LOCAL_REG=<registry_FQDN>:<registry_port>
LOCAL_REPO='ocp4/openshift4'
```

The values of **RELEASE\_IMAGE** and **VERSION** were set during the **Retrieving OpenShift Installer** step of the **Setting up the environment for an OpenShift installation** section.

2. After mirroring the registry, confirm that you can access it in your disconnected environment:

```
$ curl -k -u <user>:<password> https://registry.example.com:<registry_port>/v2/_catalog
{"repositories":["<Repo_Name>"]}
```

## 13.6.9. Miscellaneous issues

### 13.6.9.1. Addressing the runtime network not ready error

After the deployment of a cluster you might receive the following error:

```
`runtime network not ready: NetworkReady=false reason:NetworkPluginNotReady message:Network
plugin returns error: Missing CNI default network`
```

The Cluster Network Operator is responsible for deploying the networking components in response to a special object created by the installer. It runs very early in the installation process, after the control plane (master) nodes have come up, but before the bootstrap control plane has been torn down. It can be indicative of more subtle installer issues, such as long delays in bringing up control plane (master) nodes or issues with **apiserver** communication.

## Procedure

1. Inspect the pods in the **openshift-network-operator** namespace:

```
$ oc get all -n openshift-network-operator
```

NAME	READY	STATUS	RESTARTS	AGE
pod/network-operator-69dfd7b577-bg89v	0/1	ContainerCreating	0	149m

2. On the **provisioner** node, determine that the network configuration exists:

```
$ kubectl get network.config.openshift.io cluster -oyaml
```

```
apiVersion: config.openshift.io/v1
kind: Network
metadata:
  name: cluster
spec:
  serviceNetwork:
  - 172.30.0.0/16
  clusterNetwork:
  - cidr: 10.128.0.0/14
    hostPrefix: 23
  networkType: OpenShiftSDN
```

If it does not exist, the installer did not create it. To determine why the installer did not create it, execute the following:

```
$ openshift-install create manifests
```

3. Check that the **network-operator** is running:

```
$ kubectl -n openshift-network-operator get pods
```

4. Retrieve the logs:

```
$ kubectl -n openshift-network-operator logs -l "name=network-operator"
```

On high availability clusters with three or more control plane (master) nodes, the Operator will perform leader election and all other Operators will sleep. For additional details, see [Troubleshooting](#).

### 13.6.9.2. Cluster nodes not getting the correct IPv6 address over DHCP

If the cluster nodes are not getting the correct IPv6 address over DHCP, check the following:

1. Ensure the reserved IPv6 addresses reside outside the DHCP range.
2. In the IP address reservation on the DHCP server, ensure the reservation specifies the correct DHCP Unique Identifier (DUID). For example:

```
# This is a dnsmasq dhcp reservation, 'id:00:03:00:01' is the client id and '18:db:f2:8c:d5:9f' is
the MAC Address for the NIC
id:00:03:00:01:18:db:f2:8c:d5:9f,openshift-master-1,[2620:52:0:1302::6]
```

3. Ensure that route announcements are working.
4. Ensure that the DHCP server is listening on the required interfaces serving the IP address ranges.

### 13.6.9.3. Cluster nodes not getting the correct hostname over DHCP

During IPv6 deployment, cluster nodes must get their hostname over DHCP. Sometimes the **NetworkManager** does not assign the hostname immediately. A control plane (master) node might report an error such as:

```
Failed Units: 2
NetworkManager-wait-online.service
nodeip-configuration.service
```

This error indicates that the cluster node likely booted without first receiving a hostname from the DHCP server, which causes **kubelet** to boot with a **localhost.localdomain** hostname. To address the error, force the node to renew the hostname.

#### Procedure

1. Retrieve the **hostname**:

```
[core@master-X ~]$ hostname
```

If the hostname is **localhost**, proceed with the following steps.



#### NOTE

Where **X** is the control plane node number.

2. Force the cluster node to renew the DHCP lease:

```
[core@master-X ~]$ sudo nmcli con up "<bare_metal_nic>"
```

Replace **<bare\_metal\_nic>** with the wired connection corresponding to the **baremetal** network.

3. Check **hostname** again:

```
[core@master-X ~]$ hostname
```

4. If the hostname is still **localhost.localdomain**, restart **NetworkManager**:

```
[core@master-X ~]$ sudo systemctl restart NetworkManager
```

5. If the hostname is still **localhost.localdomain**, wait a few minutes and check again. If the hostname remains **localhost.localdomain**, repeat the previous steps.

6. Restart the **nodeip-configuration** service:

```
[core@master-X ~]$ sudo systemctl restart nodeip-configuration.service
```

This service will reconfigure the **kubelet** service with the correct hostname references.

7. Reload the unit files definition since the kubelet changed in the previous step:

```
[core@master-X ~]$ sudo systemctl daemon-reload
```



- Restart the **kubelet** service:

```
[core@master-X ~]$ sudo systemctl restart kubelet.service
```

- Ensure **kubelet** booted with the correct hostname:

```
[core@master-X ~]$ sudo journalctl -fu kubelet.service
```

If the cluster node is not getting the correct hostname over DHCP after the cluster is up and running, such as during a reboot, the cluster will have a pending **csr**. **Do not** approve a **csr**, or other issues might arise.

### Addressing a **csr**

- Get CSRs on the cluster:

```
$ oc get csr
```

- Verify if a pending **csr** contains **Subject Name: localhost.localdomain**:

```
$ oc get csr <pending_csr> -o jsonpath='{.spec.request}' | base64 --decode | openssl req -noout -text
```

- Remove any **csr** that contains **Subject Name: localhost.localdomain**:

```
$ oc delete csr <wrong_csr>
```

#### 13.6.9.4. Routes do not reach endpoints

During the installation process, it is possible to encounter a Virtual Router Redundancy Protocol (VRRP) conflict. This conflict might occur if a previously used OpenShift Container Platform node that was once part of a cluster deployment using a specific cluster name is still running but not part of the current OpenShift Container Platform cluster deployment using that same cluster name. For example, a cluster was deployed using the cluster name **openshift**, deploying three control plane (master) nodes and three worker nodes. Later, a separate install uses the same cluster name **openshift**, but this redeployment only installed three control plane (master) nodes, leaving the three worker nodes from a previous deployment in an **ON** state. This might cause a Virtual Router Identifier (VRID) conflict and a VRRP conflict.

- Get the route:

```
$ oc get route oauth-openshift
```

- Check the service endpoint:

```
$ oc get svc oauth-openshift
```

```
NAME          TYPE          CLUSTER-IP    EXTERNAL-IP  PORT(S)  AGE
oauth-openshift ClusterIP    172.30.19.162 <none>       443/TCP  59m
```

- Attempt to reach the service from a control plane (master) node:

```
[core@master0 ~]$ curl -k https://172.30.19.162
```

```
{
  "kind": "Status",
  "apiVersion": "v1",
  "metadata": {
  },
  "status": "Failure",
  "message": "forbidden: User \"system:anonymous\" cannot get path \"/\"",
  "reason": "Forbidden",
  "details": {
  },
  "code": 403
}
```

4. Identify the **authentication-operator** errors from the **provisioner** node:

```
$ oc logs deployment/authentication-operator -n openshift-authentication-operator
```

```
Event(v1.ObjectReference{Kind:"Deployment", Namespace:"openshift-authentication-operator", Name:"authentication-operator", UID:"225c5bd5-b368-439b-9155-5fd3c0459d98", APIVersion:"apps/v1", ResourceVersion:"", FieldPath:""}): type: 'Normal' reason: 'OperatorStatusChanged' Status for clusteroperator/authentication changed: Degraded message changed from "IngressStateEndpointsDegraded: All 2 endpoints for oauth-server are reporting"
```

## Solution

1. Ensure that the cluster name for every deployment is unique, ensuring no conflict.
2. Turn off all the rogue nodes which are not part of the cluster deployment that are using the same cluster name. Otherwise, the authentication pod of the OpenShift Container Platform cluster might never start successfully.

### 13.6.9.5. Failed Ignition during Firstboot

During the Firstboot, the Ignition configuration may fail.

#### Procedure

1. Connect to the node where the Ignition configuration failed:

```
Failed Units: 1
machine-config-daemon-firstboot.service
```

2. Restart the **machine-config-daemon-firstboot** service:

```
[core@worker-X ~]$ sudo systemctl restart machine-config-daemon-firstboot.service
```

### 13.6.9.6. NTP out of sync

The deployment of OpenShift Container Platform clusters depends on NTP synchronized clocks among the cluster nodes. Without synchronized clocks, the deployment may fail due to clock drift if the time difference is greater than two seconds.

## Procedure

1. Check for differences in the **AGE** of the cluster nodes. For example:

```
$ oc get nodes
```

```
NAME                STATUS ROLES  AGE  VERSION
master-0.cloud.example.com Ready  master 145m v1.23.0
master-1.cloud.example.com Ready  master 135m v1.23.0
master-2.cloud.example.com Ready  master 145m v1.23.0
worker-2.cloud.example.com Ready  worker 100m v1.23.0
```

2. Check for inconsistent timing delays due to clock drift. For example:

```
$ oc get bmh -n openshift-machine-api
```

```
master-1  error registering master-1 ipmi://<out_of_band_ip>
```

```
$ sudo timedatectl
```

```
Local time: Tue 2020-03-10 18:20:02 UTC
Universal time: Tue 2020-03-10 18:20:02 UTC
RTC time: Tue 2020-03-10 18:36:53
Time zone: UTC (UTC, +0000)
System clock synchronized: no
NTP service: active
RTC in local TZ: no
```

## Addressing clock drift in existing clusters

1. Create a Butane config file including the contents of the **chrony.conf** file to be delivered to the nodes. In the following example, create **99-master-chrony.bu** to add the file to the control plane nodes. You can modify the file for worker nodes or repeat this procedure for the worker role.



### NOTE

See "Creating machine configs with Butane" for information about Butane.

```
variant: openshift
version: 4.10.0
metadata:
  name: 99-master-chrony
  labels:
    machineconfiguration.openshift.io/role: master
storage:
  files:
    - path: /etc/chrony.conf
```

```

mode: 0644
overwrite: true
contents:
  inline: |
    server <NTP_server> iburst 1
    stratumweight 0
    driftfile /var/lib/chrony/drift
    rtsync
    makestep 10 3
    bindcmdaddress 127.0.0.1
    bindcmdaddress ::1
    keyfile /etc/chrony.keys
    commandkey 1
    generatecommandkey
    noclientlog
    logchange 0.5
    logdir /var/log/chrony

```

**1** Replace **<NTP\_server>** with the IP address of the NTP server.

2. Use Butane to generate a **MachineConfig** object file, **99-master-chrony.yaml**, containing the configuration to be delivered to the nodes:

```
$ butane 99-master-chrony.bu -o 99-master-chrony.yaml
```

3. Apply the **MachineConfig** object file:

```
$ oc apply -f 99-master-chrony.yaml
```

4. Ensure the **System clock synchronized** value is **yes**:

```
$ sudo timedatectl
```

```

Local time: Tue 2020-03-10 19:10:02 UTC
Universal time: Tue 2020-03-10 19:10:02 UTC
RTC time: Tue 2020-03-10 19:36:53
Time zone: UTC (UTC, +0000)
System clock synchronized: yes
NTP service: active
RTC in local TZ: no

```

To setup clock synchronization prior to deployment, generate the manifest files and add this file to the **openshift** directory. For example:

```
$ cp chrony-masters.yaml ~/clusterconfigs/openshift/99_masters-chrony-configuration.yaml
```

Then, continue to create the cluster.

### 13.6.10. Reviewing the installation

After installation, ensure the installer deployed the nodes and pods successfully.

## Procedure

1. When the OpenShift Container Platform cluster nodes are installed appropriately, the following **Ready** state is seen within the **STATUS** column:

```
$ oc get nodes
```

```
NAME                STATUS  ROLES    AGE  VERSION
master-0.example.com Ready  master,worker  4h  v1.23.0
master-1.example.com Ready  master,worker  4h  v1.23.0
master-2.example.com Ready  master,worker  4h  v1.23.0
```

2. Confirm the installer deployed all pods successfully. The following command removes any pods that are still running or have completed as part of the output.

```
$ oc get pods --all-namespaces | grep -iv running | grep -iv complete
```

# CHAPTER 14. INSTALLING IBM CLOUD BARE METAL (CLASSIC)

## 14.1. PREREQUISITES

You can use installer-provisioned installation to install OpenShift Container Platform on IBM Cloud® Bare Metal (Classic) nodes. This document describes the prerequisites and procedures when installing OpenShift Container Platform on IBM Cloud nodes.

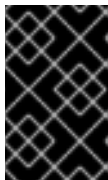

### IMPORTANT

Red Hat supports IPMI and PXE on the provisioning network only. Red Hat has not tested Red Fish, virtual media, or other complementary technologies such as Secure Boot on IBM Cloud deployments. A provisioning network is required.

Installer-provisioned installation of OpenShift Container Platform requires:

- One node with Red Hat Enterprise Linux CoreOS (RHCOS) 8.x installed, for running the provisioner
- Three control plane nodes
- One routable network
- One provisioning network

Before starting an installer-provisioned installation of OpenShift Container Platform on IBM Cloud Bare Metal (Classic), address the following prerequisites and requirements.

### 14.1.1. Setting up IBM Cloud Bare Metal (Classic) infrastructure

To deploy an OpenShift Container Platform cluster on IBM Cloud® Bare Metal (Classic) infrastructure, you must first provision the IBM Cloud nodes.



### IMPORTANT

Red Hat supports IPMI and PXE on the **provisioning** network only. Red Hat has not tested Red Fish, virtual media, or other complementary technologies such as Secure Boot on IBM Cloud deployments. The **provisioning** network is required.

You can customize IBM Cloud nodes using the IBM Cloud API. When creating IBM Cloud nodes, you must consider the following requirements.

#### Use one data center per cluster

All nodes in the OpenShift Container Platform cluster must run in the same IBM Cloud data center.

#### Create public and private VLANs

Create all nodes with a single public VLAN and a single private VLAN.

#### Ensure subnets have sufficient IP addresses

IBM Cloud public VLAN subnets use a /28 prefix by default, which provides 16 IP addresses. That is sufficient for a cluster consisting of three control plane nodes, four worker nodes, and two IP addresses for the API VIP and Ingress VIP on the **baremetal** network. For larger clusters, you might need a smaller

prefix.

IBM Cloud private VLAN subnets use a **/26** prefix by default, which provides 64 IP addresses. IBM Cloud Bare Metal (Classic) uses private network IP addresses to access the Baseboard Management Controller (BMC) of each node. OpenShift Container Platform creates an additional subnet for the **provisioning** network. Network traffic for the **provisioning** network subnet routes through the private VLAN. For larger clusters, you might need a smaller prefix.

**Table 14.1. IP addresses per prefix**

IP addresses	Prefix
32	<b>/27</b>
64	<b>/26</b>
128	<b>/25</b>
256	<b>/24</b>

### Configuring NICs

OpenShift Container Platform deploys with two networks:

- **provisioning**: The **provisioning** network is a non-routable network used for provisioning the underlying operating system on each node that is a part of the OpenShift Container Platform cluster.
- **baremetal**: The **baremetal** network is a routable network. You can use any NIC order to interface with the **baremetal** network, provided it is not the NIC specified in the **provisioningNetworkInterface** configuration setting or the NIC associated to a node's **bootMACAddress** configuration setting for the **provisioning** network.

While the cluster nodes can contain more than two NICs, the installation process only focuses on the first two NICs. For example:

NIC	Network	VLAN
NIC1	<b>provisioning</b>	<provisioning_vlan>
NIC2	<b>baremetal</b>	<baremetal_vlan>

In the previous example, NIC1 on all control plane and worker nodes connects to the non-routable network (**provisioning**) that is only used for the installation of the OpenShift Container Platform cluster. NIC2 on all control plane and worker nodes connects to the routable **baremetal** network.

PXE	Boot order
NIC1 PXE-enabled <b>provisioning</b> network	1
NIC2 <b>baremetal</b> network.	2

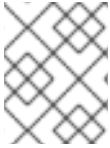
**NOTE**

Ensure PXE is enabled on the NIC used for the **provisioning** network and is disabled on all other NICs.

**Configuring canonical names**

Clients access the OpenShift Container Platform cluster nodes over the **baremetal** network. Configure IBM Cloud subdomains or subzones where the canonical name extension is the cluster name.

```
<cluster_name>.<domain>
```

For example:

```
test-cluster.example.com
```

**Creating DNS entries**

You must create DNS **A** record entries resolving to unused IP addresses on the public subnet for the following:

Usage	Host Name	IP
API	api.<cluster_name>.<domain>	<ip>
Ingress LB (apps)	*.apps.<cluster_name>.<domain>	<ip>

Control plane and worker nodes already have DNS entries after provisioning.

The following table provides an example of fully qualified domain names. The API and Nameserver addresses begin with canonical name extensions. The host names of the control plane and worker nodes are examples, so you can use any host naming convention you prefer.

Usage	Host Name	IP
API	api.<cluster_name>.<domain>	<ip>
Ingress LB (apps)	*.apps.<cluster_name>.<domain>	<ip>
Provisioner node	provisioner.<cluster_name>.<domain>	<ip>
Master-0	openshift-master-0.<cluster_name>.<domain>	<ip>
Master-1	openshift-master-1.<cluster_name>.<domain>	<ip>
Master-2	openshift-master-2.<cluster_name>.<domain>	<ip>



Usage	Host Name	IP
Worker-0	openshift-worker-0. <cluster_name>.<domain>	<ip>
Worker-1	openshift-worker-1. <cluster_name>.<domain>	<ip>
Worker-n	openshift-worker-n. <cluster_name>.<domain>	<ip>

OpenShift Container Platform includes functionality that uses cluster membership information to generate **A** records. This resolves the node names to their IP addresses. After the nodes are registered with the API, the cluster can disperse node information without using CoreDNS-mDNS. This eliminates the network traffic associated with multicast DNS.



### IMPORTANT

After provisioning the IBM Cloud nodes, you must create a DNS entry for the **api.<cluster\_name>.<domain>** domain name on the external DNS because removing CoreDNS causes the local entry to disappear. Failure to create a DNS record for the **api.<cluster\_name>.<domain>** domain name in the external DNS server prevents worker nodes from joining the cluster.

### Network Time Protocol (NTP)

Each OpenShift Container Platform node in the cluster must have access to an NTP server. OpenShift Container Platform nodes use NTP to synchronize their clocks. For example, cluster nodes use SSL certificates that require validation, which might fail if the date and time between the nodes are not in sync.



### IMPORTANT

Define a consistent clock date and time format in each cluster node's BIOS settings, or installation might fail.

### Configure a DHCP server

IBM Cloud Bare Metal (Classic) does not run DHCP on the public or private VLANs. After provisioning IBM Cloud nodes, you must set up a DHCP server for the public VLAN, which corresponds to OpenShift Container Platform's **baremetal** network.



### NOTE

The IP addresses allocated to each node do not need to match the IP addresses allocated by the IBM Cloud Bare Metal (Classic) provisioning system.

See the "Configuring the public subnet" section for details.

### Ensure BMC access privileges

The "Remote management" page for each node on the dashboard contains the node's intelligent platform management interface (IPMI) credentials. The default IPMI privileges prevent the user from

making certain boot target changes. You must change the privilege level to **OPERATOR** so that Ironic can make those changes.

In the `install-config.yaml` file, add the `privilegelevel` parameter to the URLs used to configure each BMC. See the "Configuring the `install-config.yaml` file" section for additional details. For example:

```
ipmi://<IP>:<port>?privilegelevel=OPERATOR
```

Alternatively, contact IBM Cloud support and request that they increase the IPMI privileges to **ADMINISTRATOR** for each node.

### Create bare metal servers

Create bare metal servers in the [IBM Cloud dashboard](#) by navigating to **Create resource** → **Bare Metal Servers for Classic**.

Alternatively, you can create bare metal servers with the `ibmcloud` CLI utility. For example:

```
$ ibmcloud sl hardware create --hostname <SERVERNAME> \
    --domain <DOMAIN> \
    --size <SIZE> \
    --os <OS-TYPE> \
    --datacenter <DC-NAME> \
    --port-speed <SPEED> \
    --billing <BILLING>
```

See [Installing the stand-alone IBM Cloud CLI](#) for details on installing the IBM Cloud CLI.



#### NOTE

IBM Cloud servers might take 3-5 hours to become available.

## 14.2. SETTING UP THE ENVIRONMENT FOR AN OPENSIFT CONTAINER PLATFORM INSTALLATION

### 14.2.1. Preparing the provisioner node on IBM Cloud Bare Metal (Classic) infrastructure

Perform the following steps to prepare the provisioner node.

#### Procedure

1. Log in to the provisioner node via `ssh`.
2. Create a non-root user (`kni`) and provide that user with `sudo` privileges:

```
# useradd kni
```

```
# passwd kni
```

```
# echo "kni ALL=(root) NOPASSWD:ALL" | tee -a /etc/sudoers.d/kni
```

```
# chmod 0440 /etc/sudoers.d/kni
```

- 
- 3. Create an **ssh** key for the new user:

```
# su - kni -c "ssh-keygen -f /home/kni/.ssh/id_rsa -N ""
```

- 4. Log in as the new user on the provisioner node:

```
# su - kni
```

- 5. Use Red Hat Subscription Manager to register the provisioner node:

```
$ sudo subscription-manager register --username=<user> --password=<pass> --auto-attach
```

```
$ sudo subscription-manager repos --enable=rhel-8-for-x86_64-appstream-rpms \
--enable=rhel-8-for-x86_64-baseos-rpms
```



#### NOTE

For more information about Red Hat Subscription Manager, see [Using and Configuring Red Hat Subscription Manager](#).

- 6. Install the following packages:

```
$ sudo dnf install -y libvirt qemu-kvm mkisofs python3-devel jq ipmitool
```

- 7. Modify the user to add the **libvirt** group to the newly created user:

```
$ sudo usermod --append --groups libvirt kni
```

- 8. Start **firewalld**:

```
$ sudo systemctl start firewalld
```

- 9. Enable **firewalld**:

```
$ sudo systemctl enable firewalld
```

- 10. Start the **http** service:

```
$ sudo firewall-cmd --zone=public --add-service=http --permanent
```

```
$ sudo firewall-cmd --reload
```

- 11. Start and enable the **libvirtd** service:

```
$ sudo systemctl enable libvirtd --now
```

- 12. Set the ID of the provisioner node:

```
$ PRVN_HOST_ID=<ID>
```

You can view the ID with the following **ibmcloud** command:

```
$ ibmcloud sl hardware list
```

13. Set the ID of the public subnet:

```
$ PUBLICSUBNETID=<ID>
```

You can view the ID with the following **ibmcloud** command:

```
$ ibmcloud sl subnet list
```

14. Set the ID of the private subnet:

```
$ PRIVSUBNETID=<ID>
```

You can view the ID with the following **ibmcloud** command:

```
$ ibmcloud sl subnet list
```

15. Set the provisioner node public IP address:

```
$ PRVN_PUB_IP=$(ibmcloud sl hardware detail $PRVN_HOST_ID --output JSON | jq  
.primaryIpAddress -r)
```

16. Set the CIDR for the public network:

```
$ PUBLICCIDR=$(ibmcloud sl subnet detail $PUBLICSUBNETID --output JSON | jq .cidr)
```

17. Set the IP address and CIDR for the public network:

```
$ PUB_IP_CIDR=$PRVN_PUB_IP/$PUBLICCIDR
```

18. Set the gateway for the public network:

```
$ PUB_GATEWAY=$(ibmcloud sl subnet detail $PUBLICSUBNETID --output JSON | jq  
.gateway -r)
```

19. Set the private IP address of the provisioner node:

```
$ PRVN_PRIV_IP=$(ibmcloud sl hardware detail $PRVN_HOST_ID --output JSON | \  
jq .primaryBackendIpAddress -r)
```

20. Set the CIDR for the private network:

```
$ PRIVCIDR=$(ibmcloud sl subnet detail $PRIVSUBNETID --output JSON | jq .cidr)
```

21. Set the IP address and CIDR for the private network:

```
$ PRIV_IP_CIDR=$PRVN_PRIV_IP/$PRIVCIDR
```

22. Set the gateway for the private network:

```
$ PRIV_GATEWAY=$(ibmcloud sl subnet detail $PRIVSUBNETID --output JSON | jq
.gateway -r)
```

23. Set up the bridges for the **baremetal** and **provisioning** networks:

```
$ sudo nohup bash -c "
  nmcli --get-values UUID con show | xargs -n 1 nmcli con delete
  nmcli connection add ifname provisioning type bridge con-name provisioning
  nmcli con add type bridge-slave ifname eth1 master provisioning
  nmcli connection add ifname baremetal type bridge con-name baremetal
  nmcli con add type bridge-slave ifname eth2 master baremetal
  nmcli connection modify baremetal ipv4.addresses $PUB_IP_CIDR ipv4.method manual
  ipv4.gateway $PUB_GATEWAY
  nmcli connection modify provisioning ipv4.addresses 172.22.0.1/24,$PRIV_IP_CIDR
  ipv4.method manual
  nmcli connection modify provisioning +ipv4.routes \"10.0.0.0/8 $PRIV_GATEWAY\"
  nmcli con down baremetal
  nmcli con up baremetal
  nmcli con down provisioning
  nmcli con up provisioning
  init 6
"
```



#### NOTE

For **eth1** and **eth2**, substitute the appropriate interface name, as needed.

24. If required, SSH back into the **provisioner** node:

```
# ssh kni@provisioner.<cluster-name>.<domain>
```

25. Verify the connection bridges have been properly created:

```
$ sudo nmcli con show
```

#### Example output

```
NAME                UUID                                TYPE  DEVICE
baremetal           4d5133a5-8351-4bb9-bfd4-3af264801530 bridge baremetal
provisioning        43942805-017f-4d7d-a2c2-7cb3324482ed bridge provisioning
virbr0              d9bca40f-eee1-410b-8879-a2d4bb0465e7 bridge virbr0
bridge-slave-eth1  76a8ed50-c7e5-4999-b4f6-6d9014dd0812 ethernet eth1
bridge-slave-eth2  f31c3353-54b7-48de-893a-02d2b34c4736 ethernet eth2
```

26. Create a **pull-secret.txt** file:

```
$ vim pull-secret.txt
```

In a web browser, navigate to [Install on Bare Metal with user-provisioned infrastructure](#). In step 1, click **Download pull secret**. Paste the contents into the **pull-secret.txt** file and save the contents in the **kni** user's home directory.

## 14.2.2. Configuring the public subnet

All of the OpenShift Container Platform cluster nodes must be on the public subnet. IBM Cloud® Bare Metal (Classic) does not provide a DHCP server on the subnet. Set it up separately on the provisioner node.

You must reset the BASH variables defined when preparing the provisioner node. Rebooting the provisioner node after preparing it will delete the BASH variables previously set.

### Procedure

1. Install **dnsmasq**:

```
$ sudo dnf install dnsmasq
```

2. Open the **dnsmasq** configuration file:

```
$ sudo vi /etc/dnsmasq.conf
```

3. Add the following configuration to the **dnsmasq** configuration file:

```
interface=baremetal
except-interface=lo
bind-dynamic
log-dhcp

dhcp-range=<ip_addr>,<ip_addr>,<pub_cidr> 1
dhcp-option=baremetal,121,0.0.0.0/0,<pub_gateway>,<prvn_priv_ip>,<prvn_pub_ip> 2
dhcp-hostsfile=/var/lib/dnsmasq/dnsmasq.hostsfile
```

- 1 Set the DHCP range. Replace both instances of **<ip\_addr>** with one unused IP address from the public subnet so that the **dhcp-range** for the **baremetal** network begins and ends with the same the IP address. Replace **<pub\_cidr>** with the CIDR of the public subnet.
- 2 Set the DHCP option. Replace **<pub\_gateway>** with the IP address of the gateway for the **baremetal** network. Replace **<prvn\_priv\_ip>** with the IP address of the provisioner node's private IP address on the **provisioning** network. Replace **<prvn\_pub\_ip>** with the IP address of the provisioner node's public IP address on the **baremetal** network.

To retrieve the value for **<pub\_cidr>**, execute:

```
$ ibmcloud sl subnet detail <publicsubnetid> --output JSON | jq .cidr
```

Replace **<publicsubnetid>** with the ID of the public subnet.

To retrieve the value for **<pub\_gateway>**, execute:

```
$ ibmcloud sl subnet detail <publicsubnetid> --output JSON | jq .gateway -r
```

Replace **<publicsubnetid>** with the ID of the public subnet.

To retrieve the value for `<prvn_priv_ip>`, execute:

```
$ ibmcloud sl hardware detail <id> --output JSON | \
jq .primaryBackendIpAddress -r
```

Replace `<id>` with the ID of the provisioner node.

To retrieve the value for `<prvn_pub_ip>`, execute:

```
$ ibmcloud sl hardware detail <id> --output JSON | jq .primaryIpAddress -r
```

Replace `<id>` with the ID of the provisioner node.

- Obtain the list of hardware for the cluster:

```
$ ibmcloud sl hardware list
```

- Obtain the MAC addresses and IP addresses for each node:

```
$ ibmcloud sl hardware detail <id> --output JSON | \
jq '.networkComponents[] | \
"\(.primaryIpAddress) \(.macAddress)" | grep -v null
```

Replace `<id>` with the ID of the node.

### Example output

```
"10.196.130.144 00:e0:ed:6a:ca:b4"
"141.125.65.215 00:e0:ed:6a:ca:b5"
```

Make a note of the MAC address and IP address of the public network. Make a separate note of the MAC address of the private network, which you will use later in the `install-config.yaml` file. Repeat this procedure for each node until you have all the public MAC and IP addresses for the public **baremetal** network, and the MAC addresses of the private **provisioning** network.

- Add the MAC and IP address pair of the public **baremetal** network for each node into the `dnsmasq.hostsfile` file:

```
$ sudo vim /var/lib/dnsmasq/dnsmasq.hostsfile
```

### Example input

```
00:e0:ed:6a:ca:b5,141.125.65.215,master-0
<mac>,<ip>,master-1
<mac>,<ip>,master-2
<mac>,<ip>,worker-0
<mac>,<ip>,worker-1
...
```

Replace `<mac>`,`<ip>` with the public MAC address and public IP address of the corresponding node name.

- Start **dnsmasq**:

```
$ sudo systemctl start dnsmasq
```

8. Enable **dnsmasq** so that it starts when booting the node:

```
$ sudo systemctl enable dnsmasq
```

9. Verify **dnsmasq** is running:

```
$ sudo systemctl status dnsmasq
```

### Example output

```
● dnsmasq.service - DNS caching server.  
Loaded: loaded (/usr/lib/systemd/system/dnsmasq.service; enabled; vendor preset: disabled)  
Active: active (running) since Tue 2021-10-05 05:04:14 CDT; 49s ago  
Main PID: 3101 (dnsmasq)  
Tasks: 1 (limit: 204038)  
Memory: 732.0K  
CGroup: /system.slice/dnsmasq.service  
└─3101 /usr/sbin/dnsmasq -k
```

10. Open ports **53** and **67** with UDP protocol:

```
$ sudo firewall-cmd --add-port 53/udp --permanent
```

```
$ sudo firewall-cmd --add-port 67/udp --permanent
```

11. Add **provisioning** to the external zone with masquerade:

```
$ sudo firewall-cmd --change-zone=provisioning --zone=external --permanent
```

This step ensures network address translation for IPMI calls to the management subnet.

12. Reload the **firewalld** configuration:

```
$ sudo firewall-cmd --reload
```

### 14.2.3. Retrieving the OpenShift Container Platform installer

Use the **stable-4.x** version of the installer to deploy the generally available stable version of OpenShift Container Platform:

```
$ export VERSION=stable-4.10  
export RELEASE_IMAGE=$(curl -s https://mirror.openshift.com/pub/openshift-  
v4/clients/ocp/$VERSION/release.txt | grep 'Pull From: quay.io' | awk -F ' ' '{print $3}')
```

### 14.2.4. Extracting the OpenShift Container Platform installer

After retrieving the installer, the next step is to extract it.

#### Procedure



1. Set the environment variables:

```
$ export cmd=openshift-baremetal-install
```

```
$ export pullsecret_file=~/.pull-secret.txt
```

```
$ export extract_dir=$(pwd)
```

2. Get the **oc** binary:

```
$ curl -s https://mirror.openshift.com/pub/openshift-v4/clients/ocp/$VERSION/openshift-client-linux.tar.gz | tar zxvf - oc
```

3. Extract the installer:

```
$ sudo cp oc /usr/local/bin
```

```
$ oc adm release extract --registry-config "${pullsecret_file}" --command=$cmd --to "${extract_dir}" ${RELEASE_IMAGE}
```

```
$ sudo cp openshift-baremetal-install /usr/local/bin
```

### 14.2.5. Configuring the `install-config.yaml` file

The **install-config.yaml** file requires some additional details. Most of the information is teaching the installer and the resulting cluster enough about the available IBM Cloud® Bare Metal (Classic) hardware so that it is able to fully manage it. The material difference between installing on bare metal and installing on IBM Cloud Bare Metal (Classic) is that you must explicitly set the privilege level for IPMI in the BMC section of the **install-config.yaml** file.

#### Procedure

1. Configure **install-config.yaml**. Change the appropriate variables to match the environment, including **pullSecret** and **sshKey**.

```
apiVersion: v1
baseDomain: <domain>
metadata:
  name: <cluster_name>
networking:
  machineNetwork:
    - cidr: <public-cidr>
    networkType: OVNKubernetes
compute:
  - name: worker
    replicas: 2
controlPlane:
  name: master
  replicas: 3
  platform:
    baremetal: {}
platform:
```

```

baremetal:
  apiVIP: <api_ip>
  ingressVIP: <wildcard_ip>
  provisioningNetworkInterface: <NIC1>
  provisioningNetworkCIDR: <CIDR>
  hosts:
    - name: openshift-master-0
      role: master
      bmc:
        address: ipmi://10.196.130.145?privilegelevel=OPERATOR 1
        username: root
        password: <password>
        bootMACAddress: 00:e0:ed:6a:ca:b4 2
        rootDeviceHints:
          deviceName: "/dev/sda"
    - name: openshift-worker-0
      role: worker
      bmc:
        address: ipmi://<out-of-band-ip>?privilegelevel=OPERATOR 3
        username: <user>
        password: <password>
        bootMACAddress: <NIC1_mac_address> 4
        rootDeviceHints:
          deviceName: "/dev/sda"
  pullSecret: '<pull_secret>'
  sshKey: '<ssh_pub_key>'

```

**1 3** The **bmc.address** provides a **privilegelevel** configuration setting with the value set to **OPERATOR**. This is required for IBM Cloud Bare Metal (Classic) infrastructure.

**2 4** Add the MAC address of the private **provisioning** network NIC for the corresponding node.



## NOTE

You can use the **ibmcloud** command-line utility to retrieve the password.

```

$ ibmcloud sl hardware detail <id> --output JSON | \
  jq ""(.networkManagementIpAddress)
  (.remoteManagementAccounts[0].password)""

```

Replace **<id>** with the ID of the node.

2. Create a directory to store the cluster configuration:

```
$ mkdir ~/clusterconfigs
```

3. Copy the **install-config.yaml** file into the directory:

```
$ cp install-config.yaml ~/clusterconfig
```

4. Ensure all bare metal nodes are powered off prior to installing the OpenShift Container Platform cluster:

```
$ ipmitool -I lanplus -U <user> -P <password> -H <management_server_ip> power off
```

- Remove old bootstrap resources if any are left over from a previous deployment attempt:

```
for i in $(sudo virsh list | tail -n +3 | grep bootstrap | awk {'print $2'});
do
  sudo virsh destroy $i;
  sudo virsh undefine $i;
  sudo virsh vol-delete $i --pool $i;
  sudo virsh vol-delete $i.ign --pool $i;
  sudo virsh pool-destroy $i;
  sudo virsh pool-undefine $i;
done
```

### 14.2.6. Additional install-config parameters

See the following tables for the required parameters, the **hosts** parameter, and the **bmc** parameter for the **install-config.yaml** file.

Table 14.2. Required parameters

Parameters	Default	Description
<b>baseDomain</b>		The domain name for the cluster. For example, <b>example.com</b> .
<b>bootMode</b>	<b>UEFI</b>	The boot mode for a node. Options are <b>legacy</b> , <b>UEFI</b> , and <b>UEFISecureBoot</b> . If <b>bootMode</b> is not set, Ironic sets it while inspecting the node.
<b>sshKey</b>		The <b>sshKey</b> configuration setting contains the key in the <code>~/.ssh/id_rsa.pub</code> file required to access the control plane nodes and worker nodes. Typically, this key is from the <b>provisioner</b> node.
<b>pullSecret</b>		The <b>pullSecret</b> configuration setting contains a copy of the pull secret downloaded from the <a href="#">Install OpenShift on Bare Metal</a> page when preparing the provisioner node.
<pre>metadata:   name:</pre>		The name to be given to the OpenShift Container Platform cluster. For example, <b>openshift</b> .

Parameters	Default	Description
<pre>networking:   machineNetwork:     - cidr:</pre>		The public CIDR (Classless Inter-Domain Routing) of the external network. For example, <b>10.0.0.0/24</b> .
<pre>compute:   - name: worker</pre>		The OpenShift Container Platform cluster requires a name be provided for worker (or compute) nodes even if there are zero nodes.
<pre>compute:   replicas: 2</pre>		Replicas sets the number of worker (or compute) nodes in the OpenShift Container Platform cluster.
<pre>controlPlane:   name: master</pre>		The OpenShift Container Platform cluster requires a name for control plane (master) nodes.
<pre>controlPlane:   replicas: 3</pre>		Replicas sets the number of control plane (master) nodes included as part of the OpenShift Container Platform cluster.
<b>provisioningNetworkInterface</b>		The name of the network interface on nodes connected to the provisioning network. For OpenShift Container Platform 4.9 and later releases, use the <b>bootMACAddress</b> configuration setting to enable Ironic to identify the IP address of the NIC instead of using the <b>provisioningNetworkInterface</b> configuration setting to identify the name of the NIC.
<b>defaultMachinePlatform</b>		The default configuration used for machine pools without a platform configuration.

Parameters	Default	Description
<b>apiVIP</b>		<p>(Optional) The virtual IP address for Kubernetes API communication.</p> <p>This setting must either be provided in the <b>install-config.yaml</b> file as a reserved IP from the MachineNetwork or pre-configured in the DNS so that the default name resolves correctly. Use the virtual IP address and not the FQDN when adding a value to the <b>apiVIP</b> configuration setting in the <b>install-config.yaml</b> file. The IP address must be from the primary IPv4 network when using dual stack networking. If not set, the installer uses <b>api.&lt;cluster_name&gt;.&lt;base_domain&gt;</b> to derive the IP address from the DNS.</p>
<b>disableCertificateVerification</b>	<b>False</b>	<p><b>redfish</b> and <b>redfish-virtualmedia</b> need this parameter to manage BMC addresses. The value should be <b>True</b> when using a self-signed certificate for BMC addresses.</p>
<b>ingressVIP</b>		<p>(Optional) The virtual IP address for ingress traffic.</p> <p>This setting must either be provided in the <b>install-config.yaml</b> file as a reserved IP from the MachineNetwork or pre-configured in the DNS so that the default name resolves correctly. Use the virtual IP address and not the FQDN when adding a value to the <b>ingressVIP</b> configuration setting in the <b>install-config.yaml</b> file. The IP address must be from the primary IPv4 network when using dual stack networking. If not set, the installer uses <b>test.apps.&lt;cluster_name&gt;.&lt;base_domain&gt;</b> to derive the IP address from the DNS.</p>

Table 14.3. Optional Parameters

Parameters	Default	Description
<b>provisioningDHCPRange</b>	<b>172.22.0.10,172.22.0.100</b>	Defines the IP range for nodes on the provisioning network.
<b>provisioningNetworkCIDR</b>	<b>172.22.0.0/24</b>	The CIDR for the network to use for provisioning. This option is required when not using the default address range on the provisioning network.
<b>clusterProvisioningIP</b>	The third IP address of the <b>provisioningNetworkCIDR</b> .	The IP address within the cluster where the provisioning services run. Defaults to the third IP address of the provisioning subnet. For example, <b>172.22.0.3</b> .
<b>bootstrapProvisioningIP</b>	The second IP address of the <b>provisioningNetworkCIDR</b> .	The IP address on the bootstrap VM where the provisioning services run while the installer is deploying the control plane (master) nodes. Defaults to the second IP address of the provisioning subnet. For example, <b>172.22.0.2</b> or <b>2620:52:0:1307::2</b> .
<b>externalBridge</b>	<b>baremetal</b>	The name of the bare-metal bridge of the hypervisor attached to the bare-metal network.
<b>provisioningBridge</b>	<b>provisioning</b>	The name of the provisioning bridge on the <b>provisioner</b> host attached to the provisioning network.
<b>defaultMachinePlatform</b>		The default configuration used for machine pools without a platform configuration.
<b>bootstrapOSImage</b>		A URL to override the default operating system image for the bootstrap node. The URL must contain a SHA-256 hash of the image. For example: <a href="https://mirror.openshift.com/rhcos-&lt;version&gt;-qemu.qcow2.gz?sha256=&lt;uncompressed_sha256&gt;">https://mirror.openshift.com/rhcos-&lt;version&gt;-qemu.qcow2.gz?sha256=&lt;uncompressed_sha256&gt;</a> .

Parameters	Default	Description
<b>provisioningNetwork</b>		<p>The <b>provisioningNetwork</b> configuration setting determines whether the cluster uses the provisioning network. If it does, the configuration setting also determines if the cluster manages the network.</p> <p><b>Disabled:</b> Set this parameter to <b>Disabled</b> to disable the requirement for a provisioning network. When set to <b>Disabled</b>, you must only use virtual media based provisioning, or bring up the cluster using the assisted installer. If <b>Disabled</b> and using power management, BMCs must be accessible from the bare-metal network. If <b>Disabled</b>, you must provide two IP addresses on the bare-metal network that are used for the provisioning services.</p> <p><b>Managed:</b> Set this parameter to <b>Managed</b>, which is the default, to fully manage the provisioning network, including DHCP, TFTP, and so on.</p> <p><b>Unmanaged:</b> Set this parameter to <b>Unmanaged</b> to enable the provisioning network but take care of manual configuration of DHCP. Virtual media provisioning is recommended but PXE is still available if required.</p>
<b>httpProxy</b>		Set this parameter to the appropriate HTTP proxy used within your environment.
<b>httpsProxy</b>		Set this parameter to the appropriate HTTPS proxy used within your environment.
<b>noProxy</b>		Set this parameter to the appropriate list of exclusions for proxy usage within your environment.

## Hosts

The **hosts** parameter is a list of separate bare metal assets used to build the cluster.

Table 14.4. Hosts

Name	Default	Description
<b>name</b>		The name of the <b>BareMetalHost</b> resource to associate with the details. For example, <b>openshift-master-0</b> .
<b>role</b>		The role of the bare metal node. Either <b>master</b> or <b>worker</b> .
<b>bmc</b>		Connection details for the baseboard management controller. See the BMC addressing section for additional details.

Name	Default	Description
<b>bootMACAddress</b>		<p>The MAC address of the NIC that the host uses for the provisioning network. Ironic retrieves the IP address using the <b>bootMACAddress</b> configuration setting. Then, it binds to the host.</p> <div style="display: flex; align-items: flex-start;">  <div> <p><b>NOTE</b></p> <p>You must provide a valid MAC address from the host if you disabled the provisioning network.</p> </div> </div>
<b>networkConfig</b>		<p>Set this optional parameter to configure the network interface of a host. See "(Optional) Configuring host network interfaces" for additional details.</p>

### 14.2.7. Root device hints

The **rootDeviceHints** parameter enables the installer to provision the Red Hat Enterprise Linux CoreOS (RHCOS) image to a particular device. The installer examines the devices in the order it discovers them, and compares the discovered values with the hint values. The installer uses the first discovered device that matches the hint value. The configuration can combine multiple hints, but a device must match all hints for the installer to select it.

Table 14.5. Subfields

Subfield	Description
<b>deviceName</b>	A string containing a Linux device name like <b>/dev/vda</b> . The hint must match the actual value exactly.
<b>hctl</b>	A string containing a SCSI bus address like <b>0:0:0:0</b> . The hint must match the actual value exactly.
<b>model</b>	A string containing a vendor-specific device identifier. The hint can be a substring of the actual value.
<b>vendor</b>	A string containing the name of the vendor or manufacturer of the device. The hint can be a substring of the actual value.
<b>serialNumber</b>	A string containing the device serial number. The hint must match the actual value exactly.
<b>minSizeGigabytes</b>	An integer representing the minimum size of the device in gigabytes.



Subfield	Description
<b>wwn</b>	A string containing the unique storage identifier. The hint must match the actual value exactly.
<b>wwnWithExtension</b>	A string containing the unique storage identifier with the vendor extension appended. The hint must match the actual value exactly.
<b>wwnVendorExtension</b>	A string containing the unique vendor storage identifier. The hint must match the actual value exactly.
<b>rotational</b>	A boolean indicating whether the device should be a rotating disk (true) or not (false).

### Example usage

```
- name: master-0
  role: master
  bmc:
    address: ipmi://10.10.0.3:6203
    username: admin
    password: redhat
  bootMACAddress: de:ad:be:ef:00:40
  rootDeviceHints:
    deviceName: "/dev/sda"
```

### 14.2.8. Creating the OpenShift Container Platform manifests

1. Create the OpenShift Container Platform manifests.

```
$ ./openshift-baremetal-install --dir ~/clusterconfigs create manifests
```

```
INFO Consuming Install Config from target directory
WARNING Making control-plane schedulable by setting MastersSchedulable to true for Scheduler cluster settings
WARNING Discarding the OpenShift Manifest that was provided in the target directory because its dependencies are dirty and it needs to be regenerated
```

### 14.2.9. Deploying the cluster via the OpenShift Container Platform installer

Run the OpenShift Container Platform installer:

```
$ ./openshift-baremetal-install --dir ~/clusterconfigs --log-level debug create cluster
```

### 14.2.10. Following the installation

During the deployment process, you can check the installation's overall status by issuing the **tail** command to the **.openshift\_install.log** log file in the install directory folder:

```
$ tail -f /path/to/install-dir/.openshift_install.log
```

# CHAPTER 15. INSTALLING WITH Z/VM ON IBM Z AND LINUXONE

## 15.1. PREPARING TO INSTALL WITH Z/VM ON IBM Z AND LINUXONE

### 15.1.1. Prerequisites

- You reviewed details about the [OpenShift Container Platform installation and update](#) processes.
- You read the documentation on [selecting a cluster installation method and preparing it for users](#).

### 15.1.2. Choosing a method to install OpenShift Container Platform with z/VM on IBM Z or LinuxONE

You can install a cluster with z/VM on IBM Z or LinuxONE infrastructure that you provision, by using one of the following methods:

- [Installing a cluster with z/VM on IBM Z and LinuxONE](#) You can install OpenShift Container Platform with z/VM on IBM Z or LinuxONE infrastructure that you provision.
- [Installing a cluster with z/VM on IBM Z and LinuxONE in a restricted network](#) You can install OpenShift Container Platform with z/VM on IBM Z or LinuxONE infrastructure that you provision in a restricted or disconnected network, by using an internal mirror of the installation release content. You can use this method to install a cluster that does not require an active internet connection to obtain the software components. You can also use this installation method to ensure that your clusters only use container images that satisfy your organizational controls on external content.

## 15.2. INSTALLING A CLUSTER WITH Z/VM ON IBM Z AND LINUXONE

In OpenShift Container Platform version 4.10, you can install a cluster on IBM Z or LinuxONE infrastructure that you provision.



### NOTE

While this document refers only to IBM Z, all information in it also applies to LinuxONE.



### IMPORTANT

Additional considerations exist for non-bare metal platforms. Review the information in the [guidelines for deploying OpenShift Container Platform on non-tested platforms](#) before you install an OpenShift Container Platform cluster.

### 15.2.1. Prerequisites

- You reviewed details about the [OpenShift Container Platform installation and update](#) processes.
- You read the documentation on [selecting a cluster installation method and preparing it for users](#).

- Before you begin the installation process, you must clean the installation directory. This ensures that the required installation files are created and updated during the installation process.
- You provisioned [persistent storage using OpenShift Data Foundation](#) or other supported storage protocols for your cluster. To deploy a private image registry, you must set up persistent storage with **ReadWriteMany** access.
- If you use a firewall, you [configured it to allow the sites](#) that your cluster requires access to.

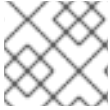
**NOTE**

Be sure to also review this site list if you are configuring a proxy.

## 15.2.2. Internet access for OpenShift Container Platform

In OpenShift Container Platform 4.10, you require access to the internet to install your cluster.

You must have internet access to:

- Access [OpenShift Cluster Manager](#) to download the installation program and perform subscription management. If the cluster has internet access and you do not disable Telemetry, that service automatically entitles your cluster.
- Access [Quay.io](#) to obtain the packages that are required to install your cluster.
- Obtain the packages that are required to perform cluster updates.

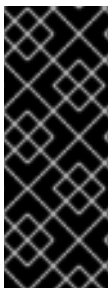
**IMPORTANT**

If your cluster cannot have direct internet access, you can perform a restricted network installation on some types of infrastructure that you provision. During that process, you download the required content and use it to populate a mirror registry with the installation packages. With some installation types, the environment that you install your cluster in will not require internet access. Before you update the cluster, you update the content of the mirror registry.

## 15.2.3. Requirements for a cluster with user-provisioned infrastructure

For a cluster that contains user-provisioned infrastructure, you must deploy all of the required machines.

This section describes the requirements for deploying OpenShift Container Platform on user-provisioned infrastructure.

### 15.2.3.1. Required machines for cluster installation

The smallest OpenShift Container Platform clusters require the following hosts:

**Table 15.1. Minimum required hosts**

Hosts	Description
-------	-------------

Hosts	Description
One temporary bootstrap machine	The cluster requires the bootstrap machine to deploy the OpenShift Container Platform cluster on the three control plane machines. You can remove the bootstrap machine after you install the cluster.
Three control plane machines	The control plane machines run the Kubernetes and OpenShift Container Platform services that form the control plane.
At least two compute machines, which are also known as worker machines.	The workloads requested by OpenShift Container Platform users run on the compute machines.



### IMPORTANT

To improve high availability of your cluster, distribute the control plane machines over different z/VM instances on at least two physical machines.

The bootstrap, control plane, and compute machines must use Red Hat Enterprise Linux CoreOS (RHCOS) as the operating system.

Note that RHCOS is based on Red Hat Enterprise Linux (RHEL) 8 and inherits all of its hardware certifications and requirements. See [Red Hat Enterprise Linux technology capabilities and limits](#) .

#### 15.2.3.2. Minimum resource requirements for cluster installation

Each cluster machine must meet the following minimum requirements:

**Table 15.2. Minimum resource requirements**

Machine	Operating System	vCPU [1]	Virtual RAM	Storage	IOPS
Bootstrap	RHCOS	4	16 GB	100 GB	N/A
Control plane	RHCOS	4	16 GB	100 GB	N/A
Compute	RHCOS	2	8 GB	100 GB	N/A

1. One physical core (IFL) provides two logical cores (threads) when SMT-2 is enabled. The hypervisor can provide two or more vCPUs.

If an instance type for your platform meets the minimum requirements for cluster machines, it is supported to use in OpenShift Container Platform.

#### 15.2.3.3. Minimum IBM Z system environment

You can install OpenShift Container Platform version 4.10 on the following IBM hardware:

- IBM z16 (all models), IBM z15 (all models), IBM z14 (all models), IBM z13, and IBM z13s
- LinuxONE, any version

### Hardware requirements

- The equivalent of six Integrated Facilities for Linux (IFL), which are SMT2 enabled, for each cluster.
- At least one network connection to both connect to the **LoadBalancer** service and to serve data for traffic outside the cluster.



#### NOTE

You can use dedicated or shared IFLs to assign sufficient compute resources. Resource sharing is one of the key strengths of IBM Z. However, you must adjust capacity correctly on each hypervisor layer and ensure sufficient resources for every OpenShift Container Platform cluster.



#### IMPORTANT

Since the overall performance of the cluster can be impacted, the LPARs that are used to setup the OpenShift Container Platform clusters must provide sufficient compute capacity. In this context, LPAR weight management, entitlements, and CPU shares on the hypervisor level play an important role.

### Operating system requirements

- One instance of z/VM 7.2 or later

On your z/VM instance, set up:

- Three guest virtual machines for OpenShift Container Platform control plane machines
- Two guest virtual machines for OpenShift Container Platform compute machines
- One guest virtual machine for the temporary OpenShift Container Platform bootstrap machine

### IBM Z network connectivity requirements

To install on IBM Z under z/VM, you require a single z/VM virtual NIC in layer 2 mode. You also need:

- A direct-attached OSA or RoCE network adapter
- A z/VM VSwitch set up. For a preferred setup, use OSA link aggregation.

### Disk storage for the z/VM guest virtual machines

- FICON attached disk storage (DASDs). These can be z/VM minidisks, fullpack minidisks, or dedicated DASDs, all of which must be formatted as CDL, which is the default. To reach the minimum required DASD size for Red Hat Enterprise Linux CoreOS (RHCOS) installations, you need extended address volumes (EAV). If available, use HyperPAV to ensure optimal performance.
- FCP attached disk storage

### Storage / Main Memory

- 16 GB for OpenShift Container Platform control plane machines
- 8 GB for OpenShift Container Platform compute machines
- 16 GB for the temporary OpenShift Container Platform bootstrap machine

#### 15.2.3.4. Preferred IBM Z system environment

##### Hardware requirements

- Three LPARS that each have the equivalent of six IFLs, which are SMT2 enabled, for each cluster.
- Two network connections to both connect to the **LoadBalancer** service and to serve data for traffic outside the cluster.
- HiperSockets, which are attached to a node either directly as a device or by bridging with one z/VM VSWITCH to be transparent to the z/VM guest. To directly connect HiperSockets to a node, you must set up a gateway to the external network via a RHEL 8 guest to bridge to the HiperSockets network.

##### Operating system requirements

- Two or three instances of z/VM 7.2 or later for high availability

On your z/VM instances, set up:

- Three guest virtual machines for OpenShift Container Platform control plane machines, one per z/VM instance.
- At least six guest virtual machines for OpenShift Container Platform compute machines, distributed across the z/VM instances.
- One guest virtual machine for the temporary OpenShift Container Platform bootstrap machine.
- To ensure the availability of integral components in an overcommitted environment, increase the priority of the control plane by using the CP command **SET SHARE**. Do the same for infrastructure nodes, if they exist. See [SET SHARE](#) in IBM Documentation.

##### IBM Z network connectivity requirements

To install on IBM Z under z/VM, you require a single z/VM virtual NIC in layer 2 mode. You also need:

- A direct-attached OSA or RoCE network adapter
- A z/VM VSwitch set up. For a preferred setup, use OSA link aggregation.

##### Disk storage for the z/VM guest virtual machines

- FICON attached disk storage (DASDs). These can be z/VM minidisks, fullpack minidisks, or dedicated DASDs, all of which must be formatted as CDL, which is the default. To reach the minimum required DASD size for Red Hat Enterprise Linux CoreOS (RHCOS) installations, you need extended address volumes (EAV). If available, use HyperPAV and High Performance FICON (zHPF) to ensure optimal performance.
- FCP attached disk storage

##### Storage / Main Memory

- 16 GB for OpenShift Container Platform control plane machines

- 16 GB for OpenShift Container Platform control plane machines
- 8 GB for OpenShift Container Platform compute machines
- 16 GB for the temporary OpenShift Container Platform bootstrap machine

### 15.2.3.5. Certificate signing requests management

Because your cluster has limited access to automatic machine management when you use infrastructure that you provision, you must provide a mechanism for approving cluster certificate signing requests (CSRs) after installation. The **kube-controller-manager** only approves the kubelet client CSRs. The **machine-approver** cannot guarantee the validity of a serving certificate that is requested by using kubelet credentials because it cannot confirm that the correct machine issued the request. You must determine and implement a method of verifying the validity of the kubelet serving certificate requests and approving them.

#### Additional resources

- See [Bridging a HiperSockets LAN with a z/VM Virtual Switch](#) in IBM Documentation.
- See [Scaling HyperPAV alias devices on Linux guests on z/VM](#) for performance optimization.
- See [Topics in LPAR performance](#) for LPAR weight management and entitlements.
- [Recommended host practices for IBM Z & LinuxONE environments](#)

### 15.2.3.6. Networking requirements for user-provisioned infrastructure

All the Red Hat Enterprise Linux CoreOS (RHCOS) machines require networking to be configured in **initramfs** during boot to fetch their Ignition config files.

During the initial boot, the machines require an HTTP or HTTPS server to establish a network connection to download their Ignition config files.

The machines are configured with static IP addresses. No DHCP server is required. Ensure that the machines have persistent IP addresses and hostnames.

The Kubernetes API server must be able to resolve the node names of the cluster machines. If the API servers and worker nodes are in different zones, you can configure a default DNS search zone to allow the API server to resolve the node names. Another supported approach is to always refer to hosts by their fully-qualified domain names in both the node objects and all DNS requests.

#### 15.2.3.6.1. Network connectivity requirements

You must configure the network connectivity between machines to allow OpenShift Container Platform cluster components to communicate. Each machine must be able to resolve the hostnames of all other machines in the cluster.

This section provides details about the ports that are required.



#### IMPORTANT

In connected OpenShift Container Platform environments, all nodes are required to have internet access to pull images for platform containers and provide telemetry data to Red Hat.



Table 15.3. Ports used for all-machine to all-machine communications

Protocol	Port	Description
ICMP	N/A	Network reachability tests
TCP	<b>1936</b>	Metrics
	<b>9000-9999</b>	Host level services, including the node exporter on ports <b>9100-9101</b> and the Cluster Version Operator on port <b>9099</b> .
	<b>10250-10259</b>	The default ports that Kubernetes reserves
	<b>10256</b>	openshift-sdn
UDP	<b>4789</b>	VXLAN
	<b>6081</b>	Geneve
	<b>9000-9999</b>	Host level services, including the node exporter on ports <b>9100-9101</b> .
	<b>500</b>	IPsec IKE packets
	<b>4500</b>	IPsec NAT-T packets
TCP/UDP	<b>30000-32767</b>	Kubernetes node port
ESP	N/A	IPsec Encapsulating Security Payload (ESP)

Table 15.4. Ports used for all-machine to control plane communications

Protocol	Port	Description
TCP	<b>6443</b>	Kubernetes API

Table 15.5. Ports used for control plane machine to control plane machine communications

Protocol	Port	Description
TCP	<b>2379-2380</b>	etcd server and peer ports

### NTP configuration for user-provisioned infrastructure

OpenShift Container Platform clusters are configured to use a public Network Time Protocol (NTP) server by default. If you want to use a local enterprise NTP server, or if your cluster is being deployed in a disconnected network, you can configure the cluster to use a specific time server. For more information, see the documentation for *Configuring chrony time service*.

## Additional resources

- [Configuring chrony time service](#)

### 15.2.3.7. User-provisioned DNS requirements

In OpenShift Container Platform deployments, DNS name resolution is required for the following components:

- The Kubernetes API
- The OpenShift Container Platform application wildcard
- The bootstrap, control plane, and compute machines

Reverse DNS resolution is also required for the Kubernetes API, the bootstrap machine, the control plane machines, and the compute machines.

DNS A/AAAA or CNAME records are used for name resolution and PTR records are used for reverse name resolution. The reverse records are important because Red Hat Enterprise Linux CoreOS (RHCOS) uses the reverse records to set the hostnames for all the nodes, unless the hostnames are provided by DHCP. Additionally, the reverse records are used to generate the certificate signing requests (CSR) that OpenShift Container Platform needs to operate.

The following DNS records are required for a user-provisioned OpenShift Container Platform cluster and they must be in place before installation. In each record, **<cluster\_name>** is the cluster name and **<base\_domain>** is the base domain that you specify in the **install-config.yaml** file. A complete DNS record takes the form: **<component>.<cluster\_name>.<base\_domain>.**

**Table 15.6. Required DNS records**

Component	Record	Description
Kubernetes API	<b>api.&lt;cluster_name&gt;.&lt;base_domain&gt;.</b>	A DNS A/AAAA or CNAME record, and a DNS PTR record, to identify the API load balancer. These records must be resolvable by both clients external to the cluster and from all the nodes within the cluster.
	<b>api-int.&lt;cluster_name&gt;.&lt;base_domain&gt;.</b>	A DNS A/AAAA or CNAME record, and a DNS PTR record, to internally identify the API load balancer. These records must be resolvable from all the nodes within the cluster.
		 <p><b>IMPORTANT</b></p> <p>The API server must be able to resolve the worker nodes by the hostnames that are recorded in Kubernetes. If the API server cannot resolve the node names, then proxied API calls can fail, and you cannot retrieve logs from pods.</p>

Component	Record	Description
Routes	<b>*.apps.&lt;cluster_name&gt;.&lt;base_domain&gt;.</b>	<p>A wildcard DNS A/AAAA or CNAME record that refers to the application ingress load balancer. The application ingress load balancer targets the machines that run the Ingress Controller pods. The Ingress Controller pods run on the compute machines by default. These records must be resolvable by both clients external to the cluster and from all the nodes within the cluster.</p> <p>For example, <b>console-openshift-console.apps.&lt;cluster_name&gt;.&lt;base_domain&gt;</b> is used as a wildcard route to the OpenShift Container Platform console.</p>
Bootstrap machine	<b>bootstrap.&lt;cluster_name&gt;.&lt;base_domain&gt;.</b>	A DNS A/AAAA or CNAME record, and a DNS PTR record, to identify the bootstrap machine. These records must be resolvable by the nodes within the cluster.
Control plane machines	<b>&lt;master&gt;&lt;n&gt;.&lt;cluster_name&gt;.&lt;base_domain&gt;.</b>	DNS A/AAAA or CNAME records and DNS PTR records to identify each machine for the control plane nodes. These records must be resolvable by the nodes within the cluster.
Compute machines	<b>&lt;worker&gt;&lt;n&gt;.&lt;cluster_name&gt;.&lt;base_domain&gt;.</b>	DNS A/AAAA or CNAME records and DNS PTR records to identify each machine for the worker nodes. These records must be resolvable by the nodes within the cluster.



## NOTE

In OpenShift Container Platform 4.4 and later, you do not need to specify etcd host and SRV records in your DNS configuration.

## TIP

You can use the **dig** command to verify name and reverse name resolution. See the section on *Validating DNS resolution for user-provisioned infrastructure* for detailed validation steps.

### 15.2.3.7.1. Example DNS configuration for user-provisioned clusters

This section provides A and PTR record configuration samples that meet the DNS requirements for deploying OpenShift Container Platform on user-provisioned infrastructure. The samples are not meant to provide advice for choosing one DNS solution over another.

In the examples, the cluster name is **ocp4** and the base domain is **example.com**.

#### Example DNS A record configuration for a user-provisioned cluster

The following example is a BIND zone file that shows sample A records for name resolution in a user-provisioned cluster.

### Example 15.1. Sample DNS zone database

```

$TTL 1W
@ IN SOA ns1.example.com. root (
    2019070700 ; serial
    3H ; refresh (3 hours)
    30M ; retry (30 minutes)
    2W ; expiry (2 weeks)
    1W ) ; minimum (1 week)
IN NS ns1.example.com.
IN MX 10 smtp.example.com.
;
;
;
ns1.example.com. IN A 192.168.1.5
smtp.example.com. IN A 192.168.1.5
;
;
helper.example.com. IN A 192.168.1.5
helper.ocp4.example.com. IN A 192.168.1.5
;
;
api.ocp4.example.com. IN A 192.168.1.5 1
api-int.ocp4.example.com. IN A 192.168.1.5 2
;
;
*.apps.ocp4.example.com. IN A 192.168.1.5 3
;
;
bootstrap.ocp4.example.com. IN A 192.168.1.96 4
;
;
master0.ocp4.example.com. IN A 192.168.1.97 5
master1.ocp4.example.com. IN A 192.168.1.98 6
master2.ocp4.example.com. IN A 192.168.1.99 7
;
;
worker0.ocp4.example.com. IN A 192.168.1.11 8
worker1.ocp4.example.com. IN A 192.168.1.7 9
;
;EOF

```

- 1 Provides name resolution for the Kubernetes API. The record refers to the IP address of the API load balancer.
- 2 Provides name resolution for the Kubernetes API. The record refers to the IP address of the API load balancer and is used for internal cluster communications.
- 3 Provides name resolution for the wildcard routes. The record refers to the IP address of the application ingress load balancer. The application ingress load balancer targets the machines that run the Ingress Controller pods. The Ingress Controller pods run on the compute machines by default.

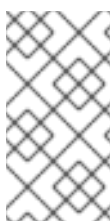

#### NOTE

In the example, the same load balancer is used for the Kubernetes API and application ingress traffic. In production scenarios, you can deploy the API and application ingress load balancers separately so that you can scale the load balancer infrastructure for each in isolation.

- 4 Provides name resolution for the bootstrap machine.
- 5 6 7 Provides name resolution for the control plane machines.
- 8 9 Provides name resolution for the compute machines.

### Example DNS PTR record configuration for a user-provisioned cluster

The following example BIND zone file shows sample PTR records for reverse name resolution in a user-provisioned cluster.

#### Example 15.2. Sample DNS zone database for reverse records

```
$TTL 1W
@ IN SOA ns1.example.com. root (
    2019070700 ; serial
    3H ; refresh (3 hours)
    30M ; retry (30 minutes)
    2W ; expiry (2 weeks)
    1W ) ; minimum (1 week)
IN NS ns1.example.com.
;
5.1.168.192.in-addr.arpa. IN PTR api.ocp4.example.com. 1
5.1.168.192.in-addr.arpa. IN PTR api-int.ocp4.example.com. 2
;
96.1.168.192.in-addr.arpa. IN PTR bootstrap.ocp4.example.com. 3
;
97.1.168.192.in-addr.arpa. IN PTR master0.ocp4.example.com. 4
98.1.168.192.in-addr.arpa. IN PTR master1.ocp4.example.com. 5
99.1.168.192.in-addr.arpa. IN PTR master2.ocp4.example.com. 6
;
11.1.168.192.in-addr.arpa. IN PTR worker0.ocp4.example.com. 7
7.1.168.192.in-addr.arpa. IN PTR worker1.ocp4.example.com. 8
;
;EOF
```

- 1 Provides reverse DNS resolution for the Kubernetes API. The PTR record refers to the record name of the API load balancer.
- 2 Provides reverse DNS resolution for the Kubernetes API. The PTR record refers to the record name of the API load balancer and is used for internal cluster communications.
- 3 Provides reverse DNS resolution for the bootstrap machine.
- 4 5 6 Provides reverse DNS resolution for the control plane machines.
- 7 8 Provides reverse DNS resolution for the compute machines.

**NOTE**

A PTR record is not required for the OpenShift Container Platform application wildcard.

**15.2.3.8. Load balancing requirements for user-provisioned infrastructure**

Before you install OpenShift Container Platform, you must provision the API and application ingress load balancing infrastructure. In production scenarios, you can deploy the API and application ingress load balancers separately so that you can scale the load balancer infrastructure for each in isolation.

**NOTE**

If you want to deploy the API and application Ingress load balancers with a Red Hat Enterprise Linux (RHEL) instance, you must purchase the RHEL subscription separately.

The load balancing infrastructure must meet the following requirements:

1. **API load balancer.** Provides a common endpoint for users, both human and machine, to interact with and configure the platform. Configure the following conditions:
  - Layer 4 load balancing only. This can be referred to as Raw TCP, SSL Passthrough, or SSL Bridge mode. If you use SSL Bridge mode, you must enable Server Name Indication (SNI) for the API routes.
  - A stateless load balancing algorithm. The options vary based on the load balancer implementation.

**IMPORTANT**

Do not configure session persistence for an API load balancer. Configuring session persistence for a Kubernetes API server might cause performance issues from excess application traffic for your OpenShift Container Platform cluster and the Kubernetes API that runs inside the cluster.

Configure the following ports on both the front and back of the load balancers:

**Table 15.7. API load balancer**

Port	Back-end machines (pool members)	Internal	External	Description
<b>6443</b>	Bootstrap and control plane. You remove the bootstrap machine from the load balancer after the bootstrap machine initializes the cluster control plane. You must configure the <b>/readyz</b> endpoint for the API server health check probe.	X	X	Kubernetes API server
<b>22623</b>	Bootstrap and control plane. You remove the bootstrap machine from the load balancer after the bootstrap machine initializes the cluster control plane.	X		Machine config server

**NOTE**

The load balancer must be configured to take a maximum of 30 seconds from the time the API server turns off the **/readyz** endpoint to the removal of the API server instance from the pool. Within the time frame after **/readyz** returns an error or becomes healthy, the endpoint must have been removed or added. Probing every 5 or 10 seconds, with two successful requests to become healthy and three to become unhealthy, are well-tested values.

2. **Application Ingress load balancer.** Provides an ingress point for application traffic flowing in from outside the cluster. A working configuration for the Ingress router is required for an OpenShift Container Platform cluster.

Configure the following conditions:

- Layer 4 load balancing only. This can be referred to as Raw TCP, SSL Passthrough, or SSL Bridge mode. If you use SSL Bridge mode, you must enable Server Name Indication (SNI) for the ingress routes.
- A connection-based or session-based persistence is recommended, based on the options available and types of applications that will be hosted on the platform.

**TIP**

If the true IP address of the client can be seen by the application Ingress load balancer, enabling source IP-based session persistence can improve performance for applications that use end-to-end TLS encryption.

Configure the following ports on both the front and back of the load balancers:

**Table 15.8. Application Ingress load balancer**

Port	Back-end machines (pool members)	Internal	External	Description
<b>443</b>	The machines that run the Ingress Controller pods, compute, or worker, by default.	X	X	HTTPS traffic
<b>80</b>	The machines that run the Ingress Controller pods, compute, or worker, by default.	X	X	HTTP traffic

**NOTE**

If you are deploying a three-node cluster with zero compute nodes, the Ingress Controller pods run on the control plane nodes. In three-node cluster deployments, you must configure your application Ingress load balancer to route HTTP and HTTPS traffic to the control plane nodes.

#### 15.2.3.8.1. Example load balancer configuration for user-provisioned clusters

This section provides an example API and application ingress load balancer configuration that meets the load balancing requirements for user-provisioned clusters. The sample is an **/etc/haproxy/haproxy.cfg** configuration for an HAProxy load balancer. The example is not meant to provide advice for choosing

one load balancing solution over another.

In the example, the same load balancer is used for the Kubernetes API and application ingress traffic. In production scenarios, you can deploy the API and application ingress load balancers separately so that you can scale the load balancer infrastructure for each in isolation.



## NOTE

If you are using HAProxy as a load balancer and SELinux is set to **enforcing**, you must ensure that the HAProxy service can bind to the configured TCP port by running **setsebool -P haproxy\_connect\_any=1**.

### Example 15.3. Sample API and application Ingress load balancer configuration

```

global
  log      127.0.0.1 local2
  pidfile /var/run/haproxy.pid
  maxconn 4000
  daemon
defaults
  mode          http
  log           global
  option        dontlognull
  option http-server-close
  option        redispatch
  retries       3
  timeout http-request 10s
  timeout queue   1m
  timeout connect 10s
  timeout client  1m
  timeout server  1m
  timeout http-keep-alive 10s
  timeout check   10s
  maxconn        3000
listen api-server-6443 1
  bind *:6443
  mode tcp
  server bootstrap bootstrap.ocp4.example.com:6443 check inter 1s backup 2
  server master0 master0.ocp4.example.com:6443 check inter 1s
  server master1 master1.ocp4.example.com:6443 check inter 1s
  server master2 master2.ocp4.example.com:6443 check inter 1s
listen machine-config-server-22623 3
  bind *:22623
  mode tcp
  server bootstrap bootstrap.ocp4.example.com:22623 check inter 1s backup 4
  server master0 master0.ocp4.example.com:22623 check inter 1s
  server master1 master1.ocp4.example.com:22623 check inter 1s
  server master2 master2.ocp4.example.com:22623 check inter 1s
listen ingress-router-443 5
  bind *:443
  mode tcp
  balance source
  server worker0 worker0.ocp4.example.com:443 check inter 1s
  server worker1 worker1.ocp4.example.com:443 check inter 1s

```



```
listen ingress-router-80 6
bind *:80
mode tcp
balance source
server worker0 worker0.ocp4.example.com:80 check inter 1s
server worker1 worker1.ocp4.example.com:80 check inter 1s
```

- 1** Port **6443** handles the Kubernetes API traffic and points to the control plane machines.
- 2** **4** The bootstrap entries must be in place before the OpenShift Container Platform cluster installation and they must be removed after the bootstrap process is complete.
- 3** Port **22623** handles the machine config server traffic and points to the control plane machines.
- 5** Port **443** handles the HTTPS traffic and points to the machines that run the Ingress Controller pods. The Ingress Controller pods run on the compute machines by default.
- 6** Port **80** handles the HTTP traffic and points to the machines that run the Ingress Controller pods. The Ingress Controller pods run on the compute machines by default.



#### NOTE

If you are deploying a three-node cluster with zero compute nodes, the Ingress Controller pods run on the control plane nodes. In three-node cluster deployments, you must configure your application Ingress load balancer to route HTTP and HTTPS traffic to the control plane nodes.

#### TIP

If you are using HAProxy as a load balancer, you can check that the **haproxy** process is listening on ports **6443**, **22623**, **443**, and **80** by running **netstat -nltupe** on the HAProxy node.

### 15.2.4. Preparing the user-provisioned infrastructure

Before you install OpenShift Container Platform on user-provisioned infrastructure, you must prepare the underlying infrastructure.

This section provides details about the high-level steps required to set up your cluster infrastructure in preparation for an OpenShift Container Platform installation. This includes configuring IP networking and network connectivity for your cluster nodes, preparing a web server for the Ignition files, enabling the required ports through your firewall, and setting up the required DNS and load balancing infrastructure.

After preparation, your cluster infrastructure must meet the requirements outlined in the *Requirements for a cluster with user-provisioned infrastructure* section.

#### Prerequisites

- You have reviewed the [OpenShift Container Platform 4.x Tested Integrations](#) page.
- You have reviewed the infrastructure requirements detailed in the *Requirements for a cluster with user-provisioned infrastructure* section.

## Procedure

1. Set up static IP addresses.
2. Set up an HTTP or HTTPS server to provide Ignition files to the cluster nodes.
3. Ensure that your network infrastructure provides the required network connectivity between the cluster components. See the *Networking requirements for user-provisioned infrastructure* section for details about the requirements.
4. Configure your firewall to enable the ports required for the OpenShift Container Platform cluster components to communicate. See *Networking requirements for user-provisioned infrastructure* section for details about the ports that are required.

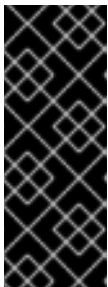

### IMPORTANT

By default, port **1936** is accessible for an OpenShift Container Platform cluster, because each control plane node needs access to this port.

Avoid using the Ingress load balancer to expose this port, because doing so might result in the exposure of sensitive information, such as statistics and metrics, related to Ingress Controllers.

5. Setup the required DNS infrastructure for your cluster.
  - a. Configure DNS name resolution for the Kubernetes API, the application wildcard, the bootstrap machine, the control plane machines, and the compute machines.
  - b. Configure reverse DNS resolution for the Kubernetes API, the bootstrap machine, the control plane machines, and the compute machines.  
See the *User-provisioned DNS requirements* section for more information about the OpenShift Container Platform DNS requirements.
6. Validate your DNS configuration.
  - a. From your installation node, run DNS lookups against the record names of the Kubernetes API, the wildcard routes, and the cluster nodes. Validate that the IP addresses in the responses correspond to the correct components.
  - b. From your installation node, run reverse DNS lookups against the IP addresses of the load balancer and the cluster nodes. Validate that the record names in the responses correspond to the correct components.  
See the *Validating DNS resolution for user-provisioned infrastructure* section for detailed DNS validation steps.
7. Provision the required API and application ingress load balancing infrastructure. See the *Load balancing requirements for user-provisioned infrastructure* section for more information about the requirements.



### NOTE

Some load balancing solutions require the DNS name resolution for the cluster nodes to be in place before the load balancing is initialized.

## 15.2.5. Validating DNS resolution for user-provisioned infrastructure

You can validate your DNS configuration before installing OpenShift Container Platform on user-provisioned infrastructure.



## IMPORTANT

The validation steps detailed in this section must succeed before you install your cluster.

### Prerequisites

- You have configured the required DNS records for your user-provisioned infrastructure.

### Procedure

- From your installation node, run DNS lookups against the record names of the Kubernetes API, the wildcard routes, and the cluster nodes. Validate that the IP addresses contained in the responses correspond to the correct components.
  - Perform a lookup against the Kubernetes API record name. Check that the result points to the IP address of the API load balancer:

```
$ dig +noall +answer @<nameserver_ip> api.<cluster_name>.<base_domain> 1
```

- Replace **<nameserver\_ip>** with the IP address of the nameserver, **<cluster\_name>** with your cluster name, and **<base\_domain>** with your base domain name.

#### Example output

```
api.ocp4.example.com. 0 IN A 192.168.1.5
```

- Perform a lookup against the Kubernetes internal API record name. Check that the result points to the IP address of the API load balancer:

```
$ dig +noall +answer @<nameserver_ip> api-int.<cluster_name>.<base_domain>
```

#### Example output

```
api-int.ocp4.example.com. 0 IN A 192.168.1.5
```

- Test an example **\*.apps.<cluster\_name>.<base\_domain>** DNS wildcard lookup. All of the application wildcard lookups must resolve to the IP address of the application ingress load balancer:

```
$ dig +noall +answer @<nameserver_ip> random.apps.<cluster_name>.<base_domain>
```

#### Example output

```
random.apps.ocp4.example.com. 0 IN A 192.168.1.5
```

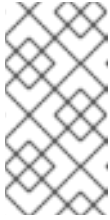
**NOTE**

In the example outputs, the same load balancer is used for the Kubernetes API and application ingress traffic. In production scenarios, you can deploy the API and application ingress load balancers separately so that you can scale the load balancer infrastructure for each in isolation.

You can replace **random** with another wildcard value. For example, you can query the route to the OpenShift Container Platform console:

```
$ dig +noall +answer @<nameserver_ip> console-openshift-console.apps.
<cluster_name>.<base_domain>
```

**Example output**

```
console-openshift-console.apps.ocp4.example.com. 0 IN A 192.168.1.5
```

- d. Run a lookup against the bootstrap DNS record name. Check that the result points to the IP address of the bootstrap node:

```
$ dig +noall +answer @<nameserver_ip> bootstrap.<cluster_name>.<base_domain>
```

**Example output**

```
bootstrap.ocp4.example.com. 0 IN A 192.168.1.96
```

- e. Use this method to perform lookups against the DNS record names for the control plane and compute nodes. Check that the results correspond to the IP addresses of each node.
2. From your installation node, run reverse DNS lookups against the IP addresses of the load balancer and the cluster nodes. Validate that the record names contained in the responses correspond to the correct components.
- a. Perform a reverse lookup against the IP address of the API load balancer. Check that the response includes the record names for the Kubernetes API and the Kubernetes internal API:

```
$ dig +noall +answer @<nameserver_ip> -x 192.168.1.5
```

**Example output**

```
5.1.168.192.in-addr.arpa. 0 IN PTR api-int.ocp4.example.com. 1
5.1.168.192.in-addr.arpa. 0 IN PTR api.ocp4.example.com. 2
```

- 1** Provides the record name for the Kubernetes internal API.
- 2** Provides the record name for the Kubernetes API.

**NOTE**

A PTR record is not required for the OpenShift Container Platform application wildcard. No validation step is needed for reverse DNS resolution against the IP address of the application ingress load balancer.

- b. Perform a reverse lookup against the IP address of the bootstrap node. Check that the result points to the DNS record name of the bootstrap node:

```
$ dig +noall +answer @<nameserver_ip> -x 192.168.1.96
```

**Example output**

```
96.1.168.192.in-addr.arpa. 0 IN PTR bootstrap.ocp4.example.com.
```

- c. Use this method to perform reverse lookups against the IP addresses for the control plane and compute nodes. Check that the results correspond to the DNS record names of each node.

### 15.2.6. Generating a key pair for cluster node SSH access

During an OpenShift Container Platform installation, you can provide an SSH public key to the installation program. The key is passed to the Red Hat Enterprise Linux CoreOS (RHCOS) nodes through their Ignition config files and is used to authenticate SSH access to the nodes. The key is added to the `~/.ssh/authorized_keys` list for the **core** user on each node, which enables password-less authentication.

After the key is passed to the nodes, you can use the key pair to SSH in to the RHCOS nodes as the user **core**. To access the nodes through SSH, the private key identity must be managed by SSH for your local user.

If you want to SSH in to your cluster nodes to perform installation debugging or disaster recovery, you must provide the SSH public key during the installation process. The `./openshift-install gather` command also requires the SSH public key to be in place on the cluster nodes.

**IMPORTANT**

Do not skip this procedure in production environments, where disaster recovery and debugging is required.

**Procedure**

1. If you do not have an existing SSH key pair on your local machine to use for authentication onto your cluster nodes, create one. For example, on a computer that uses a Linux operating system, run the following command:

```
$ ssh-keygen -t ed25519 -N "" -f <path>/<file_name> 1
```

- 1 Specify the path and file name, such as `~/.ssh/id_ed25519`, of the new SSH key. If you have an existing key pair, ensure your public key is in the your `~/.ssh` directory.

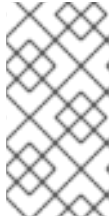
**NOTE**

If you plan to install an OpenShift Container Platform cluster that uses FIPS validated or Modules In Process cryptographic libraries on the **x86\_64** architecture, do not create a key that uses the **ed25519** algorithm. Instead, create a key that uses the **rsa** or **ecdsa** algorithm.

2. View the public SSH key:

```
$ cat <path>/<file_name>.pub
```

For example, run the following to view the `~/.ssh/id_ed25519.pub` public key:

```
$ cat ~/.ssh/id_ed25519.pub
```

3. Add the SSH private key identity to the SSH agent for your local user, if it has not already been added. SSH agent management of the key is required for password-less SSH authentication onto your cluster nodes, or if you want to use the `./openshift-install gather` command.

**NOTE**

On some distributions, default SSH private key identities such as `~/.ssh/id_rsa` and `~/.ssh/id_dsa` are managed automatically.

- a. If the **ssh-agent** process is not already running for your local user, start it as a background task:

```
$ eval "$(ssh-agent -s)"
```

**Example output**

```
Agent pid 31874
```

**NOTE**

If your cluster is in FIPS mode, only use FIPS-compliant algorithms to generate the SSH key. The key must be either RSA or ECDSA.

4. Add your SSH private key to the **ssh-agent**:

```
$ ssh-add <path>/<file_name> 1
```

- 1** Specify the path and file name for your SSH private key, such as `~/.ssh/id_ed25519`

**Example output**

```
Identity added: /home/<you>/<path>/<file_name> (<computer_name>)
```

**Next steps**

- When you install OpenShift Container Platform, provide the SSH public key to the installation program.

### 15.2.7. Obtaining the installation program

Before you install OpenShift Container Platform, download the installation file on your provisioning machine.

#### Prerequisites

- You have a machine that runs Linux, for example Red Hat Enterprise Linux 8, with 500 MB of local disk space

#### Procedure

1. Access the [Infrastructure Provider](#) page on the OpenShift Cluster Manager site. If you have a Red Hat account, log in with your credentials. If you do not, create an account.
2. Select your infrastructure provider.
3. Navigate to the page for your installation type, download the installation program that corresponds with your host operating system and architecture, and place the file in the directory where you will store the installation configuration files.

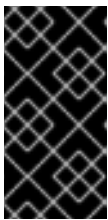

#### IMPORTANT

The installation program creates several files on the computer that you use to install your cluster. You must keep the installation program and the files that the installation program creates after you finish installing the cluster. Both files are required to delete the cluster.

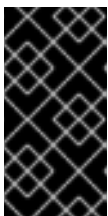

#### IMPORTANT

Deleting the files created by the installation program does not remove your cluster, even if the cluster failed during installation. To remove your cluster, complete the OpenShift Container Platform uninstallation procedures for your specific cloud provider.

4. Extract the installation program. For example, on a computer that uses a Linux operating system, run the following command:

```
$ tar -xvf openshift-install-linux.tar.gz
```

5. Download your installation [pull secret from the Red Hat OpenShift Cluster Manager](#) . This pull secret allows you to authenticate with the services that are provided by the included authorities, including Quay.io, which serves the container images for OpenShift Container Platform components.

### 15.2.8. Installing the OpenShift CLI by downloading the binary

You can install the OpenShift CLI (**oc**) to interact with OpenShift Container Platform from a command-line interface. You can install **oc** on Linux, Windows, or macOS.



## IMPORTANT

If you installed an earlier version of **oc**, you cannot use it to complete all of the commands in OpenShift Container Platform 4.10. Download and install the new version of **oc**.

### Installing the OpenShift CLI on Linux

You can install the OpenShift CLI (**oc**) binary on Linux by using the following procedure.

#### Procedure

1. Navigate to the [OpenShift Container Platform downloads page](#) on the Red Hat Customer Portal.
2. Select the appropriate version in the **Version** drop-down menu.
3. Click **Download Now** next to the **OpenShift v4.10 Linux Client** entry and save the file.
4. Unpack the archive:

```
$ tar xvf <file>
```

5. Place the **oc** binary in a directory that is on your **PATH**.  
To check your **PATH**, execute the following command:

```
$ echo $PATH
```

After you install the OpenShift CLI, it is available using the **oc** command:

```
$ oc <command>
```

### Installing the OpenShift CLI on Windows

You can install the OpenShift CLI (**oc**) binary on Windows by using the following procedure.

#### Procedure

1. Navigate to the [OpenShift Container Platform downloads page](#) on the Red Hat Customer Portal.
2. Select the appropriate version in the **Version** drop-down menu.
3. Click **Download Now** next to the **OpenShift v4.10 Windows Client** entry and save the file.
4. Unzip the archive with a ZIP program.
5. Move the **oc** binary to a directory that is on your **PATH**.  
To check your **PATH**, open the command prompt and execute the following command:

```
C:\> path
```

After you install the OpenShift CLI, it is available using the **oc** command:

```
C:\> oc <command>
```



## Installing the OpenShift CLI on macOS

You can install the OpenShift CLI (**oc**) binary on macOS by using the following procedure.

### Procedure

1. Navigate to the [OpenShift Container Platform downloads page](#) on the Red Hat Customer Portal.
2. Select the appropriate version in the **Version** drop-down menu.
3. Click **Download Now** next to the **OpenShift v4.10 MacOSX Client** entry and save the file.
4. Unpack and unzip the archive.
5. Move the **oc** binary to a directory on your PATH.  
To check your **PATH**, open a terminal and execute the following command:

```
$ echo $PATH
```

After you install the OpenShift CLI, it is available using the **oc** command:

```
$ oc <command>
```

### 15.2.9. Manually creating the installation configuration file

For user-provisioned installations of OpenShift Container Platform, you manually generate your installation configuration file.

#### Prerequisites

- You have an SSH public key on your local machine to provide to the installation program. The key will be used for SSH authentication onto your cluster nodes for debugging and disaster recovery.
- You have obtained the OpenShift Container Platform installation program and the pull secret for your cluster.

#### Procedure

1. Create an installation directory to store your required installation assets in:

```
$ mkdir <installation_directory>
```



#### IMPORTANT

You must create a directory. Some installation assets, like bootstrap X.509 certificates have short expiration intervals, so you must not reuse an installation directory. If you want to reuse individual files from another cluster installation, you can copy them into your directory. However, the file names for the installation assets might change between releases. Use caution when copying installation files from an earlier OpenShift Container Platform version.

2. Customize the sample **install-config.yaml** file template that is provided and save it in the **<installation\_directory>**.

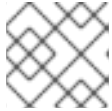
**NOTE**

You must name this configuration file **install-config.yaml**.

**NOTE**

For some platform types, you can alternatively run **./openshift-install create install-config --dir <installation\_directory>** to generate an **install-config.yaml** file. You can provide details about your cluster configuration at the prompts.

3. Back up the **install-config.yaml** file so that you can use it to install multiple clusters.

**IMPORTANT**

The **install-config.yaml** file is consumed during the next step of the installation process. You must back it up now.

### 15.2.9.1. Installation configuration parameters

Before you deploy an OpenShift Container Platform cluster, you provide a customized **install-config.yaml** installation configuration file that describes the details for your environment.

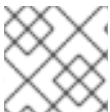
**NOTE**

After installation, you cannot modify these parameters in the **install-config.yaml** file.

#### 15.2.9.1.1. Required configuration parameters

Required installation configuration parameters are described in the following table:

**Table 15.9. Required parameters**

Parameter	Description	Values
<b>apiVersion</b>	The API version for the <b>install-config.yaml</b> content. The current version is <b>v1</b> . The installer may also support older API versions.	String

Parameter	Description	Values
<b>baseDomain</b>	The base domain of your cloud provider. The base domain is used to create routes to your OpenShift Container Platform cluster components. The full DNS name for your cluster is a combination of the <b>baseDomain</b> and <b>metadata.name</b> parameter values that uses the <b>&lt;metadata.name&gt;</b> . <b>&lt;baseDomain&gt;</b> format.	A fully-qualified domain or subdomain name, such as <b>example.com</b> .
<b>metadata</b>	Kubernetes resource <b>ObjectMeta</b> , from which only the <b>name</b> parameter is consumed.	Object
<b>metadata.name</b>	The name of the cluster. DNS records for the cluster are all subdomains of <b>{{.metadata.name}}</b> . <b>{{.baseDomain}}</b> .	String of lowercase letters, hyphens (-), and periods (.), such as <b>dev</b> .
<b>platform</b>	The configuration for the specific platform upon which to perform the installation: <b>alibabacloud</b> , <b>aws</b> , <b>baremetal</b> , <b>azure</b> , <b>gcp</b> , <b>ibmcloud</b> , <b>openstack</b> , <b>ovirt</b> , <b>vsphere</b> , or <b>{}</b> . For additional information about <b>platform.&lt;platform&gt;</b> parameters, consult the table for your specific platform that follows.	Object
<b>pullSecret</b>	Get a <a href="#">pull secret from the Red Hat OpenShift Cluster Manager</a> to authenticate downloading container images for OpenShift Container Platform components from services such as Quay.io.	<pre>{   "auths":{     "cloud.openshift.com":{       "auth":"b3Blb=",       "email":"you@example.com"     },     "quay.io":{       "auth":"b3Blb=",       "email":"you@example.com"     }   } }</pre>

### 15.2.9.1.2. Network configuration parameters

You can customize your installation configuration based on the requirements of your existing network infrastructure. For example, you can expand the IP address block for the cluster network or provide different IP address blocks than the defaults.

Only IPv4 addresses are supported.

Table 15.10. Network parameters

Parameter	Description	Values
<b>networking</b>	The configuration for the cluster network.	Object   <b>NOTE</b> You cannot modify parameters specified by the <b>networking</b> object after installation.
<b>networking.networkType</b>	The cluster network provider Container Network Interface (CNI) plugin to install.	Either <b>OpenShiftSDN</b> or <b>OVNKubernetes</b> . <b>OpenShiftSDN</b> is a CNI provider for all-Linux networks. <b>OVNKubernetes</b> is a CNI provider for Linux networks and hybrid networks that contain both Linux and Windows servers. The default value is <b>OpenShiftSDN</b> .
<b>networking.clusterNetwork</b>	The IP address blocks for pods.  The default value is <b>10.128.0.0/14</b> with a host prefix of <b>/23</b> .  If you specify multiple IP address blocks, the blocks must not overlap.	An array of objects. For example:  <pre>networking:   clusterNetwork:     - cidr: 10.128.0.0/14       hostPrefix: 23</pre>
<b>networking.clusterNetwork.cidr</b>	Required if you use <b>networking.clusterNetwork</b> . An IP address block.  An IPv4 network.	An IP address block in Classless Inter-Domain Routing (CIDR) notation. The prefix length for an IPv4 block is between <b>0</b> and <b>32</b> .
<b>networking.clusterNetwork.hostPrefix</b>	The subnet prefix length to assign to each individual node. For example, if <b>hostPrefix</b> is set to <b>23</b> then each node is assigned a <b>/23</b> subnet out of the given <b>cidr</b> . A <b>hostPrefix</b> value of <b>23</b> provides 510 ( $2^{(32 - 23)} - 2$ ) pod IP addresses.	A subnet prefix.  The default value is <b>23</b> .

Parameter	Description	Values
<b>networking.serviceNetwork</b>	<p>The IP address block for services. The default value is <b>172.30.0.0/16</b>.</p> <p>The OpenShift SDN and OVN-Kubernetes network providers support only a single IP address block for the service network.</p>	<p>An array with an IP address block in CIDR format. For example:</p> <pre>networking:   serviceNetwork:     - 172.30.0.0/16</pre>
<b>networking.machineNetwork</b>	<p>The IP address blocks for machines.</p> <p>If you specify multiple IP address blocks, the blocks must not overlap.</p> <p>If you specify multiple IP kernel arguments, the <b>machineNetwork.cidr</b> value must be the CIDR of the primary network.</p>	<p>An array of objects. For example:</p> <pre>networking:   machineNetwork:     - cidr: 10.0.0.0/16</pre>
<b>networking.machineNetwork.cidr</b>	<p>Required if you use <b>networking.machineNetwork</b>. An IP address block. The default value is <b>10.0.0.0/16</b> for all platforms other than libvirt. For libvirt, the default value is <b>192.168.126.0/24</b>.</p>	<p>An IP network block in CIDR notation.</p> <p>For example, <b>10.0.0.0/16</b>.</p> <div style="display: flex; align-items: flex-start;">  <div> <p><b>NOTE</b></p> <p>Set the <b>networking.machineNetwork</b> to match the CIDR that the preferred NIC resides in.</p> </div> </div>

### 15.2.9.1.3. Optional configuration parameters



Optional installation configuration parameters are described in the following table:

Table 15.11. Optional parameters

Parameter	Description	Values
<b>additionalTrustBundle</b>	<p>A PEM-encoded X.509 certificate bundle that is added to the nodes' trusted certificate store. This trust bundle may also be used when a proxy has been configured.</p>	String



Parameter	Description	Values
<b>cgroupsV2</b>	Enables <a href="#">Linux control groups version 2</a> (cgroups v2) on specific nodes in your cluster. The OpenShift Container Platform process for enabling cgroups v2 disables all cgroup version 1 controllers and hierarchies. The OpenShift Container Platform cgroups version 2 feature is in Developer Preview and is not supported by Red Hat at this time.	<b>true</b>
<b>compute</b>	The configuration for the machines that comprise the compute nodes.	Array of <b>MachinePool</b> objects.
<b>compute.architecture</b>	Determines the instruction set architecture of the machines in the pool. Currently, heterogeneous clusters are not supported, so all pools must specify the same architecture. Valid values are <b>s390x</b> (the default).	String
<b>compute.hyperthreading</b>	Whether to enable or disable simultaneous multithreading, or <b>hyperthreading</b> , on compute machines. By default, simultaneous multithreading is enabled to increase the performance of your machines' cores.   <b>IMPORTANT</b> If you disable simultaneous multithreading, ensure that your capacity planning accounts for the dramatically decreased machine performance.	<b>Enabled</b> or <b>Disabled</b>
<b>compute.name</b>	Required if you use <b>compute</b> . The name of the machine pool.	<b>worker</b>
<b>compute.platform</b>	Required if you use <b>compute</b> . Use this parameter to specify the cloud provider to host the worker machines. This parameter value must match the <b>controlPlane.platform</b> parameter value.	<b>alibabacloud, aws, azure, gcp, ibmcloud, openstack, ovirt, vsphere, or {}</b>

Parameter	Description	Values
<b>compute.replicas</b>	The number of compute machines, which are also known as worker machines, to provision.	A positive integer greater than or equal to <b>2</b> . The default value is <b>3</b> .
<b>controlPlane</b>	The configuration for the machines that comprise the control plane.	Array of <b>MachinePool</b> objects.
<b>controlPlane.architecture</b>	Determines the instruction set architecture of the machines in the pool. Currently, heterogeneous clusters are not supported, so all pools must specify the same architecture. Valid values are <b>s390x</b> (the default).	String
<b>controlPlane.hyperthreading</b>	<p>Whether to enable or disable simultaneous multithreading, or <b>hyperthreading</b>, on control plane machines. By default, simultaneous multithreading is enabled to increase the performance of your machines' cores.</p> <div style="display: flex; align-items: center;">  <div> <p><b>IMPORTANT</b></p> <p>If you disable simultaneous multithreading, ensure that your capacity planning accounts for the dramatically decreased machine performance.</p> </div> </div>	<b>Enabled</b> or <b>Disabled</b>
<b>controlPlane.name</b>	Required if you use <b>controlPlane</b> . The name of the machine pool.	<b>master</b>
<b>controlPlane.platform</b>	Required if you use <b>controlPlane</b> . Use this parameter to specify the cloud provider that hosts the control plane machines. This parameter value must match the <b>compute.platform</b> parameter value.	<b>alibabacloud, aws, azure, gcp, ibmcloud, openstack, ovirt, vsphere</b> , or <b>{}</b>
<b>controlPlane.replicas</b>	The number of control plane machines to provision.	The only supported value is <b>3</b> , which is the default value.

Parameter	Description	Values
<b>credentialsMode</b>	<p>The Cloud Credential Operator (CCO) mode. If no mode is specified, the CCO dynamically tries to determine the capabilities of the provided credentials, with a preference for mint mode on the platforms where multiple modes are supported.</p> <div data-bbox="485 510 595 862" style="border: 1px solid black; padding: 5px; margin-bottom: 10px;">  </div> <p><b>NOTE</b></p> <p>Not all CCO modes are supported for all cloud providers. For more information on CCO modes, see the <i>Cloud Credential Operator</i> entry in the <i>Cluster Operators reference content</i>.</p> <div data-bbox="485 907 595 1258" style="border: 1px solid black; padding: 5px;">  </div> <p><b>NOTE</b></p> <p>If your AWS account has service control policies (SCP) enabled, you must configure the <b>credentialsMode</b> parameter to <b>Mint</b>, <b>Passthrough</b> or <b>Manual</b>.</p>	<b>Mint, Passthrough, Manual</b> or an empty string ("").



Parameter	Description	Values
<b>fips</b>	<p>Enable or disable FIPS mode. The default is <b>false</b> (disabled). If FIPS mode is enabled, the Red Hat Enterprise Linux CoreOS (RHCOS) machines that OpenShift Container Platform runs on bypass the default Kubernetes cryptography suite and use the cryptography modules that are provided with RHCOS instead.</p> <div data-bbox="488 584 592 1361" style="background-color: black; width: 65px; height: 347px; margin-bottom: 10px;"></div> <div data-bbox="671 591 861 618" style="font-weight: bold; margin-bottom: 5px;">IMPORTANT</div> <div data-bbox="671 658 932 1361"> <p>To enable FIPS mode for your cluster, you must run the installation program from a Red Hat Enterprise Linux (RHEL) computer configured to operate in FIPS mode. For more information about configuring FIPS mode on RHEL, see <a href="#">Installing the system in FIPS mode</a>. The use of FIPS validated or Modules In Process cryptographic libraries is only supported on OpenShift Container Platform deployments on the <b>x86_64</b> architecture.</p> </div> <div data-bbox="488 1408 592 1603" style="background-color: black; width: 65px; height: 87px; margin-bottom: 10px;"></div> <div data-bbox="671 1415 762 1442" style="font-weight: bold; margin-bottom: 5px;">NOTE</div> <div data-bbox="671 1482 922 1603"> <p>If you are using Azure File storage, you cannot enable FIPS mode.</p> </div>	<b>false</b> or <b>true</b>
<b>imageContentSources</b>	Sources and repositories for the release-image content.	Array of objects. Includes a <b>source</b> and, optionally, <b>mirrors</b> , as described in the following rows of this table.
<b>imageContentSources.source</b>	Required if you use <b>imageContentSources</b> . Specify the repository that users refer to, for example, in image pull specifications.	String
<b>imageContentSources.mirrors</b>	Specify one or more repositories that may also contain the same images.	Array of strings

Parameter	Description	Values
<b>publish</b>	How to publish or expose the user-facing endpoints of your cluster, such as the Kubernetes API, OpenShift routes.	<p><b>Internal</b> or <b>External</b>. The default value is <b>External</b>.</p> <p>Setting this field to <b>Internal</b> is not supported on non-cloud platforms and IBM Cloud VPC.</p> <div style="display: flex; align-items: flex-start;">  <div> <p><b>IMPORTANT</b></p> <p>If the value of the field is set to <b>Internal</b>, the cluster will become non-functional. For more information, refer to <a href="#">BZ#1953035</a>.</p> </div> </div>
<b>sshKey</b>	<p>The SSH key or keys to authenticate access your cluster machines.</p> <div style="display: flex; align-items: flex-start;">  <div> <p><b>NOTE</b></p> <p>For production OpenShift Container Platform clusters on which you want to perform installation debugging or disaster recovery, specify an SSH key that your <b>ssh-agent</b> process uses.</p> </div> </div>	<p>One or more keys. For example:</p> <pre>sshKey:   &lt;key1&gt;   &lt;key2&gt;   &lt;key3&gt;</pre>

### 15.2.9.2. Sample install-config.yaml file for IBM Z

You can customize the **install-config.yaml** file to specify more details about your OpenShift Container Platform cluster's platform or modify the values of the required parameters.

```
apiVersion: v1
baseDomain: example.com 1
compute: 2
- hyperthreading: Enabled 3
  name: worker
  replicas: 0 4
  architecture : s390x
controlPlane: 5
  hyperthreading: Enabled 6
  name: master
  replicas: 3 7
  architecture : s390x
metadata:
```

```

name: test 8
networking:
  clusterNetwork:
    - cidr: 10.128.0.0/14 9
      hostPrefix: 23 10
  networkType: OpenShiftSDN
  serviceNetwork: 11
    - 172.30.0.0/16
platform:
  none: {} 12
fips: false 13
pullSecret: '{"auths": ...}' 14
sshKey: 'ssh-ed25519 AAAA...' 15

```

- 1** The base domain of the cluster. All DNS records must be sub-domains of this base and include the cluster name.
- 2 5** The **controlPlane** section is a single mapping, but the **compute** section is a sequence of mappings. To meet the requirements of the different data structures, the first line of the **compute** section must begin with a hyphen, -, and the first line of the **controlPlane** section must not. Only one control plane pool is used.
- 3 6** Specifies whether to enable or disable simultaneous multithreading (SMT), or hyperthreading. By default, SMT is enabled to increase the performance of the cores in your machines. You can disable it by setting the parameter value to **Disabled**. If you disable SMT, you must disable it in all cluster machines; this includes both control plane and compute machines.



#### NOTE

Simultaneous multithreading (SMT) is enabled by default. If SMT is not available on your OpenShift Container Platform nodes, the **hyperthreading** parameter has no effect.



#### IMPORTANT

If you disable **hyperthreading**, whether on your OpenShift Container Platform nodes or in the **install-config.yaml** file, ensure that your capacity planning accounts for the dramatically decreased machine performance.

- 4** You must set this value to **0** when you install OpenShift Container Platform on user-provisioned infrastructure. In installer-provisioned installations, the parameter controls the number of compute machines that the cluster creates and manages for you. In user-provisioned installations, you must manually deploy the compute machines before you finish installing the cluster.



#### NOTE

If you are installing a three-node cluster, do not deploy any compute machines when you install the Red Hat Enterprise Linux CoreOS (RHCOS) machines.

- 7** The number of control plane machines that you add to the cluster. Because the cluster uses these values as the number of etcd endpoints in the cluster, the value must match the number of control plane machines that you deploy.

- 8 The cluster name that you specified in your DNS records.
- 9 A block of IP addresses from which pod IP addresses are allocated. This block must not overlap with existing physical networks. These IP addresses are used for the pod network. If you need to access the pods from an external network, you must configure load balancers and routers to manage the traffic.



#### NOTE

Class E CIDR range is reserved for a future use. To use the Class E CIDR range, you must ensure your networking environment accepts the IP addresses within the Class E CIDR range.

- 10 The subnet prefix length to assign to each individual node. For example, if **hostPrefix** is set to **23**, then each node is assigned a **/23** subnet out of the given **cidr**, which allows for 510 ( $2^{(32 - 23)} - 2$ ) pod IP addresses. If you are required to provide access to nodes from an external network, configure load balancers and routers to manage the traffic.
- 11 The IP address pool to use for service IP addresses. You can enter only one IP address pool. This block must not overlap with existing physical networks. If you need to access the services from an external network, configure load balancers and routers to manage the traffic.
- 12 You must set the platform to **none**. You cannot provide additional platform configuration variables for IBM Z infrastructure.



#### IMPORTANT

Clusters that are installed with the platform type **none** are unable to use some features, such as managing compute machines with the Machine API. This limitation applies even if the compute machines that are attached to the cluster are installed on a platform that would normally support the feature. This parameter cannot be changed after installation.

- 13 Whether to enable or disable FIPS mode. By default, FIPS mode is not enabled. If FIPS mode is enabled, the Red Hat Enterprise Linux CoreOS (RHCOS) machines that OpenShift Container Platform runs on bypass the default Kubernetes cryptography suite and use the cryptography modules that are provided with RHCOS instead.



#### IMPORTANT

To enable FIPS mode for your cluster, you must run the installation program from a Red Hat Enterprise Linux (RHEL) computer configured to operate in FIPS mode. For more information about configuring FIPS mode on RHEL, see [Installing the system in FIPS mode](#). The use of FIPS validated or Modules In Process cryptographic libraries is only supported on OpenShift Container Platform deployments on the **x86\_64** architecture.

- 14 The [pull secret from the Red Hat OpenShift Cluster Manager](#) . This pull secret allows you to authenticate with the services that are provided by the included authorities, including Quay.io, which serves the container images for OpenShift Container Platform components.
- 15 The SSH public key for the **core** user in Red Hat Enterprise Linux CoreOS (RHCOS).



## NOTE

For production OpenShift Container Platform clusters on which you want to perform installation debugging or disaster recovery, specify an SSH key that your **ssh-agent** process uses.

### 15.2.9.3. Configuring the cluster-wide proxy during installation

Production environments can deny direct access to the internet and instead have an HTTP or HTTPS proxy available. You can configure a new OpenShift Container Platform cluster to use a proxy by configuring the proxy settings in the **install-config.yaml** file.

#### Prerequisites

- You have an existing **install-config.yaml** file.
- You reviewed the sites that your cluster requires access to and determined whether any of them need to bypass the proxy. By default, all cluster egress traffic is proxied, including calls to hosting cloud provider APIs. You added sites to the **Proxy** object's **spec.noProxy** field to bypass the proxy if necessary.



## NOTE

The **Proxy** object **status.noProxy** field is populated with the values of the **networking.machineNetwork[].cidr**, **networking.clusterNetwork[].cidr**, and **networking.serviceNetwork[]** fields from your installation configuration.

For installations on Amazon Web Services (AWS), Google Cloud Platform (GCP), Microsoft Azure, and Red Hat OpenStack Platform (RHOSP), the **Proxy** object **status.noProxy** field is also populated with the instance metadata endpoint (**169.254.169.254**).

#### Procedure

1. Edit your **install-config.yaml** file and add the proxy settings. For example:

```
apiVersion: v1
baseDomain: my.domain.com
proxy:
  httpProxy: http://<username>:<pswd>@<ip>:<port> 1
  httpsProxy: https://<username>:<pswd>@<ip>:<port> 2
  noProxy: example.com 3
additionalTrustBundle: | 4
  -----BEGIN CERTIFICATE-----
  <MY_TRUSTED_CA_CERT>
  -----END CERTIFICATE-----
...
```

- 1 A proxy URL to use for creating HTTP connections outside the cluster. The URL scheme must be **http**.
- 2 A proxy URL to use for creating HTTPS connections outside the cluster.

- 3 A comma-separated list of destination domain names, IP addresses, or other network CIDRs to exclude from proxying. Preface a domain with `.` to match subdomains only. For
- 4 If provided, the installation program generates a config map that is named **user-ca-bundle** in the **openshift-config** namespace that contains one or more additional CA certificates that are required for proxying HTTPS connections. The Cluster Network Operator then creates a **trusted-ca-bundle** config map that merges these contents with the Red Hat Enterprise Linux CoreOS (RHCOS) trust bundle, and this config map is referenced in the **trustedCA** field of the **Proxy** object. The **additionalTrustBundle** field is required unless the proxy's identity certificate is signed by an authority from the RHCOS trust bundle.

**NOTE**

The installation program does not support the proxy **readinessEndpoints** field.

**NOTE**

If the installer times out, restart and then complete the deployment by using the **wait-for** command of the installer. For example:

```
$ ./openshift-install wait-for install-complete --log-level debug
```

2. Save the file and reference it when installing OpenShift Container Platform.

The installation program creates a cluster-wide proxy that is named **cluster** that uses the proxy settings in the provided **install-config.yaml** file. If no proxy settings are provided, a **cluster Proxy** object is still created, but it will have a nil **spec**.

**NOTE**

Only the **Proxy** object named **cluster** is supported, and no additional proxies can be created.

#### 15.2.9.4. Configuring a three-node cluster

Optionally, you can deploy zero compute machines in a minimal three node cluster that consists of three control plane machines only. This provides smaller, more resource efficient clusters for cluster administrators and developers to use for testing, development, and production.

In three-node OpenShift Container Platform environments, the three control plane machines are schedulable, which means that your application workloads are scheduled to run on them.

#### Prerequisites

- You have an existing **install-config.yaml** file.

#### Procedure

- Ensure that the number of compute replicas is set to **0** in your **install-config.yaml** file, as shown in the following **compute** stanza:

```
compute:
```

```
- name: worker
  platform: {}
  replicas: 0
```



## NOTE

You must set the value of the **replicas** parameter for the compute machines to **0** when you install OpenShift Container Platform on user-provisioned infrastructure, regardless of the number of compute machines you are deploying. In installer-provisioned installations, the parameter controls the number of compute machines that the cluster creates and manages for you. This does not apply to user-provisioned installations, where the compute machines are deployed manually.



## NOTE

The preferred resource for control plane nodes is six vCPUs and 21 GB. For three control plane nodes this is the memory + vCPU equivalent of a minimum five-node cluster. You should back the three nodes, each installed on a 120 GB disk, with three IFLs that are SMT2 enabled. The minimum tested setup is three vCPUs and 10 GB on a 120 GB disk for each control plane node.

For three-node cluster installations, follow these next steps:

- If you are deploying a three-node cluster with zero compute nodes, the Ingress Controller pods run on the control plane nodes. In three-node cluster deployments, you must configure your application ingress load balancer to route HTTP and HTTPS traffic to the control plane nodes. See the *Load balancing requirements for user-provisioned infrastructure* section for more information.
- When you create the Kubernetes manifest files in the following procedure, ensure that the **mastersSchedulable** parameter in the `<installation_directory>/manifests/cluster-scheduler-02-config.yml` file is set to **true**. This enables your application workloads to run on the control plane nodes.
- Do not deploy any compute nodes when you create the Red Hat Enterprise Linux CoreOS (RHCOS) machines.

### 15.2.10. Cluster Network Operator configuration

The configuration for the cluster network is specified as part of the Cluster Network Operator (CNO) configuration and stored in a custom resource (CR) object that is named **cluster**. The CR specifies the fields for the **Network** API in the **operator.openshift.io** API group.

The CNO configuration inherits the following fields during cluster installation from the **Network** API in the **Network.config.openshift.io** API group and these fields cannot be changed:

#### **clusterNetwork**

IP address pools from which pod IP addresses are allocated.

#### **serviceNetwork**

IP address pool for services.

#### **defaultNetwork.type**

Cluster network provider, such as OpenShift SDN or OVN-Kubernetes.

You can specify the cluster network provider configuration for your cluster by setting the fields for the **defaultNetwork** object in the CNO object named **cluster**.

### 15.2.10.1. Cluster Network Operator configuration object

The fields for the Cluster Network Operator (CNO) are described in the following table:

Table 15.12. Cluster Network Operator configuration object

Field	Type	Description
<b>metadata.name</b>	<b>string</b>	The name of the CNO object. This name is always <b>cluster</b> .
<b>spec.clusterNetwork</b>	<b>array</b>	<p>A list specifying the blocks of IP addresses from which pod IP addresses are allocated and the subnet prefix length assigned to each individual node in the cluster. For example:</p> <pre>spec:   clusterNetwork:   - cidr: 10.128.0.0/19     hostPrefix: 23   - cidr: 10.128.32.0/19     hostPrefix: 23</pre> <p>You can customize this field only in the <b>install-config.yaml</b> file before you create the manifests. The value is read-only in the manifest file.</p>
<b>spec.serviceNetwork</b>	<b>array</b>	<p>A block of IP addresses for services. The OpenShift SDN and OVN-Kubernetes Container Network Interface (CNI) network providers support only a single IP address block for the service network. For example:</p> <pre>spec:   serviceNetwork:   - 172.30.0.0/14</pre> <p>You can customize this field only in the <b>install-config.yaml</b> file before you create the manifests. The value is read-only in the manifest file.</p>
<b>spec.defaultNetwork</b>	<b>object</b>	Configures the Container Network Interface (CNI) cluster network provider for the cluster network.
<b>spec.kubeProxyConfig</b>	<b>object</b>	The fields for this object specify the kube-proxy configuration. If you are using the OVN-Kubernetes cluster network provider, the kube-proxy configuration has no effect.

### defaultNetwork object configuration

The values for the **defaultNetwork** object are defined in the following table:

Table 15.13. defaultNetwork object



Field	Type	Description
<b>type</b>	<b>string</b>	<p>Either <b>OpenShiftSDN</b> or <b>OVNKubernetes</b>. The cluster network provider is selected during installation. This value cannot be changed after cluster installation.</p> <div style="display: flex; align-items: flex-start;"> <div style="flex: 1;">  </div> <div style="flex: 2;"> <p><b>NOTE</b></p> <p>OpenShift Container Platform uses the OpenShift SDN Container Network Interface (CNI) cluster network provider by default.</p> </div> </div>
<b>openshiftSDNConfig</b>	<b>object</b>	This object is only valid for the OpenShift SDN cluster network provider.
<b>ovnKubernetesConfig</b>	<b>object</b>	This object is only valid for the OVN-Kubernetes cluster network provider.

#### Configuration for the OpenShift SDN CNI cluster network provider

The following table describes the configuration fields for the OpenShift SDN Container Network Interface (CNI) cluster network provider.

Table 15.14. **openshiftSDNConfig** object

Field	Type	Description
<b>mode</b>	<b>string</b>	<p>Configures the network isolation mode for OpenShift SDN. The default value is <b>NetworkPolicy</b>.</p> <p>The values <b>Multitenant</b> and <b>Subnet</b> are available for backwards compatibility with OpenShift Container Platform 3.x but are not recommended. This value cannot be changed after cluster installation.</p>

Field	Type	Description
<b>mtu</b>	<b>integer</b>	<p>The maximum transmission unit (MTU) for the VXLAN overlay network. This is detected automatically based on the MTU of the primary network interface. You do not normally need to override the detected MTU.</p> <p>If the auto-detected value is not what you expect it to be, confirm that the MTU on the primary network interface on your nodes is correct. You cannot use this option to change the MTU value of the primary network interface on the nodes.</p> <p>If your cluster requires different MTU values for different nodes, you must set this value to <b>50</b> less than the lowest MTU value in your cluster. For example, if some nodes in your cluster have an MTU of <b>9001</b>, and some have an MTU of <b>1500</b>, you must set this value to <b>1450</b>.</p> <p>This value cannot be changed after cluster installation.</p>
<b>vxlanPort</b>	<b>integer</b>	<p>The port to use for all VXLAN packets. The default value is <b>4789</b>. This value cannot be changed after cluster installation.</p> <p>If you are running in a virtualized environment with existing nodes that are part of another VXLAN network, then you might be required to change this. For example, when running an OpenShift SDN overlay on top of VMware NSX-T, you must select an alternate port for the VXLAN, because both SDNs use the same default VXLAN port number.</p> <p>On Amazon Web Services (AWS), you can select an alternate port for the VXLAN between port <b>9000</b> and port <b>9999</b>.</p>

### Example OpenShift SDN configuration

```
defaultNetwork:
  type: OpenShiftSDN
  openshiftSDNConfig:
    mode: NetworkPolicy
    mtu: 1450
    vxlanPort: 4789
```

### Configuration for the OVN-Kubernetes CNI cluster network provider

The following table describes the configuration fields for the OVN-Kubernetes CNI cluster network provider.

Table 15.15. `ovnKubernetesConfig` object

Field	Type	Description
-------	------	-------------

Field	Type	Description
<b>mtu</b>	<b>integer</b>	<p>The maximum transmission unit (MTU) for the Geneve (Generic Network Virtualization Encapsulation) overlay network. This is detected automatically based on the MTU of the primary network interface. You do not normally need to override the detected MTU.</p> <p>If the auto-detected value is not what you expect it to be, confirm that the MTU on the primary network interface on your nodes is correct. You cannot use this option to change the MTU value of the primary network interface on the nodes.</p> <p>If your cluster requires different MTU values for different nodes, you must set this value to <b>100</b> less than the lowest MTU value in your cluster. For example, if some nodes in your cluster have an MTU of <b>9001</b>, and some have an MTU of <b>1500</b>, you must set this value to <b>1400</b>.</p>
<b>genevePort</b>	<b>integer</b>	The port to use for all Geneve packets. The default value is <b>6081</b> . This value cannot be changed after cluster installation.
<b>ipsecConfig</b>	<b>object</b>	Specify an empty object to enable IPsec encryption. This value cannot be changed after cluster installation.
<b>policyAuditConfig</b>	<b>object</b>	Specify a configuration object for customizing network policy audit logging. If unset, the defaults audit log settings are used.
<b>gatewayConfig</b>	<b>object</b>	Optional: Specify a configuration object for customizing how egress traffic is sent to the node gateway.
		 <p><b>NOTE</b></p> <p>While migrating egress traffic, you can expect some disruption to workloads and service traffic until the Cluster Network Operator (CNO) successfully rolls out the changes.</p>

Table 15.16. **policyAuditConfig** object

Field	Type	Description
<b>rateLimit</b>	integer	The maximum number of messages to generate every second per node. The default value is <b>20</b> messages per second.
<b>maxFileSize</b>	integer	The maximum size for the audit log in bytes. The default value is <b>50000000</b> or 50 MB.

Field	Type	Description
<b>destination</b>	string	<p>One of the following additional audit log targets:</p> <p><b>libc</b> The libc <b>syslog()</b> function of the journald process on the host.</p> <p><b>udp:&lt;host&gt;:&lt;port&gt;</b> A syslog server. Replace <b>&lt;host&gt;:&lt;port&gt;</b> with the host and port of the syslog server.</p> <p><b>unix:&lt;file&gt;</b> A Unix Domain Socket file specified by <b>&lt;file&gt;</b>.</p> <p><b>null</b> Do not send the audit logs to any additional target.</p>
<b>syslogFacility</b>	string	The syslog facility, such as <b>kern</b> , as defined by RFC5424. The default value is <b>local0</b> .

Table 15.17. gatewayConfig object

Field	Type	Description
<b>routingViaHost</b>	<b>boolean</b>	<p>Set this field to <b>true</b> to send egress traffic from pods to the host networking stack. For highly-specialized installations and applications that rely on manually configured routes in the kernel routing table, you might want to route egress traffic to the host networking stack. By default, egress traffic is processed in OVN to exit the cluster and is not affected by specialized routes in the kernel routing table. The default value is <b>false</b>.</p> <p>This field has an interaction with the Open vSwitch hardware offloading feature. If you set this field to <b>true</b>, you do not receive the performance benefits of the offloading because egress traffic is processed by the host networking stack.</p>

### Example OVN-Kubernetes configuration with IPsec enabled

```

defaultNetwork:
  type: OVNKubernetes
  ovnKubernetesConfig:
    mtu: 1400
    genevePort: 6081
    ipsecConfig: {}

```

### kubeProxyConfig object configuration

The values for the **kubeProxyConfig** object are defined in the following table:

Table 15.18. kubeProxyConfig object

Field	Type	Description
<b>iptablesSyncPeriod</b>	<b>string</b>	<p>The refresh period for <b>iptables</b> rules. The default value is <b>30s</b>. Valid suffixes include <b>s</b>, <b>m</b>, and <b>h</b> and are described in the <a href="#">Go time package</a> documentation.</p> <div style="display: flex; align-items: flex-start;">  <div> <p><b>NOTE</b></p> <p>Because of performance improvements introduced in OpenShift Container Platform 4.3 and greater, adjusting the <b>iptablesSyncPeriod</b> parameter is no longer necessary.</p> </div> </div>
<b>proxyArguments.iptables-min-sync-period</b>	<b>array</b>	<p>The minimum duration before refreshing <b>iptables</b> rules. This field ensures that the refresh does not happen too frequently. Valid suffixes include <b>s</b>, <b>m</b>, and <b>h</b> and are described in the <a href="#">Go time package</a>. The default value is:</p> <pre>kubeProxyConfig:   proxyArguments:     iptables-min-sync-period:       - 0s</pre>

### 15.2.11. Creating the Kubernetes manifest and Ignition config files

Because you must modify some cluster definition files and manually start the cluster machines, you must generate the Kubernetes manifest and Ignition config files that the cluster needs to configure the machines.

The installation configuration file transforms into the Kubernetes manifests. The manifests wrap into the Ignition configuration files, which are later used to configure the cluster machines.



#### IMPORTANT

- The Ignition config files that the OpenShift Container Platform installation program generates contain certificates that expire after 24 hours, which are then renewed at that time. If the cluster is shut down before renewing the certificates and the cluster is later restarted after the 24 hours have elapsed, the cluster automatically recovers the expired certificates. The exception is that you must manually approve the pending **node-bootstrapper** certificate signing requests (CSRs) to recover kubelet certificates. See the documentation for *Recovering from expired control plane certificates* for more information.
- It is recommended that you use Ignition config files within 12 hours after they are generated because the 24-hour certificate rotates from 16 to 22 hours after the cluster is installed. By using the Ignition config files within 12 hours, you can avoid installation failure if the certificate update runs during installation.



## NOTE

The installation program that generates the manifest and Ignition files is architecture specific and can be obtained from the [client image mirror](#). The Linux version of the installation program runs on s390x only. This installer program is also available as a Mac OS version.

## Prerequisites

- You obtained the OpenShift Container Platform installation program.
- You created the **install-config.yaml** installation configuration file.

## Procedure

1. Change to the directory that contains the OpenShift Container Platform installation program and generate the Kubernetes manifests for the cluster:

```
$ ./openshift-install create manifests --dir <installation_directory> 1
```

- 1 For **<installation\_directory>**, specify the installation directory that contains the **install-config.yaml** file you created.



## WARNING

If you are installing a three-node cluster, skip the following step to allow the control plane nodes to be schedulable.



## IMPORTANT

When you configure control plane nodes from the default unschedulable to schedulable, additional subscriptions are required. This is because control plane nodes then become worker nodes.

2. Check that the **mastersSchedulable** parameter in the **<installation\_directory>/manifests/cluster-scheduler-02-config.yml** Kubernetes manifest file is set to **false**. This setting prevents pods from being scheduled on the control plane machines:
  - a. Open the **<installation\_directory>/manifests/cluster-scheduler-02-config.yml** file.
  - b. Locate the **mastersSchedulable** parameter and ensure that it is set to **false**.
  - c. Save and exit the file.
3. To create the Ignition configuration files, run the following command from the directory that contains the installation program:

```
$ ./openshift-install create ignition-configs --dir <installation_directory> 1
```

- 1 For `<installation_directory>`, specify the same installation directory.

Ignition config files are created for the bootstrap, control plane, and compute nodes in the installation directory. The `kubeadmin-password` and `kubeconfig` files are created in the `./<installation_directory>/auth` directory:

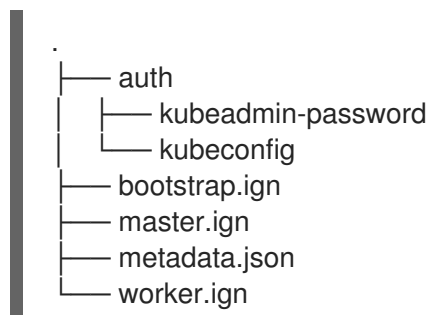

### 15.2.12. Installing RHCOS and starting the OpenShift Container Platform bootstrap process

To install OpenShift Container Platform on IBM Z infrastructure that you provision, you must install Red Hat Enterprise Linux CoreOS (RHCOS) on z/VM guest virtual machines. When you install RHCOS, you must provide the Ignition config file that was generated by the OpenShift Container Platform installation program for the type of machine you are installing. If you have configured suitable networking, DNS, and load balancing infrastructure, the OpenShift Container Platform bootstrap process begins automatically after the RHCOS z/VM guest virtual machines have rebooted.

Complete the following steps to create the machines.

#### Prerequisites

- An HTTP or HTTPS server running on your provisioning machine that is accessible to the machines you create.

#### Procedure

1. Log in to Linux on your provisioning machine.
2. Obtain the Red Hat Enterprise Linux CoreOS (RHCOS) kernel, initramfs, and rootfs files from the [RHCOS image mirror](#).



#### IMPORTANT

The RHCOS images might not change with every release of OpenShift Container Platform. You must download images with the highest version that is less than or equal to the OpenShift Container Platform version that you install. Only use the appropriate kernel, initramfs, and rootfs artifacts described in the following procedure.

The file names contain the OpenShift Container Platform version number. They resemble the following examples:

- kernel: `rhcos-<version>-live-kernel-<architecture>`
- initramfs: `rhcos-<version>-live-initramfs.<architecture>.img`

- rootfs: **rhcos-<version>-live-rootfs.<architecture>.img**

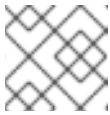
**NOTE**

The rootfs image is the same for FCP and DASD.

### 3. Create parameter files. The following parameters are specific for a particular virtual machine:

- For **ip=**, specify the following seven entries:
  - i. The IP address for the machine.
  - ii. An empty string.
  - iii. The gateway.
  - iv. The netmask.
  - v. The machine host and domain name in the form **hostname.domainname**. Omit this value to let RHCOS decide.
  - vi. The network interface name. Omit this value to let RHCOS decide.
  - vii. If you use static IP addresses, specify **none**.
- For **coreos.inst.ignition\_url=**, specify the Ignition file for the machine role. Use **bootstrap.ign**, **master.ign**, or **worker.ign**. Only HTTP and HTTPS protocols are supported.
- For **coreos.live.rootfs\_url=**, specify the matching rootfs artifact for the kernel and initramfs you are booting. Only HTTP and HTTPS protocols are supported.
- For installations on DASD-type disks, complete the following tasks:
  - i. For **coreos.inst.install\_dev=**, specify **dasda**.
  - ii. Use **rd.dasd=** to specify the DASD where RHCOS is to be installed.
  - iii. Leave all other parameters unchanged.  
Example parameter file, **bootstrap-0.parm**, for the bootstrap machine:

```
rd.neednet=1 \
console=ttysclp0 \
coreos.inst.install_dev=dasda \
coreos.live.rootfs_url=http://cl1.provide.example.com:8080/assets/rhcos-live-
rootfs.s390x.img \
coreos.inst.ignition_url=http://cl1.provide.example.com:8080/ignition/bootstrap.ign \
ip=172.18.78.2::172.18.78.1:255.255.255.0::none nameserver=172.18.78.1 \
rd.znet=qeth,0.0.bdf0,0.0.bdf1,0.0.bdf2,layer2=1,portno=0 \
zfcplib.allow_lun_scan=0 \
rd.dasd=0.0.3490
```

Write all options in the parameter file as a single line and make sure you have no newline characters.

- For installations on FCP-type disks, complete the following tasks:
  - i. Use **rd.zfcp=<adapter>,<wwpn>,<lun>** to specify the FCP disk where RHCOS is to be



installed. For multipathing repeat this step for each additional path.



#### NOTE

When you install with multiple paths, you must enable multipathing directly after the installation, not at a later point in time, as this can cause problems.

- ii. Set the install device as: **coreos.inst.install\_dev=sda**.



#### NOTE

If additional LUNs are configured with NPIV, FCP requires **zfcplib.allow\_lun\_scan=0**. If you must enable **zfcplib.allow\_lun\_scan=1** because you use a CSI driver, for example, you must configure your NPIV so that each node cannot access the boot partition of another node.

- iii. Leave all other parameters unchanged.



#### IMPORTANT

Additional post-installation steps are required to fully enable multipathing. For more information, see "Enabling multipathing with kernel arguments on RHCOS" in *Post-installation machine configuration tasks*.

The following is an example parameter file **worker-1.parm** for a worker node with multipathing:

```
rd.neednet=1 \
console=ttysclp0 \
coreos.inst.install_dev=sda \
coreos.live.rootfs_url=http://cl1.provide.example.com:8080/assets/rhcos-live-
rootfs.s390x.img \
coreos.inst.ignition_url=http://cl1.provide.example.com:8080/ignition/worker.ign \
ip=172.18.78.2::172.18.78.1:255.255.255.0::none nameserver=172.18.78.1 \
rd.znet=qeth,0.0.bdf0,0.0.bdf1,0.0.bdf2,layer2=1,portno=0 \
zfcplib.allow_lun_scan=0 \
rd.zfcplib=0.0.1987,0x50050763070bc5e3,0x4008400B00000000 \
rd.zfcplib=0.0.19C7,0x50050763070bc5e3,0x4008400B00000000 \
rd.zfcplib=0.0.1987,0x50050763071bc5e3,0x4008400B00000000 \
rd.zfcplib=0.0.19C7,0x50050763071bc5e3,0x4008400B00000000
```

Write all options in the parameter file as a single line and make sure you have no newline characters.

4. Transfer the initramfs, kernel, parameter files, and RHCOS images to z/VM, for example with FTP. For details about how to transfer the files with FTP and boot from the virtual reader, see [Installing under Z/VM](#).
5. Punch the files to the virtual reader of the z/VM guest virtual machine that is to become your bootstrap node.  
See [PUNCH](#) in IBM Documentation.

**TIP**

You can use the CP PUNCH command or, if you use Linux, the **vmur** command to transfer files between two z/VM guest virtual machines.

6. Log in to CMS on the bootstrap machine.
7. IPL the bootstrap machine from the reader:

```
$ ipl c
```

See [IPL](#) in IBM Documentation.

8. Repeat this procedure for the other machines in the cluster.

### 15.2.12.1. Advanced RHCOS installation reference

This section illustrates the networking configuration and other advanced options that allow you to modify the Red Hat Enterprise Linux CoreOS (RHCOS) manual installation process. The following tables describe the kernel arguments and command-line options you can use with the RHCOS live installer and the **coreos-installer** command.

#### 15.2.12.1.1. Networking and bonding options for ISO installations

If you install RHCOS from an ISO image, you can add kernel arguments manually when you boot the image to configure networking for a node. If no networking arguments are specified, DHCP is activated in the initramfs when RHCOS detects that networking is required to fetch the Ignition config file.

**IMPORTANT**

When adding networking arguments manually, you must also add the **rd.neednet=1** kernel argument to bring the network up in the initramfs.

The following table provides examples for configuring networking and bonding on your RHCOS nodes for ISO installations. The examples describe how to use the **ip=**, **nameserver=**, and **bond=** kernel arguments.

**NOTE**

Ordering is important when adding the kernel arguments: **ip=**, **nameserver=**, and then **bond=**.

The networking options are passed to the **dracut** tool during system boot. For more information about the networking options supported by **dracut**, see the **dracut.cmdline** manual page.

The following examples are the networking options for ISO installation.

#### Configuring DHCP or static IP addresses

To configure an IP address, either use DHCP (**ip=dhcp**) or set an individual static IP address (**ip=<host\_ip>**). If setting a static IP, you must then identify the DNS server IP address (**nameserver=<dns\_ip>**) on each node. The following example sets:

- The node's IP address to **10.10.10.2**

- The gateway address to **10.10.10.254**
- The netmask to **255.255.255.0**
- The hostname to **core0.example.com**
- The DNS server address to **4.4.4.41**
- The auto-configuration value to **none**. No auto-configuration is required when IP networking is configured statically.

```
ip=10.10.10.2::10.10.10.254:255.255.255.0:core0.example.com:enp1s0:none
nameserver=4.4.4.41
```



## NOTE

When you use DHCP to configure IP addressing for the RHCOS machines, the machines also obtain the DNS server information through DHCP. For DHCP-based deployments, you can define the DNS server address that is used by the RHCOS nodes through your DHCP server configuration.

### Configuring an IP address without a static hostname

You can configure an IP address without assigning a static hostname. If a static hostname is not set by the user, it will be picked up and automatically set by a reverse DNS lookup. To configure an IP address without a static hostname refer to the following example:

- The node's IP address to **10.10.10.2**
- The gateway address to **10.10.10.254**
- The netmask to **255.255.255.0**
- The DNS server address to **4.4.4.41**
- The auto-configuration value to **none**. No auto-configuration is required when IP networking is configured statically.

```
ip=10.10.10.2::10.10.10.254:255.255.255.0::enp1s0:none
nameserver=4.4.4.41
```

### Specifying multiple network interfaces

You can specify multiple network interfaces by setting multiple **ip=** entries.

```
ip=10.10.10.2::10.10.10.254:255.255.255.0:core0.example.com:enp1s0:none
ip=10.10.10.3::10.10.10.254:255.255.255.0:core0.example.com:enp2s0:none
```

### Configuring default gateway and route

Optional: You can configure routes to additional networks by setting an **rd.route=** value.



## NOTE

When you configure one or multiple networks, one default gateway is required. If the additional network gateway is different from the primary network gateway, the default gateway must be the primary network gateway.

- Run the following command to configure the default gateway:

```
ip=::10.10.10.254:::
```

- Enter the following command to configure the route for the additional network:

```
rd.route=20.20.20.0/24:20.20.20.254:enp2s0
```

### Disabling DHCP on a single interface

You can disable DHCP on a single interface, such as when there are two or more network interfaces and only one interface is being used. In the example, the **enp1s0** interface has a static networking configuration and DHCP is disabled for **enp2s0**, which is not used:

```
ip=10.10.10.2::10.10.10.254:255.255.255.0:core0.example.com:enp1s0:none
ip=::::core0.example.com:enp2s0:none
```

### Combining DHCP and static IP configurations

You can combine DHCP and static IP configurations on systems with multiple network interfaces, for example:

```
ip=enp1s0:dhcp
ip=10.10.10.2::10.10.10.254:255.255.255.0:core0.example.com:enp2s0:none
```

### Configuring VLANs on individual interfaces

Optional: You can configure VLANs on individual interfaces by using the **vlan=** parameter.

- To configure a VLAN on a network interface and use a static IP address, run the following command:

```
ip=10.10.10.2::10.10.10.254:255.255.255.0:core0.example.com:enp2s0.100:none
vlan=enp2s0.100:enp2s0
```

- To configure a VLAN on a network interface and to use DHCP, run the following command:

```
ip=enp2s0.100:dhcp
vlan=enp2s0.100:enp2s0
```

### Providing multiple DNS servers

You can provide multiple DNS servers by adding a **nameserver=** entry for each server, for example:

```
nameserver=1.1.1.1
nameserver=8.8.8.8
```

### Bonding multiple network interfaces to a single interface

Optional: You can bond multiple network interfaces to a single interface by using the **bond=** option. Refer to the following examples:

- The syntax for configuring a bonded interface is: **bond=name[:network\_interfaces][:options]** *name* is the bonding device name (**bond0**), *network\_interfaces* represents a comma-separated list of physical (ethernet) interfaces (**em1,em2**), and *options* is a comma-separated list of bonding options. Enter **modinfo bonding** to see available options.

- When you create a bonded interface using **bond=**, you must specify how the IP address is assigned and other information for the bonded interface.
- To configure the bonded interface to use DHCP, set the bond's IP address to **dhcp**. For example:

```
bond=bond0:em1,em2:mode=active-backup
ip=bond0:dhcp
```

- To configure the bonded interface to use a static IP address, enter the specific IP address you want and related information. For example:

```
bond=bond0:em1,em2:mode=active-backup,fail_over_mac=1
ip=10.10.10.2::10.10.10.254:255.255.255.0:core0.example.com:bond0:none
```

Always set option **fail\_over\_mac=1** in active-backup mode, to avoid problems when shared OSA/RoCE cards are used.

### Bonding multiple network interfaces to a single interface

Optional: You can configure VLANs on bonded interfaces by using the **vlan=** parameter and to use DHCP, for example:

```
ip=bond0.100:dhcp
bond=bond0:em1,em2:mode=active-backup
vlan=bond0.100:bond0
```

Use the following example to configure the bonded interface with a VLAN and to use a static IP address:

```
ip=10.10.10.2::10.10.10.254:255.255.255.0:core0.example.com:bond0.100:none
bond=bond0:em1,em2:mode=active-backup
vlan=bond0.100:bond0
```

### Using network teaming

Optional: You can use a network teaming as an alternative to bonding by using the **team=** parameter:

- The syntax for configuring a team interface is: **team=name[:network\_interfaces]**  
*name* is the team device name (**team0**) and *network\_interfaces* represents a comma-separated list of physical (ethernet) interfaces (**em1, em2**).

Teaming is planned to be deprecated when RHCOS switches to an upcoming version of RHEL. For more information, see this [Red Hat Knowledgebase Article](#) .

Use the following example to configure a network team:

```
team=team0:em1,em2
ip=team0:dhcp
```

## 15.2.13. Waiting for the bootstrap process to complete

The OpenShift Container Platform bootstrap process begins after the cluster nodes first boot into the persistent RHCOS environment that has been installed to disk. The configuration information provided through the Ignition config files is used to initialize the bootstrap process and install OpenShift Container Platform on the machines. You must wait for the bootstrap process to complete.

## Prerequisites

- You have created the Ignition config files for your cluster.
- You have configured suitable network, DNS and load balancing infrastructure.
- You have obtained the installation program and generated the Ignition config files for your cluster.
- You installed RHCOS on your cluster machines and provided the Ignition config files that the OpenShift Container Platform installation program generated.
- Your machines have direct internet access or have an HTTP or HTTPS proxy available.

## Procedure

1. Monitor the bootstrap process:

```
$ ./openshift-install --dir <installation_directory> wait-for bootstrap-complete \ 1
--log-level=info 2
```

- 1 For **<installation\_directory>**, specify the path to the directory that you stored the installation files in.

- 2 To view different installation details, specify **warn**, **debug**, or **error** instead of **info**.

## Example output

```
INFO Waiting up to 30m0s for the Kubernetes API at https://api.test.example.com:6443...
INFO API v1.23.0 up
INFO Waiting up to 30m0s for bootstrapping to complete...
INFO It is now safe to remove the bootstrap resources
```

The command succeeds when the Kubernetes API server signals that it has been bootstrapped on the control plane machines.

2. After bootstrap process is complete, remove the bootstrap machine from the load balancer.

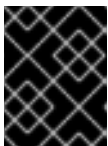

### IMPORTANT

You must remove the bootstrap machine from the load balancer at this point. You can also remove or reformat the bootstrap machine itself.

## 15.2.14. Logging in to the cluster by using the CLI

You can log in to your cluster as a default system user by exporting the cluster **kubeconfig** file. The **kubeconfig** file contains information about the cluster that is used by the CLI to connect a client to the correct cluster and API server. The file is specific to a cluster and is created during OpenShift Container Platform installation.

## Prerequisites

- You deployed an OpenShift Container Platform cluster.

- You installed the **oc** CLI.

### Procedure

1. Export the **kubeadmin** credentials:

```
$ export KUBECONFIG=<installation_directory>/auth/kubeconfig 1
```

- 1** For **<installation\_directory>**, specify the path to the directory that you stored the installation files in.

2. Verify you can run **oc** commands successfully using the exported configuration:

```
$ oc whoami
```

### Example output

```
system:admin
```

## 15.2.15. Approving the certificate signing requests for your machines

When you add machines to a cluster, two pending certificate signing requests (CSRs) are generated for each machine that you added. You must confirm that these CSRs are approved or, if necessary, approve them yourself. The client requests must be approved first, followed by the server requests.

### Prerequisites

- You added machines to your cluster.

### Procedure

1. Confirm that the cluster recognizes the machines:

```
$ oc get nodes
```

### Example output

```
NAME      STATUS  ROLES  AGE  VERSION
master-0  Ready   master 63m  v1.23.0
master-1  Ready   master 63m  v1.23.0
master-2  Ready   master 64m  v1.23.0
```

The output lists all of the machines that you created.

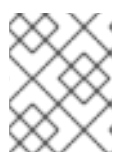

### NOTE

The preceding output might not include the compute nodes, also known as worker nodes, until some CSRs are approved.

2. Review the pending CSRs and ensure that you see the client requests with the **Pending** or **Approved** status for each machine that you added to the cluster:

```
$ oc get csr
```

### Example output

NAME	AGE	REQUESTOR	CONDITION
csr-mddf5	20m	system:node:master-01.example.com	Approved,Issued
csr-z5rln	16m	system:node:worker-21.example.com	Approved,Issued

- If the CSRs were not approved, after all of the pending CSRs for the machines you added are in **Pending** status, approve the CSRs for your cluster machines:



#### NOTE

Because the CSRs rotate automatically, approve your CSRs within an hour of adding the machines to the cluster. If you do not approve them within an hour, the certificates will rotate, and more than two certificates will be present for each node. You must approve all of these certificates. After the client CSR is approved, the Kubelet creates a secondary CSR for the serving certificate, which requires manual approval. Then, subsequent serving certificate renewal requests are automatically approved by the **machine-approver** if the Kubelet requests a new certificate with identical parameters.



#### NOTE

For clusters running on platforms that are not machine API enabled, such as bare metal and other user-provisioned infrastructure, you must implement a method of automatically approving the kubelet serving certificate requests (CSRs). If a request is not approved, then the **oc exec**, **oc rsh**, and **oc logs** commands cannot succeed, because a serving certificate is required when the API server connects to the kubelet. Any operation that contacts the Kubelet endpoint requires this certificate approval to be in place. The method must watch for new CSRs, confirm that the CSR was submitted by the **node-bootstrapper** service account in the **system:node** or **system:admin** groups, and confirm the identity of the node.

- To approve them individually, run the following command for each valid CSR:

```
$ oc adm certificate approve <csr_name> 1
```

- 1** **<csr\_name>** is the name of a CSR from the list of current CSRs.

- To approve all pending CSRs, run the following command:

```
$ oc get csr -o go-template='{{range .items}}{{if not .status}}{{.metadata.name}}{\n"}\n{{end}}\n{{end}}' | xargs --no-run-if-empty oc adm certificate approve
```



#### NOTE

Some Operators might not become available until some CSRs are approved.



4. Now that your client requests are approved, you must review the server requests for each machine that you added to the cluster:

```
$ oc get csr
```

### Example output

```
NAME      AGE   REQUESTOR                                     CONDITION
csr-bfd72 5m26s system:node:ip-10-0-50-126.us-east-2.compute.internal
Pending
csr-c57lv 5m26s system:node:ip-10-0-95-157.us-east-2.compute.internal
Pending
...
```

5. If the remaining CSRs are not approved, and are in the **Pending** status, approve the CSRs for your cluster machines:

- To approve them individually, run the following command for each valid CSR:

```
$ oc adm certificate approve <csr_name> 1
```

- 1** **<csr\_name>** is the name of a CSR from the list of current CSRs.

- To approve all pending CSRs, run the following command:

```
$ oc get csr -o go-template='{{range .items}}{{if not .status}}{{.metadata.name}}{\n"}\n{{end}}' | xargs oc adm certificate approve
```

6. After all client and server CSRs have been approved, the machines have the **Ready** status. Verify this by running the following command:

```
$ oc get nodes
```

### Example output

```
NAME      STATUS   ROLES    AGE   VERSION
master-0  Ready   master   73m   v1.23.0
master-1  Ready   master   73m   v1.23.0
master-2  Ready   master   74m   v1.23.0
worker-0  Ready   worker   11m   v1.23.0
worker-1  Ready   worker   11m   v1.23.0
```



### NOTE

It can take a few minutes after approval of the server CSRs for the machines to transition to the **Ready** status.

### Additional information

- For more information on CSRs, see [Certificate Signing Requests](#).

## 15.2.16. Initial Operator configuration

After the control plane initializes, you must immediately configure some Operators so that they all become available.

## Prerequisites

- Your control plane has initialized.

## Procedure

1. Watch the cluster components come online:

```
$ watch -n5 oc get clusteroperators
```

## Example output

NAME	VERSION	AVAILABLE	PROGRESSING	DEGRADED	SINCE
authentication	4.10.0	True	False	False	19m
baremetal	4.10.0	True	False	False	37m
cloud-credential	4.10.0	True	False	False	40m
cluster-autoscaler	4.10.0	True	False	False	37m
config-operator	4.10.0	True	False	False	38m
console	4.10.0	True	False	False	26m
csi-snapshot-controller	4.10.0	True	False	False	37m
dns	4.10.0	True	False	False	37m
etcd	4.10.0	True	False	False	36m
image-registry	4.10.0	True	False	False	31m
ingress	4.10.0	True	False	False	30m
insights	4.10.0	True	False	False	31m
kube-apiserver	4.10.0	True	False	False	26m
kube-controller-manager	4.10.0	True	False	False	36m
kube-scheduler	4.10.0	True	False	False	36m
kube-storage-version-migrator	4.10.0	True	False	False	37m
machine-api	4.10.0	True	False	False	29m
machine-approver	4.10.0	True	False	False	37m
machine-config	4.10.0	True	False	False	36m
marketplace	4.10.0	True	False	False	37m
monitoring	4.10.0	True	False	False	29m
network	4.10.0	True	False	False	38m
node-tuning	4.10.0	True	False	False	37m
openshift-apiserver	4.10.0	True	False	False	32m
openshift-controller-manager	4.10.0	True	False	False	30m
openshift-samples	4.10.0	True	False	False	32m
operator-lifecycle-manager	4.10.0	True	False	False	37m
operator-lifecycle-manager-catalog	4.10.0	True	False	False	37m
operator-lifecycle-manager-packageserver	4.10.0	True	False	False	32m
service-ca	4.10.0	True	False	False	38m
storage	4.10.0	True	False	False	37m

2. Configure the Operators that are not available.

### 15.2.16.1. Image registry storage configuration

The Image Registry Operator is not initially available for platforms that do not provide default storage. After installation, you must configure your registry to use storage so that the Registry Operator is made available.

Instructions are shown for configuring a persistent volume, which is required for production clusters. Where applicable, instructions are shown for configuring an empty directory as the storage location, which is available for only non-production clusters.

Additional instructions are provided for allowing the image registry to use block storage types by using the **Recreate** rollout strategy during upgrades.

### 15.2.16.1.1. Configuring registry storage for IBM Z

As a cluster administrator, following installation you must configure your registry to use storage.

#### Prerequisites

- You have access to the cluster as a user with the **cluster-admin** role.
- You have a cluster on IBM Z.
- You have provisioned persistent storage for your cluster, such as Red Hat OpenShift Data Foundation.



#### IMPORTANT

OpenShift Container Platform supports **ReadWriteOnce** access for image registry storage when you have only one replica. **ReadWriteOnce** access also requires that the registry uses the **Recreate** rollout strategy. To deploy an image registry that supports high availability with two or more replicas, **ReadWriteMany** access is required.

- Must have 100Gi capacity.

#### Procedure

1. To configure your registry to use storage, change the **spec.storage.pvc** in the **configs.imageregistry/cluster** resource.



#### NOTE

When using shared storage, review your security settings to prevent outside access.

2. Verify that you do not have a registry pod:

```
$ oc get pod -n openshift-image-registry -l docker-registry=default
```

#### Example output

```
No resources found in openshift-image-registry namespace
```

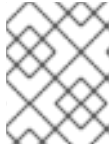
**NOTE**

If you do have a registry pod in your output, you do not need to continue with this procedure.

3. Check the registry configuration:

```
$ oc edit configs.imageregistry.operator.openshift.io
```

**Example output**

```
storage:
  pvc:
    claim:
```

Leave the **claim** field blank to allow the automatic creation of an **image-registry-storage** PVC.

4. Check the **clusteroperator** status:

```
$ oc get clusteroperator image-registry
```

**Example output**

NAME	VERSION	AVAILABLE	PROGRESSING	DEGRADED	SINCE
image-registry	4.10	True	False	False	6h50m

5. Ensure that your registry is set to managed to enable building and pushing of images.

- Run:

```
$ oc edit configs.imageregistry/cluster
```

Then, change the line

```
managementState: Removed
```

to

```
managementState: Managed
```

### 15.2.16.1.2. Configuring storage for the image registry in non-production clusters

You must configure storage for the Image Registry Operator. For non-production clusters, you can set the image registry to an empty directory. If you do so, all images are lost if you restart the registry.

**Procedure**

- To set the image registry storage to an empty directory:

```
$ oc patch configs.imageregistry.operator.openshift.io cluster --type merge --patch '{"spec": {"storage":{"emptyDir":{}}}'
```

**WARNING**

Configure this option for only non-production clusters.

If you run this command before the Image Registry Operator initializes its components, the **oc patch** command fails with the following error:

```
Error from server (NotFound): configs.imageregistry.operator.openshift.io "cluster" not found
```

Wait a few minutes and run the command again.

### 15.2.17. Completing installation on user-provisioned infrastructure

After you complete the Operator configuration, you can finish installing the cluster on infrastructure that you provide.

#### Prerequisites

- Your control plane has initialized.
- You have completed the initial Operator configuration.

#### Procedure

1. Confirm that all the cluster components are online with the following command:

```
$ watch -n5 oc get clusteroperators
```

#### Example output

NAME	VERSION	AVAILABLE	PROGRESSING	DEGRADED	SINCE
authentication	4.10.0	True	False	False	19m
baremetal	4.10.0	True	False	False	37m
cloud-credential	4.10.0	True	False	False	40m
cluster-autoscaler	4.10.0	True	False	False	37m
config-operator	4.10.0	True	False	False	38m
console	4.10.0	True	False	False	26m
csi-snapshot-controller	4.10.0	True	False	False	37m
dns	4.10.0	True	False	False	37m
etcd	4.10.0	True	False	False	36m
image-registry	4.10.0	True	False	False	31m
ingress	4.10.0	True	False	False	30m
insights	4.10.0	True	False	False	31m
kube-apiserver	4.10.0	True	False	False	26m
kube-controller-manager	4.10.0	True	False	False	36m
kube-scheduler	4.10.0	True	False	False	36m
kube-storage-version-migrator	4.10.0	True	False	False	37m
machine-api	4.10.0	True	False	False	29m

machine-approver	4.10.0	True	False	False	37m
machine-config	4.10.0	True	False	False	36m
marketplace	4.10.0	True	False	False	37m
monitoring	4.10.0	True	False	False	29m
network	4.10.0	True	False	False	38m
node-tuning	4.10.0	True	False	False	37m
openshift-apiserver	4.10.0	True	False	False	32m
openshift-controller-manager	4.10.0	True	False	False	30m
openshift-samples	4.10.0	True	False	False	32m
operator-lifecycle-manager	4.10.0	True	False	False	37m
operator-lifecycle-manager-catalog	4.10.0	True	False	False	37m
operator-lifecycle-manager-packageserver	4.10.0	True	False	False	32m
service-ca	4.10.0	True	False	False	38m
storage	4.10.0	True	False	False	37m

Alternatively, the following command notifies you when all of the clusters are available. It also retrieves and displays credentials:

```
$ ./openshift-install --dir <installation_directory> wait-for install-complete 1
```

- 1** For **<installation\_directory>**, specify the path to the directory that you stored the installation files in.

### Example output

```
INFO Waiting up to 30m0s for the cluster to initialize...
```

The command succeeds when the Cluster Version Operator finishes deploying the OpenShift Container Platform cluster from Kubernetes API server.



### IMPORTANT

- The Ignition config files that the installation program generates contain certificates that expire after 24 hours, which are then renewed at that time. If the cluster is shut down before renewing the certificates and the cluster is later restarted after the 24 hours have elapsed, the cluster automatically recovers the expired certificates. The exception is that you must manually approve the pending **node-bootstrapper** certificate signing requests (CSRs) to recover kubelet certificates. See the documentation for *Recovering from expired control plane certificates* for more information.
- It is recommended that you use Ignition config files within 12 hours after they are generated because the 24-hour certificate rotates from 16 to 22 hours after the cluster is installed. By using the Ignition config files within 12 hours, you can avoid installation failure if the certificate update runs during installation.

2. Confirm that the Kubernetes API server is communicating with the pods.

- a. To view a list of all pods, use the following command:

```
$ oc get pods --all-namespaces
```

**Example output**

```

NAMESPACE           NAME                                     READY  STATUS
RESTARTS  AGE
openshift-apiserver-operator  openshift-apiserver-operator-85cb746d55-zqhs8  1/1
Running    1    9m
openshift-apiserver          apiserver-67b9g                                1/1  Running  0
3m
openshift-apiserver          apiserver-ljcmx                                1/1  Running  0
1m
openshift-apiserver          apiserver-z25h4                                1/1  Running  0
2m
openshift-authentication-operator  authentication-operator-69d5d8bf84-vh2n8    1/1
Running    0    5m
...

```

- b. View the logs for a pod that is listed in the output of the previous command by using the following command:

```
$ oc logs <pod_name> -n <namespace> ❶
```

- ❶ Specify the pod name and namespace, as shown in the output of the previous command.

If the pod logs display, the Kubernetes API server can communicate with the cluster machines.

3. For an installation with Fibre Channel Protocol (FCP), additional steps are required to enable multipathing. Do not enable multipathing during installation. See "Enabling multipathing with kernel arguments on RHCOS" in the *Post-installation machine configuration tasks* documentation for more information.

**15.2.18. Telemetry access for OpenShift Container Platform**

In OpenShift Container Platform 4.10, the Telemetry service, which runs by default to provide metrics about cluster health and the success of updates, requires internet access. If your cluster is connected to the internet, Telemetry runs automatically, and your cluster is registered to [OpenShift Cluster Manager](#).

After you confirm that your [OpenShift Cluster Manager](#) inventory is correct, either maintained automatically by Telemetry or manually by using OpenShift Cluster Manager, [use subscription watch](#) to track your OpenShift Container Platform subscriptions at the account or multi-cluster level.

**Additional resources**

- See [About remote health monitoring](#) for more information about the Telemetry service
- [How to generate SOSREPORT within OpenShift4 nodes without SSH](#) .

**15.2.19. Next steps**

- [Enabling multipathing with kernel arguments on RHCOS](#) .
- [Customize your cluster](#) .

- If necessary, you can [opt out of remote health reporting](#) .

## 15.3. INSTALLING A CLUSTER WITH Z/VM ON IBM Z AND LINUXONE IN A RESTRICTED NETWORK

In OpenShift Container Platform version 4.10, you can install a cluster on IBM Z and LinuxONE infrastructure that you provision in a restricted network.

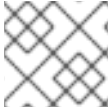

### NOTE

While this document refers to only IBM Z, all information in it also applies to LinuxONE.

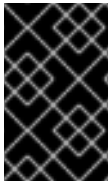

### IMPORTANT

Additional considerations exist for non-bare metal platforms. Review the information in the [guidelines for deploying OpenShift Container Platform on non-tested platforms](#) before you install an OpenShift Container Platform cluster.

### 15.3.1. Prerequisites

- You reviewed details about the [OpenShift Container Platform installation and update](#) processes.
- You read the documentation on [selecting a cluster installation method and preparing it for users](#).
- You [created a mirror registry for installation in a restricted network](#) and obtained the **imageContentSources** data for your version of OpenShift Container Platform.
- Before you begin the installation process, you must move or remove any existing installation files. This ensures that the required installation files are created and updated during the installation process.

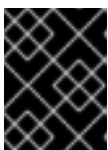

### IMPORTANT

Ensure that installation steps are done from a machine with access to the installation media.

- You provisioned [persistent storage using OpenShift Data Foundation](#) or other supported storage protocols for your cluster. To deploy a private image registry, you must set up persistent storage with **ReadWriteMany** access.
- If you use a firewall and plan to use the Telemetry service, you [configured the firewall to allow the sites](#) that your cluster requires access to.



### NOTE

Be sure to also review this site list if you are configuring a proxy.

### 15.3.2. About installations in restricted networks

In OpenShift Container Platform 4.10, you can perform an installation that does not require an active connection to the internet to obtain software components. Restricted network installations can be



completed using installer-provisioned infrastructure or user-provisioned infrastructure, depending on the cloud platform to which you are installing the cluster.

If you choose to perform a restricted network installation on a cloud platform, you still require access to its cloud APIs. Some cloud functions, like Amazon Web Service's Route 53 DNS and IAM services, require internet access. Depending on your network, you might require less internet access for an installation on bare metal hardware or on VMware vSphere.

To complete a restricted network installation, you must create a registry that mirrors the contents of the OpenShift image registry and contains the installation media. You can create this registry on a mirror host, which can access both the internet and your closed network, or by using other methods that meet your restrictions.



### IMPORTANT

Because of the complexity of the configuration for user-provisioned installations, consider completing a standard user-provisioned infrastructure installation before you attempt a restricted network installation using user-provisioned infrastructure. Completing this test installation might make it easier to isolate and troubleshoot any issues that might arise during your installation in a restricted network.

#### 15.3.2.1. Additional limits

Clusters in restricted networks have the following additional limitations and restrictions:

- The **ClusterVersion** status includes an **Unable to retrieve available updates** error.
- By default, you cannot use the contents of the Developer Catalog because you cannot access the required image stream tags.

#### 15.3.3. Internet access for OpenShift Container Platform

In OpenShift Container Platform 4.10, you require access to the internet to obtain the images that are necessary to install your cluster.

You must have internet access to:

- Access [OpenShift Cluster Manager](#) to download the installation program and perform subscription management. If the cluster has internet access and you do not disable Telemetry, that service automatically entitles your cluster.
- Access [Quay.io](#) to obtain the packages that are required to install your cluster.
- Obtain the packages that are required to perform cluster updates.



### IMPORTANT

If your cluster cannot have direct internet access, you can perform a restricted network installation on some types of infrastructure that you provision. During that process, you download the required content and use it to populate a mirror registry with the installation packages. With some installation types, the environment that you install your cluster in will not require internet access. Before you update the cluster, you update the content of the mirror registry.

#### 15.3.4. Requirements for a cluster with user-provisioned infrastructure

For a cluster that contains user-provisioned infrastructure, you must deploy all of the required machines.

This section describes the requirements for deploying OpenShift Container Platform on user-provisioned infrastructure.

### 15.3.4.1. Required machines for cluster installation

The smallest OpenShift Container Platform clusters require the following hosts:

**Table 15.19. Minimum required hosts**

Hosts	Description
One temporary bootstrap machine	The cluster requires the bootstrap machine to deploy the OpenShift Container Platform cluster on the three control plane machines. You can remove the bootstrap machine after you install the cluster.
Three control plane machines	The control plane machines run the Kubernetes and OpenShift Container Platform services that form the control plane.
At least two compute machines, which are also known as worker machines.	The workloads requested by OpenShift Container Platform users run on the compute machines.



#### IMPORTANT

To improve high availability of your cluster, distribute the control plane machines over different z/VM instances on at least two physical machines.

The bootstrap, control plane, and compute machines must use Red Hat Enterprise Linux CoreOS (RHCOS) as the operating system.

Note that RHCOS is based on Red Hat Enterprise Linux (RHEL) 8 and inherits all of its hardware certifications and requirements. See [Red Hat Enterprise Linux technology capabilities and limits](#) .

### 15.3.4.2. Minimum resource requirements for cluster installation

Each cluster machine must meet the following minimum requirements:

**Table 15.20. Minimum resource requirements**

Machine	Operating System	vCPU [1]	Virtual RAM	Storage	IOPS
Bootstrap	RHCOS	4	16 GB	100 GB	N/A
Control plane	RHCOS	4	16 GB	100 GB	N/A
Compute	RHCOS	2	8 GB	100 GB	N/A

1. One physical core (IFL) provides two logical cores (threads) when SMT-2 is enabled. The hypervisor can provide two or more vCPUs.

If an instance type for your platform meets the minimum requirements for cluster machines, it is supported to use in OpenShift Container Platform.

### 15.3.4.3. Minimum IBM Z system environment

You can install OpenShift Container Platform version 4.10 on the following IBM hardware:

- IBM z16 (all models), IBM z15 (all models), IBM z14 (all models), IBM z13, and IBM z13s
- LinuxONE, any version

#### Hardware requirements

- The equivalent of six Integrated Facilities for Linux (IFL), which are SMT2 enabled, for each cluster.
- At least one network connection to both connect to the **LoadBalancer** service and to serve data for traffic outside the cluster.



#### NOTE

You can use dedicated or shared IFLs to assign sufficient compute resources. Resource sharing is one of the key strengths of IBM Z. However, you must adjust capacity correctly on each hypervisor layer and ensure sufficient resources for every OpenShift Container Platform cluster.



#### IMPORTANT

Since the overall performance of the cluster can be impacted, the LPARs that are used to setup the OpenShift Container Platform clusters must provide sufficient compute capacity. In this context, LPAR weight management, entitlements, and CPU shares on the hypervisor level play an important role.

#### Operating system requirements

- One instance of z/VM 7.2 or later

On your z/VM instance, set up:

- Three guest virtual machines for OpenShift Container Platform control plane machines
- Two guest virtual machines for OpenShift Container Platform compute machines
- One guest virtual machine for the temporary OpenShift Container Platform bootstrap machine

#### IBM Z network connectivity requirements

To install on IBM Z under z/VM, you require a single z/VM virtual NIC in layer 2 mode. You also need:

- A direct-attached OSA or RoCE network adapter
- A z/VM VSwitch set up. For a preferred setup, use OSA link aggregation.

#### Disk storage for the z/VM guest virtual machines

- FICON attached disk storage (DASDs). These can be z/VM minidisks, fullpack minidisks, or dedicated DASDs, all of which must be formatted as CDL, which is the default. To reach the minimum required DASD size for Red Hat Enterprise Linux CoreOS (RHCOS) installations, you need extended address volumes (EAV). If available, use HyperPAV to ensure optimal performance.
- FCP attached disk storage

### Storage / Main Memory

- 16 GB for OpenShift Container Platform control plane machines
- 8 GB for OpenShift Container Platform compute machines
- 16 GB for the temporary OpenShift Container Platform bootstrap machine

### 15.3.4.4. Preferred IBM Z system environment

#### Hardware requirements

- Three LPARS that each have the equivalent of six IFLs, which are SMT2 enabled, for each cluster.
- Two network connections to both connect to the **LoadBalancer** service and to serve data for traffic outside the cluster.
- HiperSockets, which are attached to a node either directly as a device or by bridging with one z/VM VSWITCH to be transparent to the z/VM guest. To directly connect HiperSockets to a node, you must set up a gateway to the external network via a RHEL 8 guest to bridge to the HiperSockets network.

#### Operating system requirements

- Two or three instances of z/VM 7.2 or later for high availability

On your z/VM instances, set up:

- Three guest virtual machines for OpenShift Container Platform control plane machines, one per z/VM instance.
- At least six guest virtual machines for OpenShift Container Platform compute machines, distributed across the z/VM instances.
- One guest virtual machine for the temporary OpenShift Container Platform bootstrap machine.
- To ensure the availability of integral components in an overcommitted environment, increase the priority of the control plane by using the CP command **SET SHARE**. Do the same for infrastructure nodes, if they exist. See [SET SHARE](#) in IBM Documentation.

#### IBM Z network connectivity requirements

To install on IBM Z under z/VM, you require a single z/VM virtual NIC in layer 2 mode. You also need:

- A direct-attached OSA or RoCE network adapter
- A z/VM VSwitch set up. For a preferred setup, use OSA link aggregation.

#### Disk storage for the z/VM guest virtual machines

- FICON attached disk storage (DASDs). These can be z/VM minidisks, fullpack minidisks, or dedicated DASDs, all of which must be formatted as CDL, which is the default. To reach the minimum required DASD size for Red Hat Enterprise Linux CoreOS (RHCOS) installations, you need extended address volumes (EAV). If available, use HyperPAV and High Performance FICON (zHPF) to ensure optimal performance.
- FCP attached disk storage

### Storage / Main Memory

- 16 GB for OpenShift Container Platform control plane machines
- 8 GB for OpenShift Container Platform compute machines
- 16 GB for the temporary OpenShift Container Platform bootstrap machine

### 15.3.4.5. Certificate signing requests management

Because your cluster has limited access to automatic machine management when you use infrastructure that you provision, you must provide a mechanism for approving cluster certificate signing requests (CSRs) after installation. The **kube-controller-manager** only approves the kubelet client CSRs. The **machine-approver** cannot guarantee the validity of a serving certificate that is requested by using kubelet credentials because it cannot confirm that the correct machine issued the request. You must determine and implement a method of verifying the validity of the kubelet serving certificate requests and approving them.

### Additional resources

- See [Bridging a HyperSockets LAN with a z/VM Virtual Switch](#) in IBM Documentation.
- See [Scaling HyperPAV alias devices on Linux guests on z/VM](#) for performance optimization.
- See [Topics in LPAR performance](#) for LPAR weight management and entitlements.
- [Recommended host practices for IBM Z & LinuxONE environments](#)

### 15.3.4.6. Networking requirements for user-provisioned infrastructure

All the Red Hat Enterprise Linux CoreOS (RHCOS) machines require networking to be configured in **initramfs** during boot to fetch their Ignition config files.

During the initial boot, the machines require an IP address configuration that is set either through a DHCP server or statically by providing the required boot options. After a network connection is established, the machines download their Ignition config files from an HTTP or HTTPS server. The Ignition config files are then used to set the exact state of each machine. The Machine Config Operator completes more changes to the machines, such as the application of new certificates or keys, after installation.

It is recommended to use a DHCP server for long-term management of the cluster machines. Ensure that the DHCP server is configured to provide persistent IP addresses, DNS server information, and hostnames to the cluster machines.

**NOTE**

If a DHCP service is not available for your user-provisioned infrastructure, you can instead provide the IP networking configuration and the address of the DNS server to the nodes at RHCOS install time. These can be passed as boot arguments if you are installing from an ISO image. See the *Installing RHCOS and starting the OpenShift Container Platform bootstrap process* section for more information about static IP provisioning and advanced networking options.

The Kubernetes API server must be able to resolve the node names of the cluster machines. If the API servers and worker nodes are in different zones, you can configure a default DNS search zone to allow the API server to resolve the node names. Another supported approach is to always refer to hosts by their fully-qualified domain names in both the node objects and all DNS requests.

**15.3.4.6.1. Setting the cluster node hostnames through DHCP**

On Red Hat Enterprise Linux CoreOS (RHCOS) machines, the hostname is set through NetworkManager. By default, the machines obtain their hostname through DHCP. If the hostname is not provided by DHCP, set statically through kernel arguments, or another method, it is obtained through a reverse DNS lookup. Reverse DNS lookup occurs after the network has been initialized on a node and can take time to resolve. Other system services can start prior to this and detect the hostname as **localhost** or similar. You can avoid this by using DHCP to provide the hostname for each cluster node.

Additionally, setting the hostnames through DHCP can bypass any manual DNS record name configuration errors in environments that have a DNS split-horizon implementation.

**15.3.4.6.2. Network connectivity requirements**

You must configure the network connectivity between machines to allow OpenShift Container Platform cluster components to communicate. Each machine must be able to resolve the hostnames of all other machines in the cluster.

This section provides details about the ports that are required.

**Table 15.21. Ports used for all-machine to all-machine communications**

Protocol	Port	Description
ICMP	N/A	Network reachability tests
TCP	<b>1936</b>	Metrics
	<b>9000-9999</b>	Host level services, including the node exporter on ports <b>9100-9101</b> and the Cluster Version Operator on port <b>9099</b> .
	<b>10250-10259</b>	The default ports that Kubernetes reserves
	<b>10256</b>	openshift-sdn
UDP	<b>4789</b>	VXLAN

Protocol	Port	Description
	<b>6081</b>	Geneve
	<b>9000-9999</b>	Host level services, including the node exporter on ports <b>9100-9101</b> .
	<b>500</b>	IPsec IKE packets
	<b>4500</b>	IPsec NAT-T packets
TCP/UDP	<b>30000-32767</b>	Kubernetes node port
ESP	N/A	IPsec Encapsulating Security Payload (ESP)

Table 15.22. Ports used for all-machine to control plane communications

Protocol	Port	Description
TCP	<b>6443</b>	Kubernetes API

Table 15.23. Ports used for control plane machine to control plane machine communications

Protocol	Port	Description
TCP	<b>2379-2380</b>	etcd server and peer ports

### NTP configuration for user-provisioned infrastructure

OpenShift Container Platform clusters are configured to use a public Network Time Protocol (NTP) server by default. If you want to use a local enterprise NTP server, or if your cluster is being deployed in a disconnected network, you can configure the cluster to use a specific time server. For more information, see the documentation for *Configuring chrony time service*.

#### Additional resources

- [Configuring chrony time service](#)

### 15.3.4.7. User-provisioned DNS requirements

In OpenShift Container Platform deployments, DNS name resolution is required for the following components:

- The Kubernetes API
- The OpenShift Container Platform application wildcard
- The bootstrap, control plane, and compute machines

Reverse DNS resolution is also required for the Kubernetes API, the bootstrap machine, the control plane machines, and the compute machines.

DNS A/AAAA or CNAME records are used for name resolution and PTR records are used for reverse name resolution. The reverse records are important because Red Hat Enterprise Linux CoreOS (RHCOS) uses the reverse records to set the hostnames for all the nodes, unless the hostnames are provided by DHCP. Additionally, the reverse records are used to generate the certificate signing requests (CSR) that OpenShift Container Platform needs to operate.

The following DNS records are required for a user-provisioned OpenShift Container Platform cluster and they must be in place before installation. In each record, **<cluster\_name>** is the cluster name and **<base\_domain>** is the base domain that you specify in the **install-config.yaml** file. A complete DNS record takes the form: **<component>.<cluster\_name>.<base\_domain>..**

**Table 15.24. Required DNS records**

Component	Record	Description
Kubernetes API	<b>api.&lt;cluster_name&gt;.&lt;base_domain&gt;..</b>	A DNS A/AAAA or CNAME record, and a DNS PTR record, to identify the API load balancer. These records must be resolvable by both clients external to the cluster and from all the nodes within the cluster.
	<b>api-int.&lt;cluster_name&gt;.&lt;base_domain&gt;..</b>	A DNS A/AAAA or CNAME record, and a DNS PTR record, to internally identify the API load balancer. These records must be resolvable from all the nodes within the cluster.
		 <p><b>IMPORTANT</b></p> <p>The API server must be able to resolve the worker nodes by the hostnames that are recorded in Kubernetes. If the API server cannot resolve the node names, then proxied API calls can fail, and you cannot retrieve logs from pods.</p>
Routes	<b>*.apps.&lt;cluster_name&gt;.&lt;base_domain&gt;..</b>	A wildcard DNS A/AAAA or CNAME record that refers to the application ingress load balancer. The application ingress load balancer targets the machines that run the Ingress Controller pods. The Ingress Controller pods run on the compute machines by default. These records must be resolvable by both clients external to the cluster and from all the nodes within the cluster.
		For example, <b>console-openshift-console.apps.&lt;cluster_name&gt;.&lt;base_domain&gt;..</b> is used as a wildcard route to the OpenShift Container Platform console.
Bootstrap machine	<b>bootstrap.&lt;cluster_name&gt;.&lt;base_domain&gt;..</b>	A DNS A/AAAA or CNAME record, and a DNS PTR record, to identify the bootstrap machine. These records must be resolvable by the nodes within the cluster.



Component	Record	Description
Control plane machines	<b>&lt;master&gt;&lt;n&gt;. &lt;cluster_name&gt;. &lt;base_domain&gt;.</b>	DNS A/AAAA or CNAME records and DNS PTR records to identify each machine for the control plane nodes. These records must be resolvable by the nodes within the cluster.
Compute machines	<b>&lt;worker&gt;&lt;n&gt;. &lt;cluster_name&gt;. &lt;base_domain&gt;.</b>	DNS A/AAAA or CNAME records and DNS PTR records to identify each machine for the worker nodes. These records must be resolvable by the nodes within the cluster.



## NOTE

In OpenShift Container Platform 4.4 and later, you do not need to specify etcd host and SRV records in your DNS configuration.

## TIP

You can use the **dig** command to verify name and reverse name resolution. See the section on *Validating DNS resolution for user-provisioned infrastructure* for detailed validation steps.

### 15.3.4.7.1. Example DNS configuration for user-provisioned clusters

This section provides A and PTR record configuration samples that meet the DNS requirements for deploying OpenShift Container Platform on user-provisioned infrastructure. The samples are not meant to provide advice for choosing one DNS solution over another.

In the examples, the cluster name is **ocp4** and the base domain is **example.com**.

#### Example DNS A record configuration for a user-provisioned cluster

The following example is a BIND zone file that shows sample A records for name resolution in a user-provisioned cluster.

#### Example 15.4. Sample DNS zone database

```
$TTL 1W
@ IN SOA ns1.example.com. root (
    2019070700 ; serial
    3H ; refresh (3 hours)
    30M ; retry (30 minutes)
    2W ; expiry (2 weeks)
    1W ) ; minimum (1 week)
IN NS ns1.example.com.
IN MX 10 smtp.example.com.
;
;
ns1.example.com. IN A 192.168.1.5
smtp.example.com. IN A 192.168.1.5
;
helper.example.com. IN A 192.168.1.5
```

```

helper.ocp4.example.com. IN A 192.168.1.5
;
api.ocp4.example.com. IN A 192.168.1.5 1
api-int.ocp4.example.com. IN A 192.168.1.5 2
;
*.apps.ocp4.example.com. IN A 192.168.1.5 3
;
bootstrap.ocp4.example.com. IN A 192.168.1.96 4
;
master0.ocp4.example.com. IN A 192.168.1.97 5
master1.ocp4.example.com. IN A 192.168.1.98 6
master2.ocp4.example.com. IN A 192.168.1.99 7
;
worker0.ocp4.example.com. IN A 192.168.1.11 8
worker1.ocp4.example.com. IN A 192.168.1.7 9
;
;EOF

```

- 1 Provides name resolution for the Kubernetes API. The record refers to the IP address of the API load balancer.
- 2 Provides name resolution for the Kubernetes API. The record refers to the IP address of the API load balancer and is used for internal cluster communications.
- 3 Provides name resolution for the wildcard routes. The record refers to the IP address of the application ingress load balancer. The application ingress load balancer targets the machines that run the Ingress Controller pods. The Ingress Controller pods run on the compute machines by default.



#### NOTE

In the example, the same load balancer is used for the Kubernetes API and application ingress traffic. In production scenarios, you can deploy the API and application ingress load balancers separately so that you can scale the load balancer infrastructure for each in isolation.

- 4 Provides name resolution for the bootstrap machine.
- 5 6 7 Provides name resolution for the control plane machines.
- 8 9 Provides name resolution for the compute machines.

### Example DNS PTR record configuration for a user-provisioned cluster

The following example BIND zone file shows sample PTR records for reverse name resolution in a user-provisioned cluster.

#### Example 15.5. Sample DNS zone database for reverse records

```

$TTL 1W
@ IN SOA ns1.example.com. root (
  2019070700 ; serial

```

```

3H ; refresh (3 hours)
30M ; retry (30 minutes)
2W ; expiry (2 weeks)
1W ) ; minimum (1 week)
IN NS ns1.example.com.
;
5.1.168.192.in-addr.arpa. IN PTR api.ocp4.example.com. 1
5.1.168.192.in-addr.arpa. IN PTR api-int.ocp4.example.com. 2
;
96.1.168.192.in-addr.arpa. IN PTR bootstrap.ocp4.example.com. 3
;
97.1.168.192.in-addr.arpa. IN PTR master0.ocp4.example.com. 4
98.1.168.192.in-addr.arpa. IN PTR master1.ocp4.example.com. 5
99.1.168.192.in-addr.arpa. IN PTR master2.ocp4.example.com. 6
;
11.1.168.192.in-addr.arpa. IN PTR worker0.ocp4.example.com. 7
7.1.168.192.in-addr.arpa. IN PTR worker1.ocp4.example.com. 8
;
;EOF

```

- 1 Provides reverse DNS resolution for the Kubernetes API. The PTR record refers to the record name of the API load balancer.
- 2 Provides reverse DNS resolution for the Kubernetes API. The PTR record refers to the record name of the API load balancer and is used for internal cluster communications.
- 3 Provides reverse DNS resolution for the bootstrap machine.
- 4 5 6 Provides reverse DNS resolution for the control plane machines.
- 7 8 Provides reverse DNS resolution for the compute machines.

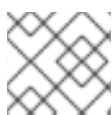

#### NOTE

A PTR record is not required for the OpenShift Container Platform application wildcard.

#### 15.3.4.8. Load balancing requirements for user-provisioned infrastructure

Before you install OpenShift Container Platform, you must provision the API and application ingress load balancing infrastructure. In production scenarios, you can deploy the API and application ingress load balancers separately so that you can scale the load balancer infrastructure for each in isolation.



#### NOTE

If you want to deploy the API and application Ingress load balancers with a Red Hat Enterprise Linux (RHEL) instance, you must purchase the RHEL subscription separately.

The load balancing infrastructure must meet the following requirements:

1. **API load balancer.** Provides a common endpoint for users, both human and machine, to interact with and configure the platform. Configure the following conditions:

- Layer 4 load balancing only. This can be referred to as Raw TCP, SSL Passthrough, or SSL Bridge mode. If you use SSL Bridge mode, you must enable Server Name Indication (SNI) for the API routes.
- A stateless load balancing algorithm. The options vary based on the load balancer implementation.



### IMPORTANT

Do not configure session persistence for an API load balancer. Configuring session persistence for a Kubernetes API server might cause performance issues from excess application traffic for your OpenShift Container Platform cluster and the Kubernetes API that runs inside the cluster.

Configure the following ports on both the front and back of the load balancers:

**Table 15.25. API load balancer**

Port	Back-end machines (pool members)	Internal	External	Description
<b>6443</b>	Bootstrap and control plane. You remove the bootstrap machine from the load balancer after the bootstrap machine initializes the cluster control plane. You must configure the <b>/readyz</b> endpoint for the API server health check probe.	X	X	Kubernetes API server
<b>22623</b>	Bootstrap and control plane. You remove the bootstrap machine from the load balancer after the bootstrap machine initializes the cluster control plane.	X		Machine config server



### NOTE

The load balancer must be configured to take a maximum of 30 seconds from the time the API server turns off the **/readyz** endpoint to the removal of the API server instance from the pool. Within the time frame after **/readyz** returns an error or becomes healthy, the endpoint must have been removed or added. Probing every 5 or 10 seconds, with two successful requests to become healthy and three to become unhealthy, are well-tested values.

2. **Application Ingress load balancer.** Provides an ingress point for application traffic flowing in from outside the cluster. A working configuration for the Ingress router is required for an OpenShift Container Platform cluster. Configure the following conditions:

- Layer 4 load balancing only. This can be referred to as Raw TCP, SSL Passthrough, or SSL Bridge mode. If you use SSL Bridge mode, you must enable Server Name Indication (SNI) for the ingress routes.

- A connection-based or session-based persistence is recommended, based on the options available and types of applications that will be hosted on the platform.

## TIP

If the true IP address of the client can be seen by the application Ingress load balancer, enabling source IP-based session persistence can improve performance for applications that use end-to-end TLS encryption.

Configure the following ports on both the front and back of the load balancers:

**Table 15.26. Application Ingress load balancer**

Port	Back-end machines (pool members)	Internal	External	Description
<b>443</b>	The machines that run the Ingress Controller pods, compute, or worker, by default.	X	X	HTTPS traffic
<b>80</b>	The machines that run the Ingress Controller pods, compute, or worker, by default.	X	X	HTTP traffic



## NOTE

If you are deploying a three-node cluster with zero compute nodes, the Ingress Controller pods run on the control plane nodes. In three-node cluster deployments, you must configure your application Ingress load balancer to route HTTP and HTTPS traffic to the control plane nodes.

### 15.3.4.8.1. Example load balancer configuration for user-provisioned clusters

This section provides an example API and application ingress load balancer configuration that meets the load balancing requirements for user-provisioned clusters. The sample is an `/etc/haproxy/haproxy.cfg` configuration for an HAProxy load balancer. The example is not meant to provide advice for choosing one load balancing solution over another.

In the example, the same load balancer is used for the Kubernetes API and application ingress traffic. In production scenarios, you can deploy the API and application ingress load balancers separately so that you can scale the load balancer infrastructure for each in isolation.



## NOTE

If you are using HAProxy as a load balancer and SELinux is set to **enforcing**, you must ensure that the HAProxy service can bind to the configured TCP port by running `setsebool -P haproxy_connect_any=1`.

### Example 15.6. Sample API and application Ingress load balancer configuration

```
global
log      127.0.0.1 local2
pidfile /var/run/haproxy.pid
```

```

maxconn 4000
daemon
defaults
mode http
log global
option dontlognull
option http-server-close
option redispatch
retries 3
timeout http-request 10s
timeout queue 1m
timeout connect 10s
timeout client 1m
timeout server 1m
timeout http-keep-alive 10s
timeout check 10s
maxconn 3000
listen api-server-6443 1
bind *:6443
mode tcp
server bootstrap bootstrap.ocp4.example.com:6443 check inter 1s backup 2
server master0 master0.ocp4.example.com:6443 check inter 1s
server master1 master1.ocp4.example.com:6443 check inter 1s
server master2 master2.ocp4.example.com:6443 check inter 1s
listen machine-config-server-22623 3
bind *:22623
mode tcp
server bootstrap bootstrap.ocp4.example.com:22623 check inter 1s backup 4
server master0 master0.ocp4.example.com:22623 check inter 1s
server master1 master1.ocp4.example.com:22623 check inter 1s
server master2 master2.ocp4.example.com:22623 check inter 1s
listen ingress-router-443 5
bind *:443
mode tcp
balance source
server worker0 worker0.ocp4.example.com:443 check inter 1s
server worker1 worker1.ocp4.example.com:443 check inter 1s
listen ingress-router-80 6
bind *:80
mode tcp
balance source
server worker0 worker0.ocp4.example.com:80 check inter 1s
server worker1 worker1.ocp4.example.com:80 check inter 1s

```

- 1** Port **6443** handles the Kubernetes API traffic and points to the control plane machines.
- 2** **4** The bootstrap entries must be in place before the OpenShift Container Platform cluster installation and they must be removed after the bootstrap process is complete.
- 3** Port **22623** handles the machine config server traffic and points to the control plane machines.
- 5** Port **443** handles the HTTPS traffic and points to the machines that run the Ingress Controller pods. The Ingress Controller pods run on the compute machines by default.
- 6** Port **80** handles the HTTP traffic and points to the machines that run the Ingress Controller pods. The Ingress Controller pods run on the compute machines by default.



## NOTE

If you are deploying a three-node cluster with zero compute nodes, the Ingress Controller pods run on the control plane nodes. In three-node cluster deployments, you must configure your application Ingress load balancer to route HTTP and HTTPS traffic to the control plane nodes.

## TIP

If you are using HAProxy as a load balancer, you can check that the **haproxy** process is listening on ports **6443**, **22623**, **443**, and **80** by running **netstat -nltp** on the HAProxy node.

### 15.3.5. Preparing the user-provisioned infrastructure

Before you install OpenShift Container Platform on user-provisioned infrastructure, you must prepare the underlying infrastructure.

This section provides details about the high-level steps required to set up your cluster infrastructure in preparation for an OpenShift Container Platform installation. This includes configuring IP networking and network connectivity for your cluster nodes, preparing a web server for the Ignition files, enabling the required ports through your firewall, and setting up the required DNS and load balancing infrastructure.

After preparation, your cluster infrastructure must meet the requirements outlined in the *Requirements for a cluster with user-provisioned infrastructure* section.

#### Prerequisites

- You have reviewed the [OpenShift Container Platform 4.x Tested Integrations](#) page.
- You have reviewed the infrastructure requirements detailed in the *Requirements for a cluster with user-provisioned infrastructure* section.

#### Procedure

1. Set up static IP addresses.
2. Set up an HTTP or HTTPS server to provide Ignition files to the cluster nodes.
3. Ensure that your network infrastructure provides the required network connectivity between the cluster components. See the *Networking requirements for user-provisioned infrastructure* section for details about the requirements.
4. Configure your firewall to enable the ports required for the OpenShift Container Platform cluster components to communicate. See *Networking requirements for user-provisioned infrastructure* section for details about the ports that are required.

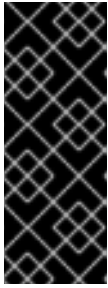

### IMPORTANT

By default, port **1936** is accessible for an OpenShift Container Platform cluster, because each control plane node needs access to this port.

Avoid using the Ingress load balancer to expose this port, because doing so might result in the exposure of sensitive information, such as statistics and metrics, related to Ingress Controllers.

5. Setup the required DNS infrastructure for your cluster.
  - a. Configure DNS name resolution for the Kubernetes API, the application wildcard, the bootstrap machine, the control plane machines, and the compute machines.
  - b. Configure reverse DNS resolution for the Kubernetes API, the bootstrap machine, the control plane machines, and the compute machines.  
See the *User-provisioned DNS requirements* section for more information about the OpenShift Container Platform DNS requirements.
6. Validate your DNS configuration.
  - a. From your installation node, run DNS lookups against the record names of the Kubernetes API, the wildcard routes, and the cluster nodes. Validate that the IP addresses in the responses correspond to the correct components.
  - b. From your installation node, run reverse DNS lookups against the IP addresses of the load balancer and the cluster nodes. Validate that the record names in the responses correspond to the correct components.  
See the *Validating DNS resolution for user-provisioned infrastructure* section for detailed DNS validation steps.
7. Provision the required API and application ingress load balancing infrastructure. See the *Load balancing requirements for user-provisioned infrastructure* section for more information about the requirements.



### NOTE

Some load balancing solutions require the DNS name resolution for the cluster nodes to be in place before the load balancing is initialized.

### 15.3.6. Validating DNS resolution for user-provisioned infrastructure

You can validate your DNS configuration before installing OpenShift Container Platform on user-provisioned infrastructure.



### IMPORTANT

The validation steps detailed in this section must succeed before you install your cluster.

#### Prerequisites

- You have configured the required DNS records for your user-provisioned infrastructure.

#### Procedure



1. From your installation node, run DNS lookups against the record names of the Kubernetes API, the wildcard routes, and the cluster nodes. Validate that the IP addresses contained in the responses correspond to the correct components.
  - a. Perform a lookup against the Kubernetes API record name. Check that the result points to the IP address of the API load balancer:

```
$ dig +noall +answer @<nameserver_ip> api.<cluster_name>.<base_domain> 1
```

- 1 Replace **<nameserver\_ip>** with the IP address of the nameserver, **<cluster\_name>** with your cluster name, and **<base\_domain>** with your base domain name.

#### Example output

```
api.ocp4.example.com. 0 IN A 192.168.1.5
```

- b. Perform a lookup against the Kubernetes internal API record name. Check that the result points to the IP address of the API load balancer:

```
$ dig +noall +answer @<nameserver_ip> api-int.<cluster_name>.<base_domain>
```

#### Example output

```
api-int.ocp4.example.com. 0 IN A 192.168.1.5
```

- c. Test an example **\*.apps.<cluster\_name>.<base\_domain>** DNS wildcard lookup. All of the application wildcard lookups must resolve to the IP address of the application ingress load balancer:

```
$ dig +noall +answer @<nameserver_ip> random.apps.<cluster_name>.<base_domain>
```

#### Example output

```
random.apps.ocp4.example.com. 0 IN A 192.168.1.5
```



#### NOTE

In the example outputs, the same load balancer is used for the Kubernetes API and application ingress traffic. In production scenarios, you can deploy the API and application ingress load balancers separately so that you can scale the load balancer infrastructure for each in isolation.

You can replace **random** with another wildcard value. For example, you can query the route to the OpenShift Container Platform console:

```
$ dig +noall +answer @<nameserver_ip> console-openshift-console.apps.<cluster_name>.<base_domain>
```

#### Example output

```
console-openshift-console.apps.ocp4.example.com. 0 IN A 192.168.1.5
```

- d. Run a lookup against the bootstrap DNS record name. Check that the result points to the IP address of the bootstrap node:

```
$ dig +noall +answer @<nameserver_ip> bootstrap.<cluster_name>.<base_domain>
```

### Example output

```
bootstrap.ocp4.example.com. 0 IN A 192.168.1.96
```

- e. Use this method to perform lookups against the DNS record names for the control plane and compute nodes. Check that the results correspond to the IP addresses of each node.
2. From your installation node, run reverse DNS lookups against the IP addresses of the load balancer and the cluster nodes. Validate that the record names contained in the responses correspond to the correct components.

- a. Perform a reverse lookup against the IP address of the API load balancer. Check that the response includes the record names for the Kubernetes API and the Kubernetes internal API:

```
$ dig +noall +answer @<nameserver_ip> -x 192.168.1.5
```

### Example output

```
5.1.168.192.in-addr.arpa. 0 IN PTR api-int.ocp4.example.com. 1
5.1.168.192.in-addr.arpa. 0 IN PTR api.ocp4.example.com. 2
```

1 Provides the record name for the Kubernetes internal API.

2 Provides the record name for the Kubernetes API.



### NOTE

A PTR record is not required for the OpenShift Container Platform application wildcard. No validation step is needed for reverse DNS resolution against the IP address of the application ingress load balancer.

- b. Perform a reverse lookup against the IP address of the bootstrap node. Check that the result points to the DNS record name of the bootstrap node:

```
$ dig +noall +answer @<nameserver_ip> -x 192.168.1.96
```

### Example output

```
96.1.168.192.in-addr.arpa. 0 IN PTR bootstrap.ocp4.example.com.
```

- c. Use this method to perform reverse lookups against the IP addresses for the control plane and compute nodes. Check that the results correspond to the DNS record names of each node.

### 15.3.7. Generating a key pair for cluster node SSH access

During an OpenShift Container Platform installation, you can provide an SSH public key to the installation program. The key is passed to the Red Hat Enterprise Linux CoreOS (RHCOS) nodes through their Ignition config files and is used to authenticate SSH access to the nodes. The key is added to the `~/.ssh/authorized_keys` list for the **core** user on each node, which enables password-less authentication.

After the key is passed to the nodes, you can use the key pair to SSH in to the RHCOS nodes as the user **core**. To access the nodes through SSH, the private key identity must be managed by SSH for your local user.

If you want to SSH in to your cluster nodes to perform installation debugging or disaster recovery, you must provide the SSH public key during the installation process. The `./openshift-install gather` command also requires the SSH public key to be in place on the cluster nodes.



#### IMPORTANT

Do not skip this procedure in production environments, where disaster recovery and debugging is required.

#### Procedure

1. If you do not have an existing SSH key pair on your local machine to use for authentication onto your cluster nodes, create one. For example, on a computer that uses a Linux operating system, run the following command:

```
$ ssh-keygen -t ed25519 -N "" -f <path>/<file_name> 1
```

- 1 Specify the path and file name, such as `~/.ssh/id_ed25519`, of the new SSH key. If you have an existing key pair, ensure your public key is in the your `~/.ssh` directory.



#### NOTE

If you plan to install an OpenShift Container Platform cluster that uses FIPS validated or Modules In Process cryptographic libraries on the **x86\_64** architecture, do not create a key that uses the **ed25519** algorithm. Instead, create a key that uses the **rsa** or **ecdsa** algorithm.

2. View the public SSH key:

```
$ cat <path>/<file_name>.pub
```

For example, run the following to view the `~/.ssh/id_ed25519.pub` public key:

```
$ cat ~/.ssh/id_ed25519.pub
```

3. Add the SSH private key identity to the SSH agent for your local user, if it has not already been added. SSH agent management of the key is required for password-less SSH authentication onto your cluster nodes, or if you want to use the `./openshift-install gather` command.

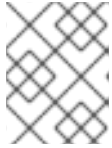
**NOTE**

On some distributions, default SSH private key identities such as `~/.ssh/id_rsa` and `~/.ssh/id_dsa` are managed automatically.

- a. If the **ssh-agent** process is not already running for your local user, start it as a background task:

```
$ eval "$(ssh-agent -s)"
```

**Example output**

```
Agent pid 31874
```

**NOTE**

If your cluster is in FIPS mode, only use FIPS-compliant algorithms to generate the SSH key. The key must be either RSA or ECDSA.

4. Add your SSH private key to the **ssh-agent**:

```
$ ssh-add <path>/<file_name> 1
```

- 1** Specify the path and file name for your SSH private key, such as `~/.ssh/id_ed25519`

**Example output**

```
Identity added: /home/<you>/<path>/<file_name> (<computer_name>)
```

**Next steps**

- When you install OpenShift Container Platform, provide the SSH public key to the installation program.

**15.3.8. Manually creating the installation configuration file**

For user-provisioned installations of OpenShift Container Platform, you manually generate your installation configuration file.

**Prerequisites**

- You have an SSH public key on your local machine to provide to the installation program. The key will be used for SSH authentication onto your cluster nodes for debugging and disaster recovery.
- You have obtained the OpenShift Container Platform installation program and the pull secret for your cluster.

**Procedure**

1. Create an installation directory to store your required installation assets in:

```
$ mkdir <installation_directory>
```

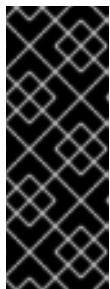

### IMPORTANT

You must create a directory. Some installation assets, like bootstrap X.509 certificates have short expiration intervals, so you must not reuse an installation directory. If you want to reuse individual files from another cluster installation, you can copy them into your directory. However, the file names for the installation assets might change between releases. Use caution when copying installation files from an earlier OpenShift Container Platform version.

2. Customize the sample **install-config.yaml** file template that is provided and save it in the **<installation\_directory>**.



### NOTE

You must name this configuration file **install-config.yaml**.



### NOTE

For some platform types, you can alternatively run **./openshift-install create install-config --dir <installation\_directory>** to generate an **install-config.yaml** file. You can provide details about your cluster configuration at the prompts.

3. Back up the **install-config.yaml** file so that you can use it to install multiple clusters.



### IMPORTANT

The **install-config.yaml** file is consumed during the next step of the installation process. You must back it up now.

#### 15.3.8.1. Installation configuration parameters

Before you deploy an OpenShift Container Platform cluster, you provide a customized **install-config.yaml** installation configuration file that describes the details for your environment.

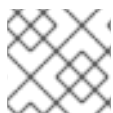

### NOTE

After installation, you cannot modify these parameters in the **install-config.yaml** file.

##### 15.3.8.1.1. Required configuration parameters

Required installation configuration parameters are described in the following table:

Table 15.27. Required parameters

Parameter	Description	Values
-----------	-------------	--------

Parameter	Description	Values
<b>apiVersion</b>	The API version for the <b>install-config.yaml</b> content. The current version is <b>v1</b> . The installer may also support older API versions.	String
<b>baseDomain</b>	The base domain of your cloud provider. The base domain is used to create routes to your OpenShift Container Platform cluster components. The full DNS name for your cluster is a combination of the <b>baseDomain</b> and <b>metadata.name</b> parameter values that uses the <b>&lt;metadata.name&gt;</b> . <b>&lt;baseDomain&gt;</b> format.	A fully-qualified domain or subdomain name, such as <b>example.com</b> .
<b>metadata</b>	Kubernetes resource <b>ObjectMeta</b> , from which only the <b>name</b> parameter is consumed.	Object
<b>metadata.name</b>	The name of the cluster. DNS records for the cluster are all subdomains of <b>{{.metadata.name}}</b> . <b>{{.baseDomain}}</b> .	String of lowercase letters, hyphens (-), and periods (.), such as <b>dev</b> .
<b>platform</b>	The configuration for the specific platform upon which to perform the installation: <b>alibabacloud</b> , <b>aws</b> , <b>baremetal</b> , <b>azure</b> , <b>gcp</b> , <b>ibmcloud</b> , <b>openstack</b> , <b>ovirt</b> , <b>vsphere</b> , or <b>{}</b> . For additional information about <b>platform.&lt;platform&gt;</b> parameters, consult the table for your specific platform that follows.	Object

Parameter	Description	Values
<b>pullSecret</b>	Get a <a href="#">pull secret from the Red Hat OpenShift Cluster Manager</a> to authenticate downloading container images for OpenShift Container Platform components from services such as Quay.io.	<pre>{   "auths":{     "cloud.openshift.com":{       "auth":"b3Blb=",       "email":"you@example.com"     },     "quay.io":{       "auth":"b3Blb=",       "email":"you@example.com"     }   } }</pre>

### 15.3.8.1.2. Network configuration parameters

You can customize your installation configuration based on the requirements of your existing network infrastructure. For example, you can expand the IP address block for the cluster network or provide different IP address blocks than the defaults.

Only IPv4 addresses are supported.

Table 15.28. Network parameters

Parameter	Description	Values
<b>networking</b>	The configuration for the cluster network.	Object  <p><b>NOTE</b></p> <p>You cannot modify parameters specified by the <b>networking</b> object after installation.</p>
<b>networking.network Type</b>	The cluster network provider Container Network Interface (CNI) plugin to install.	Either <b>OpenShiftSDN</b> or <b>OVNKubernetes</b> . <b>OpenShiftSDN</b> is a CNI provider for all-Linux networks. <b>OVNKubernetes</b> is a CNI provider for Linux networks and hybrid networks that contain both Linux and Windows servers. The default value is <b>OpenShiftSDN</b> .

Parameter	Description	Values
<b>networking.clusterNetwork</b>	<p>The IP address blocks for pods.</p> <p>The default value is <b>10.128.0.0/14</b> with a host prefix of <b>/23</b>.</p> <p>If you specify multiple IP address blocks, the blocks must not overlap.</p>	<p>An array of objects. For example:</p> <pre>networking:   clusterNetwork:     - cidr: 10.128.0.0/14       hostPrefix: 23</pre>
<b>networking.clusterNetwork.cidr</b>	<p>Required if you use <b>networking.clusterNetwork</b>. An IP address block.</p> <p>An IPv4 network.</p>	<p>An IP address block in Classless Inter-Domain Routing (CIDR) notation. The prefix length for an IPv4 block is between <b>0</b> and <b>32</b>.</p>
<b>networking.clusterNetwork.hostPrefix</b>	<p>The subnet prefix length to assign to each individual node. For example, if <b>hostPrefix</b> is set to <b>23</b> then each node is assigned a <b>/23</b> subnet out of the given <b>cidr</b>. A <b>hostPrefix</b> value of <b>23</b> provides 510 (<math>2^{(32 - 23)} - 2</math>) pod IP addresses.</p>	<p>A subnet prefix.</p> <p>The default value is <b>23</b>.</p>
<b>networking.serviceNetwork</b>	<p>The IP address block for services. The default value is <b>172.30.0.0/16</b>.</p> <p>The OpenShift SDN and OVN-Kubernetes network providers support only a single IP address block for the service network.</p>	<p>An array with an IP address block in CIDR format. For example:</p> <pre>networking:   serviceNetwork:     - 172.30.0.0/16</pre>
<b>networking.machineNetwork</b>	<p>The IP address blocks for machines.</p> <p>If you specify multiple IP address blocks, the blocks must not overlap.</p> <p>If you specify multiple IP kernel arguments, the <b>machineNetwork.cidr</b> value must be the CIDR of the primary network.</p>	<p>An array of objects. For example:</p> <pre>networking:   machineNetwork:     - cidr: 10.0.0.0/16</pre>



Parameter	Description	Values
<b>networking.machineNetwork.cidr</b>	Required if you use <b>networking.machineNetwork</b> . An IP address block. The default value is <b>10.0.0.0/16</b> for all platforms other than libvirt. For libvirt, the default value is <b>192.168.126.0/24</b> .	An IP network block in CIDR notation. For example, <b>10.0.0.0/16</b> .  <b>NOTE</b> Set the <b>networking.machineNetwork</b> to match the CIDR that the preferred NIC resides in.

### 15.3.8.1.3. Optional configuration parameters



Optional installation configuration parameters are described in the following table:

Table 15.29. Optional parameters



Parameter	Description	Values
<b>additionalTrustBundle</b>	A PEM-encoded X.509 certificate bundle that is added to the nodes' trusted certificate store. This trust bundle may also be used when a proxy has been configured.	String
<b>cgroupsV2</b>	Enables <a href="#">Linux control groups version 2</a> (cgroups v2) on specific nodes in your cluster. The OpenShift Container Platform process for enabling cgroups v2 disables all cgroup version 1 controllers and hierarchies. The OpenShift Container Platform cgroups version 2 feature is in Developer Preview and is not supported by Red Hat at this time.	<b>true</b>
<b>compute</b>	The configuration for the machines that comprise the compute nodes.	Array of <b>MachinePool</b> objects.
<b>compute.architecture</b>	Determines the instruction set architecture of the machines in the pool. Currently, heterogeneous clusters are not supported, so all pools must specify the same architecture. Valid values are <b>s390x</b> (the default).	String

Parameter	Description	Values
<b>compute.hyperthreading</b>	<p>Whether to enable or disable simultaneous multithreading, or <b>hyperthreading</b>, on compute machines. By default, simultaneous multithreading is enabled to increase the performance of your machines' cores.</p> <div style="display: flex; align-items: center;">  <div> <p><b>IMPORTANT</b></p> <p>If you disable simultaneous multithreading, ensure that your capacity planning accounts for the dramatically decreased machine performance.</p> </div> </div>	<b>Enabled</b> or <b>Disabled</b>
<b>compute.name</b>	Required if you use <b>compute</b> . The name of the machine pool.	<b>worker</b>
<b>compute.platform</b>	Required if you use <b>compute</b> . Use this parameter to specify the cloud provider to host the worker machines. This parameter value must match the <b>controlPlane.platform</b> parameter value.	<b>alibabacloud, aws, azure, gcp, ibmcloud, openstack, ovirt, vsphere</b> , or <b>{}</b>
<b>compute.replicas</b>	The number of compute machines, which are also known as worker machines, to provision.	A positive integer greater than or equal to <b>2</b> . The default value is <b>3</b> .
<b>controlPlane</b>	The configuration for the machines that comprise the control plane.	Array of <b>MachinePool</b> objects.
<b>controlPlane.architecture</b>	Determines the instruction set architecture of the machines in the pool. Currently, heterogeneous clusters are not supported, so all pools must specify the same architecture. Valid values are <b>s390x</b> (the default).	String

Parameter	Description	Values
<b>controlPlane.hypert hreading</b>	<p>Whether to enable or disable simultaneous multithreading, or <b>hyperthreading</b>, on control plane machines. By default, simultaneous multithreading is enabled to increase the performance of your machines' cores.</p>  <p><b>IMPORTANT</b></p> <p>If you disable simultaneous multithreading, ensure that your capacity planning accounts for the dramatically decreased machine performance.</p>	<b>Enabled</b> or <b>Disabled</b>
<b>controlPlane.name</b>	Required if you use <b>controlPlane</b> . The name of the machine pool.	<b>master</b>
<b>controlPlane.platfor m</b>	Required if you use <b>controlPlane</b> . Use this parameter to specify the cloud provider that hosts the control plane machines. This parameter value must match the <b>compute.platform</b> parameter value.	<b>alibabacloud, aws, azure, gcp, ibmcloud, openstack, ovirt, vsphere, or {}</b>
<b>controlPlane.replica s</b>	The number of control plane machines to provision.	The only supported value is <b>3</b> , which is the default value.

Parameter	Description	Values
<b>credentialsMode</b>	<p>The Cloud Credential Operator (CCO) mode. If no mode is specified, the CCO dynamically tries to determine the capabilities of the provided credentials, with a preference for mint mode on the platforms where multiple modes are supported.</p> <p> <b>NOTE</b></p> <p>Not all CCO modes are supported for all cloud providers. For more information on CCO modes, see the <i>Cloud Credential Operator</i> entry in the <i>Cluster Operators</i> reference content.</p> <p> <b>NOTE</b></p> <p>If your AWS account has service control policies (SCP) enabled, you must configure the <b>credentialsMode</b> parameter to <b>Mint</b>, <b>Passthrough</b> or <b>Manual</b>.</p>	<b>Mint, Passthrough, Manual</b> or an empty string ("").

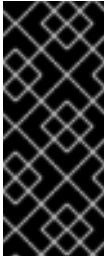
Parameter	Description	Values
<b>fips</b>	<p>Enable or disable FIPS mode. The default is <b>false</b> (disabled). If FIPS mode is enabled, the Red Hat Enterprise Linux CoreOS (RHCOS) machines that OpenShift Container Platform runs on bypass the default Kubernetes cryptography suite and use the cryptography modules that are provided with RHCOS instead.</p> <div style="display: flex; align-items: flex-start;"> <div style="width: 20px; height: 100px; background: repeating-linear-gradient(45deg, transparent, transparent 2px, black 2px, black 4px); margin-right: 10px;"></div> <div> <p><b>IMPORTANT</b></p> <p>To enable FIPS mode for your cluster, you must run the installation program from a Red Hat Enterprise Linux (RHEL) computer configured to operate in FIPS mode. For more information about configuring FIPS mode on RHEL, see <a href="#">Installing the system in FIPS mode</a>. The use of FIPS validated or Modules In Process cryptographic libraries is only supported on OpenShift Container Platform deployments on the <b>x86_64</b> architecture.</p> </div> </div> <div style="display: flex; align-items: flex-start; margin-top: 10px;"> <div style="width: 20px; height: 100px; background: repeating-linear-gradient(45deg, transparent, transparent 2px, black 2px, black 4px); margin-right: 10px;"></div> <div> <p><b>NOTE</b></p> <p>If you are using Azure File storage, you cannot enable FIPS mode.</p> </div> </div>	<b>false</b> or <b>true</b>
<b>imageContentSources</b>	Sources and repositories for the release-image content.	Array of objects. Includes a <b>source</b> and, optionally, <b>mirrors</b> , as described in the following rows of this table.
<b>imageContentSources.source</b>	Required if you use <b>imageContentSources</b> . Specify the repository that users refer to, for example, in image pull specifications.	String
<b>imageContentSources.mirrors</b>	Specify one or more repositories that may also contain the same images.	Array of strings

Parameter	Description	Values
<b>publish</b>	How to publish or expose the user-facing endpoints of your cluster, such as the Kubernetes API, OpenShift routes.	<p><b>Internal</b> or <b>External</b>. The default value is <b>External</b>.</p> <p>Setting this field to <b>Internal</b> is not supported on non-cloud platforms and IBM Cloud VPC.</p> <div style="display: flex; align-items: flex-start;">  <div> <p><b>IMPORTANT</b></p> <p>If the value of the field is set to <b>Internal</b>, the cluster will become non-functional. For more information, refer to <a href="#">BZ#1953035</a>.</p> </div> </div>
<b>sshKey</b>	<p>The SSH key or keys to authenticate access your cluster machines.</p> <div style="display: flex; align-items: flex-start;">  <div> <p><b>NOTE</b></p> <p>For production OpenShift Container Platform clusters on which you want to perform installation debugging or disaster recovery, specify an SSH key that your <b>ssh-agent</b> process uses.</p> </div> </div>	<p>One or more keys. For example:</p> <pre>sshKey:   &lt;key1&gt;   &lt;key2&gt;   &lt;key3&gt;</pre>

### 15.3.8.2. Sample install-config.yaml file for IBM Z

You can customize the **install-config.yaml** file to specify more details about your OpenShift Container Platform cluster's platform or modify the values of the required parameters.

```
apiVersion: v1
baseDomain: example.com 1
compute: 2
- hyperthreading: Enabled 3
  name: worker
  replicas: 0 4
  architecture : s390x
controlPlane: 5
  hyperthreading: Enabled 6
  name: master
  replicas: 3 7
  architecture : s390x
```



manually deploy the compute machines before you finish installing the cluster.

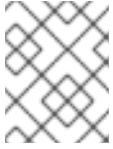

#### NOTE

If you are installing a three-node cluster, do not deploy any compute machines when you install the Red Hat Enterprise Linux CoreOS (RHCOS) machines.

- 7 The number of control plane machines that you add to the cluster. Because the cluster uses these values as the number of etcd endpoints in the cluster, the value must match the number of control plane machines that you deploy.
- 8 The cluster name that you specified in your DNS records.
- 9 A block of IP addresses from which pod IP addresses are allocated. This block must not overlap with existing physical networks. These IP addresses are used for the pod network. If you need to access the pods from an external network, you must configure load balancers and routers to manage the traffic.

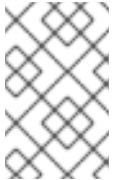

#### NOTE

Class E CIDR range is reserved for a future use. To use the Class E CIDR range, you must ensure your networking environment accepts the IP addresses within the Class E CIDR range.

- 10 The subnet prefix length to assign to each individual node. For example, if **hostPrefix** is set to **23**, then each node is assigned a **/23** subnet out of the given **cidr**, which allows for 510 ( $2^{(32 - 23)} - 2$ ) pod IP addresses. If you are required to provide access to nodes from an external network, configure load balancers and routers to manage the traffic.
- 11 The IP address pool to use for service IP addresses. You can enter only one IP address pool. This block must not overlap with existing physical networks. If you need to access the services from an external network, configure load balancers and routers to manage the traffic.
- 12 You must set the platform to **none**. You cannot provide additional platform configuration variables for IBM Z infrastructure.



#### IMPORTANT

Clusters that are installed with the platform type **none** are unable to use some features, such as managing compute machines with the Machine API. This limitation applies even if the compute machines that are attached to the cluster are installed on a platform that would normally support the feature. This parameter cannot be changed after installation.

- 13 Whether to enable or disable FIPS mode. By default, FIPS mode is not enabled. If FIPS mode is enabled, the Red Hat Enterprise Linux CoreOS (RHCOS) machines that OpenShift Container Platform runs on bypass the default Kubernetes cryptography suite and use the cryptography modules that are provided with RHCOS instead.





## IMPORTANT

To enable FIPS mode for your cluster, you must run the installation program from a Red Hat Enterprise Linux (RHEL) computer configured to operate in FIPS mode. For more information about configuring FIPS mode on RHEL, see [Installing the system in FIPS mode](#). The use of FIPS validated or Modules In Process cryptographic libraries is only supported on OpenShift Container Platform deployments on the **x86\_64** architecture.

- 14 For **<local\_registry>**, specify the registry domain name, and optionally the port, that your mirror registry uses to serve content. For example, **registry.example.com** or **registry.example.com:5000**. For **<credentials>**, specify the base64-encoded user name and password for your mirror registry.
- 15 The SSH public key for the **core** user in Red Hat Enterprise Linux CoreOS (RHCOS).



## NOTE

For production OpenShift Container Platform clusters on which you want to perform installation debugging or disaster recovery, specify an SSH key that your **ssh-agent** process uses.

- 16 Add the **additionalTrustBundle** parameter and value. The value must be the contents of the certificate file that you used for your mirror registry. The certificate file can be an existing, trusted certificate authority or the self-signed certificate that you generated for the mirror registry.
- 17 Provide the **imageContentSources** section from the output of the command to mirror the repository.

### 15.3.8.3. Configuring the cluster-wide proxy during installation

Production environments can deny direct access to the internet and instead have an HTTP or HTTPS proxy available. You can configure a new OpenShift Container Platform cluster to use a proxy by configuring the proxy settings in the **install-config.yaml** file.

#### Prerequisites

- You have an existing **install-config.yaml** file.
- You reviewed the sites that your cluster requires access to and determined whether any of them need to bypass the proxy. By default, all cluster egress traffic is proxied, including calls to hosting cloud provider APIs. You added sites to the **Proxy** object's **spec.noProxy** field to bypass the proxy if necessary.



## NOTE

The **Proxy** object **status.noProxy** field is populated with the values of the **networking.machineNetwork[].cidr**, **networking.clusterNetwork[].cidr**, and **networking.serviceNetwork[]** fields from your installation configuration.

For installations on Amazon Web Services (AWS), Google Cloud Platform (GCP), Microsoft Azure, and Red Hat OpenStack Platform (RHOSP), the **Proxy** object **status.noProxy** field is also populated with the instance metadata endpoint (**169.254.169.254**).

## Procedure

1. Edit your **install-config.yaml** file and add the proxy settings. For example:

```

apiVersion: v1
baseDomain: my.domain.com
proxy:
  httpProxy: http://<username>:<pswd>@<ip>:<port> 1
  httpsProxy: https://<username>:<pswd>@<ip>:<port> 2
  noProxy: example.com 3
  additionalTrustBundle: | 4
    -----BEGIN CERTIFICATE-----
    <MY_TRUSTED_CA_CERT>
    -----END CERTIFICATE-----
...

```

- 1 A proxy URL to use for creating HTTP connections outside the cluster. The URL scheme must be **http**.
- 2 A proxy URL to use for creating HTTPS connections outside the cluster.
- 3 A comma-separated list of destination domain names, IP addresses, or other network CIDRs to exclude from proxying. Preface a domain with **.** to match subdomains only. For example, **.y.com** matches **x.y.com**, but not **y.com**. Use **\*** to bypass the proxy for all destinations.
- 4 If provided, the installation program generates a config map that is named **user-ca-bundle** in the **openshift-config** namespace that contains one or more additional CA certificates that are required for proxying HTTPS connections. The Cluster Network Operator then creates a **trusted-ca-bundle** config map that merges these contents with the Red Hat Enterprise Linux CoreOS (RHCOS) trust bundle, and this config map is referenced in the **trustedCA** field of the **Proxy** object. The **additionalTrustBundle** field is required unless the proxy's identity certificate is signed by an authority from the RHCOS trust bundle.



### NOTE

The installation program does not support the proxy **readinessEndpoints** field.



### NOTE

If the installer times out, restart and then complete the deployment by using the **wait-for** command of the installer. For example:

```
$ ./openshift-install wait-for install-complete --log-level debug
```

2. Save the file and reference it when installing OpenShift Container Platform.

The installation program creates a cluster-wide proxy that is named **cluster** that uses the proxy settings in the provided **install-config.yaml** file. If no proxy settings are provided, a **cluster Proxy** object is still created, but it will have a nil **spec**.

**NOTE**

Only the **Proxy** object named **cluster** is supported, and no additional proxies can be created.

**15.3.8.4. Configuring a three-node cluster**

Optionally, you can deploy zero compute machines in a minimal three node cluster that consists of three control plane machines only. This provides smaller, more resource efficient clusters for cluster administrators and developers to use for testing, development, and production.

In three-node OpenShift Container Platform environments, the three control plane machines are schedulable, which means that your application workloads are scheduled to run on them.

**Prerequisites**

- You have an existing **install-config.yaml** file.

**Procedure**

- Ensure that the number of compute replicas is set to **0** in your **install-config.yaml** file, as shown in the following **compute** stanza:

```
compute:
- name: worker
  platform: {}
  replicas: 0
```

**NOTE**

You must set the value of the **replicas** parameter for the compute machines to **0** when you install OpenShift Container Platform on user-provisioned infrastructure, regardless of the number of compute machines you are deploying. In installer-provisioned installations, the parameter controls the number of compute machines that the cluster creates and manages for you. This does not apply to user-provisioned installations, where the compute machines are deployed manually.

**NOTE**

The preferred resource for control plane nodes is six vCPUs and 21 GB. For three control plane nodes this is the memory + vCPU equivalent of a minimum five-node cluster. You should back the three nodes, each installed on a 120 GB disk, with three IFLs that are SMT2 enabled. The minimum tested setup is three vCPUs and 10 GB on a 120 GB disk for each control plane node.

For three-node cluster installations, follow these next steps:

- If you are deploying a three-node cluster with zero compute nodes, the Ingress Controller pods run on the control plane nodes. In three-node cluster deployments, you must configure your application ingress load balancer to route HTTP and HTTPS traffic to the control plane nodes. See the *Load balancing requirements for user-provisioned infrastructure* section for more information.

- When you create the Kubernetes manifest files in the following procedure, ensure that the **mastersSchedulable** parameter in the `<installation_directory>/manifests/cluster-scheduler-02-config.yml` file is set to **true**. This enables your application workloads to run on the control plane nodes.
- Do not deploy any compute nodes when you create the Red Hat Enterprise Linux CoreOS (RHCOS) machines.

### 15.3.9. Cluster Network Operator configuration

The configuration for the cluster network is specified as part of the Cluster Network Operator (CNO) configuration and stored in a custom resource (CR) object that is named **cluster**. The CR specifies the fields for the **Network** API in the **operator.openshift.io** API group.

The CNO configuration inherits the following fields during cluster installation from the **Network** API in the **Network.config.openshift.io** API group and these fields cannot be changed:

#### **clusterNetwork**

IP address pools from which pod IP addresses are allocated.

#### **serviceNetwork**

IP address pool for services.

#### **defaultNetwork.type**

Cluster network provider, such as OpenShift SDN or OVN-Kubernetes.

You can specify the cluster network provider configuration for your cluster by setting the fields for the **defaultNetwork** object in the CNO object named **cluster**.

#### 15.3.9.1. Cluster Network Operator configuration object

The fields for the Cluster Network Operator (CNO) are described in the following table:

**Table 15.30. Cluster Network Operator configuration object**

Field	Type	Description
<b>metadata.name</b>	<b>string</b>	The name of the CNO object. This name is always <b>cluster</b> .
<b>spec.clusterNetwork</b>	<b>array</b>	<p>A list specifying the blocks of IP addresses from which pod IP addresses are allocated and the subnet prefix length assigned to each individual node in the cluster. For example:</p> <pre>spec:   clusterNetwork:   - cidr: 10.128.0.0/19     hostPrefix: 23   - cidr: 10.128.32.0/19     hostPrefix: 23</pre> <p>You can customize this field only in the <b>install-config.yaml</b> file before you create the manifests. The value is read-only in the manifest file.</p>

Field	Type	Description
<b>spec.serviceNetwork</b>	<b>array</b>	<p>A block of IP addresses for services. The OpenShift SDN and OVN-Kubernetes Container Network Interface (CNI) network providers support only a single IP address block for the service network. For example:</p> <pre>spec:   serviceNetwork:   - 172.30.0.0/14</pre> <p>You can customize this field only in the <b>install-config.yaml</b> file before you create the manifests. The value is read-only in the manifest file.</p>
<b>spec.defaultNetwork</b>	<b>object</b>	Configures the Container Network Interface (CNI) cluster network provider for the cluster network.
<b>spec.kubeProxyConfig</b>	<b>object</b>	The fields for this object specify the kube-proxy configuration. If you are using the OVN-Kubernetes cluster network provider, the kube-proxy configuration has no effect.

### defaultNetwork object configuration

The values for the **defaultNetwork** object are defined in the following table:

Table 15.31. **defaultNetwork** object

Field	Type	Description
<b>type</b>	<b>string</b>	<p>Either <b>OpenShiftSDN</b> or <b>OVNKubernetes</b>. The cluster network provider is selected during installation. This value cannot be changed after cluster installation.</p> <div style="display: flex; align-items: flex-start;"> <div style="flex: 1;">  </div> <div style="flex: 2;"> <p><b>NOTE</b></p> <p>OpenShift Container Platform uses the OpenShift SDN Container Network Interface (CNI) cluster network provider by default.</p> </div> </div>
<b>openshiftSDNConfig</b>	<b>object</b>	This object is only valid for the OpenShift SDN cluster network provider.
<b>ovnKubernetesConfig</b>	<b>object</b>	This object is only valid for the OVN-Kubernetes cluster network provider.

### Configuration for the OpenShift SDN CNI cluster network provider

The following table describes the configuration fields for the OpenShift SDN Container Network Interface (CNI) cluster network provider.

**Table 15.32. openshiftSDNConfig object**

Field	Type	Description
<b>mode</b>	<b>string</b>	<p>Configures the network isolation mode for OpenShift SDN. The default value is <b>NetworkPolicy</b>.</p> <p>The values <b>Multitenant</b> and <b>Subnet</b> are available for backwards compatibility with OpenShift Container Platform 3.x but are not recommended. This value cannot be changed after cluster installation.</p>
<b>mtu</b>	<b>integer</b>	<p>The maximum transmission unit (MTU) for the VXLAN overlay network. This is detected automatically based on the MTU of the primary network interface. You do not normally need to override the detected MTU.</p> <p>If the auto-detected value is not what you expect it to be, confirm that the MTU on the primary network interface on your nodes is correct. You cannot use this option to change the MTU value of the primary network interface on the nodes.</p> <p>If your cluster requires different MTU values for different nodes, you must set this value to <b>50</b> less than the lowest MTU value in your cluster. For example, if some nodes in your cluster have an MTU of <b>9001</b>, and some have an MTU of <b>1500</b>, you must set this value to <b>1450</b>.</p> <p>This value cannot be changed after cluster installation.</p>
<b>vxlanPort</b>	<b>integer</b>	<p>The port to use for all VXLAN packets. The default value is <b>4789</b>. This value cannot be changed after cluster installation.</p> <p>If you are running in a virtualized environment with existing nodes that are part of another VXLAN network, then you might be required to change this. For example, when running an OpenShift SDN overlay on top of VMware NSX-T, you must select an alternate port for the VXLAN, because both SDNs use the same default VXLAN port number.</p> <p>On Amazon Web Services (AWS), you can select an alternate port for the VXLAN between port <b>9000</b> and port <b>9999</b>.</p>

### Example OpenShift SDN configuration

```
defaultNetwork:
  type: OpenShiftSDN
  openshiftSDNConfig:
    mode: NetworkPolicy
    mtu: 1450
    vxlanPort: 4789
```

### Configuration for the OVN-Kubernetes CNI cluster network provider

The following table describes the configuration fields for the OVN-Kubernetes CNI cluster network provider.

Table 15.33. `ovnKubernetesConfig` object

Field	Type	Description
<code>mtu</code>	<code>integer</code>	<p>The maximum transmission unit (MTU) for the Geneve (Generic Network Virtualization Encapsulation) overlay network. This is detected automatically based on the MTU of the primary network interface. You do not normally need to override the detected MTU.</p> <p>If the auto-detected value is not what you expect it to be, confirm that the MTU on the primary network interface on your nodes is correct. You cannot use this option to change the MTU value of the primary network interface on the nodes.</p> <p>If your cluster requires different MTU values for different nodes, you must set this value to <b>100</b> less than the lowest MTU value in your cluster. For example, if some nodes in your cluster have an MTU of <b>9001</b>, and some have an MTU of <b>1500</b>, you must set this value to <b>1400</b>.</p>
<code>genevePort</code>	<code>integer</code>	The port to use for all Geneve packets. The default value is <b>6081</b> . This value cannot be changed after cluster installation.
<code>ipsecConfig</code>	<code>object</code>	Specify an empty object to enable IPsec encryption. This value cannot be changed after cluster installation.
<code>policyAuditConfig</code>	<code>object</code>	Specify a configuration object for customizing network policy audit logging. If unset, the defaults audit log settings are used.
<code>gatewayConfig</code>	<code>object</code>	<p>Optional: Specify a configuration object for customizing how egress traffic is sent to the node gateway.</p> <div style="display: flex; align-items: flex-start;"> <div style="flex: 1;">  </div> <div style="flex: 2;"> <p><b>NOTE</b></p> <p>While migrating egress traffic, you can expect some disruption to workloads and service traffic until the Cluster Network Operator (CNO) successfully rolls out the changes.</p> </div> </div>

Table 15.34. `policyAuditConfig` object

Field	Type	Description
-------	------	-------------

Field	Type	Description
<b>rateLimit</b>	integer	The maximum number of messages to generate every second per node. The default value is <b>20</b> messages per second.
<b>maxFileSize</b>	integer	The maximum size for the audit log in bytes. The default value is <b>50000000</b> or 50 MB.
<b>destination</b>	string	One of the following additional audit log targets:  <b>libc</b> The libc <b>syslog()</b> function of the journald process on the host. <b>udp:&lt;host&gt;:&lt;port&gt;</b> A syslog server. Replace <b>&lt;host&gt;:&lt;port&gt;</b> with the host and port of the syslog server. <b>unix:&lt;file&gt;</b> A Unix Domain Socket file specified by <b>&lt;file&gt;</b> . <b>null</b> Do not send the audit logs to any additional target.
<b>syslogFacility</b>	string	The syslog facility, such as <b>kern</b> , as defined by RFC5424. The default value is <b>local0</b> .

Table 15.35. gatewayConfig object

Field	Type	Description
<b>routingViaHost</b>	<b>boolean</b>	Set this field to <b>true</b> to send egress traffic from pods to the host networking stack. For highly-specialized installations and applications that rely on manually configured routes in the kernel routing table, you might want to route egress traffic to the host networking stack. By default, egress traffic is processed in OVN to exit the cluster and is not affected by specialized routes in the kernel routing table. The default value is <b>false</b> .  This field has an interaction with the Open vSwitch hardware offloading feature. If you set this field to <b>true</b> , you do not receive the performance benefits of the offloading because egress traffic is processed by the host networking stack.

### Example OVN-Kubernetes configuration with IPsec enabled

```
defaultNetwork:
  type: OVNKubernetes
  ovnKubernetesConfig:
    mtu: 1400
    genevePort: 6081
    ipsecConfig: {}
```



**kubeProxyConfig object configuration**

The values for the **kubeProxyConfig** object are defined in the following table:

**Table 15.36. kubeProxyConfig object**

Field	Type	Description
<b>iptablesSyncPeriod</b>	<b>string</b>	<p>The refresh period for <b>iptables</b> rules. The default value is <b>30s</b>. Valid suffixes include <b>s</b>, <b>m</b>, and <b>h</b> and are described in the <a href="#">Go time package</a> documentation.</p> <div style="display: flex; align-items: flex-start;"> <div style="flex: 1;">  </div> <div style="flex: 2;"> <p><b>NOTE</b></p> <p>Because of performance improvements introduced in OpenShift Container Platform 4.3 and greater, adjusting the <b>iptablesSyncPeriod</b> parameter is no longer necessary.</p> </div> </div>
<b>proxyArguments.iptables-min-sync-period</b>	<b>array</b>	<p>The minimum duration before refreshing <b>iptables</b> rules. This field ensures that the refresh does not happen too frequently. Valid suffixes include <b>s</b>, <b>m</b>, and <b>h</b> and are described in the <a href="#">Go time package</a>. The default value is:</p> <pre> kubeProxyConfig:   proxyArguments:     iptables-min-sync-period:       - 0s </pre>

### 15.3.10. Creating the Kubernetes manifest and Ignition config files

Because you must modify some cluster definition files and manually start the cluster machines, you must generate the Kubernetes manifest and Ignition config files that the cluster needs to configure the machines.

The installation configuration file transforms into the Kubernetes manifests. The manifests wrap into the Ignition configuration files, which are later used to configure the cluster machines.

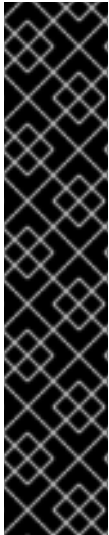

## IMPORTANT

- The Ignition config files that the OpenShift Container Platform installation program generates contain certificates that expire after 24 hours, which are then renewed at that time. If the cluster is shut down before renewing the certificates and the cluster is later restarted after the 24 hours have elapsed, the cluster automatically recovers the expired certificates. The exception is that you must manually approve the pending **node-bootstrapper** certificate signing requests (CSRs) to recover kubelet certificates. See the documentation for *Recovering from expired control plane certificates* for more information.
- It is recommended that you use Ignition config files within 12 hours after they are generated because the 24-hour certificate rotates from 16 to 22 hours after the cluster is installed. By using the Ignition config files within 12 hours, you can avoid installation failure if the certificate update runs during installation.



## NOTE

The installation program that generates the manifest and Ignition files is architecture specific and can be obtained from the [client image mirror](#). The Linux version of the installation program runs on s390x only. This installer program is also available as a Mac OS version.

## Prerequisites

- You obtained the OpenShift Container Platform installation program. For a restricted network installation, these files are on your mirror host.
- You created the **install-config.yaml** installation configuration file.

## Procedure

1. Change to the directory that contains the OpenShift Container Platform installation program and generate the Kubernetes manifests for the cluster:

```
$ ./openshift-install create manifests --dir <installation_directory> 1
```

- 1** For **<installation\_directory>**, specify the installation directory that contains the **install-config.yaml** file you created.



## WARNING

If you are installing a three-node cluster, skip the following step to allow the control plane nodes to be schedulable.



## IMPORTANT

When you configure control plane nodes from the default unschedulable to schedulable, additional subscriptions are required. This is because control plane nodes then become worker nodes.

2. Check that the **mastersSchedulable** parameter in the **<installation\_directory>/manifests/cluster-scheduler-02-config.yml** Kubernetes manifest file is set to **false**. This setting prevents pods from being scheduled on the control plane machines:
  - a. Open the **<installation\_directory>/manifests/cluster-scheduler-02-config.yml** file.
  - b. Locate the **mastersSchedulable** parameter and ensure that it is set to **false**.
  - c. Save and exit the file.
3. To create the Ignition configuration files, run the following command from the directory that contains the installation program:

```
$ ./openshift-install create ignition-configs --dir <installation_directory> 1
```

**1** For **<installation\_directory>**, specify the same installation directory.

Ignition config files are created for the bootstrap, control plane, and compute nodes in the installation directory. The **kubeadmin-password** and **kubeconfig** files are created in the **./<installation\_directory>/auth** directory:

```
.
├── auth
│   ├── kubeadmin-password
│   └── kubeconfig
├── bootstrap.ign
├── master.ign
├── metadata.json
└── worker.ign
```

### 15.3.11. Installing RHCOS and starting the OpenShift Container Platform bootstrap process

To install OpenShift Container Platform on IBM Z infrastructure that you provision, you must install Red Hat Enterprise Linux CoreOS (RHCOS) on z/VM guest virtual machines. When you install RHCOS, you must provide the Ignition config file that was generated by the OpenShift Container Platform installation program for the type of machine you are installing. If you have configured suitable networking, DNS, and load balancing infrastructure, the OpenShift Container Platform bootstrap process begins automatically after the RHCOS z/VM guest virtual machines have rebooted.

Complete the following steps to create the machines.

#### Prerequisites

- An HTTP or HTTPS server running on your provisioning machine that is accessible to the machines you create.

## Procedure

1. Log in to Linux on your provisioning machine.
2. Obtain the Red Hat Enterprise Linux CoreOS (RHCOS) kernel, initramfs, and rootfs files from the [RHCOS image mirror](#).

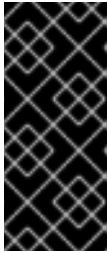

### IMPORTANT

The RHCOS images might not change with every release of OpenShift Container Platform. You must download images with the highest version that is less than or equal to the OpenShift Container Platform version that you install. Only use the appropriate kernel, initramfs, and rootfs artifacts described in the following procedure.

The file names contain the OpenShift Container Platform version number. They resemble the following examples:

- kernel: **rhcos-<version>-live-kernel-<architecture>**
- initramfs: **rhcos-<version>-live-initramfs.<architecture>.img**
- rootfs: **rhcos-<version>-live-rootfs.<architecture>.img**



### NOTE

The rootfs image is the same for FCP and DASD.

3. Create parameter files. The following parameters are specific for a particular virtual machine:
  - For **ip=**, specify the following seven entries:
    - i. The IP address for the machine.
    - ii. An empty string.
    - iii. The gateway.
    - iv. The netmask.
    - v. The machine host and domain name in the form **hostname.domainname**. Omit this value to let RHCOS decide.
    - vi. The network interface name. Omit this value to let RHCOS decide.
    - vii. If you use static IP addresses, specify **none**.
  - For **coreos.inst.ignition\_url=**, specify the Ignition file for the machine role. Use **bootstrap.ign**, **master.ign**, or **worker.ign**. Only HTTP and HTTPS protocols are supported.
  - For **coreos.live.rootfs\_url=**, specify the matching rootfs artifact for the kernel and initramfs you are booting. Only HTTP and HTTPS protocols are supported.
  - For installations on DASD-type disks, complete the following tasks:
    - i. For **coreos.inst.install\_dev=**, specify **dasda**.

- ii. Use **rd.dasd=** to specify the DASD where RHCOS is to be installed.
- iii. Leave all other parameters unchanged.  
Example parameter file, **bootstrap-0.parm**, for the bootstrap machine:

```
rd.neednet=1 \
console=ttysclp0 \
coreos.inst.install_dev=dasda \
coreos.live.rootfs_url=http://cl1.provide.example.com:8080/assets/rhcos-live-
rootfs.s390x.img \
coreos.inst.ignition_url=http://cl1.provide.example.com:8080/ignition/bootstrap.ign \
ip=172.18.78.2::172.18.78.1:255.255.255.0::none nameserver=172.18.78.1 \
rd.znet=qeth,0.0.bdf0,0.0.bdf1,0.0.bdf2,layer2=1,portno=0 \
zfcp.allow_lun_scan=0 \
rd.dasd=0.0.3490
```

Write all options in the parameter file as a single line and make sure you have no newline characters.

- For installations on FCP-type disks, complete the following tasks:
  - i. Use **rd.zfcp=<adapter>,<wwpn>,<lun>** to specify the FCP disk where RHCOS is to be installed. For multipathing repeat this step for each additional path.



#### NOTE

When you install with multiple paths, you must enable multipathing directly after the installation, not at a later point in time, as this can cause problems.

- ii. Set the install device as: **coreos.inst.install\_dev=sda**.



#### NOTE

If additional LUNs are configured with NPIV, FCP requires **zfcp.allow\_lun\_scan=0**. If you must enable **zfcp.allow\_lun\_scan=1** because you use a CSI driver, for example, you must configure your NPIV so that each node cannot access the boot partition of another node.

- iii. Leave all other parameters unchanged.



#### IMPORTANT

Additional post-installation steps are required to fully enable multipathing. For more information, see "Enabling multipathing with kernel arguments on RHCOS" in *Post-installation machine configuration tasks*.

The following is an example parameter file **worker-1.parm** for a worker node with multipathing:

```
rd.neednet=1 \
console=ttysclp0 \
```

```

coreos.inst.install_dev=sda \
coreos.live.rootfs_url=http://cl1.provide.example.com:8080/assets/rhcos-live-
rootfs.s390x.img \
coreos.inst.ignition_url=http://cl1.provide.example.com:8080/ignition/worker.ign \
ip=172.18.78.2::172.18.78.1:255.255.255.0:::none nameserver=172.18.78.1 \
rd.znet=qeth,0.0.bdf0,0.0.bdf1,0.0.bdf2,layer2=1,portno=0 \
zfcp.allow_lun_scan=0 \
rd.zfcp=0.0.1987,0x50050763070bc5e3,0x4008400B00000000 \
rd.zfcp=0.0.19C7,0x50050763070bc5e3,0x4008400B00000000 \
rd.zfcp=0.0.1987,0x50050763071bc5e3,0x4008400B00000000 \
rd.zfcp=0.0.19C7,0x50050763071bc5e3,0x4008400B00000000

```

Write all options in the parameter file as a single line and make sure you have no newline characters.

4. Transfer the initramfs, kernel, parameter files, and RHCOS images to z/VM, for example with FTP. For details about how to transfer the files with FTP and boot from the virtual reader, see [Installing under Z/VM](#).
5. Punch the files to the virtual reader of the z/VM guest virtual machine that is to become your bootstrap node.  
See [PUNCH](#) in IBM Documentation.

### TIP

You can use the CP PUNCH command or, if you use Linux, the **vmur** command to transfer files between two z/VM guest virtual machines.

6. Log in to CMS on the bootstrap machine.
7. IPL the bootstrap machine from the reader:

```
$ ipl c
```

See [IPL](#) in IBM Documentation.

8. Repeat this procedure for the other machines in the cluster.

## 15.3.11.1. Advanced RHCOS installation reference

This section illustrates the networking configuration and other advanced options that allow you to modify the Red Hat Enterprise Linux CoreOS (RHCOS) manual installation process. The following tables describe the kernel arguments and command-line options you can use with the RHCOS live installer and the **coreos-installer** command.

### 15.3.11.1.1. Networking and bonding options for ISO installations

If you install RHCOS from an ISO image, you can add kernel arguments manually when you boot the image to configure networking for a node. If no networking arguments are specified, DHCP is activated in the initramfs when RHCOS detects that networking is required to fetch the Ignition config file.

**IMPORTANT**

When adding networking arguments manually, you must also add the **rd.neednet=1** kernel argument to bring the network up in the initramfs.

The following table provides examples for configuring networking and bonding on your RHCOS nodes for ISO installations. The examples describe how to use the **ip=**, **nameserver=**, and **bond=** kernel arguments.

**NOTE**

Ordering is important when adding the kernel arguments: **ip=**, **nameserver=**, and then **bond=**.

The networking options are passed to the **dracut** tool during system boot. For more information about the networking options supported by **dracut**, see the **dracut.cmdline** manual page.

The following examples are the networking options for ISO installation.

**Configuring DHCP or static IP addresses**

To configure an IP address, either use DHCP (**ip=dhcp**) or set an individual static IP address (**ip=<host\_ip>**). If setting a static IP, you must then identify the DNS server IP address (**nameserver=<dns\_ip>**) on each node. The following example sets:

- The node's IP address to **10.10.10.2**
- The gateway address to **10.10.10.254**
- The netmask to **255.255.255.0**
- The hostname to **core0.example.com**
- The DNS server address to **4.4.4.41**
- The auto-configuration value to **none**. No auto-configuration is required when IP networking is configured statically.

```
ip=10.10.10.2::10.10.10.254:255.255.255.0:core0.example.com:enp1s0:none
nameserver=4.4.4.41
```

**NOTE**

When you use DHCP to configure IP addressing for the RHCOS machines, the machines also obtain the DNS server information through DHCP. For DHCP-based deployments, you can define the DNS server address that is used by the RHCOS nodes through your DHCP server configuration.

**Configuring an IP address without a static hostname**

You can configure an IP address without assigning a static hostname. If a static hostname is not set by the user, it will be picked up and automatically set by a reverse DNS lookup. To configure an IP address without a static hostname refer to the following example:

- The node's IP address to **10.10.10.2**

- The gateway address to **10.10.10.254**
- The netmask to **255.255.255.0**
- The DNS server address to **4.4.4.41**
- The auto-configuration value to **none**. No auto-configuration is required when IP networking is configured statically.

```
ip=10.10.10.2::10.10.10.254:255.255.255.0::enp1s0:none
nameserver=4.4.4.41
```

### Specifying multiple network interfaces

You can specify multiple network interfaces by setting multiple **ip=** entries.

```
ip=10.10.10.2::10.10.10.254:255.255.255.0:core0.example.com:enp1s0:none
ip=10.10.10.3::10.10.10.254:255.255.255.0:core0.example.com:enp2s0:none
```

### Configuring default gateway and route

Optional: You can configure routes to additional networks by setting an **rd.route=** value.



#### NOTE

When you configure one or multiple networks, one default gateway is required. If the additional network gateway is different from the primary network gateway, the default gateway must be the primary network gateway.

- Run the following command to configure the default gateway:

```
ip=::10.10.10.254:::
```

- Enter the following command to configure the route for the additional network:

```
rd.route=20.20.20.0/24:20.20.20.254:enp2s0
```

### Disabling DHCP on a single interface

You can disable DHCP on a single interface, such as when there are two or more network interfaces and only one interface is being used. In the example, the **enp1s0** interface has a static networking configuration and DHCP is disabled for **enp2s0**, which is not used:

```
ip=10.10.10.2::10.10.10.254:255.255.255.0:core0.example.com:enp1s0:none
ip=::::core0.example.com:enp2s0:none
```

### Combining DHCP and static IP configurations

You can combine DHCP and static IP configurations on systems with multiple network interfaces, for example:

```
ip=enp1s0:dhcp
ip=10.10.10.2::10.10.10.254:255.255.255.0:core0.example.com:enp2s0:none
```

### Configuring VLANs on individual interfaces

Optional: You can configure VLANs on individual interfaces by using the **vlan=** parameter.



- To configure a VLAN on a network interface and use a static IP address, run the following command:

```
ip=10.10.10.2::10.10.10.254:255.255.255.0:core0.example.com:enp2s0.100:none
vlan=enp2s0.100:enp2s0
```

- To configure a VLAN on a network interface and to use DHCP, run the following command:

```
ip=enp2s0.100:dhcp
vlan=enp2s0.100:enp2s0
```

### Providing multiple DNS servers

You can provide multiple DNS servers by adding a **nameserver=** entry for each server, for example:

```
nameserver=1.1.1.1
nameserver=8.8.8.8
```

### Bonding multiple network interfaces to a single interface

Optional: You can bond multiple network interfaces to a single interface by using the **bond=** option. Refer to the following examples:

- The syntax for configuring a bonded interface is: **bond=name[:network\_interfaces][:options]** *name* is the bonding device name (**bond0**), *network\_interfaces* represents a comma-separated list of physical (ethernet) interfaces (**em1,em2**), and *options* is a comma-separated list of bonding options. Enter **modinfo bonding** to see available options.
- When you create a bonded interface using **bond=**, you must specify how the IP address is assigned and other information for the bonded interface.
- To configure the bonded interface to use DHCP, set the bond's IP address to **dhcp**. For example:

```
bond=bond0:em1,em2:mode=active-backup
ip=bond0:dhcp
```

- To configure the bonded interface to use a static IP address, enter the specific IP address you want and related information. For example:

```
bond=bond0:em1,em2:mode=active-backup,fail_over_mac=1
ip=10.10.10.2::10.10.10.254:255.255.255.0:core0.example.com:bond0:none
```

Always set option **fail\_over\_mac=1** in active-backup mode, to avoid problems when shared OSA/RoCE cards are used.

### Bonding multiple network interfaces to a single interface

Optional: You can configure VLANs on bonded interfaces by using the **vlan=** parameter and to use DHCP, for example:

```
ip=bond0.100:dhcp
bond=bond0:em1,em2:mode=active-backup
vlan=bond0.100:bond0
```

Use the following example to configure the bonded interface with a VLAN and to use a static IP address:

■

```
ip=10.10.10.2::10.10.10.254:255.255.255.0:core0.example.com:bond0.100:none
bond=bond0:em1,em2:mode=active-backup
vlan=bond0.100:bond0
```

### Using network teaming

Optional: You can use a network teaming as an alternative to bonding by using the **team=** parameter:

- The syntax for configuring a team interface is: **team=name[:network\_interfaces]**  
*name* is the team device name (**team0**) and *network\_interfaces* represents a comma-separated list of physical (ethernet) interfaces (**em1, em2**).

Teaming is planned to be deprecated when RHCOS switches to an upcoming version of RHEL. For more information, see this [Red Hat Knowledgebase Article](#).

Use the following example to configure a network team:

```
team=team0:em1,em2
ip=team0:dhcp
```

## 15.3.12. Waiting for the bootstrap process to complete

The OpenShift Container Platform bootstrap process begins after the cluster nodes first boot into the persistent RHCOS environment that has been installed to disk. The configuration information provided through the Ignition config files is used to initialize the bootstrap process and install OpenShift Container Platform on the machines. You must wait for the bootstrap process to complete.

### Prerequisites

- You have created the Ignition config files for your cluster.
- You have configured suitable network, DNS and load balancing infrastructure.
- You have obtained the installation program and generated the Ignition config files for your cluster.
- You installed RHCOS on your cluster machines and provided the Ignition config files that the OpenShift Container Platform installation program generated.

### Procedure

1. Monitor the bootstrap process:

```
$ ./openshift-install --dir <installation_directory> wait-for bootstrap-complete \ 1
--log-level=info 2
```

1 For **<installation\_directory>**, specify the path to the directory that you stored the installation files in.

2 To view different installation details, specify **warn**, **debug**, or **error** instead of **info**.

### Example output

```
INFO Waiting up to 30m0s for the Kubernetes API at https://api.test.example.com:6443...
```

```
INFO API v1.23.0 up
INFO Waiting up to 30m0s for bootstrapping to complete...
INFO It is now safe to remove the bootstrap resources
```

The command succeeds when the Kubernetes API server signals that it has been bootstrapped on the control plane machines.

2. After bootstrap process is complete, remove the bootstrap machine from the load balancer.



### IMPORTANT

You must remove the bootstrap machine from the load balancer at this point. You can also remove or reformat the bootstrap machine itself.

## 15.3.13. Logging in to the cluster by using the CLI

You can log in to your cluster as a default system user by exporting the cluster **kubeconfig** file. The **kubeconfig** file contains information about the cluster that is used by the CLI to connect a client to the correct cluster and API server. The file is specific to a cluster and is created during OpenShift Container Platform installation.

### Prerequisites

- You deployed an OpenShift Container Platform cluster.
- You installed the **oc** CLI.

### Procedure

1. Export the **kubeadmin** credentials:

```
$ export KUBECONFIG=<installation_directory>/auth/kubeconfig 1
```

- 1** For **<installation\_directory>**, specify the path to the directory that you stored the installation files in.

2. Verify you can run **oc** commands successfully using the exported configuration:

```
$ oc whoami
```

### Example output

```
system:admin
```

## 15.3.14. Approving the certificate signing requests for your machines

When you add machines to a cluster, two pending certificate signing requests (CSRs) are generated for each machine that you added. You must confirm that these CSRs are approved or, if necessary, approve them yourself. The client requests must be approved first, followed by the server requests.

### Prerequisites

- You added machines to your cluster.

## Procedure

- Confirm that the cluster recognizes the machines:

```
$ oc get nodes
```

### Example output

```
NAME      STATUS    ROLES    AGE   VERSION
master-0  Ready     master   63m   v1.23.0
master-1  Ready     master   63m   v1.23.0
master-2  Ready     master   64m   v1.23.0
```

The output lists all of the machines that you created.

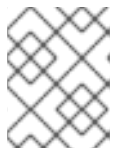

### NOTE

The preceding output might not include the compute nodes, also known as worker nodes, until some CSRs are approved.

- Review the pending CSRs and ensure that you see the client requests with the **Pending** or **Approved** status for each machine that you added to the cluster:

```
$ oc get csr
```

### Example output

```
NAME      AGE   REQUESTOR                                     CONDITION
csr-8b2br  15m   system:serviceaccount:openshift-machine-config-operator:node-
bootstrapper  Pending
csr-8vnps  15m   system:serviceaccount:openshift-machine-config-operator:node-
bootstrapper  Pending
...
```

In this example, two machines are joining the cluster. You might see more approved CSRs in the list.

- If the CSRs were not approved, after all of the pending CSRs for the machines you added are in **Pending** status, approve the CSRs for your cluster machines:



### NOTE

Because the CSRs rotate automatically, approve your CSRs within an hour of adding the machines to the cluster. If you do not approve them within an hour, the certificates will rotate, and more than two certificates will be present for each node. You must approve all of these certificates. After the client CSR is approved, the Kubelet creates a secondary CSR for the serving certificate, which requires manual approval. Then, subsequent serving certificate renewal requests are automatically approved by the **machine-approver** if the Kubelet requests a new certificate with identical parameters.



## NOTE

For clusters running on platforms that are not machine API enabled, such as bare metal and other user-provisioned infrastructure, you must implement a method of automatically approving the kubelet serving certificate requests (CSRs). If a request is not approved, then the **oc exec**, **oc rsh**, and **oc logs** commands cannot succeed, because a serving certificate is required when the API server connects to the kubelet. Any operation that contacts the Kubelet endpoint requires this certificate approval to be in place. The method must watch for new CSRs, confirm that the CSR was submitted by the **node-bootstrap** service account in the **system:node** or **system:admin** groups, and confirm the identity of the node.

- To approve them individually, run the following command for each valid CSR:

```
$ oc adm certificate approve <csr_name> 1
```

- 1** **<csr\_name>** is the name of a CSR from the list of current CSRs.

- To approve all pending CSRs, run the following command:

```
$ oc get csr -o go-template='{{range .items}}{{if not .status}}{{.metadata.name}}{"\n"}\n{{end}}' | xargs --no-run-if-empty oc adm certificate approve
```



## NOTE

Some Operators might not become available until some CSRs are approved.

- Now that your client requests are approved, you must review the server requests for each machine that you added to the cluster:

```
$ oc get csr
```

### Example output

```
NAME      AGE   REQUESTOR                                     CONDITION
csr-bfd72 5m26s system:node:ip-10-0-50-126.us-east-2.compute.internal
Pending
csr-c57lv 5m26s system:node:ip-10-0-95-157.us-east-2.compute.internal
Pending
...
```

- If the remaining CSRs are not approved, and are in the **Pending** status, approve the CSRs for your cluster machines:

- To approve them individually, run the following command for each valid CSR:

```
$ oc adm certificate approve <csr_name> 1
```

- 1** **<csr\_name>** is the name of a CSR from the list of current CSRs.

- To approve all pending CSRs, run the following command:

```
$ oc get csr -o go-template='{{range .items}}{{if not .status}}{{.metadata.name}}{\n"}\n{{end}}' | xargs oc adm certificate approve
```

6. After all client and server CSRs have been approved, the machines have the **Ready** status. Verify this by running the following command:

```
$ oc get nodes
```

### Example output

```
NAME      STATUS  ROLES  AGE  VERSION
master-0  Ready   master 73m  v1.23.0
master-1  Ready   master 73m  v1.23.0
master-2  Ready   master 74m  v1.23.0
worker-0  Ready   worker 11m  v1.23.0
worker-1  Ready   worker 11m  v1.23.0
```



### NOTE

It can take a few minutes after approval of the server CSRs for the machines to transition to the **Ready** status.

### Additional information

- For more information on CSRs, see [Certificate Signing Requests](#).

## 15.3.15. Initial Operator configuration

After the control plane initializes, you must immediately configure some Operators so that they all become available.

### Prerequisites

- Your control plane has initialized.

### Procedure

1. Watch the cluster components come online:

```
$ watch -n5 oc get clusteroperators
```

### Example output

NAME	VERSION	AVAILABLE	PROGRESSING	DEGRADED	SINCE
authentication	4.10.0	True	False	False	19m
baremetal	4.10.0	True	False	False	37m
cloud-credential	4.10.0	True	False	False	40m
cluster-autoscaler	4.10.0	True	False	False	37m
config-operator	4.10.0	True	False	False	38m

console	4.10.0	True	False	False	26m
csi-snapshot-controller	4.10.0	True	False	False	37m
dns	4.10.0	True	False	False	37m
etcd	4.10.0	True	False	False	36m
image-registry	4.10.0	True	False	False	31m
ingress	4.10.0	True	False	False	30m
insights	4.10.0	True	False	False	31m
kube-apiserver	4.10.0	True	False	False	26m
kube-controller-manager	4.10.0	True	False	False	36m
kube-scheduler	4.10.0	True	False	False	36m
kube-storage-version-migrator	4.10.0	True	False	False	37m
machine-api	4.10.0	True	False	False	29m
machine-approver	4.10.0	True	False	False	37m
machine-config	4.10.0	True	False	False	36m
marketplace	4.10.0	True	False	False	37m
monitoring	4.10.0	True	False	False	29m
network	4.10.0	True	False	False	38m
node-tuning	4.10.0	True	False	False	37m
openshift-apiserver	4.10.0	True	False	False	32m
openshift-controller-manager	4.10.0	True	False	False	30m
openshift-samples	4.10.0	True	False	False	32m
operator-lifecycle-manager	4.10.0	True	False	False	37m
operator-lifecycle-manager-catalog	4.10.0	True	False	False	37m
operator-lifecycle-manager-packageserver	4.10.0	True	False	False	32m
service-ca	4.10.0	True	False	False	38m
storage	4.10.0	True	False	False	37m

2. Configure the Operators that are not available.

### 15.3.15.1. Disabling the default OperatorHub sources

Operator catalogs that source content provided by Red Hat and community projects are configured for OperatorHub by default during an OpenShift Container Platform installation. In a restricted network environment, you must disable the default catalogs as a cluster administrator.

#### Procedure

- Disable the sources for the default catalogs by adding **disableAllDefaultSources: true** to the **OperatorHub** object:

```
$ oc patch OperatorHub cluster --type json \
  -p '[{"op": "add", "path": "/spec/disableAllDefaultSources", "value": true}]'
```

#### TIP

Alternatively, you can use the web console to manage catalog sources. From the **Administration** → **Cluster Settings** → **Configuration** → **OperatorHub** page, click the **Sources** tab, where you can create, delete, disable, and enable individual sources.

### 15.3.15.2. Image registry storage configuration

The Image Registry Operator is not initially available for platforms that do not provide default storage. After installation, you must configure your registry to use storage so that the Registry Operator is made available.

Instructions are shown for configuring a persistent volume, which is required for production clusters. Where applicable, instructions are shown for configuring an empty directory as the storage location, which is available for only non-production clusters.

Additional instructions are provided for allowing the image registry to use block storage types by using the **Recreate** rollout strategy during upgrades.

### 15.3.15.2.1. Configuring registry storage for IBM Z

As a cluster administrator, following installation you must configure your registry to use storage.

#### Prerequisites

- You have access to the cluster as a user with the **cluster-admin** role.
- You have a cluster on IBM Z.
- You have provisioned persistent storage for your cluster, such as Red Hat OpenShift Data Foundation.



#### IMPORTANT

OpenShift Container Platform supports **ReadWriteOnce** access for image registry storage when you have only one replica. **ReadWriteOnce** access also requires that the registry uses the **Recreate** rollout strategy. To deploy an image registry that supports high availability with two or more replicas, **ReadWriteMany** access is required.

- Must have 100Gi capacity.

#### Procedure

1. To configure your registry to use storage, change the **spec.storage.pvc** in the **configs.imageregistry/cluster** resource.



#### NOTE

When using shared storage, review your security settings to prevent outside access.

2. Verify that you do not have a registry pod:

```
$ oc get pod -n openshift-image-registry -l docker-registry=default
```

#### Example output

```
No resources found in openshift-image-registry namespace
```



#### NOTE

If you do have a registry pod in your output, you do not need to continue with this procedure.



3. Check the registry configuration:

```
$ oc edit configs.imageregistry.operator.openshift.io
```

#### Example output

```
storage:
  pvc:
    claim:
```

Leave the **claim** field blank to allow the automatic creation of an **image-registry-storage** PVC.

4. Check the **clusteroperator** status:

```
$ oc get clusteroperator image-registry
```

#### Example output

NAME	VERSION	AVAILABLE	PROGRESSING	DEGRADED	SINCE
image-registry	4.10	True	False	False	6h50m

5. Ensure that your registry is set to managed to enable building and pushing of images.

- Run:

```
$ oc edit configs.imageregistry/cluster
```

Then, change the line

```
managementState: Removed
```

to

```
managementState: Managed
```

#### 15.3.15.2.2. Configuring storage for the image registry in non-production clusters

You must configure storage for the Image Registry Operator. For non-production clusters, you can set the image registry to an empty directory. If you do so, all images are lost if you restart the registry.

#### Procedure

- To set the image registry storage to an empty directory:

```
$ oc patch configs.imageregistry.operator.openshift.io cluster --type merge --patch '{"spec": {"storage":{"emptyDir":{}}}'
```

**WARNING**

Configure this option for only non-production clusters.

If you run this command before the Image Registry Operator initializes its components, the **oc patch** command fails with the following error:

```
Error from server (NotFound): configs.imageregistry.operator.openshift.io "cluster" not found
```

Wait a few minutes and run the command again.

### 15.3.16. Completing installation on user-provisioned infrastructure

After you complete the Operator configuration, you can finish installing the cluster on infrastructure that you provide.

#### Prerequisites

- Your control plane has initialized.
- You have completed the initial Operator configuration.

#### Procedure

1. Confirm that all the cluster components are online with the following command:

```
$ watch -n5 oc get clusteroperators
```

#### Example output

NAME	VERSION	AVAILABLE	PROGRESSING	DEGRADED	SINCE
authentication	4.10.0	True	False	False	19m
baremetal	4.10.0	True	False	False	37m
cloud-credential	4.10.0	True	False	False	40m
cluster-autoscaler	4.10.0	True	False	False	37m
config-operator	4.10.0	True	False	False	38m
console	4.10.0	True	False	False	26m
csi-snapshot-controller	4.10.0	True	False	False	37m
dns	4.10.0	True	False	False	37m
etcd	4.10.0	True	False	False	36m
image-registry	4.10.0	True	False	False	31m
ingress	4.10.0	True	False	False	30m
insights	4.10.0	True	False	False	31m
kube-apiserver	4.10.0	True	False	False	26m
kube-controller-manager	4.10.0	True	False	False	36m
kube-scheduler	4.10.0	True	False	False	36m
kube-storage-version-migrator	4.10.0	True	False	False	37m
machine-api	4.10.0	True	False	False	29m

machine-approver	4.10.0	True	False	False	37m
machine-config	4.10.0	True	False	False	36m
marketplace	4.10.0	True	False	False	37m
monitoring	4.10.0	True	False	False	29m
network	4.10.0	True	False	False	38m
node-tuning	4.10.0	True	False	False	37m
openshift-apiserver	4.10.0	True	False	False	32m
openshift-controller-manager	4.10.0	True	False	False	30m
openshift-samples	4.10.0	True	False	False	32m
operator-lifecycle-manager	4.10.0	True	False	False	37m
operator-lifecycle-manager-catalog	4.10.0	True	False	False	37m
operator-lifecycle-manager-packageserver	4.10.0	True	False	False	32m
service-ca	4.10.0	True	False	False	38m
storage	4.10.0	True	False	False	37m

Alternatively, the following command notifies you when all of the clusters are available. It also retrieves and displays credentials:

```
$ ./openshift-install --dir <installation_directory> wait-for install-complete 1
```

- 1** For **<installation\_directory>**, specify the path to the directory that you stored the installation files in.

### Example output

```
INFO Waiting up to 30m0s for the cluster to initialize...
```

The command succeeds when the Cluster Version Operator finishes deploying the OpenShift Container Platform cluster from Kubernetes API server.

### IMPORTANT

- The Ignition config files that the installation program generates contain certificates that expire after 24 hours, which are then renewed at that time. If the cluster is shut down before renewing the certificates and the cluster is later restarted after the 24 hours have elapsed, the cluster automatically recovers the expired certificates. The exception is that you must manually approve the pending **node-bootstrapper** certificate signing requests (CSRs) to recover kubelet certificates. See the documentation for *Recovering from expired control plane certificates* for more information.
- It is recommended that you use Ignition config files within 12 hours after they are generated because the 24-hour certificate rotates from 16 to 22 hours after the cluster is installed. By using the Ignition config files within 12 hours, you can avoid installation failure if the certificate update runs during installation.

2. Confirm that the Kubernetes API server is communicating with the pods.

- a. To view a list of all pods, use the following command:

```
$ oc get pods --all-namespaces
```

### Example output

```

NAMESPACE          NAME          READY  STATUS
RESTARTS  AGE
openshift-apiserver-operator  openshift-apiserver-operator-85cb746d55-zqhs8  1/1
Running    1    9m
openshift-apiserver          apiserver-67b9g          1/1  Running  0
3m
openshift-apiserver          apiserver-ljcmx          1/1  Running  0
1m
openshift-apiserver          apiserver-z25h4          1/1  Running  0
2m
openshift-authentication-operator  authentication-operator-69d5d8bf84-vh2n8  1/1
Running    0    5m
...

```

- b. View the logs for a pod that is listed in the output of the previous command by using the following command:

```
$ oc logs <pod_name> -n <namespace> 1
```

- 1** Specify the pod name and namespace, as shown in the output of the previous command.

If the pod logs display, the Kubernetes API server can communicate with the cluster machines.

- For an installation with Fibre Channel Protocol (FCP), additional steps are required to enable multipathing. Do not enable multipathing during installation. See "Enabling multipathing with kernel arguments on RHCOS" in the *Post-installation machine configuration tasks* documentation for more information.
- Register your cluster on the [Cluster registration](#) page.

### Additional resources

- [How to generate SOSREPORT within OpenShift Container Platform version 4 nodes without SSH.](#)

### 15.3.17. Next steps

- [Customize your cluster.](#)
- If the mirror registry that you used to install your cluster has a trusted CA, add it to the cluster by [configuring additional trust stores](#).
- If necessary, you can [opt out of remote health reporting](#).
- If necessary, see [Registering your disconnected cluster](#)

# CHAPTER 16. INSTALLING WITH RHEL KVM ON IBM Z AND LINUXONE

## 16.1. PREPARING TO INSTALL WITH RHEL KVM ON IBM Z AND LINUXONE

### 16.1.1. Prerequisites

- You reviewed details about the [OpenShift Container Platform installation and update](#) processes.
- You read the documentation on [selecting a cluster installation method and preparing it for users](#).

### 16.1.2. Choosing a method to install OpenShift Container Platform with RHEL KVM on IBM Z or LinuxONE

You can install a cluster with RHEL KVM on IBM Z or LinuxONE infrastructure that you provision, by using one of the following methods:

- **Installing a cluster with RHEL KVM on IBM Z and LinuxONE** You can install OpenShift Container Platform with KVM on IBM Z or LinuxONE infrastructure that you provision.
- **Installing a cluster with RHEL KVM on IBM Z and LinuxONE in a restricted network** You can install OpenShift Container Platform with RHEL KVM on IBM Z or LinuxONE infrastructure that you provision in a restricted or disconnected network, by using an internal mirror of the installation release content. You can use this method to install a cluster that does not require an active internet connection to obtain the software components. You can also use this installation method to ensure that your clusters only use container images that satisfy your organizational controls on external content.

## 16.2. INSTALLING A CLUSTER WITH RHEL KVM ON IBM Z AND LINUXONE

In OpenShift Container Platform version 4.10, you can install a cluster on IBM Z or LinuxONE infrastructure that you provision.



### NOTE

While this document refers only to IBM Z, all information in it also applies to LinuxONE.



### IMPORTANT

Additional considerations exist for non-bare metal platforms. Review the information in the [guidelines for deploying OpenShift Container Platform on non-tested platforms](#) before you install an OpenShift Container Platform cluster.

### 16.2.1. Prerequisites

- You reviewed details about the [OpenShift Container Platform installation and update](#) processes.

- You read the documentation on [selecting a cluster installation method and preparing it for users](#).
- Before you begin the installation process, you must clean the installation directory. This ensures that the required installation files are created and updated during the installation process.
- You provisioned [persistent storage using OpenShift Data Foundation](#) or other supported storage protocols for your cluster. To deploy a private image registry, you must set up persistent storage with **ReadWriteMany** access.
- If you use a firewall, you [configured it to allow the sites](#) that your cluster requires access to.
- You provisioned a RHEL Kernel Virtual Machine (KVM) system that is hosted on the logical partition (LPAR) and based on RHEL 8.4 or later.

**NOTE**

Be sure to also review this site list if you are configuring a proxy.

## 16.2.2. Internet access for OpenShift Container Platform

In OpenShift Container Platform 4.10, you require access to the internet to install your cluster.

You must have internet access to:

- Access [OpenShift Cluster Manager](#) to download the installation program and perform subscription management. If the cluster has internet access and you do not disable Telemetry, that service automatically entitles your cluster.
- Access [Quay.io](#) to obtain the packages that are required to install your cluster.
- Obtain the packages that are required to perform cluster updates.

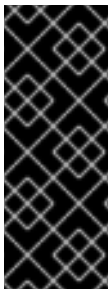
**IMPORTANT**

If your cluster cannot have direct internet access, you can perform a restricted network installation on some types of infrastructure that you provision. During that process, you download the required content and use it to populate a mirror registry with the installation packages. With some installation types, the environment that you install your cluster in will not require internet access. Before you update the cluster, you update the content of the mirror registry.

## 16.2.3. Machine requirements for a cluster with user-provisioned infrastructure

For a cluster that contains user-provisioned infrastructure, you must deploy all of the required machines.

One or more KVM host machines based on RHEL 8.4 or later. Each RHEL KVM host machine must have libvirt installed and running. The virtual machines are provisioned under each RHEL KVM host machine.

### 16.2.3.1. Required machines

The smallest OpenShift Container Platform clusters require the following hosts:

**Table 16.1. Minimum required hosts**

Hosts	Description
One temporary bootstrap machine	The cluster requires the bootstrap machine to deploy the OpenShift Container Platform cluster on the three control plane machines. You can remove the bootstrap machine after you install the cluster.
Three control plane machines	The control plane machines run the Kubernetes and OpenShift Container Platform services that form the control plane.
At least two compute machines, which are also known as worker machines.	The workloads requested by OpenShift Container Platform users run on the compute machines.



### IMPORTANT

To improve high availability of your cluster, distribute the control plane machines over different RHEL instances on at least two physical machines.

The bootstrap, control plane, and compute machines must use Red Hat Enterprise Linux CoreOS (RHCOS) as the operating system.

See [Red Hat Enterprise Linux technology capabilities and limits](#) .

#### 16.2.3.2. Network connectivity requirements

The OpenShift Container Platform installer creates the Ignition files, which are necessary for all the Red Hat Enterprise Linux CoreOS (RHCOS) virtual machines. The automated installation of OpenShift Container Platform is performed by the bootstrap machine. It starts the installation of OpenShift Container Platform on each node, starts the Kubernetes cluster, and then finishes. During this bootstrap, the virtual machine must have an established network connection either through a Dynamic Host Configuration Protocol (DHCP) server or static IP address.

#### 16.2.3.3. IBM Z network connectivity requirements

To install on IBM Z under RHEL KVM, you need:

- A RHEL KVM host configured with an OSA or RoCE network adapter.
- Either a RHEL KVM host that is configured to use bridged networking in libvirt or MacVTap to connect the network to the guests.  
See [Types of virtual network connections](#) .

#### 16.2.3.4. Host machine resource requirements

The RHEL KVM host in your environment must meet the following requirements to host the virtual machines that you plan for the OpenShift Container Platform environment. See [Getting started with virtualization](#).

You can install OpenShift Container Platform version 4.10 on the following IBM hardware:

- IBM z16 (all models), IBM z15 (all models), IBM z14 (all models), IBM z13, and IBM z13s

- LinuxONE, any version

### 16.2.3.5. Minimum IBM Z system environment

#### Hardware requirements

- The equivalent of six Integrated Facilities for Linux (IFL), which are SMT2 enabled, for each cluster.
- At least one network connection to both connect to the **LoadBalancer** service and to serve data for traffic outside the cluster.



#### NOTE

You can use dedicated or shared IFLs to assign sufficient compute resources. Resource sharing is one of the key strengths of IBM Z. However, you must adjust capacity correctly on each hypervisor layer and ensure sufficient resources for every OpenShift Container Platform cluster.



#### IMPORTANT

Since the overall performance of the cluster can be impacted, the LPARs that are used to setup the OpenShift Container Platform clusters must provide sufficient compute capacity. In this context, LPAR weight management, entitlements, and CPU shares on the hypervisor level play an important role.

#### Operating system requirements

- One LPAR running RHEL 8.4 or later with KVM, which is managed by libvirt

On your RHEL KVM host, set up:

- Three guest virtual machines for OpenShift Container Platform control plane machines
- Two guest virtual machines for OpenShift Container Platform compute machines
- One guest virtual machine for the temporary OpenShift Container Platform bootstrap machine

### 16.2.3.6. Minimum resource requirements

Each cluster virtual machine must meet the following minimum requirements:

Virtual Machine	Operating System	vCPU [1]	Virtual RAM	Storage	IOPS
Bootstrap	RHCOS	4	16 GB	100 GB	N/A
Control plane	RHCOS	4	16 GB	100 GB	N/A
Compute	RHCOS	2	8 GB	100 GB	N/A

1. One physical core (IFL) provides two logical cores (threads) when SMT-2 is enabled. The hypervisor can provide two or more vCPUs.



### 16.2.3.7. Preferred IBM Z system environment

#### Hardware requirements

- Three LPARS that each have the equivalent of six IFLs, which are SMT2 enabled, for each cluster.
- Two network connections to both connect to the **LoadBalancer** service and to serve data for traffic outside the cluster.

#### Operating system requirements

- For high availability, two or three LPARs running RHEL 8.4 or later with KVM, which are managed by libvirt.

On your RHEL KVM host, set up:

- Three guest virtual machines for OpenShift Container Platform control plane machines, distributed across the RHEL KVM host machines.
- At least six guest virtual machines for OpenShift Container Platform compute machines, distributed across the RHEL KVM host machines.
- One guest virtual machine for the temporary OpenShift Container Platform bootstrap machine.
- To ensure the availability of integral components in an overcommitted environment, increase the priority of the control plane by using **cpu\_shares**. Do the same for infrastructure nodes, if they exist. See [schedinfo](#) in IBM Documentation.

### 16.2.3.8. Preferred resource requirements

The preferred requirements for each cluster virtual machine are:

Virtual Machine	Operating System	vCPU	Virtual RAM	Storage
Bootstrap	RHCOS	4	16 GB	120 GB
Control plane	RHCOS	8	16 GB	120 GB
Compute	RHCOS	6	8 GB	120 GB

### 16.2.3.9. Certificate signing requests management

Because your cluster has limited access to automatic machine management when you use infrastructure that you provision, you must provide a mechanism for approving cluster certificate signing requests (CSRs) after installation. The **kube-controller-manager** only approves the kubelet client CSRs. The **machine-approver** cannot guarantee the validity of a serving certificate that is requested by using kubelet credentials because it cannot confirm that the correct machine issued the request. You must determine and implement a method of verifying the validity of the kubelet serving certificate requests and approving them.

#### Additional resources

- [Recommended host practices for IBM Z & LinuxONE environments](#)

### 16.2.3.10. Networking requirements for user-provisioned infrastructure

All the Red Hat Enterprise Linux CoreOS (RHCOS) machines require networking to be configured in **initramfs** during boot to fetch their Ignition config files.

During the initial boot, the machines require an IP address configuration that is set either through a DHCP server or statically by providing the required boot options. After a network connection is established, the machines download their Ignition config files from an HTTP or HTTPS server. The Ignition config files are then used to set the exact state of each machine. The Machine Config Operator completes more changes to the machines, such as the application of new certificates or keys, after installation.

It is recommended to use a DHCP server for long-term management of the cluster machines. Ensure that the DHCP server is configured to provide persistent IP addresses, DNS server information, and hostnames to the cluster machines.



#### NOTE

If a DHCP service is not available for your user-provisioned infrastructure, you can instead provide the IP networking configuration and the address of the DNS server to the nodes at RHCOS install time. These can be passed as boot arguments if you are installing from an ISO image. See the *Installing RHCOS and starting the OpenShift Container Platform bootstrap process* section for more information about static IP provisioning and advanced networking options.

The Kubernetes API server must be able to resolve the node names of the cluster machines. If the API servers and worker nodes are in different zones, you can configure a default DNS search zone to allow the API server to resolve the node names. Another supported approach is to always refer to hosts by their fully-qualified domain names in both the node objects and all DNS requests.

#### 16.2.3.10.1. Setting the cluster node hostnames through DHCP

On Red Hat Enterprise Linux CoreOS (RHCOS) machines, the hostname is set through NetworkManager. By default, the machines obtain their hostname through DHCP. If the hostname is not provided by DHCP, set statically through kernel arguments, or another method, it is obtained through a reverse DNS lookup. Reverse DNS lookup occurs after the network has been initialized on a node and can take time to resolve. Other system services can start prior to this and detect the hostname as **localhost** or similar. You can avoid this by using DHCP to provide the hostname for each cluster node.

Additionally, setting the hostnames through DHCP can bypass any manual DNS record name configuration errors in environments that have a DNS split-horizon implementation.

#### 16.2.3.10.2. Network connectivity requirements

You must configure the network connectivity between machines to allow OpenShift Container Platform cluster components to communicate. Each machine must be able to resolve the hostnames of all other machines in the cluster.

This section provides details about the ports that are required.



#### IMPORTANT

In connected OpenShift Container Platform environments, all nodes are required to have internet access to pull images for platform containers and provide telemetry data to Red Hat.

**NOTE**

The RHEL KVM host must be configured to use bridged networking in libvirt or MacVTap to connect the network to the virtual machines. The virtual machines must have access to the network, which is attached to the RHEL KVM host. Virtual Networks, for example network address translation (NAT), within KVM are not a supported configuration.

**Table 16.2. Ports used for all-machine to all-machine communications**

Protocol	Port	Description
ICMP	N/A	Network reachability tests
TCP	<b>1936</b>	Metrics
	<b>9000-9999</b>	Host level services, including the node exporter on ports <b>9100-9101</b> and the Cluster Version Operator on port <b>9099</b> .
	<b>10250-10259</b>	The default ports that Kubernetes reserves
	<b>10256</b>	openshift-sdn
UDP	<b>4789</b>	VXLAN
	<b>6081</b>	Geneve
	<b>9000-9999</b>	Host level services, including the node exporter on ports <b>9100-9101</b> .
	<b>500</b>	IPsec IKE packets
	<b>4500</b>	IPsec NAT-T packets
TCP/UDP	<b>30000-32767</b>	Kubernetes node port
ESP	N/A	IPsec Encapsulating Security Payload (ESP)

**Table 16.3. Ports used for all-machine to control plane communications**

Protocol	Port	Description
TCP	<b>6443</b>	Kubernetes API

**Table 16.4. Ports used for control plane machine to control plane machine communications**

Protocol	Port	Description
TCP	<b>2379-2380</b>	etcd server and peer ports

### NTP configuration for user-provisioned infrastructure

OpenShift Container Platform clusters are configured to use a public Network Time Protocol (NTP) server by default. If you want to use a local enterprise NTP server, or if your cluster is being deployed in a disconnected network, you can configure the cluster to use a specific time server. For more information, see the documentation for *Configuring chrony time service*.

If a DHCP server provides NTP server information, the chrony time service on the Red Hat Enterprise Linux CoreOS (RHCOS) machines read the information and can sync the clock with the NTP servers.

### Additional resources

- [Configuring chrony time service](#)

### 16.2.3.11. User-provisioned DNS requirements

In OpenShift Container Platform deployments, DNS name resolution is required for the following components:

- The Kubernetes API
- The OpenShift Container Platform application wildcard
- The bootstrap, control plane, and compute machines

Reverse DNS resolution is also required for the Kubernetes API, the bootstrap machine, the control plane machines, and the compute machines.

DNS A/AAAA or CNAME records are used for name resolution and PTR records are used for reverse name resolution. The reverse records are important because Red Hat Enterprise Linux CoreOS (RHCOS) uses the reverse records to set the hostnames for all the nodes, unless the hostnames are provided by DHCP. Additionally, the reverse records are used to generate the certificate signing requests (CSR) that OpenShift Container Platform needs to operate.

The following DNS records are required for a user-provisioned OpenShift Container Platform cluster and they must be in place before installation. In each record, **<cluster\_name>** is the cluster name and **<base\_domain>** is the base domain that you specify in the **install-config.yaml** file. A complete DNS record takes the form: **<component>.<cluster\_name>.<base\_domain>..**

**Table 16.5. Required DNS records**

Component	Record	Description
Kubernetes API	<b>api.&lt;cluster_name&gt;.&lt;base_domain&gt;..</b>	A DNS A/AAAA or CNAME record, and a DNS PTR record, to identify the API load balancer. These records must be resolvable by both clients external to the cluster and from all the nodes within the cluster.

Component	Record	Description
	<b>api-int.&lt;cluster_name&gt;.&lt;base_domain&gt;.</b>	<p>A DNS A/AAAA or CNAME record, and a DNS PTR record, to internally identify the API load balancer. These records must be resolvable from all the nodes within the cluster.</p> <div style="display: flex; align-items: flex-start;">  <div> <p><b>IMPORTANT</b></p> <p>The API server must be able to resolve the worker nodes by the hostnames that are recorded in Kubernetes. If the API server cannot resolve the node names, then proxied API calls can fail, and you cannot retrieve logs from pods.</p> </div> </div>
Routes	<b>*.apps.&lt;cluster_name&gt;.&lt;base_domain&gt;.</b>	<p>A wildcard DNS A/AAAA or CNAME record that refers to the application ingress load balancer. The application ingress load balancer targets the machines that run the Ingress Controller pods. The Ingress Controller pods run on the compute machines by default. These records must be resolvable by both clients external to the cluster and from all the nodes within the cluster.</p> <p>For example, <b>console-openshift-console.apps.&lt;cluster_name&gt;.&lt;base_domain&gt;</b> is used as a wildcard route to the OpenShift Container Platform console.</p>
Bootstrap machine	<b>bootstrap.&lt;cluster_name&gt;.&lt;base_domain&gt;.</b>	A DNS A/AAAA or CNAME record, and a DNS PTR record, to identify the bootstrap machine. These records must be resolvable by the nodes within the cluster.
Control plane machines	<b>&lt;master&gt;&lt;n&gt;.&lt;cluster_name&gt;.&lt;base_domain&gt;.</b>	DNS A/AAAA or CNAME records and DNS PTR records to identify each machine for the control plane nodes. These records must be resolvable by the nodes within the cluster.
Compute machines	<b>&lt;worker&gt;&lt;n&gt;.&lt;cluster_name&gt;.&lt;base_domain&gt;.</b>	DNS A/AAAA or CNAME records and DNS PTR records to identify each machine for the worker nodes. These records must be resolvable by the nodes within the cluster.



#### NOTE

In OpenShift Container Platform 4.4 and later, you do not need to specify etcd host and SRV records in your DNS configuration.

**TIP**

You can use the **dig** command to verify name and reverse name resolution. See the section on *Validating DNS resolution for user-provisioned infrastructure* for detailed validation steps.

**16.2.3.11.1. Example DNS configuration for user-provisioned clusters**

This section provides A and PTR record configuration samples that meet the DNS requirements for deploying OpenShift Container Platform on user-provisioned infrastructure. The samples are not meant to provide advice for choosing one DNS solution over another.

In the examples, the cluster name is **ocp4** and the base domain is **example.com**.

**Example DNS A record configuration for a user-provisioned cluster**

The following example is a BIND zone file that shows sample A records for name resolution in a user-provisioned cluster.

**Example 16.1. Sample DNS zone database**

```
$TTL 1W
@ IN SOA ns1.example.com. root (
    2019070700 ; serial
    3H ; refresh (3 hours)
    30M ; retry (30 minutes)
    2W ; expiry (2 weeks)
    1W ) ; minimum (1 week)
IN NS ns1.example.com.
IN MX 10 smtp.example.com.
;
;
ns1.example.com. IN A 192.168.1.5
smtp.example.com. IN A 192.168.1.5
;
helper.example.com. IN A 192.168.1.5
helper.ocp4.example.com. IN A 192.168.1.5
;
api.ocp4.example.com. IN A 192.168.1.5 ①
api-int.ocp4.example.com. IN A 192.168.1.5 ②
;
*.apps.ocp4.example.com. IN A 192.168.1.5 ③
;
bootstrap.ocp4.example.com. IN A 192.168.1.96 ④
;
master0.ocp4.example.com. IN A 192.168.1.97 ⑤
master1.ocp4.example.com. IN A 192.168.1.98 ⑥
master2.ocp4.example.com. IN A 192.168.1.99 ⑦
;
worker0.ocp4.example.com. IN A 192.168.1.11 ⑧
worker1.ocp4.example.com. IN A 192.168.1.7 ⑨
;
;EOF
```

- ① Provides name resolution for the Kubernetes API. The record refers to the IP address of the API load balancer.

- 2 Provides name resolution for the Kubernetes API. The record refers to the IP address of the API load balancer and is used for internal cluster communications.
- 3 Provides name resolution for the wildcard routes. The record refers to the IP address of the application ingress load balancer. The application ingress load balancer targets the machines that run the Ingress Controller pods. The Ingress Controller pods run on the compute machines by default.



#### NOTE

In the example, the same load balancer is used for the Kubernetes API and application ingress traffic. In production scenarios, you can deploy the API and application ingress load balancers separately so that you can scale the load balancer infrastructure for each in isolation.

- 4 Provides name resolution for the bootstrap machine.
- 5 6 7 Provides name resolution for the control plane machines.
- 8 9 Provides name resolution for the compute machines.

### Example DNS PTR record configuration for a user-provisioned cluster

The following example BIND zone file shows sample PTR records for reverse name resolution in a user-provisioned cluster.

#### Example 16.2. Sample DNS zone database for reverse records

```
$TTL 1W
@ IN SOA ns1.example.com. root (
    2019070700 ; serial
    3H ; refresh (3 hours)
    30M ; retry (30 minutes)
    2W ; expiry (2 weeks)
    1W ) ; minimum (1 week)
IN NS ns1.example.com.
;
5.1.168.192.in-addr.arpa. IN PTR api.ocp4.example.com. 1
5.1.168.192.in-addr.arpa. IN PTR api-int.ocp4.example.com. 2
;
96.1.168.192.in-addr.arpa. IN PTR bootstrap.ocp4.example.com. 3
;
97.1.168.192.in-addr.arpa. IN PTR master0.ocp4.example.com. 4
98.1.168.192.in-addr.arpa. IN PTR master1.ocp4.example.com. 5
99.1.168.192.in-addr.arpa. IN PTR master2.ocp4.example.com. 6
;
11.1.168.192.in-addr.arpa. IN PTR worker0.ocp4.example.com. 7
7.1.168.192.in-addr.arpa. IN PTR worker1.ocp4.example.com. 8
;
;EOF
```

- 1 Provides reverse DNS resolution for the Kubernetes API. The PTR record refers to the record name of the API load balancer.
- 2 Provides reverse DNS resolution for the Kubernetes API. The PTR record refers to the record name of the API load balancer and is used for internal cluster communications.
- 3 Provides reverse DNS resolution for the bootstrap machine.
- 4 5 6 Provides reverse DNS resolution for the control plane machines.
- 7 8 Provides reverse DNS resolution for the compute machines.

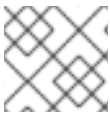
**NOTE**

A PTR record is not required for the OpenShift Container Platform application wildcard.

### 16.2.3.12. Load balancing requirements for user-provisioned infrastructure

Before you install OpenShift Container Platform, you must provision the API and application ingress load balancing infrastructure. In production scenarios, you can deploy the API and application ingress load balancers separately so that you can scale the load balancer infrastructure for each in isolation.

**NOTE**

If you want to deploy the API and application Ingress load balancers with a Red Hat Enterprise Linux (RHEL) instance, you must purchase the RHEL subscription separately.

The load balancing infrastructure must meet the following requirements:

1. **API load balancer.** Provides a common endpoint for users, both human and machine, to interact with and configure the platform. Configure the following conditions:
  - Layer 4 load balancing only. This can be referred to as Raw TCP, SSL Passthrough, or SSL Bridge mode. If you use SSL Bridge mode, you must enable Server Name Indication (SNI) for the API routes.
  - A stateless load balancing algorithm. The options vary based on the load balancer implementation.

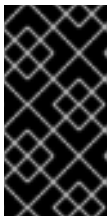
**IMPORTANT**

Do not configure session persistence for an API load balancer. Configuring session persistence for a Kubernetes API server might cause performance issues from excess application traffic for your OpenShift Container Platform cluster and the Kubernetes API that runs inside the cluster.

Configure the following ports on both the front and back of the load balancers:

**Table 16.6. API load balancer**



Port	Back-end machines (pool members)	Internal	External	Description
<b>6443</b>	Bootstrap and control plane. You remove the bootstrap machine from the load balancer after the bootstrap machine initializes the cluster control plane. You must configure the <b>/readyz</b> endpoint for the API server health check probe.	X	X	Kubernetes API server
<b>22623</b>	Bootstrap and control plane. You remove the bootstrap machine from the load balancer after the bootstrap machine initializes the cluster control plane.	X		Machine config server



### NOTE

The load balancer must be configured to take a maximum of 30 seconds from the time the API server turns off the **/readyz** endpoint to the removal of the API server instance from the pool. Within the time frame after **/readyz** returns an error or becomes healthy, the endpoint must have been removed or added. Probing every 5 or 10 seconds, with two successful requests to become healthy and three to become unhealthy, are well-tested values.

2. **Application Ingress load balancer.** Provides an ingress point for application traffic flowing in from outside the cluster. A working configuration for the Ingress router is required for an OpenShift Container Platform cluster.

Configure the following conditions:

- Layer 4 load balancing only. This can be referred to as Raw TCP, SSL Passthrough, or SSL Bridge mode. If you use SSL Bridge mode, you must enable Server Name Indication (SNI) for the ingress routes.
- A connection-based or session-based persistence is recommended, based on the options available and types of applications that will be hosted on the platform.

### TIP

If the true IP address of the client can be seen by the application Ingress load balancer, enabling source IP-based session persistence can improve performance for applications that use end-to-end TLS encryption.

Configure the following ports on both the front and back of the load balancers:

**Table 16.7. Application Ingress load balancer**

Port	Back-end machines (pool members)	Internal	External	Description
------	----------------------------------	----------	----------	-------------

Port	Back-end machines (pool members)	Internal	External	Description
<b>443</b>	The machines that run the Ingress Controller pods, compute, or worker, by default.	X	X	HTTPS traffic
<b>80</b>	The machines that run the Ingress Controller pods, compute, or worker, by default.	X	X	HTTP traffic

**NOTE**

If you are deploying a three-node cluster with zero compute nodes, the Ingress Controller pods run on the control plane nodes. In three-node cluster deployments, you must configure your application Ingress load balancer to route HTTP and HTTPS traffic to the control plane nodes.

**16.2.3.12.1. Example load balancer configuration for user-provisioned clusters**

This section provides an example API and application ingress load balancer configuration that meets the load balancing requirements for user-provisioned clusters. The sample is an `/etc/haproxy/haproxy.cfg` configuration for an HAProxy load balancer. The example is not meant to provide advice for choosing one load balancing solution over another.

In the example, the same load balancer is used for the Kubernetes API and application ingress traffic. In production scenarios, you can deploy the API and application ingress load balancers separately so that you can scale the load balancer infrastructure for each in isolation.

**NOTE**

If you are using HAProxy as a load balancer and SELinux is set to **enforcing**, you must ensure that the HAProxy service can bind to the configured TCP port by running **setsebool -P haproxy\_connect\_any=1**.

**Example 16.3. Sample API and application Ingress load balancer configuration**

```
global
  log      127.0.0.1 local2
  pidfile  /var/run/haproxy.pid
  maxconn  4000
  daemon
defaults
  mode            http
  log             global
  option          dontlognull
  option http-server-close
  option          redispatch
  retries         3
  timeout http-request  10s
  timeout queue      1m
  timeout connect    10s
  timeout client     1m
```

```

timeout server      1m
timeout http-keep-alive 10s
timeout check      10s
maxconn            3000
listen api-server-6443 1
bind *:6443
mode tcp
server bootstrap bootstrap.ocp4.example.com:6443 check inter 1s backup 2
server master0 master0.ocp4.example.com:6443 check inter 1s
server master1 master1.ocp4.example.com:6443 check inter 1s
server master2 master2.ocp4.example.com:6443 check inter 1s
listen machine-config-server-22623 3
bind *:22623
mode tcp
server bootstrap bootstrap.ocp4.example.com:22623 check inter 1s backup 4
server master0 master0.ocp4.example.com:22623 check inter 1s
server master1 master1.ocp4.example.com:22623 check inter 1s
server master2 master2.ocp4.example.com:22623 check inter 1s
listen ingress-router-443 5
bind *:443
mode tcp
balance source
server worker0 worker0.ocp4.example.com:443 check inter 1s
server worker1 worker1.ocp4.example.com:443 check inter 1s
listen ingress-router-80 6
bind *:80
mode tcp
balance source
server worker0 worker0.ocp4.example.com:80 check inter 1s
server worker1 worker1.ocp4.example.com:80 check inter 1s

```

- 1** Port **6443** handles the Kubernetes API traffic and points to the control plane machines.
- 2** **4** The bootstrap entries must be in place before the OpenShift Container Platform cluster installation and they must be removed after the bootstrap process is complete.
- 3** Port **22623** handles the machine config server traffic and points to the control plane machines.
- 5** Port **443** handles the HTTPS traffic and points to the machines that run the Ingress Controller pods. The Ingress Controller pods run on the compute machines by default.
- 6** Port **80** handles the HTTP traffic and points to the machines that run the Ingress Controller pods. The Ingress Controller pods run on the compute machines by default.



#### NOTE

If you are deploying a three-node cluster with zero compute nodes, the Ingress Controller pods run on the control plane nodes. In three-node cluster deployments, you must configure your application Ingress load balancer to route HTTP and HTTPS traffic to the control plane nodes.

**TIP**

If you are using HAProxy as a load balancer, you can check that the **haproxy** process is listening on ports **6443**, **22623**, **443**, and **80** by running **netstat -nltp** on the HAProxy node.

### 16.2.4. Preparing the user-provisioned infrastructure

Before you install OpenShift Container Platform on user-provisioned infrastructure, you must prepare the underlying infrastructure.

This section provides details about the high-level steps required to set up your cluster infrastructure in preparation for an OpenShift Container Platform installation. This includes configuring IP networking and network connectivity for your cluster nodes, enabling the required ports through your firewall, and setting up the required DNS and load balancing infrastructure.

After preparation, your cluster infrastructure must meet the requirements outlined in the *Requirements for a cluster with user-provisioned infrastructure* section.

**Prerequisites**

- You have reviewed the [OpenShift Container Platform 4.x Tested Integrations](#) page.
- You have reviewed the infrastructure requirements detailed in the *Requirements for a cluster with user-provisioned infrastructure* section.

**Procedure**

1. If you are using DHCP to provide the IP networking configuration to your cluster nodes, configure your DHCP service.
  - a. Add persistent IP addresses for the nodes to your DHCP server configuration. In your configuration, match the MAC address of the relevant network interface to the intended IP address for each node.
  - b. When you use DHCP to configure IP addressing for the cluster machines, the machines also obtain the DNS server information through DHCP. Define the persistent DNS server address that is used by the cluster nodes through your DHCP server configuration.

**NOTE**

If you are not using a DHCP service, you must provide the IP networking configuration and the address of the DNS server to the nodes at RHCOS install time. These can be passed as boot arguments if you are installing from an ISO image. See the *Installing RHCOS and starting the OpenShift Container Platform bootstrap process* section for more information about static IP provisioning and advanced networking options.

- c. Define the hostnames of your cluster nodes in your DHCP server configuration. See the *Setting the cluster node hostnames through DHCP* section for details about hostname considerations.

**NOTE**

If you are not using a DHCP service, the cluster nodes obtain their hostname through a reverse DNS lookup.

2. Choose to perform either a fast track installation of Red Hat Enterprise Linux CoreOS (RHCOS) or a full installation of Red Hat Enterprise Linux CoreOS (RHCOS). For the full installation, you must set up an HTTP or HTTPS server to provide Ignition files and install images to the cluster nodes. For the fast track installation an HTTP or HTTPS server is not required, however, a DHCP server is required. See sections "Fast-track installation: Creating Red Hat Enterprise Linux CoreOS (RHCOS) machines" and "Full installation: Creating Red Hat Enterprise Linux CoreOS (RHCOS) machines".
3. Ensure that your network infrastructure provides the required network connectivity between the cluster components. See the *Networking requirements for user-provisioned infrastructure* section for details about the requirements.
4. Configure your firewall to enable the ports required for the OpenShift Container Platform cluster components to communicate. See *Networking requirements for user-provisioned infrastructure* section for details about the ports that are required.



### IMPORTANT

By default, port **1936** is accessible for an OpenShift Container Platform cluster, because each control plane node needs access to this port.

Avoid using the Ingress load balancer to expose this port, because doing so might result in the exposure of sensitive information, such as statistics and metrics, related to Ingress Controllers.

5. Setup the required DNS infrastructure for your cluster.
  - a. Configure DNS name resolution for the Kubernetes API, the application wildcard, the bootstrap machine, the control plane machines, and the compute machines.
  - b. Configure reverse DNS resolution for the Kubernetes API, the bootstrap machine, the control plane machines, and the compute machines.  
See the *User-provisioned DNS requirements* section for more information about the OpenShift Container Platform DNS requirements.
6. Validate your DNS configuration.
  - a. From your installation node, run DNS lookups against the record names of the Kubernetes API, the wildcard routes, and the cluster nodes. Validate that the IP addresses in the responses correspond to the correct components.
  - b. From your installation node, run reverse DNS lookups against the IP addresses of the load balancer and the cluster nodes. Validate that the record names in the responses correspond to the correct components.  
See the *Validating DNS resolution for user-provisioned infrastructure* section for detailed DNS validation steps.
7. Provision the required API and application ingress load balancing infrastructure. See the *Load balancing requirements for user-provisioned infrastructure* section for more information about the requirements.



### NOTE

Some load balancing solutions require the DNS name resolution for the cluster nodes to be in place before the load balancing is initialized.

## 16.2.5. Validating DNS resolution for user-provisioned infrastructure

You can validate your DNS configuration before installing OpenShift Container Platform on user-provisioned infrastructure.



### IMPORTANT

The validation steps detailed in this section must succeed before you install your cluster.

### Prerequisites

- You have configured the required DNS records for your user-provisioned infrastructure.

### Procedure

- From your installation node, run DNS lookups against the record names of the Kubernetes API, the wildcard routes, and the cluster nodes. Validate that the IP addresses contained in the responses correspond to the correct components.

- Perform a lookup against the Kubernetes API record name. Check that the result points to the IP address of the API load balancer:

```
$ dig +noall +answer @<nameserver_ip> api.<cluster_name>.<base_domain> 1
```

- Replace **<nameserver\_ip>** with the IP address of the nameserver, **<cluster\_name>** with your cluster name, and **<base\_domain>** with your base domain name.

### Example output

```
api.ocp4.example.com. 0 IN A 192.168.1.5
```

- Perform a lookup against the Kubernetes internal API record name. Check that the result points to the IP address of the API load balancer:

```
$ dig +noall +answer @<nameserver_ip> api-int.<cluster_name>.<base_domain>
```

### Example output

```
api-int.ocp4.example.com. 0 IN A 192.168.1.5
```

- Test an example **\*.apps.<cluster\_name>.<base\_domain>** DNS wildcard lookup. All of the application wildcard lookups must resolve to the IP address of the application ingress load balancer:

```
$ dig +noall +answer @<nameserver_ip> random.apps.<cluster_name>.<base_domain>
```

### Example output

```
random.apps.ocp4.example.com. 0 IN A 192.168.1.5
```

**NOTE**

In the example outputs, the same load balancer is used for the Kubernetes API and application ingress traffic. In production scenarios, you can deploy the API and application ingress load balancers separately so that you can scale the load balancer infrastructure for each in isolation.

You can replace **random** with another wildcard value. For example, you can query the route to the OpenShift Container Platform console:

```
$ dig +noall +answer @<nameserver_ip> console-openshift-console.apps.
<cluster_name>.<base_domain>
```

**Example output**

```
console-openshift-console.apps.ocp4.example.com. 0 IN A 192.168.1.5
```

- d. Run a lookup against the bootstrap DNS record name. Check that the result points to the IP address of the bootstrap node:

```
$ dig +noall +answer @<nameserver_ip> bootstrap.<cluster_name>.<base_domain>
```

**Example output**

```
bootstrap.ocp4.example.com. 0 IN A 192.168.1.96
```

- e. Use this method to perform lookups against the DNS record names for the control plane and compute nodes. Check that the results correspond to the IP addresses of each node.
2. From your installation node, run reverse DNS lookups against the IP addresses of the load balancer and the cluster nodes. Validate that the record names contained in the responses correspond to the correct components.
- a. Perform a reverse lookup against the IP address of the API load balancer. Check that the response includes the record names for the Kubernetes API and the Kubernetes internal API:

```
$ dig +noall +answer @<nameserver_ip> -x 192.168.1.5
```

**Example output**

```
5.1.168.192.in-addr.arpa. 0 IN PTR api-int.ocp4.example.com. 1
5.1.168.192.in-addr.arpa. 0 IN PTR api.ocp4.example.com. 2
```

- 1** Provides the record name for the Kubernetes internal API.
- 2** Provides the record name for the Kubernetes API.

**NOTE**

A PTR record is not required for the OpenShift Container Platform application wildcard. No validation step is needed for reverse DNS resolution against the IP address of the application ingress load balancer.

- b. Perform a reverse lookup against the IP address of the bootstrap node. Check that the result points to the DNS record name of the bootstrap node:

```
$ dig +noall +answer @<nameserver_ip> -x 192.168.1.96
```

**Example output**

```
96.1.168.192.in-addr.arpa. 0 IN PTR bootstrap.ocp4.example.com.
```

- c. Use this method to perform reverse lookups against the IP addresses for the control plane and compute nodes. Check that the results correspond to the DNS record names of each node.

**16.2.6. Generating a key pair for cluster node SSH access**

During an OpenShift Container Platform installation, you can provide an SSH public key to the installation program. The key is passed to the Red Hat Enterprise Linux CoreOS (RHCOS) nodes through their Ignition config files and is used to authenticate SSH access to the nodes. The key is added to the `~/.ssh/authorized_keys` list for the **core** user on each node, which enables password-less authentication.

After the key is passed to the nodes, you can use the key pair to SSH in to the RHCOS nodes as the user **core**. To access the nodes through SSH, the private key identity must be managed by SSH for your local user.

If you want to SSH in to your cluster nodes to perform installation debugging or disaster recovery, you must provide the SSH public key during the installation process. The **`./openshift-install gather`** command also requires the SSH public key to be in place on the cluster nodes.

**IMPORTANT**

Do not skip this procedure in production environments, where disaster recovery and debugging is required.

**Procedure**

1. If you do not have an existing SSH key pair on your local machine to use for authentication onto your cluster nodes, create one. For example, on a computer that uses a Linux operating system, run the following command:

```
$ ssh-keygen -t ed25519 -N "" -f <path>/<file_name> 1
```

- 1** Specify the path and file name, such as `~/.ssh/id_ed25519`, of the new SSH key. If you have an existing key pair, ensure your public key is in the your `~/.ssh` directory.

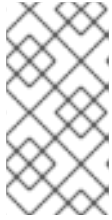

**NOTE**

If you plan to install an OpenShift Container Platform cluster that uses FIPS validated or Modules In Process cryptographic libraries on the **x86\_64** architecture, do not create a key that uses the **ed25519** algorithm. Instead, create a key that uses the **rsa** or **ecdsa** algorithm.

2. View the public SSH key:

```
$ cat <path>/<file_name>.pub
```

For example, run the following to view the `~/.ssh/id_ed25519.pub` public key:

```
$ cat ~/.ssh/id_ed25519.pub
```

3. Add the SSH private key identity to the SSH agent for your local user, if it has not already been added. SSH agent management of the key is required for password-less SSH authentication onto your cluster nodes, or if you want to use the `./openshift-install gather` command.

**NOTE**

On some distributions, default SSH private key identities such as `~/.ssh/id_rsa` and `~/.ssh/id_dsa` are managed automatically.

- a. If the **ssh-agent** process is not already running for your local user, start it as a background task:

```
$ eval "$(ssh-agent -s)"
```

**Example output**

```
Agent pid 31874
```

**NOTE**

If your cluster is in FIPS mode, only use FIPS-compliant algorithms to generate the SSH key. The key must be either RSA or ECDSA.

4. Add your SSH private key to the **ssh-agent**:

```
$ ssh-add <path>/<file_name> 1
```

- 1** Specify the path and file name for your SSH private key, such as `~/.ssh/id_ed25519`

**Example output**

```
Identity added: /home/<you>/<path>/<file_name> (<computer_name>)
```

**Next steps**

- When you install OpenShift Container Platform, provide the SSH public key to the installation program.

### 16.2.7. Obtaining the installation program

Before you install OpenShift Container Platform, download the installation file on your provisioning machine.

#### Prerequisites

- You have a machine that runs Linux, for example Red Hat Enterprise Linux 8, with 500 MB of local disk space

#### Procedure

1. Access the [Infrastructure Provider](#) page on the OpenShift Cluster Manager site. If you have a Red Hat account, log in with your credentials. If you do not, create an account.
2. Select your infrastructure provider.
3. Navigate to the page for your installation type, download the installation program that corresponds with your host operating system and architecture, and place the file in the directory where you will store the installation configuration files.

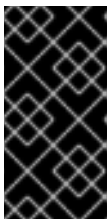

#### IMPORTANT

The installation program creates several files on the computer that you use to install your cluster. You must keep the installation program and the files that the installation program creates after you finish installing the cluster. Both files are required to delete the cluster.

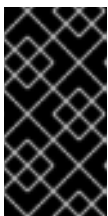

#### IMPORTANT

Deleting the files created by the installation program does not remove your cluster, even if the cluster failed during installation. To remove your cluster, complete the OpenShift Container Platform uninstallation procedures for your specific cloud provider.

4. Extract the installation program. For example, on a computer that uses a Linux operating system, run the following command:

```
$ tar -xvf openshift-install-linux.tar.gz
```

5. Download your installation [pull secret from the Red Hat OpenShift Cluster Manager](#) . This pull secret allows you to authenticate with the services that are provided by the included authorities, including Quay.io, which serves the container images for OpenShift Container Platform components.

### 16.2.8. Installing the OpenShift CLI by downloading the binary

You can install the OpenShift CLI (**oc**) to interact with OpenShift Container Platform from a command-line interface. You can install **oc** on Linux, Windows, or macOS.



## IMPORTANT

If you installed an earlier version of **oc**, you cannot use it to complete all of the commands in OpenShift Container Platform 4.10. Download and install the new version of **oc**.

### Installing the OpenShift CLI on Linux

You can install the OpenShift CLI (**oc**) binary on Linux by using the following procedure.

#### Procedure

1. Navigate to the [OpenShift Container Platform downloads page](#) on the Red Hat Customer Portal.
2. Select the appropriate version in the **Version** drop-down menu.
3. Click **Download Now** next to the **OpenShift v4.10 Linux Client** entry and save the file.
4. Unpack the archive:

```
$ tar xvf <file>
```

5. Place the **oc** binary in a directory that is on your **PATH**.  
To check your **PATH**, execute the following command:

```
$ echo $PATH
```

After you install the OpenShift CLI, it is available using the **oc** command:

```
$ oc <command>
```

### Installing the OpenShift CLI on Windows

You can install the OpenShift CLI (**oc**) binary on Windows by using the following procedure.

#### Procedure

1. Navigate to the [OpenShift Container Platform downloads page](#) on the Red Hat Customer Portal.
2. Select the appropriate version in the **Version** drop-down menu.
3. Click **Download Now** next to the **OpenShift v4.10 Windows Client** entry and save the file.
4. Unzip the archive with a ZIP program.
5. Move the **oc** binary to a directory that is on your **PATH**.  
To check your **PATH**, open the command prompt and execute the following command:

```
C:\> path
```

After you install the OpenShift CLI, it is available using the **oc** command:

```
C:\> oc <command>
```

## Installing the OpenShift CLI on macOS

You can install the OpenShift CLI (**oc**) binary on macOS by using the following procedure.

### Procedure

1. Navigate to the [OpenShift Container Platform downloads page](#) on the Red Hat Customer Portal.
2. Select the appropriate version in the **Version** drop-down menu.
3. Click **Download Now** next to the **OpenShift v4.10 MacOSX Client** entry and save the file.
4. Unpack and unzip the archive.
5. Move the **oc** binary to a directory on your PATH.  
To check your **PATH**, open a terminal and execute the following command:

```
$ echo $PATH
```

After you install the OpenShift CLI, it is available using the **oc** command:

```
$ oc <command>
```

## 16.2.9. Manually creating the installation configuration file

For user-provisioned installations of OpenShift Container Platform, you manually generate your installation configuration file.

### Prerequisites

- You have an SSH public key on your local machine to provide to the installation program. The key will be used for SSH authentication onto your cluster nodes for debugging and disaster recovery.
- You have obtained the OpenShift Container Platform installation program and the pull secret for your cluster.

### Procedure

1. Create an installation directory to store your required installation assets in:

```
$ mkdir <installation_directory>
```

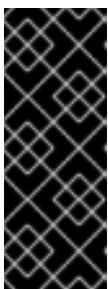

### IMPORTANT

You must create a directory. Some installation assets, like bootstrap X.509 certificates have short expiration intervals, so you must not reuse an installation directory. If you want to reuse individual files from another cluster installation, you can copy them into your directory. However, the file names for the installation assets might change between releases. Use caution when copying installation files from an earlier OpenShift Container Platform version.

2. Customize the sample **install-config.yaml** file template that is provided and save it in the **<installation\_directory>**.

**NOTE**

You must name this configuration file **install-config.yaml**.

**NOTE**

For some platform types, you can alternatively run **./openshift-install create install-config --dir <installation\_directory>** to generate an **install-config.yaml** file. You can provide details about your cluster configuration at the prompts.

3. Back up the **install-config.yaml** file so that you can use it to install multiple clusters.

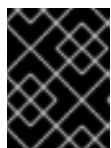
**IMPORTANT**

The **install-config.yaml** file is consumed during the next step of the installation process. You must back it up now.

### 16.2.9.1. Installation configuration parameters

Before you deploy an OpenShift Container Platform cluster, you provide a customized **install-config.yaml** installation configuration file that describes the details for your environment.

**NOTE**

After installation, you cannot modify these parameters in the **install-config.yaml** file.

#### 16.2.9.1.1. Required configuration parameters

Required installation configuration parameters are described in the following table:

**Table 16.8. Required parameters**

Parameter	Description	Values
<b>apiVersion</b>	The API version for the <b>install-config.yaml</b> content. The current version is <b>v1</b> . The installer may also support older API versions.	String

Parameter	Description	Values
<b>baseDomain</b>	The base domain of your cloud provider. The base domain is used to create routes to your OpenShift Container Platform cluster components. The full DNS name for your cluster is a combination of the <b>baseDomain</b> and <b>metadata.name</b> parameter values that uses the <b>&lt;metadata.name&gt;.&lt;baseDomain&gt;</b> format.	A fully-qualified domain or subdomain name, such as <b>example.com</b> .
<b>metadata</b>	Kubernetes resource <b>ObjectMeta</b> , from which only the <b>name</b> parameter is consumed.	Object
<b>metadata.name</b>	The name of the cluster. DNS records for the cluster are all subdomains of <b>{{.metadata.name}}.{{.baseDomain}}</b> .	String of lowercase letters, hyphens (-), and periods (.), such as <b>dev</b> .
<b>platform</b>	The configuration for the specific platform upon which to perform the installation: <b>alibabacloud, aws, baremetal, azure, gcp, ibmcloud, openstack, ovirt, vsphere</b> , or <b>{}</b> . For additional information about <b>platform.&lt;platform&gt;</b> parameters, consult the table for your specific platform that follows.	Object
<b>pullSecret</b>	Get a <a href="#">pull secret from the Red Hat OpenShift Cluster Manager</a> to authenticate downloading container images for OpenShift Container Platform components from services such as Quay.io.	<pre>{   "auths":{     "cloud.openshift.com":{       "auth":"b3Blb=",       "email":"you@example.com"     },     "quay.io":{       "auth":"b3Blb=",       "email":"you@example.com"     }   } }</pre>

### 16.2.9.1.2. Network configuration parameters

You can customize your installation configuration based on the requirements of your existing network infrastructure. For example, you can expand the IP address block for the cluster network or provide different IP address blocks than the defaults.

Only IPv4 addresses are supported.

Table 16.9. Network parameters

Parameter	Description	Values
<b>networking</b>	The configuration for the cluster network.	Object   <b>NOTE</b> You cannot modify parameters specified by the <b>networking</b> object after installation.
<b>networking.network Type</b>	The cluster network provider Container Network Interface (CNI) plugin to install.	Either <b>OpenShiftSDN</b> or <b>OVNKubernetes</b> . <b>OpenShiftSDN</b> is a CNI provider for all-Linux networks. <b>OVNKubernetes</b> is a CNI provider for Linux networks and hybrid networks that contain both Linux and Windows servers. The default value is <b>OpenShiftSDN</b> .
<b>networking.clusterNetwork</b>	The IP address blocks for pods.  The default value is <b>10.128.0.0/14</b> with a host prefix of <b>/23</b> .  If you specify multiple IP address blocks, the blocks must not overlap.	An array of objects. For example:  <pre>networking:   clusterNetwork:     - cidr: 10.128.0.0/14       hostPrefix: 23</pre>
<b>networking.clusterNetwork.cidr</b>	Required if you use <b>networking.clusterNetwork</b> . An IP address block.  An IPv4 network.	An IP address block in Classless Inter-Domain Routing (CIDR) notation. The prefix length for an IPv4 block is between <b>0</b> and <b>32</b> .
<b>networking.clusterNetwork.hostPrefix</b>	The subnet prefix length to assign to each individual node. For example, if <b>hostPrefix</b> is set to <b>23</b> then each node is assigned a <b>/23</b> subnet out of the given <b>cidr</b> . A <b>hostPrefix</b> value of <b>23</b> provides 510 ( $2^{(32 - 23)} - 2$ ) pod IP addresses.	A subnet prefix.  The default value is <b>23</b> .

Parameter	Description	Values
<b>networking.serviceNetwork</b>	<p>The IP address block for services. The default value is <b>172.30.0.0/16</b>.</p> <p>The OpenShift SDN and OVN-Kubernetes network providers support only a single IP address block for the service network.</p>	<p>An array with an IP address block in CIDR format. For example:</p> <pre>networking:   serviceNetwork:   - 172.30.0.0/16</pre>
<b>networking.machineNetwork</b>	<p>The IP address blocks for machines.</p> <p>If you specify multiple IP address blocks, the blocks must not overlap.</p> <p>If you specify multiple IP kernel arguments, the <b>machineNetwork.cidr</b> value must be the CIDR of the primary network.</p>	<p>An array of objects. For example:</p> <pre>networking:   machineNetwork:   - cidr: 10.0.0.0/16</pre>
<b>networking.machineNetwork.cidr</b>	<p>Required if you use <b>networking.machineNetwork</b>. An IP address block. The default value is <b>10.0.0.0/16</b> for all platforms other than libvirt. For libvirt, the default value is <b>192.168.126.0/24</b>.</p>	<p>An IP network block in CIDR notation.</p> <p>For example, <b>10.0.0.0/16</b>.</p> <div style="display: flex; align-items: flex-start;">  <div> <p><b>NOTE</b></p> <p>Set the <b>networking.machineNetwork</b> to match the CIDR that the preferred NIC resides in.</p> </div> </div>

### 16.2.9.1.3. Optional configuration parameters

Optional installation configuration parameters are described in the following table:

Table 16.10. Optional parameters

Parameter	Description	Values
<b>additionalTrustBundle</b>	<p>A PEM-encoded X.509 certificate bundle that is added to the nodes' trusted certificate store. This trust bundle may also be used when a proxy has been configured.</p>	String





Parameter	Description	Values
<b>cgroupsV2</b>	Enables <a href="#">Linux control groups version 2</a> (cgroups v2) on specific nodes in your cluster. The OpenShift Container Platform process for enabling cgroups v2 disables all cgroup version 1 controllers and hierarchies. The OpenShift Container Platform cgroups version 2 feature is in Developer Preview and is not supported by Red Hat at this time.	<b>true</b>
<b>compute</b>	The configuration for the machines that comprise the compute nodes.	Array of <b>MachinePool</b> objects.
<b>compute.architecture</b>	Determines the instruction set architecture of the machines in the pool. Currently, heterogeneous clusters are not supported, so all pools must specify the same architecture. Valid values are <b>s390x</b> (the default).	String
<b>compute.hyperthreading</b>	Whether to enable or disable simultaneous multithreading, or <b>hyperthreading</b> , on compute machines. By default, simultaneous multithreading is enabled to increase the performance of your machines' cores.   <b>IMPORTANT</b> If you disable simultaneous multithreading, ensure that your capacity planning accounts for the dramatically decreased machine performance.	<b>Enabled</b> or <b>Disabled</b>
<b>compute.name</b>	Required if you use <b>compute</b> . The name of the machine pool.	<b>worker</b>
<b>compute.platform</b>	Required if you use <b>compute</b> . Use this parameter to specify the cloud provider to host the worker machines. This parameter value must match the <b>controlPlane.platform</b> parameter value.	<b>alibabacloud, aws, azure, gcp, ibmcloud, openstack, ovirt, vsphere, or {}</b>

Parameter	Description	Values
<b>compute.replicas</b>	The number of compute machines, which are also known as worker machines, to provision.	A positive integer greater than or equal to <b>2</b> . The default value is <b>3</b> .
<b>controlPlane</b>	The configuration for the machines that comprise the control plane.	Array of <b>MachinePool</b> objects.
<b>controlPlane.architecture</b>	Determines the instruction set architecture of the machines in the pool. Currently, heterogeneous clusters are not supported, so all pools must specify the same architecture. Valid values are <b>s390x</b> (the default).	String
<b>controlPlane.hyperthreading</b>	<p>Whether to enable or disable simultaneous multithreading, or <b>hyperthreading</b>, on control plane machines. By default, simultaneous multithreading is enabled to increase the performance of your machines' cores.</p> <div style="display: flex; align-items: center;">  <div> <p><b>IMPORTANT</b></p> <p>If you disable simultaneous multithreading, ensure that your capacity planning accounts for the dramatically decreased machine performance.</p> </div> </div>	<b>Enabled</b> or <b>Disabled</b>
<b>controlPlane.name</b>	Required if you use <b>controlPlane</b> . The name of the machine pool.	<b>master</b>
<b>controlPlane.platform</b>	Required if you use <b>controlPlane</b> . Use this parameter to specify the cloud provider that hosts the control plane machines. This parameter value must match the <b>compute.platform</b> parameter value.	<b>alibabacloud, aws, azure, gcp, ibmcloud, openstack, ovirt, vsphere</b> , or <b>{}</b>
<b>controlPlane.replicas</b>	The number of control plane machines to provision.	The only supported value is <b>3</b> , which is the default value.

Parameter	Description	Values
<b>credentialsMode</b>	<p>The Cloud Credential Operator (CCO) mode. If no mode is specified, the CCO dynamically tries to determine the capabilities of the provided credentials, with a preference for mint mode on the platforms where multiple modes are supported.</p> <div data-bbox="485 510 595 864" style="border: 1px solid black; padding: 5px; margin-bottom: 10px;"> <p><b>NOTE</b></p> <p>Not all CCO modes are supported for all cloud providers. For more information on CCO modes, see the <i>Cloud Credential Operator</i> entry in the <i>Cluster Operators reference content</i>.</p> </div> <div data-bbox="485 909 595 1263" style="border: 1px solid black; padding: 5px;"> <p><b>NOTE</b></p> <p>If your AWS account has service control policies (SCP) enabled, you must configure the <b>credentialsMode</b> parameter to <b>Mint</b>, <b>Passthrough</b> or <b>Manual</b>.</p> </div>	<b>Mint, Passthrough, Manual</b> or an empty string ("").

Parameter	Description	Values
<b>fips</b>	<p>Enable or disable FIPS mode. The default is <b>false</b> (disabled). If FIPS mode is enabled, the Red Hat Enterprise Linux CoreOS (RHCOS) machines that OpenShift Container Platform runs on bypass the default Kubernetes cryptography suite and use the cryptography modules that are provided with RHCOS instead.</p> <div style="display: flex; align-items: flex-start;"> <div style="width: 20px; height: 100px; background: repeating-linear-gradient(45deg, transparent, transparent 2px, black 2px, black 4px); margin-right: 10px;"></div> <div> <p><b>IMPORTANT</b></p> <p>To enable FIPS mode for your cluster, you must run the installation program from a Red Hat Enterprise Linux (RHEL) computer configured to operate in FIPS mode. For more information about configuring FIPS mode on RHEL, see <a href="#">Installing the system in FIPS mode</a>. The use of FIPS validated or Modules In Process cryptographic libraries is only supported on OpenShift Container Platform deployments on the <b>x86_64</b> architecture.</p> </div> </div> <div style="display: flex; align-items: flex-start; margin-top: 10px;"> <div style="width: 20px; height: 100px; background: repeating-linear-gradient(45deg, transparent, transparent 2px, black 2px, black 4px); margin-right: 10px;"></div> <div> <p><b>NOTE</b></p> <p>If you are using Azure File storage, you cannot enable FIPS mode.</p> </div> </div>	<b>false</b> or <b>true</b>
<b>imageContentSources</b>	Sources and repositories for the release-image content.	Array of objects. Includes a <b>source</b> and, optionally, <b>mirrors</b> , as described in the following rows of this table.
<b>imageContentSources.source</b>	Required if you use <b>imageContentSources</b> . Specify the repository that users refer to, for example, in image pull specifications.	String
<b>imageContentSources.mirrors</b>	Specify one or more repositories that may also contain the same images.	Array of strings

Parameter	Description	Values
<b>publish</b>	How to publish or expose the user-facing endpoints of your cluster, such as the Kubernetes API, OpenShift routes.	<p><b>Internal</b> or <b>External</b>. The default value is <b>External</b>.</p> <p>Setting this field to <b>Internal</b> is not supported on non-cloud platforms and IBM Cloud VPC.</p> <div style="display: flex; align-items: flex-start;">  <div> <p><b>IMPORTANT</b></p> <p>If the value of the field is set to <b>Internal</b>, the cluster will become non-functional. For more information, refer to <a href="#">BZ#1953035</a>.</p> </div> </div>
<b>sshKey</b>	<p>The SSH key or keys to authenticate access your cluster machines.</p> <div style="display: flex; align-items: flex-start;">  <div> <p><b>NOTE</b></p> <p>For production OpenShift Container Platform clusters on which you want to perform installation debugging or disaster recovery, specify an SSH key that your <b>ssh-agent</b> process uses.</p> </div> </div>	<p>One or more keys. For example:</p> <pre>sshKey:   &lt;key1&gt;   &lt;key2&gt;   &lt;key3&gt;</pre>

### 16.2.9.2. Sample install-config.yaml file for IBM Z

You can customize the **install-config.yaml** file to specify more details about your OpenShift Container Platform cluster's platform or modify the values of the required parameters.

```
apiVersion: v1
baseDomain: example.com 1
compute: 2
- hyperthreading: Enabled 3
  name: worker
  replicas: 0 4
  architecture : s390x
controlPlane: 5
  hyperthreading: Enabled 6
  name: master
  replicas: 3 7
  architecture : s390x
metadata:
```

```

name: test 8
networking:
  clusterNetwork:
    - cidr: 10.128.0.0/14 9
      hostPrefix: 23 10
  networkType: OpenShiftSDN
  serviceNetwork: 11
    - 172.30.0.0/16
platform:
  none: {} 12
fips: false 13
pullSecret: '{"auths": ...}' 14
sshKey: 'ssh-ed25519 AAAA...' 15

```

- 1** The base domain of the cluster. All DNS records must be sub-domains of this base and include the cluster name.
- 2 5** The **controlPlane** section is a single mapping, but the **compute** section is a sequence of mappings. To meet the requirements of the different data structures, the first line of the **compute** section must begin with a hyphen, -, and the first line of the **controlPlane** section must not. Only one control plane pool is used.
- 3 6** Specifies whether to enable or disable simultaneous multithreading (SMT), or hyperthreading. By default, SMT is enabled to increase the performance of the cores in your machines. You can disable it by setting the parameter value to **Disabled**. If you disable SMT, you must disable it in all cluster machines; this includes both control plane and compute machines.

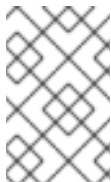

#### NOTE

Simultaneous multithreading (SMT) is enabled by default. If SMT is not available on your OpenShift Container Platform nodes, the **hyperthreading** parameter has no effect.



#### IMPORTANT

If you disable **hyperthreading**, whether on your OpenShift Container Platform nodes or in the **install-config.yaml** file, ensure that your capacity planning accounts for the dramatically decreased machine performance.

- 4** You must set this value to **0** when you install OpenShift Container Platform on user-provisioned infrastructure. In installer-provisioned installations, the parameter controls the number of compute machines that the cluster creates and manages for you. In user-provisioned installations, you must manually deploy the compute machines before you finish installing the cluster.

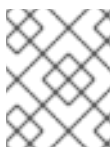

#### NOTE

If you are installing a three-node cluster, do not deploy any compute machines when you install the Red Hat Enterprise Linux CoreOS (RHCOS) machines.

- 7** The number of control plane machines that you add to the cluster. Because the cluster uses these values as the number of etcd endpoints in the cluster, the value must match the number of control plane machines that you deploy.

- 8 The cluster name that you specified in your DNS records.
- 9 A block of IP addresses from which pod IP addresses are allocated. This block must not overlap with existing physical networks. These IP addresses are used for the pod network. If you need to access the pods from an external network, you must configure load balancers and routers to manage the traffic.



#### NOTE

Class E CIDR range is reserved for a future use. To use the Class E CIDR range, you must ensure your networking environment accepts the IP addresses within the Class E CIDR range.

- 10 The subnet prefix length to assign to each individual node. For example, if **hostPrefix** is set to **23**, then each node is assigned a **/23** subnet out of the given **cidr**, which allows for 510 ( $2^{(32 - 23)} - 2$ ) pod IP addresses. If you are required to provide access to nodes from an external network, configure load balancers and routers to manage the traffic.
- 11 The IP address pool to use for service IP addresses. You can enter only one IP address pool. This block must not overlap with existing physical networks. If you need to access the services from an external network, configure load balancers and routers to manage the traffic.
- 12 You must set the platform to **none**. You cannot provide additional platform configuration variables for IBM Z infrastructure.



#### IMPORTANT

Clusters that are installed with the platform type **none** are unable to use some features, such as managing compute machines with the Machine API. This limitation applies even if the compute machines that are attached to the cluster are installed on a platform that would normally support the feature. This parameter cannot be changed after installation.

- 13 Whether to enable or disable FIPS mode. By default, FIPS mode is not enabled. If FIPS mode is enabled, the Red Hat Enterprise Linux CoreOS (RHCOS) machines that OpenShift Container Platform runs on bypass the default Kubernetes cryptography suite and use the cryptography modules that are provided with RHCOS instead.



#### IMPORTANT

To enable FIPS mode for your cluster, you must run the installation program from a Red Hat Enterprise Linux (RHEL) computer configured to operate in FIPS mode. For more information about configuring FIPS mode on RHEL, see [Installing the system in FIPS mode](#). The use of FIPS validated or Modules In Process cryptographic libraries is only supported on OpenShift Container Platform deployments on the **x86\_64** architecture.

- 14 The [pull secret from the Red Hat OpenShift Cluster Manager](#) . This pull secret allows you to authenticate with the services that are provided by the included authorities, including Quay.io, which serves the container images for OpenShift Container Platform components.
- 15 The SSH public key for the **core** user in Red Hat Enterprise Linux CoreOS (RHCOS).

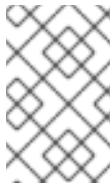
**NOTE**

For production OpenShift Container Platform clusters on which you want to perform installation debugging or disaster recovery, specify an SSH key that your **ssh-agent** process uses.

**16.2.9.3. Configuring the cluster-wide proxy during installation**

Production environments can deny direct access to the internet and instead have an HTTP or HTTPS proxy available. You can configure a new OpenShift Container Platform cluster to use a proxy by configuring the proxy settings in the **install-config.yaml** file.

**Prerequisites**

- You have an existing **install-config.yaml** file.
- You reviewed the sites that your cluster requires access to and determined whether any of them need to bypass the proxy. By default, all cluster egress traffic is proxied, including calls to hosting cloud provider APIs. You added sites to the **Proxy** object's **spec.noProxy** field to bypass the proxy if necessary.

**NOTE**

The **Proxy** object **status.noProxy** field is populated with the values of the **networking.machineNetwork[].cidr**, **networking.clusterNetwork[].cidr**, and **networking.serviceNetwork[]** fields from your installation configuration.

For installations on Amazon Web Services (AWS), Google Cloud Platform (GCP), Microsoft Azure, and Red Hat OpenStack Platform (RHOSP), the **Proxy** object **status.noProxy** field is also populated with the instance metadata endpoint (**169.254.169.254**).

**Procedure**

1. Edit your **install-config.yaml** file and add the proxy settings. For example:

```
apiVersion: v1
baseDomain: my.domain.com
proxy:
  httpProxy: http://<username>:<pswd>@<ip>:<port> 1
  httpsProxy: https://<username>:<pswd>@<ip>:<port> 2
  noProxy: example.com 3
additionalTrustBundle: | 4
  -----BEGIN CERTIFICATE-----
  <MY_TRUSTED_CA_CERT>
  -----END CERTIFICATE-----
...
```

- 1 A proxy URL to use for creating HTTP connections outside the cluster. The URL scheme must be **http**.
- 2 A proxy URL to use for creating HTTPS connections outside the cluster.



- 3 A comma-separated list of destination domain names, IP addresses, or other network CIDRs to exclude from proxying. Preface a domain with `.` to match subdomains only. For
- 4 If provided, the installation program generates a config map that is named **user-ca-bundle** in the **openshift-config** namespace that contains one or more additional CA certificates that are required for proxying HTTPS connections. The Cluster Network Operator then creates a **trusted-ca-bundle** config map that merges these contents with the Red Hat Enterprise Linux CoreOS (RHCOS) trust bundle, and this config map is referenced in the **trustedCA** field of the **Proxy** object. The **additionalTrustBundle** field is required unless the proxy's identity certificate is signed by an authority from the RHCOS trust bundle.

**NOTE**

The installation program does not support the proxy **readinessEndpoints** field.

**NOTE**

If the installer times out, restart and then complete the deployment by using the **wait-for** command of the installer. For example:

```
$ ./openshift-install wait-for install-complete --log-level debug
```

2. Save the file and reference it when installing OpenShift Container Platform.

The installation program creates a cluster-wide proxy that is named **cluster** that uses the proxy settings in the provided **install-config.yaml** file. If no proxy settings are provided, a **cluster Proxy** object is still created, but it will have a nil **spec**.

**NOTE**

Only the **Proxy** object named **cluster** is supported, and no additional proxies can be created.

#### 16.2.9.4. Configuring a three-node cluster

Optionally, you can deploy zero compute machines in a minimal three node cluster that consists of three control plane machines only. This provides smaller, more resource efficient clusters for cluster administrators and developers to use for testing, development, and production.

In three-node OpenShift Container Platform environments, the three control plane machines are schedulable, which means that your application workloads are scheduled to run on them.

#### Prerequisites

- You have an existing **install-config.yaml** file.

#### Procedure

- Ensure that the number of compute replicas is set to **0** in your **install-config.yaml** file, as shown in the following **compute** stanza:

```
compute:
```

```
- name: worker
  platform: {}
  replicas: 0
```



## NOTE

You must set the value of the **replicas** parameter for the compute machines to **0** when you install OpenShift Container Platform on user-provisioned infrastructure, regardless of the number of compute machines you are deploying. In installer-provisioned installations, the parameter controls the number of compute machines that the cluster creates and manages for you. This does not apply to user-provisioned installations, where the compute machines are deployed manually.

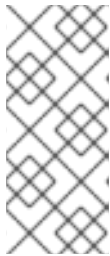

## NOTE

The preferred resource for control plane nodes is six vCPUs and 21 GB. For three control plane nodes this is the memory + vCPU equivalent of a minimum five-node cluster. You should back the three nodes, each installed on a 120 GB disk, with three IFLs that are SMT2 enabled. The minimum tested setup is three vCPUs and 10 GB on a 120 GB disk for each control plane node.

For three-node cluster installations, follow these next steps:

- If you are deploying a three-node cluster with zero compute nodes, the Ingress Controller pods run on the control plane nodes. In three-node cluster deployments, you must configure your application ingress load balancer to route HTTP and HTTPS traffic to the control plane nodes. See the *Load balancing requirements for user-provisioned infrastructure* section for more information.
- When you create the Kubernetes manifest files in the following procedure, ensure that the **mastersSchedulable** parameter in the `<installation_directory>/manifests/cluster-scheduler-02-config.yml` file is set to **true**. This enables your application workloads to run on the control plane nodes.
- Do not deploy any compute nodes when you create the Red Hat Enterprise Linux CoreOS (RHCOS) machines.

### 16.2.10. Cluster Network Operator configuration

The configuration for the cluster network is specified as part of the Cluster Network Operator (CNO) configuration and stored in a custom resource (CR) object that is named **cluster**. The CR specifies the fields for the **Network** API in the **operator.openshift.io** API group.

The CNO configuration inherits the following fields during cluster installation from the **Network** API in the **Network.config.openshift.io** API group and these fields cannot be changed:

#### **clusterNetwork**

IP address pools from which pod IP addresses are allocated.

#### **serviceNetwork**

IP address pool for services.

#### **defaultNetwork.type**

Cluster network provider, such as OpenShift SDN or OVN-Kubernetes.

You can specify the cluster network provider configuration for your cluster by setting the fields for the **defaultNetwork** object in the CNO object named **cluster**.

### 16.2.10.1. Cluster Network Operator configuration object

The fields for the Cluster Network Operator (CNO) are described in the following table:

Table 16.11. Cluster Network Operator configuration object

Field	Type	Description
<b>metadata.name</b>	<b>string</b>	The name of the CNO object. This name is always <b>cluster</b> .
<b>spec.clusterNetwork</b>	<b>array</b>	<p>A list specifying the blocks of IP addresses from which pod IP addresses are allocated and the subnet prefix length assigned to each individual node in the cluster. For example:</p> <pre>spec:   clusterNetwork:   - cidr: 10.128.0.0/19     hostPrefix: 23   - cidr: 10.128.32.0/19     hostPrefix: 23</pre> <p>You can customize this field only in the <b>install-config.yaml</b> file before you create the manifests. The value is read-only in the manifest file.</p>
<b>spec.serviceNetwork</b>	<b>array</b>	<p>A block of IP addresses for services. The OpenShift SDN and OVN-Kubernetes Container Network Interface (CNI) network providers support only a single IP address block for the service network. For example:</p> <pre>spec:   serviceNetwork:   - 172.30.0.0/14</pre> <p>You can customize this field only in the <b>install-config.yaml</b> file before you create the manifests. The value is read-only in the manifest file.</p>
<b>spec.defaultNetwork</b>	<b>object</b>	Configures the Container Network Interface (CNI) cluster network provider for the cluster network.
<b>spec.kubeProxyConfig</b>	<b>object</b>	The fields for this object specify the kube-proxy configuration. If you are using the OVN-Kubernetes cluster network provider, the kube-proxy configuration has no effect.

### defaultNetwork object configuration

The values for the **defaultNetwork** object are defined in the following table:

Table 16.12. defaultNetwork object

Field	Type	Description
<b>type</b>	<b>string</b>	<p>Either <b>OpenShiftSDN</b> or <b>OVNKubernetes</b>. The cluster network provider is selected during installation. This value cannot be changed after cluster installation.</p> <div style="display: flex; align-items: flex-start;">  <p><b>NOTE</b></p> <p>OpenShift Container Platform uses the OpenShift SDN Container Network Interface (CNI) cluster network provider by default.</p> </div>
<b>openshiftSDNConfig</b>	<b>object</b>	This object is only valid for the OpenShift SDN cluster network provider.
<b>ovnKubernetesConfig</b>	<b>object</b>	This object is only valid for the OVN-Kubernetes cluster network provider.

#### Configuration for the OpenShift SDN CNI cluster network provider

The following table describes the configuration fields for the OpenShift SDN Container Network Interface (CNI) cluster network provider.

Table 16.13. **openshiftSDNConfig** object

Field	Type	Description
<b>mode</b>	<b>string</b>	<p>Configures the network isolation mode for OpenShift SDN. The default value is <b>NetworkPolicy</b>.</p> <p>The values <b>Multitenant</b> and <b>Subnet</b> are available for backwards compatibility with OpenShift Container Platform 3.x but are not recommended. This value cannot be changed after cluster installation.</p>

Field	Type	Description
<b>mtu</b>	<b>integer</b>	<p>The maximum transmission unit (MTU) for the VXLAN overlay network. This is detected automatically based on the MTU of the primary network interface. You do not normally need to override the detected MTU.</p> <p>If the auto-detected value is not what you expect it to be, confirm that the MTU on the primary network interface on your nodes is correct. You cannot use this option to change the MTU value of the primary network interface on the nodes.</p> <p>If your cluster requires different MTU values for different nodes, you must set this value to <b>50</b> less than the lowest MTU value in your cluster. For example, if some nodes in your cluster have an MTU of <b>9001</b>, and some have an MTU of <b>1500</b>, you must set this value to <b>1450</b>.</p> <p>This value cannot be changed after cluster installation.</p>
<b>vxlanPort</b>	<b>integer</b>	<p>The port to use for all VXLAN packets. The default value is <b>4789</b>. This value cannot be changed after cluster installation.</p> <p>If you are running in a virtualized environment with existing nodes that are part of another VXLAN network, then you might be required to change this. For example, when running an OpenShift SDN overlay on top of VMware NSX-T, you must select an alternate port for the VXLAN, because both SDNs use the same default VXLAN port number.</p> <p>On Amazon Web Services (AWS), you can select an alternate port for the VXLAN between port <b>9000</b> and port <b>9999</b>.</p>

### Example OpenShift SDN configuration

```
defaultNetwork:
  type: OpenShiftSDN
  openshiftSDNConfig:
    mode: NetworkPolicy
    mtu: 1450
    vxlanPort: 4789
```

### Configuration for the OVN-Kubernetes CNI cluster network provider

The following table describes the configuration fields for the OVN-Kubernetes CNI cluster network provider.

**Table 16.14. ovnKubernetesConfig object**

Field	Type	Description
-------	------	-------------

Field	Type	Description
<b>mtu</b>	<b>integer</b>	<p>The maximum transmission unit (MTU) for the Geneve (Generic Network Virtualization Encapsulation) overlay network. This is detected automatically based on the MTU of the primary network interface. You do not normally need to override the detected MTU.</p> <p>If the auto-detected value is not what you expect it to be, confirm that the MTU on the primary network interface on your nodes is correct. You cannot use this option to change the MTU value of the primary network interface on the nodes.</p> <p>If your cluster requires different MTU values for different nodes, you must set this value to <b>100</b> less than the lowest MTU value in your cluster. For example, if some nodes in your cluster have an MTU of <b>9001</b>, and some have an MTU of <b>1500</b>, you must set this value to <b>1400</b>.</p>
<b>genevePort</b>	<b>integer</b>	The port to use for all Geneve packets. The default value is <b>6081</b> . This value cannot be changed after cluster installation.
<b>ipsecConfig</b>	<b>object</b>	Specify an empty object to enable IPsec encryption. This value cannot be changed after cluster installation.
<b>policyAuditConfig</b>	<b>object</b>	Specify a configuration object for customizing network policy audit logging. If unset, the defaults audit log settings are used.
<b>gatewayConfig</b>	<b>object</b>	<p>Optional: Specify a configuration object for customizing how egress traffic is sent to the node gateway.</p> <div style="display: flex; align-items: flex-start;">  <div> <p><b>NOTE</b></p> <p>While migrating egress traffic, you can expect some disruption to workloads and service traffic until the Cluster Network Operator (CNO) successfully rolls out the changes.</p> </div> </div>

Table 16.15. **policyAuditConfig** object

Field	Type	Description
<b>rateLimit</b>	integer	The maximum number of messages to generate every second per node. The default value is <b>20</b> messages per second.
<b>maxFileSize</b>	integer	The maximum size for the audit log in bytes. The default value is <b>50000000</b> or 50 MB.

Field	Type	Description
<b>destination</b>	string	<p>One of the following additional audit log targets:</p> <p><b>libc</b> The libc <b>syslog()</b> function of the journald process on the host.</p> <p><b>udp:&lt;host&gt;:&lt;port&gt;</b> A syslog server. Replace <b>&lt;host&gt;:&lt;port&gt;</b> with the host and port of the syslog server.</p> <p><b>unix:&lt;file&gt;</b> A Unix Domain Socket file specified by <b>&lt;file&gt;</b>.</p> <p><b>null</b> Do not send the audit logs to any additional target.</p>
<b>syslogFacility</b>	string	The syslog facility, such as <b>kern</b> , as defined by RFC5424. The default value is <b>local0</b> .

Table 16.16. gatewayConfig object

Field	Type	Description
<b>routingViaHost</b>	<b>boolean</b>	<p>Set this field to <b>true</b> to send egress traffic from pods to the host networking stack. For highly-specialized installations and applications that rely on manually configured routes in the kernel routing table, you might want to route egress traffic to the host networking stack. By default, egress traffic is processed in OVN to exit the cluster and is not affected by specialized routes in the kernel routing table. The default value is <b>false</b>.</p> <p>This field has an interaction with the Open vSwitch hardware offloading feature. If you set this field to <b>true</b>, you do not receive the performance benefits of the offloading because egress traffic is processed by the host networking stack.</p>

### Example OVN-Kubernetes configuration with IPsec enabled

```

defaultNetwork:
  type: OVNKubernetes
  ovnKubernetesConfig:
    mtu: 1400
    genevePort: 6081
    ipsecConfig: {}

```

### kubeProxyConfig object configuration

The values for the **kubeProxyConfig** object are defined in the following table:

Table 16.17. kubeProxyConfig object

Field	Type	Description
<b>iptablesSyncPeriod</b>	<b>string</b>	<p>The refresh period for <b>iptables</b> rules. The default value is <b>30s</b>. Valid suffixes include <b>s</b>, <b>m</b>, and <b>h</b> and are described in the <a href="#">Go time package</a> documentation.</p> <div style="display: flex; align-items: flex-start;">  <div> <p><b>NOTE</b></p> <p>Because of performance improvements introduced in OpenShift Container Platform 4.3 and greater, adjusting the <b>iptablesSyncPeriod</b> parameter is no longer necessary.</p> </div> </div>
<b>proxyArguments.iptables-min-sync-period</b>	<b>array</b>	<p>The minimum duration before refreshing <b>iptables</b> rules. This field ensures that the refresh does not happen too frequently. Valid suffixes include <b>s</b>, <b>m</b>, and <b>h</b> and are described in the <a href="#">Go time package</a>. The default value is:</p> <pre>kubeProxyConfig:   proxyArguments:     iptables-min-sync-period:       - 0s</pre>

### 16.2.11. Creating the Kubernetes manifest and Ignition config files

Because you must modify some cluster definition files and manually start the cluster machines, you must generate the Kubernetes manifest and Ignition config files that the cluster needs to configure the machines.

The installation configuration file transforms into the Kubernetes manifests. The manifests wrap into the Ignition configuration files, which are later used to configure the cluster machines.



#### IMPORTANT

- The Ignition config files that the OpenShift Container Platform installation program generates contain certificates that expire after 24 hours, which are then renewed at that time. If the cluster is shut down before renewing the certificates and the cluster is later restarted after the 24 hours have elapsed, the cluster automatically recovers the expired certificates. The exception is that you must manually approve the pending **node-bootstrapper** certificate signing requests (CSRs) to recover kubelet certificates. See the documentation for *Recovering from expired control plane certificates* for more information.
- It is recommended that you use Ignition config files within 12 hours after they are generated because the 24-hour certificate rotates from 16 to 22 hours after the cluster is installed. By using the Ignition config files within 12 hours, you can avoid installation failure if the certificate update runs during installation.





## NOTE

The installation program that generates the manifest and Ignition files is architecture specific and can be obtained from the [client image mirror](#). The Linux version of the installation program runs on s390x only. This installer program is also available as a Mac OS version.

## Prerequisites

- You obtained the OpenShift Container Platform installation program.
- You created the **install-config.yaml** installation configuration file.

## Procedure

1. Change to the directory that contains the OpenShift Container Platform installation program and generate the Kubernetes manifests for the cluster:

```
$ ./openshift-install create manifests --dir <installation_directory> 1
```

- 1** For **<installation\_directory>**, specify the installation directory that contains the **install-config.yaml** file you created.



## WARNING

If you are installing a three-node cluster, skip the following step to allow the control plane nodes to be schedulable.



## IMPORTANT

When you configure control plane nodes from the default unschedulable to schedulable, additional subscriptions are required. This is because control plane nodes then become worker nodes.

2. Check that the **mastersSchedulable** parameter in the **<installation\_directory>/manifests/cluster-scheduler-02-config.yml** Kubernetes manifest file is set to **false**. This setting prevents pods from being scheduled on the control plane machines:
  - a. Open the **<installation\_directory>/manifests/cluster-scheduler-02-config.yml** file.
  - b. Locate the **mastersSchedulable** parameter and ensure that it is set to **false**.
  - c. Save and exit the file.
3. To create the Ignition configuration files, run the following command from the directory that contains the installation program:

```
$ ./openshift-install create ignition-configs --dir <installation_directory> 1
```

- 1 For `<installation_directory>`, specify the same installation directory.

Ignition config files are created for the bootstrap, control plane, and compute nodes in the installation directory. The `kubeadmin-password` and `kubeconfig` files are created in the `./<installation_directory>/auth` directory:

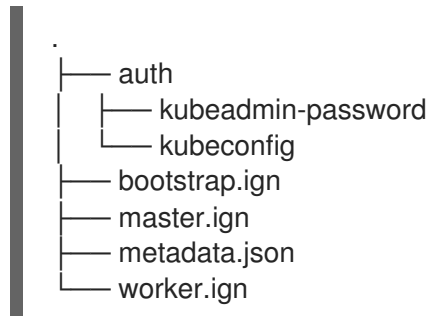

## 16.2.12. Installing RHCOS and starting the OpenShift Container Platform bootstrap process

To install OpenShift Container Platform on IBM Z infrastructure that you provision, you must install Red Hat Enterprise Linux CoreOS (RHCOS) as Red Hat Enterprise Linux (RHEL) guest virtual machines. When you install RHCOS, you must provide the Ignition config file that was generated by the OpenShift Container Platform installation program for the type of machine you are installing. If you have configured suitable networking, DNS, and load balancing infrastructure, the OpenShift Container Platform bootstrap process begins automatically after the RHCOS machines have rebooted.

You can perform a fast-track installation of RHCOS that uses a prepackaged QEMU copy-on-write (QCOW2) disk image. Alternatively, you can perform a full installation on a new QCOW2 disk image.

### 16.2.12.1. Fast-track installation by using a prepackaged QCOW2 disk image

Complete the following steps to create the machines in a fast-track installation of Red Hat Enterprise Linux CoreOS (RHCOS), importing a prepackaged Red Hat Enterprise Linux CoreOS (RHCOS) QEMU copy-on-write (QCOW2) disk image.

#### Prerequisites

- At least one LPAR running RHEL 8.4 with KVM, referred to as RHEL KVM host in this procedure.
- The KVM/QEMU hypervisor is installed on the RHEL KVM host.
- A domain name server (DNS) that can perform hostname and reverse lookup for the nodes.
- A DHCP server that provides IP addresses.

#### Procedure

1. Obtain the RHEL QEMU copy-on-write (QCOW2) disk image file from the [Product Downloads](#) page on the Red Hat Customer Portal or from the [RHCOS image mirror](#) page.

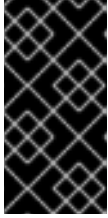
**IMPORTANT**

The RHCOS images might not change with every release of OpenShift Container Platform. You must download images with the highest version that is less than or equal to the OpenShift Container Platform version that you install. Only use the appropriate RHCOS QCOW2 image described in the following procedure.

2. Download the QCOW2 disk image and Ignition files to a common directory on the RHEL KVM host.

For example: **`/var/lib/libvirt/images`**

**NOTE**

The Ignition files are generated by the OpenShift Container Platform installer.

3. Create a new disk image with the QCOW2 disk image backing file for each KVM guest node.

```
$ qemu-img create -f qcow2 -F qcow2 -b /var/lib/libvirt/images/{source_rhcos_qemu}
/var/lib/libvirt/images/{vmname}.qcow2 {size}
```

4. Create the new KVM guest nodes using the Ignition file and the new disk image.

```
$ virt-install --noautoconsole \
  --connect qemu:///system \
  --name {vn_name} \
  --memory {memory} \
  --vcpus {vcpus} \
  --disk {disk} \
  --import \
  --network network={network},mac={mac} \
  --disk path={ign_file},format=raw,readonly=on,serial=ignition,startup_policy=optional
```

**16.2.12.2. Full installation on a new QCOW2 disk image**

Complete the following steps to create the machines in a full installation on a new QEMU copy-on-write (QCOW2) disk image.

**Prerequisites**

- At least one LPAR running RHEL 8.4 with KVM, referred to as RHEL KVM host in this procedure.
- The KVM/QEMU hypervisor is installed on the RHEL KVM host.
- A domain name server (DNS) that can perform hostname and reverse lookup for the nodes.
- An HTTP or HTTPS server is set up.

**Procedure**

1. Obtain the RHEL kernel, initramfs, and rootfs files from the [Product Downloads](#) page on the Red Hat Customer Portal or from the [RHCOS image mirror](#) page.

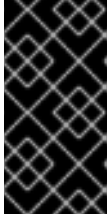
**IMPORTANT**

The RHCOS images might not change with every release of OpenShift Container Platform. You must download images with the highest version that is less than or equal to the OpenShift Container Platform version that you install. Only use the appropriate RHCOS QCOW2 image described in the following procedure.

The file names contain the OpenShift Container Platform version number. They resemble the following examples:

- kernel: **rhcos-<version>-live-kernel-<architecture>**
  - initramfs: **rhcos-<version>-live-initramfs.<architecture>.img**
  - rootfs: **rhcos-<version>-live-rootfs.<architecture>.img**
2. Move the downloaded RHEL live kernel, initramfs, and rootfs as well as the Ignition files to an HTTP or HTTPS server before you launch **virt-install**.

**NOTE**

The Ignition files are generated by the OpenShift Container Platform installer.

3. Create the new KVM guest nodes using the RHEL kernel, initramfs, and Ignition files, the new disk image, and adjusted parm line arguments.
- For **--location**, specify the location of the kernel/initrd on the HTTP or HTTPS server.
  - For **coreos.inst.ignition\_url=**, specify the Ignition file for the machine role. Use **bootstrap.ign**, **master.ign**, or **worker.ign**. Only HTTP and HTTPS protocols are supported.
  - For **coreos.live.rootfs\_url=**, specify the matching rootfs artifact for the kernel and initramfs you are booting. Only HTTP and HTTPS protocols are supported.

```
$ virt-install \
  --connect qemu:///system \
  --name {vn_name} \
  --vcpus {vcpus} \
  --memory {memory_mb} \
  --disk {vn_name}.qcow2,size={image_size| default(10,true)} \
  --network network={virt_network_parm} \
  --boot hd \
  --location {media_location},kernel={rhcos_kernel},initrd={rhcos_initrd} \
  --extra-args "rd.neednet=1 coreos.inst=yes coreos.inst.install_dev=vda
  coreos.live.rootfs_url={rhcos_liveos} ip={ip}::{default_gateway}:{subnet_mask_length}:
  {vn_name}:enc1:none:{MTU} nameserver={dns} coreos.inst.ignition_url={rhcos_ign}" \
  --noautoconsole \
  --wait
```

**16.2.12.3. Advanced RHCOS installation reference**

This section illustrates the networking configuration and other advanced options that allow you to modify the Red Hat Enterprise Linux CoreOS (RHCOS) manual installation process. The following tables describe the kernel arguments and command-line options you can use with the RHCOS live installer and the **coreos-installer** command.

### 16.2.12.3.1. Networking options for ISO installations

If you install RHCOS from an ISO image, you can add kernel arguments manually when you boot the image to configure networking for a node. If no networking arguments are specified, DHCP is activated in the initramfs when RHCOS detects that networking is required to fetch the Ignition config file.

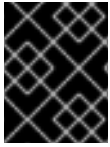

#### IMPORTANT

When adding networking arguments manually, you must also add the **rd.neednet=1** kernel argument to bring the network up in the initramfs.

The following information provides examples for configuring networking on your RHCOS nodes for ISO installations. The examples describe how to use the **ip=** and **nameserver=** kernel arguments.



#### NOTE

Ordering is important when adding the kernel arguments: **ip=** and **nameserver=**.

The networking options are passed to the **dracut** tool during system boot. For more information about the networking options supported by **dracut**, see the **dracut.cmdline** manual page.

The following examples are the networking options for ISO installation.

#### Configuring DHCP or static IP addresses

To configure an IP address, either use DHCP (**ip=dhcp**) or set an individual static IP address (**ip=<host\_ip>**). If setting a static IP, you must then identify the DNS server IP address (**nameserver=<dns\_ip>**) on each node. The following example sets:

- The node's IP address to **10.10.10.2**
- The gateway address to **10.10.10.254**
- The netmask to **255.255.255.0**
- The hostname to **core0.example.com**
- The DNS server address to **4.4.4.41**
- The auto-configuration value to **none**. No auto-configuration is required when IP networking is configured statically.

```
ip=10.10.10.2::10.10.10.254:255.255.255.0:core0.example.com:enp1s0:none
nameserver=4.4.4.41
```



#### NOTE

When you use DHCP to configure IP addressing for the RHCOS machines, the machines also obtain the DNS server information through DHCP. For DHCP-based deployments, you can define the DNS server address that is used by the RHCOS nodes through your DHCP server configuration.

#### Configuring an IP address without a static hostname

You can configure an IP address without assigning a static hostname. If a static hostname is not set by the user, it will be picked up and automatically set by a reverse DNS lookup. To configure an IP address without a static hostname refer to the following example:

- The node's IP address to **10.10.10.2**
- The gateway address to **10.10.10.254**
- The netmask to **255.255.255.0**
- The DNS server address to **4.4.4.41**
- The auto-configuration value to **none**. No auto-configuration is required when IP networking is configured statically.

```
ip=10.10.10.2::10.10.10.254:255.255.255.0::enp1s0:none
nameserver=4.4.4.41
```

### Specifying multiple network interfaces

You can specify multiple network interfaces by setting multiple **ip=** entries.

```
ip=10.10.10.2::10.10.10.254:255.255.255.0:core0.example.com:enp1s0:none
ip=10.10.10.3::10.10.10.254:255.255.255.0:core0.example.com:enp2s0:none
```

### Configuring default gateway and route

Optional: You can configure routes to additional networks by setting an **rd.route=** value.



#### NOTE

When you configure one or multiple networks, one default gateway is required. If the additional network gateway is different from the primary network gateway, the default gateway must be the primary network gateway.

- Run the following command to configure the default gateway:

```
ip=::10.10.10.254:::
```

- Enter the following command to configure the route for the additional network:

```
rd.route=20.20.20.0/24:20.20.20.254:enp2s0
```

### Disabling DHCP on a single interface

You can disable DHCP on a single interface, such as when there are two or more network interfaces and only one interface is being used. In the example, the **enp1s0** interface has a static networking configuration and DHCP is disabled for **enp2s0**, which is not used:

```
ip=10.10.10.2::10.10.10.254:255.255.255.0:core0.example.com:enp1s0:none
ip=::::core0.example.com:enp2s0:none
```

### Combining DHCP and static IP configurations

You can combine DHCP and static IP configurations on systems with multiple network interfaces, for example:

```
ip=enp1s0:dhcp
ip=10.10.10.2::10.10.10.254:255.255.255.0:core0.example.com:enp2s0:none
```

### Configuring VLANs on individual interfaces

Optional: You can configure VLANs on individual interfaces by using the **vlan=** parameter.

- To configure a VLAN on a network interface and use a static IP address, run the following command:

```
ip=10.10.10.2::10.10.10.254:255.255.255.0:core0.example.com:enp2s0.100:none
vlan=enp2s0.100:enp2s0
```

- To configure a VLAN on a network interface and to use DHCP, run the following command:

```
ip=enp2s0.100:dhcp
vlan=enp2s0.100:enp2s0
```

### Providing multiple DNS servers

You can provide multiple DNS servers by adding a **nameserver=** entry for each server, for example:

```
nameserver=1.1.1.1
nameserver=8.8.8.8
```

## 16.2.13. Waiting for the bootstrap process to complete

The OpenShift Container Platform bootstrap process begins after the cluster nodes first boot into the persistent RHCOS environment that has been installed to disk. The configuration information provided through the Ignition config files is used to initialize the bootstrap process and install OpenShift Container Platform on the machines. You must wait for the bootstrap process to complete.

### Prerequisites

- You have created the Ignition config files for your cluster.
- You have configured suitable network, DNS and load balancing infrastructure.
- You have obtained the installation program and generated the Ignition config files for your cluster.
- You installed RHCOS on your cluster machines and provided the Ignition config files that the OpenShift Container Platform installation program generated.
- Your machines have direct internet access or have an HTTP or HTTPS proxy available.

### Procedure

1. Monitor the bootstrap process:

```
$ ./openshift-install --dir <installation_directory> wait-for bootstrap-complete \ 1
--log-level=info 2
```

- 1 For **<installation\_directory>**, specify the path to the directory that you stored the installation files in.

- 2 To view different installation details, specify **warn**, **debug**, or **error** instead of **info**.

### Example output

```
INFO Waiting up to 30m0s for the Kubernetes API at https://api.test.example.com:6443...
INFO API v1.23.0 up
INFO Waiting up to 30m0s for bootstrapping to complete...
INFO It is now safe to remove the bootstrap resources
```

The command succeeds when the Kubernetes API server signals that it has been bootstrapped on the control plane machines.

2. After bootstrap process is complete, remove the bootstrap machine from the load balancer.



### IMPORTANT

You must remove the bootstrap machine from the load balancer at this point. You can also remove or reformat the bootstrap machine itself.

## 16.2.14. Logging in to the cluster by using the CLI

You can log in to your cluster as a default system user by exporting the cluster **kubeconfig** file. The **kubeconfig** file contains information about the cluster that is used by the CLI to connect a client to the correct cluster and API server. The file is specific to a cluster and is created during OpenShift Container Platform installation.

### Prerequisites

- You deployed an OpenShift Container Platform cluster.
- You installed the **oc** CLI.

### Procedure

1. Export the **kubeadmin** credentials:

```
$ export KUBECONFIG=<installation_directory>/auth/kubeconfig 1
```

- 1 For **<installation\_directory>**, specify the path to the directory that you stored the installation files in.

2. Verify you can run **oc** commands successfully using the exported configuration:

```
$ oc whoami
```

### Example output

```
system:admin
```

## 16.2.15. Approving the certificate signing requests for your machines



When you add machines to a cluster, two pending certificate signing requests (CSRs) are generated for each machine that you added. You must confirm that these CSRs are approved or, if necessary, approve them yourself. The client requests must be approved first, followed by the server requests.

## Prerequisites

- You added machines to your cluster.

## Procedure

1. Confirm that the cluster recognizes the machines:

```
$ oc get nodes
```

### Example output

```
NAME      STATUS   ROLES    AGE   VERSION
master-0  Ready   master   63m   v1.23.0
master-1  Ready   master   63m   v1.23.0
master-2  Ready   master   64m   v1.23.0
```

The output lists all of the machines that you created.



### NOTE

The preceding output might not include the compute nodes, also known as worker nodes, until some CSRs are approved.

2. Review the pending CSRs and ensure that you see the client requests with the **Pending** or **Approved** status for each machine that you added to the cluster:

```
$ oc get csr
```

### Example output

```
NAME      AGE   REQUESTOR                                CONDITION
csr-mddf5  20m   system:node:master-01.example.com   Approved,Issued
csr-z5rln  16m   system:node:worker-21.example.com   Approved,Issued
```

3. If the CSRs were not approved, after all of the pending CSRs for the machines you added are in **Pending** status, approve the CSRs for your cluster machines:



### NOTE

Because the CSRs rotate automatically, approve your CSRs within an hour of adding the machines to the cluster. If you do not approve them within an hour, the certificates will rotate, and more than two certificates will be present for each node. You must approve all of these certificates. After the client CSR is approved, the Kubelet creates a secondary CSR for the serving certificate, which requires manual approval. Then, subsequent serving certificate renewal requests are automatically approved by the **machine-approver** if the Kubelet requests a new certificate with identical parameters.

**NOTE**

For clusters running on platforms that are not machine API enabled, such as bare metal and other user-provisioned infrastructure, you must implement a method of automatically approving the kubelet serving certificate requests (CSRs). If a request is not approved, then the **oc exec**, **oc rsh**, and **oc logs** commands cannot succeed, because a serving certificate is required when the API server connects to the kubelet. Any operation that contacts the Kubelet endpoint requires this certificate approval to be in place. The method must watch for new CSRs, confirm that the CSR was submitted by the **node-bootstrap** service account in the **system:node** or **system:admin** groups, and confirm the identity of the node.

- To approve them individually, run the following command for each valid CSR:

```
$ oc adm certificate approve <csr_name> 1
```

- 1** **<csr\_name>** is the name of a CSR from the list of current CSRs.

- To approve all pending CSRs, run the following command:

```
$ oc get csr -o go-template='{{range .items}}{{if not .status}}{{.metadata.name}}{\n"}\n{{end}}' | xargs --no-run-if-empty oc adm certificate approve
```

**NOTE**

Some Operators might not become available until some CSRs are approved.

- Now that your client requests are approved, you must review the server requests for each machine that you added to the cluster:

```
$ oc get csr
```

**Example output**

```
NAME      AGE   REQUESTOR                                     CONDITION
csr-bfd72 5m26s system:node:ip-10-0-50-126.us-east-2.compute.internal
Pending
csr-c57lv 5m26s system:node:ip-10-0-95-157.us-east-2.compute.internal
Pending
...
```

- If the remaining CSRs are not approved, and are in the **Pending** status, approve the CSRs for your cluster machines:

- To approve them individually, run the following command for each valid CSR:

```
$ oc adm certificate approve <csr_name> 1
```

- 1** **<csr\_name>** is the name of a CSR from the list of current CSRs.

- To approve all pending CSRs, run the following command:

```
$ oc get csr -o go-template='{{range .items}}{{if not .status}}{{.metadata.name}}{\n"}\n{{end}}' | xargs oc adm certificate approve
```

6. After all client and server CSRs have been approved, the machines have the **Ready** status. Verify this by running the following command:

```
$ oc get nodes
```

### Example output

```
NAME      STATUS  ROLES  AGE  VERSION
master-0  Ready   master 73m  v1.23.0
master-1  Ready   master 73m  v1.23.0
master-2  Ready   master 74m  v1.23.0
worker-0  Ready   worker 11m  v1.23.0
worker-1  Ready   worker 11m  v1.23.0
```

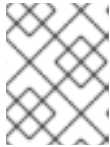

### NOTE

It can take a few minutes after approval of the server CSRs for the machines to transition to the **Ready** status.

### Additional information

- For more information on CSRs, see [Certificate Signing Requests](#).

## 16.2.16. Initial Operator configuration

After the control plane initializes, you must immediately configure some Operators so that they all become available.

### Prerequisites

- Your control plane has initialized.

### Procedure

1. Watch the cluster components come online:

```
$ watch -n5 oc get clusteroperators
```

### Example output

NAME	VERSION	AVAILABLE	PROGRESSING	DEGRADED	SINCE
authentication	4.10.0	True	False	False	19m
baremetal	4.10.0	True	False	False	37m
cloud-credential	4.10.0	True	False	False	40m
cluster-autoscaler	4.10.0	True	False	False	37m
config-operator	4.10.0	True	False	False	38m

console	4.10.0	True	False	False	26m
csi-snapshot-controller	4.10.0	True	False	False	37m
dns	4.10.0	True	False	False	37m
etcd	4.10.0	True	False	False	36m
image-registry	4.10.0	True	False	False	31m
ingress	4.10.0	True	False	False	30m
insights	4.10.0	True	False	False	31m
kube-apiserver	4.10.0	True	False	False	26m
kube-controller-manager	4.10.0	True	False	False	36m
kube-scheduler	4.10.0	True	False	False	36m
kube-storage-version-migrator	4.10.0	True	False	False	37m
machine-api	4.10.0	True	False	False	29m
machine-approver	4.10.0	True	False	False	37m
machine-config	4.10.0	True	False	False	36m
marketplace	4.10.0	True	False	False	37m
monitoring	4.10.0	True	False	False	29m
network	4.10.0	True	False	False	38m
node-tuning	4.10.0	True	False	False	37m
openshift-apiserver	4.10.0	True	False	False	32m
openshift-controller-manager	4.10.0	True	False	False	30m
openshift-samples	4.10.0	True	False	False	32m
operator-lifecycle-manager	4.10.0	True	False	False	37m
operator-lifecycle-manager-catalog	4.10.0	True	False	False	37m
operator-lifecycle-manager-packageserver	4.10.0	True	False	False	32m
service-ca	4.10.0	True	False	False	38m
storage	4.10.0	True	False	False	37m

2. Configure the Operators that are not available.

### 16.2.16.1. Image registry storage configuration

The Image Registry Operator is not initially available for platforms that do not provide default storage. After installation, you must configure your registry to use storage so that the Registry Operator is made available.

Instructions are shown for configuring a persistent volume, which is required for production clusters. Where applicable, instructions are shown for configuring an empty directory as the storage location, which is available for only non-production clusters.

Additional instructions are provided for allowing the image registry to use block storage types by using the **Recreate** rollout strategy during upgrades.

#### 16.2.16.1.1. Configuring registry storage for IBM Z

As a cluster administrator, following installation you must configure your registry to use storage.

#### Prerequisites

- You have access to the cluster as a user with the **cluster-admin** role.
- You have a cluster on IBM Z.
- You have provisioned persistent storage for your cluster, such as Red Hat OpenShift Data Foundation.



## IMPORTANT

OpenShift Container Platform supports **ReadWriteOnce** access for image registry storage when you have only one replica. **ReadWriteOnce** access also requires that the registry uses the **Recreate** rollout strategy. To deploy an image registry that supports high availability with two or more replicas, **ReadWriteMany** access is required.

- Must have 100Gi capacity.

## Procedure

1. To configure your registry to use storage, change the **spec.storage.pvc** in the **configs.imageregistry/cluster** resource.



## NOTE

When using shared storage, review your security settings to prevent outside access.

2. Verify that you do not have a registry pod:

```
$ oc get pod -n openshift-image-registry -l docker-registry=default
```

## Example output

```
No resources found in openshift-image-registry namespace
```



## NOTE

If you do have a registry pod in your output, you do not need to continue with this procedure.

3. Check the registry configuration:

```
$ oc edit configs.imageregistry.operator.openshift.io
```

## Example output

```
storage:
  pvc:
    claim:
```

Leave the **claim** field blank to allow the automatic creation of an **image-registry-storage** PVC.

4. Check the **clusteroperator** status:

```
$ oc get clusteroperator image-registry
```

## Example output

NAME	VERSION	AVAILABLE	PROGRESSING	DEGRADED	SINCE
image-registry	4.10	True	False	False	6h50m

5. Ensure that your registry is set to managed to enable building and pushing of images.

- Run:

```
$ oc edit configs.imageregistry/cluster
```

Then, change the line

```
managementState: Removed
```

to

```
managementState: Managed
```

### 16.2.16.1.2. Configuring storage for the image registry in non-production clusters

You must configure storage for the Image Registry Operator. For non-production clusters, you can set the image registry to an empty directory. If you do so, all images are lost if you restart the registry.

#### Procedure

- To set the image registry storage to an empty directory:

```
$ oc patch configs.imageregistry.operator.openshift.io cluster --type merge --patch '{"spec": {"storage":{"emptyDir":{}}}'
```



#### WARNING

Configure this option for only non-production clusters.

If you run this command before the Image Registry Operator initializes its components, the **oc patch** command fails with the following error:

```
Error from server (NotFound): configs.imageregistry.operator.openshift.io "cluster" not found
```

Wait a few minutes and run the command again.

### 16.2.17. Completing installation on user-provisioned infrastructure

After you complete the Operator configuration, you can finish installing the cluster on infrastructure that you provide.

#### Prerequisites

- Your control plane has initialized.
- You have completed the initial Operator configuration.

## Procedure

1. Confirm that all the cluster components are online with the following command:

```
$ watch -n5 oc get clusteroperators
```

## Example output

NAME	VERSION	AVAILABLE	PROGRESSING	DEGRADED	SINCE
authentication	4.10.0	True	False	False	19m
baremetal	4.10.0	True	False	False	37m
cloud-credential	4.10.0	True	False	False	40m
cluster-autoscaler	4.10.0	True	False	False	37m
config-operator	4.10.0	True	False	False	38m
console	4.10.0	True	False	False	26m
csi-snapshot-controller	4.10.0	True	False	False	37m
dns	4.10.0	True	False	False	37m
etcd	4.10.0	True	False	False	36m
image-registry	4.10.0	True	False	False	31m
ingress	4.10.0	True	False	False	30m
insights	4.10.0	True	False	False	31m
kube-apiserver	4.10.0	True	False	False	26m
kube-controller-manager	4.10.0	True	False	False	36m
kube-scheduler	4.10.0	True	False	False	36m
kube-storage-version-migrator	4.10.0	True	False	False	37m
machine-api	4.10.0	True	False	False	29m
machine-approver	4.10.0	True	False	False	37m
machine-config	4.10.0	True	False	False	36m
marketplace	4.10.0	True	False	False	37m
monitoring	4.10.0	True	False	False	29m
network	4.10.0	True	False	False	38m
node-tuning	4.10.0	True	False	False	37m
openshift-apiserver	4.10.0	True	False	False	32m
openshift-controller-manager	4.10.0	True	False	False	30m
openshift-samples	4.10.0	True	False	False	32m
operator-lifecycle-manager	4.10.0	True	False	False	37m
operator-lifecycle-manager-catalog	4.10.0	True	False	False	37m
operator-lifecycle-manager-packageserver	4.10.0	True	False	False	32m
service-ca	4.10.0	True	False	False	38m
storage	4.10.0	True	False	False	37m

Alternatively, the following command notifies you when all of the clusters are available. It also retrieves and displays credentials:

```
$ ./openshift-install --dir <installation_directory> wait-for install-complete 1
```

- 1** For **<installation\_directory>**, specify the path to the directory that you stored the installation files in.

## Example output

```
INFO Waiting up to 30m0s for the cluster to initialize...
```

The command succeeds when the Cluster Version Operator finishes deploying the OpenShift Container Platform cluster from Kubernetes API server.



### IMPORTANT

- The Ignition config files that the installation program generates contain certificates that expire after 24 hours, which are then renewed at that time. If the cluster is shut down before renewing the certificates and the cluster is later restarted after the 24 hours have elapsed, the cluster automatically recovers the expired certificates. The exception is that you must manually approve the pending **node-bootstrapper** certificate signing requests (CSRs) to recover kubelet certificates. See the documentation for *Recovering from expired control plane certificates* for more information.
- It is recommended that you use Ignition config files within 12 hours after they are generated because the 24-hour certificate rotates from 16 to 22 hours after the cluster is installed. By using the Ignition config files within 12 hours, you can avoid installation failure if the certificate update runs during installation.

2. Confirm that the Kubernetes API server is communicating with the pods.

a. To view a list of all pods, use the following command:

```
$ oc get pods --all-namespaces
```

### Example output

```

NAMESPACE           NAME                                     READY  STATUS
RESTARTS  AGE
openshift-apiserver-operator  openshift-apiserver-operator-85cb746d55-zqhs8  1/1
Running   1    9m
openshift-apiserver          apiserver-67b9g                                1/1  Running  0
3m
openshift-apiserver          apiserver-ljcmx                                1/1  Running  0
1m
openshift-apiserver          apiserver-z25h4                                1/1  Running  0
2m
openshift-authentication-operator  authentication-operator-69d5d8bf84-vh2n8      1/1
Running   0    5m
...
```

b. View the logs for a pod that is listed in the output of the previous command by using the following command:

```
$ oc logs <pod_name> -n <namespace> 1
```

- 1** Specify the pod name and namespace, as shown in the output of the previous command.



If the pod logs display, the Kubernetes API server can communicate with the cluster machines.

- For an installation with Fibre Channel Protocol (FCP), additional steps are required to enable multipathing. Do not enable multipathing during installation.  
See "Enabling multipathing with kernel arguments on RHCOS" in the *Post-installation machine configuration tasks* documentation for more information.

### 16.2.18. Telemetry access for OpenShift Container Platform

In OpenShift Container Platform 4.10, the Telemetry service, which runs by default to provide metrics about cluster health and the success of updates, requires internet access. If your cluster is connected to the internet, Telemetry runs automatically, and your cluster is registered to [OpenShift Cluster Manager](#).

After you confirm that your [OpenShift Cluster Manager](#) inventory is correct, either maintained automatically by Telemetry or manually by using OpenShift Cluster Manager, [use subscription watch](#) to track your OpenShift Container Platform subscriptions at the account or multi-cluster level.

#### Additional resources

- See [About remote health monitoring](#) for more information about the Telemetry service
- [How to generate SOSREPORT within OpenShift4 nodes without SSH](#) .

### 16.2.19. Next steps

- [Customize your cluster](#).
- If necessary, you can [opt out of remote health reporting](#) .

## 16.3. INSTALLING A CLUSTER WITH RHEL KVM ON IBM Z AND LINUXONE IN A RESTRICTED NETWORK

In OpenShift Container Platform version 4.10, you can install a cluster on IBM Z and LinuxONE infrastructure that you provision in a restricted network.



#### NOTE

While this document refers to only IBM Z, all information in it also applies to LinuxONE.



#### IMPORTANT

Additional considerations exist for non-bare metal platforms. Review the information in the [guidelines for deploying OpenShift Container Platform on non-tested platforms](#) before you install an OpenShift Container Platform cluster.

### 16.3.1. Prerequisites

- You reviewed details about the [OpenShift Container Platform installation and update](#) processes.
- You read the documentation on [selecting a cluster installation method and preparing it for users](#).

- You [created a registry on your mirror host](#) and obtained the **imageContentSources** data for your version of OpenShift Container Platform.
- You must move or remove any existing installation files, before you begin the installation process. This ensures that the required installation files are created and updated during the installation process.

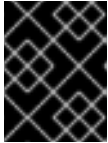

### IMPORTANT

Ensure that installation steps are done from a machine with access to the installation media.

- You provisioned [persistent storage using OpenShift Data Foundation](#) or other supported storage protocols for your cluster. To deploy a private image registry, you must set up persistent storage with **ReadWriteMany** access.
- If you use a firewall, you [configured it to allow the sites](#) that your cluster requires access to.
- You provisioned a RHEL Kernel Virtual Machine (KVM) system that is hosted on the logical partition (LPAR) and based on RHEL 8.4 or later.



### NOTE

Be sure to also review this site list if you are configuring a proxy.

## 16.3.2. About installations in restricted networks

In OpenShift Container Platform 4.10, you can perform an installation that does not require an active connection to the internet to obtain software components. Restricted network installations can be completed using installer-provisioned infrastructure or user-provisioned infrastructure, depending on the cloud platform to which you are installing the cluster.

If you choose to perform a restricted network installation on a cloud platform, you still require access to its cloud APIs. Some cloud functions, like Amazon Web Service's Route 53 DNS and IAM services, require internet access. Depending on your network, you might require less internet access for an installation on bare metal hardware or on VMware vSphere.

To complete a restricted network installation, you must create a registry that mirrors the contents of the OpenShift image registry and contains the installation media. You can create this registry on a mirror host, which can access both the internet and your closed network, or by using other methods that meet your restrictions.

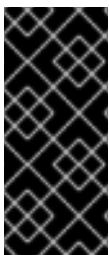

### IMPORTANT

Because of the complexity of the configuration for user-provisioned installations, consider completing a standard user-provisioned infrastructure installation before you attempt a restricted network installation using user-provisioned infrastructure. Completing this test installation might make it easier to isolate and troubleshoot any issues that might arise during your installation in a restricted network.

### 16.3.2.1. Additional limits

Clusters in restricted networks have the following additional limitations and restrictions:

- The **ClusterVersion** status includes an **Unable to retrieve available updates** error.
- By default, you cannot use the contents of the Developer Catalog because you cannot access the required image stream tags.

### 16.3.3. Internet access for OpenShift Container Platform

In OpenShift Container Platform 4.10, you require access to the internet to obtain the images that are necessary to install your cluster.

You must have internet access to:

- Access [OpenShift Cluster Manager](#) to download the installation program and perform subscription management. If the cluster has internet access and you do not disable Telemetry, that service automatically entitles your cluster.
- Access [Quay.io](#) to obtain the packages that are required to install your cluster.
- Obtain the packages that are required to perform cluster updates.



#### IMPORTANT

If your cluster cannot have direct internet access, you can perform a restricted network installation on some types of infrastructure that you provision. During that process, you download the required content and use it to populate a mirror registry with the installation packages. With some installation types, the environment that you install your cluster in will not require internet access. Before you update the cluster, you update the content of the mirror registry.

### 16.3.4. Machine requirements for a cluster with user-provisioned infrastructure

For a cluster that contains user-provisioned infrastructure, you must deploy all of the required machines.

One or more KVM host machines based on RHEL 8.4 or later. Each RHEL KVM host machine must have libvirt installed and running. The virtual machines are provisioned under each RHEL KVM host machine.

#### 16.3.4.1. Required machines

The smallest OpenShift Container Platform clusters require the following hosts:

**Table 16.18. Minimum required hosts**

Hosts	Description
One temporary bootstrap machine	The cluster requires the bootstrap machine to deploy the OpenShift Container Platform cluster on the three control plane machines. You can remove the bootstrap machine after you install the cluster.
Three control plane machines	The control plane machines run the Kubernetes and OpenShift Container Platform services that form the control plane.

Hosts	Description
At least two compute machines, which are also known as worker machines.	The workloads requested by OpenShift Container Platform users run on the compute machines.



### IMPORTANT

To improve high availability of your cluster, distribute the control plane machines over different RHEL instances on at least two physical machines.

The bootstrap, control plane, and compute machines must use Red Hat Enterprise Linux CoreOS (RHCOS) as the operating system.

See [Red Hat Enterprise Linux technology capabilities and limits](#) .

#### 16.3.4.2. Network connectivity requirements

The OpenShift Container Platform installer creates the Ignition files, which are necessary for all the Red Hat Enterprise Linux CoreOS (RHCOS) virtual machines. The automated installation of OpenShift Container Platform is performed by the bootstrap machine. It starts the installation of OpenShift Container Platform on each node, starts the Kubernetes cluster, and then finishes. During this bootstrap, the virtual machine must have an established network connection either through a Dynamic Host Configuration Protocol (DHCP) server or static IP address.

#### 16.3.4.3. IBM Z network connectivity requirements

To install on IBM Z under RHEL KVM, you need:

- A RHEL KVM host configured with an OSA or RoCE network adapter.
- Either a RHEL KVM host that is configured to use bridged networking in libvirt or MacVTap to connect the network to the guests.  
See [Types of virtual network connections](#) .

#### 16.3.4.4. Host machine resource requirements

The RHEL KVM host in your environment must meet the following requirements to host the virtual machines that you plan for the OpenShift Container Platform environment. See [Getting started with virtualization](#).

You can install OpenShift Container Platform version 4.10 on the following IBM hardware:

- IBM z16 (all models), IBM z15 (all models), IBM z14 (all models), IBM z13, and IBM z13s
- LinuxONE, any version

#### 16.3.4.5. Minimum IBM Z system environment

##### Hardware requirements

- The equivalent of six Integrated Facilities for Linux (IFL), which are SMT2 enabled, for each cluster.

- At least one network connection to both connect to the **LoadBalancer** service and to serve data for traffic outside the cluster.



### NOTE

You can use dedicated or shared IFLs to assign sufficient compute resources. Resource sharing is one of the key strengths of IBM Z. However, you must adjust capacity correctly on each hypervisor layer and ensure sufficient resources for every OpenShift Container Platform cluster.



### IMPORTANT

Since the overall performance of the cluster can be impacted, the LPARs that are used to setup the OpenShift Container Platform clusters must provide sufficient compute capacity. In this context, LPAR weight management, entitlements, and CPU shares on the hypervisor level play an important role.

## Operating system requirements

- One LPAR running RHEL 8.4 or later with KVM, which is managed by libvirt

On your RHEL KVM host, set up:

- Three guest virtual machines for OpenShift Container Platform control plane machines
- Two guest virtual machines for OpenShift Container Platform compute machines
- One guest virtual machine for the temporary OpenShift Container Platform bootstrap machine

### 16.3.4.6. Minimum resource requirements

Each cluster virtual machine must meet the following minimum requirements:

Virtual Machine	Operating System	vCPU [1]	Virtual RAM	Storage	IOPS
Bootstrap	RHCOS	4	16 GB	100 GB	N/A
Control plane	RHCOS	4	16 GB	100 GB	N/A
Compute	RHCOS	2	8 GB	100 GB	N/A

1. One physical core (IFL) provides two logical cores (threads) when SMT-2 is enabled. The hypervisor can provide two or more vCPUs.

### 16.3.4.7. Preferred IBM Z system environment

#### Hardware requirements

- Three LPARS that each have the equivalent of six IFLs, which are SMT2 enabled, for each cluster.

- Two network connections to both connect to the **LoadBalancer** service and to serve data for traffic outside the cluster.

### Operating system requirements

- For high availability, two or three LPARs running RHEL 8.4 or later with KVM, which are managed by libvirt.

On your RHEL KVM host, set up:

- Three guest virtual machines for OpenShift Container Platform control plane machines, distributed across the RHEL KVM host machines.
- At least six guest virtual machines for OpenShift Container Platform compute machines, distributed across the RHEL KVM host machines.
- One guest virtual machine for the temporary OpenShift Container Platform bootstrap machine.
- To ensure the availability of integral components in an overcommitted environment, increase the priority of the control plane by using **cpu\_shares**. Do the same for infrastructure nodes, if they exist. See [schedinfo](#) in IBM Documentation.

#### 16.3.4.8. Preferred resource requirements

The preferred requirements for each cluster virtual machine are:

Virtual Machine	Operating System	vCPU	Virtual RAM	Storage
Bootstrap	RHCOS	4	16 GB	120 GB
Control plane	RHCOS	8	16 GB	120 GB
Compute	RHCOS	6	8 GB	120 GB

#### 16.3.4.9. Certificate signing requests management

Because your cluster has limited access to automatic machine management when you use infrastructure that you provision, you must provide a mechanism for approving cluster certificate signing requests (CSRs) after installation. The **kube-controller-manager** only approves the kubelet client CSRs. The **machine-approver** cannot guarantee the validity of a serving certificate that is requested by using kubelet credentials because it cannot confirm that the correct machine issued the request. You must determine and implement a method of verifying the validity of the kubelet serving certificate requests and approving them.

#### Additional resources

- [Recommended host practices for IBM Z & LinuxONE environments](#)

#### 16.3.4.10. Networking requirements for user-provisioned infrastructure

All the Red Hat Enterprise Linux CoreOS (RHCOS) machines require networking to be configured in **initramfs** during boot to fetch their Ignition config files.

During the initial boot, the machines require an IP address configuration that is set either through a

DHCP server or statically by providing the required boot options. After a network connection is established, the machines download their Ignition config files from an HTTP or HTTPS server. The Ignition config files are then used to set the exact state of each machine. The Machine Config Operator completes more changes to the machines, such as the application of new certificates or keys, after installation.

It is recommended to use a DHCP server for long-term management of the cluster machines. Ensure that the DHCP server is configured to provide persistent IP addresses, DNS server information, and hostnames to the cluster machines.

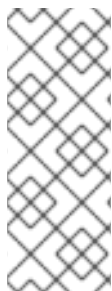

## NOTE

If a DHCP service is not available for your user-provisioned infrastructure, you can instead provide the IP networking configuration and the address of the DNS server to the nodes at RHCOS install time. These can be passed as boot arguments if you are installing from an ISO image. See the *Installing RHCOS and starting the OpenShift Container Platform bootstrap process* section for more information about static IP provisioning and advanced networking options.

The Kubernetes API server must be able to resolve the node names of the cluster machines. If the API servers and worker nodes are in different zones, you can configure a default DNS search zone to allow the API server to resolve the node names. Another supported approach is to always refer to hosts by their fully-qualified domain names in both the node objects and all DNS requests.

### 16.3.4.10.1. Setting the cluster node hostnames through DHCP

On Red Hat Enterprise Linux CoreOS (RHCOS) machines, the hostname is set through NetworkManager. By default, the machines obtain their hostname through DHCP. If the hostname is not provided by DHCP, set statically through kernel arguments, or another method, it is obtained through a reverse DNS lookup. Reverse DNS lookup occurs after the network has been initialized on a node and can take time to resolve. Other system services can start prior to this and detect the hostname as **localhost** or similar. You can avoid this by using DHCP to provide the hostname for each cluster node.

Additionally, setting the hostnames through DHCP can bypass any manual DNS record name configuration errors in environments that have a DNS split-horizon implementation.

### 16.3.4.10.2. Network connectivity requirements

You must configure the network connectivity between machines to allow OpenShift Container Platform cluster components to communicate. Each machine must be able to resolve the hostnames of all other machines in the cluster.

This section provides details about the ports that are required.

**Table 16.19. Ports used for all-machine to all-machine communications**

Protocol	Port	Description
ICMP	N/A	Network reachability tests
TCP	<b>1936</b>	Metrics

Protocol	Port	Description
	<b>9000-9999</b>	Host level services, including the node exporter on ports <b>9100-9101</b> and the Cluster Version Operator on port <b>9099</b> .
	<b>10250-10259</b>	The default ports that Kubernetes reserves
	<b>10256</b>	openshift-sdn
UDP	<b>4789</b>	VXLAN
	<b>6081</b>	Geneve
	<b>9000-9999</b>	Host level services, including the node exporter on ports <b>9100-9101</b> .
	<b>500</b>	IPsec IKE packets
	<b>4500</b>	IPsec NAT-T packets
TCP/UDP	<b>30000-32767</b>	Kubernetes node port
ESP	N/A	IPsec Encapsulating Security Payload (ESP)

Table 16.20. Ports used for all-machine to control plane communications

Protocol	Port	Description
TCP	<b>6443</b>	Kubernetes API

Table 16.21. Ports used for control plane machine to control plane machine communications

Protocol	Port	Description
TCP	<b>2379-2380</b>	etcd server and peer ports

### NTP configuration for user-provisioned infrastructure

OpenShift Container Platform clusters are configured to use a public Network Time Protocol (NTP) server by default. If you want to use a local enterprise NTP server, or if your cluster is being deployed in a disconnected network, you can configure the cluster to use a specific time server. For more information, see the documentation for *Configuring chrony time service*.

If a DHCP server provides NTP server information, the chrony time service on the Red Hat Enterprise Linux CoreOS (RHCOS) machines read the information and can sync the clock with the NTP servers.

### Additional resources



- [Configuring chrony time service](#)

### 16.3.4.11. User-provisioned DNS requirements

In OpenShift Container Platform deployments, DNS name resolution is required for the following components:

- The Kubernetes API
- The OpenShift Container Platform application wildcard
- The bootstrap, control plane, and compute machines

Reverse DNS resolution is also required for the Kubernetes API, the bootstrap machine, the control plane machines, and the compute machines.

DNS A/AAAA or CNAME records are used for name resolution and PTR records are used for reverse name resolution. The reverse records are important because Red Hat Enterprise Linux CoreOS (RHCOS) uses the reverse records to set the hostnames for all the nodes, unless the hostnames are provided by DHCP. Additionally, the reverse records are used to generate the certificate signing requests (CSR) that OpenShift Container Platform needs to operate.

The following DNS records are required for a user-provisioned OpenShift Container Platform cluster and they must be in place before installation. In each record, **<cluster\_name>** is the cluster name and **<base\_domain>** is the base domain that you specify in the **install-config.yaml** file. A complete DNS record takes the form: **<component>.<cluster\_name>.<base\_domain>..**

**Table 16.22. Required DNS records**

Component	Record	Description
Kubernetes API	<b>api.&lt;cluster_name&gt;.&lt;base_domain&gt;.</b>	A DNS A/AAAA or CNAME record, and a DNS PTR record, to identify the API load balancer. These records must be resolvable by both clients external to the cluster and from all the nodes within the cluster.
	<b>api-int.&lt;cluster_name&gt;.&lt;base_domain&gt;.</b>	A DNS A/AAAA or CNAME record, and a DNS PTR record, to internally identify the API load balancer. These records must be resolvable from all the nodes within the cluster.
		 <p><b>IMPORTANT</b></p> <p>The API server must be able to resolve the worker nodes by the hostnames that are recorded in Kubernetes. If the API server cannot resolve the node names, then proxied API calls can fail, and you cannot retrieve logs from pods.</p>

Component	Record	Description
Routes	<b>*.apps.&lt;cluster_name&gt;.&lt;base_domain&gt;.</b>	<p>A wildcard DNS A/AAAA or CNAME record that refers to the application ingress load balancer. The application ingress load balancer targets the machines that run the Ingress Controller pods. The Ingress Controller pods run on the compute machines by default. These records must be resolvable by both clients external to the cluster and from all the nodes within the cluster.</p> <p>For example, <b>console-openshift-console.apps.&lt;cluster_name&gt;.&lt;base_domain&gt;</b> is used as a wildcard route to the OpenShift Container Platform console.</p>
Bootstrap machine	<b>bootstrap.&lt;cluster_name&gt;.&lt;base_domain&gt;.</b>	A DNS A/AAAA or CNAME record, and a DNS PTR record, to identify the bootstrap machine. These records must be resolvable by the nodes within the cluster.
Control plane machines	<b>&lt;master&gt;&lt;n&gt;.&lt;cluster_name&gt;.&lt;base_domain&gt;.</b>	DNS A/AAAA or CNAME records and DNS PTR records to identify each machine for the control plane nodes. These records must be resolvable by the nodes within the cluster.
Compute machines	<b>&lt;worker&gt;&lt;n&gt;.&lt;cluster_name&gt;.&lt;base_domain&gt;.</b>	DNS A/AAAA or CNAME records and DNS PTR records to identify each machine for the worker nodes. These records must be resolvable by the nodes within the cluster.

**NOTE**

In OpenShift Container Platform 4.4 and later, you do not need to specify etcd host and SRV records in your DNS configuration.

**TIP**

You can use the **dig** command to verify name and reverse name resolution. See the section on *Validating DNS resolution for user-provisioned infrastructure* for detailed validation steps.

**16.3.4.11.1. Example DNS configuration for user-provisioned clusters**

This section provides A and PTR record configuration samples that meet the DNS requirements for deploying OpenShift Container Platform on user-provisioned infrastructure. The samples are not meant to provide advice for choosing one DNS solution over another.

In the examples, the cluster name is **ocp4** and the base domain is **example.com**.

**Example DNS A record configuration for a user-provisioned cluster**

The following example is a BIND zone file that shows sample A records for name resolution in a user-provisioned cluster.

**Example 16.4. Sample DNS zone database**

```

$TTL 1W
@ IN SOA ns1.example.com. root (
    2019070700 ; serial
    3H ; refresh (3 hours)
    30M ; retry (30 minutes)
    2W ; expiry (2 weeks)
    1W ) ; minimum (1 week)
IN NS ns1.example.com.
IN MX 10 smtp.example.com.
;
;
ns1.example.com. IN A 192.168.1.5
smtp.example.com. IN A 192.168.1.5
;
helper.example.com. IN A 192.168.1.5
helper.ocp4.example.com. IN A 192.168.1.5
;
api.ocp4.example.com. IN A 192.168.1.5 1
api-int.ocp4.example.com. IN A 192.168.1.5 2
;
*.apps.ocp4.example.com. IN A 192.168.1.5 3
;
bootstrap.ocp4.example.com. IN A 192.168.1.96 4
;
master0.ocp4.example.com. IN A 192.168.1.97 5
master1.ocp4.example.com. IN A 192.168.1.98 6
master2.ocp4.example.com. IN A 192.168.1.99 7
;
worker0.ocp4.example.com. IN A 192.168.1.11 8
worker1.ocp4.example.com. IN A 192.168.1.7 9
;
;EOF

```

- 1 Provides name resolution for the Kubernetes API. The record refers to the IP address of the API load balancer.
- 2 Provides name resolution for the Kubernetes API. The record refers to the IP address of the API load balancer and is used for internal cluster communications.
- 3 Provides name resolution for the wildcard routes. The record refers to the IP address of the application ingress load balancer. The application ingress load balancer targets the machines that run the Ingress Controller pods. The Ingress Controller pods run on the compute machines by default.

**NOTE**

In the example, the same load balancer is used for the Kubernetes API and application ingress traffic. In production scenarios, you can deploy the API and application ingress load balancers separately so that you can scale the load balancer infrastructure for each in isolation.

- 4 Provides name resolution for the bootstrap machine.
- 5 6 7 Provides name resolution for the control plane machines.
- 8 9 Provides name resolution for the compute machines.

### Example DNS PTR record configuration for a user-provisioned cluster

The following example BIND zone file shows sample PTR records for reverse name resolution in a user-provisioned cluster.

#### Example 16.5. Sample DNS zone database for reverse records

```
$TTL 1W
@ IN SOA ns1.example.com. root (
  2019070700 ; serial
  3H ; refresh (3 hours)
  30M ; retry (30 minutes)
  2W ; expiry (2 weeks)
  1W ) ; minimum (1 week)
IN NS ns1.example.com.
;
5.1.168.192.in-addr.arpa. IN PTR api.ocp4.example.com. 1
5.1.168.192.in-addr.arpa. IN PTR api-int.ocp4.example.com. 2
;
96.1.168.192.in-addr.arpa. IN PTR bootstrap.ocp4.example.com. 3
;
97.1.168.192.in-addr.arpa. IN PTR master0.ocp4.example.com. 4
98.1.168.192.in-addr.arpa. IN PTR master1.ocp4.example.com. 5
99.1.168.192.in-addr.arpa. IN PTR master2.ocp4.example.com. 6
;
11.1.168.192.in-addr.arpa. IN PTR worker0.ocp4.example.com. 7
7.1.168.192.in-addr.arpa. IN PTR worker1.ocp4.example.com. 8
;
;EOF
```

- 1 Provides reverse DNS resolution for the Kubernetes API. The PTR record refers to the record name of the API load balancer.
- 2 Provides reverse DNS resolution for the Kubernetes API. The PTR record refers to the record name of the API load balancer and is used for internal cluster communications.
- 3 Provides reverse DNS resolution for the bootstrap machine.
- 4 5 6 Provides reverse DNS resolution for the control plane machines.
- 7 8 Provides reverse DNS resolution for the compute machines.

**NOTE**

A PTR record is not required for the OpenShift Container Platform application wildcard.

**16.3.4.12. Load balancing requirements for user-provisioned infrastructure**

Before you install OpenShift Container Platform, you must provision the API and application ingress load balancing infrastructure. In production scenarios, you can deploy the API and application ingress load balancers separately so that you can scale the load balancer infrastructure for each in isolation.

**NOTE**

If you want to deploy the API and application Ingress load balancers with a Red Hat Enterprise Linux (RHEL) instance, you must purchase the RHEL subscription separately.

The load balancing infrastructure must meet the following requirements:

1. **API load balancer.** Provides a common endpoint for users, both human and machine, to interact with and configure the platform. Configure the following conditions:
  - Layer 4 load balancing only. This can be referred to as Raw TCP, SSL Passthrough, or SSL Bridge mode. If you use SSL Bridge mode, you must enable Server Name Indication (SNI) for the API routes.
  - A stateless load balancing algorithm. The options vary based on the load balancer implementation.

**IMPORTANT**

Do not configure session persistence for an API load balancer. Configuring session persistence for a Kubernetes API server might cause performance issues from excess application traffic for your OpenShift Container Platform cluster and the Kubernetes API that runs inside the cluster.

Configure the following ports on both the front and back of the load balancers:

**Table 16.23. API load balancer**

Port	Back-end machines (pool members)	Internal	External	Description
<b>6443</b>	Bootstrap and control plane. You remove the bootstrap machine from the load balancer after the bootstrap machine initializes the cluster control plane. You must configure the <b>/readyz</b> endpoint for the API server health check probe.	X	X	Kubernetes API server
<b>22623</b>	Bootstrap and control plane. You remove the bootstrap machine from the load balancer after the bootstrap machine initializes the cluster control plane.	X		Machine config server

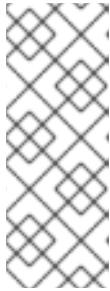
**NOTE**

The load balancer must be configured to take a maximum of 30 seconds from the time the API server turns off the **/readyz** endpoint to the removal of the API server instance from the pool. Within the time frame after **/readyz** returns an error or becomes healthy, the endpoint must have been removed or added. Probing every 5 or 10 seconds, with two successful requests to become healthy and three to become unhealthy, are well-tested values.

2. **Application Ingress load balancer.** Provides an ingress point for application traffic flowing in from outside the cluster. A working configuration for the Ingress router is required for an OpenShift Container Platform cluster.

Configure the following conditions:

- Layer 4 load balancing only. This can be referred to as Raw TCP, SSL Passthrough, or SSL Bridge mode. If you use SSL Bridge mode, you must enable Server Name Indication (SNI) for the ingress routes.
- A connection-based or session-based persistence is recommended, based on the options available and types of applications that will be hosted on the platform.

**TIP**

If the true IP address of the client can be seen by the application Ingress load balancer, enabling source IP-based session persistence can improve performance for applications that use end-to-end TLS encryption.

Configure the following ports on both the front and back of the load balancers:

**Table 16.24. Application Ingress load balancer**

Port	Back-end machines (pool members)	Internal	External	Description
<b>443</b>	The machines that run the Ingress Controller pods, compute, or worker, by default.	X	X	HTTPS traffic
<b>80</b>	The machines that run the Ingress Controller pods, compute, or worker, by default.	X	X	HTTP traffic

**NOTE**

If you are deploying a three-node cluster with zero compute nodes, the Ingress Controller pods run on the control plane nodes. In three-node cluster deployments, you must configure your application Ingress load balancer to route HTTP and HTTPS traffic to the control plane nodes.

#### 16.3.4.12.1. Example load balancer configuration for user-provisioned clusters

This section provides an example API and application ingress load balancer configuration that meets the load balancing requirements for user-provisioned clusters. The sample is an **/etc/haproxy/haproxy.cfg** configuration for an HAProxy load balancer. The example is not meant to provide advice for choosing

one load balancing solution over another.

In the example, the same load balancer is used for the Kubernetes API and application ingress traffic. In production scenarios, you can deploy the API and application ingress load balancers separately so that you can scale the load balancer infrastructure for each in isolation.



## NOTE

If you are using HAProxy as a load balancer and SELinux is set to **enforcing**, you must ensure that the HAProxy service can bind to the configured TCP port by running **setsebool -P haproxy\_connect\_any=1**.

### Example 16.6. Sample API and application Ingress load balancer configuration

```

global
  log      127.0.0.1 local2
  pidfile  /var/run/haproxy.pid
  maxconn  4000
  daemon
defaults
  mode            http
  log             global
  option          dontlognull
  option http-server-close
  option          redispatch
  retries         3
  timeout http-request 10s
  timeout queue    1m
  timeout connect  10s
  timeout client   1m
  timeout server   1m
  timeout http-keep-alive 10s
  timeout check    10s
  maxconn         3000
listen api-server-6443 1
  bind *:6443
  mode tcp
  server bootstrap bootstrap.ocp4.example.com:6443 check inter 1s backup 2
  server master0 master0.ocp4.example.com:6443 check inter 1s
  server master1 master1.ocp4.example.com:6443 check inter 1s
  server master2 master2.ocp4.example.com:6443 check inter 1s
listen machine-config-server-22623 3
  bind *:22623
  mode tcp
  server bootstrap bootstrap.ocp4.example.com:22623 check inter 1s backup 4
  server master0 master0.ocp4.example.com:22623 check inter 1s
  server master1 master1.ocp4.example.com:22623 check inter 1s
  server master2 master2.ocp4.example.com:22623 check inter 1s
listen ingress-router-443 5
  bind *:443
  mode tcp
  balance source
  server worker0 worker0.ocp4.example.com:443 check inter 1s
  server worker1 worker1.ocp4.example.com:443 check inter 1s

```

```
listen ingress-router-80 6
bind *:80
mode tcp
balance source
server worker0 worker0.ocp4.example.com:80 check inter 1s
server worker1 worker1.ocp4.example.com:80 check inter 1s
```

- 1** Port **6443** handles the Kubernetes API traffic and points to the control plane machines.
- 2** **4** The bootstrap entries must be in place before the OpenShift Container Platform cluster installation and they must be removed after the bootstrap process is complete.
- 3** Port **22623** handles the machine config server traffic and points to the control plane machines.
- 5** Port **443** handles the HTTPS traffic and points to the machines that run the Ingress Controller pods. The Ingress Controller pods run on the compute machines by default.
- 6** Port **80** handles the HTTP traffic and points to the machines that run the Ingress Controller pods. The Ingress Controller pods run on the compute machines by default.



#### NOTE

If you are deploying a three-node cluster with zero compute nodes, the Ingress Controller pods run on the control plane nodes. In three-node cluster deployments, you must configure your application Ingress load balancer to route HTTP and HTTPS traffic to the control plane nodes.

#### TIP

If you are using HAProxy as a load balancer, you can check that the **haproxy** process is listening on ports **6443**, **22623**, **443**, and **80** by running **netstat -nltupe** on the HAProxy node.

### 16.3.5. Preparing the user-provisioned infrastructure

Before you install OpenShift Container Platform on user-provisioned infrastructure, you must prepare the underlying infrastructure.

This section provides details about the high-level steps required to set up your cluster infrastructure in preparation for an OpenShift Container Platform installation. This includes configuring IP networking and network connectivity for your cluster nodes, enabling the required ports through your firewall, and setting up the required DNS and load balancing infrastructure.

After preparation, your cluster infrastructure must meet the requirements outlined in the *Requirements for a cluster with user-provisioned infrastructure* section.

#### Prerequisites

- You have reviewed the [OpenShift Container Platform 4.x Tested Integrations](#) page.
- You have reviewed the infrastructure requirements detailed in the *Requirements for a cluster with user-provisioned infrastructure* section.



## Procedure

1. If you are using DHCP to provide the IP networking configuration to your cluster nodes, configure your DHCP service.
  - a. Add persistent IP addresses for the nodes to your DHCP server configuration. In your configuration, match the MAC address of the relevant network interface to the intended IP address for each node.
  - b. When you use DHCP to configure IP addressing for the cluster machines, the machines also obtain the DNS server information through DHCP. Define the persistent DNS server address that is used by the cluster nodes through your DHCP server configuration.



### NOTE

If you are not using a DHCP service, you must provide the IP networking configuration and the address of the DNS server to the nodes at RHCOS install time. These can be passed as boot arguments if you are installing from an ISO image. See the *Installing RHCOS and starting the OpenShift Container Platform bootstrap process* section for more information about static IP provisioning and advanced networking options.

- c. Define the hostnames of your cluster nodes in your DHCP server configuration. See the *Setting the cluster node hostnames through DHCP* section for details about hostname considerations.



### NOTE

If you are not using a DHCP service, the cluster nodes obtain their hostname through a reverse DNS lookup.

2. Choose to perform either a fast track installation of Red Hat Enterprise Linux CoreOS (RHCOS) or a full installation of Red Hat Enterprise Linux CoreOS (RHCOS). For the full installation, you must set up an HTTP or HTTPS server to provide Ignition files and install images to the cluster nodes. For the fast track installation an HTTP or HTTPS server is not required, however, a DHCP server is required. See sections "Fast-track installation: Creating Red Hat Enterprise Linux CoreOS (RHCOS) machines" and "Full installation: Creating Red Hat Enterprise Linux CoreOS (RHCOS) machines".
3. Ensure that your network infrastructure provides the required network connectivity between the cluster components. See the *Networking requirements for user-provisioned infrastructure* section for details about the requirements.
4. Configure your firewall to enable the ports required for the OpenShift Container Platform cluster components to communicate. See *Networking requirements for user-provisioned infrastructure* section for details about the ports that are required.



### IMPORTANT

By default, port **1936** is accessible for an OpenShift Container Platform cluster, because each control plane node needs access to this port.

Avoid using the Ingress load balancer to expose this port, because doing so might result in the exposure of sensitive information, such as statistics and metrics, related to Ingress Controllers.

5. Setup the required DNS infrastructure for your cluster.
  - a. Configure DNS name resolution for the Kubernetes API, the application wildcard, the bootstrap machine, the control plane machines, and the compute machines.
  - b. Configure reverse DNS resolution for the Kubernetes API, the bootstrap machine, the control plane machines, and the compute machines.  
See the *User-provisioned DNS requirements* section for more information about the OpenShift Container Platform DNS requirements.
6. Validate your DNS configuration.
  - a. From your installation node, run DNS lookups against the record names of the Kubernetes API, the wildcard routes, and the cluster nodes. Validate that the IP addresses in the responses correspond to the correct components.
  - b. From your installation node, run reverse DNS lookups against the IP addresses of the load balancer and the cluster nodes. Validate that the record names in the responses correspond to the correct components.  
See the *Validating DNS resolution for user-provisioned infrastructure* section for detailed DNS validation steps.
7. Provision the required API and application ingress load balancing infrastructure. See the *Load balancing requirements for user-provisioned infrastructure* section for more information about the requirements.

**NOTE**

Some load balancing solutions require the DNS name resolution for the cluster nodes to be in place before the load balancing is initialized.

### 16.3.6. Validating DNS resolution for user-provisioned infrastructure

You can validate your DNS configuration before installing OpenShift Container Platform on user-provisioned infrastructure.

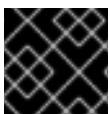
**IMPORTANT**

The validation steps detailed in this section must succeed before you install your cluster.

#### Prerequisites

- You have configured the required DNS records for your user-provisioned infrastructure.

#### Procedure

1. From your installation node, run DNS lookups against the record names of the Kubernetes API, the wildcard routes, and the cluster nodes. Validate that the IP addresses contained in the responses correspond to the correct components.
  - a. Perform a lookup against the Kubernetes API record name. Check that the result points to the IP address of the API load balancer:

```
$ dig +noall +answer @<nameserver_ip> api.<cluster_name>.<base_domain> 1
```

- 1 Replace `<nameserver_ip>` with the IP address of the nameserver, `<cluster_name>` with your cluster name, and `<base_domain>` with your base domain name.

### Example output

```
api.ocp4.example.com. 0 IN A 192.168.1.5
```

- b. Perform a lookup against the Kubernetes internal API record name. Check that the result points to the IP address of the API load balancer:

```
$ dig +noall +answer @<nameserver_ip> api-int.<cluster_name>.<base_domain>
```

### Example output

```
api-int.ocp4.example.com. 0 IN A 192.168.1.5
```

- c. Test an example `*.apps.<cluster_name>.<base_domain>` DNS wildcard lookup. All of the application wildcard lookups must resolve to the IP address of the application ingress load balancer:

```
$ dig +noall +answer @<nameserver_ip> random.apps.<cluster_name>.<base_domain>
```

### Example output

```
random.apps.ocp4.example.com. 0 IN A 192.168.1.5
```



### NOTE

In the example outputs, the same load balancer is used for the Kubernetes API and application ingress traffic. In production scenarios, you can deploy the API and application ingress load balancers separately so that you can scale the load balancer infrastructure for each in isolation.

You can replace **random** with another wildcard value. For example, you can query the route to the OpenShift Container Platform console:

```
$ dig +noall +answer @<nameserver_ip> console-openshift-console.apps.<cluster_name>.<base_domain>
```

### Example output

```
console-openshift-console.apps.ocp4.example.com. 0 IN A 192.168.1.5
```

- d. Run a lookup against the bootstrap DNS record name. Check that the result points to the IP address of the bootstrap node:

```
$ dig +noall +answer @<nameserver_ip> bootstrap.<cluster_name>.<base_domain>
```

### Example output

```
bootstrap.ocp4.example.com. 0 IN A 192.168.1.96
```

- e. Use this method to perform lookups against the DNS record names for the control plane and compute nodes. Check that the results correspond to the IP addresses of each node.
2. From your installation node, run reverse DNS lookups against the IP addresses of the load balancer and the cluster nodes. Validate that the record names contained in the responses correspond to the correct components.
    - a. Perform a reverse lookup against the IP address of the API load balancer. Check that the response includes the record names for the Kubernetes API and the Kubernetes internal API:

```
$ dig +noall +answer @<nameserver_ip> -x 192.168.1.5
```

### Example output

```
5.1.168.192.in-addr.arpa. 0 IN PTR api-int.ocp4.example.com. 1  
5.1.168.192.in-addr.arpa. 0 IN PTR api.ocp4.example.com. 2
```

- 1** Provides the record name for the Kubernetes internal API.
- 2** Provides the record name for the Kubernetes API.



### NOTE

A PTR record is not required for the OpenShift Container Platform application wildcard. No validation step is needed for reverse DNS resolution against the IP address of the application ingress load balancer.

- b. Perform a reverse lookup against the IP address of the bootstrap node. Check that the result points to the DNS record name of the bootstrap node:

```
$ dig +noall +answer @<nameserver_ip> -x 192.168.1.96
```

### Example output

```
96.1.168.192.in-addr.arpa. 0 IN PTR bootstrap.ocp4.example.com.
```

- c. Use this method to perform reverse lookups against the IP addresses for the control plane and compute nodes. Check that the results correspond to the DNS record names of each node.

## 16.3.7. Generating a key pair for cluster node SSH access

During an OpenShift Container Platform installation, you can provide an SSH public key to the installation program. The key is passed to the Red Hat Enterprise Linux CoreOS (RHCOS) nodes through their Ignition config files and is used to authenticate SSH access to the nodes. The key is added to the `~/.ssh/authorized_keys` list for the **core** user on each node, which enables password-less authentication.

After the key is passed to the nodes, you can use the key pair to SSH in to the RHCOS nodes as the user **core**. To access the nodes through SSH, the private key identity must be managed by SSH for your local user.

If you want to SSH in to your cluster nodes to perform installation debugging or disaster recovery, you must provide the SSH public key during the installation process. The **./openshift-install gather** command also requires the SSH public key to be in place on the cluster nodes.



### IMPORTANT

Do not skip this procedure in production environments, where disaster recovery and debugging is required.

### Procedure

1. If you do not have an existing SSH key pair on your local machine to use for authentication onto your cluster nodes, create one. For example, on a computer that uses a Linux operating system, run the following command:

```
$ ssh-keygen -t ed25519 -N "" -f <path>/<file_name> 1
```

- 1 Specify the path and file name, such as `~/.ssh/id_ed25519`, of the new SSH key. If you have an existing key pair, ensure your public key is in the your `~/.ssh` directory.



### NOTE

If you plan to install an OpenShift Container Platform cluster that uses FIPS validated or Modules In Process cryptographic libraries on the **x86\_64** architecture, do not create a key that uses the **ed25519** algorithm. Instead, create a key that uses the **rsa** or **ecdsa** algorithm.

2. View the public SSH key:

```
$ cat <path>/<file_name>.pub
```

For example, run the following to view the `~/.ssh/id_ed25519.pub` public key:

```
$ cat ~/.ssh/id_ed25519.pub
```

3. Add the SSH private key identity to the SSH agent for your local user, if it has not already been added. SSH agent management of the key is required for password-less SSH authentication onto your cluster nodes, or if you want to use the **./openshift-install gather** command.



### NOTE

On some distributions, default SSH private key identities such as `~/.ssh/id_rsa` and `~/.ssh/id_dsa` are managed automatically.

- a. If the **ssh-agent** process is not already running for your local user, start it as a background task:

```
$ eval "$(ssh-agent -s)"
```

-

### Example output

```
Agent pid 31874
```



### NOTE

If your cluster is in FIPS mode, only use FIPS-compliant algorithms to generate the SSH key. The key must be either RSA or ECDSA.

4. Add your SSH private key to the **ssh-agent**:

```
$ ssh-add <path>/<file_name> 1
```

- 1** Specify the path and file name for your SSH private key, such as `~/.ssh/id_ed25519`

### Example output

```
Identity added: /home/<you>/<path>/<file_name> (<computer_name>)
```

### Next steps

- When you install OpenShift Container Platform, provide the SSH public key to the installation program.

## 16.3.8. Manually creating the installation configuration file

For user-provisioned installations of OpenShift Container Platform, you manually generate your installation configuration file.

### Prerequisites

- You have an SSH public key on your local machine to provide to the installation program. The key will be used for SSH authentication onto your cluster nodes for debugging and disaster recovery.
- You have obtained the OpenShift Container Platform installation program and the pull secret for your cluster.

### Procedure

1. Create an installation directory to store your required installation assets in:

```
$ mkdir <installation_directory>
```

**IMPORTANT**

You must create a directory. Some installation assets, like bootstrap X.509 certificates have short expiration intervals, so you must not reuse an installation directory. If you want to reuse individual files from another cluster installation, you can copy them into your directory. However, the file names for the installation assets might change between releases. Use caution when copying installation files from an earlier OpenShift Container Platform version.

2. Customize the sample **install-config.yaml** file template that is provided and save it in the **<installation\_directory>**.

**NOTE**

You must name this configuration file **install-config.yaml**.

**NOTE**

For some platform types, you can alternatively run **./openshift-install create install-config --dir <installation\_directory>** to generate an **install-config.yaml** file. You can provide details about your cluster configuration at the prompts.

3. Back up the **install-config.yaml** file so that you can use it to install multiple clusters.

**IMPORTANT**

The **install-config.yaml** file is consumed during the next step of the installation process. You must back it up now.

**16.3.8.1. Installation configuration parameters**

Before you deploy an OpenShift Container Platform cluster, you provide a customized **install-config.yaml** installation configuration file that describes the details for your environment.

**NOTE**

After installation, you cannot modify these parameters in the **install-config.yaml** file.

**16.3.8.1.1. Required configuration parameters**

Required installation configuration parameters are described in the following table:

**Table 16.25. Required parameters**

Parameter	Description	Values
<b>apiVersion</b>	The API version for the <b>install-config.yaml</b> content. The current version is <b>v1</b> . The installer may also support older API versions.	String

Parameter	Description	Values
<b>baseDomain</b>	The base domain of your cloud provider. The base domain is used to create routes to your OpenShift Container Platform cluster components. The full DNS name for your cluster is a combination of the <b>baseDomain</b> and <b>metadata.name</b> parameter values that uses the <b>&lt;metadata.name&gt;.&lt;baseDomain&gt;</b> format.	A fully-qualified domain or subdomain name, such as <b>example.com</b> .
<b>metadata</b>	Kubernetes resource <b>ObjectMeta</b> , from which only the <b>name</b> parameter is consumed.	Object
<b>metadata.name</b>	The name of the cluster. DNS records for the cluster are all subdomains of <b>{{.metadata.name}}.{{.baseDomain}}</b> .	String of lowercase letters, hyphens (-), and periods (.), such as <b>dev</b> .
<b>platform</b>	The configuration for the specific platform upon which to perform the installation: <b>alibabacloud, aws, baremetal, azure, gcp, ibmcloud, openstack, ovirt, vsphere</b> , or <b>{}</b> . For additional information about <b>platform.&lt;platform&gt;</b> parameters, consult the table for your specific platform that follows.	Object
<b>pullSecret</b>	Get a <a href="#">pull secret from the Red Hat OpenShift Cluster Manager</a> to authenticate downloading container images for OpenShift Container Platform components from services such as Quay.io.	<pre>{   "auths":{     "cloud.openshift.com":{       "auth":"b3Blb=",       "email":"you@example.com"     },     "quay.io":{       "auth":"b3Blb=",       "email":"you@example.com"     }   } }</pre>



### 16.3.8.1.2. Network configuration parameters

You can customize your installation configuration based on the requirements of your existing network infrastructure. For example, you can expand the IP address block for the cluster network or provide different IP address blocks than the defaults.

Only IPv4 addresses are supported.

Table 16.26. Network parameters

Parameter	Description	Values
<b>networking</b>	The configuration for the cluster network.	Object   <b>NOTE</b> You cannot modify parameters specified by the <b>networking</b> object after installation.
<b>networking.network Type</b>	The cluster network provider Container Network Interface (CNI) plugin to install.	Either <b>OpenShiftSDN</b> or <b>OVNKubernetes</b> . <b>OpenShiftSDN</b> is a CNI provider for all-Linux networks. <b>OVNKubernetes</b> is a CNI provider for Linux networks and hybrid networks that contain both Linux and Windows servers. The default value is <b>OpenShiftSDN</b> .
<b>networking.clusterNetwork</b>	The IP address blocks for pods.  The default value is <b>10.128.0.0/14</b> with a host prefix of <b>/23</b> .  If you specify multiple IP address blocks, the blocks must not overlap.	An array of objects. For example:   networking: clusterNetwork: - cidr: <b>10.128.0.0/14</b> hostPrefix: <b>23</b>
<b>networking.clusterNetwork.cidr</b>	Required if you use <b>networking.clusterNetwork</b> . An IP address block.  An IPv4 network.	An IP address block in Classless Inter-Domain Routing (CIDR) notation. The prefix length for an IPv4 block is between <b>0</b> and <b>32</b> .
<b>networking.clusterNetwork.hostPrefix</b>	The subnet prefix length to assign to each individual node. For example, if <b>hostPrefix</b> is set to <b>23</b> then each node is assigned a <b>/23</b> subnet out of the given <b>cidr</b> . A <b>hostPrefix</b> value of <b>23</b> provides 510 ( $2^{(32 - 23)} - 2$ ) pod IP addresses.	A subnet prefix.  The default value is <b>23</b> .

Parameter	Description	Values
<b>networking.serviceNetwork</b>	<p>The IP address block for services. The default value is <b>172.30.0.0/16</b>.</p> <p>The OpenShift SDN and OVN-Kubernetes network providers support only a single IP address block for the service network.</p>	<p>An array with an IP address block in CIDR format. For example:</p> <pre>networking:   serviceNetwork:     - 172.30.0.0/16</pre>
<b>networking.machineNetwork</b>	<p>The IP address blocks for machines.</p> <p>If you specify multiple IP address blocks, the blocks must not overlap.</p> <p>If you specify multiple IP kernel arguments, the <b>machineNetwork.cidr</b> value must be the CIDR of the primary network.</p>	<p>An array of objects. For example:</p> <pre>networking:   machineNetwork:     - cidr: 10.0.0.0/16</pre>
<b>networking.machineNetwork.cidr</b>	<p>Required if you use <b>networking.machineNetwork</b>. An IP address block. The default value is <b>10.0.0.0/16</b> for all platforms other than libvirt. For libvirt, the default value is <b>192.168.126.0/24</b>.</p>	<p>An IP network block in CIDR notation. For example, <b>10.0.0.0/16</b>.</p> <div style="display: flex; align-items: flex-start;">  <div> <p><b>NOTE</b></p> <p>Set the <b>networking.machineNetwork</b> to match the CIDR that the preferred NIC resides in.</p> </div> </div>

### 16.3.8.1.3. Optional configuration parameters

Optional installation configuration parameters are described in the following table:

Table 16.27. Optional parameters



Parameter	Description	Values
<b>additionalTrustBundle</b>	<p>A PEM-encoded X.509 certificate bundle that is added to the nodes' trusted certificate store. This trust bundle may also be used when a proxy has been configured.</p>	String

Parameter	Description	Values
<b>cgroupsV2</b>	Enables <a href="#">Linux control groups version 2</a> (cgroups v2) on specific nodes in your cluster. The OpenShift Container Platform process for enabling cgroups v2 disables all cgroup version 1 controllers and hierarchies. The OpenShift Container Platform cgroups version 2 feature is in Developer Preview and is not supported by Red Hat at this time.	<b>true</b>
<b>compute</b>	The configuration for the machines that comprise the compute nodes.	Array of <b>MachinePool</b> objects.
<b>compute.architecture</b>	Determines the instruction set architecture of the machines in the pool. Currently, heterogeneous clusters are not supported, so all pools must specify the same architecture. Valid values are <b>s390x</b> (the default).	String
<b>compute.hyperthreading</b>	<p>Whether to enable or disable simultaneous multithreading, or <b>hyperthreading</b>, on compute machines. By default, simultaneous multithreading is enabled to increase the performance of your machines' cores.</p> <div style="display: flex; align-items: center;">  <div> <p><b>IMPORTANT</b></p> <p>If you disable simultaneous multithreading, ensure that your capacity planning accounts for the dramatically decreased machine performance.</p> </div> </div>	<b>Enabled</b> or <b>Disabled</b>
<b>compute.name</b>	Required if you use <b>compute</b> . The name of the machine pool.	<b>worker</b>

Parameter	Description	Values
<b>compute.platform</b>	Required if you use <b>compute</b> . Use this parameter to specify the cloud provider to host the worker machines. This parameter value must match the <b>controlPlane.platform</b> parameter value.	<b>alibabacloud, aws, azure, gcp, ibmcloud, openstack, ovirt, vsphere</b> , or <b>{}</b>
<b>compute.replicas</b>	The number of compute machines, which are also known as worker machines, to provision.	A positive integer greater than or equal to <b>2</b> . The default value is <b>3</b> .
<b>controlPlane</b>	The configuration for the machines that comprise the control plane.	Array of <b>MachinePool</b> objects.
<b>controlPlane.architecture</b>	Determines the instruction set architecture of the machines in the pool. Currently, heterogeneous clusters are not supported, so all pools must specify the same architecture. Valid values are <b>s390x</b> (the default).	String
<b>controlPlane.hyperthreading</b>	<p>Whether to enable or disable simultaneous multithreading, or <b>hyperthreading</b>, on control plane machines. By default, simultaneous multithreading is enabled to increase the performance of your machines' cores.</p> <div data-bbox="485 1317 592 1632" data-label="Image"> </div> <p><b>IMPORTANT</b></p> <p>If you disable simultaneous multithreading, ensure that your capacity planning accounts for the dramatically decreased machine performance.</p>	<b>Enabled</b> or <b>Disabled</b>
<b>controlPlane.name</b>	Required if you use <b>controlPlane</b> . The name of the machine pool.	<b>master</b>

Parameter	Description	Values
<b>controlPlane.platform</b>	Required if you use <b>controlPlane</b> . Use this parameter to specify the cloud provider that hosts the control plane machines. This parameter value must match the <b>compute.platform</b> parameter value.	<b>alibabacloud, aws, azure, gcp, ibmcloud, openstack, ovirt, vsphere</b> , or {}
<b>controlPlane.replicas</b>	The number of control plane machines to provision.	The only supported value is <b>3</b> , which is the default value.
<b>credentialsMode</b>	<p>The Cloud Credential Operator (CCO) mode. If no mode is specified, the CCO dynamically tries to determine the capabilities of the provided credentials, with a preference for mint mode on the platforms where multiple modes are supported.</p> <div data-bbox="485 891 595 1245" style="border: 1px solid black; padding: 5px; margin-bottom: 10px;"> <p><b>NOTE</b></p> <p>Not all CCO modes are supported for all cloud providers. For more information on CCO modes, see the <i>Cloud Credential Operator</i> entry in the <i>Cluster Operators reference</i> content.</p> </div> <div data-bbox="485 1290 595 1644" style="border: 1px solid black; padding: 5px;"> <p><b>NOTE</b></p> <p>If your AWS account has service control policies (SCP) enabled, you must configure the <b>credentialsMode</b> parameter to <b>Mint, Passthrough</b> or <b>Manual</b>.</p> </div>	<b>Mint, Passthrough, Manual</b> or an empty string ("").

Parameter	Description	Values
<b>fips</b>	<p>Enable or disable FIPS mode. The default is <b>false</b> (disabled). If FIPS mode is enabled, the Red Hat Enterprise Linux CoreOS (RHCOS) machines that OpenShift Container Platform runs on bypass the default Kubernetes cryptography suite and use the cryptography modules that are provided with RHCOS instead.</p> <div style="display: flex; align-items: flex-start;"> <div style="width: 60px; height: 100px; background: repeating-linear-gradient(45deg, transparent, transparent 2px, black 2px, black 4px); margin-right: 10px;"></div> <div> <p><b>IMPORTANT</b></p> <p>To enable FIPS mode for your cluster, you must run the installation program from a Red Hat Enterprise Linux (RHEL) computer configured to operate in FIPS mode. For more information about configuring FIPS mode on RHEL, see <a href="#">Installing the system in FIPS mode</a>. The use of FIPS validated or Modules In Process cryptographic libraries is only supported on OpenShift Container Platform deployments on the <b>x86_64</b> architecture.</p> </div> </div> <div style="display: flex; align-items: flex-start; margin-top: 10px;"> <div style="width: 60px; height: 60px; background: repeating-linear-gradient(45deg, transparent, transparent 2px, black 2px, black 4px); margin-right: 10px;"></div> <div> <p><b>NOTE</b></p> <p>If you are using Azure File storage, you cannot enable FIPS mode.</p> </div> </div>	<b>false</b> or <b>true</b>
<b>imageContentSources</b>	Sources and repositories for the release-image content.	Array of objects. Includes a <b>source</b> and, optionally, <b>mirrors</b> , as described in the following rows of this table.
<b>imageContentSources.source</b>	Required if you use <b>imageContentSources</b> . Specify the repository that users refer to, for example, in image pull specifications.	String
<b>imageContentSources.mirrors</b>	Specify one or more repositories that may also contain the same images.	Array of strings

Parameter	Description	Values
<b>publish</b>	How to publish or expose the user-facing endpoints of your cluster, such as the Kubernetes API, OpenShift routes.	<p><b>Internal</b> or <b>External</b>. The default value is <b>External</b>.</p> <p>Setting this field to <b>Internal</b> is not supported on non-cloud platforms and IBM Cloud VPC.</p> <div style="display: flex; align-items: flex-start;">  <div> <p><b>IMPORTANT</b></p> <p>If the value of the field is set to <b>Internal</b>, the cluster will become non-functional. For more information, refer to <a href="#">BZ#1953035</a>.</p> </div> </div>
<b>sshKey</b>	<p>The SSH key or keys to authenticate access your cluster machines.</p> <div style="display: flex; align-items: flex-start;">  <div> <p><b>NOTE</b></p> <p>For production OpenShift Container Platform clusters on which you want to perform installation debugging or disaster recovery, specify an SSH key that your <b>ssh-agent</b> process uses.</p> </div> </div>	<p>One or more keys. For example:</p> <pre>sshKey:   &lt;key1&gt;   &lt;key2&gt;   &lt;key3&gt;</pre>

### 16.3.8.2. Sample install-config.yaml file for IBM Z

You can customize the **install-config.yaml** file to specify more details about your OpenShift Container Platform cluster's platform or modify the values of the required parameters.

```
apiVersion: v1
baseDomain: example.com 1
compute: 2
- hyperthreading: Enabled 3
  name: worker
  replicas: 0 4
  architecture : s390x
controlPlane: 5
  hyperthreading: Enabled 6
  name: master
  replicas: 3 7
  architecture : s390x
```





manually deploy the compute machines before you finish installing the cluster.

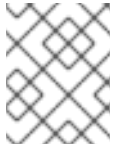

#### NOTE

If you are installing a three-node cluster, do not deploy any compute machines when you install the Red Hat Enterprise Linux CoreOS (RHCOS) machines.

- 7 The number of control plane machines that you add to the cluster. Because the cluster uses these values as the number of etcd endpoints in the cluster, the value must match the number of control plane machines that you deploy.
- 8 The cluster name that you specified in your DNS records.
- 9 A block of IP addresses from which pod IP addresses are allocated. This block must not overlap with existing physical networks. These IP addresses are used for the pod network. If you need to access the pods from an external network, you must configure load balancers and routers to manage the traffic.



#### NOTE

Class E CIDR range is reserved for a future use. To use the Class E CIDR range, you must ensure your networking environment accepts the IP addresses within the Class E CIDR range.

- 10 The subnet prefix length to assign to each individual node. For example, if **hostPrefix** is set to **23**, then each node is assigned a **/23** subnet out of the given **cidr**, which allows for 510 ( $2^{(32 - 23)} - 2$ ) pod IP addresses. If you are required to provide access to nodes from an external network, configure load balancers and routers to manage the traffic.
- 11 The IP address pool to use for service IP addresses. You can enter only one IP address pool. This block must not overlap with existing physical networks. If you need to access the services from an external network, configure load balancers and routers to manage the traffic.
- 12 You must set the platform to **none**. You cannot provide additional platform configuration variables for IBM Z infrastructure.



#### IMPORTANT

Clusters that are installed with the platform type **none** are unable to use some features, such as managing compute machines with the Machine API. This limitation applies even if the compute machines that are attached to the cluster are installed on a platform that would normally support the feature. This parameter cannot be changed after installation.

- 13 Whether to enable or disable FIPS mode. By default, FIPS mode is not enabled. If FIPS mode is enabled, the Red Hat Enterprise Linux CoreOS (RHCOS) machines that OpenShift Container Platform runs on bypass the default Kubernetes cryptography suite and use the cryptography modules that are provided with RHCOS instead.

**IMPORTANT**

To enable FIPS mode for your cluster, you must run the installation program from a Red Hat Enterprise Linux (RHEL) computer configured to operate in FIPS mode. For more information about configuring FIPS mode on RHEL, see [Installing the system in FIPS mode](#). The use of FIPS validated or Modules In Process cryptographic libraries is only supported on OpenShift Container Platform deployments on the **x86\_64** architecture.

- 14 For **<local\_registry>**, specify the registry domain name, and optionally the port, that your mirror registry uses to serve content. For example, **registry.example.com** or **registry.example.com:5000**. For **<credentials>**, specify the base64-encoded user name and password for your mirror registry.
- 15 The SSH public key for the **core** user in Red Hat Enterprise Linux CoreOS (RHCOS).

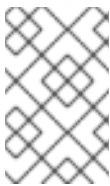
**NOTE**

For production OpenShift Container Platform clusters on which you want to perform installation debugging or disaster recovery, specify an SSH key that your **ssh-agent** process uses.

- 16 Add the **additionalTrustBundle** parameter and value. The value must be the contents of the certificate file that you used for your mirror registry. The certificate file can be an existing, trusted certificate authority or the self-signed certificate that you generated for the mirror registry.
- 17 Provide the **imageContentSources** section from the output of the command to mirror the repository.

**16.3.8.3. Configuring the cluster-wide proxy during installation**

Production environments can deny direct access to the internet and instead have an HTTP or HTTPS proxy available. You can configure a new OpenShift Container Platform cluster to use a proxy by configuring the proxy settings in the **install-config.yaml** file.

**Prerequisites**

- You have an existing **install-config.yaml** file.
- You reviewed the sites that your cluster requires access to and determined whether any of them need to bypass the proxy. By default, all cluster egress traffic is proxied, including calls to hosting cloud provider APIs. You added sites to the **Proxy** object's **spec.noProxy** field to bypass the proxy if necessary.

**NOTE**

The **Proxy** object **status.noProxy** field is populated with the values of the **networking.machineNetwork[].cidr**, **networking.clusterNetwork[].cidr**, and **networking.serviceNetwork[]** fields from your installation configuration.

For installations on Amazon Web Services (AWS), Google Cloud Platform (GCP), Microsoft Azure, and Red Hat OpenStack Platform (RHOSP), the **Proxy** object **status.noProxy** field is also populated with the instance metadata endpoint (**169.254.169.254**).

## Procedure

1. Edit your **install-config.yaml** file and add the proxy settings. For example:

```

apiVersion: v1
baseDomain: my.domain.com
proxy:
  httpProxy: http://<username>:<pswd>@<ip>:<port> 1
  httpsProxy: https://<username>:<pswd>@<ip>:<port> 2
  noProxy: example.com 3
  additionalTrustBundle: | 4
    -----BEGIN CERTIFICATE-----
    <MY_TRUSTED_CA_CERT>
    -----END CERTIFICATE-----
...

```

- 1 A proxy URL to use for creating HTTP connections outside the cluster. The URL scheme must be **http**.
- 2 A proxy URL to use for creating HTTPS connections outside the cluster.
- 3 A comma-separated list of destination domain names, IP addresses, or other network CIDRs to exclude from proxying. Preface a domain with **.** to match subdomains only. For example, **.y.com** matches **x.y.com**, but not **y.com**. Use **\*** to bypass the proxy for all destinations.
- 4 If provided, the installation program generates a config map that is named **user-ca-bundle** in the **openshift-config** namespace that contains one or more additional CA certificates that are required for proxying HTTPS connections. The Cluster Network Operator then creates a **trusted-ca-bundle** config map that merges these contents with the Red Hat Enterprise Linux CoreOS (RHCOS) trust bundle, and this config map is referenced in the **trustedCA** field of the **Proxy** object. The **additionalTrustBundle** field is required unless the proxy's identity certificate is signed by an authority from the RHCOS trust bundle.



### NOTE

The installation program does not support the proxy **readinessEndpoints** field.



### NOTE

If the installer times out, restart and then complete the deployment by using the **wait-for** command of the installer. For example:

```
$ ./openshift-install wait-for install-complete --log-level debug
```

2. Save the file and reference it when installing OpenShift Container Platform.

The installation program creates a cluster-wide proxy that is named **cluster** that uses the proxy settings in the provided **install-config.yaml** file. If no proxy settings are provided, a **cluster Proxy** object is still created, but it will have a nil **spec**.

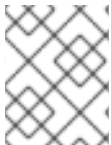
**NOTE**

Only the **Proxy** object named **cluster** is supported, and no additional proxies can be created.

**16.3.8.4. Configuring a three-node cluster**

Optionally, you can deploy zero compute machines in a minimal three node cluster that consists of three control plane machines only. This provides smaller, more resource efficient clusters for cluster administrators and developers to use for testing, development, and production.

In three-node OpenShift Container Platform environments, the three control plane machines are schedulable, which means that your application workloads are scheduled to run on them.

**Prerequisites**

- You have an existing **install-config.yaml** file.

**Procedure**

- Ensure that the number of compute replicas is set to **0** in your **install-config.yaml** file, as shown in the following **compute** stanza:

```
compute:
- name: worker
  platform: {}
  replicas: 0
```

**NOTE**

You must set the value of the **replicas** parameter for the compute machines to **0** when you install OpenShift Container Platform on user-provisioned infrastructure, regardless of the number of compute machines you are deploying. In installer-provisioned installations, the parameter controls the number of compute machines that the cluster creates and manages for you. This does not apply to user-provisioned installations, where the compute machines are deployed manually.

**NOTE**

The preferred resource for control plane nodes is six vCPUs and 21 GB. For three control plane nodes this is the memory + vCPU equivalent of a minimum five-node cluster. You should back the three nodes, each installed on a 120 GB disk, with three IFLs that are SMT2 enabled. The minimum tested setup is three vCPUs and 10 GB on a 120 GB disk for each control plane node.

For three-node cluster installations, follow these next steps:

- If you are deploying a three-node cluster with zero compute nodes, the Ingress Controller pods run on the control plane nodes. In three-node cluster deployments, you must configure your application ingress load balancer to route HTTP and HTTPS traffic to the control plane nodes. See the *Load balancing requirements for user-provisioned infrastructure* section for more information.

- When you create the Kubernetes manifest files in the following procedure, ensure that the **mastersSchedulable** parameter in the `<installation_directory>/manifests/cluster-scheduler-02-config.yml` file is set to **true**. This enables your application workloads to run on the control plane nodes.
- Do not deploy any compute nodes when you create the Red Hat Enterprise Linux CoreOS (RHCOS) machines.

### 16.3.9. Cluster Network Operator configuration

The configuration for the cluster network is specified as part of the Cluster Network Operator (CNO) configuration and stored in a custom resource (CR) object that is named **cluster**. The CR specifies the fields for the **Network** API in the **operator.openshift.io** API group.

The CNO configuration inherits the following fields during cluster installation from the **Network** API in the **Network.config.openshift.io** API group and these fields cannot be changed:

#### **clusterNetwork**

IP address pools from which pod IP addresses are allocated.

#### **serviceNetwork**

IP address pool for services.

#### **defaultNetwork.type**

Cluster network provider, such as OpenShift SDN or OVN-Kubernetes.

You can specify the cluster network provider configuration for your cluster by setting the fields for the **defaultNetwork** object in the CNO object named **cluster**.

#### 16.3.9.1. Cluster Network Operator configuration object

The fields for the Cluster Network Operator (CNO) are described in the following table:

**Table 16.28. Cluster Network Operator configuration object**

Field	Type	Description
<b>metadata.name</b>	<b>string</b>	The name of the CNO object. This name is always <b>cluster</b> .
<b>spec.clusterNetwork</b>	<b>array</b>	<p>A list specifying the blocks of IP addresses from which pod IP addresses are allocated and the subnet prefix length assigned to each individual node in the cluster. For example:</p> <pre>spec:   clusterNetwork:   - cidr: 10.128.0.0/19     hostPrefix: 23   - cidr: 10.128.32.0/19     hostPrefix: 23</pre> <p>You can customize this field only in the <b>install-config.yaml</b> file before you create the manifests. The value is read-only in the manifest file.</p>

Field	Type	Description
<b>spec.serviceNetwork</b>	<b>array</b>	<p>A block of IP addresses for services. The OpenShift SDN and OVN-Kubernetes Container Network Interface (CNI) network providers support only a single IP address block for the service network. For example:</p> <pre>spec:   serviceNetwork:   - 172.30.0.0/14</pre> <p>You can customize this field only in the <b>install-config.yaml</b> file before you create the manifests. The value is read-only in the manifest file.</p>
<b>spec.defaultNetwork</b>	<b>object</b>	Configures the Container Network Interface (CNI) cluster network provider for the cluster network.
<b>spec.kubeProxyConfig</b>	<b>object</b>	The fields for this object specify the kube-proxy configuration. If you are using the OVN-Kubernetes cluster network provider, the kube-proxy configuration has no effect.

#### defaultNetwork object configuration

The values for the **defaultNetwork** object are defined in the following table:

Table 16.29. **defaultNetwork** object

Field	Type	Description
<b>type</b>	<b>string</b>	<p>Either <b>OpenShiftSDN</b> or <b>OVNKubernetes</b>. The cluster network provider is selected during installation. This value cannot be changed after cluster installation.</p> <div style="display: flex; align-items: flex-start;"> <div style="flex: 1;">  </div> <div style="flex: 2;"> <p><b>NOTE</b></p> <p>OpenShift Container Platform uses the OpenShift SDN Container Network Interface (CNI) cluster network provider by default.</p> </div> </div>
<b>openshiftSDNConfig</b>	<b>object</b>	This object is only valid for the OpenShift SDN cluster network provider.
<b>ovnKubernetesConfig</b>	<b>object</b>	This object is only valid for the OVN-Kubernetes cluster network provider.

#### Configuration for the OpenShift SDN CNI cluster network provider

The following table describes the configuration fields for the OpenShift SDN Container Network Interface (CNI) cluster network provider.

**Table 16.30. openshiftSDNConfig object**

Field	Type	Description
<b>mode</b>	<b>string</b>	<p>Configures the network isolation mode for OpenShift SDN. The default value is <b>NetworkPolicy</b>.</p> <p>The values <b>Multitenant</b> and <b>Subnet</b> are available for backwards compatibility with OpenShift Container Platform 3.x but are not recommended. This value cannot be changed after cluster installation.</p>
<b>mtu</b>	<b>integer</b>	<p>The maximum transmission unit (MTU) for the VXLAN overlay network. This is detected automatically based on the MTU of the primary network interface. You do not normally need to override the detected MTU.</p> <p>If the auto-detected value is not what you expect it to be, confirm that the MTU on the primary network interface on your nodes is correct. You cannot use this option to change the MTU value of the primary network interface on the nodes.</p> <p>If your cluster requires different MTU values for different nodes, you must set this value to <b>50</b> less than the lowest MTU value in your cluster. For example, if some nodes in your cluster have an MTU of <b>9001</b>, and some have an MTU of <b>1500</b>, you must set this value to <b>1450</b>.</p> <p>This value cannot be changed after cluster installation.</p>
<b>vxlanPort</b>	<b>integer</b>	<p>The port to use for all VXLAN packets. The default value is <b>4789</b>. This value cannot be changed after cluster installation.</p> <p>If you are running in a virtualized environment with existing nodes that are part of another VXLAN network, then you might be required to change this. For example, when running an OpenShift SDN overlay on top of VMware NSX-T, you must select an alternate port for the VXLAN, because both SDNs use the same default VXLAN port number.</p> <p>On Amazon Web Services (AWS), you can select an alternate port for the VXLAN between port <b>9000</b> and port <b>9999</b>.</p>

### Example OpenShift SDN configuration

```
defaultNetwork:
  type: OpenShiftSDN
  openshiftSDNConfig:
    mode: NetworkPolicy
    mtu: 1450
    vxlanPort: 4789
```

### Configuration for the OVN-Kubernetes CNI cluster network provider

The following table describes the configuration fields for the OVN-Kubernetes CNI cluster network provider.

Table 16.31. `ovnKubernetesConfig` object

Field	Type	Description
<code>mtu</code>	<code>integer</code>	<p>The maximum transmission unit (MTU) for the Geneve (Generic Network Virtualization Encapsulation) overlay network. This is detected automatically based on the MTU of the primary network interface. You do not normally need to override the detected MTU.</p> <p>If the auto-detected value is not what you expect it to be, confirm that the MTU on the primary network interface on your nodes is correct. You cannot use this option to change the MTU value of the primary network interface on the nodes.</p> <p>If your cluster requires different MTU values for different nodes, you must set this value to <b>100</b> less than the lowest MTU value in your cluster. For example, if some nodes in your cluster have an MTU of <b>9001</b>, and some have an MTU of <b>1500</b>, you must set this value to <b>1400</b>.</p>
<code>genevePort</code>	<code>integer</code>	The port to use for all Geneve packets. The default value is <b>6081</b> . This value cannot be changed after cluster installation.
<code>ipsecConfig</code>	<code>object</code>	Specify an empty object to enable IPsec encryption. This value cannot be changed after cluster installation.
<code>policyAuditConfig</code>	<code>object</code>	Specify a configuration object for customizing network policy audit logging. If unset, the defaults audit log settings are used.
<code>gatewayConfig</code>	<code>object</code>	<p>Optional: Specify a configuration object for customizing how egress traffic is sent to the node gateway.</p> <div style="display: flex; align-items: flex-start;"> <div style="flex: 1;">  </div> <div style="flex: 2;"> <p><b>NOTE</b></p> <p>While migrating egress traffic, you can expect some disruption to workloads and service traffic until the Cluster Network Operator (CNO) successfully rolls out the changes.</p> </div> </div>

Table 16.32. `policyAuditConfig` object

Field	Type	Description
-------	------	-------------



Field	Type	Description
<b>rateLimit</b>	integer	The maximum number of messages to generate every second per node. The default value is <b>20</b> messages per second.
<b>maxFileSize</b>	integer	The maximum size for the audit log in bytes. The default value is <b>50000000</b> or 50 MB.
<b>destination</b>	string	One of the following additional audit log targets:  <b>libc</b> The libc <b>syslog()</b> function of the journald process on the host.  <b>udp:&lt;host&gt;:&lt;port&gt;</b> A syslog server. Replace <b>&lt;host&gt;:&lt;port&gt;</b> with the host and port of the syslog server.  <b>unix:&lt;file&gt;</b> A Unix Domain Socket file specified by <b>&lt;file&gt;</b> .  <b>null</b> Do not send the audit logs to any additional target.
<b>syslogFacility</b>	string	The syslog facility, such as <b>kern</b> , as defined by RFC5424. The default value is <b>local0</b> .

Table 16.33. gatewayConfig object

Field	Type	Description
<b>routingViaHost</b>	<b>boolean</b>	Set this field to <b>true</b> to send egress traffic from pods to the host networking stack. For highly-specialized installations and applications that rely on manually configured routes in the kernel routing table, you might want to route egress traffic to the host networking stack. By default, egress traffic is processed in OVN to exit the cluster and is not affected by specialized routes in the kernel routing table. The default value is <b>false</b> .  This field has an interaction with the Open vSwitch hardware offloading feature. If you set this field to <b>true</b> , you do not receive the performance benefits of the offloading because egress traffic is processed by the host networking stack.

### Example OVN-Kubernetes configuration with IPsec enabled

```
defaultNetwork:
  type: OVNKubernetes
  ovnKubernetesConfig:
    mtu: 1400
    genevePort: 6081
    ipsecConfig: {}
```

**kubeProxyConfig object configuration**

The values for the **kubeProxyConfig** object are defined in the following table:

**Table 16.34. kubeProxyConfig object**

Field	Type	Description
<b>iptablesSyncPeriod</b>	<b>string</b>	<p>The refresh period for <b>iptables</b> rules. The default value is <b>30s</b>. Valid suffixes include <b>s</b>, <b>m</b>, and <b>h</b> and are described in the <a href="#">Go time package</a> documentation.</p> <div style="display: flex; align-items: flex-start;"> <div style="border: 1px solid #ccc; padding: 5px; margin-right: 10px;">  </div> <div> <p><b>NOTE</b></p> <p>Because of performance improvements introduced in OpenShift Container Platform 4.3 and greater, adjusting the <b>iptablesSyncPeriod</b> parameter is no longer necessary.</p> </div> </div>
<b>proxyArguments.iptables-min-sync-period</b>	<b>array</b>	<p>The minimum duration before refreshing <b>iptables</b> rules. This field ensures that the refresh does not happen too frequently. Valid suffixes include <b>s</b>, <b>m</b>, and <b>h</b> and are described in the <a href="#">Go time package</a>. The default value is:</p> <pre>kubeProxyConfig:   proxyArguments:     iptables-min-sync-period:       - 0s</pre>

**16.3.10. Creating the Kubernetes manifest and Ignition config files**

Because you must modify some cluster definition files and manually start the cluster machines, you must generate the Kubernetes manifest and Ignition config files that the cluster needs to configure the machines.

The installation configuration file transforms into the Kubernetes manifests. The manifests wrap into the Ignition configuration files, which are later used to configure the cluster machines.

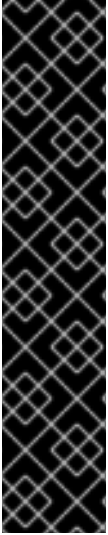

## IMPORTANT

- The Ignition config files that the OpenShift Container Platform installation program generates contain certificates that expire after 24 hours, which are then renewed at that time. If the cluster is shut down before renewing the certificates and the cluster is later restarted after the 24 hours have elapsed, the cluster automatically recovers the expired certificates. The exception is that you must manually approve the pending **node-bootstrapper** certificate signing requests (CSRs) to recover kubelet certificates. See the documentation for *Recovering from expired control plane certificates* for more information.
- It is recommended that you use Ignition config files within 12 hours after they are generated because the 24-hour certificate rotates from 16 to 22 hours after the cluster is installed. By using the Ignition config files within 12 hours, you can avoid installation failure if the certificate update runs during installation.



## NOTE

The installation program that generates the manifest and Ignition files is architecture specific and can be obtained from the [client image mirror](#). The Linux version of the installation program runs on s390x only. This installer program is also available as a Mac OS version.

## Prerequisites

- You obtained the OpenShift Container Platform installation program. For a restricted network installation, these files are on your mirror host.
- You created the **install-config.yaml** installation configuration file.

## Procedure

1. Change to the directory that contains the OpenShift Container Platform installation program and generate the Kubernetes manifests for the cluster:

```
$ ./openshift-install create manifests --dir <installation_directory> 1
```

- 1** For **<installation\_directory>**, specify the installation directory that contains the **install-config.yaml** file you created.



## WARNING

If you are installing a three-node cluster, skip the following step to allow the control plane nodes to be schedulable.

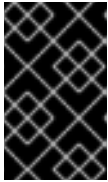

## IMPORTANT

When you configure control plane nodes from the default unschedulable to schedulable, additional subscriptions are required. This is because control plane nodes then become worker nodes.

2. Check that the **mastersSchedulable** parameter in the **<installation\_directory>/manifests/cluster-scheduler-02-config.yml** Kubernetes manifest file is set to **false**. This setting prevents pods from being scheduled on the control plane machines:
  - a. Open the **<installation\_directory>/manifests/cluster-scheduler-02-config.yml** file.
  - b. Locate the **mastersSchedulable** parameter and ensure that it is set to **false**.
  - c. Save and exit the file.
3. To create the Ignition configuration files, run the following command from the directory that contains the installation program:

```
$ ./openshift-install create ignition-configs --dir <installation_directory> 1
```

**1** For **<installation\_directory>**, specify the same installation directory.

Ignition config files are created for the bootstrap, control plane, and compute nodes in the installation directory. The **kubeadmin-password** and **kubeconfig** files are created in the **./<installation\_directory>/auth** directory:

```
.
├── auth
│   ├── kubeadmin-password
│   └── kubeconfig
├── bootstrap.ign
├── master.ign
├── metadata.json
└── worker.ign
```

### 16.3.11. Installing RHCOS and starting the OpenShift Container Platform bootstrap process

To install OpenShift Container Platform on IBM Z infrastructure that you provision, you must install Red Hat Enterprise Linux CoreOS (RHCOS) as Red Hat Enterprise Linux (RHEL) guest virtual machines. When you install RHCOS, you must provide the Ignition config file that was generated by the OpenShift Container Platform installation program for the type of machine you are installing. If you have configured suitable networking, DNS, and load balancing infrastructure, the OpenShift Container Platform bootstrap process begins automatically after the RHCOS machines have rebooted.

You can perform a fast-track installation of RHCOS that uses a prepackaged QEMU copy-on-write (QCOW2) disk image. Alternatively, you can perform a full installation on a new QCOW2 disk image.

#### 16.3.11.1. Fast-track installation by using a prepackaged QCOW2 disk image

Complete the following steps to create the machines in a fast-track installation of Red Hat Enterprise Linux CoreOS (RHCOS), importing a prepackaged Red Hat Enterprise Linux CoreOS (RHCOS) QEMU copy-on-write (QCOW2) disk image.

### Prerequisites

- At least one LPAR running RHEL 8.4 with KVM, referred to as RHEL KVM host in this procedure.
- The KVM/QEMU hypervisor is installed on the RHEL KVM host.
- A domain name server (DNS) that can perform hostname and reverse lookup for the nodes.
- A DHCP server that provides IP addresses.

### Procedure

1. Obtain the RHEL QEMU copy-on-write (QCOW2) disk image file from the [Product Downloads](#) page on the Red Hat Customer Portal or from the [RHCOS image mirror](#) page.

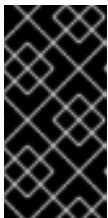

#### IMPORTANT

The RHCOS images might not change with every release of OpenShift Container Platform. You must download images with the highest version that is less than or equal to the OpenShift Container Platform version that you install. Only use the appropriate RHCOS QCOW2 image described in the following procedure.

2. Download the QCOW2 disk image and Ignition files to a common directory on the RHEL KVM host.

For example: `/var/lib/libvirt/images`



#### NOTE

The Ignition files are generated by the OpenShift Container Platform installer.

3. Create a new disk image with the QCOW2 disk image backing file for each KVM guest node.

```
$ qemu-img create -f qcow2 -F qcow2 -b /var/lib/libvirt/images/{source_rhcos_qemu}
/var/lib/libvirt/images/{vmname}.qcow2 {size}
```

4. Create the new KVM guest nodes using the Ignition file and the new disk image.

```
$ virt-install --noautoconsole \
  --connect qemu:///system \
  --name {vn_name} \
  --memory {memory} \
  --vcpus {vcpus} \
  --disk {disk} \
  --import \
  --network network={network},mac={mac} \
  --disk path={ign_file},format=raw,readonly=on,serial=ignition,startup_policy=optional
```

#### 16.3.11.2. Full installation on a new QCOW2 disk image

Complete the following steps to create the machines in a full installation on a new QEMU copy-on-write (QCOW2) disk image.

## Prerequisites

- At least one LPAR running RHEL 8.4 with KVM, referred to as RHEL KVM host in this procedure.
- The KVM/QEMU hypervisor is installed on the RHEL KVM host.
- A domain name server (DNS) that can perform hostname and reverse lookup for the nodes.
- An HTTP or HTTPS server is set up.

## Procedure

1. Obtain the RHEL kernel, initramfs, and rootfs files from the [Product Downloads](#) page on the Red Hat Customer Portal or from the [RHCOS image mirror](#) page.

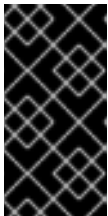

### IMPORTANT

The RHCOS images might not change with every release of OpenShift Container Platform. You must download images with the highest version that is less than or equal to the OpenShift Container Platform version that you install. Only use the appropriate RHCOS QCOW2 image described in the following procedure.

The file names contain the OpenShift Container Platform version number. They resemble the following examples:

- kernel: **rhcos-`<version>`-live-kernel-`<architecture>`**
  - initramfs: **rhcos-`<version>`-live-initramfs.`<architecture>`.img**
  - rootfs: **rhcos-`<version>`-live-rootfs.`<architecture>`.img**
2. Move the downloaded RHEL live kernel, initramfs, and rootfs as well as the Ignition files to an HTTP or HTTPS server before you launch **virt-install**.



### NOTE

The Ignition files are generated by the OpenShift Container Platform installer.

3. Create the new KVM guest nodes using the RHEL kernel, initramfs, and ignition files, the new disk image, and adjusted parm line arguments.
  - For **--location**, specify the location of the kernel/initrd on the HTTP or HTTPS server.
  - For **coreos.inst.ignition\_url=**, specify the Ignition file for the machine role. Use **bootstrap.ign**, **master.ign**, or **worker.ign**. Only HTTP and HTTPS protocols are supported.
  - For **coreos.live.rootfs\_url=**, specify the matching rootfs artifact for the kernel and initramfs you are booting. Only HTTP and HTTPS protocols are supported.

```
$ virt-install \
  --connect qemu:///system \
  --name {vn_name} \
```

```

--vcpus {vcpus} \
--memory {memory_mb} \
--disk {vn_name}.qcow2,size={image_size| default(10,true)} \
--network network={virt_network_parm} \
--boot hd \
--location {media_location},kernel={rhcos_kernel},initrd={rhcos_initrd} \
--extra-args "rd.neednet=1 coreos.inst=yes coreos.inst.install_dev=vda
coreos.live.rootfs_url={rhcos_liveos} ip={ip}::{default_gateway}:{subnet_mask_length}:
{vn_name}:enc1:none:{MTU} nameserver={dns} coreos.inst.ignition_url={rhcos_ign}" \
--noautoconsole \
--wait

```

### 16.3.11.3. Advanced RHCOS installation reference

This section illustrates the networking configuration and other advanced options that allow you to modify the Red Hat Enterprise Linux CoreOS (RHCOS) manual installation process. The following tables describe the kernel arguments and command-line options you can use with the RHCOS live installer and the **coreos-installer** command.

#### 16.3.11.3.1. Networking options for ISO installations

If you install RHCOS from an ISO image, you can add kernel arguments manually when you boot the image to configure networking for a node. If no networking arguments are specified, DHCP is activated in the initramfs when RHCOS detects that networking is required to fetch the Ignition config file.

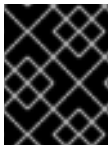

#### IMPORTANT

When adding networking arguments manually, you must also add the **rd.neednet=1** kernel argument to bring the network up in the initramfs.

The following information provides examples for configuring networking on your RHCOS nodes for ISO installations. The examples describe how to use the **ip=** and **nameserver=** kernel arguments.



#### NOTE

Ordering is important when adding the kernel arguments: **ip=** and **nameserver=**.

The networking options are passed to the **dracut** tool during system boot. For more information about the networking options supported by **dracut**, see the **dracut.cmdline** manual page.

The following examples are the networking options for ISO installation.

#### Configuring DHCP or static IP addresses

To configure an IP address, either use DHCP (**ip=dhcp**) or set an individual static IP address (**ip=<host\_ip>**). If setting a static IP, you must then identify the DNS server IP address (**nameserver=<dns\_ip>**) on each node. The following example sets:

- The node's IP address to **10.10.10.2**
- The gateway address to **10.10.10.254**
- The netmask to **255.255.255.0**
- The hostname to **core0.example.com**

- The DNS server address to **4.4.4.41**
- The auto-configuration value to **none**. No auto-configuration is required when IP networking is configured statically.

```
ip=10.10.10.2::10.10.10.254:255.255.255.0:core0.example.com:enp1s0:none
nameserver=4.4.4.41
```



#### NOTE

When you use DHCP to configure IP addressing for the RHCOS machines, the machines also obtain the DNS server information through DHCP. For DHCP-based deployments, you can define the DNS server address that is used by the RHCOS nodes through your DHCP server configuration.

#### Configuring an IP address without a static hostname

You can configure an IP address without assigning a static hostname. If a static hostname is not set by the user, it will be picked up and automatically set by a reverse DNS lookup. To configure an IP address without a static hostname refer to the following example:

- The node's IP address to **10.10.10.2**
- The gateway address to **10.10.10.254**
- The netmask to **255.255.255.0**
- The DNS server address to **4.4.4.41**
- The auto-configuration value to **none**. No auto-configuration is required when IP networking is configured statically.

```
ip=10.10.10.2::10.10.10.254:255.255.255.0::enp1s0:none
nameserver=4.4.4.41
```

#### Specifying multiple network interfaces

You can specify multiple network interfaces by setting multiple **ip=** entries.

```
ip=10.10.10.2::10.10.10.254:255.255.255.0:core0.example.com:enp1s0:none
ip=10.10.10.3::10.10.10.254:255.255.255.0:core0.example.com:enp2s0:none
```

#### Configuring default gateway and route

Optional: You can configure routes to additional networks by setting an **rd.route=** value.

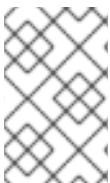

#### NOTE

When you configure one or multiple networks, one default gateway is required. If the additional network gateway is different from the primary network gateway, the default gateway must be the primary network gateway.

- Run the following command to configure the default gateway:

```
ip=::10.10.10.254:::
```



- Enter the following command to configure the route for the additional network:

```
rd.route=20.20.20.0/24:20.20.20.254:enp2s0
```

### Disabling DHCP on a single interface

You can disable DHCP on a single interface, such as when there are two or more network interfaces and only one interface is being used. In the example, the **enp1s0** interface has a static networking configuration and DHCP is disabled for **enp2s0**, which is not used:

```
ip=10.10.10.2::10.10.10.254:255.255.255.0:core0.example.com:enp1s0:none
ip=::::core0.example.com:enp2s0:none
```

### Combining DHCP and static IP configurations

You can combine DHCP and static IP configurations on systems with multiple network interfaces, for example:

```
ip=enp1s0:dhcp
ip=10.10.10.2::10.10.10.254:255.255.255.0:core0.example.com:enp2s0:none
```

### Configuring VLANs on individual interfaces

Optional: You can configure VLANs on individual interfaces by using the **vlan=** parameter.

- To configure a VLAN on a network interface and use a static IP address, run the following command:

```
ip=10.10.10.2::10.10.10.254:255.255.255.0:core0.example.com:enp2s0.100:none
vlan=enp2s0.100:enp2s0
```

- To configure a VLAN on a network interface and to use DHCP, run the following command:

```
ip=enp2s0.100:dhcp
vlan=enp2s0.100:enp2s0
```

### Providing multiple DNS servers

You can provide multiple DNS servers by adding a **nameserver=** entry for each server, for example:

```
nameserver=1.1.1.1
nameserver=8.8.8.8
```

## 16.3.12. Waiting for the bootstrap process to complete

The OpenShift Container Platform bootstrap process begins after the cluster nodes first boot into the persistent RHCOS environment that has been installed to disk. The configuration information provided through the Ignition config files is used to initialize the bootstrap process and install OpenShift Container Platform on the machines. You must wait for the bootstrap process to complete.

### Prerequisites

- You have created the Ignition config files for your cluster.
- You have configured suitable network, DNS and load balancing infrastructure.

- You have obtained the installation program and generated the Ignition config files for your cluster.
- You installed RHCOS on your cluster machines and provided the Ignition config files that the OpenShift Container Platform installation program generated.

## Procedure

1. Monitor the bootstrap process:

```
$ ./openshift-install --dir <installation_directory> wait-for bootstrap-complete \ 1  
--log-level=info 2
```

- 1 For **<installation\_directory>**, specify the path to the directory that you stored the installation files in.

- 2 To view different installation details, specify **warn**, **debug**, or **error** instead of **info**.

## Example output

```
INFO Waiting up to 30m0s for the Kubernetes API at https://api.test.example.com:6443...  
INFO API v1.23.0 up  
INFO Waiting up to 30m0s for bootstrapping to complete...  
INFO It is now safe to remove the bootstrap resources
```

The command succeeds when the Kubernetes API server signals that it has been bootstrapped on the control plane machines.

2. After bootstrap process is complete, remove the bootstrap machine from the load balancer.

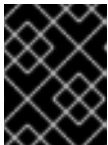

### IMPORTANT

You must remove the bootstrap machine from the load balancer at this point. You can also remove or reformat the bootstrap machine itself.

## 16.3.13. Logging in to the cluster by using the CLI

You can log in to your cluster as a default system user by exporting the cluster **kubeconfig** file. The **kubeconfig** file contains information about the cluster that is used by the CLI to connect a client to the correct cluster and API server. The file is specific to a cluster and is created during OpenShift Container Platform installation.

### Prerequisites

- You deployed an OpenShift Container Platform cluster.
- You installed the **oc** CLI.

## Procedure

1. Export the **kubeadmin** credentials:

```
$ export KUBECONFIG=<installation_directory>/auth/kubeconfig 1
```

- 1 For `<installation_directory>`, specify the path to the directory that you stored the installation files in.

2. Verify you can run `oc` commands successfully using the exported configuration:

```
$ oc whoami
```

#### Example output

```
system:admin
```

### 16.3.14. Approving the certificate signing requests for your machines

When you add machines to a cluster, two pending certificate signing requests (CSRs) are generated for each machine that you added. You must confirm that these CSRs are approved or, if necessary, approve them yourself. The client requests must be approved first, followed by the server requests.

#### Prerequisites

- You added machines to your cluster.

#### Procedure

1. Confirm that the cluster recognizes the machines:

```
$ oc get nodes
```

#### Example output

```
NAME      STATUS  ROLES  AGE  VERSION
master-0  Ready   master 63m  v1.23.0
master-1  Ready   master 63m  v1.23.0
master-2  Ready   master 64m  v1.23.0
```

The output lists all of the machines that you created.



#### NOTE

The preceding output might not include the compute nodes, also known as worker nodes, until some CSRs are approved.

2. Review the pending CSRs and ensure that you see the client requests with the **Pending** or **Approved** status for each machine that you added to the cluster:

```
$ oc get csr
```

#### Example output

```
NAME      AGE  REQUESTOR                                     CONDITION
csr-8b2br 15m  system:serviceaccount:openshift-machine-config-operator:node-
bootstrapper Pending
```

```
csr-8vnps 15m system:serviceaccount:openshift-machine-config-operator:node-
bootstrapper Pending
...
```

In this example, two machines are joining the cluster. You might see more approved CSRs in the list.

- If the CSRs were not approved, after all of the pending CSRs for the machines you added are in **Pending** status, approve the CSRs for your cluster machines:



#### NOTE

Because the CSRs rotate automatically, approve your CSRs within an hour of adding the machines to the cluster. If you do not approve them within an hour, the certificates will rotate, and more than two certificates will be present for each node. You must approve all of these certificates. After the client CSR is approved, the Kubelet creates a secondary CSR for the serving certificate, which requires manual approval. Then, subsequent serving certificate renewal requests are automatically approved by the **machine-approver** if the Kubelet requests a new certificate with identical parameters.



#### NOTE

For clusters running on platforms that are not machine API enabled, such as bare metal and other user-provisioned infrastructure, you must implement a method of automatically approving the kubelet serving certificate requests (CSRs). If a request is not approved, then the **oc exec**, **oc rsh**, and **oc logs** commands cannot succeed, because a serving certificate is required when the API server connects to the kubelet. Any operation that contacts the Kubelet endpoint requires this certificate approval to be in place. The method must watch for new CSRs, confirm that the CSR was submitted by the **node-bootstrapper** service account in the **system:node** or **system:admin** groups, and confirm the identity of the node.

- To approve them individually, run the following command for each valid CSR:

```
$ oc adm certificate approve <csr_name> 1
```

- 1** **<csr\_name>** is the name of a CSR from the list of current CSRs.

- To approve all pending CSRs, run the following command:

```
$ oc get csr -o go-template='{{range .items}}{{if not .status}}{{.metadata.name}}{"\n"}\n{{end}}{{end}}' | xargs --no-run-if-empty oc adm certificate approve
```



#### NOTE

Some Operators might not become available until some CSRs are approved.

- Now that your client requests are approved, you must review the server requests for each machine that you added to the cluster:

```
$ oc get csr
```

### Example output

```
NAME      AGE   REQUESTOR                                     CONDITION
csr-bfd72 5m26s system:node:ip-10-0-50-126.us-east-2.compute.internal
Pending
csr-c57lv 5m26s system:node:ip-10-0-95-157.us-east-2.compute.internal
Pending
...
```

- If the remaining CSRs are not approved, and are in the **Pending** status, approve the CSRs for your cluster machines:

- To approve them individually, run the following command for each valid CSR:

```
$ oc adm certificate approve <csr_name> 1
```

- 1** **<csr\_name>** is the name of a CSR from the list of current CSRs.

- To approve all pending CSRs, run the following command:

```
$ oc get csr -o go-template='{{range .items}}{{if not .status}}{{.metadata.name}}{"\n"}\n{{end}}{{end}}' | xargs oc adm certificate approve
```

- After all client and server CSRs have been approved, the machines have the **Ready** status. Verify this by running the following command:

```
$ oc get nodes
```

### Example output

```
NAME      STATUS   ROLES    AGE   VERSION
master-0  Ready   master   73m   v1.23.0
master-1  Ready   master   73m   v1.23.0
master-2  Ready   master   74m   v1.23.0
worker-0  Ready   worker   11m   v1.23.0
worker-1  Ready   worker   11m   v1.23.0
```



### NOTE

It can take a few minutes after approval of the server CSRs for the machines to transition to the **Ready** status.

### Additional information

- For more information on CSRs, see [Certificate Signing Requests](#).

## 16.3.15. Initial Operator configuration

After the control plane initializes, you must immediately configure some Operators so that they all become available.

## Prerequisites

- Your control plane has initialized.

## Procedure

1. Watch the cluster components come online:

```
$ watch -n5 oc get clusteroperators
```

## Example output

NAME	VERSION	AVAILABLE	PROGRESSING	DEGRADED	SINCE
authentication	4.10.0	True	False	False	19m
baremetal	4.10.0	True	False	False	37m
cloud-credential	4.10.0	True	False	False	40m
cluster-autoscaler	4.10.0	True	False	False	37m
config-operator	4.10.0	True	False	False	38m
console	4.10.0	True	False	False	26m
csi-snapshot-controller	4.10.0	True	False	False	37m
dns	4.10.0	True	False	False	37m
etcd	4.10.0	True	False	False	36m
image-registry	4.10.0	True	False	False	31m
ingress	4.10.0	True	False	False	30m
insights	4.10.0	True	False	False	31m
kube-apiserver	4.10.0	True	False	False	26m
kube-controller-manager	4.10.0	True	False	False	36m
kube-scheduler	4.10.0	True	False	False	36m
kube-storage-version-migrator	4.10.0	True	False	False	37m
machine-api	4.10.0	True	False	False	29m
machine-approver	4.10.0	True	False	False	37m
machine-config	4.10.0	True	False	False	36m
marketplace	4.10.0	True	False	False	37m
monitoring	4.10.0	True	False	False	29m
network	4.10.0	True	False	False	38m
node-tuning	4.10.0	True	False	False	37m
openshift-apiserver	4.10.0	True	False	False	32m
openshift-controller-manager	4.10.0	True	False	False	30m
openshift-samples	4.10.0	True	False	False	32m
operator-lifecycle-manager	4.10.0	True	False	False	37m
operator-lifecycle-manager-catalog	4.10.0	True	False	False	37m
operator-lifecycle-manager-packageserver	4.10.0	True	False	False	32m
service-ca	4.10.0	True	False	False	38m
storage	4.10.0	True	False	False	37m

2. Configure the Operators that are not available.

### 16.3.15.1. Disabling the default OperatorHub sources

Operator catalogs that source content provided by Red Hat and community projects are configured for OperatorHub by default during an OpenShift Container Platform installation. In a restricted network environment, you must disable the default catalogs as a cluster administrator.

### Procedure

- Disable the sources for the default catalogs by adding **disableAllDefaultSources: true** to the **OperatorHub** object:

```
$ oc patch OperatorHub cluster --type json \
  -p '[{"op": "add", "path": "/spec/disableAllDefaultSources", "value": true}]'
```

### TIP

Alternatively, you can use the web console to manage catalog sources. From the **Administration** → **Cluster Settings** → **Configuration** → **OperatorHub** page, click the **Sources** tab, where you can create, delete, disable, and enable individual sources.

### 16.3.15.2. Image registry storage configuration

The Image Registry Operator is not initially available for platforms that do not provide default storage. After installation, you must configure your registry to use storage so that the Registry Operator is made available.

Instructions are shown for configuring a persistent volume, which is required for production clusters. Where applicable, instructions are shown for configuring an empty directory as the storage location, which is available for only non-production clusters.

Additional instructions are provided for allowing the image registry to use block storage types by using the **Recreate** rollout strategy during upgrades.

#### 16.3.15.2.1. Configuring registry storage for IBM Z

As a cluster administrator, following installation you must configure your registry to use storage.

### Prerequisites

- You have access to the cluster as a user with the **cluster-admin** role.
- You have a cluster on IBM Z.
- You have provisioned persistent storage for your cluster, such as Red Hat OpenShift Data Foundation.

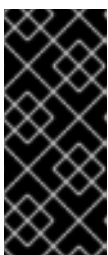

### IMPORTANT

OpenShift Container Platform supports **ReadWriteOnce** access for image registry storage when you have only one replica. **ReadWriteOnce** access also requires that the registry uses the **Recreate** rollout strategy. To deploy an image registry that supports high availability with two or more replicas, **ReadWriteMany** access is required.

- Must have 100Gi capacity.

## Procedure

1. To configure your registry to use storage, change the **spec.storage.pvc** in the **configs.imageregistry/cluster** resource.

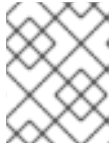

### NOTE

When using shared storage, review your security settings to prevent outside access.

2. Verify that you do not have a registry pod:

```
$ oc get pod -n openshift-image-registry -l docker-registry=default
```

### Example output

```
No resources found in openshift-image-registry namespace
```

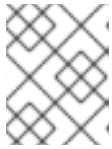

### NOTE

If you do have a registry pod in your output, you do not need to continue with this procedure.

3. Check the registry configuration:

```
$ oc edit configs.imageregistry.operator.openshift.io
```

### Example output

```
storage:
  pvc:
    claim:
```

Leave the **claim** field blank to allow the automatic creation of an **image-registry-storage** PVC.

4. Check the **clusteroperator** status:

```
$ oc get clusteroperator image-registry
```

### Example output

NAME	VERSION	AVAILABLE	PROGRESSING	DEGRADED	SINCE
image-registry	4.10	True	False	False	6h50m

5. Ensure that your registry is set to managed to enable building and pushing of images.

- Run:

```
$ oc edit configs.imageregistry/cluster
```



Then, change the line

```
managementState: Removed
```

to

```
managementState: Managed
```

### 16.3.15.2.2. Configuring storage for the image registry in non-production clusters

You must configure storage for the Image Registry Operator. For non-production clusters, you can set the image registry to an empty directory. If you do so, all images are lost if you restart the registry.

#### Procedure

- To set the image registry storage to an empty directory:

```
$ oc patch configs.imageregistry.operator.openshift.io cluster --type merge --patch '{"spec": {"storage":{"emptyDir":{}}}'
```



#### WARNING

Configure this option for only non-production clusters.

If you run this command before the Image Registry Operator initializes its components, the **oc patch** command fails with the following error:

```
Error from server (NotFound): configs.imageregistry.operator.openshift.io "cluster" not found
```

Wait a few minutes and run the command again.

### 16.3.16. Completing installation on user-provisioned infrastructure

After you complete the Operator configuration, you can finish installing the cluster on infrastructure that you provide.

#### Prerequisites

- Your control plane has initialized.
- You have completed the initial Operator configuration.

#### Procedure

1. Confirm that all the cluster components are online with the following command:

```
$ watch -n5 oc get clusteroperators
```

## Example output

NAME	VERSION	AVAILABLE	PROGRESSING	DEGRADED	SINCE
authentication	4.10.0	True	False	False	19m
baremetal	4.10.0	True	False	False	37m
cloud-credential	4.10.0	True	False	False	40m
cluster-autoscaler	4.10.0	True	False	False	37m
config-operator	4.10.0	True	False	False	38m
console	4.10.0	True	False	False	26m
csi-snapshot-controller	4.10.0	True	False	False	37m
dns	4.10.0	True	False	False	37m
etcd	4.10.0	True	False	False	36m
image-registry	4.10.0	True	False	False	31m
ingress	4.10.0	True	False	False	30m
insights	4.10.0	True	False	False	31m
kube-apiserver	4.10.0	True	False	False	26m
kube-controller-manager	4.10.0	True	False	False	36m
kube-scheduler	4.10.0	True	False	False	36m
kube-storage-version-migrator	4.10.0	True	False	False	37m
machine-api	4.10.0	True	False	False	29m
machine-approver	4.10.0	True	False	False	37m
machine-config	4.10.0	True	False	False	36m
marketplace	4.10.0	True	False	False	37m
monitoring	4.10.0	True	False	False	29m
network	4.10.0	True	False	False	38m
node-tuning	4.10.0	True	False	False	37m
openshift-apiserver	4.10.0	True	False	False	32m
openshift-controller-manager	4.10.0	True	False	False	30m
openshift-samples	4.10.0	True	False	False	32m
operator-lifecycle-manager	4.10.0	True	False	False	37m
operator-lifecycle-manager-catalog	4.10.0	True	False	False	37m
operator-lifecycle-manager-packageserver	4.10.0	True	False	False	32m
service-ca	4.10.0	True	False	False	38m
storage	4.10.0	True	False	False	37m

Alternatively, the following command notifies you when all of the clusters are available. It also retrieves and displays credentials:

```
$ ./openshift-install --dir <installation_directory> wait-for install-complete 1
```

- 1** For **<installation\_directory>**, specify the path to the directory that you stored the installation files in.

## Example output

```
INFO Waiting up to 30m0s for the cluster to initialize...
```

The command succeeds when the Cluster Version Operator finishes deploying the OpenShift Container Platform cluster from Kubernetes API server.



## IMPORTANT

- The Ignition config files that the installation program generates contain certificates that expire after 24 hours, which are then renewed at that time. If the cluster is shut down before renewing the certificates and the cluster is later restarted after the 24 hours have elapsed, the cluster automatically recovers the expired certificates. The exception is that you must manually approve the pending **node-bootstrapper** certificate signing requests (CSRs) to recover kubelet certificates. See the documentation for *Recovering from expired control plane certificates* for more information.
- It is recommended that you use Ignition config files within 12 hours after they are generated because the 24-hour certificate rotates from 16 to 22 hours after the cluster is installed. By using the Ignition config files within 12 hours, you can avoid installation failure if the certificate update runs during installation.

2. Confirm that the Kubernetes API server is communicating with the pods.

a. To view a list of all pods, use the following command:

```
$ oc get pods --all-namespaces
```

### Example output

```

NAMESPACE           NAME                                     READY  STATUS
RESTARTS  AGE
openshift-apiserver-operator  openshift-apiserver-operator-85cb746d55-zqhs8  1/1
Running  1      9m
openshift-apiserver          apiserver-67b9g                                1/1  Running  0
3m
openshift-apiserver          apiserver-ljcmx                                1/1  Running  0
1m
openshift-apiserver          apiserver-z25h4                                1/1  Running  0
2m
openshift-authentication-operator  authentication-operator-69d5d8bf84-vh2n8  1/1
Running  0      5m
...

```

b. View the logs for a pod that is listed in the output of the previous command by using the following command:

```
$ oc logs <pod_name> -n <namespace> ❶
```

- ❶ Specify the pod name and namespace, as shown in the output of the previous command.

If the pod logs display, the Kubernetes API server can communicate with the cluster machines.

3. For an installation with Fibre Channel Protocol (FCP), additional steps are required to enable multipathing. Do not enable multipathing during installation. See "Enabling multipathing with kernel arguments on RHCOS" in the *Post-installation machine configuration tasks* documentation for more information.

4. Register your cluster on the [Cluster registration](#) page.

#### Additional resources

- [How to generate SOSREPORT within OpenShift Container Platform version 4 nodes without SSH.](#)

#### 16.3.17. Next steps

- [Customize your cluster.](#)
- If the mirror registry that you used to install your cluster has a trusted CA, add it to the cluster by [configuring additional trust stores.](#)
- If necessary, you can [opt out of remote health reporting](#) .
- If necessary, see [Registering your disconnected cluster](#)

## CHAPTER 17. INSTALLING ON IBM POWER

### 17.1. PREPARING TO INSTALL ON IBM POWER

#### 17.1.1. Prerequisites

- You reviewed details about the [OpenShift Container Platform installation and update](#) processes.
- You read the documentation on [selecting a cluster installation method and preparing it for users](#).

#### 17.1.2. Choosing a method to install OpenShift Container Platform on IBM Power

You can install a cluster on IBM Power infrastructure that you provision, by using one of the following methods:

- **Installing a cluster on IBM Power** You can install OpenShift Container Platform on IBM Power infrastructure that you provision.
- **Installing a cluster on IBM Power in a restricted network** You can install OpenShift Container Platform on IBM Power infrastructure that you provision in a restricted or disconnected network, by using an internal mirror of the installation release content. You can use this method to install a cluster that does not require an active internet connection to obtain the software components. You can also use this installation method to ensure that your clusters only use container images that satisfy your organizational controls on external content.

### 17.2. INSTALLING A CLUSTER ON IBM POWER

In OpenShift Container Platform version 4.10, you can install a cluster on IBM Power infrastructure that you provision.



#### IMPORTANT

Additional considerations exist for non-bare metal platforms. Review the information in the [guidelines for deploying OpenShift Container Platform on non-tested platforms](#) before you install an OpenShift Container Platform cluster.

#### 17.2.1. Prerequisites

- You reviewed details about the [OpenShift Container Platform installation and update](#) processes.
- You read the documentation on [selecting a cluster installation method and preparing it for users](#).
- Before you begin the installation process, you must clean the installation directory. This ensures that the required installation files are created and updated during the installation process.
- You provisioned [persistent storage using OpenShift Data Foundation](#) or other supported storage protocols for your cluster. To deploy a private image registry, you must set up persistent storage with **ReadWriteMany** access.

- If you use a firewall, you [configured it to allow the sites](#) that your cluster requires access to.

**NOTE**

Be sure to also review this site list if you are configuring a proxy.

### 17.2.2. Internet access for OpenShift Container Platform

In OpenShift Container Platform 4.10, you require access to the internet to install your cluster.

You must have internet access to:

- Access [OpenShift Cluster Manager](#) to download the installation program and perform subscription management. If the cluster has internet access and you do not disable Telemetry, that service automatically entitles your cluster.
- Access [Quay.io](#) to obtain the packages that are required to install your cluster.
- Obtain the packages that are required to perform cluster updates.

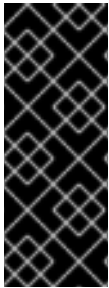
**IMPORTANT**

If your cluster cannot have direct internet access, you can perform a restricted network installation on some types of infrastructure that you provision. During that process, you download the required content and use it to populate a mirror registry with the installation packages. With some installation types, the environment that you install your cluster in will not require internet access. Before you update the cluster, you update the content of the mirror registry.

### 17.2.3. Requirements for a cluster with user-provisioned infrastructure

For a cluster that contains user-provisioned infrastructure, you must deploy all of the required machines.

This section describes the requirements for deploying OpenShift Container Platform on user-provisioned infrastructure.

#### 17.2.3.1. Required machines for cluster installation

The smallest OpenShift Container Platform clusters require the following hosts:

**Table 17.1. Minimum required hosts**

Hosts	Description
One temporary bootstrap machine	The cluster requires the bootstrap machine to deploy the OpenShift Container Platform cluster on the three control plane machines. You can remove the bootstrap machine after you install the cluster.
Three control plane machines	The control plane machines run the Kubernetes and OpenShift Container Platform services that form the control plane.

Hosts	Description
At least two compute machines, which are also known as worker machines.	The workloads requested by OpenShift Container Platform users run on the compute machines.



### IMPORTANT

To maintain high availability of your cluster, use separate physical hosts for these cluster machines.

The bootstrap, control plane, and compute machines must use Red Hat Enterprise Linux CoreOS (RHCOS) as the operating system.

Note that RHCOS is based on Red Hat Enterprise Linux (RHEL) 8 and inherits all of its hardware certifications and requirements. See [Red Hat Enterprise Linux technology capabilities and limits](#) .

#### 17.2.3.2. Minimum resource requirements for cluster installation

Each cluster machine must meet the following minimum requirements:

**Table 17.2. Minimum resource requirements**

Machine	Operating System	vCPU [1]	Virtual RAM	Storage	IOPS [2]
Bootstrap	RHCOS	2	16 GB	100 GB	300
Control plane	RHCOS	2	16 GB	100 GB	300
Compute	RHCOS	2	8 GB	100 GB	300

1. One vCPU is equivalent to one physical core when simultaneous multithreading (SMT), or hyperthreading, is not enabled. When enabled, use the following formula to calculate the corresponding ratio:  $(\text{threads per core} \times \text{cores}) \times \text{sockets} = \text{vCPUs}$ .
2. OpenShift Container Platform and Kubernetes are sensitive to disk performance, and faster storage is recommended, particularly for etcd on the control plane nodes. Note that on many cloud platforms, storage size and IOPS scale together, so you might need to over-allocate storage volume to obtain sufficient performance.

If an instance type for your platform meets the minimum requirements for cluster machines, it is supported to use in OpenShift Container Platform.

#### 17.2.3.3. Minimum IBM Power requirements

You can install OpenShift Container Platform version 4.10 on the following IBM hardware:

- IBM Power8, Power9, or Power10 processor-based systems

#### Hardware requirements

- Six IBM Power bare metal servers or six LPARs across multiple PowerVM servers

### Operating system requirements

- One instance of an IBM Power8, Power9, or Power10 processor-based system

On your IBM Power instance, set up:

- Three guest virtual machines for OpenShift Container Platform control plane machines
- Two guest virtual machines for OpenShift Container Platform compute machines
- One guest virtual machine for the temporary OpenShift Container Platform bootstrap machine

### Disk storage for the IBM Power guest virtual machines

- Local storage, or storage provisioned by the Virtual I/O Server using vSCSI, NPIV (N-Port ID Virtualization) or SSP (shared storage pools)

### Network for the PowerVM guest virtual machines

- Dedicated physical adapter, or SR-IOV virtual function
- Available by the Virtual I/O Server using Shared Ethernet Adapter
- Virtualized by the Virtual I/O Server using IBM vNIC

### Storage / main memory

- 100 GB / 16 GB for OpenShift Container Platform control plane machines
- 100 GB / 8 GB for OpenShift Container Platform compute machines
- 100 GB / 16 GB for the temporary OpenShift Container Platform bootstrap machine

## 17.2.3.4. Recommended IBM Power system requirements

### Hardware requirements

- Six IBM Power bare metal servers or six LPARs across multiple PowerVM servers

### Operating system requirements

- One instance of an IBM Power8, Power9, or Power10 processor-based system

On your IBM Power instance, set up:

- Three guest virtual machines for OpenShift Container Platform control plane machines
- Two guest virtual machines for OpenShift Container Platform compute machines
- One guest virtual machine for the temporary OpenShift Container Platform bootstrap machine

### Disk storage for the IBM Power guest virtual machines

- Local storage, or storage provisioned by the Virtual I/O Server using vSCSI, NPIV (N-Port ID Virtualization) or SSP (shared storage pools)

### Network for the PowerVM guest virtual machines



- Dedicated physical adapter, or SR-IOV virtual function
- Available by the Virtual I/O Server using Shared Ethernet Adapter
- Virtualized by the Virtual I/O Server using IBM vNIC

### Storage / main memory

- 120 GB / 32 GB for OpenShift Container Platform control plane machines
- 120 GB / 32 GB for OpenShift Container Platform compute machines
- 120 GB / 16 GB for the temporary OpenShift Container Platform bootstrap machine

#### 17.2.3.5. Certificate signing requests management

Because your cluster has limited access to automatic machine management when you use infrastructure that you provision, you must provide a mechanism for approving cluster certificate signing requests (CSRs) after installation. The **kube-controller-manager** only approves the kubelet client CSRs. The **machine-approver** cannot guarantee the validity of a serving certificate that is requested by using kubelet credentials because it cannot confirm that the correct machine issued the request. You must determine and implement a method of verifying the validity of the kubelet serving certificate requests and approving them.

#### 17.2.3.6. Networking requirements for user-provisioned infrastructure

All the Red Hat Enterprise Linux CoreOS (RHCOS) machines require networking to be configured in **initramfs** during boot to fetch their Ignition config files.

During the initial boot, the machines require an IP address configuration that is set either through a DHCP server or statically by providing the required boot options. After a network connection is established, the machines download their Ignition config files from an HTTP or HTTPS server. The Ignition config files are then used to set the exact state of each machine. The Machine Config Operator completes more changes to the machines, such as the application of new certificates or keys, after installation.

It is recommended to use a DHCP server for long-term management of the cluster machines. Ensure that the DHCP server is configured to provide persistent IP addresses, DNS server information, and hostnames to the cluster machines.



#### NOTE

If a DHCP service is not available for your user-provisioned infrastructure, you can instead provide the IP networking configuration and the address of the DNS server to the nodes at RHCOS install time. These can be passed as boot arguments if you are installing from an ISO image. See the *Installing RHCOS and starting the OpenShift Container Platform bootstrap process* section for more information about static IP provisioning and advanced networking options.

The Kubernetes API server must be able to resolve the node names of the cluster machines. If the API servers and worker nodes are in different zones, you can configure a default DNS search zone to allow the API server to resolve the node names. Another supported approach is to always refer to hosts by their fully-qualified domain names in both the node objects and all DNS requests.

##### 17.2.3.6.1. Setting the cluster node hostnames through DHCP

On Red Hat Enterprise Linux CoreOS (RHCOS) machines, the hostname is set through NetworkManager. By default, the machines obtain their hostname through DHCP. If the hostname is not provided by DHCP, set statically through kernel arguments, or another method, it is obtained through a reverse DNS lookup. Reverse DNS lookup occurs after the network has been initialized on a node and can take time to resolve. Other system services can start prior to this and detect the hostname as **localhost** or similar. You can avoid this by using DHCP to provide the hostname for each cluster node.

Additionally, setting the hostnames through DHCP can bypass any manual DNS record name configuration errors in environments that have a DNS split-horizon implementation.

### 17.2.3.6.2. Network connectivity requirements

You must configure the network connectivity between machines to allow OpenShift Container Platform cluster components to communicate. Each machine must be able to resolve the hostnames of all other machines in the cluster.

This section provides details about the ports that are required.



#### IMPORTANT

In connected OpenShift Container Platform environments, all nodes are required to have internet access to pull images for platform containers and provide telemetry data to Red Hat.

**Table 17.3. Ports used for all-machine to all-machine communications**

Protocol	Port	Description
ICMP	N/A	Network reachability tests
TCP	<b>1936</b>	Metrics
	<b>9000-9999</b>	Host level services, including the node exporter on ports <b>9100-9101</b> and the Cluster Version Operator on port <b>9099</b> .
	<b>10250-10259</b>	The default ports that Kubernetes reserves
	<b>10256</b>	openshift-sdn
UDP	<b>4789</b>	VXLAN
	<b>6081</b>	Geneve
	<b>9000-9999</b>	Host level services, including the node exporter on ports <b>9100-9101</b> .
	<b>500</b>	IPsec IKE packets
	<b>4500</b>	IPsec NAT-T packets
TCP/UDP	<b>30000-32767</b>	Kubernetes node port

Protocol	Port	Description
ESP	N/A	IPsec Encapsulating Security Payload (ESP)

**Table 17.4. Ports used for all-machine to control plane communications**

Protocol	Port	Description
TCP	<b>6443</b>	Kubernetes API

**Table 17.5. Ports used for control plane machine to control plane machine communications**

Protocol	Port	Description
TCP	<b>2379-2380</b>	etcd server and peer ports

### NTP configuration for user-provisioned infrastructure

OpenShift Container Platform clusters are configured to use a public Network Time Protocol (NTP) server by default. If you want to use a local enterprise NTP server, or if your cluster is being deployed in a disconnected network, you can configure the cluster to use a specific time server. For more information, see the documentation for *Configuring chrony time service*.

If a DHCP server provides NTP server information, the chrony time service on the Red Hat Enterprise Linux CoreOS (RHCOS) machines read the information and can sync the clock with the NTP servers.

### Additional resources

- [Configuring chrony time service](#)

### 17.2.3.7. User-provisioned DNS requirements

In OpenShift Container Platform deployments, DNS name resolution is required for the following components:

- The Kubernetes API
- The OpenShift Container Platform application wildcard
- The bootstrap, control plane, and compute machines

Reverse DNS resolution is also required for the Kubernetes API, the bootstrap machine, the control plane machines, and the compute machines.

DNS A/AAAA or CNAME records are used for name resolution and PTR records are used for reverse name resolution. The reverse records are important because Red Hat Enterprise Linux CoreOS (RHCOS) uses the reverse records to set the hostnames for all the nodes, unless the hostnames are provided by DHCP. Additionally, the reverse records are used to generate the certificate signing requests (CSR) that OpenShift Container Platform needs to operate.

**NOTE**

It is recommended to use a DHCP server to provide the hostnames to each cluster node. See the *DHCP recommendations for user-provisioned infrastructure* section for more information.

The following DNS records are required for a user-provisioned OpenShift Container Platform cluster and they must be in place before installation. In each record, **<cluster\_name>** is the cluster name and **<base\_domain>** is the base domain that you specify in the **install-config.yaml** file. A complete DNS record takes the form: **<component>.<cluster\_name>.<base\_domain>..**

**Table 17.6. Required DNS records**

Component	Record	Description
Kubernetes API	<b>api.&lt;cluster_name&gt;.&lt;base_domain&gt;.</b>	A DNS A/AAAA or CNAME record, and a DNS PTR record, to identify the API load balancer. These records must be resolvable by both clients external to the cluster and from all the nodes within the cluster.
	<b>api-int.&lt;cluster_name&gt;.&lt;base_domain&gt;.</b>	A DNS A/AAAA or CNAME record, and a DNS PTR record, to internally identify the API load balancer. These records must be resolvable from all the nodes within the cluster.
		 <p><b>IMPORTANT</b></p> <p>The API server must be able to resolve the worker nodes by the hostnames that are recorded in Kubernetes. If the API server cannot resolve the node names, then proxied API calls can fail, and you cannot retrieve logs from pods.</p>
Routes	<b>*.apps.&lt;cluster_name&gt;.&lt;base_domain&gt;.</b>	<p>A wildcard DNS A/AAAA or CNAME record that refers to the application ingress load balancer. The application ingress load balancer targets the machines that run the Ingress Controller pods. The Ingress Controller pods run on the compute machines by default. These records must be resolvable by both clients external to the cluster and from all the nodes within the cluster.</p> <p>For example, <b>console-openshift-console.apps.&lt;cluster_name&gt;.&lt;base_domain&gt;</b> is used as a wildcard route to the OpenShift Container Platform console.</p>
Bootstrap machine	<b>bootstrap.&lt;cluster_name&gt;.&lt;base_domain&gt;.</b>	A DNS A/AAAA or CNAME record, and a DNS PTR record, to identify the bootstrap machine. These records must be resolvable by the nodes within the cluster.

Component	Record	Description
Control plane machines	<b>&lt;master&gt;&lt;n&gt;. &lt;cluster_name&gt;. &lt;base_domain&gt;.</b>	DNS A/AAAA or CNAME records and DNS PTR records to identify each machine for the control plane nodes. These records must be resolvable by the nodes within the cluster.
Compute machines	<b>&lt;worker&gt;&lt;n&gt;. &lt;cluster_name&gt;. &lt;base_domain&gt;.</b>	DNS A/AAAA or CNAME records and DNS PTR records to identify each machine for the worker nodes. These records must be resolvable by the nodes within the cluster.



## NOTE

In OpenShift Container Platform 4.4 and later, you do not need to specify etcd host and SRV records in your DNS configuration.

## TIP

You can use the **dig** command to verify name and reverse name resolution. See the section on *Validating DNS resolution for user-provisioned infrastructure* for detailed validation steps.

### 17.2.3.7.1. Example DNS configuration for user-provisioned clusters

This section provides A and PTR record configuration samples that meet the DNS requirements for deploying OpenShift Container Platform on user-provisioned infrastructure. The samples are not meant to provide advice for choosing one DNS solution over another.

In the examples, the cluster name is **ocp4** and the base domain is **example.com**.

#### Example DNS A record configuration for a user-provisioned cluster

The following example is a BIND zone file that shows sample A records for name resolution in a user-provisioned cluster.

#### Example 17.1. Sample DNS zone database

```
$TTL 1W
@ IN SOA ns1.example.com. root (
  2019070700 ; serial
  3H ; refresh (3 hours)
  30M ; retry (30 minutes)
  2W ; expiry (2 weeks)
  1W ) ; minimum (1 week)
IN NS ns1.example.com.
IN MX 10 smtp.example.com.
;
;
ns1.example.com. IN A 192.168.1.5
smtp.example.com. IN A 192.168.1.5
;
helper.example.com. IN A 192.168.1.5
```

```

helper.ocp4.example.com. IN A 192.168.1.5
;
api.ocp4.example.com. IN A 192.168.1.5 1
api-int.ocp4.example.com. IN A 192.168.1.5 2
;
*.apps.ocp4.example.com. IN A 192.168.1.5 3
;
bootstrap.ocp4.example.com. IN A 192.168.1.96 4
;
master0.ocp4.example.com. IN A 192.168.1.97 5
master1.ocp4.example.com. IN A 192.168.1.98 6
master2.ocp4.example.com. IN A 192.168.1.99 7
;
worker0.ocp4.example.com. IN A 192.168.1.11 8
worker1.ocp4.example.com. IN A 192.168.1.7 9
;
;EOF

```

- 1 Provides name resolution for the Kubernetes API. The record refers to the IP address of the API load balancer.
- 2 Provides name resolution for the Kubernetes API. The record refers to the IP address of the API load balancer and is used for internal cluster communications.
- 3 Provides name resolution for the wildcard routes. The record refers to the IP address of the application ingress load balancer. The application ingress load balancer targets the machines that run the Ingress Controller pods. The Ingress Controller pods run on the compute machines by default.



#### NOTE

In the example, the same load balancer is used for the Kubernetes API and application ingress traffic. In production scenarios, you can deploy the API and application ingress load balancers separately so that you can scale the load balancer infrastructure for each in isolation.

- 4 Provides name resolution for the bootstrap machine.
- 5 6 7 Provides name resolution for the control plane machines.
- 8 9 Provides name resolution for the compute machines.

### Example DNS PTR record configuration for a user-provisioned cluster

The following example BIND zone file shows sample PTR records for reverse name resolution in a user-provisioned cluster.

#### Example 17.2. Sample DNS zone database for reverse records

```

$TTL 1W
@ IN SOA ns1.example.com. root (
  2019070700 ; serial

```

```

3H ; refresh (3 hours)
30M ; retry (30 minutes)
2W ; expiry (2 weeks)
1W ) ; minimum (1 week)
IN NS ns1.example.com.
;
5.1.168.192.in-addr.arpa. IN PTR api.ocp4.example.com. 1
5.1.168.192.in-addr.arpa. IN PTR api-int.ocp4.example.com. 2
;
96.1.168.192.in-addr.arpa. IN PTR bootstrap.ocp4.example.com. 3
;
97.1.168.192.in-addr.arpa. IN PTR master0.ocp4.example.com. 4
98.1.168.192.in-addr.arpa. IN PTR master1.ocp4.example.com. 5
99.1.168.192.in-addr.arpa. IN PTR master2.ocp4.example.com. 6
;
11.1.168.192.in-addr.arpa. IN PTR worker0.ocp4.example.com. 7
7.1.168.192.in-addr.arpa. IN PTR worker1.ocp4.example.com. 8
;
;EOF

```

- 1 Provides reverse DNS resolution for the Kubernetes API. The PTR record refers to the record name of the API load balancer.
- 2 Provides reverse DNS resolution for the Kubernetes API. The PTR record refers to the record name of the API load balancer and is used for internal cluster communications.
- 3 Provides reverse DNS resolution for the bootstrap machine.
- 4 5 6 Provides reverse DNS resolution for the control plane machines.
- 7 8 Provides reverse DNS resolution for the compute machines.



#### NOTE

A PTR record is not required for the OpenShift Container Platform application wildcard.

### 17.2.3.8. Load balancing requirements for user-provisioned infrastructure

Before you install OpenShift Container Platform, you must provision the API and application ingress load balancing infrastructure. In production scenarios, you can deploy the API and application ingress load balancers separately so that you can scale the load balancer infrastructure for each in isolation.

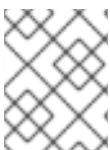

#### NOTE

If you want to deploy the API and application Ingress load balancers with a Red Hat Enterprise Linux (RHEL) instance, you must purchase the RHEL subscription separately.

The load balancing infrastructure must meet the following requirements:

1. **API load balancer.** Provides a common endpoint for users, both human and machine, to interact with and configure the platform. Configure the following conditions:

- Layer 4 load balancing only. This can be referred to as Raw TCP, SSL Passthrough, or SSL Bridge mode. If you use SSL Bridge mode, you must enable Server Name Indication (SNI) for the API routes.
- A stateless load balancing algorithm. The options vary based on the load balancer implementation.



### IMPORTANT

Do not configure session persistence for an API load balancer. Configuring session persistence for a Kubernetes API server might cause performance issues from excess application traffic for your OpenShift Container Platform cluster and the Kubernetes API that runs inside the cluster.

Configure the following ports on both the front and back of the load balancers:

**Table 17.7. API load balancer**

Port	Back-end machines (pool members)	Internal	External	Description
<b>6443</b>	Bootstrap and control plane. You remove the bootstrap machine from the load balancer after the bootstrap machine initializes the cluster control plane. You must configure the <b>/readyz</b> endpoint for the API server health check probe.	X	X	Kubernetes API server
<b>22623</b>	Bootstrap and control plane. You remove the bootstrap machine from the load balancer after the bootstrap machine initializes the cluster control plane.	X		Machine config server



### NOTE

The load balancer must be configured to take a maximum of 30 seconds from the time the API server turns off the **/readyz** endpoint to the removal of the API server instance from the pool. Within the time frame after **/readyz** returns an error or becomes healthy, the endpoint must have been removed or added. Probing every 5 or 10 seconds, with two successful requests to become healthy and three to become unhealthy, are well-tested values.

2. **Application Ingress load balancer.** Provides an ingress point for application traffic flowing in from outside the cluster. A working configuration for the Ingress router is required for an OpenShift Container Platform cluster. Configure the following conditions:

- Layer 4 load balancing only. This can be referred to as Raw TCP, SSL Passthrough, or SSL Bridge mode. If you use SSL Bridge mode, you must enable Server Name Indication (SNI) for the ingress routes.



- A connection-based or session-based persistence is recommended, based on the options available and types of applications that will be hosted on the platform.

## TIP

If the true IP address of the client can be seen by the application Ingress load balancer, enabling source IP-based session persistence can improve performance for applications that use end-to-end TLS encryption.

Configure the following ports on both the front and back of the load balancers:

**Table 17.8. Application Ingress load balancer**

Port	Back-end machines (pool members)	Internal	External	Description
<b>443</b>	The machines that run the Ingress Controller pods, compute, or worker, by default.	X	X	HTTPS traffic
<b>80</b>	The machines that run the Ingress Controller pods, compute, or worker, by default.	X	X	HTTP traffic



## NOTE

If you are deploying a three-node cluster with zero compute nodes, the Ingress Controller pods run on the control plane nodes. In three-node cluster deployments, you must configure your application Ingress load balancer to route HTTP and HTTPS traffic to the control plane nodes.

### 17.2.3.8.1. Example load balancer configuration for user-provisioned clusters

This section provides an example API and application ingress load balancer configuration that meets the load balancing requirements for user-provisioned clusters. The sample is an `/etc/haproxy/haproxy.cfg` configuration for an HAProxy load balancer. The example is not meant to provide advice for choosing one load balancing solution over another.

In the example, the same load balancer is used for the Kubernetes API and application ingress traffic. In production scenarios, you can deploy the API and application ingress load balancers separately so that you can scale the load balancer infrastructure for each in isolation.



## NOTE

If you are using HAProxy as a load balancer and SELinux is set to **enforcing**, you must ensure that the HAProxy service can bind to the configured TCP port by running **setsebool -P haproxy\_connect\_any=1**.

### Example 17.3. Sample API and application Ingress load balancer configuration

```
global
log      127.0.0.1 local2
pidfile /var/run/haproxy.pid
```

```

maxconn 4000
daemon
defaults
mode http
log global
option dontlognull
option http-server-close
option redispatch
retries 3
timeout http-request 10s
timeout queue 1m
timeout connect 10s
timeout client 1m
timeout server 1m
timeout http-keep-alive 10s
timeout check 10s
maxconn 3000
listen api-server-6443 1
bind *:6443
mode tcp
server bootstrap bootstrap.ocp4.example.com:6443 check inter 1s backup 2
server master0 master0.ocp4.example.com:6443 check inter 1s
server master1 master1.ocp4.example.com:6443 check inter 1s
server master2 master2.ocp4.example.com:6443 check inter 1s
listen machine-config-server-22623 3
bind *:22623
mode tcp
server bootstrap bootstrap.ocp4.example.com:22623 check inter 1s backup 4
server master0 master0.ocp4.example.com:22623 check inter 1s
server master1 master1.ocp4.example.com:22623 check inter 1s
server master2 master2.ocp4.example.com:22623 check inter 1s
listen ingress-router-443 5
bind *:443
mode tcp
balance source
server worker0 worker0.ocp4.example.com:443 check inter 1s
server worker1 worker1.ocp4.example.com:443 check inter 1s
listen ingress-router-80 6
bind *:80
mode tcp
balance source
server worker0 worker0.ocp4.example.com:80 check inter 1s
server worker1 worker1.ocp4.example.com:80 check inter 1s

```

- 1 Port **6443** handles the Kubernetes API traffic and points to the control plane machines.
- 2 4 The bootstrap entries must be in place before the OpenShift Container Platform cluster installation and they must be removed after the bootstrap process is complete.
- 3 Port **22623** handles the machine config server traffic and points to the control plane machines.
- 5 Port **443** handles the HTTPS traffic and points to the machines that run the Ingress Controller pods. The Ingress Controller pods run on the compute machines by default.
- 6

Port **80** handles the HTTP traffic and points to the machines that run the Ingress Controller pods. The Ingress Controller pods run on the compute machines by default.



#### NOTE

If you are deploying a three-node cluster with zero compute nodes, the Ingress Controller pods run on the control plane nodes. In three-node cluster deployments, you must configure your application Ingress load balancer to route HTTP and HTTPS traffic to the control plane nodes.

#### TIP

If you are using HAProxy as a load balancer, you can check that the **haproxy** process is listening on ports **6443**, **22623**, **443**, and **80** by running **netstat -nltp** on the HAProxy node.

### 17.2.4. Preparing the user-provisioned infrastructure

Before you install OpenShift Container Platform on user-provisioned infrastructure, you must prepare the underlying infrastructure.

This section provides details about the high-level steps required to set up your cluster infrastructure in preparation for an OpenShift Container Platform installation. This includes configuring IP networking and network connectivity for your cluster nodes, enabling the required ports through your firewall, and setting up the required DNS and load balancing infrastructure.

After preparation, your cluster infrastructure must meet the requirements outlined in the *Requirements for a cluster with user-provisioned infrastructure* section.

#### Prerequisites

- You have reviewed the [OpenShift Container Platform 4.x Tested Integrations](#) page.
- You have reviewed the infrastructure requirements detailed in the *Requirements for a cluster with user-provisioned infrastructure* section.

#### Procedure

1. If you are using DHCP to provide the IP networking configuration to your cluster nodes, configure your DHCP service.
  - a. Add persistent IP addresses for the nodes to your DHCP server configuration. In your configuration, match the MAC address of the relevant network interface to the intended IP address for each node.
  - b. When you use DHCP to configure IP addressing for the cluster machines, the machines also obtain the DNS server information through DHCP. Define the persistent DNS server address that is used by the cluster nodes through your DHCP server configuration.

**NOTE**

If you are not using a DHCP service, you must provide the IP networking configuration and the address of the DNS server to the nodes at RHCOS install time. These can be passed as boot arguments if you are installing from an ISO image. See the *Installing RHCOS and starting the OpenShift Container Platform bootstrap process* section for more information about static IP provisioning and advanced networking options.

- c. Define the hostnames of your cluster nodes in your DHCP server configuration. See the *Setting the cluster node hostnames through DHCP* section for details about hostname considerations.

**NOTE**

If you are not using a DHCP service, the cluster nodes obtain their hostname through a reverse DNS lookup.

2. Ensure that your network infrastructure provides the required network connectivity between the cluster components. See the *Networking requirements for user-provisioned infrastructure* section for details about the requirements.
3. Configure your firewall to enable the ports required for the OpenShift Container Platform cluster components to communicate. See *Networking requirements for user-provisioned infrastructure* section for details about the ports that are required.

**IMPORTANT**

By default, port **1936** is accessible for an OpenShift Container Platform cluster, because each control plane node needs access to this port.

Avoid using the Ingress load balancer to expose this port, because doing so might result in the exposure of sensitive information, such as statistics and metrics, related to Ingress Controllers.

4. Setup the required DNS infrastructure for your cluster.
  - a. Configure DNS name resolution for the Kubernetes API, the application wildcard, the bootstrap machine, the control plane machines, and the compute machines.
  - b. Configure reverse DNS resolution for the Kubernetes API, the bootstrap machine, the control plane machines, and the compute machines.  
See the *User-provisioned DNS requirements* section for more information about the OpenShift Container Platform DNS requirements.
5. Validate your DNS configuration.
  - a. From your installation node, run DNS lookups against the record names of the Kubernetes API, the wildcard routes, and the cluster nodes. Validate that the IP addresses in the responses correspond to the correct components.
  - b. From your installation node, run reverse DNS lookups against the IP addresses of the load balancer and the cluster nodes. Validate that the record names in the responses correspond to the correct components.

See the *Validating DNS resolution for user-provisioned infrastructure* section for detailed DNS validation steps.

6. Provision the required API and application ingress load balancing infrastructure. See the *Load balancing requirements for user-provisioned infrastructure* section for more information about the requirements.



### NOTE

Some load balancing solutions require the DNS name resolution for the cluster nodes to be in place before the load balancing is initialized.

## 17.2.5. Validating DNS resolution for user-provisioned infrastructure

You can validate your DNS configuration before installing OpenShift Container Platform on user-provisioned infrastructure.



### IMPORTANT

The validation steps detailed in this section must succeed before you install your cluster.

### Prerequisites

- You have configured the required DNS records for your user-provisioned infrastructure.

### Procedure

1. From your installation node, run DNS lookups against the record names of the Kubernetes API, the wildcard routes, and the cluster nodes. Validate that the IP addresses contained in the responses correspond to the correct components.
  - a. Perform a lookup against the Kubernetes API record name. Check that the result points to the IP address of the API load balancer:

```
$ dig +noall +answer @<nameserver_ip> api.<cluster_name>.<base_domain> 1
```

- 1 Replace **<nameserver\_ip>** with the IP address of the nameserver, **<cluster\_name>** with your cluster name, and **<base\_domain>** with your base domain name.

### Example output

```
api.ocp4.example.com. 0 IN A 192.168.1.5
```

- b. Perform a lookup against the Kubernetes internal API record name. Check that the result points to the IP address of the API load balancer:

```
$ dig +noall +answer @<nameserver_ip> api-int.<cluster_name>.<base_domain>
```

### Example output

```
api-int.ocp4.example.com. 0 IN A 192.168.1.5
```

- c. Test an example `*.apps.<cluster_name>.<base_domain>` DNS wildcard lookup. All of the application wildcard lookups must resolve to the IP address of the application ingress load balancer:

```
$ dig +noall +answer @<nameserver_ip> random.apps.<cluster_name>.<base_domain>
```

#### Example output

```
random.apps.ocp4.example.com. 0 IN A 192.168.1.5
```



#### NOTE

In the example outputs, the same load balancer is used for the Kubernetes API and application ingress traffic. In production scenarios, you can deploy the API and application ingress load balancers separately so that you can scale the load balancer infrastructure for each in isolation.

You can replace **random** with another wildcard value. For example, you can query the route to the OpenShift Container Platform console:

```
$ dig +noall +answer @<nameserver_ip> console-openshift-console.apps.<cluster_name>.<base_domain>
```

#### Example output

```
console-openshift-console.apps.ocp4.example.com. 0 IN A 192.168.1.5
```

- d. Run a lookup against the bootstrap DNS record name. Check that the result points to the IP address of the bootstrap node:

```
$ dig +noall +answer @<nameserver_ip> bootstrap.<cluster_name>.<base_domain>
```

#### Example output

```
bootstrap.ocp4.example.com. 0 IN A 192.168.1.96
```

- e. Use this method to perform lookups against the DNS record names for the control plane and compute nodes. Check that the results correspond to the IP addresses of each node.
2. From your installation node, run reverse DNS lookups against the IP addresses of the load balancer and the cluster nodes. Validate that the record names contained in the responses correspond to the correct components.
- a. Perform a reverse lookup against the IP address of the API load balancer. Check that the response includes the record names for the Kubernetes API and the Kubernetes internal API:

```
$ dig +noall +answer @<nameserver_ip> -x 192.168.1.5
```

#### Example output

```
5.1.168.192.in-addr.arpa. 0 IN PTR api-int.ocp4.example.com. 1
5.1.168.192.in-addr.arpa. 0 IN PTR api.ocp4.example.com. 2
```

- 1 Provides the record name for the Kubernetes internal API.
- 2 Provides the record name for the Kubernetes API.



#### NOTE

A PTR record is not required for the OpenShift Container Platform application wildcard. No validation step is needed for reverse DNS resolution against the IP address of the application ingress load balancer.

- b. Perform a reverse lookup against the IP address of the bootstrap node. Check that the result points to the DNS record name of the bootstrap node:

```
$ dig +noall +answer @<nameserver_ip> -x 192.168.1.96
```

#### Example output

```
96.1.168.192.in-addr.arpa. 0 IN PTR bootstrap.ocp4.example.com.
```

- c. Use this method to perform reverse lookups against the IP addresses for the control plane and compute nodes. Check that the results correspond to the DNS record names of each node.

### 17.2.6. Generating a key pair for cluster node SSH access

During an OpenShift Container Platform installation, you can provide an SSH public key to the installation program. The key is passed to the Red Hat Enterprise Linux CoreOS (RHCOS) nodes through their Ignition config files and is used to authenticate SSH access to the nodes. The key is added to the `~/.ssh/authorized_keys` list for the **core** user on each node, which enables password-less authentication.

After the key is passed to the nodes, you can use the key pair to SSH in to the RHCOS nodes as the user **core**. To access the nodes through SSH, the private key identity must be managed by SSH for your local user.

If you want to SSH in to your cluster nodes to perform installation debugging or disaster recovery, you must provide the SSH public key during the installation process. The `./openshift-install gather` command also requires the SSH public key to be in place on the cluster nodes.

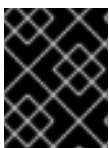

#### IMPORTANT

Do not skip this procedure in production environments, where disaster recovery and debugging is required.



#### NOTE

You must use a local key, not one that you configured with platform-specific approaches such as [AWS key pairs](#).

## Procedure

1. If you do not have an existing SSH key pair on your local machine to use for authentication onto your cluster nodes, create one. For example, on a computer that uses a Linux operating system, run the following command:

```
$ ssh-keygen -t ed25519 -N "" -f <path>/<file_name> 1
```

- 1 Specify the path and file name, such as `~/.ssh/id_ed25519`, of the new SSH key. If you have an existing key pair, ensure your public key is in the your `~/.ssh` directory.



### NOTE

If you plan to install an OpenShift Container Platform cluster that uses FIPS validated or Modules In Process cryptographic libraries on the **x86\_64** architecture, do not create a key that uses the **ed25519** algorithm. Instead, create a key that uses the **rsa** or **ecdsa** algorithm.

2. View the public SSH key:

```
$ cat <path>/<file_name>.pub
```

For example, run the following to view the `~/.ssh/id_ed25519.pub` public key:

```
$ cat ~/.ssh/id_ed25519.pub
```

3. Add the SSH private key identity to the SSH agent for your local user, if it has not already been added. SSH agent management of the key is required for password-less SSH authentication onto your cluster nodes, or if you want to use the `./openshift-install gather` command.



### NOTE

On some distributions, default SSH private key identities such as `~/.ssh/id_rsa` and `~/.ssh/id_dsa` are managed automatically.

- a. If the **ssh-agent** process is not already running for your local user, start it as a background task:

```
$ eval "$(ssh-agent -s)"
```

### Example output

```
Agent pid 31874
```



### NOTE

If your cluster is in FIPS mode, only use FIPS-compliant algorithms to generate the SSH key. The key must be either RSA or ECDSA.

4. Add your SSH private key to the **ssh-agent**:

■



```
$ ssh-add <path>/<file_name> 1
```

- 1 Specify the path and file name for your SSH private key, such as `~/.ssh/id_ed25519`

### Example output

```
Identity added: /home/<you>/<path>/<file_name> (<computer_name>)
```

### Next steps

- When you install OpenShift Container Platform, provide the SSH public key to the installation program.

## 17.2.7. Obtaining the installation program

Before you install OpenShift Container Platform, download the installation file on a local computer.

### Prerequisites

- You have a computer that runs Linux or macOS, with 500 MB of local disk space

### Procedure

1. Access the [Infrastructure Provider](#) page on the OpenShift Cluster Manager site. If you have a Red Hat account, log in with your credentials. If you do not, create an account.
2. Select your infrastructure provider.
3. Navigate to the page for your installation type, download the installation program that corresponds with your host operating system and architecture, and place the file in the directory where you will store the installation configuration files.



#### IMPORTANT

The installation program creates several files on the computer that you use to install your cluster. You must keep the installation program and the files that the installation program creates after you finish installing the cluster. Both files are required to delete the cluster.



#### IMPORTANT

Deleting the files created by the installation program does not remove your cluster, even if the cluster failed during installation. To remove your cluster, complete the OpenShift Container Platform uninstallation procedures for your specific cloud provider.

4. Extract the installation program. For example, on a computer that uses a Linux operating system, run the following command:

```
$ tar -xvf openshift-install-linux.tar.gz
```

5. Download your installation [pull secret from the Red Hat OpenShift Cluster Manager](#) . This pull

secret allows you to authenticate with the services that are provided by the included authorities, including Quay.io, which serves the container images for OpenShift Container Platform components.

## 17.2.8. Installing the OpenShift CLI by downloading the binary

You can install the OpenShift CLI (**oc**) to interact with OpenShift Container Platform from a command-line interface. You can install **oc** on Linux, Windows, or macOS.

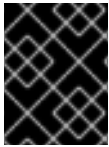

### IMPORTANT

If you installed an earlier version of **oc**, you cannot use it to complete all of the commands in OpenShift Container Platform 4.10. Download and install the new version of **oc**.

### Installing the OpenShift CLI on Linux

You can install the OpenShift CLI (**oc**) binary on Linux by using the following procedure.

#### Procedure

1. Navigate to the [OpenShift Container Platform downloads page](#) on the Red Hat Customer Portal.
2. Select the appropriate version in the **Version** drop-down menu.
3. Click **Download Now** next to the **OpenShift v4.10 Linux Client** entry and save the file.
4. Unpack the archive:

```
$ tar xvf <file>
```

5. Place the **oc** binary in a directory that is on your **PATH**.  
To check your **PATH**, execute the following command:

```
$ echo $PATH
```

After you install the OpenShift CLI, it is available using the **oc** command:

```
$ oc <command>
```

### Installing the OpenShift CLI on Windows

You can install the OpenShift CLI (**oc**) binary on Windows by using the following procedure.

#### Procedure

1. Navigate to the [OpenShift Container Platform downloads page](#) on the Red Hat Customer Portal.
2. Select the appropriate version in the **Version** drop-down menu.
3. Click **Download Now** next to the **OpenShift v4.10 Windows Client** entry and save the file.
4. Unzip the archive with a ZIP program.
5. Move the **oc** binary to a directory that is on your **PATH**.

To check your **PATH**, open the command prompt and execute the following command:

```
C:\> path
```

After you install the OpenShift CLI, it is available using the **oc** command:

```
C:\> oc <command>
```

### Installing the OpenShift CLI on macOS

You can install the OpenShift CLI (**oc**) binary on macOS by using the following procedure.

#### Procedure

1. Navigate to the [OpenShift Container Platform downloads page](#) on the Red Hat Customer Portal.
2. Select the appropriate version in the **Version** drop-down menu.
3. Click **Download Now** next to the **OpenShift v4.10 MacOSX Client** entry and save the file.
4. Unpack and unzip the archive.
5. Move the **oc** binary to a directory on your **PATH**.

To check your **PATH**, open a terminal and execute the following command:

```
$ echo $PATH
```

After you install the OpenShift CLI, it is available using the **oc** command:

```
$ oc <command>
```

### 17.2.9. Manually creating the installation configuration file

For user-provisioned installations of OpenShift Container Platform, you manually generate your installation configuration file.

#### Prerequisites

- You have an SSH public key on your local machine to provide to the installation program. The key will be used for SSH authentication onto your cluster nodes for debugging and disaster recovery.
- You have obtained the OpenShift Container Platform installation program and the pull secret for your cluster.

#### Procedure

1. Create an installation directory to store your required installation assets in:

```
$ mkdir <installation_directory>
```

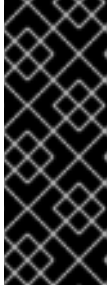
**IMPORTANT**

You must create a directory. Some installation assets, like bootstrap X.509 certificates have short expiration intervals, so you must not reuse an installation directory. If you want to reuse individual files from another cluster installation, you can copy them into your directory. However, the file names for the installation assets might change between releases. Use caution when copying installation files from an earlier OpenShift Container Platform version.

2. Customize the sample **install-config.yaml** file template that is provided and save it in the **<installation\_directory>**.

**NOTE**

You must name this configuration file **install-config.yaml**.

**NOTE**

For some platform types, you can alternatively run **./openshift-install create install-config --dir <installation\_directory>** to generate an **install-config.yaml** file. You can provide details about your cluster configuration at the prompts.

3. Back up the **install-config.yaml** file so that you can use it to install multiple clusters.

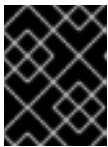
**IMPORTANT**

The **install-config.yaml** file is consumed during the next step of the installation process. You must back it up now.

**17.2.9.1. Installation configuration parameters**

Before you deploy an OpenShift Container Platform cluster, you provide a customized **install-config.yaml** installation configuration file that describes the details for your environment.

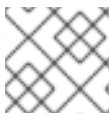
**NOTE**

After installation, you cannot modify these parameters in the **install-config.yaml** file.

**17.2.9.1.1. Required configuration parameters**

Required installation configuration parameters are described in the following table:

**Table 17.9. Required parameters**

Parameter	Description	Values
<b>apiVersion</b>	The API version for the <b>install-config.yaml</b> content. The current version is <b>v1</b> . The installer may also support older API versions.	String

Parameter	Description	Values
<b>baseDomain</b>	The base domain of your cloud provider. The base domain is used to create routes to your OpenShift Container Platform cluster components. The full DNS name for your cluster is a combination of the <b>baseDomain</b> and <b>metadata.name</b> parameter values that uses the <b>&lt;metadata.name&gt;.&lt;baseDomain&gt;</b> format.	A fully-qualified domain or subdomain name, such as <b>example.com</b> .
<b>metadata</b>	Kubernetes resource <b>ObjectMeta</b> , from which only the <b>name</b> parameter is consumed.	Object
<b>metadata.name</b>	The name of the cluster. DNS records for the cluster are all subdomains of <b>{{.metadata.name}}.{{.baseDomain}}</b> .	String of lowercase letters, hyphens (-), and periods (.), such as <b>dev</b> .
<b>platform</b>	The configuration for the specific platform upon which to perform the installation: <b>alibabacloud, aws, baremetal, azure, gcp, ibmcloud, openstack, ovirt, vsphere</b> , or <b>{}</b> . For additional information about <b>platform.&lt;platform&gt;</b> parameters, consult the table for your specific platform that follows.	Object

Parameter	Description	Values
<b>pullSecret</b>	Get a <a href="#">pull secret from the Red Hat OpenShift Cluster Manager</a> to authenticate downloading container images for OpenShift Container Platform components from services such as Quay.io.	<pre>{   "auths":{     "cloud.openshift.com":{       "auth":"b3Blb=",       "email":"you@example.com"     },     "quay.io":{       "auth":"b3Blb=",       "email":"you@example.com"     }   } }</pre>

### 17.2.9.1.2. Network configuration parameters

You can customize your installation configuration based on the requirements of your existing network infrastructure. For example, you can expand the IP address block for the cluster network or provide different IP address blocks than the defaults.

Only IPv4 addresses are supported.

Table 17.10. Network parameters

Parameter	Description	Values
<b>networking</b>	The configuration for the cluster network.	Object  <p><b>NOTE</b></p> <p>You cannot modify parameters specified by the <b>networking</b> object after installation.</p>
<b>networking.network Type</b>	The cluster network provider Container Network Interface (CNI) plugin to install.	Either <b>OpenShiftSDN</b> or <b>OVNKubernetes</b> . <b>OpenShiftSDN</b> is a CNI provider for all-Linux networks. <b>OVNKubernetes</b> is a CNI provider for Linux networks and hybrid networks that contain both Linux and Windows servers. The default value is <b>OpenShiftSDN</b> .

Parameter	Description	Values
<b>networking.clusterNetwork</b>	<p>The IP address blocks for pods.</p> <p>The default value is <b>10.128.0.0/14</b> with a host prefix of <b>/23</b>.</p> <p>If you specify multiple IP address blocks, the blocks must not overlap.</p>	<p>An array of objects. For example:</p> <pre>networking:   clusterNetwork:     - cidr: 10.128.0.0/14       hostPrefix: 23</pre>
<b>networking.clusterNetwork.cidr</b>	<p>Required if you use <b>networking.clusterNetwork</b>. An IP address block.</p> <p>An IPv4 network.</p>	<p>An IP address block in Classless Inter-Domain Routing (CIDR) notation. The prefix length for an IPv4 block is between <b>0</b> and <b>32</b>.</p>
<b>networking.clusterNetwork.hostPrefix</b>	<p>The subnet prefix length to assign to each individual node. For example, if <b>hostPrefix</b> is set to <b>23</b> then each node is assigned a <b>/23</b> subnet out of the given <b>cidr</b>. A <b>hostPrefix</b> value of <b>23</b> provides 510 (<math>2^{(32 - 23)} - 2</math>) pod IP addresses.</p>	<p>A subnet prefix.</p> <p>The default value is <b>23</b>.</p>
<b>networking.serviceNetwork</b>	<p>The IP address block for services. The default value is <b>172.30.0.0/16</b>.</p> <p>The OpenShift SDN and OVN-Kubernetes network providers support only a single IP address block for the service network.</p>	<p>An array with an IP address block in CIDR format. For example:</p> <pre>networking:   serviceNetwork:     - 172.30.0.0/16</pre>
<b>networking.machineNetwork</b>	<p>The IP address blocks for machines.</p> <p>If you specify multiple IP address blocks, the blocks must not overlap.</p> <p>If you specify multiple IP kernel arguments, the <b>machineNetwork.cidr</b> value must be the CIDR of the primary network.</p>	<p>An array of objects. For example:</p> <pre>networking:   machineNetwork:     - cidr: 10.0.0.0/16</pre>

Parameter	Description	Values
<b>networking.machineNetwork.cidr</b>	Required if you use <b>networking.machineNetwork</b> . An IP address block. The default value is <b>10.0.0.0/16</b> for all platforms other than libvirt. For libvirt, the default value is <b>192.168.126.0/24</b> .	An IP network block in CIDR notation. For example, <b>10.0.0.0/16</b> .  <b>NOTE</b> Set the <b>networking.machineNetwork</b> to match the CIDR that the preferred NIC resides in.

### 17.2.9.1.3. Optional configuration parameters

Optional installation configuration parameters are described in the following table:

Table 17.11. Optional parameters

Parameter	Description	Values
<b>additionalTrustBundle</b>	A PEM-encoded X.509 certificate bundle that is added to the nodes' trusted certificate store. This trust bundle may also be used when a proxy has been configured.	String
<b>cgroupsV2</b>	Enables <a href="#">Linux control groups version 2</a> (cgroups v2) on specific nodes in your cluster. The OpenShift Container Platform process for enabling cgroups v2 disables all cgroup version 1 controllers and hierarchies. The OpenShift Container Platform cgroups version 2 feature is in Developer Preview and is not supported by Red Hat at this time.	<b>true</b>
<b>compute</b>	The configuration for the machines that comprise the compute nodes.	Array of <b>MachinePool</b> objects.
<b>compute.architecture</b>	Determines the instruction set architecture of the machines in the pool. Currently, heterogeneous clusters are not supported, so all pools must specify the same architecture. Valid values are <b>ppc64le</b> (the default).	String





Parameter	Description	Values
<b>compute.hyperthreading</b>	<p>Whether to enable or disable simultaneous multithreading, or <b>hyperthreading</b>, on compute machines. By default, simultaneous multithreading is enabled to increase the performance of your machines' cores.</p> <div style="display: flex; align-items: center;">  <div> <p><b>IMPORTANT</b></p> <p>If you disable simultaneous multithreading, ensure that your capacity planning accounts for the dramatically decreased machine performance.</p> </div> </div>	<b>Enabled</b> or <b>Disabled</b>
<b>compute.name</b>	Required if you use <b>compute</b> . The name of the machine pool.	<b>worker</b>
<b>compute.platform</b>	Required if you use <b>compute</b> . Use this parameter to specify the cloud provider to host the worker machines. This parameter value must match the <b>controlPlane.platform</b> parameter value.	<b>alibabacloud, aws, azure, gcp, ibmcloud, openstack, ovirt, vsphere</b> , or <b>{}</b>
<b>compute.replicas</b>	The number of compute machines, which are also known as worker machines, to provision.	A positive integer greater than or equal to <b>2</b> . The default value is <b>3</b> .
<b>controlPlane</b>	The configuration for the machines that comprise the control plane.	Array of <b>MachinePool</b> objects.
<b>controlPlane.architecture</b>	Determines the instruction set architecture of the machines in the pool. Currently, heterogeneous clusters are not supported, so all pools must specify the same architecture. Valid values are <b>ppc64le</b> (the default).	String

Parameter	Description	Values
<b>controlPlane.hyperthreading</b>	<p>Whether to enable or disable simultaneous multithreading, or <b>hyperthreading</b>, on control plane machines. By default, simultaneous multithreading is enabled to increase the performance of your machines' cores.</p> <div style="display: flex; align-items: center;">  <div> <p><b>IMPORTANT</b></p> <p>If you disable simultaneous multithreading, ensure that your capacity planning accounts for the dramatically decreased machine performance.</p> </div> </div>	<b>Enabled</b> or <b>Disabled</b>
<b>controlPlane.name</b>	Required if you use <b>controlPlane</b> . The name of the machine pool.	<b>master</b>
<b>controlPlane.platform</b>	Required if you use <b>controlPlane</b> . Use this parameter to specify the cloud provider that hosts the control plane machines. This parameter value must match the <b>compute.platform</b> parameter value.	<b>alibabacloud, aws, azure, gcp, ibmcloud, openstack, ovirt, vsphere, or {}</b>
<b>controlPlane.replicas</b>	The number of control plane machines to provision.	The only supported value is <b>3</b> , which is the default value.

Parameter	Description	Values
<b>credentialsMode</b>	<p>The Cloud Credential Operator (CCO) mode. If no mode is specified, the CCO dynamically tries to determine the capabilities of the provided credentials, with a preference for mint mode on the platforms where multiple modes are supported.</p> <div data-bbox="485 510 595 860" style="border: 1px solid black; padding: 5px; margin-bottom: 10px;"> <p><b>NOTE</b></p> <p>Not all CCO modes are supported for all cloud providers. For more information on CCO modes, see the <i>Cloud Credential Operator</i> entry in the <i>Cluster Operators</i> reference content.</p> </div> <div data-bbox="485 909 595 1258" style="border: 1px solid black; padding: 5px;"> <p><b>NOTE</b></p> <p>If your AWS account has service control policies (SCP) enabled, you must configure the <b>credentialsMode</b> parameter to <b>Mint</b>, <b>Passthrough</b> or <b>Manual</b>.</p> </div>	<b>Mint, Passthrough, Manual</b> or an empty string ("").

Parameter	Description	Values
<b>fips</b>	<p>Enable or disable FIPS mode. The default is <b>false</b> (disabled). If FIPS mode is enabled, the Red Hat Enterprise Linux CoreOS (RHCOS) machines that OpenShift Container Platform runs on bypass the default Kubernetes cryptography suite and use the cryptography modules that are provided with RHCOS instead.</p> <div style="display: flex; align-items: flex-start;"> <div style="width: 20px; height: 100px; background: repeating-linear-gradient(45deg, transparent, transparent 2px, black 2px, black 4px); margin-right: 10px;"></div> <div> <p><b>IMPORTANT</b></p> <p>To enable FIPS mode for your cluster, you must run the installation program from a Red Hat Enterprise Linux (RHEL) computer configured to operate in FIPS mode. For more information about configuring FIPS mode on RHEL, see <a href="#">Installing the system in FIPS mode</a>. The use of FIPS validated or Modules In Process cryptographic libraries is only supported on OpenShift Container Platform deployments on the <b>x86_64</b> architecture.</p> </div> </div> <div style="display: flex; align-items: flex-start; margin-top: 10px;"> <div style="width: 20px; height: 40px; background: repeating-linear-gradient(45deg, transparent, transparent 2px, black 2px, black 4px); margin-right: 10px;"></div> <div> <p><b>NOTE</b></p> <p>If you are using Azure File storage, you cannot enable FIPS mode.</p> </div> </div>	<b>false</b> or <b>true</b>
<b>imageContentSources</b>	Sources and repositories for the release-image content.	Array of objects. Includes a <b>source</b> and, optionally, <b>mirrors</b> , as described in the following rows of this table.
<b>imageContentSources.source</b>	Required if you use <b>imageContentSources</b> . Specify the repository that users refer to, for example, in image pull specifications.	String

Parameter	Description	Values
<b>imageContentSources.mirrors</b>	Specify one or more repositories that may also contain the same images.	Array of strings
<b>publish</b>	How to publish or expose the user-facing endpoints of your cluster, such as the Kubernetes API, OpenShift routes.	<p><b>Internal</b> or <b>External</b>. The default value is <b>External</b>.</p> <p>Setting this field to <b>Internal</b> is not supported on non-cloud platforms and IBM Cloud VPC.</p> <div style="display: flex; align-items: flex-start;">  <div> <p><b>IMPORTANT</b></p> <p>If the value of the field is set to <b>Internal</b>, the cluster will become non-functional. For more information, refer to <a href="#">BZ#1953035</a>.</p> </div> </div>
<b>sshKey</b>	<p>The SSH key or keys to authenticate access your cluster machines.</p> <div style="display: flex; align-items: flex-start;">  <div> <p><b>NOTE</b></p> <p>For production OpenShift Container Platform clusters on which you want to perform installation debugging or disaster recovery, specify an SSH key that your <b>ssh-agent</b> process uses.</p> </div> </div>	<p>One or more keys. For example:</p> <pre>sshKey:   &lt;key1&gt;   &lt;key2&gt;   &lt;key3&gt;</pre>

### 17.2.9.2. Sample install-config.yaml file for IBM Power

You can customize the **install-config.yaml** file to specify more details about your OpenShift Container Platform cluster's platform or modify the values of the required parameters.

```
apiVersion: v1
baseDomain: example.com 1
compute: 2
- hyperthreading: Enabled 3
  name: worker
  replicas: 0 4
  architecture : ppc64le
controlPlane: 5
```

```

hyperthreading: Enabled 6
name: master
replicas: 3 7
architecture : ppc64le
metadata:
  name: test 8
networking:
  clusterNetwork:
  - cidr: 10.128.0.0/14 9
    hostPrefix: 23 10
  networkType: OpenShiftSDN
  serviceNetwork: 11
  - 172.30.0.0/16
platform:
  none: {} 12
fips: false 13
pullSecret: '{"auths": ...}' 14
sshKey: 'ssh-ed25519 AAAA...' 15

```

- 1** The base domain of the cluster. All DNS records must be sub-domains of this base and include the cluster name.
- 2** **5** The **controlPlane** section is a single mapping, but the **compute** section is a sequence of mappings. To meet the requirements of the different data structures, the first line of the **compute** section must begin with a hyphen, -, and the first line of the **controlPlane** section must not. Only one control plane pool is used.
- 3** **6** Specifies whether to enable or disable simultaneous multithreading (SMT), or hyperthreading. By default, SMT is enabled to increase the performance of the cores in your machines. You can disable it by setting the parameter value to **Disabled**. If you disable SMT, you must disable it in all cluster machines; this includes both control plane and compute machines.



#### NOTE

Simultaneous multithreading (SMT) is enabled by default. If SMT is not enabled in your BIOS settings, the **hyperthreading** parameter has no effect.



#### IMPORTANT

If you disable **hyperthreading**, whether in the BIOS or in the **install-config.yaml** file, ensure that your capacity planning accounts for the dramatically decreased machine performance.

- 4** You must set this value to **0** when you install OpenShift Container Platform on user-provisioned infrastructure. In installer-provisioned installations, the parameter controls the number of compute machines that the cluster creates and manages for you. In user-provisioned installations, you must manually deploy the compute machines before you finish installing the cluster.



#### NOTE

If you are installing a three-node cluster, do not deploy any compute machines when you install the Red Hat Enterprise Linux CoreOS (RHCOS) machines.

- 7 The number of control plane machines that you add to the cluster. Because the cluster uses these values as the number of etcd endpoints in the cluster, the value must match the number of control
- 8 The cluster name that you specified in your DNS records.
- 9 A block of IP addresses from which pod IP addresses are allocated. This block must not overlap with existing physical networks. These IP addresses are used for the pod network. If you need to access the pods from an external network, you must configure load balancers and routers to manage the traffic.



#### NOTE

Class E CIDR range is reserved for a future use. To use the Class E CIDR range, you must ensure your networking environment accepts the IP addresses within the Class E CIDR range.

- 10 The subnet prefix length to assign to each individual node. For example, if **hostPrefix** is set to **23**, then each node is assigned a **/23** subnet out of the given **cidr**, which allows for 510 ( $2^{(32 - 23)} - 2$ ) pod IP addresses. If you are required to provide access to nodes from an external network, configure load balancers and routers to manage the traffic.
- 11 The IP address pool to use for service IP addresses. You can enter only one IP address pool. This block must not overlap with existing physical networks. If you need to access the services from an external network, configure load balancers and routers to manage the traffic.
- 12 You must set the platform to **none**. You cannot provide additional platform configuration variables for IBM Power infrastructure.



#### IMPORTANT

Clusters that are installed with the platform type **none** are unable to use some features, such as managing compute machines with the Machine API. This limitation applies even if the compute machines that are attached to the cluster are installed on a platform that would normally support the feature. This parameter cannot be changed after installation.

- 13 Whether to enable or disable FIPS mode. By default, FIPS mode is not enabled. If FIPS mode is enabled, the Red Hat Enterprise Linux CoreOS (RHCOS) machines that OpenShift Container Platform runs on bypass the default Kubernetes cryptography suite and use the cryptography modules that are provided with RHCOS instead.



#### IMPORTANT

To enable FIPS mode for your cluster, you must run the installation program from a Red Hat Enterprise Linux (RHEL) computer configured to operate in FIPS mode. For more information about configuring FIPS mode on RHEL, see [Installing the system in FIPS mode](#). The use of FIPS validated or Modules In Process cryptographic libraries is only supported on OpenShift Container Platform deployments on the **x86\_64** architecture.

- 14 The [pull secret from the Red Hat OpenShift Cluster Manager](#) . This pull secret allows you to authenticate with the services that are provided by the included authorities, including Quay.io, which serves the container images for OpenShift Container Platform components.

- 15 The SSH public key for the **core** user in Red Hat Enterprise Linux CoreOS (RHCOS).



#### NOTE

For production OpenShift Container Platform clusters on which you want to perform installation debugging or disaster recovery, specify an SSH key that your **ssh-agent** process uses.

### 17.2.9.3. Configuring the cluster-wide proxy during installation

Production environments can deny direct access to the internet and instead have an HTTP or HTTPS proxy available. You can configure a new OpenShift Container Platform cluster to use a proxy by configuring the proxy settings in the **install-config.yaml** file.

#### Prerequisites

- You have an existing **install-config.yaml** file.
- You reviewed the sites that your cluster requires access to and determined whether any of them need to bypass the proxy. By default, all cluster egress traffic is proxied, including calls to hosting cloud provider APIs. You added sites to the **Proxy** object's **spec.noProxy** field to bypass the proxy if necessary.

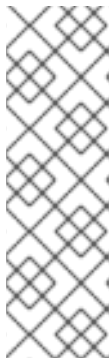

#### NOTE

The **Proxy** object **status.noProxy** field is populated with the values of the **networking.machineNetwork[].cidr**, **networking.clusterNetwork[].cidr**, and **networking.serviceNetwork[]** fields from your installation configuration.

For installations on Amazon Web Services (AWS), Google Cloud Platform (GCP), Microsoft Azure, and Red Hat OpenStack Platform (RHOSP), the **Proxy** object **status.noProxy** field is also populated with the instance metadata endpoint (**169.254.169.254**).

#### Procedure

- Edit your **install-config.yaml** file and add the proxy settings. For example:

```
apiVersion: v1
baseDomain: my.domain.com
proxy:
  httpProxy: http://<username>:<pswd>@<ip>:<port> 1
  httpsProxy: https://<username>:<pswd>@<ip>:<port> 2
  noProxy: example.com 3
  additionalTrustBundle: | 4
    -----BEGIN CERTIFICATE-----
    <MY_TRUSTED_CA_CERT>
    -----END CERTIFICATE-----
  ...
```

- A proxy URL to use for creating HTTP connections outside the cluster. The URL scheme must be **http**.



- 2 A proxy URL to use for creating HTTPS connections outside the cluster.
- 3 A comma-separated list of destination domain names, IP addresses, or other network CIDRs to exclude from proxying. Preface a domain with `.` to match subdomains only. For example, `.y.com` matches `x.y.com`, but not `y.com`. Use `*` to bypass the proxy for all destinations.
- 4 If provided, the installation program generates a config map that is named **user-ca-bundle** in the **openshift-config** namespace that contains one or more additional CA certificates that are required for proxying HTTPS connections. The Cluster Network Operator then creates a **trusted-ca-bundle** config map that merges these contents with the Red Hat Enterprise Linux CoreOS (RHCOS) trust bundle, and this config map is referenced in the **trustedCA** field of the **Proxy** object. The **additionalTrustBundle** field is required unless the proxy's identity certificate is signed by an authority from the RHCOS trust bundle.

**NOTE**

The installation program does not support the proxy **readinessEndpoints** field.

**NOTE**

If the installer times out, restart and then complete the deployment by using the **wait-for** command of the installer. For example:

```
$ ./openshift-install wait-for install-complete --log-level debug
```

2. Save the file and reference it when installing OpenShift Container Platform.

The installation program creates a cluster-wide proxy that is named **cluster** that uses the proxy settings in the provided **install-config.yaml** file. If no proxy settings are provided, a **cluster Proxy** object is still created, but it will have a nil **spec**.

**NOTE**

Only the **Proxy** object named **cluster** is supported, and no additional proxies can be created.

#### 17.2.9.4. Configuring a three-node cluster

Optionally, you can deploy zero compute machines in a bare metal cluster that consists of three control plane machines only. This provides smaller, more resource efficient clusters for cluster administrators and developers to use for testing, development, and production.

In three-node OpenShift Container Platform environments, the three control plane machines are schedulable, which means that your application workloads are scheduled to run on them.

#### Prerequisites

- You have an existing **install-config.yaml** file.

#### Procedure

- Ensure that the number of compute replicas is set to **0** in your **install-config.yaml** file, as shown in the following **compute** stanza:

```
compute:
- name: worker
  platform: {}
  replicas: 0
```

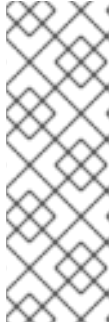

#### NOTE

You must set the value of the **replicas** parameter for the compute machines to **0** when you install OpenShift Container Platform on user-provisioned infrastructure, regardless of the number of compute machines you are deploying. In installer-provisioned installations, the parameter controls the number of compute machines that the cluster creates and manages for you. This does not apply to user-provisioned installations, where the compute machines are deployed manually.

For three-node cluster installations, follow these next steps:

- If you are deploying a three-node cluster with zero compute nodes, the Ingress Controller pods run on the control plane nodes. In three-node cluster deployments, you must configure your application ingress load balancer to route HTTP and HTTPS traffic to the control plane nodes. See the *Load balancing requirements for user-provisioned infrastructure* section for more information.
- When you create the Kubernetes manifest files in the following procedure, ensure that the **mastersSchedulable** parameter in the **<installation\_directory>/manifests/cluster-scheduler-02-config.yml** file is set to **true**. This enables your application workloads to run on the control plane nodes.
- Do not deploy any compute nodes when you create the Red Hat Enterprise Linux CoreOS (RHCOS) machines.

### 17.2.10. Cluster Network Operator configuration

The configuration for the cluster network is specified as part of the Cluster Network Operator (CNO) configuration and stored in a custom resource (CR) object that is named **cluster**. The CR specifies the fields for the **Network** API in the **operator.openshift.io** API group.

The CNO configuration inherits the following fields during cluster installation from the **Network** API in the **Network.config.openshift.io** API group and these fields cannot be changed:

#### **clusterNetwork**

IP address pools from which pod IP addresses are allocated.

#### **serviceNetwork**

IP address pool for services.

#### **defaultNetwork.type**

Cluster network provider, such as OpenShift SDN or OVN-Kubernetes.

You can specify the cluster network provider configuration for your cluster by setting the fields for the **defaultNetwork** object in the CNO object named **cluster**.

### 17.2.10.1. Cluster Network Operator configuration object

The fields for the Cluster Network Operator (CNO) are described in the following table:

Table 17.12. Cluster Network Operator configuration object

Field	Type	Description
<b>metadata.name</b>	<b>string</b>	The name of the CNO object. This name is always <b>cluster</b> .
<b>spec.clusterNetwork</b>	<b>array</b>	<p>A list specifying the blocks of IP addresses from which pod IP addresses are allocated and the subnet prefix length assigned to each individual node in the cluster. For example:</p> <pre>spec:   clusterNetwork:   - cidr: 10.128.0.0/19     hostPrefix: 23   - cidr: 10.128.32.0/19     hostPrefix: 23</pre> <p>You can customize this field only in the <b>install-config.yaml</b> file before you create the manifests. The value is read-only in the manifest file.</p>
<b>spec.serviceNetwork</b>	<b>array</b>	<p>A block of IP addresses for services. The OpenShift SDN and OVN-Kubernetes Container Network Interface (CNI) network providers support only a single IP address block for the service network. For example:</p> <pre>spec:   serviceNetwork:   - 172.30.0.0/14</pre> <p>You can customize this field only in the <b>install-config.yaml</b> file before you create the manifests. The value is read-only in the manifest file.</p>
<b>spec.defaultNetwork</b>	<b>object</b>	Configures the Container Network Interface (CNI) cluster network provider for the cluster network.
<b>spec.kubeProxy</b> <b>Config</b>	<b>object</b>	The fields for this object specify the kube-proxy configuration. If you are using the OVN-Kubernetes cluster network provider, the kube-proxy configuration has no effect.

#### defaultNetwork object configuration

The values for the **defaultNetwork** object are defined in the following table:

Table 17.13. defaultNetwork object

Field	Type	Description
<b>type</b>	<b>string</b>	<p>Either <b>OpenShiftSDN</b> or <b>OVNKubernetes</b>. The cluster network provider is selected during installation. This value cannot be changed after cluster installation.</p> <div style="display: flex; align-items: flex-start;">  <div> <p><b>NOTE</b></p> <p>OpenShift Container Platform uses the OpenShift SDN Container Network Interface (CNI) cluster network provider by default.</p> </div> </div>
<b>openshiftSDNConfig</b>	<b>object</b>	This object is only valid for the OpenShift SDN cluster network provider.
<b>ovnKubernetesConfig</b>	<b>object</b>	This object is only valid for the OVN-Kubernetes cluster network provider.

#### Configuration for the OpenShift SDN CNI cluster network provider

The following table describes the configuration fields for the OpenShift SDN Container Network Interface (CNI) cluster network provider.

**Table 17.14. openshiftSDNConfig object**

Field	Type	Description
<b>mode</b>	<b>string</b>	<p>Configures the network isolation mode for OpenShift SDN. The default value is <b>NetworkPolicy</b>.</p> <p>The values <b>Multitenant</b> and <b>Subnet</b> are available for backwards compatibility with OpenShift Container Platform 3.x but are not recommended. This value cannot be changed after cluster installation.</p>

Field	Type	Description
<b>mtu</b>	<b>integer</b>	<p>The maximum transmission unit (MTU) for the VXLAN overlay network. This is detected automatically based on the MTU of the primary network interface. You do not normally need to override the detected MTU.</p> <p>If the auto-detected value is not what you expect it to be, confirm that the MTU on the primary network interface on your nodes is correct. You cannot use this option to change the MTU value of the primary network interface on the nodes.</p> <p>If your cluster requires different MTU values for different nodes, you must set this value to <b>50</b> less than the lowest MTU value in your cluster. For example, if some nodes in your cluster have an MTU of <b>9001</b>, and some have an MTU of <b>1500</b>, you must set this value to <b>1450</b>.</p> <p>This value cannot be changed after cluster installation.</p>
<b>vxlanPort</b>	<b>integer</b>	<p>The port to use for all VXLAN packets. The default value is <b>4789</b>. This value cannot be changed after cluster installation.</p> <p>If you are running in a virtualized environment with existing nodes that are part of another VXLAN network, then you might be required to change this. For example, when running an OpenShift SDN overlay on top of VMware NSX-T, you must select an alternate port for the VXLAN, because both SDNs use the same default VXLAN port number.</p> <p>On Amazon Web Services (AWS), you can select an alternate port for the VXLAN between port <b>9000</b> and port <b>9999</b>.</p>

### Example OpenShift SDN configuration

```
defaultNetwork:
  type: OpenShiftSDN
  openshiftSDNConfig:
    mode: NetworkPolicy
    mtu: 1450
    vxlanPort: 4789
```

### Configuration for the OVN-Kubernetes CNI cluster network provider

The following table describes the configuration fields for the OVN-Kubernetes CNI cluster network provider.

Table 17.15. `ovnKubernetesConfig` object

Field	Type	Description
-------	------	-------------

Field	Type	Description
<b>mtu</b>	<b>integer</b>	<p>The maximum transmission unit (MTU) for the Geneve (Generic Network Virtualization Encapsulation) overlay network. This is detected automatically based on the MTU of the primary network interface. You do not normally need to override the detected MTU.</p> <p>If the auto-detected value is not what you expect it to be, confirm that the MTU on the primary network interface on your nodes is correct. You cannot use this option to change the MTU value of the primary network interface on the nodes.</p> <p>If your cluster requires different MTU values for different nodes, you must set this value to <b>100</b> less than the lowest MTU value in your cluster. For example, if some nodes in your cluster have an MTU of <b>9001</b>, and some have an MTU of <b>1500</b>, you must set this value to <b>1400</b>.</p>
<b>genevePort</b>	<b>integer</b>	The port to use for all Geneve packets. The default value is <b>6081</b> . This value cannot be changed after cluster installation.
<b>ipsecConfig</b>	<b>object</b>	Specify an empty object to enable IPsec encryption. This value cannot be changed after cluster installation.
<b>policyAuditConfig</b>	<b>object</b>	Specify a configuration object for customizing network policy audit logging. If unset, the defaults audit log settings are used.
<b>gatewayConfig</b>	<b>object</b>	<p>Optional: Specify a configuration object for customizing how egress traffic is sent to the node gateway.</p> <div style="display: flex; align-items: flex-start;">  <div> <p><b>NOTE</b></p> <p>While migrating egress traffic, you can expect some disruption to workloads and service traffic until the Cluster Network Operator (CNO) successfully rolls out the changes.</p> </div> </div>

Table 17.16. **policyAuditConfig** object

Field	Type	Description
<b>rateLimit</b>	integer	The maximum number of messages to generate every second per node. The default value is <b>20</b> messages per second.

Field	Type	Description
<b>maxFileSize</b>	integer	The maximum size for the audit log in bytes. The default value is <b>50000000</b> or 50 MB.
<b>destination</b>	string	One of the following additional audit log targets:  <b>libc</b> The libc <b>syslog()</b> function of the journald process on the host. <b>udp:&lt;host&gt;:&lt;port&gt;</b> A syslog server. Replace <b>&lt;host&gt;:&lt;port&gt;</b> with the host and port of the syslog server. <b>unix:&lt;file&gt;</b> A Unix Domain Socket file specified by <b>&lt;file&gt;</b> . <b>null</b> Do not send the audit logs to any additional target.
<b>syslogFacility</b>	string	The syslog facility, such as <b>kern</b> , as defined by RFC5424. The default value is <b>local0</b> .

Table 17.17. gatewayConfig object

Field	Type	Description
<b>routingViaHost</b>	<b>boolean</b>	Set this field to <b>true</b> to send egress traffic from pods to the host networking stack. For highly-specialized installations and applications that rely on manually configured routes in the kernel routing table, you might want to route egress traffic to the host networking stack. By default, egress traffic is processed in OVN to exit the cluster and is not affected by specialized routes in the kernel routing table. The default value is <b>false</b> .  This field has an interaction with the Open vSwitch hardware offloading feature. If you set this field to <b>true</b> , you do not receive the performance benefits of the offloading because egress traffic is processed by the host networking stack.

### Example OVN-Kubernetes configuration with IPsec enabled

```
defaultNetwork:
  type: OVNKubernetes
  ovnKubernetesConfig:
    mtu: 1400
    genevePort: 6081
    ipsecConfig: {}
```

### kubeProxyConfig object configuration

The values for the **kubeProxyConfig** object are defined in the following table:

Table 17.18. kubeProxyConfig object

Field	Type	Description
<b>iptablesSyncPeriod</b>	<b>string</b>	<p>The refresh period for <b>iptables</b> rules. The default value is <b>30s</b>. Valid suffixes include <b>s</b>, <b>m</b>, and <b>h</b> and are described in the <a href="#">Go time package</a> documentation.</p> <div style="display: flex; align-items: flex-start;">  <div> <p><b>NOTE</b></p> <p>Because of performance improvements introduced in OpenShift Container Platform 4.3 and greater, adjusting the <b>iptablesSyncPeriod</b> parameter is no longer necessary.</p> </div> </div>
<b>proxyArguments.iptables-min-sync-period</b>	<b>array</b>	<p>The minimum duration before refreshing <b>iptables</b> rules. This field ensures that the refresh does not happen too frequently. Valid suffixes include <b>s</b>, <b>m</b>, and <b>h</b> and are described in the <a href="#">Go time package</a>. The default value is:</p> <pre>kubeProxyConfig:   proxyArguments:     iptables-min-sync-period:       - 0s</pre>

### 17.2.11. Creating the Kubernetes manifest and Ignition config files

Because you must modify some cluster definition files and manually start the cluster machines, you must generate the Kubernetes manifest and Ignition config files that the cluster needs to configure the machines.

The installation configuration file transforms into the Kubernetes manifests. The manifests wrap into the Ignition configuration files, which are later used to configure the cluster machines.



#### IMPORTANT

- The Ignition config files that the OpenShift Container Platform installation program generates contain certificates that expire after 24 hours, which are then renewed at that time. If the cluster is shut down before renewing the certificates and the cluster is later restarted after the 24 hours have elapsed, the cluster automatically recovers the expired certificates. The exception is that you must manually approve the pending **node-bootstrapper** certificate signing requests (CSRs) to recover kubelet certificates. See the documentation for *Recovering from expired control plane certificates* for more information.
- It is recommended that you use Ignition config files within 12 hours after they are generated because the 24-hour certificate rotates from 16 to 22 hours after the cluster is installed. By using the Ignition config files within 12 hours, you can avoid installation failure if the certificate update runs during installation.





## NOTE

The installation program that generates the manifest and Ignition files is architecture specific and can be obtained from the [client image mirror](#). The Linux version of the installation program runs on ppc64le only. This installer program is also available as a Mac OS version.

## Prerequisites

- You obtained the OpenShift Container Platform installation program.
- You created the **install-config.yaml** installation configuration file.

## Procedure

1. Change to the directory that contains the OpenShift Container Platform installation program and generate the Kubernetes manifests for the cluster:

```
$ ./openshift-install create manifests --dir <installation_directory> 1
```

- 1** For **<installation\_directory>**, specify the installation directory that contains the **install-config.yaml** file you created.



## WARNING

If you are installing a three-node cluster, skip the following step to allow the control plane nodes to be schedulable.



## IMPORTANT

When you configure control plane nodes from the default unschedulable to schedulable, additional subscriptions are required. This is because control plane nodes then become worker nodes.

2. Check that the **mastersSchedulable** parameter in the **<installation\_directory>/manifests/cluster-scheduler-02-config.yml** Kubernetes manifest file is set to **false**. This setting prevents pods from being scheduled on the control plane machines:
  - a. Open the **<installation\_directory>/manifests/cluster-scheduler-02-config.yml** file.
  - b. Locate the **mastersSchedulable** parameter and ensure that it is set to **false**.
  - c. Save and exit the file.
3. To create the Ignition configuration files, run the following command from the directory that contains the installation program:

```
$ ./openshift-install create ignition-configs --dir <installation_directory> 1
```

- 1 For `<installation_directory>`, specify the same installation directory.

Ignition config files are created for the bootstrap, control plane, and compute nodes in the installation directory. The **kubeadmin-password** and **kubeconfig** files are created in the `./<installation_directory>/auth` directory:

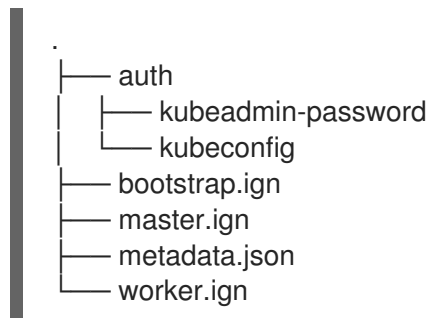

## 17.2.12. Installing RHCOS and starting the OpenShift Container Platform bootstrap process

To install OpenShift Container Platform on IBM Power infrastructure that you provision, you must install Red Hat Enterprise Linux CoreOS (RHCOS) on the machines. When you install RHCOS, you must provide the Ignition config file that was generated by the OpenShift Container Platform installation program for the type of machine you are installing. If you have configured suitable networking, DNS, and load balancing infrastructure, the OpenShift Container Platform bootstrap process begins automatically after the RHCOS machines have rebooted.

Follow either the steps to use an ISO image or network PXE booting to install RHCOS on the machines.

### 17.2.12.1. Installing RHCOS by using an ISO image

You can use an ISO image to install RHCOS on the machines.

#### Prerequisites

- You have created the Ignition config files for your cluster.
- You have configured suitable network, DNS and load balancing infrastructure.
- You have an HTTP server that can be accessed from your computer, and from the machines that you create.
- You have reviewed the *Advanced RHCOS installation configuration* section for different ways to configure features, such as networking and disk partitioning.

#### Procedure

1. Obtain the SHA512 digest for each of your Ignition config files. For example, you can use the following on a system running Linux to get the SHA512 digest for your **bootstrap.ign** Ignition config file:

```
$ sha512sum <installation_directory>/bootstrap.ign
```

The digests are provided to the **coreos-installer** in a later step to validate the authenticity of the Ignition config files on the cluster nodes.

- Upload the bootstrap, control plane, and compute node Ignition config files that the installation program created to your HTTP server. Note the URLs of these files.

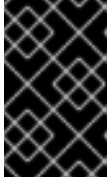

### IMPORTANT

You can add or change configuration settings in your Ignition configs before saving them to your HTTP server. If you plan to add more compute machines to your cluster after you finish installation, do not delete these files.

- From the installation host, validate that the Ignition config files are available on the URLs. The following example gets the Ignition config file for the bootstrap node:

```
$ curl -k http://<HTTP_server>/bootstrap.ign 1
```

### Example output

```
% Total % Received % Xferd Average Speed Time Time Time Current
          Dload Upload Total Spent Left Speed
 0  0  0  0  0  0  0  0  --:--:-- --:--:-- --:--:-- 0{"ignition":
{"version":"3.2.0"}, "passwd":{"users":[{"name":"core", "sshAuthorizedKeys":["ssh-rsa...
```

Replace **bootstrap.ign** with **master.ign** or **worker.ign** in the command to validate that the Ignition config files for the control plane and compute nodes are also available.

- Although it is possible to obtain the RHCOS images that are required for your preferred method of installing operating system instances from the [RHCOS image mirror](#) page, the recommended way to obtain the correct version of your RHCOS images are from the output of **openshift-install** command:

```
$ openshift-install coreos print-stream-json | grep '\.iso[^\.]'
```

### Example output

```
"location": "<url>/art/storage/releases/rhcos-4.10-aarch64/<release>/aarch64/rhcos-
<release>-live.aarch64.iso",
"location": "<url>/art/storage/releases/rhcos-4.10-ppc64le/<release>/ppc64le/rhcos-
<release>-live.ppc64le.iso",
"location": "<url>/art/storage/releases/rhcos-4.10-s390x/<release>/s390x/rhcos-<release>-
live.s390x.iso",
"location": "<url>/art/storage/releases/rhcos-4.10/<release>/x86_64/rhcos-<release>-
live.x86_64.iso",
```

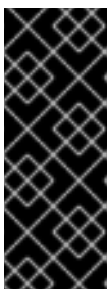

### IMPORTANT

The RHCOS images might not change with every release of OpenShift Container Platform. You must download images with the highest version that is less than or equal to the OpenShift Container Platform version that you install. Use the image versions that match your OpenShift Container Platform version if they are available. Use only ISO images for this procedure. RHCOS qcow2 images are not supported for this installation type.

ISO file names resemble the following example:

**rhcos-<version>-live.<architecture>.iso**

5. Use the ISO to start the RHCOS installation. Use one of the following installation options:
  - Burn the ISO image to a disk and boot it directly.
  - Use ISO redirection by using a lights-out management (LOM) interface.
6. Boot the RHCOS ISO image without specifying any options or interrupting the live boot sequence. Wait for the installer to boot into a shell prompt in the RHCOS live environment.

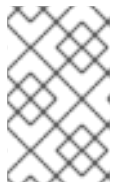
**NOTE**

It is possible to interrupt the RHCOS installation boot process to add kernel arguments. However, for this ISO procedure you should use the **coreos-installer** command as outlined in the following steps, instead of adding kernel arguments.

7. Run the **coreos-installer** command and specify the options that meet your installation requirements. At a minimum, you must specify the URL that points to the Ignition config file for the node type, and the device that you are installing to:

```
$ sudo coreos-installer install --ignition-url=http://<HTTP_server>/<node_type>.ign <device>
--ignition-hash=sha512-<digest> 1 2
```

**1 1** You must run the **coreos-installer** command by using **sudo**, because the **core** user does not have the required root privileges to perform the installation.

**2** The **--ignition-hash** option is required when the Ignition config file is obtained through an HTTP URL to validate the authenticity of the Ignition config file on the cluster node. **<digest>** is the Ignition config file SHA512 digest obtained in a preceding step.

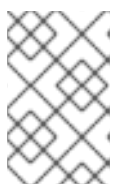
**NOTE**

If you want to provide your Ignition config files through an HTTPS server that uses TLS, you can add the internal certificate authority (CA) to the system trust store before running **coreos-installer**.

The following example initializes a bootstrap node installation to the **/dev/sda** device. The Ignition config file for the bootstrap node is obtained from an HTTP web server with the IP address 192.168.1.2:

```
$ sudo coreos-installer install --ignition-
url=http://192.168.1.2:80/installation_directory/bootstrap.ign /dev/sda --ignition-hash=sha512-
a5a2d43879223273c9b60af66b44202a1d1248fc01cf156c46d4a79f552b6bad47bc8cc78ddf011
6e80c59d2ea9e32ba53bc807afbca581aa059311def2c3e3b
```

8. Monitor the progress of the RHCOS installation on the console of the machine.



## IMPORTANT

Be sure that the installation is successful on each node before commencing with the OpenShift Container Platform installation. Observing the installation process can also help to determine the cause of RHCOS installation issues that might arise.

9. After RHCOS installs, you must reboot the system. During the system reboot, it applies the Ignition config file that you specified.
10. Check the console output to verify that Ignition ran.

### Example command

```
Ignition: ran on 2022/03/14 14:48:33 UTC (this boot)
Ignition: user-provided config was applied
```

11. Continue to create the other machines for your cluster.



## IMPORTANT

You must create the bootstrap and control plane machines at this time. If the control plane machines are not made schedulable, also create at least two compute machines before you install OpenShift Container Platform.

If the required network, DNS, and load balancer infrastructure are in place, the OpenShift Container Platform bootstrap process begins automatically after the RHCOS nodes have rebooted.



## NOTE

RHCOS nodes do not include a default password for the **core** user. You can access the nodes by running **ssh core@<node>.<cluster\_name>.<base\_domain>** as a user with access to the SSH private key that is paired to the public key that you specified in your **install\_config.yaml** file. OpenShift Container Platform 4 cluster nodes running RHCOS are immutable and rely on Operators to apply cluster changes. Accessing cluster nodes by using SSH is not recommended. However, when investigating installation issues, if the OpenShift Container Platform API is not available, or the kubelet is not properly functioning on a target node, SSH access might be required for debugging or disaster recovery.

### 17.2.12.1.1. Advanced RHCOS installation reference

This section illustrates the networking configuration and other advanced options that allow you to modify the Red Hat Enterprise Linux CoreOS (RHCOS) manual installation process. The following tables describe the kernel arguments and command-line options you can use with the RHCOS live installer and the **coreos-installer** command.

#### 17.2.12.1.1.1. Networking and bonding options for ISO installations

If you install RHCOS from an ISO image, you can add kernel arguments manually when you boot the image to configure networking for a node. If no networking arguments are specified, DHCP is activated in the initramfs when RHCOS detects that networking is required to fetch the Ignition config file.

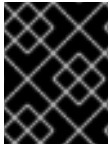
**IMPORTANT**

When adding networking arguments manually, you must also add the **rd.neednet=1** kernel argument to bring the network up in the initramfs.

The following table provides examples for configuring networking and bonding on your RHCOS nodes for ISO installations. The examples describe how to use the **ip=**, **nameserver=**, and **bond=** kernel arguments.

**NOTE**

Ordering is important when adding the kernel arguments: **ip=**, **nameserver=**, and then **bond=**.

The networking options are passed to the **dracut** tool during system boot. For more information about the networking options supported by **dracut**, see the **dracut.cmdline** manual page.

The following examples are the networking options for ISO installation.

## Configuring DHCP or static IP addresses

To configure an IP address, either use DHCP (**ip=dhcp**) or set an individual static IP address (**ip=<host\_ip>**). If setting a static IP, you must then identify the DNS server IP address (**nameserver=<dns\_ip>**) on each node. The following example sets:

- The node's IP address to **10.10.10.2**
- The gateway address to **10.10.10.254**
- The netmask to **255.255.255.0**
- The hostname to **core0.example.com**
- The DNS server address to **4.4.4.41**
- The auto-configuration value to **none**. No auto-configuration is required when IP networking is configured statically.

```
ip=10.10.10.2::10.10.10.254:255.255.255.0:core0.example.com:enp1s0:none
nameserver=4.4.4.41
```

**NOTE**

When you use DHCP to configure IP addressing for the RHCOS machines, the machines also obtain the DNS server information through DHCP. For DHCP-based deployments, you can define the DNS server address that is used by the RHCOS nodes through your DHCP server configuration.

## Configuring an IP address without a static hostname

You can configure an IP address without assigning a static hostname. If a static hostname is not set by the user, it will be picked up and automatically set by a reverse DNS lookup. To configure an IP address without a static hostname refer to the following example:

- The node's IP address to **10.10.10.2**

- The gateway address to **10.10.10.254**
- The netmask to **255.255.255.0**
- The DNS server address to **4.4.4.41**
- The auto-configuration value to **none**. No auto-configuration is required when IP networking is configured statically.

```
ip=10.10.10.2::10.10.10.254:255.255.255.0::enp1s0:none
nameserver=4.4.4.41
```

#### Specifying multiple network interfaces

You can specify multiple network interfaces by setting multiple **ip=** entries.

```
ip=10.10.10.2::10.10.10.254:255.255.255.0:core0.example.com:enp1s0:none
ip=10.10.10.3::10.10.10.254:255.255.255.0:core0.example.com:enp2s0:none
```

#### Configuring default gateway and route

Optional: You can configure routes to additional networks by setting an **rd.route=** value.



#### NOTE

When you configure one or multiple networks, one default gateway is required. If the additional network gateway is different from the primary network gateway, the default gateway must be the primary network gateway.

- Run the following command to configure the default gateway:

```
ip=::10.10.10.254:::
```

- Enter the following command to configure the route for the additional network:

```
rd.route=20.20.20.0/24:20.20.20.254:enp2s0
```

#### Disabling DHCP on a single interface

You can disable DHCP on a single interface, such as when there are two or more network interfaces and only one interface is being used. In the example, the **enp1s0** interface has a static networking configuration and DHCP is disabled for **enp2s0**, which is not used:

```
ip=10.10.10.2::10.10.10.254:255.255.255.0:core0.example.com:enp1s0:none
ip=::::core0.example.com:enp2s0:none
```

#### Combining DHCP and static IP configurations

You can combine DHCP and static IP configurations on systems with multiple network interfaces, for example:

```
ip=enp1s0:dhcp
ip=10.10.10.2::10.10.10.254:255.255.255.0:core0.example.com:enp2s0:none
```

#### Configuring VLANs on individual interfaces

Optional: You can configure VLANs on individual interfaces by using the **vlan=** parameter.

- To configure a VLAN on a network interface and use a static IP address, run the following command:

```
ip=10.10.10.2::10.10.10.254:255.255.255.0:core0.example.com:enp2s0.100:none
vlan=enp2s0.100:enp2s0
```

- To configure a VLAN on a network interface and to use DHCP, run the following command:

```
ip=enp2s0.100:dhcp
vlan=enp2s0.100:enp2s0
```

#### Providing multiple DNS servers

You can provide multiple DNS servers by adding a **nameserver=** entry for each server, for example:

```
nameserver=1.1.1.1
nameserver=8.8.8.8
```

#### Bonding multiple network interfaces to a single interface

Optional: You can bond multiple network interfaces to a single interface by using the **bond=** option. Refer to the following examples:

- The syntax for configuring a bonded interface is: **bond=name[:network\_interfaces][:options]** *name* is the bonding device name (**bond0**), *network\_interfaces* represents a comma-separated list of physical (ethernet) interfaces (**em1,em2**), and *options* is a comma-separated list of bonding options. Enter **modinfo bonding** to see available options.
- When you create a bonded interface using **bond=**, you must specify how the IP address is assigned and other information for the bonded interface.
- To configure the bonded interface to use DHCP, set the bond's IP address to **dhcp**. For example:

```
bond=bond0:em1,em2:mode=active-backup
ip=bond0:dhcp
```

- To configure the bonded interface to use a static IP address, enter the specific IP address you want and related information. For example:

```
bond=bond0:em1,em2:mode=active-backup
ip=10.10.10.2::10.10.10.254:255.255.255.0:core0.example.com:bond0:none
```

#### Bonding multiple network interfaces to a single interface

Optional: You can configure VLANs on bonded interfaces by using the **vlan=** parameter and to use DHCP, for example:

```
ip=bond0.100:dhcp
bond=bond0:em1,em2:mode=active-backup
vlan=bond0.100:bond0
```

Use the following example to configure the bonded interface with a VLAN and to use a static IP address:



```
ip=10.10.10.2::10.10.10.254:255.255.255.0:core0.example.com:bond0.100:none
bond=bond0:em1,em2:mode=active-backup
vlan=bond0.100:bond0
```

Using network teaming

Optional: You can use a network teaming as an alternative to bonding by using the **team=** parameter:

- The syntax for configuring a team interface is: **team=name[:network\_interfaces]**  
*name* is the team device name (**team0**) and *network\_interfaces* represents a comma-separated list of physical (ethernet) interfaces (**em1, em2**).

Teaming is planned to be deprecated when RHCOS switches to an upcoming version of RHEL. For more information, see this [Red Hat Knowledgebase Article](#) .

Use the following example to configure a network team:

```
team=team0:em1,em2
ip=team0:dhcp
```

### 17.2.12.2. Installing RHCOS by using PXE booting

You can use PXE booting to install RHCOS on the machines.

#### Prerequisites

- You have created the Ignition config files for your cluster.
- You have configured suitable network, DNS and load balancing infrastructure.
- You have configured suitable PXE infrastructure.
- You have an HTTP server that can be accessed from your computer, and from the machines that you create.
- You have reviewed the *Advanced RHCOS installation configuration* section for different ways to configure features, such as networking and disk partitioning.

#### Procedure

1. Upload the bootstrap, control plane, and compute node Ignition config files that the installation program created to your HTTP server. Note the URLs of these files.



#### IMPORTANT

You can add or change configuration settings in your Ignition configs before saving them to your HTTP server. If you plan to add more compute machines to your cluster after you finish installation, do not delete these files.

2. From the installation host, validate that the Ignition config files are available on the URLs. The following example gets the Ignition config file for the bootstrap node:

```
$ curl -k http://<HTTP_server>/bootstrap.ign 1
```

## Example output

```
% Total   % Received % Xferd  Average Speed   Time    Time     Time  Current
           Dload  Upload  Total   Spent    Left  Speed
  0   0   0   0   0   0   0   0  --:--:--  --:--:--  --:--:--    0{"ignition":
{"version":"3.2.0"},"passwd":{"users":[{"name":"core","sshAuthorizedKeys":["ssh-rsa...
```

Replace **bootstrap.ign** with **master.ign** or **worker.ign** in the command to validate that the Ignition config files for the control plane and compute nodes are also available.

- Although it is possible to obtain the RHCOS **kernel**, **initramfs** and **rootfs** files that are required for your preferred method of installing operating system instances from the [RHCOS image mirror](#)[RHCOS image mirror](#) page, the recommended way to obtain the correct version of your RHCOS files are from the output of **openshift-install** command:

```
$ openshift-install coreos print-stream-json | grep -Eo "https.*(kernel-|initramfs-|rootfs-)|w+(\.img)?"
```

## Example output

```
"<url>/art/storage/releases/rhcos-4.10-aarch64/<release>/aarch64/rhcos-<release>-live-
kernel-aarch64"
"<url>/art/storage/releases/rhcos-4.10-aarch64/<release>/aarch64/rhcos-<release>-live-
initramfs.aarch64.img"
"<url>/art/storage/releases/rhcos-4.10-aarch64/<release>/aarch64/rhcos-<release>-live-
rootfs.aarch64.img"
"<url>/art/storage/releases/rhcos-4.10-ppc64le/49.84.202110081256-0/ppc64le/rhcos-
<release>-live-kernel-ppc64le"
"<url>/art/storage/releases/rhcos-4.10-ppc64le/<release>/ppc64le/rhcos-<release>-live-
initramfs.ppc64le.img"
"<url>/art/storage/releases/rhcos-4.10-ppc64le/<release>/ppc64le/rhcos-<release>-live-
rootfs.ppc64le.img"
"<url>/art/storage/releases/rhcos-4.10-s390x/<release>/s390x/rhcos-<release>-live-kernel-
s390x"
"<url>/art/storage/releases/rhcos-4.10-s390x/<release>/s390x/rhcos-<release>-live-
initramfs.s390x.img"
"<url>/art/storage/releases/rhcos-4.10-s390x/<release>/s390x/rhcos-<release>-live-
rootfs.s390x.img"
"<url>/art/storage/releases/rhcos-4.10/<release>/x86_64/rhcos-<release>-live-kernel-
x86_64"
"<url>/art/storage/releases/rhcos-4.10/<release>/x86_64/rhcos-<release>-live-
initramfs.x86_64.img"
"<url>/art/storage/releases/rhcos-4.10/<release>/x86_64/rhcos-<release>-live-
rootfs.x86_64.img"
```



### IMPORTANT

The RHCOS artifacts might not change with every release of OpenShift Container Platform. You must download images with the highest version that is less than or equal to the OpenShift Container Platform version that you install. Only use the appropriate **kernel**, **initramfs**, and **rootfs** artifacts described below for this procedure. RHCOS QCOW2 images are not supported for this installation type.

The file names contain the OpenShift Container Platform version number. They resemble the following examples:

- **kernel:** `rhcos-<version>-live-kernel-<architecture>`
- **initramfs:** `rhcos-<version>-live-initramfs.<architecture>.img`
- **rootfs:** `rhcos-<version>-live-rootfs.<architecture>.img`

4. Upload the **rootfs**, **kernel**, and **initramfs** files to your HTTP server.



### IMPORTANT

If you plan to add more compute machines to your cluster after you finish installation, do not delete these files.

5. Configure the network boot infrastructure so that the machines boot from their local disks after RHCOS is installed on them.
6. Configure PXE installation for the RHCOS images and begin the installation. Modify the following example menu entry for your environment and verify that the image and Ignition files are properly accessible:

```

DEFAULT pxeboot
TIMEOUT 20
PROMPT 0
LABEL pxeboot
  KERNEL http://<HTTP_server>/rhcos-<version>-live-kernel-<architecture> 1
  APPEND initrd=http://<HTTP_server>/rhcos-<version>-live-initramfs.<architecture>.img
  coreos.live.rootfs_url=http://<HTTP_server>/rhcos-<version>-live-rootfs.<architecture>.img
  coreos.inst.install_dev=/dev/sda coreos.inst.ignition_url=http://<HTTP_server>/bootstrap.ign
2 3

```

- 1** Specify the location of the live **kernel** file that you uploaded to your HTTP server. The URL must be HTTP, TFTP, or FTP; HTTPS and NFS are not supported.
- 2** If you use multiple NICs, specify a single interface in the **ip** option. For example, to use DHCP on a NIC that is named **eno1**, set **ip=eno1:dhcp**.
- 3** Specify the locations of the RHCOS files that you uploaded to your HTTP server. The **initrd** parameter value is the location of the **initramfs** file, the **coreos.live.rootfs\_url** parameter value is the location of the **rootfs** file, and the **coreos.inst.ignition\_url** parameter value is the location of the bootstrap Ignition config file. You can also add more kernel arguments to the **APPEND** line to configure networking or other boot options.



### NOTE

This configuration does not enable serial console access on machines with a graphical console. To configure a different console, add one or more **console=** arguments to the **APPEND** line. For example, add **console=tty0 console=ttyS0** to set the first PC serial port as the primary console and the graphical console as a secondary console. For more information, see [How does one set up a serial terminal and/or console in Red Hat Enterprise Linux?](#).

7. Monitor the progress of the RHCOS installation on the console of the machine.

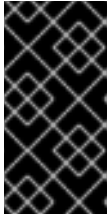

### IMPORTANT

Be sure that the installation is successful on each node before commencing with the OpenShift Container Platform installation. Observing the installation process can also help to determine the cause of RHCOS installation issues that might arise.

8. After RHCOS installs, the system reboots. During reboot, the system applies the Ignition config file that you specified.
9. Check the console output to verify that Ignition ran.

### Example command

```
Ignition: ran on 2022/03/14 14:48:33 UTC (this boot)
Ignition: user-provided config was applied
```

10. Continue to create the machines for your cluster.

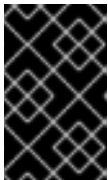

### IMPORTANT

You must create the bootstrap and control plane machines at this time. If the control plane machines are not made schedulable, also create at least two compute machines before you install the cluster.

If the required network, DNS, and load balancer infrastructure are in place, the OpenShift Container Platform bootstrap process begins automatically after the RHCOS nodes have rebooted.



### NOTE

RHCOS nodes do not include a default password for the **core** user. You can access the nodes by running **ssh core@<node>.<cluster\_name>.<base\_domain>** as a user with access to the SSH private key that is paired to the public key that you specified in your **install\_config.yaml** file. OpenShift Container Platform 4 cluster nodes running RHCOS are immutable and rely on Operators to apply cluster changes. Accessing cluster nodes by using SSH is not recommended. However, when investigating installation issues, if the OpenShift Container Platform API is not available, or the kubelet is not properly functioning on a target node, SSH access might be required for debugging or disaster recovery.

#### 17.2.12.3. Enabling multipathing with kernel arguments on RHCOS

In OpenShift Container Platform 4.9 or later, during installation, you can enable multipathing for provisioned nodes. RHCOS supports multipathing on the primary disk. Multipathing provides added benefits of stronger resilience to hardware failure to achieve higher host availability.

During the initial cluster creation, you might want to add kernel arguments to all master or worker nodes. To add kernel arguments to master or worker nodes, you can create a **MachineConfig** object and inject that object into the set of manifest files used by Ignition during cluster setup.

## Procedure

1. Change to the directory that contains the installation program and generate the Kubernetes manifests for the cluster:

```
$ ./openshift-install create manifests --dir <installation_directory>
```

2. Decide if you want to add kernel arguments to worker or control plane nodes.
  - Create a machine config file. For example, create a **99-master-kargs-mpath.yaml** that instructs the cluster to add the **master** label and identify the multipath kernel argument:

```
apiVersion: machineconfiguration.openshift.io/v1
kind: MachineConfig
metadata:
  labels:
    machineconfiguration.openshift.io/role: "master"
  name: 99-master-kargs-mpath
spec:
  kernelArguments:
    - 'rd.multipath=default'
    - 'root=/dev/disk/by-label/dm-mpath-root'
```

3. To enable multipathing post-installation on worker nodes:
  - Create a machine config file. For example, create a **99-worker-kargs-mpath.yaml** that instructs the cluster to add the **worker** label and identify the multipath kernel argument:

```
apiVersion: machineconfiguration.openshift.io/v1
kind: MachineConfig
metadata:
  labels:
    machineconfiguration.openshift.io/role: "worker"
  name: 99-worker-kargs-mpath
spec:
  kernelArguments:
    - 'rd.multipath=default'
    - 'root=/dev/disk/by-label/dm-mpath-root'
```

You can now continue on to create the cluster.



### IMPORTANT

Additional post-installation steps are required to fully enable multipathing. For more information, see “Enabling multipathing with kernel arguments on RHCOS” in *Post-installation machine configuration tasks*.

In case of MPIO failure, use the `bootlist` command to update the boot device list with alternate logical device names. The command displays a boot list and it designates the possible boot devices for when the system is booted in normal mode.

- a. To display a boot list and specify the possible boot devices if the system is booted in normal mode, enter the following command:

```
$ bootlist -m normal -o  
sda
```

- b. To update the boot list for normal mode and add alternate device names, enter the following command:

```
$ bootlist -m normal -o /dev/sdc /dev/sdd /dev/sde  
sdc  
sdd  
sde
```

If the original boot disk path is down, the node reboots from the alternate device registered in the normal boot device list.

### 17.2.13. Waiting for the bootstrap process to complete

The OpenShift Container Platform bootstrap process begins after the cluster nodes first boot into the persistent RHCOS environment that has been installed to disk. The configuration information provided through the Ignition config files is used to initialize the bootstrap process and install OpenShift Container Platform on the machines. You must wait for the bootstrap process to complete.

#### Prerequisites

- You have created the Ignition config files for your cluster.
- You have configured suitable network, DNS and load balancing infrastructure.
- You have obtained the installation program and generated the Ignition config files for your cluster.
- You installed RHCOS on your cluster machines and provided the Ignition config files that the OpenShift Container Platform installation program generated.
- Your machines have direct internet access or have an HTTP or HTTPS proxy available.

#### Procedure

1. Monitor the bootstrap process:

```
$ ./openshift-install --dir <installation_directory> wait-for bootstrap-complete \ 1  
--log-level=info 2
```

- 1** For **<installation\_directory>**, specify the path to the directory that you stored the installation files in.

- 2** To view different installation details, specify **warn**, **debug**, or **error** instead of **info**.

#### Example output

```
INFO Waiting up to 30m0s for the Kubernetes API at https://api.test.example.com:6443...  
INFO API v1.23.0 up  
INFO Waiting up to 30m0s for bootstrapping to complete...  
INFO It is now safe to remove the bootstrap resources
```

The command succeeds when the Kubernetes API server signals that it has been bootstrapped on the control plane machines.

2. After bootstrap process is complete, remove the bootstrap machine from the load balancer.

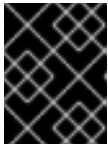

### IMPORTANT

You must remove the bootstrap machine from the load balancer at this point. You can also remove or reformat the bootstrap machine itself.

## 17.2.14. Logging in to the cluster by using the CLI

You can log in to your cluster as a default system user by exporting the cluster **kubeconfig** file. The **kubeconfig** file contains information about the cluster that is used by the CLI to connect a client to the correct cluster and API server. The file is specific to a cluster and is created during OpenShift Container Platform installation.

### Prerequisites

- You deployed an OpenShift Container Platform cluster.
- You installed the **oc** CLI.

### Procedure

1. Export the **kubeadmin** credentials:

```
$ export KUBECONFIG=<installation_directory>/auth/kubeconfig 1
```

- 1 For **<installation\_directory>**, specify the path to the directory that you stored the installation files in.

2. Verify you can run **oc** commands successfully using the exported configuration:

```
$ oc whoami
```

### Example output

```
system:admin
```

## 17.2.15. Approving the certificate signing requests for your machines

When you add machines to a cluster, two pending certificate signing requests (CSRs) are generated for each machine that you added. You must confirm that these CSRs are approved or, if necessary, approve them yourself. The client requests must be approved first, followed by the server requests.

### Prerequisites

- You added machines to your cluster.

### Procedure

1. Confirm that the cluster recognizes the machines:

```
$ oc get nodes
```

### Example output

```
NAME      STATUS    ROLES    AGE   VERSION
master-0  Ready     master   63m   v1.23.0
master-1  Ready     master   63m   v1.23.0
master-2  Ready     master   64m   v1.23.0
```

The output lists all of the machines that you created.



### NOTE

The preceding output might not include the compute nodes, also known as worker nodes, until some CSRs are approved.

2. Review the pending CSRs and ensure that you see the client requests with the **Pending** or **Approved** status for each machine that you added to the cluster:

```
$ oc get csr
```

### Example output

```
NAME      AGE   REQUESTOR                                     CONDITION
csr-8b2br  15m   system:serviceaccount:openshift-machine-config-operator:node-
bootstrapper  Pending
csr-8vnps  15m   system:serviceaccount:openshift-machine-config-operator:node-
bootstrapper  Pending
...
```

In this example, two machines are joining the cluster. You might see more approved CSRs in the list.

3. If the CSRs were not approved, after all of the pending CSRs for the machines you added are in **Pending** status, approve the CSRs for your cluster machines:



### NOTE

Because the CSRs rotate automatically, approve your CSRs within an hour of adding the machines to the cluster. If you do not approve them within an hour, the certificates will rotate, and more than two certificates will be present for each node. You must approve all of these certificates. After the client CSR is approved, the Kubelet creates a secondary CSR for the serving certificate, which requires manual approval. Then, subsequent serving certificate renewal requests are automatically approved by the **machine-approver** if the Kubelet requests a new certificate with identical parameters.



**NOTE**

For clusters running on platforms that are not machine API enabled, such as bare metal and other user-provisioned infrastructure, you must implement a method of automatically approving the kubelet serving certificate requests (CSRs). If a request is not approved, then the **oc exec**, **oc rsh**, and **oc logs** commands cannot succeed, because a serving certificate is required when the API server connects to the kubelet. Any operation that contacts the Kubelet endpoint requires this certificate approval to be in place. The method must watch for new CSRs, confirm that the CSR was submitted by the **node-bootstrap** service account in the **system:node** or **system:admin** groups, and confirm the identity of the node.

- To approve them individually, run the following command for each valid CSR:

```
$ oc adm certificate approve <csr_name> 1
```

- 1** **<csr\_name>** is the name of a CSR from the list of current CSRs.

- To approve all pending CSRs, run the following command:

```
$ oc get csr -o go-template='{{range .items}}{{if not .status}}{{.metadata.name}}{"\n"}\n{{end}}{{end}}' | xargs --no-run-if-empty oc adm certificate approve
```

**NOTE**

Some Operators might not become available until some CSRs are approved.

4. Now that your client requests are approved, you must review the server requests for each machine that you added to the cluster:

```
$ oc get csr
```

**Example output**

```
NAME      AGE   REQUESTOR                                     CONDITION
csr-bfd72 5m26s system:node:ip-10-0-50-126.us-east-2.compute.internal
Pending
csr-c57lv 5m26s system:node:ip-10-0-95-157.us-east-2.compute.internal
Pending
...
```

5. If the remaining CSRs are not approved, and are in the **Pending** status, approve the CSRs for your cluster machines:

- To approve them individually, run the following command for each valid CSR:

```
$ oc adm certificate approve <csr_name> 1
```

- 1** **<csr\_name>** is the name of a CSR from the list of current CSRs.

- To approve all pending CSRs, run the following command:

```
$ oc get csr -o go-template='{{range .items}}{{if not .status}}{{.metadata.name}}{\n"}\n{{end}}\n{{end}}' | xargs oc adm certificate approve
```

6. After all client and server CSRs have been approved, the machines have the **Ready** status. Verify this by running the following command:

```
$ oc get nodes
```

### Example output

```
NAME      STATUS  ROLES  AGE  VERSION
master-0  Ready   master 73m  v1.23.0
master-1  Ready   master 73m  v1.23.0
master-2  Ready   master 74m  v1.23.0
worker-0  Ready   worker 11m  v1.23.0
worker-1  Ready   worker 11m  v1.23.0
```

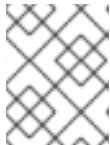

### NOTE

It can take a few minutes after approval of the server CSRs for the machines to transition to the **Ready** status.

### Additional information

- For more information on CSRs, see [Certificate Signing Requests](#).

## 17.2.16. Initial Operator configuration

After the control plane initializes, you must immediately configure some Operators so that they all become available.

### Prerequisites

- Your control plane has initialized.

### Procedure

1. Watch the cluster components come online:

```
$ watch -n5 oc get clusteroperators
```

### Example output

NAME	VERSION	AVAILABLE	PROGRESSING	DEGRADED	SINCE
authentication	4.10.0	True	False	False	19m
baremetal	4.10.0	True	False	False	37m
cloud-credential	4.10.0	True	False	False	40m
cluster-autoscaler	4.10.0	True	False	False	37m
config-operator	4.10.0	True	False	False	38m

console	4.10.0	True	False	False	26m
csi-snapshot-controller	4.10.0	True	False	False	37m
dns	4.10.0	True	False	False	37m
etcd	4.10.0	True	False	False	36m
image-registry	4.10.0	True	False	False	31m
ingress	4.10.0	True	False	False	30m
insights	4.10.0	True	False	False	31m
kube-apiserver	4.10.0	True	False	False	26m
kube-controller-manager	4.10.0	True	False	False	36m
kube-scheduler	4.10.0	True	False	False	36m
kube-storage-version-migrator	4.10.0	True	False	False	37m
machine-api	4.10.0	True	False	False	29m
machine-approver	4.10.0	True	False	False	37m
machine-config	4.10.0	True	False	False	36m
marketplace	4.10.0	True	False	False	37m
monitoring	4.10.0	True	False	False	29m
network	4.10.0	True	False	False	38m
node-tuning	4.10.0	True	False	False	37m
openshift-apiserver	4.10.0	True	False	False	32m
openshift-controller-manager	4.10.0	True	False	False	30m
openshift-samples	4.10.0	True	False	False	32m
operator-lifecycle-manager	4.10.0	True	False	False	37m
operator-lifecycle-manager-catalog	4.10.0	True	False	False	37m
operator-lifecycle-manager-packageserver	4.10.0	True	False	False	32m
service-ca	4.10.0	True	False	False	38m
storage	4.10.0	True	False	False	37m

2. Configure the Operators that are not available.

### 17.2.16.1. Image registry storage configuration

The Image Registry Operator is not initially available for platforms that do not provide default storage. After installation, you must configure your registry to use storage so that the Registry Operator is made available.

Instructions are shown for configuring a persistent volume, which is required for production clusters. Where applicable, instructions are shown for configuring an empty directory as the storage location, which is available for only non-production clusters.

Additional instructions are provided for allowing the image registry to use block storage types by using the **Recreate** rollout strategy during upgrades.

#### 17.2.16.1.1. Configuring registry storage for IBM Power

As a cluster administrator, following installation you must configure your registry to use storage.

#### Prerequisites

- You have access to the cluster as a user with the **cluster-admin** role.
- You have a cluster on IBM Power.
- You have provisioned persistent storage for your cluster, such as Red Hat OpenShift Data Foundation.

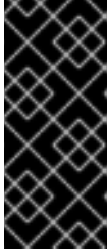
**IMPORTANT**

OpenShift Container Platform supports **ReadWriteOnce** access for image registry storage when you have only one replica. **ReadWriteOnce** access also requires that the registry uses the **Recreate** rollout strategy. To deploy an image registry that supports high availability with two or more replicas, **ReadWriteMany** access is required.

- Must have 100Gi capacity.

**Procedure**

1. To configure your registry to use storage, change the **spec.storage.pvc** in the **configs.imageregistry/cluster** resource.

**NOTE**

When using shared storage, review your security settings to prevent outside access.

2. Verify that you do not have a registry pod:

```
$ oc get pod -n openshift-image-registry -l docker-registry=default
```

**Example output**

```
No resources found in openshift-image-registry namespace
```

**NOTE**

If you do have a registry pod in your output, you do not need to continue with this procedure.

3. Check the registry configuration:

```
$ oc edit configs.imageregistry.operator.openshift.io
```

**Example output**

```
storage:
  pvc:
    claim:
```

Leave the **claim** field blank to allow the automatic creation of an **image-registry-storage** PVC.

4. Check the **clusteroperator** status:

```
$ oc get clusteroperator image-registry
```

**Example output**

NAME	VERSION	AVAILABLE	PROGRESSING	DEGRADED	SINCE
image-registry	4.10	True	False	False	6h50m

5. Ensure that your registry is set to managed to enable building and pushing of images.

- Run:

```
$ oc edit configs.imageregistry/cluster
```

Then, change the line

```
managementState: Removed
```

to

```
managementState: Managed
```

### 17.2.16.1.2. Configuring storage for the image registry in non-production clusters

You must configure storage for the Image Registry Operator. For non-production clusters, you can set the image registry to an empty directory. If you do so, all images are lost if you restart the registry.

#### Procedure

- To set the image registry storage to an empty directory:

```
$ oc patch configs.imageregistry.operator.openshift.io cluster --type merge --patch '{"spec": {"storage":{"emptyDir":{}}}'
```



#### WARNING

Configure this option for only non-production clusters.

If you run this command before the Image Registry Operator initializes its components, the **oc patch** command fails with the following error:

```
Error from server (NotFound): configs.imageregistry.operator.openshift.io "cluster" not found
```

Wait a few minutes and run the command again.

### 17.2.17. Completing installation on user-provisioned infrastructure

After you complete the Operator configuration, you can finish installing the cluster on infrastructure that you provide.

#### Prerequisites

- Your control plane has initialized.
- You have completed the initial Operator configuration.

## Procedure

1. Confirm that all the cluster components are online with the following command:

```
$ watch -n5 oc get clusteroperators
```

## Example output

NAME	VERSION	AVAILABLE	PROGRESSING	DEGRADED	SINCE
authentication	4.10.0	True	False	False	19m
baremetal	4.10.0	True	False	False	37m
cloud-credential	4.10.0	True	False	False	40m
cluster-autoscaler	4.10.0	True	False	False	37m
config-operator	4.10.0	True	False	False	38m
console	4.10.0	True	False	False	26m
csi-snapshot-controller	4.10.0	True	False	False	37m
dns	4.10.0	True	False	False	37m
etcd	4.10.0	True	False	False	36m
image-registry	4.10.0	True	False	False	31m
ingress	4.10.0	True	False	False	30m
insights	4.10.0	True	False	False	31m
kube-apiserver	4.10.0	True	False	False	26m
kube-controller-manager	4.10.0	True	False	False	36m
kube-scheduler	4.10.0	True	False	False	36m
kube-storage-version-migrator	4.10.0	True	False	False	37m
machine-api	4.10.0	True	False	False	29m
machine-approver	4.10.0	True	False	False	37m
machine-config	4.10.0	True	False	False	36m
marketplace	4.10.0	True	False	False	37m
monitoring	4.10.0	True	False	False	29m
network	4.10.0	True	False	False	38m
node-tuning	4.10.0	True	False	False	37m
openshift-apiserver	4.10.0	True	False	False	32m
openshift-controller-manager	4.10.0	True	False	False	30m
openshift-samples	4.10.0	True	False	False	32m
operator-lifecycle-manager	4.10.0	True	False	False	37m
operator-lifecycle-manager-catalog	4.10.0	True	False	False	37m
operator-lifecycle-manager-packageserver	4.10.0	True	False	False	32m
service-ca	4.10.0	True	False	False	38m
storage	4.10.0	True	False	False	37m

Alternatively, the following command notifies you when all of the clusters are available. It also retrieves and displays credentials:

```
$ ./openshift-install --dir <installation_directory> wait-for install-complete 1
```

- 1** For **<installation\_directory>**, specify the path to the directory that you stored the installation files in.

## Example output

```
INFO Waiting up to 30m0s for the cluster to initialize...
```

The command succeeds when the Cluster Version Operator finishes deploying the OpenShift Container Platform cluster from Kubernetes API server.

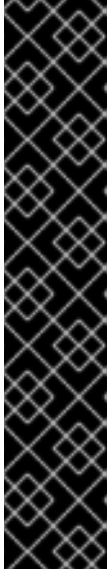

### IMPORTANT

- The Ignition config files that the installation program generates contain certificates that expire after 24 hours, which are then renewed at that time. If the cluster is shut down before renewing the certificates and the cluster is later restarted after the 24 hours have elapsed, the cluster automatically recovers the expired certificates. The exception is that you must manually approve the pending **node-bootstrapper** certificate signing requests (CSRs) to recover kubelet certificates. See the documentation for *Recovering from expired control plane certificates* for more information.
- It is recommended that you use Ignition config files within 12 hours after they are generated because the 24-hour certificate rotates from 16 to 22 hours after the cluster is installed. By using the Ignition config files within 12 hours, you can avoid installation failure if the certificate update runs during installation.

2. Confirm that the Kubernetes API server is communicating with the pods.

a. To view a list of all pods, use the following command:

```
$ oc get pods --all-namespaces
```

### Example output

```
NAMESPACE          NAME                                     READY  STATUS
RESTARTS  AGE
openshift-apiserver-operator  openshift-apiserver-operator-85cb746d55-zqhs8  1/1
Running    1    9m
openshift-apiserver          apiserver-67b9g                                1/1  Running  0
3m
openshift-apiserver          apiserver-ljcmx                                1/1  Running  0
1m
openshift-apiserver          apiserver-z25h4                                1/1  Running  0
2m
openshift-authentication-operator  authentication-operator-69d5d8bf84-vh2n8      1/1
Running    0    5m
...
```

b. View the logs for a pod that is listed in the output of the previous command by using the following command:

```
$ oc logs <pod_name> -n <namespace> ❶
```

- ❶ Specify the pod name and namespace, as shown in the output of the previous command.

If the pod logs display, the Kubernetes API server can communicate with the cluster machines.

3. Additional steps are required to enable multipathing. Do not enable multipathing during installation.

See "Enabling multipathing with kernel arguments on RHCOS" in the *Post-installation machine configuration tasks* documentation for more information.

### 17.2.18. Telemetry access for OpenShift Container Platform

In OpenShift Container Platform 4.10, the Telemetry service, which runs by default to provide metrics about cluster health and the success of updates, requires internet access. If your cluster is connected to the internet, Telemetry runs automatically, and your cluster is registered to [OpenShift Cluster Manager](#).

After you confirm that your [OpenShift Cluster Manager](#) inventory is correct, either maintained automatically by Telemetry or manually by using OpenShift Cluster Manager, [use subscription watch](#) to track your OpenShift Container Platform subscriptions at the account or multi-cluster level.

#### Additional resources

- See [About remote health monitoring](#) for more information about the Telemetry service

### 17.2.19. Next steps

- [Enabling multipathing with kernel arguments on RHCOS](#) .
- [Customize your cluster](#) .
- If necessary, you can [opt out of remote health reporting](#) .

## 17.3. INSTALLING A CLUSTER ON IBM POWER IN A RESTRICTED NETWORK

In OpenShift Container Platform version 4.10, you can install a cluster on IBM Power infrastructure that you provision in a restricted network.



### IMPORTANT

Additional considerations exist for non-bare metal platforms. Review the information in the [guidelines for deploying OpenShift Container Platform on non-tested platforms](#) before you install an OpenShift Container Platform cluster.

### 17.3.1. Prerequisites

- You reviewed details about the [OpenShift Container Platform installation and update](#) processes.
- You read the documentation on [selecting a cluster installation method and preparing it for users](#).
- You [created a mirror registry for installation in a restricted network](#) and obtained the **imageContentSources** data for your version of OpenShift Container Platform.



- Before you begin the installation process, you must move or remove any existing installation files. This ensures that the required installation files are created and updated during the installation process.



### IMPORTANT

Ensure that installation steps are performed on a machine with access to the installation media.

- You provisioned [persistent storage using OpenShift Data Foundation](#) or other supported storage protocols for your cluster. To deploy a private image registry, you must set up persistent storage with **ReadWriteMany** access.
- If you use a firewall and plan to use the Telemetry service, you [configured the firewall to allow the sites](#) that your cluster requires access to.

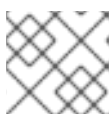

### NOTE

Be sure to also review this site list if you are configuring a proxy.

## 17.3.2. About installations in restricted networks

In OpenShift Container Platform 4.10, you can perform an installation that does not require an active connection to the internet to obtain software components. Restricted network installations can be completed using installer-provisioned infrastructure or user-provisioned infrastructure, depending on the cloud platform to which you are installing the cluster.

To complete a restricted network installation, you must create a registry that mirrors the contents of the OpenShift image registry and contains the installation media. You can create this registry on a mirror host, which can access both the internet and your closed network, or by using other methods that meet your restrictions.



### IMPORTANT

Because of the complexity of the configuration for user-provisioned installations, consider completing a standard user-provisioned infrastructure installation before you attempt a restricted network installation using user-provisioned infrastructure. Completing this test installation might make it easier to isolate and troubleshoot any issues that might arise during your installation in a restricted network.

### 17.3.2.1. Additional limits

Clusters in restricted networks have the following additional limitations and restrictions:

- The **ClusterVersion** status includes an **Unable to retrieve available updates** error.
- By default, you cannot use the contents of the Developer Catalog because you cannot access the required image stream tags.

## 17.3.3. Internet access for OpenShift Container Platform

In OpenShift Container Platform 4.10, you require access to the internet to obtain the images that are necessary to install your cluster.

You must have internet access to:

- Access [OpenShift Cluster Manager](#) to download the installation program and perform subscription management. If the cluster has internet access and you do not disable Telemetry, that service automatically entitles your cluster.
- Access [Quay.io](#) to obtain the packages that are required to install your cluster.
- Obtain the packages that are required to perform cluster updates.



### IMPORTANT

If your cluster cannot have direct internet access, you can perform a restricted network installation on some types of infrastructure that you provision. During that process, you download the required content and use it to populate a mirror registry with the installation packages. With some installation types, the environment that you install your cluster in will not require internet access. Before you update the cluster, you update the content of the mirror registry.

## 17.3.4. Requirements for a cluster with user-provisioned infrastructure

For a cluster that contains user-provisioned infrastructure, you must deploy all of the required machines.

This section describes the requirements for deploying OpenShift Container Platform on user-provisioned infrastructure.

### 17.3.4.1. Required machines for cluster installation

The smallest OpenShift Container Platform clusters require the following hosts:

**Table 17.19. Minimum required hosts**

Hosts	Description
One temporary bootstrap machine	The cluster requires the bootstrap machine to deploy the OpenShift Container Platform cluster on the three control plane machines. You can remove the bootstrap machine after you install the cluster.
Three control plane machines	The control plane machines run the Kubernetes and OpenShift Container Platform services that form the control plane.
At least two compute machines, which are also known as worker machines.	The workloads requested by OpenShift Container Platform users run on the compute machines.



### IMPORTANT

To maintain high availability of your cluster, use separate physical hosts for these cluster machines.

The bootstrap, control plane, and compute machines must use Red Hat Enterprise Linux CoreOS (RHCOS) as the operating system.

Note that RHCOS is based on Red Hat Enterprise Linux (RHEL) 8 and inherits all of its hardware certifications and requirements. See [Red Hat Enterprise Linux technology capabilities and limits](#) .

### 17.3.4.2. Minimum resource requirements for cluster installation

Each cluster machine must meet the following minimum requirements:

**Table 17.20. Minimum resource requirements**

Machine	Operating System	vCPU [1]	Virtual RAM	Storage	IOPS [2]
Bootstrap	RHCOS	2	16 GB	100 GB	300
Control plane	RHCOS	2	16 GB	100 GB	300
Compute	RHCOS	2	8 GB	100 GB	300

1. One vCPU is equivalent to one physical core when simultaneous multithreading (SMT), or hyperthreading, is not enabled. When enabled, use the following formula to calculate the corresponding ratio:  $(\text{threads per core} \times \text{cores}) \times \text{sockets} = \text{vCPUs}$ .
2. OpenShift Container Platform and Kubernetes are sensitive to disk performance, and faster storage is recommended, particularly for etcd on the control plane nodes. Note that on many cloud platforms, storage size and IOPS scale together, so you might need to over-allocate storage volume to obtain sufficient performance.

If an instance type for your platform meets the minimum requirements for cluster machines, it is supported to use in OpenShift Container Platform.

### 17.3.4.3. Minimum IBM Power requirements

You can install OpenShift Container Platform version 4.10 on the following IBM hardware:

- IBM Power8, Power9, or Power10 processor-based systems

#### Hardware requirements

- Six IBM Power bare metal servers or six LPARs across multiple PowerVM servers

#### Operating system requirements

- One instance of an IBM Power8, Power9, or Power10 processor-based system

On your IBM Power instance, set up:

- Three guest virtual machines for OpenShift Container Platform control plane machines
- Two guest virtual machines for OpenShift Container Platform compute machines
- One guest virtual machine for the temporary OpenShift Container Platform bootstrap machine

#### Disk storage for the IBM Power guest virtual machines

- Local storage, or storage provisioned by the Virtual I/O Server using vSCSI, NPIV (N-Port ID

Virtualization) or SSP (shared storage pools)

#### **Network for the PowerVM guest virtual machines**

- Dedicated physical adapter, or SR-IOV virtual function
- Available by the Virtual I/O Server using Shared Ethernet Adapter
- Virtualized by the Virtual I/O Server using IBM vNIC

#### **Storage / main memory**

- 100 GB / 16 GB for OpenShift Container Platform control plane machines
- 100 GB / 8 GB for OpenShift Container Platform compute machines
- 100 GB / 16 GB for the temporary OpenShift Container Platform bootstrap machine

### **17.3.4.4. Recommended IBM Power system requirements**

#### **Hardware requirements**

- Six IBM Power bare metal servers or six LPARs across multiple PowerVM servers

#### **Operating system requirements**

- One instance of an IBM Power8, Power9, or Power10 processor-based system

On your IBM Power instance, set up:

- Three guest virtual machines for OpenShift Container Platform control plane machines
- Two guest virtual machines for OpenShift Container Platform compute machines
- One guest virtual machine for the temporary OpenShift Container Platform bootstrap machine

#### **Disk storage for the IBM Power guest virtual machines**

- Local storage, or storage provisioned by the Virtual I/O Server using vSCSI, NPIV (N-Port ID Virtualization) or SSP (shared storage pools)

#### **Network for the PowerVM guest virtual machines**

- Dedicated physical adapter, or SR-IOV virtual function
- Available by the Virtual I/O Server using Shared Ethernet Adapter
- Virtualized by the Virtual I/O Server using IBM vNIC

#### **Storage / main memory**

- 120 GB / 32 GB for OpenShift Container Platform control plane machines
- 120 GB / 32 GB for OpenShift Container Platform compute machines
- 120 GB / 16 GB for the temporary OpenShift Container Platform bootstrap machine

### **17.3.4.5. Certificate signing requests management**

Because your cluster has limited access to automatic machine management when you use infrastructure that you provision, you must provide a mechanism for approving cluster certificate signing requests (CSRs) after installation. The **kube-controller-manager** only approves the kubelet client CSRs. The **machine-approver** cannot guarantee the validity of a serving certificate that is requested by using kubelet credentials because it cannot confirm that the correct machine issued the request. You must determine and implement a method of verifying the validity of the kubelet serving certificate requests and approving them.

#### 17.3.4.6. Networking requirements for user-provisioned infrastructure

All the Red Hat Enterprise Linux CoreOS (RHCOS) machines require networking to be configured in **initramfs** during boot to fetch their Ignition config files.

During the initial boot, the machines require an IP address configuration that is set either through a DHCP server or statically by providing the required boot options. After a network connection is established, the machines download their Ignition config files from an HTTP or HTTPS server. The Ignition config files are then used to set the exact state of each machine. The Machine Config Operator completes more changes to the machines, such as the application of new certificates or keys, after installation.

It is recommended to use a DHCP server for long-term management of the cluster machines. Ensure that the DHCP server is configured to provide persistent IP addresses, DNS server information, and hostnames to the cluster machines.



#### NOTE

If a DHCP service is not available for your user-provisioned infrastructure, you can instead provide the IP networking configuration and the address of the DNS server to the nodes at RHCOS install time. These can be passed as boot arguments if you are installing from an ISO image. See the *Installing RHCOS and starting the OpenShift Container Platform bootstrap process* section for more information about static IP provisioning and advanced networking options.

The Kubernetes API server must be able to resolve the node names of the cluster machines. If the API servers and worker nodes are in different zones, you can configure a default DNS search zone to allow the API server to resolve the node names. Another supported approach is to always refer to hosts by their fully-qualified domain names in both the node objects and all DNS requests.

##### 17.3.4.6.1. Setting the cluster node hostnames through DHCP

On Red Hat Enterprise Linux CoreOS (RHCOS) machines, the hostname is set through NetworkManager. By default, the machines obtain their hostname through DHCP. If the hostname is not provided by DHCP, set statically through kernel arguments, or another method, it is obtained through a reverse DNS lookup. Reverse DNS lookup occurs after the network has been initialized on a node and can take time to resolve. Other system services can start prior to this and detect the hostname as **localhost** or similar. You can avoid this by using DHCP to provide the hostname for each cluster node.

Additionally, setting the hostnames through DHCP can bypass any manual DNS record name configuration errors in environments that have a DNS split-horizon implementation.

##### 17.3.4.6.2. Network connectivity requirements

You must configure the network connectivity between machines to allow OpenShift Container Platform cluster components to communicate. Each machine must be able to resolve the hostnames of all other machines in the cluster.

This section provides details about the ports that are required.

**Table 17.21. Ports used for all-machine to all-machine communications**

Protocol	Port	Description
ICMP	N/A	Network reachability tests
TCP	<b>1936</b>	Metrics
	<b>9000-9999</b>	Host level services, including the node exporter on ports <b>9100-9101</b> and the Cluster Version Operator on port <b>9099</b> .
	<b>10250-10259</b>	The default ports that Kubernetes reserves
	<b>10256</b>	openshift-sdn
UDP	<b>4789</b>	VXLAN
	<b>6081</b>	Geneve
	<b>9000-9999</b>	Host level services, including the node exporter on ports <b>9100-9101</b> .
	<b>500</b>	IPsec IKE packets
	<b>4500</b>	IPsec NAT-T packets
TCP/UDP	<b>30000-32767</b>	Kubernetes node port
ESP	N/A	IPsec Encapsulating Security Payload (ESP)

**Table 17.22. Ports used for all-machine to control plane communications**

Protocol	Port	Description
TCP	<b>6443</b>	Kubernetes API

**Table 17.23. Ports used for control plane machine to control plane machine communications**

Protocol	Port	Description
TCP	<b>2379-2380</b>	etcd server and peer ports

#### NTP configuration for user-provisioned infrastructure

OpenShift Container Platform clusters are configured to use a public Network Time Protocol (NTP) server by default. If you want to use a local enterprise NTP server, or if your cluster is being deployed in a disconnected network, you can configure the cluster to use a specific time server. For more information,

see the documentation for *Configuring chrony time service* .

If a DHCP server provides NTP server information, the chrony time service on the Red Hat Enterprise Linux CoreOS (RHCOS) machines read the information and can sync the clock with the NTP servers.

#### Additional resources

- [Configuring chrony time service](#)

#### 17.3.4.7. User-provisioned DNS requirements

In OpenShift Container Platform deployments, DNS name resolution is required for the following components:

- The Kubernetes API
- The OpenShift Container Platform application wildcard
- The bootstrap, control plane, and compute machines

Reverse DNS resolution is also required for the Kubernetes API, the bootstrap machine, the control plane machines, and the compute machines.

DNS A/AAAA or CNAME records are used for name resolution and PTR records are used for reverse name resolution. The reverse records are important because Red Hat Enterprise Linux CoreOS (RHCOS) uses the reverse records to set the hostnames for all the nodes, unless the hostnames are provided by DHCP. Additionally, the reverse records are used to generate the certificate signing requests (CSR) that OpenShift Container Platform needs to operate.



#### NOTE

It is recommended to use a DHCP server to provide the hostnames to each cluster node. See the *DHCP recommendations for user-provisioned infrastructure* section for more information.

The following DNS records are required for a user-provisioned OpenShift Container Platform cluster and they must be in place before installation. In each record, **<cluster\_name>** is the cluster name and **<base\_domain>** is the base domain that you specify in the **install-config.yaml** file. A complete DNS record takes the form: **<component>.<cluster\_name>.<base\_domain>.**

Table 17.24. Required DNS records

Component	Record	Description
Kubernetes API	<b>api.&lt;cluster_name&gt;.&lt;base_domain&gt;.</b>	A DNS A/AAAA or CNAME record, and a DNS PTR record, to identify the API load balancer. These records must be resolvable by both clients external to the cluster and from all the nodes within the cluster.

Component	Record	Description
	<b>api-int.&lt;cluster_name&gt;.&lt;base_domain&gt;.</b>	<p>A DNS A/AAAA or CNAME record, and a DNS PTR record, to internally identify the API load balancer. These records must be resolvable from all the nodes within the cluster.</p> <div style="display: flex; align-items: flex-start;">  <div> <p><b>IMPORTANT</b></p> <p>The API server must be able to resolve the worker nodes by the hostnames that are recorded in Kubernetes. If the API server cannot resolve the node names, then proxied API calls can fail, and you cannot retrieve logs from pods.</p> </div> </div>
Routes	<b>*.apps.&lt;cluster_name&gt;.&lt;base_domain&gt;.</b>	<p>A wildcard DNS A/AAAA or CNAME record that refers to the application ingress load balancer. The application ingress load balancer targets the machines that run the Ingress Controller pods. The Ingress Controller pods run on the compute machines by default. These records must be resolvable by both clients external to the cluster and from all the nodes within the cluster.</p> <p>For example, <b>console-openshift-console.apps.&lt;cluster_name&gt;.&lt;base_domain&gt;</b> is used as a wildcard route to the OpenShift Container Platform console.</p>
Bootstrap machine	<b>bootstrap.&lt;cluster_name&gt;.&lt;base_domain&gt;.</b>	A DNS A/AAAA or CNAME record, and a DNS PTR record, to identify the bootstrap machine. These records must be resolvable by the nodes within the cluster.
Control plane machines	<b>&lt;master&gt;&lt;n&gt;.&lt;cluster_name&gt;.&lt;base_domain&gt;.</b>	DNS A/AAAA or CNAME records and DNS PTR records to identify each machine for the control plane nodes. These records must be resolvable by the nodes within the cluster.
Compute machines	<b>&lt;worker&gt;&lt;n&gt;.&lt;cluster_name&gt;.&lt;base_domain&gt;.</b>	DNS A/AAAA or CNAME records and DNS PTR records to identify each machine for the worker nodes. These records must be resolvable by the nodes within the cluster.

**NOTE**

In OpenShift Container Platform 4.4 and later, you do not need to specify etcd host and SRV records in your DNS configuration.

**TIP**

You can use the **dig** command to verify name and reverse name resolution. See the section on *Validating DNS resolution for user-provisioned infrastructure* for detailed validation steps.



### 17.3.4.7.1. Example DNS configuration for user-provisioned clusters

This section provides A and PTR record configuration samples that meet the DNS requirements for deploying OpenShift Container Platform on user-provisioned infrastructure. The samples are not meant to provide advice for choosing one DNS solution over another.

In the examples, the cluster name is **ocp4** and the base domain is **example.com**.

#### Example DNS A record configuration for a user-provisioned cluster

The following example is a BIND zone file that shows sample A records for name resolution in a user-provisioned cluster.

##### Example 17.4. Sample DNS zone database

```
$TTL 1W
@ IN SOA ns1.example.com. root (
  2019070700 ; serial
  3H ; refresh (3 hours)
  30M ; retry (30 minutes)
  2W ; expiry (2 weeks)
  1W ) ; minimum (1 week)
IN NS ns1.example.com.
IN MX 10 smtp.example.com.
;
;
ns1.example.com. IN A 192.168.1.5
smtp.example.com. IN A 192.168.1.5
;
helper.example.com. IN A 192.168.1.5
helper.ocp4.example.com. IN A 192.168.1.5
;
api.ocp4.example.com. IN A 192.168.1.5 1
api-int.ocp4.example.com. IN A 192.168.1.5 2
;
*.apps.ocp4.example.com. IN A 192.168.1.5 3
;
bootstrap.ocp4.example.com. IN A 192.168.1.96 4
;
master0.ocp4.example.com. IN A 192.168.1.97 5
master1.ocp4.example.com. IN A 192.168.1.98 6
master2.ocp4.example.com. IN A 192.168.1.99 7
;
worker0.ocp4.example.com. IN A 192.168.1.11 8
worker1.ocp4.example.com. IN A 192.168.1.7 9
;
;EOF
```

- 1 Provides name resolution for the Kubernetes API. The record refers to the IP address of the API load balancer.
- 2 Provides name resolution for the Kubernetes API. The record refers to the IP address of the API load balancer and is used for internal cluster communications.
- 3 Provides name resolution for the wildcard routes. The record refers to the IP address of the application ingress load balancer. The application ingress load balancer targets the machines

application ingress load balancer. The application ingress load balancer targets the machines that run the Ingress Controller pods. The Ingress Controller pods run on the compute machines by default.



## NOTE

In the example, the same load balancer is used for the Kubernetes API and application ingress traffic. In production scenarios, you can deploy the API and application ingress load balancers separately so that you can scale the load balancer infrastructure for each in isolation.

- 4 Provides name resolution for the bootstrap machine.
- 5 6 7 Provides name resolution for the control plane machines.
- 8 9 Provides name resolution for the compute machines.

## Example DNS PTR record configuration for a user-provisioned cluster

The following example BIND zone file shows sample PTR records for reverse name resolution in a user-provisioned cluster.

### Example 17.5. Sample DNS zone database for reverse records

```
$TTL 1W
@ IN SOA ns1.example.com. root (
    2019070700 ; serial
    3H ; refresh (3 hours)
    30M ; retry (30 minutes)
    2W ; expiry (2 weeks)
    1W ) ; minimum (1 week)
IN NS ns1.example.com.
;
5.1.168.192.in-addr.arpa. IN PTR api.ocp4.example.com. 1
5.1.168.192.in-addr.arpa. IN PTR api-int.ocp4.example.com. 2
;
96.1.168.192.in-addr.arpa. IN PTR bootstrap.ocp4.example.com. 3
;
97.1.168.192.in-addr.arpa. IN PTR master0.ocp4.example.com. 4
98.1.168.192.in-addr.arpa. IN PTR master1.ocp4.example.com. 5
99.1.168.192.in-addr.arpa. IN PTR master2.ocp4.example.com. 6
;
11.1.168.192.in-addr.arpa. IN PTR worker0.ocp4.example.com. 7
7.1.168.192.in-addr.arpa. IN PTR worker1.ocp4.example.com. 8
;
;EOF
```

- 1 Provides reverse DNS resolution for the Kubernetes API. The PTR record refers to the record name of the API load balancer.
- 2 Provides reverse DNS resolution for the Kubernetes API. The PTR record refers to the record name of the API load balancer and is used for internal cluster communications.

- 3 Provides reverse DNS resolution for the bootstrap machine.
- 4 5 6 Provides reverse DNS resolution for the control plane machines.
- 7 8 Provides reverse DNS resolution for the compute machines.

**NOTE**

A PTR record is not required for the OpenShift Container Platform application wildcard.

### 17.3.4.8. Load balancing requirements for user-provisioned infrastructure

Before you install OpenShift Container Platform, you must provision the API and application ingress load balancing infrastructure. In production scenarios, you can deploy the API and application ingress load balancers separately so that you can scale the load balancer infrastructure for each in isolation.

**NOTE**

If you want to deploy the API and application Ingress load balancers with a Red Hat Enterprise Linux (RHEL) instance, you must purchase the RHEL subscription separately.

The load balancing infrastructure must meet the following requirements:

1. **API load balancer.** Provides a common endpoint for users, both human and machine, to interact with and configure the platform. Configure the following conditions:
  - Layer 4 load balancing only. This can be referred to as Raw TCP, SSL Passthrough, or SSL Bridge mode. If you use SSL Bridge mode, you must enable Server Name Indication (SNI) for the API routes.
  - A stateless load balancing algorithm. The options vary based on the load balancer implementation.

**IMPORTANT**

Do not configure session persistence for an API load balancer. Configuring session persistence for a Kubernetes API server might cause performance issues from excess application traffic for your OpenShift Container Platform cluster and the Kubernetes API that runs inside the cluster.

Configure the following ports on both the front and back of the load balancers:

**Table 17.25. API load balancer**

Port	Back-end machines (pool members)	Internal	External	Description
------	----------------------------------	----------	----------	-------------

Port	Back-end machines (pool members)	Internal	External	Description
<b>6443</b>	Bootstrap and control plane. You remove the bootstrap machine from the load balancer after the bootstrap machine initializes the cluster control plane. You must configure the <b>/readyz</b> endpoint for the API server health check probe.	X	X	Kubernetes API server
<b>22623</b>	Bootstrap and control plane. You remove the bootstrap machine from the load balancer after the bootstrap machine initializes the cluster control plane.	X		Machine config server

**NOTE**

The load balancer must be configured to take a maximum of 30 seconds from the time the API server turns off the **/readyz** endpoint to the removal of the API server instance from the pool. Within the time frame after **/readyz** returns an error or becomes healthy, the endpoint must have been removed or added. Probing every 5 or 10 seconds, with two successful requests to become healthy and three to become unhealthy, are well-tested values.

2. **Application Ingress load balancer.** Provides an ingress point for application traffic flowing in from outside the cluster. A working configuration for the Ingress router is required for an OpenShift Container Platform cluster.

Configure the following conditions:

- Layer 4 load balancing only. This can be referred to as Raw TCP, SSL Passthrough, or SSL Bridge mode. If you use SSL Bridge mode, you must enable Server Name Indication (SNI) for the ingress routes.
- A connection-based or session-based persistence is recommended, based on the options available and types of applications that will be hosted on the platform.

**TIP**

If the true IP address of the client can be seen by the application Ingress load balancer, enabling source IP-based session persistence can improve performance for applications that use end-to-end TLS encryption.

Configure the following ports on both the front and back of the load balancers:

**Table 17.26. Application Ingress load balancer**

Port	Back-end machines (pool members)	Internal	External	Description
<b>443</b>	The machines that run the Ingress Controller pods, compute, or worker, by default.	X	X	HTTPS traffic
<b>80</b>	The machines that run the Ingress Controller pods, compute, or worker, by default.	X	X	HTTP traffic

**NOTE**

If you are deploying a three-node cluster with zero compute nodes, the Ingress Controller pods run on the control plane nodes. In three-node cluster deployments, you must configure your application Ingress load balancer to route HTTP and HTTPS traffic to the control plane nodes.

**17.3.4.8.1. Example load balancer configuration for user-provisioned clusters**

This section provides an example API and application ingress load balancer configuration that meets the load balancing requirements for user-provisioned clusters. The sample is an `/etc/haproxy/haproxy.cfg` configuration for an HAProxy load balancer. The example is not meant to provide advice for choosing one load balancing solution over another.

In the example, the same load balancer is used for the Kubernetes API and application ingress traffic. In production scenarios, you can deploy the API and application ingress load balancers separately so that you can scale the load balancer infrastructure for each in isolation.

**NOTE**

If you are using HAProxy as a load balancer and SELinux is set to **enforcing**, you must ensure that the HAProxy service can bind to the configured TCP port by running **setsebool -P haproxy\_connect\_any=1**.

**Example 17.6. Sample API and application Ingress load balancer configuration**

```
global
  log      127.0.0.1 local2
  pidfile  /var/run/haproxy.pid
  maxconn  4000
  daemon
defaults
  mode          http
  log           global
  option        dontlognull
  option http-server-close
  option        redispatch
  retries       3
  timeout http-request  10s
  timeout queue      1m
  timeout connect    10s
```

```

timeout client      1m
timeout server     1m
timeout http-keep-alive 10s
timeout check      10s
maxconn            3000
listen api-server-6443 1
bind *:6443
mode tcp
server bootstrap bootstrap.ocp4.example.com:6443 check inter 1s backup 2
server master0 master0.ocp4.example.com:6443 check inter 1s
server master1 master1.ocp4.example.com:6443 check inter 1s
server master2 master2.ocp4.example.com:6443 check inter 1s
listen machine-config-server-22623 3
bind *:22623
mode tcp
server bootstrap bootstrap.ocp4.example.com:22623 check inter 1s backup 4
server master0 master0.ocp4.example.com:22623 check inter 1s
server master1 master1.ocp4.example.com:22623 check inter 1s
server master2 master2.ocp4.example.com:22623 check inter 1s
listen ingress-router-443 5
bind *:443
mode tcp
balance source
server worker0 worker0.ocp4.example.com:443 check inter 1s
server worker1 worker1.ocp4.example.com:443 check inter 1s
listen ingress-router-80 6
bind *:80
mode tcp
balance source
server worker0 worker0.ocp4.example.com:80 check inter 1s
server worker1 worker1.ocp4.example.com:80 check inter 1s

```

- 1** Port **6443** handles the Kubernetes API traffic and points to the control plane machines.
- 2** **4** The bootstrap entries must be in place before the OpenShift Container Platform cluster installation and they must be removed after the bootstrap process is complete.
- 3** Port **22623** handles the machine config server traffic and points to the control plane machines.
- 5** Port **443** handles the HTTPS traffic and points to the machines that run the Ingress Controller pods. The Ingress Controller pods run on the compute machines by default.
- 6** Port **80** handles the HTTP traffic and points to the machines that run the Ingress Controller pods. The Ingress Controller pods run on the compute machines by default.

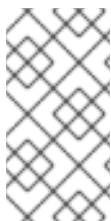

#### NOTE

If you are deploying a three-node cluster with zero compute nodes, the Ingress Controller pods run on the control plane nodes. In three-node cluster deployments, you must configure your application Ingress load balancer to route HTTP and HTTPS traffic to the control plane nodes.

**TIP**

If you are using HAProxy as a load balancer, you can check that the **haproxy** process is listening on ports **6443**, **22623**, **443**, and **80** by running **netstat -nltupe** on the HAProxy node.

**17.3.5. Preparing the user-provisioned infrastructure**

Before you install OpenShift Container Platform on user-provisioned infrastructure, you must prepare the underlying infrastructure.

This section provides details about the high-level steps required to set up your cluster infrastructure in preparation for an OpenShift Container Platform installation. This includes configuring IP networking and network connectivity for your cluster nodes, enabling the required ports through your firewall, and setting up the required DNS and load balancing infrastructure.

After preparation, your cluster infrastructure must meet the requirements outlined in the *Requirements for a cluster with user-provisioned infrastructure* section.

**Prerequisites**

- You have reviewed the [OpenShift Container Platform 4.x Tested Integrations](#) page.
- You have reviewed the infrastructure requirements detailed in the *Requirements for a cluster with user-provisioned infrastructure* section.

**Procedure**

1. If you are using DHCP to provide the IP networking configuration to your cluster nodes, configure your DHCP service.
  - a. Add persistent IP addresses for the nodes to your DHCP server configuration. In your configuration, match the MAC address of the relevant network interface to the intended IP address for each node.
  - b. When you use DHCP to configure IP addressing for the cluster machines, the machines also obtain the DNS server information through DHCP. Define the persistent DNS server address that is used by the cluster nodes through your DHCP server configuration.

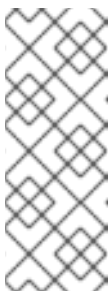
**NOTE**

If you are not using a DHCP service, you must provide the IP networking configuration and the address of the DNS server to the nodes at RHCOS install time. These can be passed as boot arguments if you are installing from an ISO image. See the *Installing RHCOS and starting the OpenShift Container Platform bootstrap process* section for more information about static IP provisioning and advanced networking options.

- c. Define the hostnames of your cluster nodes in your DHCP server configuration. See the *Setting the cluster node hostnames through DHCP* section for details about hostname considerations.

**NOTE**

If you are not using a DHCP service, the cluster nodes obtain their hostname through a reverse DNS lookup.

2. Ensure that your network infrastructure provides the required network connectivity between the cluster components. See the *Networking requirements for user-provisioned infrastructure* section for details about the requirements.
3. Configure your firewall to enable the ports required for the OpenShift Container Platform cluster components to communicate. See *Networking requirements for user-provisioned infrastructure* section for details about the ports that are required.



### IMPORTANT

By default, port **1936** is accessible for an OpenShift Container Platform cluster, because each control plane node needs access to this port.

Avoid using the Ingress load balancer to expose this port, because doing so might result in the exposure of sensitive information, such as statistics and metrics, related to Ingress Controllers.

4. Setup the required DNS infrastructure for your cluster.
  - a. Configure DNS name resolution for the Kubernetes API, the application wildcard, the bootstrap machine, the control plane machines, and the compute machines.
  - b. Configure reverse DNS resolution for the Kubernetes API, the bootstrap machine, the control plane machines, and the compute machines.  
See the *User-provisioned DNS requirements* section for more information about the OpenShift Container Platform DNS requirements.
5. Validate your DNS configuration.
  - a. From your installation node, run DNS lookups against the record names of the Kubernetes API, the wildcard routes, and the cluster nodes. Validate that the IP addresses in the responses correspond to the correct components.
  - b. From your installation node, run reverse DNS lookups against the IP addresses of the load balancer and the cluster nodes. Validate that the record names in the responses correspond to the correct components.  
See the *Validating DNS resolution for user-provisioned infrastructure* section for detailed DNS validation steps.
6. Provision the required API and application ingress load balancing infrastructure. See the *Load balancing requirements for user-provisioned infrastructure* section for more information about the requirements.



### NOTE

Some load balancing solutions require the DNS name resolution for the cluster nodes to be in place before the load balancing is initialized.

## 17.3.6. Validating DNS resolution for user-provisioned infrastructure

You can validate your DNS configuration before installing OpenShift Container Platform on user-provisioned infrastructure.



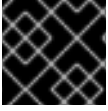

## IMPORTANT

The validation steps detailed in this section must succeed before you install your cluster.

### Prerequisites

- You have configured the required DNS records for your user-provisioned infrastructure.

### Procedure

- From your installation node, run DNS lookups against the record names of the Kubernetes API, the wildcard routes, and the cluster nodes. Validate that the IP addresses contained in the responses correspond to the correct components.
  - Perform a lookup against the Kubernetes API record name. Check that the result points to the IP address of the API load balancer:

```
$ dig +noall +answer @<nameserver_ip> api.<cluster_name>.<base_domain> 1
```

- Replace **<nameserver\_ip>** with the IP address of the nameserver, **<cluster\_name>** with your cluster name, and **<base\_domain>** with your base domain name.

#### Example output

```
api.ocp4.example.com. 0 IN A 192.168.1.5
```

- Perform a lookup against the Kubernetes internal API record name. Check that the result points to the IP address of the API load balancer:

```
$ dig +noall +answer @<nameserver_ip> api-int.<cluster_name>.<base_domain>
```

#### Example output

```
api-int.ocp4.example.com. 0 IN A 192.168.1.5
```

- Test an example **\*.apps.<cluster\_name>.<base\_domain>** DNS wildcard lookup. All of the application wildcard lookups must resolve to the IP address of the application ingress load balancer:

```
$ dig +noall +answer @<nameserver_ip> random.apps.<cluster_name>.<base_domain>
```

#### Example output

```
random.apps.ocp4.example.com. 0 IN A 192.168.1.5
```



## NOTE

In the example outputs, the same load balancer is used for the Kubernetes API and application ingress traffic. In production scenarios, you can deploy the API and application ingress load balancers separately so that you can scale the load balancer infrastructure for each in isolation.

You can replace **random** with another wildcard value. For example, you can query the route to the OpenShift Container Platform console:

```
$ dig +noall +answer @<nameserver_ip> console-openshift-console.apps.
<cluster_name>.<base_domain>
```

### Example output

```
console-openshift-console.apps.ocp4.example.com. 0 IN A 192.168.1.5
```

- d. Run a lookup against the bootstrap DNS record name. Check that the result points to the IP address of the bootstrap node:

```
$ dig +noall +answer @<nameserver_ip> bootstrap.<cluster_name>.<base_domain>
```

### Example output

```
bootstrap.ocp4.example.com. 0 IN A 192.168.1.96
```

- e. Use this method to perform lookups against the DNS record names for the control plane and compute nodes. Check that the results correspond to the IP addresses of each node.
2. From your installation node, run reverse DNS lookups against the IP addresses of the load balancer and the cluster nodes. Validate that the record names contained in the responses correspond to the correct components.

- a. Perform a reverse lookup against the IP address of the API load balancer. Check that the response includes the record names for the Kubernetes API and the Kubernetes internal API:

```
$ dig +noall +answer @<nameserver_ip> -x 192.168.1.5
```

### Example output

```
5.1.168.192.in-addr.arpa. 0 IN PTR api-int.ocp4.example.com. 1
5.1.168.192.in-addr.arpa. 0 IN PTR api.ocp4.example.com. 2
```

**1** Provides the record name for the Kubernetes internal API.

**2** Provides the record name for the Kubernetes API.



### NOTE

A PTR record is not required for the OpenShift Container Platform application wildcard. No validation step is needed for reverse DNS resolution against the IP address of the application ingress load balancer.

- b. Perform a reverse lookup against the IP address of the bootstrap node. Check that the result points to the DNS record name of the bootstrap node:

```
$ dig +noall +answer @<nameserver_ip> -x 192.168.1.96
```

## Example output

```
96.1.168.192.in-addr.arpa. 0 IN PTR bootstrap.ocp4.example.com.
```

- c. Use this method to perform reverse lookups against the IP addresses for the control plane and compute nodes. Check that the results correspond to the DNS record names of each node.

### 17.3.7. Generating a key pair for cluster node SSH access

During an OpenShift Container Platform installation, you can provide an SSH public key to the installation program. The key is passed to the Red Hat Enterprise Linux CoreOS (RHCOS) nodes through their Ignition config files and is used to authenticate SSH access to the nodes. The key is added to the `~/.ssh/authorized_keys` list for the **core** user on each node, which enables password-less authentication.

After the key is passed to the nodes, you can use the key pair to SSH in to the RHCOS nodes as the user **core**. To access the nodes through SSH, the private key identity must be managed by SSH for your local user.

If you want to SSH in to your cluster nodes to perform installation debugging or disaster recovery, you must provide the SSH public key during the installation process. The `./openshift-install gather` command also requires the SSH public key to be in place on the cluster nodes.



#### IMPORTANT

Do not skip this procedure in production environments, where disaster recovery and debugging is required.



#### NOTE

You must use a local key, not one that you configured with platform-specific approaches such as [AWS key pairs](#).

#### Procedure

1. If you do not have an existing SSH key pair on your local machine to use for authentication onto your cluster nodes, create one. For example, on a computer that uses a Linux operating system, run the following command:

```
$ ssh-keygen -t ed25519 -N "" -f <path>/<file_name> 1
```

- 1 Specify the path and file name, such as `~/.ssh/id_ed25519`, of the new SSH key. If you have an existing key pair, ensure your public key is in the your `~/.ssh` directory.



#### NOTE

If you plan to install an OpenShift Container Platform cluster that uses FIPS validated or Modules In Process cryptographic libraries on the **x86\_64** architecture, do not create a key that uses the **ed25519** algorithm. Instead, create a key that uses the **rsa** or **ecdsa** algorithm.

- View the public SSH key:

```
$ cat <path>/<file_name>.pub
```

For example, run the following to view the `~/.ssh/id_ed25519.pub` public key:

```
$ cat ~/.ssh/id_ed25519.pub
```

- Add the SSH private key identity to the SSH agent for your local user, if it has not already been added. SSH agent management of the key is required for password-less SSH authentication onto your cluster nodes, or if you want to use the `./openshift-install gather` command.



#### NOTE

On some distributions, default SSH private key identities such as `~/.ssh/id_rsa` and `~/.ssh/id_dsa` are managed automatically.

- If the `ssh-agent` process is not already running for your local user, start it as a background task:

```
$ eval "$(ssh-agent -s)"
```

#### Example output

```
Agent pid 31874
```



#### NOTE

If your cluster is in FIPS mode, only use FIPS-compliant algorithms to generate the SSH key. The key must be either RSA or ECDSA.

- Add your SSH private key to the `ssh-agent`:

```
$ ssh-add <path>/<file_name> 1
```

- 1** Specify the path and file name for your SSH private key, such as `~/.ssh/id_ed25519`

#### Example output

```
Identity added: /home/<you>/<path>/<file_name> (<computer_name>)
```

#### Next steps

- When you install OpenShift Container Platform, provide the SSH public key to the installation program.

### 17.3.8. Manually creating the installation configuration file

For user-provisioned installations of OpenShift Container Platform, you manually generate your installation configuration file.

## Prerequisites

- You have an SSH public key on your local machine to provide to the installation program. The key will be used for SSH authentication onto your cluster nodes for debugging and disaster recovery.
- You have obtained the OpenShift Container Platform installation program and the pull secret for your cluster.

## Procedure

1. Create an installation directory to store your required installation assets in:

```
$ mkdir <installation_directory>
```



### IMPORTANT

You must create a directory. Some installation assets, like bootstrap X.509 certificates have short expiration intervals, so you must not reuse an installation directory. If you want to reuse individual files from another cluster installation, you can copy them into your directory. However, the file names for the installation assets might change between releases. Use caution when copying installation files from an earlier OpenShift Container Platform version.

2. Customize the sample **install-config.yaml** file template that is provided and save it in the **<installation\_directory>**.



### NOTE

You must name this configuration file **install-config.yaml**.



### NOTE

For some platform types, you can alternatively run **./openshift-install create install-config --dir <installation\_directory>** to generate an **install-config.yaml** file. You can provide details about your cluster configuration at the prompts.

3. Back up the **install-config.yaml** file so that you can use it to install multiple clusters.



### IMPORTANT

The **install-config.yaml** file is consumed during the next step of the installation process. You must back it up now.

### 17.3.8.1. Installation configuration parameters

Before you deploy an OpenShift Container Platform cluster, you provide a customized **install-config.yaml** installation configuration file that describes the details for your environment.



### NOTE

After installation, you cannot modify these parameters in the **install-config.yaml** file.

## 17.3.8.1.1. Required configuration parameters

Required installation configuration parameters are described in the following table:

Table 17.27. Required parameters

Parameter	Description	Values
<b>apiVersion</b>	The API version for the <b>install-config.yaml</b> content. The current version is <b>v1</b> . The installer may also support older API versions.	String
<b>baseDomain</b>	The base domain of your cloud provider. The base domain is used to create routes to your OpenShift Container Platform cluster components. The full DNS name for your cluster is a combination of the <b>baseDomain</b> and <b>metadata.name</b> parameter values that uses the <b>&lt;metadata.name&gt;.&lt;baseDomain&gt;</b> format.	A fully-qualified domain or subdomain name, such as <b>example.com</b> .
<b>metadata</b>	Kubernetes resource <b>ObjectMeta</b> , from which only the <b>name</b> parameter is consumed.	Object
<b>metadata.name</b>	The name of the cluster. DNS records for the cluster are all subdomains of <b>{{.metadata.name}}</b> . <b>{{.baseDomain}}</b> .	String of lowercase letters, hyphens (-), and periods (.), such as <b>dev</b> .
<b>platform</b>	The configuration for the specific platform upon which to perform the installation: <b>alibabacloud</b> , <b>aws</b> , <b>baremetal</b> , <b>azure</b> , <b>gcp</b> , <b>ibmcloud</b> , <b>openstack</b> , <b>ovirt</b> , <b>vsphere</b> , or <b>{}</b> . For additional information about <b>platform.&lt;platform&gt;</b> parameters, consult the table for your specific platform that follows.	Object

Parameter	Description	Values
<b>pullSecret</b>	Get a <a href="#">pull secret from the Red Hat OpenShift Cluster Manager</a> to authenticate downloading container images for OpenShift Container Platform components from services such as Quay.io.	<pre>{   "auths":{     "cloud.openshift.com":{       "auth":"b3Blb=",       "email":"you@example.com"     },     "quay.io":{       "auth":"b3Blb=",       "email":"you@example.com"     }   } }</pre>

### 17.3.8.1.2. Network configuration parameters

You can customize your installation configuration based on the requirements of your existing network infrastructure. For example, you can expand the IP address block for the cluster network or provide different IP address blocks than the defaults.

Only IPv4 addresses are supported.

Table 17.28. Network parameters

Parameter	Description	Values
<b>networking</b>	The configuration for the cluster network.	Object  <div style="margin-left: 20px;"> <p><b>NOTE</b></p> <p>You cannot modify parameters specified by the <b>networking</b> object after installation.</p> </div>
<b>networking.networkType</b>	The cluster network provider Container Network Interface (CNI) plugin to install.	Either <b>OpenShiftSDN</b> or <b>OVNKubernetes</b> . <b>OpenShiftSDN</b> is a CNI provider for all-Linux networks. <b>OVNKubernetes</b> is a CNI provider for Linux networks and hybrid networks that contain both Linux and Windows servers. The default value is <b>OpenShiftSDN</b> .

Parameter	Description	Values
<b>networking.clusterNetwork</b>	<p>The IP address blocks for pods.</p> <p>The default value is <b>10.128.0.0/14</b> with a host prefix of <b>/23</b>.</p> <p>If you specify multiple IP address blocks, the blocks must not overlap.</p>	<p>An array of objects. For example:</p> <pre>networking:   clusterNetwork:     - cidr: 10.128.0.0/14       hostPrefix: 23</pre>
<b>networking.clusterNetwork.cidr</b>	<p>Required if you use <b>networking.clusterNetwork</b>. An IP address block.</p> <p>An IPv4 network.</p>	<p>An IP address block in Classless Inter-Domain Routing (CIDR) notation. The prefix length for an IPv4 block is between <b>0</b> and <b>32</b>.</p>
<b>networking.clusterNetwork.hostPrefix</b>	<p>The subnet prefix length to assign to each individual node. For example, if <b>hostPrefix</b> is set to <b>23</b> then each node is assigned a <b>/23</b> subnet out of the given <b>cidr</b>. A <b>hostPrefix</b> value of <b>23</b> provides 510 (<math>2^{(32 - 23)} - 2</math>) pod IP addresses.</p>	<p>A subnet prefix.</p> <p>The default value is <b>23</b>.</p>
<b>networking.serviceNetwork</b>	<p>The IP address block for services. The default value is <b>172.30.0.0/16</b>.</p> <p>The OpenShift SDN and OVN-Kubernetes network providers support only a single IP address block for the service network.</p>	<p>An array with an IP address block in CIDR format. For example:</p> <pre>networking:   serviceNetwork:     - 172.30.0.0/16</pre>
<b>networking.machineNetwork</b>	<p>The IP address blocks for machines.</p> <p>If you specify multiple IP address blocks, the blocks must not overlap.</p> <p>If you specify multiple IP kernel arguments, the <b>machineNetwork.cidr</b> value must be the CIDR of the primary network.</p>	<p>An array of objects. For example:</p> <pre>networking:   machineNetwork:     - cidr: 10.0.0.0/16</pre>



Parameter	Description	Values
<b>networking.machineNetwork.cidr</b>	Required if you use <b>networking.machineNetwork</b> . An IP address block. The default value is <b>10.0.0.0/16</b> for all platforms other than libvirt. For libvirt, the default value is <b>192.168.126.0/24</b> .	An IP network block in CIDR notation. For example, <b>10.0.0.0/16</b> .  <b>NOTE</b> Set the <b>networking.machineNetwork</b> to match the CIDR that the preferred NIC resides in.

### 17.3.8.1.3. Optional configuration parameters



Optional installation configuration parameters are described in the following table:

Table 17.29. Optional parameters



Parameter	Description	Values
<b>additionalTrustBundle</b>	A PEM-encoded X.509 certificate bundle that is added to the nodes' trusted certificate store. This trust bundle may also be used when a proxy has been configured.	String
<b>cgroupsV2</b>	Enables <a href="#">Linux control groups version 2</a> (cgroups v2) on specific nodes in your cluster. The OpenShift Container Platform process for enabling cgroups v2 disables all cgroup version 1 controllers and hierarchies. The OpenShift Container Platform cgroups version 2 feature is in Developer Preview and is not supported by Red Hat at this time.	<b>true</b>
<b>compute</b>	The configuration for the machines that comprise the compute nodes.	Array of <b>MachinePool</b> objects.
<b>compute.architecture</b>	Determines the instruction set architecture of the machines in the pool. Currently, heterogeneous clusters are not supported, so all pools must specify the same architecture. Valid values are <b>ppc64le</b> (the default).	String

Parameter	Description	Values
<b>compute.hyperthreading</b>	<p>Whether to enable or disable simultaneous multithreading, or <b>hyperthreading</b>, on compute machines. By default, simultaneous multithreading is enabled to increase the performance of your machines' cores.</p> <div style="display: flex; align-items: center;">  <div> <p><b>IMPORTANT</b></p> <p>If you disable simultaneous multithreading, ensure that your capacity planning accounts for the dramatically decreased machine performance.</p> </div> </div>	<b>Enabled</b> or <b>Disabled</b>
<b>compute.name</b>	Required if you use <b>compute</b> . The name of the machine pool.	<b>worker</b>
<b>compute.platform</b>	Required if you use <b>compute</b> . Use this parameter to specify the cloud provider to host the worker machines. This parameter value must match the <b>controlPlane.platform</b> parameter value.	<b>alibabacloud, aws, azure, gcp, ibmcloud, openstack, ovirt, vsphere</b> , or <b>{}</b>
<b>compute.replicas</b>	The number of compute machines, which are also known as worker machines, to provision.	A positive integer greater than or equal to <b>2</b> . The default value is <b>3</b> .
<b>controlPlane</b>	The configuration for the machines that comprise the control plane.	Array of <b>MachinePool</b> objects.
<b>controlPlane.architecture</b>	Determines the instruction set architecture of the machines in the pool. Currently, heterogeneous clusters are not supported, so all pools must specify the same architecture. Valid values are <b>ppc64le</b> (the default).	String

Parameter	Description	Values
<b>controlPlane.hyperthreading</b>	<p>Whether to enable or disable simultaneous multithreading, or <b>hyperthreading</b>, on control plane machines. By default, simultaneous multithreading is enabled to increase the performance of your machines' cores.</p> <div style="display: flex; align-items: center;">  <div> <p><b>IMPORTANT</b></p> <p>If you disable simultaneous multithreading, ensure that your capacity planning accounts for the dramatically decreased machine performance.</p> </div> </div>	<b>Enabled</b> or <b>Disabled</b>
<b>controlPlane.name</b>	Required if you use <b>controlPlane</b> . The name of the machine pool.	<b>master</b>
<b>controlPlane.platform</b>	Required if you use <b>controlPlane</b> . Use this parameter to specify the cloud provider that hosts the control plane machines. This parameter value must match the <b>compute.platform</b> parameter value.	<b>alibabacloud, aws, azure, gcp, ibmcloud, openstack, ovirt, vsphere, or {}</b>
<b>controlPlane.replicas</b>	The number of control plane machines to provision.	The only supported value is <b>3</b> , which is the default value.

Parameter	Description	Values
<b>credentialsMode</b>	<p>The Cloud Credential Operator (CCO) mode. If no mode is specified, the CCO dynamically tries to determine the capabilities of the provided credentials, with a preference for mint mode on the platforms where multiple modes are supported.</p> <p> <b>NOTE</b></p> <p>Not all CCO modes are supported for all cloud providers. For more information on CCO modes, see the <i>Cloud Credential Operator</i> entry in the <i>Cluster Operators reference content</i>.</p> <p> <b>NOTE</b></p> <p>If your AWS account has service control policies (SCP) enabled, you must configure the <b>credentialsMode</b> parameter to <b>Mint</b>, <b>Passthrough</b> or <b>Manual</b>.</p>	<b>Mint, Passthrough, Manual</b> or an empty string ("").

Parameter	Description	Values
<b>fips</b>	<p>Enable or disable FIPS mode. The default is <b>false</b> (disabled). If FIPS mode is enabled, the Red Hat Enterprise Linux CoreOS (RHCOS) machines that OpenShift Container Platform runs on bypass the default Kubernetes cryptography suite and use the cryptography modules that are provided with RHCOS instead.</p> <div style="display: flex; align-items: flex-start;"> <div style="width: 20px; height: 100px; background: repeating-linear-gradient(45deg, transparent, transparent 2px, black 2px, black 4px); margin-right: 10px;"></div> <div> <p><b>IMPORTANT</b></p> <p>To enable FIPS mode for your cluster, you must run the installation program from a Red Hat Enterprise Linux (RHEL) computer configured to operate in FIPS mode. For more information about configuring FIPS mode on RHEL, see <a href="#">Installing the system in FIPS mode</a>. The use of FIPS validated or Modules In Process cryptographic libraries is only supported on OpenShift Container Platform deployments on the <b>x86_64</b> architecture.</p> </div> </div> <div style="display: flex; align-items: flex-start; margin-top: 10px;"> <div style="width: 20px; height: 50px; background: repeating-linear-gradient(45deg, transparent, transparent 2px, black 2px, black 4px); margin-right: 10px;"></div> <div> <p><b>NOTE</b></p> <p>If you are using Azure File storage, you cannot enable FIPS mode.</p> </div> </div>	<b>false</b> or <b>true</b>
<b>imageContentSources</b>	Sources and repositories for the release-image content.	Array of objects. Includes a <b>source</b> and, optionally, <b>mirrors</b> , as described in the following rows of this table.
<b>imageContentSources.source</b>	Required if you use <b>imageContentSources</b> . Specify the repository that users refer to, for example, in image pull specifications.	String
<b>imageContentSources.mirrors</b>	Specify one or more repositories that may also contain the same images.	Array of strings

Parameter	Description	Values
<b>publish</b>	How to publish or expose the user-facing endpoints of your cluster, such as the Kubernetes API, OpenShift routes.	<p><b>Internal</b> or <b>External</b>. The default value is <b>External</b>.</p> <p>Setting this field to <b>Internal</b> is not supported on non-cloud platforms and IBM Cloud VPC.</p> <div style="display: flex; align-items: flex-start;">  <div> <p><b>IMPORTANT</b></p> <p>If the value of the field is set to <b>Internal</b>, the cluster will become non-functional. For more information, refer to <a href="#">BZ#1953035</a>.</p> </div> </div>
<b>sshKey</b>	<p>The SSH key or keys to authenticate access your cluster machines.</p> <div style="display: flex; align-items: flex-start;">  <div> <p><b>NOTE</b></p> <p>For production OpenShift Container Platform clusters on which you want to perform installation debugging or disaster recovery, specify an SSH key that your <b>ssh-agent</b> process uses.</p> </div> </div>	<p>One or more keys. For example:</p> <pre>sshKey:   &lt;key1&gt;   &lt;key2&gt;   &lt;key3&gt;</pre>

### 17.3.8.2. Sample install-config.yaml file for IBM Power

You can customize the **install-config.yaml** file to specify more details about your OpenShift Container Platform cluster's platform or modify the values of the required parameters.

```
apiVersion: v1
baseDomain: example.com 1
compute: 2
- hyperthreading: Enabled 3
  name: worker
  replicas: 0 4
  architecture : ppc64le
controlPlane: 5
  hyperthreading: Enabled 6
  name: master
  replicas: 3 7
  architecture : ppc64le
```



**NOTE**

If you are installing a three-node cluster, do not deploy any compute machines when you install the Red Hat Enterprise Linux CoreOS (RHCOS) machines.

- 7 The number of control plane machines that you add to the cluster. Because the cluster uses these values as the number of etcd endpoints in the cluster, the value must match the number of control plane machines that you deploy.
- 8 The cluster name that you specified in your DNS records.
- 9 A block of IP addresses from which pod IP addresses are allocated. This block must not overlap with existing physical networks. These IP addresses are used for the pod network. If you need to access the pods from an external network, you must configure load balancers and routers to manage the traffic.

**NOTE**

Class E CIDR range is reserved for a future use. To use the Class E CIDR range, you must ensure your networking environment accepts the IP addresses within the Class E CIDR range.

- 10 The subnet prefix length to assign to each individual node. For example, if **hostPrefix** is set to **23**, then each node is assigned a **/23** subnet out of the given **cidr**, which allows for 510 ( $2^{(32 - 23)} - 2$ ) pod IP addresses. If you are required to provide access to nodes from an external network, configure load balancers and routers to manage the traffic.
- 11 The IP address pool to use for service IP addresses. You can enter only one IP address pool. This block must not overlap with existing physical networks. If you need to access the services from an external network, configure load balancers and routers to manage the traffic.
- 12 You must set the platform to **none**. You cannot provide additional platform configuration variables for IBM Power infrastructure.

**IMPORTANT**

Clusters that are installed with the platform type **none** are unable to use some features, such as managing compute machines with the Machine API. This limitation applies even if the compute machines that are attached to the cluster are installed on a platform that would normally support the feature. This parameter cannot be changed after installation.

- 13 Whether to enable or disable FIPS mode. By default, FIPS mode is not enabled. If FIPS mode is enabled, the Red Hat Enterprise Linux CoreOS (RHCOS) machines that OpenShift Container Platform runs on bypass the default Kubernetes cryptography suite and use the cryptography modules that are provided with RHCOS instead.





## IMPORTANT

To enable FIPS mode for your cluster, you must run the installation program from a Red Hat Enterprise Linux (RHEL) computer configured to operate in FIPS mode. For more information about configuring FIPS mode on RHEL, see [Installing the system in FIPS mode](#). The use of FIPS validated or Modules In Process cryptographic libraries is only supported on OpenShift Container Platform deployments on the **x86\_64** architecture.

- 14 For **<local\_registry>**, specify the registry domain name, and optionally the port, that your mirror registry uses to serve content. For example, **registry.example.com** or **registry.example.com:5000**. For **<credentials>**, specify the base64-encoded user name and password for your mirror registry.

- 15 The SSH public key for the **core** user in Red Hat Enterprise Linux CoreOS (RHCOS).



## NOTE

For production OpenShift Container Platform clusters on which you want to perform installation debugging or disaster recovery, specify an SSH key that your **ssh-agent** process uses.

- 16 Provide the contents of the certificate file that you used for your mirror registry.

- 17 Provide the **imageContentSources** section from the output of the command to mirror the repository.

### 17.3.8.3. Configuring the cluster-wide proxy during installation

Production environments can deny direct access to the internet and instead have an HTTP or HTTPS proxy available. You can configure a new OpenShift Container Platform cluster to use a proxy by configuring the proxy settings in the **install-config.yaml** file.

#### Prerequisites

- You have an existing **install-config.yaml** file.
- You reviewed the sites that your cluster requires access to and determined whether any of them need to bypass the proxy. By default, all cluster egress traffic is proxied, including calls to hosting cloud provider APIs. You added sites to the **Proxy** object's **spec.noProxy** field to bypass the proxy if necessary.



## NOTE

The **Proxy** object **status.noProxy** field is populated with the values of the **networking.machineNetwork[].cidr**, **networking.clusterNetwork[].cidr**, and **networking.serviceNetwork[]** fields from your installation configuration.

For installations on Amazon Web Services (AWS), Google Cloud Platform (GCP), Microsoft Azure, and Red Hat OpenStack Platform (RHOSP), the **Proxy** object **status.noProxy** field is also populated with the instance metadata endpoint (**169.254.169.254**).

## Procedure

1. Edit your **install-config.yaml** file and add the proxy settings. For example:

```

apiVersion: v1
baseDomain: my.domain.com
proxy:
  httpProxy: http://<username>:<pswd>@<ip>:<port> 1
  httpsProxy: https://<username>:<pswd>@<ip>:<port> 2
  noProxy: example.com 3
additionalTrustBundle: | 4
  -----BEGIN CERTIFICATE-----
  <MY_TRUSTED_CA_CERT>
  -----END CERTIFICATE-----
...

```

- 1 A proxy URL to use for creating HTTP connections outside the cluster. The URL scheme must be **http**.
- 2 A proxy URL to use for creating HTTPS connections outside the cluster.
- 3 A comma-separated list of destination domain names, IP addresses, or other network CIDRs to exclude from proxying. Preface a domain with **.** to match subdomains only. For example, **.y.com** matches **x.y.com**, but not **y.com**. Use **\*** to bypass the proxy for all destinations.
- 4 If provided, the installation program generates a config map that is named **user-ca-bundle** in the **openshift-config** namespace that contains one or more additional CA certificates that are required for proxying HTTPS connections. The Cluster Network Operator then creates a **trusted-ca-bundle** config map that merges these contents with the Red Hat Enterprise Linux CoreOS (RHCOS) trust bundle, and this config map is referenced in the **trustedCA** field of the **Proxy** object. The **additionalTrustBundle** field is required unless the proxy's identity certificate is signed by an authority from the RHCOS trust bundle.

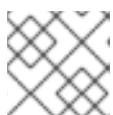

### NOTE

The installation program does not support the proxy **readinessEndpoints** field.

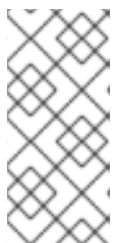

### NOTE

If the installer times out, restart and then complete the deployment by using the **wait-for** command of the installer. For example:

```
$ ./openshift-install wait-for install-complete --log-level debug
```

2. Save the file and reference it when installing OpenShift Container Platform.

The installation program creates a cluster-wide proxy that is named **cluster** that uses the proxy settings in the provided **install-config.yaml** file. If no proxy settings are provided, a **cluster Proxy** object is still created, but it will have a nil **spec**.

**NOTE**

Only the **Proxy** object named **cluster** is supported, and no additional proxies can be created.

**17.3.8.4. Configuring a three-node cluster**

Optionally, you can deploy zero compute machines in a bare metal cluster that consists of three control plane machines only. This provides smaller, more resource efficient clusters for cluster administrators and developers to use for testing, development, and production.

In three-node OpenShift Container Platform environments, the three control plane machines are schedulable, which means that your application workloads are scheduled to run on them.

**Prerequisites**

- You have an existing **install-config.yaml** file.

**Procedure**

- Ensure that the number of compute replicas is set to **0** in your **install-config.yaml** file, as shown in the following **compute** stanza:

```
compute:
- name: worker
  platform: {}
  replicas: 0
```

**NOTE**

You must set the value of the **replicas** parameter for the compute machines to **0** when you install OpenShift Container Platform on user-provisioned infrastructure, regardless of the number of compute machines you are deploying. In installer-provisioned installations, the parameter controls the number of compute machines that the cluster creates and manages for you. This does not apply to user-provisioned installations, where the compute machines are deployed manually.

For three-node cluster installations, follow these next steps:

- If you are deploying a three-node cluster with zero compute nodes, the Ingress Controller pods run on the control plane nodes. In three-node cluster deployments, you must configure your application ingress load balancer to route HTTP and HTTPS traffic to the control plane nodes. See the *Load balancing requirements for user-provisioned infrastructure* section for more information.
- When you create the Kubernetes manifest files in the following procedure, ensure that the **mastersSchedulable** parameter in the **<installation\_directory>/manifests/cluster-scheduler-02-config.yml** file is set to **true**. This enables your application workloads to run on the control plane nodes.
- Do not deploy any compute nodes when you create the Red Hat Enterprise Linux CoreOS (RHCOS) machines.

### 17.3.9. Cluster Network Operator configuration

The configuration for the cluster network is specified as part of the Cluster Network Operator (CNO) configuration and stored in a custom resource (CR) object that is named **cluster**. The CR specifies the fields for the **Network** API in the **operator.openshift.io** API group.

The CNO configuration inherits the following fields during cluster installation from the **Network** API in the **Network.config.openshift.io** API group and these fields cannot be changed:

#### **clusterNetwork**

IP address pools from which pod IP addresses are allocated.

#### **serviceNetwork**

IP address pool for services.

#### **defaultNetwork.type**

Cluster network provider, such as OpenShift SDN or OVN-Kubernetes.

You can specify the cluster network provider configuration for your cluster by setting the fields for the **defaultNetwork** object in the CNO object named **cluster**.

#### 17.3.9.1. Cluster Network Operator configuration object

The fields for the Cluster Network Operator (CNO) are described in the following table:

**Table 17.30. Cluster Network Operator configuration object**

Field	Type	Description
<b>metadata.name</b>	<b>string</b>	The name of the CNO object. This name is always <b>cluster</b> .
<b>spec.clusterNetwork</b>	<b>array</b>	<p>A list specifying the blocks of IP addresses from which pod IP addresses are allocated and the subnet prefix length assigned to each individual node in the cluster. For example:</p> <pre>spec:   clusterNetwork:   - cidr: 10.128.0.0/19     hostPrefix: 23   - cidr: 10.128.32.0/19     hostPrefix: 23</pre> <p>You can customize this field only in the <b>install-config.yaml</b> file before you create the manifests. The value is read-only in the manifest file.</p>

Field	Type	Description
<b>spec.serviceNetwork</b>	<b>array</b>	<p>A block of IP addresses for services. The OpenShift SDN and OVN-Kubernetes Container Network Interface (CNI) network providers support only a single IP address block for the service network. For example:</p> <pre>spec:   serviceNetwork:   - 172.30.0.0/14</pre> <p>You can customize this field only in the <b>install-config.yaml</b> file before you create the manifests. The value is read-only in the manifest file.</p>
<b>spec.defaultNetwork</b>	<b>object</b>	Configures the Container Network Interface (CNI) cluster network provider for the cluster network.
<b>spec.kubeProxyConfig</b>	<b>object</b>	The fields for this object specify the kube-proxy configuration. If you are using the OVN-Kubernetes cluster network provider, the kube-proxy configuration has no effect.

#### defaultNetwork object configuration

The values for the **defaultNetwork** object are defined in the following table:

Table 17.31. **defaultNetwork** object

Field	Type	Description
<b>type</b>	<b>string</b>	<p>Either <b>OpenShiftSDN</b> or <b>OVNKubernetes</b>. The cluster network provider is selected during installation. This value cannot be changed after cluster installation.</p> <div style="display: flex; align-items: flex-start;"> <div style="flex: 1;">  </div> <div style="flex: 1;"> <p><b>NOTE</b></p> <p>OpenShift Container Platform uses the OpenShift SDN Container Network Interface (CNI) cluster network provider by default.</p> </div> </div>
<b>openshiftSDNConfig</b>	<b>object</b>	This object is only valid for the OpenShift SDN cluster network provider.
<b>ovnKubernetesConfig</b>	<b>object</b>	This object is only valid for the OVN-Kubernetes cluster network provider.

#### Configuration for the OpenShift SDN CNI cluster network provider

The following table describes the configuration fields for the OpenShift SDN Container Network Interface (CNI) cluster network provider.

Table 17.32. openshiftSDNConfig object

Field	Type	Description
<b>mode</b>	<b>string</b>	<p>Configures the network isolation mode for OpenShift SDN. The default value is <b>NetworkPolicy</b>.</p> <p>The values <b>Multitenant</b> and <b>Subnet</b> are available for backwards compatibility with OpenShift Container Platform 3.x but are not recommended. This value cannot be changed after cluster installation.</p>
<b>mtu</b>	<b>integer</b>	<p>The maximum transmission unit (MTU) for the VXLAN overlay network. This is detected automatically based on the MTU of the primary network interface. You do not normally need to override the detected MTU.</p> <p>If the auto-detected value is not what you expect it to be, confirm that the MTU on the primary network interface on your nodes is correct. You cannot use this option to change the MTU value of the primary network interface on the nodes.</p> <p>If your cluster requires different MTU values for different nodes, you must set this value to <b>50</b> less than the lowest MTU value in your cluster. For example, if some nodes in your cluster have an MTU of <b>9001</b>, and some have an MTU of <b>1500</b>, you must set this value to <b>1450</b>.</p> <p>This value cannot be changed after cluster installation.</p>
<b>vxlanPort</b>	<b>integer</b>	<p>The port to use for all VXLAN packets. The default value is <b>4789</b>. This value cannot be changed after cluster installation.</p> <p>If you are running in a virtualized environment with existing nodes that are part of another VXLAN network, then you might be required to change this. For example, when running an OpenShift SDN overlay on top of VMware NSX-T, you must select an alternate port for the VXLAN, because both SDNs use the same default VXLAN port number.</p> <p>On Amazon Web Services (AWS), you can select an alternate port for the VXLAN between port <b>9000</b> and port <b>9999</b>.</p>

### Example OpenShift SDN configuration

```
defaultNetwork:
  type: OpenShiftSDN
  openshiftSDNConfig:
    mode: NetworkPolicy
    mtu: 1450
    vxlanPort: 4789
```

### Configuration for the OVN-Kubernetes CNI cluster network provider

The following table describes the configuration fields for the OVN-Kubernetes CNI cluster network provider.

Table 17.33. `ovnKubernetesConfig` object

Field	Type	Description
<code>mtu</code>	<code>integer</code>	<p>The maximum transmission unit (MTU) for the Geneve (Generic Network Virtualization Encapsulation) overlay network. This is detected automatically based on the MTU of the primary network interface. You do not normally need to override the detected MTU.</p> <p>If the auto-detected value is not what you expect it to be, confirm that the MTU on the primary network interface on your nodes is correct. You cannot use this option to change the MTU value of the primary network interface on the nodes.</p> <p>If your cluster requires different MTU values for different nodes, you must set this value to <b>100</b> less than the lowest MTU value in your cluster. For example, if some nodes in your cluster have an MTU of <b>9001</b>, and some have an MTU of <b>1500</b>, you must set this value to <b>1400</b>.</p>
<code>genevePort</code>	<code>integer</code>	The port to use for all Geneve packets. The default value is <b>6081</b> . This value cannot be changed after cluster installation.
<code>ipsecConfig</code>	<code>object</code>	Specify an empty object to enable IPsec encryption. This value cannot be changed after cluster installation.
<code>policyAuditConfig</code>	<code>object</code>	Specify a configuration object for customizing network policy audit logging. If unset, the defaults audit log settings are used.
<code>gatewayConfig</code>	<code>object</code>	<p>Optional: Specify a configuration object for customizing how egress traffic is sent to the node gateway.</p> <div style="display: flex; align-items: flex-start;"> <div style="flex: 1;">  </div> <div style="flex: 1; padding-left: 10px;"> <p><b>NOTE</b></p> <p>While migrating egress traffic, you can expect some disruption to workloads and service traffic until the Cluster Network Operator (CNO) successfully rolls out the changes.</p> </div> </div>

Table 17.34. `policyAuditConfig` object

Field	Type	Description
<code>rateLimit</code>	<code>integer</code>	The maximum number of messages to generate every second per node. The default value is <b>20</b> messages per second.

Field	Type	Description
<b>maxFileSize</b>	integer	The maximum size for the audit log in bytes. The default value is <b>50000000</b> or 50 MB.
<b>destination</b>	string	One of the following additional audit log targets:  <b>libc</b> The libc <b>syslog()</b> function of the journald process on the host. <b>udp:&lt;host&gt;:&lt;port&gt;</b> A syslog server. Replace <b>&lt;host&gt;:&lt;port&gt;</b> with the host and port of the syslog server. <b>unix:&lt;file&gt;</b> A Unix Domain Socket file specified by <b>&lt;file&gt;</b> . <b>null</b> Do not send the audit logs to any additional target.
<b>syslogFacility</b>	string	The syslog facility, such as <b>kern</b> , as defined by RFC5424. The default value is <b>local0</b> .

Table 17.35. gatewayConfig object

Field	Type	Description
<b>routingViaHost</b>	<b>boolean</b>	Set this field to <b>true</b> to send egress traffic from pods to the host networking stack. For highly-specialized installations and applications that rely on manually configured routes in the kernel routing table, you might want to route egress traffic to the host networking stack. By default, egress traffic is processed in OVN to exit the cluster and is not affected by specialized routes in the kernel routing table. The default value is <b>false</b> .  This field has an interaction with the Open vSwitch hardware offloading feature. If you set this field to <b>true</b> , you do not receive the performance benefits of the offloading because egress traffic is processed by the host networking stack.

### Example OVN-Kubernetes configuration with IPsec enabled

```
defaultNetwork:
  type: OVNKubernetes
  ovnKubernetesConfig:
    mtu: 1400
    genevePort: 6081
    ipsecConfig: {}
```

### kubeProxyConfig object configuration

The values for the **kubeProxyConfig** object are defined in the following table:



Table 17.36. kubeProxyConfig object

Field	Type	Description
<b>iptablesSyncPeriod</b>	<b>string</b>	<p>The refresh period for <b>iptables</b> rules. The default value is <b>30s</b>. Valid suffixes include <b>s</b>, <b>m</b>, and <b>h</b> and are described in the <a href="#">Go time package</a> documentation.</p> <div style="display: flex; align-items: flex-start;"> <div style="width: 40px; height: 100px; background: repeating-linear-gradient(45deg, transparent, transparent 2px, #ccc 2px, #ccc 4px); margin-right: 10px;"></div> <div> <p><b>NOTE</b></p> <p>Because of performance improvements introduced in OpenShift Container Platform 4.3 and greater, adjusting the <b>iptablesSyncPeriod</b> parameter is no longer necessary.</p> </div> </div>
<b>proxyArguments.iptables-min-sync-period</b>	<b>array</b>	<p>The minimum duration before refreshing <b>iptables</b> rules. This field ensures that the refresh does not happen too frequently. Valid suffixes include <b>s</b>, <b>m</b>, and <b>h</b> and are described in the <a href="#">Go time package</a>. The default value is:</p> <pre>kubeProxyConfig:   proxyArguments:     iptables-min-sync-period:       - 0s</pre>

### 17.3.10. Creating the Kubernetes manifest and Ignition config files

Because you must modify some cluster definition files and manually start the cluster machines, you must generate the Kubernetes manifest and Ignition config files that the cluster needs to configure the machines.

The installation configuration file transforms into the Kubernetes manifests. The manifests wrap into the Ignition configuration files, which are later used to configure the cluster machines.



#### IMPORTANT

- The Ignition config files that the OpenShift Container Platform installation program generates contain certificates that expire after 24 hours, which are then renewed at that time. If the cluster is shut down before renewing the certificates and the cluster is later restarted after the 24 hours have elapsed, the cluster automatically recovers the expired certificates. The exception is that you must manually approve the pending **node-bootstrapper** certificate signing requests (CSRs) to recover kubelet certificates. See the documentation for *Recovering from expired control plane certificates* for more information.
- It is recommended that you use Ignition config files within 12 hours after they are generated because the 24-hour certificate rotates from 16 to 22 hours after the cluster is installed. By using the Ignition config files within 12 hours, you can avoid installation failure if the certificate update runs during installation.

**NOTE**

The installation program that generates the manifest and Ignition files is architecture specific and can be obtained from the [client image mirror](#). The Linux version of the installation program runs on ppc64le only. This installer program is also available as a Mac OS version.

**Prerequisites**

- You obtained the OpenShift Container Platform installation program. For a restricted network installation, these files are on your mirror host.
- You created the **install-config.yaml** installation configuration file.

**Procedure**

1. Change to the directory that contains the OpenShift Container Platform installation program and generate the Kubernetes manifests for the cluster:

```
$ ./openshift-install create manifests --dir <installation_directory> 1
```

- 1** For **<installation\_directory>**, specify the installation directory that contains the **install-config.yaml** file you created.

**WARNING**

If you are installing a three-node cluster, skip the following step to allow the control plane nodes to be schedulable.

**IMPORTANT**

When you configure control plane nodes from the default unschedulable to schedulable, additional subscriptions are required. This is because control plane nodes then become worker nodes.

2. Check that the **mastersSchedulable** parameter in the **<installation\_directory>/manifests/cluster-scheduler-02-config.yml** Kubernetes manifest file is set to **false**. This setting prevents pods from being scheduled on the control plane machines:
  - a. Open the **<installation\_directory>/manifests/cluster-scheduler-02-config.yml** file.
  - b. Locate the **mastersSchedulable** parameter and ensure that it is set to **false**.
  - c. Save and exit the file.
3. To create the Ignition configuration files, run the following command from the directory that contains the installation program:

```
$ ./openshift-install create ignition-configs --dir <installation_directory> 1
```

1 For **<installation\_directory>**, specify the same installation directory.

Ignition config files are created for the bootstrap, control plane, and compute nodes in the installation directory. The **kubeadmin-password** and **kubeconfig** files are created in the **./<installation\_directory>/auth** directory:

```
.
├── auth
│   ├── kubeadmin-password
│   └── kubeconfig
├── bootstrap.ign
├── master.ign
├── metadata.json
└── worker.ign
```

### 17.3.11. Installing RHCOS and starting the OpenShift Container Platform bootstrap process

To install OpenShift Container Platform on IBM Power infrastructure that you provision, you must install Red Hat Enterprise Linux CoreOS (RHCOS) on the machines. When you install RHCOS, you must provide the Ignition config file that was generated by the OpenShift Container Platform installation program for the type of machine you are installing. If you have configured suitable networking, DNS, and load balancing infrastructure, the OpenShift Container Platform bootstrap process begins automatically after the RHCOS machines have rebooted.

Follow either the steps to use an ISO image or network PXE booting to install RHCOS on the machines.

#### 17.3.11.1. Installing RHCOS by using an ISO image

You can use an ISO image to install RHCOS on the machines.

##### Prerequisites

- You have created the Ignition config files for your cluster.
- You have configured suitable network, DNS and load balancing infrastructure.
- You have an HTTP server that can be accessed from your computer, and from the machines that you create.
- You have reviewed the *Advanced RHCOS installation configuration* section for different ways to configure features, such as networking and disk partitioning.

##### Procedure

1. Obtain the SHA512 digest for each of your Ignition config files. For example, you can use the following on a system running Linux to get the SHA512 digest for your **bootstrap.ign** Ignition config file:

```
$ sha512sum <installation_directory>/bootstrap.ign
```

The digests are provided to the **coreos-installer** in a later step to validate the authenticity of the Ignition config files on the cluster nodes.

2. Upload the bootstrap, control plane, and compute node Ignition config files that the installation program created to your HTTP server. Note the URLs of these files.

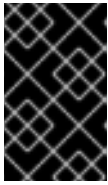

### IMPORTANT

You can add or change configuration settings in your Ignition configs before saving them to your HTTP server. If you plan to add more compute machines to your cluster after you finish installation, do not delete these files.

3. From the installation host, validate that the Ignition config files are available on the URLs. The following example gets the Ignition config file for the bootstrap node:

```
$ curl -k http://<HTTP_server>/bootstrap.ign 1
```

### Example output

```
% Total    % Received % Xferd  Average Speed   Time    Time     Time  Current
           Dload  Upload  Total   Spent    Left     Speed
  0   0   0   0   0   0   0   0   0  --:--:-- --:--:-- --:--:--    0{"ignition":
{"version":"3.2.0"},"passwd":{"users":[{"name":"core","sshAuthorizedKeys":["ssh-rsa...
```

Replace **bootstrap.ign** with **master.ign** or **worker.ign** in the command to validate that the Ignition config files for the control plane and compute nodes are also available.

4. Although it is possible to obtain the RHCOS images that are required for your preferred method of installing operating system instances from the [RHCOS image mirror](#) page, the recommended way to obtain the correct version of your RHCOS images are from the output of **openshift-install** command:

```
$ openshift-install coreos print-stream-json | grep '\.iso[^\.]'
```

### Example output

```
"location": "<url>/art/storage/releases/rhcos-4.10-aarch64/<release>/aarch64/rhcos-
<release>-live.aarch64.iso",
"location": "<url>/art/storage/releases/rhcos-4.10-ppc64le/<release>/ppc64le/rhcos-
<release>-live.ppc64le.iso",
"location": "<url>/art/storage/releases/rhcos-4.10-s390x/<release>/s390x/rhcos-<release>-
live.s390x.iso",
"location": "<url>/art/storage/releases/rhcos-4.10/<release>/x86_64/rhcos-<release>-
live.x86_64.iso",
```



### IMPORTANT

The RHCOS images might not change with every release of OpenShift Container Platform. You must download images with the highest version that is less than or equal to the OpenShift Container Platform version that you install. Use the image versions that match your OpenShift Container Platform version if they are available. Use only ISO images for this procedure. RHCOS qcow2 images are not supported for this installation type.

ISO file names resemble the following example:

**rhcos-<version>-live.<architecture>.iso**

5. Use the ISO to start the RHCOS installation. Use one of the following installation options:
  - Burn the ISO image to a disk and boot it directly.
  - Use ISO redirection by using a lights-out management (LOM) interface.
6. Boot the RHCOS ISO image without specifying any options or interrupting the live boot sequence. Wait for the installer to boot into a shell prompt in the RHCOS live environment.

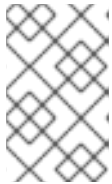

**NOTE**

It is possible to interrupt the RHCOS installation boot process to add kernel arguments. However, for this ISO procedure you should use the **coreos-installer** command as outlined in the following steps, instead of adding kernel arguments.

7. Run the **coreos-installer** command and specify the options that meet your installation requirements. At a minimum, you must specify the URL that points to the Ignition config file for the node type, and the device that you are installing to:

```
$ sudo coreos-installer install --ignition-url=http://<HTTP_server>/<node_type>.ign <device>
--ignition-hash=sha512-<digest> 1 2
```

- 1 1 You must run the **coreos-installer** command by using **sudo**, because the **core** user does not have the required root privileges to perform the installation.

- 2 The **--ignition-hash** option is required when the Ignition config file is obtained through an HTTP URL to validate the authenticity of the Ignition config file on the cluster node. **<digest>** is the Ignition config file SHA512 digest obtained in a preceding step.

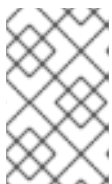

**NOTE**

If you want to provide your Ignition config files through an HTTPS server that uses TLS, you can add the internal certificate authority (CA) to the system trust store before running **coreos-installer**.

The following example initializes a bootstrap node installation to the **/dev/sda** device. The Ignition config file for the bootstrap node is obtained from an HTTP web server with the IP address 192.168.1.2:

```
$ sudo coreos-installer install --ignition-
url=http://192.168.1.2:80/installation_directory/bootstrap.ign /dev/sda --ignition-hash=sha512-
a5a2d43879223273c9b60af66b44202a1d1248fc01cf156c46d4a79f552b6bad47bc8cc78ddf011
6e80c59d2ea9e32ba53bc807afbca581aa059311def2c3e3b
```

8. Monitor the progress of the RHCOS installation on the console of the machine.

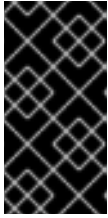

## IMPORTANT

Be sure that the installation is successful on each node before commencing with the OpenShift Container Platform installation. Observing the installation process can also help to determine the cause of RHCOS installation issues that might arise.

9. After RHCOS installs, you must reboot the system. During the system reboot, it applies the Ignition config file that you specified.
10. Check the console output to verify that Ignition ran.

### Example command

```
Ignition: ran on 2022/03/14 14:48:33 UTC (this boot)
Ignition: user-provided config was applied
```

11. Continue to create the other machines for your cluster.



## IMPORTANT

You must create the bootstrap and control plane machines at this time. If the control plane machines are not made schedulable, also create at least two compute machines before you install OpenShift Container Platform.

If the required network, DNS, and load balancer infrastructure are in place, the OpenShift Container Platform bootstrap process begins automatically after the RHCOS nodes have rebooted.



## NOTE

RHCOS nodes do not include a default password for the **core** user. You can access the nodes by running **ssh core@<node>.<cluster\_name>.<base\_domain>** as a user with access to the SSH private key that is paired to the public key that you specified in your **install\_config.yaml** file. OpenShift Container Platform 4 cluster nodes running RHCOS are immutable and rely on Operators to apply cluster changes. Accessing cluster nodes by using SSH is not recommended. However, when investigating installation issues, if the OpenShift Container Platform API is not available, or the kubelet is not properly functioning on a target node, SSH access might be required for debugging or disaster recovery.

### 17.3.11.1.1. Advanced RHCOS installation reference

This section illustrates the networking configuration and other advanced options that allow you to modify the Red Hat Enterprise Linux CoreOS (RHCOS) manual installation process. The following tables describe the kernel arguments and command-line options you can use with the RHCOS live installer and the **coreos-installer** command.

#### 17.3.11.1.1.1. Networking and bonding options for ISO installations

If you install RHCOS from an ISO image, you can add kernel arguments manually when you boot the image to configure networking for a node. If no networking arguments are specified, DHCP is activated in the initramfs when RHCOS detects that networking is required to fetch the Ignition config file.

**IMPORTANT**

When adding networking arguments manually, you must also add the **rd.neednet=1** kernel argument to bring the network up in the initramfs.

The following table provides examples for configuring networking and bonding on your RHCOS nodes for ISO installations. The examples describe how to use the **ip=**, **nameserver=**, and **bond=** kernel arguments.

**NOTE**

Ordering is important when adding the kernel arguments: **ip=**, **nameserver=**, and then **bond=**.

The networking options are passed to the **dracut** tool during system boot. For more information about the networking options supported by **dracut**, see the **dracut.cmdline** manual page.

The following examples are the networking options for ISO installation.

## Configuring DHCP or static IP addresses

To configure an IP address, either use DHCP (**ip=dhcp**) or set an individual static IP address (**ip=<host\_ip>**). If setting a static IP, you must then identify the DNS server IP address (**nameserver=<dns\_ip>**) on each node. The following example sets:

- The node's IP address to **10.10.10.2**
- The gateway address to **10.10.10.254**
- The netmask to **255.255.255.0**
- The hostname to **core0.example.com**
- The DNS server address to **4.4.4.41**
- The auto-configuration value to **none**. No auto-configuration is required when IP networking is configured statically.

```
ip=10.10.10.2::10.10.10.254:255.255.255.0:core0.example.com:enp1s0:none
nameserver=4.4.4.41
```

**NOTE**

When you use DHCP to configure IP addressing for the RHCOS machines, the machines also obtain the DNS server information through DHCP. For DHCP-based deployments, you can define the DNS server address that is used by the RHCOS nodes through your DHCP server configuration.

## Configuring an IP address without a static hostname

You can configure an IP address without assigning a static hostname. If a static hostname is not set by the user, it will be picked up and automatically set by a reverse DNS lookup. To configure an IP address without a static hostname refer to the following example:

- The node's IP address to **10.10.10.2**

- The gateway address to **10.10.10.254**
- The netmask to **255.255.255.0**
- The DNS server address to **4.4.4.41**
- The auto-configuration value to **none**. No auto-configuration is required when IP networking is configured statically.

```
ip=10.10.10.2::10.10.10.254:255.255.255.0::enp1s0:none
nameserver=4.4.4.41
```

#### Specifying multiple network interfaces

You can specify multiple network interfaces by setting multiple **ip=** entries.

```
ip=10.10.10.2::10.10.10.254:255.255.255.0:core0.example.com:enp1s0:none
ip=10.10.10.3::10.10.10.254:255.255.255.0:core0.example.com:enp2s0:none
```

#### Configuring default gateway and route

Optional: You can configure routes to additional networks by setting an **rd.route=** value.



#### NOTE

When you configure one or multiple networks, one default gateway is required. If the additional network gateway is different from the primary network gateway, the default gateway must be the primary network gateway.

- Run the following command to configure the default gateway:

```
ip=::10.10.10.254:::
```

- Enter the following command to configure the route for the additional network:

```
rd.route=20.20.20.0/24:20.20.20.254:enp2s0
```

#### Disabling DHCP on a single interface

You can disable DHCP on a single interface, such as when there are two or more network interfaces and only one interface is being used. In the example, the **enp1s0** interface has a static networking configuration and DHCP is disabled for **enp2s0**, which is not used:

```
ip=10.10.10.2::10.10.10.254:255.255.255.0:core0.example.com:enp1s0:none
ip=::::core0.example.com:enp2s0:none
```

#### Combining DHCP and static IP configurations

You can combine DHCP and static IP configurations on systems with multiple network interfaces, for example:

```
ip=enp1s0:dhcp
ip=10.10.10.2::10.10.10.254:255.255.255.0:core0.example.com:enp2s0:none
```

#### Configuring VLANs on individual interfaces

Optional: You can configure VLANs on individual interfaces by using the **vlan=** parameter.



- To configure a VLAN on a network interface and use a static IP address, run the following command:

```
ip=10.10.10.2::10.10.10.254:255.255.255.0:core0.example.com:enp2s0.100:none
vlan=enp2s0.100:enp2s0
```

- To configure a VLAN on a network interface and to use DHCP, run the following command:

```
ip=enp2s0.100:dhcp
vlan=enp2s0.100:enp2s0
```

#### Providing multiple DNS servers

You can provide multiple DNS servers by adding a **nameserver=** entry for each server, for example:

```
nameserver=1.1.1.1
nameserver=8.8.8.8
```

#### Bonding multiple network interfaces to a single interface

Optional: You can bond multiple network interfaces to a single interface by using the **bond=** option.

Refer to the following examples:

- The syntax for configuring a bonded interface is: **bond=name[:network\_interfaces][:options]** *name* is the bonding device name (**bond0**), *network\_interfaces* represents a comma-separated list of physical (ethernet) interfaces (**em1,em2**), and *options* is a comma-separated list of bonding options. Enter **modinfo bonding** to see available options.
- When you create a bonded interface using **bond=**, you must specify how the IP address is assigned and other information for the bonded interface.
- To configure the bonded interface to use DHCP, set the bond's IP address to **dhcp**. For example:

```
bond=bond0:em1,em2:mode=active-backup
ip=bond0:dhcp
```

- To configure the bonded interface to use a static IP address, enter the specific IP address you want and related information. For example:

```
bond=bond0:em1,em2:mode=active-backup
ip=10.10.10.2::10.10.10.254:255.255.255.0:core0.example.com:bond0:none
```

#### Bonding multiple network interfaces to a single interface

Optional: You can configure VLANs on bonded interfaces by using the **vlan=** parameter and to use DHCP, for example:

```
ip=bond0.100:dhcp
bond=bond0:em1,em2:mode=active-backup
vlan=bond0.100:bond0
```

Use the following example to configure the bonded interface with a VLAN and to use a static IP address:

```
ip=10.10.10.2::10.10.10.254:255.255.255.0:core0.example.com:bond0.100:none
bond=bond0:em1,em2:mode=active-backup
vlan=bond0.100:bond0
```

Using network teaming

Optional: You can use a network teaming as an alternative to bonding by using the **team=** parameter:

- The syntax for configuring a team interface is: **team=name[:network\_interfaces]**  
*name* is the team device name (**team0**) and *network\_interfaces* represents a comma-separated list of physical (ethernet) interfaces (**em1, em2**).

Teaming is planned to be deprecated when RHCOS switches to an upcoming version of RHEL. For more information, see this [Red Hat Knowledgebase Article](#) .

Use the following example to configure a network team:

```
team=team0:em1,em2
ip=team0:dhcp
```

### 17.3.11.2. Installing RHCOS by using PXE booting

You can use PXE booting to install RHCOS on the machines.

#### Prerequisites

- You have created the Ignition config files for your cluster.
- You have configured suitable network, DNS and load balancing infrastructure.
- You have configured suitable PXE infrastructure.
- You have an HTTP server that can be accessed from your computer, and from the machines that you create.
- You have reviewed the *Advanced RHCOS installation configuration* section for different ways to configure features, such as networking and disk partitioning.

#### Procedure

1. Upload the bootstrap, control plane, and compute node Ignition config files that the installation program created to your HTTP server. Note the URLs of these files.



#### IMPORTANT

You can add or change configuration settings in your Ignition configs before saving them to your HTTP server. If you plan to add more compute machines to your cluster after you finish installation, do not delete these files.

2. From the installation host, validate that the Ignition config files are available on the URLs. The following example gets the Ignition config file for the bootstrap node:

```
$ curl -k http://<HTTP_server>/bootstrap.ign 1
```

## Example output

```
% Total % Received % Xferd Average Speed Time Time Time Current
          Dload Upload Total Spent Left Speed
  0  0  0  0  0  0  0  0  --:--:-- --:--:-- --:--:-- 0{"ignition":
{"version":"3.2.0"},"passwd":{"users":[{"name":"core","sshAuthorizedKeys":["ssh-rsa...
```

Replace **bootstrap.ign** with **master.ign** or **worker.ign** in the command to validate that the Ignition config files for the control plane and compute nodes are also available.

- Although it is possible to obtain the RHCOS **kernel**, **initramfs** and **rootfs** files that are required for your preferred method of installing operating system instances from the [RHCOS image mirror](#)[RHCOS image mirror](#) page, the recommended way to obtain the correct version of your RHCOS files are from the output of **openshift-install** command:

```
$ openshift-install coreos print-stream-json | grep -Eo "https.*(kernel|initramfs|rootfs.)w+(\.img)?"
```

## Example output

```
"<url>/art/storage/releases/rhcos-4.10-aarch64/<release>/aarch64/rhcos-<release>-live-
kernel-aarch64"
"<url>/art/storage/releases/rhcos-4.10-aarch64/<release>/aarch64/rhcos-<release>-live-
initramfs.aarch64.img"
"<url>/art/storage/releases/rhcos-4.10-aarch64/<release>/aarch64/rhcos-<release>-live-
rootfs.aarch64.img"
"<url>/art/storage/releases/rhcos-4.10-ppc64le/49.84.202110081256-0/ppc64le/rhcos-
<release>-live-kernel-ppc64le"
"<url>/art/storage/releases/rhcos-4.10-ppc64le/<release>/ppc64le/rhcos-<release>-live-
initramfs.ppc64le.img"
"<url>/art/storage/releases/rhcos-4.10-ppc64le/<release>/ppc64le/rhcos-<release>-live-
rootfs.ppc64le.img"
"<url>/art/storage/releases/rhcos-4.10-s390x/<release>/s390x/rhcos-<release>-live-kernel-
s390x"
"<url>/art/storage/releases/rhcos-4.10-s390x/<release>/s390x/rhcos-<release>-live-
initramfs.s390x.img"
"<url>/art/storage/releases/rhcos-4.10-s390x/<release>/s390x/rhcos-<release>-live-
rootfs.s390x.img"
"<url>/art/storage/releases/rhcos-4.10/<release>/x86_64/rhcos-<release>-live-kernel-
x86_64"
"<url>/art/storage/releases/rhcos-4.10/<release>/x86_64/rhcos-<release>-live-
initramfs.x86_64.img"
"<url>/art/storage/releases/rhcos-4.10/<release>/x86_64/rhcos-<release>-live-
rootfs.x86_64.img"
```



### IMPORTANT

The RHCOS artifacts might not change with every release of OpenShift Container Platform. You must download images with the highest version that is less than or equal to the OpenShift Container Platform version that you install. Only use the appropriate **kernel**, **initramfs**, and **rootfs** artifacts described below for this procedure. RHCOS QCOW2 images are not supported for this installation type.

The file names contain the OpenShift Container Platform version number. They resemble the following examples:

- **kernel:** `rhcos-<version>-live-kernel-<architecture>`
- **initramfs:** `rhcos-<version>-live-initramfs.<architecture>.img`
- **rootfs:** `rhcos-<version>-live-rootfs.<architecture>.img`

4. Upload the **rootfs**, **kernel**, and **initramfs** files to your HTTP server.

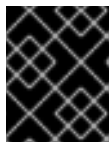

### IMPORTANT

If you plan to add more compute machines to your cluster after you finish installation, do not delete these files.

5. Configure the network boot infrastructure so that the machines boot from their local disks after RHCOS is installed on them.
6. Configure PXE installation for the RHCOS images and begin the installation. Modify the following example menu entry for your environment and verify that the image and Ignition files are properly accessible:

```

DEFAULT pxeboot
TIMEOUT 20
PROMPT 0
LABEL pxeboot
  KERNEL http://<HTTP_server>/rhcos-<version>-live-kernel-<architecture> 1
  APPEND initrd=http://<HTTP_server>/rhcos-<version>-live-initramfs.<architecture>.img
  coreos.live.rootfs_url=http://<HTTP_server>/rhcos-<version>-live-rootfs.<architecture>.img
  coreos.inst.install_dev=/dev/sda coreos.inst.ignition_url=http://<HTTP_server>/bootstrap.ign
2 3

```

- 1** Specify the location of the live **kernel** file that you uploaded to your HTTP server. The URL must be HTTP, TFTP, or FTP; HTTPS and NFS are not supported.
- 2** If you use multiple NICs, specify a single interface in the **ip** option. For example, to use DHCP on a NIC that is named **eno1**, set **ip=eno1:dhcp**.
- 3** Specify the locations of the RHCOS files that you uploaded to your HTTP server. The **initrd** parameter value is the location of the **initramfs** file, the **coreos.live.rootfs\_url** parameter value is the location of the **rootfs** file, and the **coreos.inst.ignition\_url** parameter value is the location of the bootstrap Ignition config file. You can also add more kernel arguments to the **APPEND** line to configure networking or other boot options.



### NOTE

This configuration does not enable serial console access on machines with a graphical console. To configure a different console, add one or more **console=** arguments to the **APPEND** line. For example, add **console=tty0 console=ttyS0** to set the first PC serial port as the primary console and the graphical console as a secondary console. For more information, see [How does one set up a serial terminal and/or console in Red Hat Enterprise Linux?](#)

7. Monitor the progress of the RHCOS installation on the console of the machine.



### IMPORTANT

Be sure that the installation is successful on each node before commencing with the OpenShift Container Platform installation. Observing the installation process can also help to determine the cause of RHCOS installation issues that might arise.

8. After RHCOS installs, the system reboots. During reboot, the system applies the Ignition config file that you specified.
9. Check the console output to verify that Ignition ran.

### Example command

```
Ignition: ran on 2022/03/14 14:48:33 UTC (this boot)
Ignition: user-provided config was applied
```

10. Continue to create the machines for your cluster.



### IMPORTANT

You must create the bootstrap and control plane machines at this time. If the control plane machines are not made schedulable, also create at least two compute machines before you install the cluster.

If the required network, DNS, and load balancer infrastructure are in place, the OpenShift Container Platform bootstrap process begins automatically after the RHCOS nodes have rebooted.



### NOTE

RHCOS nodes do not include a default password for the **core** user. You can access the nodes by running **ssh core@<node>.<cluster\_name>.<base\_domain>** as a user with access to the SSH private key that is paired to the public key that you specified in your **install\_config.yaml** file. OpenShift Container Platform 4 cluster nodes running RHCOS are immutable and rely on Operators to apply cluster changes. Accessing cluster nodes by using SSH is not recommended. However, when investigating installation issues, if the OpenShift Container Platform API is not available, or the kubelet is not properly functioning on a target node, SSH access might be required for debugging or disaster recovery.

#### 17.3.11.3. Enabling multipathing with kernel arguments on RHCOS

In OpenShift Container Platform 4.9 or later, during installation, you can enable multipathing for provisioned nodes. RHCOS supports multipathing on the primary disk. Multipathing provides added benefits of stronger resilience to hardware failure to achieve higher host availability.

During the initial cluster creation, you might want to add kernel arguments to all master or worker nodes. To add kernel arguments to master or worker nodes, you can create a **MachineConfig** object and inject that object into the set of manifest files used by Ignition during cluster setup.

## Procedure

1. Change to the directory that contains the installation program and generate the Kubernetes manifests for the cluster:

```
$ ./openshift-install create manifests --dir <installation_directory>
```

2. Decide if you want to add kernel arguments to worker or control plane nodes.
  - Create a machine config file. For example, create a **99-master-kargs-mpath.yaml** that instructs the cluster to add the **master** label and identify the multipath kernel argument:

```
apiVersion: machineconfiguration.openshift.io/v1
kind: MachineConfig
metadata:
  labels:
    machineconfiguration.openshift.io/role: "master"
  name: 99-master-kargs-mpath
spec:
  kernelArguments:
    - 'rd.multipath=default'
    - 'root=/dev/disk/by-label/dm-mpath-root'
```

3. To enable multipathing post-installation on worker nodes:
  - Create a machine config file. For example, create a **99-worker-kargs-mpath.yaml** that instructs the cluster to add the **worker** label and identify the multipath kernel argument:

```
apiVersion: machineconfiguration.openshift.io/v1
kind: MachineConfig
metadata:
  labels:
    machineconfiguration.openshift.io/role: "worker"
  name: 99-worker-kargs-mpath
spec:
  kernelArguments:
    - 'rd.multipath=default'
    - 'root=/dev/disk/by-label/dm-mpath-root'
```

You can now continue on to create the cluster.



### IMPORTANT

Additional post-installation steps are required to fully enable multipathing. For more information, see “Enabling multipathing with kernel arguments on RHCOS” in *Post-installation machine configuration tasks*.

In case of MPIO failure, use the `bootlist` command to update the boot device list with alternate logical device names. The command displays a boot list and it designates the possible boot devices for when the system is booted in normal mode.

- a. To display a boot list and specify the possible boot devices if the system is booted in normal mode, enter the following command:

```
$ bootlist -m normal -o
sda
```

- b. To update the boot list for normal mode and add alternate device names, enter the following command:

```
$ bootlist -m normal -o /dev/sdc /dev/sdd /dev/sde
sdc
sdd
sde
```

If the original boot disk path is down, the node reboots from the alternate device registered in the normal boot device list.

### 17.3.12. Waiting for the bootstrap process to complete

The OpenShift Container Platform bootstrap process begins after the cluster nodes first boot into the persistent RHCOS environment that has been installed to disk. The configuration information provided through the Ignition config files is used to initialize the bootstrap process and install OpenShift Container Platform on the machines. You must wait for the bootstrap process to complete.

#### Prerequisites

- You have created the Ignition config files for your cluster.
- You have configured suitable network, DNS and load balancing infrastructure.
- You have obtained the installation program and generated the Ignition config files for your cluster.
- You installed RHCOS on your cluster machines and provided the Ignition config files that the OpenShift Container Platform installation program generated.

#### Procedure

1. Monitor the bootstrap process:

```
$ ./openshift-install --dir <installation_directory> wait-for bootstrap-complete \ 1
--log-level=info 2
```

- 1 For **<installation\_directory>**, specify the path to the directory that you stored the installation files in.

- 2 To view different installation details, specify **warn**, **debug**, or **error** instead of **info**.

#### Example output

```
INFO Waiting up to 30m0s for the Kubernetes API at https://api.test.example.com:6443...
INFO API v1.23.0 up
INFO Waiting up to 30m0s for bootstrapping to complete...
INFO It is now safe to remove the bootstrap resources
```

The command succeeds when the Kubernetes API server signals that it has been bootstrapped on the control plane machines.

2. After bootstrap process is complete, remove the bootstrap machine from the load balancer.

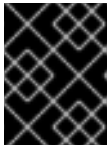

### IMPORTANT

You must remove the bootstrap machine from the load balancer at this point. You can also remove or reformat the bootstrap machine itself.

## 17.3.13. Logging in to the cluster by using the CLI

You can log in to your cluster as a default system user by exporting the cluster **kubeconfig** file. The **kubeconfig** file contains information about the cluster that is used by the CLI to connect a client to the correct cluster and API server. The file is specific to a cluster and is created during OpenShift Container Platform installation.

### Prerequisites

- You deployed an OpenShift Container Platform cluster.
- You installed the **oc** CLI.

### Procedure

1. Export the **kubeadmin** credentials:

```
$ export KUBECONFIG=<installation_directory>/auth/kubeconfig 1
```

- 1** For **<installation\_directory>**, specify the path to the directory that you stored the installation files in.

2. Verify you can run **oc** commands successfully using the exported configuration:

```
$ oc whoami
```

### Example output

```
system:admin
```

## 17.3.14. Approving the certificate signing requests for your machines

When you add machines to a cluster, two pending certificate signing requests (CSRs) are generated for each machine that you added. You must confirm that these CSRs are approved or, if necessary, approve them yourself. The client requests must be approved first, followed by the server requests.

### Prerequisites

- You added machines to your cluster.

### Procedure



1. Confirm that the cluster recognizes the machines:

```
$ oc get nodes
```

### Example output

```
NAME      STATUS    ROLES    AGE    VERSION
master-0  Ready     master   63m    v1.23.0
master-1  Ready     master   63m    v1.23.0
master-2  Ready     master   64m    v1.23.0
```

The output lists all of the machines that you created.

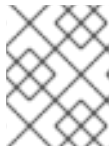

### NOTE

The preceding output might not include the compute nodes, also known as worker nodes, until some CSRs are approved.

2. Review the pending CSRs and ensure that you see the client requests with the **Pending** or **Approved** status for each machine that you added to the cluster:

```
$ oc get csr
```

### Example output

```
NAME      AGE    REQUESTOR                                     CONDITION
csr-8b2br  15m    system:serviceaccount:openshift-machine-config-operator:node-
bootstrapper  Pending
csr-8vnps  15m    system:serviceaccount:openshift-machine-config-operator:node-
bootstrapper  Pending
...
```

In this example, two machines are joining the cluster. You might see more approved CSRs in the list.

3. If the CSRs were not approved, after all of the pending CSRs for the machines you added are in **Pending** status, approve the CSRs for your cluster machines:

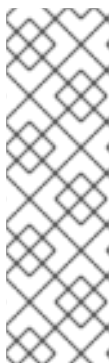

### NOTE

Because the CSRs rotate automatically, approve your CSRs within an hour of adding the machines to the cluster. If you do not approve them within an hour, the certificates will rotate, and more than two certificates will be present for each node. You must approve all of these certificates. After the client CSR is approved, the Kubelet creates a secondary CSR for the serving certificate, which requires manual approval. Then, subsequent serving certificate renewal requests are automatically approved by the **machine-approver** if the Kubelet requests a new certificate with identical parameters.

**NOTE**

For clusters running on platforms that are not machine API enabled, such as bare metal and other user-provisioned infrastructure, you must implement a method of automatically approving the kubelet serving certificate requests (CSRs). If a request is not approved, then the **oc exec**, **oc rsh**, and **oc logs** commands cannot succeed, because a serving certificate is required when the API server connects to the kubelet. Any operation that contacts the Kubelet endpoint requires this certificate approval to be in place. The method must watch for new CSRs, confirm that the CSR was submitted by the **node-bootstrap** service account in the **system:node** or **system:admin** groups, and confirm the identity of the node.

- To approve them individually, run the following command for each valid CSR:

```
$ oc adm certificate approve <csr_name> 1
```

- 1** **<csr\_name>** is the name of a CSR from the list of current CSRs.

- To approve all pending CSRs, run the following command:

```
$ oc get csr -o go-template='{{range .items}}{{if not .status}}{{.metadata.name}}{\n"}\n{{end}}' | xargs --no-run-if-empty oc adm certificate approve
```

**NOTE**

Some Operators might not become available until some CSRs are approved.

- Now that your client requests are approved, you must review the server requests for each machine that you added to the cluster:

```
$ oc get csr
```

**Example output**

```
NAME      AGE   REQUESTOR                                     CONDITION
csr-bfd72 5m26s system:node:ip-10-0-50-126.us-east-2.compute.internal
Pending
csr-c57lv 5m26s system:node:ip-10-0-95-157.us-east-2.compute.internal
Pending
...
```

- If the remaining CSRs are not approved, and are in the **Pending** status, approve the CSRs for your cluster machines:

- To approve them individually, run the following command for each valid CSR:

```
$ oc adm certificate approve <csr_name> 1
```

- 1** **<csr\_name>** is the name of a CSR from the list of current CSRs.

- To approve all pending CSRs, run the following command:

```
$ oc get csr -o go-template='{{range .items}}{{if not .status}}{{.metadata.name}}{\n"}\n{{end}}\n{{end}}' | xargs oc adm certificate approve
```

6. After all client and server CSRs have been approved, the machines have the **Ready** status. Verify this by running the following command:

```
$ oc get nodes
```

### Example output

```
NAME      STATUS  ROLES  AGE  VERSION
master-0  Ready   master 73m  v1.23.0
master-1  Ready   master 73m  v1.23.0
master-2  Ready   master 74m  v1.23.0
worker-0  Ready   worker 11m  v1.23.0
worker-1  Ready   worker 11m  v1.23.0
```



### NOTE

It can take a few minutes after approval of the server CSRs for the machines to transition to the **Ready** status.

### Additional information

- For more information on CSRs, see [Certificate Signing Requests](#).

## 17.3.15. Initial Operator configuration

After the control plane initializes, you must immediately configure some Operators so that they all become available.

### Prerequisites

- Your control plane has initialized.

### Procedure

1. Watch the cluster components come online:

```
$ watch -n5 oc get clusteroperators
```

### Example output

NAME	VERSION	AVAILABLE	PROGRESSING	DEGRADED	SINCE
authentication	4.10.0	True	False	False	19m
baremetal	4.10.0	True	False	False	37m
cloud-credential	4.10.0	True	False	False	40m
cluster-autoscaler	4.10.0	True	False	False	37m
config-operator	4.10.0	True	False	False	38m

console	4.10.0	True	False	False	26m
csi-snapshot-controller	4.10.0	True	False	False	37m
dns	4.10.0	True	False	False	37m
etcd	4.10.0	True	False	False	36m
image-registry	4.10.0	True	False	False	31m
ingress	4.10.0	True	False	False	30m
insights	4.10.0	True	False	False	31m
kube-apiserver	4.10.0	True	False	False	26m
kube-controller-manager	4.10.0	True	False	False	36m
kube-scheduler	4.10.0	True	False	False	36m
kube-storage-version-migrator	4.10.0	True	False	False	37m
machine-api	4.10.0	True	False	False	29m
machine-approver	4.10.0	True	False	False	37m
machine-config	4.10.0	True	False	False	36m
marketplace	4.10.0	True	False	False	37m
monitoring	4.10.0	True	False	False	29m
network	4.10.0	True	False	False	38m
node-tuning	4.10.0	True	False	False	37m
openshift-apiserver	4.10.0	True	False	False	32m
openshift-controller-manager	4.10.0	True	False	False	30m
openshift-samples	4.10.0	True	False	False	32m
operator-lifecycle-manager	4.10.0	True	False	False	37m
operator-lifecycle-manager-catalog	4.10.0	True	False	False	37m
operator-lifecycle-manager-packageserver	4.10.0	True	False	False	32m
service-ca	4.10.0	True	False	False	38m
storage	4.10.0	True	False	False	37m

2. Configure the Operators that are not available.

### 17.3.15.1. Disabling the default OperatorHub sources

Operator catalogs that source content provided by Red Hat and community projects are configured for OperatorHub by default during an OpenShift Container Platform installation. In a restricted network environment, you must disable the default catalogs as a cluster administrator.

#### Procedure

- Disable the sources for the default catalogs by adding **disableAllDefaultSources: true** to the **OperatorHub** object:

```
$ oc patch OperatorHub cluster --type json \
  -p [{"op": "add", "path": "/spec/disableAllDefaultSources", "value": true}]
```

#### TIP

Alternatively, you can use the web console to manage catalog sources. From the **Administration** → **Cluster Settings** → **Configuration** → **OperatorHub** page, click the **Sources** tab, where you can create, delete, disable, and enable individual sources.

### 17.3.15.2. Image registry storage configuration

The Image Registry Operator is not initially available for platforms that do not provide default storage. After installation, you must configure your registry to use storage so that the Registry Operator is made available.

Instructions are shown for configuring a persistent volume, which is required for production clusters. Where applicable, instructions are shown for configuring an empty directory as the storage location, which is available for only non-production clusters.

Additional instructions are provided for allowing the image registry to use block storage types by using the **Recreate** rollout strategy during upgrades.

### 17.3.15.2.1. Changing the image registry's management state

To start the image registry, you must change the Image Registry Operator configuration's **managementState** from **Removed** to **Managed**.

#### Procedure

- Change **managementState** Image Registry Operator configuration from **Removed** to **Managed**. For example:

```
$ oc patch configs.imageregistry.operator.openshift.io cluster --type merge --patch '{"spec": {"managementState": "Managed"}}'
```

### 17.3.15.2.2. Configuring registry storage for IBM Power

As a cluster administrator, following installation you must configure your registry to use storage.

#### Prerequisites

- You have access to the cluster as a user with the **cluster-admin** role.
- You have a cluster on IBM Power.
- You have provisioned persistent storage for your cluster, such as Red Hat OpenShift Data Foundation.



#### IMPORTANT

OpenShift Container Platform supports **ReadWriteOnce** access for image registry storage when you have only one replica. **ReadWriteOnce** access also requires that the registry uses the **Recreate** rollout strategy. To deploy an image registry that supports high availability with two or more replicas, **ReadWriteMany** access is required.

- Must have 100Gi capacity.

#### Procedure

1. To configure your registry to use storage, change the **spec.storage.pvc** in the **configs.imageregistry/cluster** resource.



#### NOTE

When using shared storage, review your security settings to prevent outside access.

- Verify that you do not have a registry pod:

```
$ oc get pod -n openshift-image-registry -l docker-registry=default
```

#### Example output

```
No resources found in openshift-image-registry namespace
```

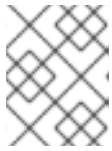

#### NOTE

If you do have a registry pod in your output, you do not need to continue with this procedure.

- Check the registry configuration:

```
$ oc edit configs.imageregistry.operator.openshift.io
```

#### Example output

```
storage:
  pvc:
    claim:
```

Leave the **claim** field blank to allow the automatic creation of an **image-registry-storage** PVC.

- Check the **clusteroperator** status:

```
$ oc get clusteroperator image-registry
```

#### Example output

NAME	VERSION	AVAILABLE	PROGRESSING	DEGRADED	SINCE
image-registry	4.10	True	False	False	6h50m

- Ensure that your registry is set to managed to enable building and pushing of images.

- Run:

```
$ oc edit configs.imageregistry/cluster
```

Then, change the line

```
managementState: Removed
```

to

```
managementState: Managed
```

### 17.3.15.2.3. Configuring storage for the image registry in non-production clusters

You must configure storage for the Image Registry Operator. For non-production clusters, you can set the image registry to an empty directory. If you do so, all images are lost if you restart the registry.

### Procedure

- To set the image registry storage to an empty directory:

```
$ oc patch configs.imageregistry.operator.openshift.io cluster --type merge --patch '{"spec": {"storage":{"emptyDir":{}}}'
```



#### WARNING

Configure this option for only non-production clusters.

If you run this command before the Image Registry Operator initializes its components, the **oc patch** command fails with the following error:

```
Error from server (NotFound): configs.imageregistry.operator.openshift.io "cluster" not found
```

Wait a few minutes and run the command again.

### 17.3.16. Completing installation on user-provisioned infrastructure

After you complete the Operator configuration, you can finish installing the cluster on infrastructure that you provide.

#### Prerequisites

- Your control plane has initialized.
- You have completed the initial Operator configuration.

### Procedure

- Confirm that all the cluster components are online with the following command:

```
$ watch -n5 oc get clusteroperators
```

#### Example output

NAME	VERSION	AVAILABLE	PROGRESSING	DEGRADED	SINCE
authentication	4.10.0	True	False	False	19m
baremetal	4.10.0	True	False	False	37m
cloud-credential	4.10.0	True	False	False	40m
cluster-autoscaler	4.10.0	True	False	False	37m
config-operator	4.10.0	True	False	False	38m
console	4.10.0	True	False	False	26m

csi-snapshot-controller	4.10.0	True	False	False	37m
dns	4.10.0	True	False	False	37m
etcd	4.10.0	True	False	False	36m
image-registry	4.10.0	True	False	False	31m
ingress	4.10.0	True	False	False	30m
insights	4.10.0	True	False	False	31m
kube-apiserver	4.10.0	True	False	False	26m
kube-controller-manager	4.10.0	True	False	False	36m
kube-scheduler	4.10.0	True	False	False	36m
kube-storage-version-migrator	4.10.0	True	False	False	37m
machine-api	4.10.0	True	False	False	29m
machine-approver	4.10.0	True	False	False	37m
machine-config	4.10.0	True	False	False	36m
marketplace	4.10.0	True	False	False	37m
monitoring	4.10.0	True	False	False	29m
network	4.10.0	True	False	False	38m
node-tuning	4.10.0	True	False	False	37m
openshift-apiserver	4.10.0	True	False	False	32m
openshift-controller-manager	4.10.0	True	False	False	30m
openshift-samples	4.10.0	True	False	False	32m
operator-lifecycle-manager	4.10.0	True	False	False	37m
operator-lifecycle-manager-catalog	4.10.0	True	False	False	37m
operator-lifecycle-manager-packageserver	4.10.0	True	False	False	32m
service-ca	4.10.0	True	False	False	38m
storage	4.10.0	True	False	False	37m

Alternatively, the following command notifies you when all of the clusters are available. It also retrieves and displays credentials:

```
$ ./openshift-install --dir <installation_directory> wait-for install-complete 1
```

- 1** For **<installation\_directory>**, specify the path to the directory that you stored the installation files in.

### Example output

```
INFO Waiting up to 30m0s for the cluster to initialize...
```

The command succeeds when the Cluster Version Operator finishes deploying the OpenShift Container Platform cluster from Kubernetes API server.



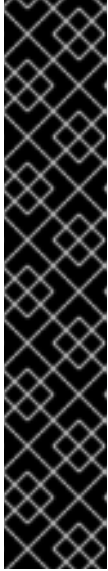

## IMPORTANT

- The Ignition config files that the installation program generates contain certificates that expire after 24 hours, which are then renewed at that time. If the cluster is shut down before renewing the certificates and the cluster is later restarted after the 24 hours have elapsed, the cluster automatically recovers the expired certificates. The exception is that you must manually approve the pending **node-bootstrapper** certificate signing requests (CSRs) to recover kubelet certificates. See the documentation for *Recovering from expired control plane certificates* for more information.
- It is recommended that you use Ignition config files within 12 hours after they are generated because the 24-hour certificate rotates from 16 to 22 hours after the cluster is installed. By using the Ignition config files within 12 hours, you can avoid installation failure if the certificate update runs during installation.

2. Confirm that the Kubernetes API server is communicating with the pods.

a. To view a list of all pods, use the following command:

```
$ oc get pods --all-namespaces
```

### Example output

```

NAMESPACE           NAME                                     READY  STATUS
RESTARTS  AGE
openshift-apiserver-operator  openshift-apiserver-operator-85cb746d55-zqhs8  1/1
Running   1      9m
openshift-apiserver           apiserver-67b9g                                1/1  Running  0
3m
openshift-apiserver           apiserver-ljcmx                                1/1  Running  0
1m
openshift-apiserver           apiserver-z25h4                                1/1  Running  0
2m
openshift-authentication-operator  authentication-operator-69d5d8bf84-vh2n8  1/1
Running   0      5m
...

```

b. View the logs for a pod that is listed in the output of the previous command by using the following command:

```
$ oc logs <pod_name> -n <namespace> ❶
```

- ❶ Specify the pod name and namespace, as shown in the output of the previous command.

If the pod logs display, the Kubernetes API server can communicate with the cluster machines.

3. Additional steps are required to enable multipathing. Do not enable multipathing during installation.

See "Enabling multipathing with kernel arguments on RHCOS" in the *Post-installation machine configuration tasks* documentation for more information.

4. Register your cluster on the [Cluster registration](#) page.

### 17.3.17. Next steps

- [Enabling multipathing with kernel arguments on RHCOS](#) .
- [Customize your cluster](#).
- If the mirror registry that you used to install your cluster has a trusted CA, add it to the cluster by [configuring additional trust stores](#).
- If necessary, you can [opt out of remote health reporting](#) .
- If necessary, see [Registering your disconnected cluster](#)

# CHAPTER 18. INSTALLING ON OPENSTACK

## 18.1. PREPARING TO INSTALL ON OPENSTACK

You can install OpenShift Container Platform on Red Hat OpenStack Platform (RHOSP).

### 18.1.1. Prerequisites

- You reviewed details about the [OpenShift Container Platform installation and update](#) processes.
- You read the documentation on [selecting a cluster installation method and preparing it for users](#).

### 18.1.2. Choosing a method to install OpenShift Container Platform on OpenStack

You can install OpenShift Container Platform on installer-provisioned or user-provisioned infrastructure. The default installation type uses installer-provisioned infrastructure, where the installation program provisions the underlying infrastructure for the cluster. You can also install OpenShift Container Platform on infrastructure that you provision. If you do not use infrastructure that the installation program provisions, you must manage and maintain the cluster resources yourself.

See [Installation process](#) for more information about installer-provisioned and user-provisioned installation processes.

#### 18.1.2.1. Installing a cluster on installer-provisioned infrastructure

You can install a cluster on Red Hat OpenStack Platform (RHOSP) infrastructure that is provisioned by the OpenShift Container Platform installation program, by using one of the following methods:

- **Installing a cluster on OpenStack with customizations** You can install a customized cluster on RHOSP. The installation program allows for some customization to be applied at the installation stage. Many other customization options are available [post-installation](#).
- **Installing a cluster on OpenStack with Kuryr** You can install a customized OpenShift Container Platform cluster on RHOSP that uses Kuryr SDN. Kuryr and OpenShift Container Platform integration is primarily designed for OpenShift Container Platform clusters running on RHOSP VMs. Kuryr improves the network performance by plugging OpenShift Container Platform pods into RHOSP SDN. In addition, it provides interconnectivity between pods and RHOSP virtual instances.
- **Installing a cluster on OpenStack in a restricted network** You can install OpenShift Container Platform on RHOSP in a restricted or disconnected network by creating an internal mirror of the installation release content. You can use this method to install a cluster that does not require an active internet connection to obtain the software components. You can also use this installation method to ensure that your clusters only use container images that satisfy your organizational controls on external content.

#### 18.1.2.2. Installing a cluster on user-provisioned infrastructure

You can install a cluster on RHOSP infrastructure that you provision, by using one of the following methods:

- **Installing a cluster on OpenStack on your own infrastructure** You can install OpenShift

Container Platform on user-provisioned RHOSP infrastructure. By using this installation method, you can integrate your cluster with existing infrastructure and modifications. For installations on user-provisioned infrastructure, you must create all RHOSP resources, like Nova servers, Neutron ports, and security groups. You can use the provided Ansible playbooks to assist with the deployment process.

- [Installing a cluster on OpenStack with Kuryr on your own infrastructure](#) You can install OpenShift Container Platform on user-provisioned RHOSP infrastructure that uses Kuryr SDN.
- [Installing a cluster on OpenStack on your own SR-IOV infrastructure](#) You can install OpenShift Container Platform on user-provisioned RHOSP infrastructure that uses single-root input/output virtualization (SR-IOV) networks to run compute machines.

### 18.1.3. Scanning RHOSP endpoints for legacy HTTPS certificates

Beginning with OpenShift Container Platform 4.10, HTTPS certificates must contain subject alternative name (SAN) fields. Run the following script to scan each HTTPS endpoint in a Red Hat OpenStack Platform (RHOSP) catalog for legacy certificates that only contain the **CommonName** field.



#### IMPORTANT

OpenShift Container Platform does not check the underlying RHOSP infrastructure for legacy certificates prior to installation or updates. Use the provided script to check for these certificates yourself. Failing to update legacy certificates prior to installing or updating a cluster will result in cluster dysfunction.

#### Prerequisites

- On the machine where you run the script, have the following software:
  - Bash version 4.0 or greater
  - **grep**
  - [OpenStack client](#)
  - **jq**
  - [OpenSSL version 1.1.1l or greater](#)
- Populate the machine with RHOSP credentials for the target cloud.

#### Procedure

1. Save the following script to your machine:

```
#!/usr/bin/env bash

set -Eeuo pipefail

declare catalog san
catalog="$(mktemp)"
san="$(mktemp)"
readonly catalog san

declare invalid=0
```

```

openstack catalog list --format json --column Name --column Endpoints \
| jq -r '.[] | .Name as $name | .Endpoints[] | select(.interface=="public") | [$name, .interface,
.url] | join(" ") \
| sort \
> "$catalog"

while read -r name interface url; do
# Ignore HTTP
if [[ ${url#"http://"} != "$url" ]]; then
continue
fi

# Remove the schema from the URL
noschema=${url#"https://"}

# If the schema was not HTTPS, error
if [[ "$noschema" == "$url" ]]; then
echo "ERROR (unknown schema): $name $interface $url"
exit 2
fi

# Remove the path and only keep host and port
noschema=${noschema%/*}
host=${noschema%:*}
port=${noschema##*.*}

# Add the port if was implicit
if [[ "$port" == "$host" ]]; then
port='443'
fi

# Get the SAN fields
openssl s_client -showcerts -servername "$host" -connect "$host:$port" </dev/null
2>/dev/null \
| openssl x509 -noout -ext subjectAltName \
> "$san"

# openssl returns the empty string if no SAN is found.
# If a SAN is found, openssl is expected to return something like:
#
# X509v3 Subject Alternative Name:
#   DNS:standalone, DNS:osp1, IP Address:192.168.2.1, IP Address:10.254.1.2
if [[ "$(grep -c "Subject Alternative Name" "$san" || true)" -gt 0 ]]; then
echo "PASS: $name $interface $url"
else
invalid=$((invalid+1))
echo "INVALID: $name $interface $url"
fi
done < "$catalog"

# clean up temporary files
rm "$catalog" "$san"

if [[ $invalid -gt 0 ]]; then
echo "${invalid} legacy certificates were detected. Update your certificates to include a SAN

```

```
field."
exit 1
else
echo "All HTTPS certificates for this cloud are valid."
fi
```

2. Run the script.
3. Replace any certificates that the script reports as **INVALID** with certificates that contain SAN fields.

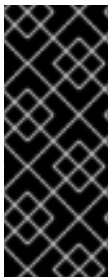

### IMPORTANT

You must replace all legacy HTTPS certificates before you install OpenShift Container Platform 4.10 or update a cluster to that version. Legacy certificates will be rejected with the following message:

```
x509: certificate relies on legacy Common Name field, use SANs instead
```

#### 18.1.3.1. Scanning RHOSP endpoints for legacy HTTPS certificates manually

Beginning with OpenShift Container Platform 4.10, HTTPS certificates must contain subject alternative name (SAN) fields. If you do not have access to the prerequisite tools that are listed in "Scanning RHOSP endpoints for legacy HTTPS certificates", perform the following steps to scan each HTTPS endpoint in a Red Hat OpenStack Platform (RHOSP) catalog for legacy certificates that only contain the **CommonName** field.

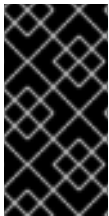

### IMPORTANT

OpenShift Container Platform does not check the underlying RHOSP infrastructure for legacy certificates prior to installation or updates. Use the following steps to check for these certificates yourself. Failing to update legacy certificates prior to installing or updating a cluster will result in cluster dysfunction.

#### Procedure

1. On a command line, run the following command to view the URL of RHOSP public endpoints:

```
$ openstack catalog list
```

Record the URL for each HTTPS endpoint that the command returns.

2. For each public endpoint, note the host and the port.

### TIP

Determine the host of an endpoint by removing the scheme, the port, and the path.

3. For each endpoint, run the following commands to extract the SAN field of the certificate:
  - a. Set a **host** variable:

```
$ host=<host_name>
```

- b. Set a **port** variable:

```
$ port=<port_number>
```

If the URL of the endpoint does not have a port, use the value **443**.

- c. Retrieve the SAN field of the certificate:

```
$ openssl s_client -showcerts -servername "$host" -connect "$host:$port" </dev/null
2>/dev/null \
| openssl x509 -noout -ext subjectAltName
```

### Example output

```
X509v3 Subject Alternative Name:
DNS:your.host.example.net
```

For each endpoint, look for output that resembles the previous example. If there is no output for an endpoint, the certificate of that endpoint is invalid and must be re-issued.



### IMPORTANT

You must replace all legacy HTTPS certificates before you install OpenShift Container Platform 4.10 or update a cluster to that version. Legacy certificates are rejected with the following message:

```
x509: certificate relies on legacy Common Name field, use SANs instead
```

## 18.2. INSTALLING A CLUSTER ON OPENSTACK WITH CUSTOMIZATIONS

In OpenShift Container Platform version 4.10, you can install a customized cluster on Red Hat OpenStack Platform (RHOSP). To customize the installation, modify parameters in the **install-config.yaml** before you install the cluster.

### 18.2.1. Prerequisites

- You reviewed details about the [OpenShift Container Platform installation and update](#) processes.
- You read the documentation on [selecting a cluster installation method and preparing it for users](#).
- You verified that OpenShift Container Platform 4.10 is compatible with your RHOSP version by using the [Supported platforms for OpenShift clusters](#) section. You can also compare platform support across different versions by viewing the [OpenShift Container Platform on RHOSP support matrix](#).
- You have a storage service installed in RHOSP, such as block storage (Cinder) or object storage (Swift). Object storage is the recommended storage technology for OpenShift Container Platform registry cluster deployment. For more information, see [Optimizing storage](#).

- You understand performance and scalability practices for cluster scaling, control plane sizing, and etcd. For more information, see [Recommended host practices](#).
- You have the metadata service enabled in RHOSP.

## 18.2.2. Resource guidelines for installing OpenShift Container Platform on RHOSP

To support an OpenShift Container Platform installation, your Red Hat OpenStack Platform (RHOSP) quota must meet the following requirements:

**Table 18.1. Recommended resources for a default OpenShift Container Platform cluster on RHOSP**

Resource	Value
Floating IP addresses	3
Ports	15
Routers	1
Subnets	1
RAM	88 GB
vCPUs	22
Volume storage	275 GB
Instances	7
Security groups	3
Security group rules	60
Server groups	2 - plus 1 for each additional availability zone in each machine pool

A cluster might function with fewer than recommended resources, but its performance is not guaranteed.



### IMPORTANT

If RHOSP object storage (Swift) is available and operated by a user account with the **swiftoperator** role, it is used as the default backend for the OpenShift Container Platform image registry. In this case, the volume storage requirement is 175 GB. Swift space requirements vary depending on the size of the image registry.

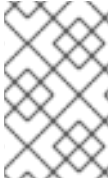

**NOTE**

By default, your security group and security group rule quotas might be low. If you encounter problems, run **openstack quota set --secgroups 3 --secgroup-rules 60 <project>** as an administrator to increase them.

An OpenShift Container Platform deployment comprises control plane machines, compute machines, and a bootstrap machine.

**18.2.2.1. Control plane machines**

By default, the OpenShift Container Platform installation process creates three control plane machines.

Each machine requires:

- An instance from the RHOSP quota
- A port from the RHOSP quota
- A flavor with at least 16 GB memory and 4 vCPUs
- At least 100 GB storage space from the RHOSP quota

**18.2.2.2. Compute machines**

By default, the OpenShift Container Platform installation process creates three compute machines.

Each machine requires:

- An instance from the RHOSP quota
- A port from the RHOSP quota
- A flavor with at least 8 GB memory and 2 vCPUs
- At least 100 GB storage space from the RHOSP quota

**TIP**

Compute machines host the applications that you run on OpenShift Container Platform; aim to run as many as you can.

**18.2.2.3. Bootstrap machine**

During installation, a bootstrap machine is temporarily provisioned to stand up the control plane. After the production control plane is ready, the bootstrap machine is deprovisioned.

The bootstrap machine requires:

- An instance from the RHOSP quota
- A port from the RHOSP quota
- A flavor with at least 16 GB memory and 4 vCPUs
- At least 100 GB storage space from the RHOSP quota

### 18.2.3. Internet access for OpenShift Container Platform

In OpenShift Container Platform 4.10, you require access to the internet to install your cluster.

You must have internet access to:

- Access [OpenShift Cluster Manager](#) to download the installation program and perform subscription management. If the cluster has internet access and you do not disable Telemetry, that service automatically entitles your cluster.
- Access [Quay.io](#) to obtain the packages that are required to install your cluster.
- Obtain the packages that are required to perform cluster updates.

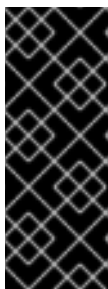

#### IMPORTANT

If your cluster cannot have direct internet access, you can perform a restricted network installation on some types of infrastructure that you provision. During that process, you download the required content and use it to populate a mirror registry with the installation packages. With some installation types, the environment that you install your cluster in will not require internet access. Before you update the cluster, you update the content of the mirror registry.

### 18.2.4. Enabling Swift on RHOSP

Swift is operated by a user account with the **swiftoperator** role. Add the role to an account before you run the installation program.



#### IMPORTANT

If [the Red Hat OpenStack Platform \(RHOSP\) object storage service](#), commonly known as Swift, is available, OpenShift Container Platform uses it as the image registry storage. If it is unavailable, the installation program relies on the RHOSP block storage service, commonly known as Cinder.

If Swift is present and you want to use it, you must enable access to it. If it is not present, or if you do not want to use it, skip this section.

#### Prerequisites

- You have a RHOSP administrator account on the target environment.
- The Swift service is installed.
- On [Ceph RGW](#), the **account in url** option is enabled.

#### Procedure

To enable Swift on RHOSP:

1. As an administrator in the RHOSP CLI, add the **swiftoperator** role to the account that will access Swift:

```
$ openstack role add --user <user> --project <project> swiftoperator
```

Your RHOSP deployment can now use Swift for the image registry.

## 18.2.5. Configuring an image registry with custom storage on clusters that run on RHOSP

After you install a cluster on Red Hat OpenStack Platform (RHOSP), you can use a Cinder volume that is in a specific availability zone for registry storage.

### Procedure

1. Create a YAML file that specifies the storage class and availability zone to use. For example:

```
apiVersion: storage.k8s.io/v1
kind: StorageClass
metadata:
  name: custom-csi-storageclass
provisioner: cinder.csi.openstack.org
volumeBindingMode: WaitForFirstConsumer
allowVolumeExpansion: true
parameters:
  availability: <availability_zone_name>
```



### NOTE

OpenShift Container Platform does not verify the existence of the availability zone you choose. Verify the name of the availability zone before you apply the configuration.

2. From a command line, apply the configuration:

```
$ oc apply -f <storage_class_file_name>
```

### Example output

```
storageclass.storage.k8s.io/custom-csi-storageclass created
```

3. Create a YAML file that specifies a persistent volume claim (PVC) that uses your storage class and the **openshift-image-registry** namespace. For example:

```
apiVersion: v1
kind: PersistentVolumeClaim
metadata:
  name: csi-pvc-imageregistry
  namespace: openshift-image-registry 1
  annotations:
    imageregistry.openshift.io: "true"
spec:
  accessModes:
    - ReadWriteOnce
  volumeMode: Filesystem
resources:
```

```

requests:
  storage: 100Gi 2
storageClassName: <your_custom_storage_class> 3

```

- 1** Enter the namespace **openshift-image-registry**. This namespace allows the Cluster Image Registry Operator to consume the PVC.
- 2** Optional: Adjust the volume size.
- 3** Enter the name of the storage class that you created.

4. From a command line, apply the configuration:

```
$ oc apply -f <pvc_file_name>
```

### Example output

```
persistentvolumeclaim/csi-pvc-imageregistry created
```

5. Replace the original persistent volume claim in the image registry configuration with the new claim:

```
$ oc patch configs.imageregistry.operator.openshift.io/cluster --type 'json' -p='[{"op": "replace", "path": "/spec/storage/pvc/claim", "value": "csi-pvc-imageregistry"}]'
```

### Example output

```
config.imageregistry.operator.openshift.io/cluster patched
```

Over the next several minutes, the configuration is updated.

## Verification

To confirm that the registry is using the resources that you defined:

1. Verify that the PVC claim value is identical to the name that you provided in your PVC definition:

```
$ oc get configs.imageregistry.operator.openshift.io/cluster -o yaml
```

### Example output

```

...
status:
  ...
  managementState: Managed
  pvc:
    claim: csi-pvc-imageregistry
  ...

```

2. Verify that the status of the PVC is **Bound**:

```
$ oc get pvc -n openshift-image-registry csi-pvc-imageregistry
```

## Example output

```

NAME                STATUS VOLUME                CAPACITY ACCESS MODES
STORAGECLASS        AGE
csi-pvc-imageregistry Bound  pvc-72a8f9c9-f462-11e8-b6b6-fa163e18b7b5 100Gi
RWO                 custom-csi-storageclass 11m

```

### 18.2.6. Verifying external network access

The OpenShift Container Platform installation process requires external network access. You must provide an external network value to it, or deployment fails. Before you begin the process, verify that a network with the external router type exists in Red Hat OpenStack Platform (RHOSP).

#### Prerequisites

- [Configure OpenStack's networking service to have DHCP agents forward instances' DNS queries](#)

#### Procedure

1. Using the RHOSP CLI, verify the name and ID of the 'External' network:

```
$ openstack network list --long -c ID -c Name -c "Router Type"
```

#### Example output

```

+-----+-----+-----+
| ID                | Name      | Router Type |
+-----+-----+-----+
| 148a8023-62a7-4672-b018-003462f8d7dc | public_network | External  |
+-----+-----+-----+

```

A network with an external router type appears in the network list. If at least one does not, see [Creating a default floating IP network](#) and [Creating a default provider network](#).

#### IMPORTANT

If the external network's CIDR range overlaps one of the default network ranges, you must change the matching network ranges in the **install-config.yaml** file before you start the installation process.

The default network ranges are:

Network	Range
<b>machineNetwork</b>	10.0.0.0/16
<b>serviceNetwork</b>	172.30.0.0/16
<b>clusterNetwork</b>	10.128.0.0/14

**WARNING**

If the installation program finds multiple networks with the same name, it sets one of them at random. To avoid this behavior, create unique names for resources in RHOSP.

**NOTE**

If the Neutron trunk service plugin is enabled, a trunk port is created by default. For more information, see [Neutron trunk port](#).

### 18.2.7. Defining parameters for the installation program

The OpenShift Container Platform installation program relies on a file that is called **clouds.yaml**. The file describes Red Hat OpenStack Platform (RHOSP) configuration parameters, including the project name, log in information, and authorization service URLs.

**Procedure**

1. Create the **clouds.yaml** file:
  - If your RHOSP distribution includes the Horizon web UI, generate a **clouds.yaml** file in it.

**IMPORTANT**

Remember to add a password to the **auth** field. You can also keep secrets in [a separate file](#) from **clouds.yaml**.

- If your RHOSP distribution does not include the Horizon web UI, or you do not want to use Horizon, create the file yourself. For detailed information about **clouds.yaml**, see [Config files](#) in the RHOSP documentation.

```
clouds:
  shiftstack:
    auth:
      auth_url: http://10.10.14.42:5000/v3
      project_name: shiftstack
      username: <username>
      password: <password>
      user_domain_name: Default
      project_domain_name: Default
  dev-env:
    region_name: RegionOne
    auth:
      username: <username>
      password: <password>
      project_name: 'devonly'
      auth_url: 'https://10.10.14.22:5001/v2.0'
```

2. If your RHOSP installation uses self-signed certificate authority (CA) certificates for endpoint authentication:
  - a. Copy the certificate authority file to your machine.
  - b. Add the **cacerts** key to the **clouds.yaml** file. The value must be an absolute, non-root-accessible path to the CA certificate:

```
clouds:
  shiftstack:
    ...
  cacert: "/etc/pki/ca-trust/source/anchors/ca.crt.pem"
```

### TIP

After you run the installer with a custom CA certificate, you can update the certificate by editing the value of the **ca-cert.pem** key in the **cloud-provider-config** keymap. On a command line, run:

```
$ oc edit configmap -n openshift-config cloud-provider-config
```

3. Place the **clouds.yaml** file in one of the following locations:
  - a. The value of the **OS\_CLIENT\_CONFIG\_FILE** environment variable
  - b. The current directory
  - c. A Unix-specific user configuration directory, for example **~/.config/openstack/clouds.yaml**
  - d. A Unix-specific site configuration directory, for example **/etc/openstack/clouds.yaml**

The installation program searches for **clouds.yaml** in that order.

## 18.2.8. Setting cloud provider options

Optionally, you can edit the cloud provider configuration for your cluster. The cloud provider configuration controls how OpenShift Container Platform interacts with Red Hat OpenStack Platform (RHOSP).

For a complete list of cloud provider configuration parameters, see the "OpenStack cloud configuration reference guide" page in the "Installing on OpenStack" documentation.

### Procedure

1. If you have not already generated manifest files for your cluster, generate them by running the following command:

```
$ openshift-install --dir <destination_directory> create manifests
```

2. In a text editor, open the cloud-provider configuration manifest file. For example:

```
$ vi openshift/manifests/cloud-provider-config.yaml
```

3. Modify the options based on the cloud configuration specification.

Configuring Octavia for load balancing is a common case for clusters that do not use Kuryr. For example:

```
#...
[LoadBalancer]
use-octavia=true 1
lb-provider = "amphora" 2
floating-network-id="d3deb660-4190-40a3-91f1-37326fe6ec4a" 3
create-monitor = True 4
monitor-delay = 10s 5
monitor-timeout = 10s 6
monitor-max-retries = 1 7
#...
```

- 1 This property enables Octavia integration.
- 2 This property sets the Octavia provider that your load balancer uses. It accepts **"ovn"** or **"amphora"** as values. If you choose to use OVN, you must also set **lb-method** to **SOURCE\_IP\_PORT**.
- 3 This property is required if you want to use multiple external networks with your cluster. The cloud provider creates floating IP addresses on the network that is specified here.
- 4 This property controls whether the cloud provider creates health monitors for Octavia load balancers. Set the value to **True** to create health monitors. As of RHOSP 16.1 and 16.2, this feature is only available for the Amphora provider.
- 5 This property sets the frequency with which endpoints are monitored. The value must be in the **time.ParseDuration()** format. This property is required if the value of the **create-monitor** property is **True**.
- 6 This property sets the time that monitoring requests are open before timing out. The value must be in the **time.ParseDuration()** format. This property is required if the value of the **create-monitor** property is **True**.
- 7 This property defines how many successful monitoring requests are required before a load balancer is marked as online. The value must be an integer. This property is required if the value of the **create-monitor** property is **True**.



### IMPORTANT

Prior to saving your changes, verify that the file is structured correctly. Clusters might fail if properties are not placed in the appropriate section.



### IMPORTANT

You must set the value of the **create-monitor** property to **True** if you use services that have the value of the **.spec.externalTrafficPolicy** property set to **Local**. The OVN Octavia provider in RHOSP 16.1 and 16.2 does not support health monitors. Therefore, services that have **ETP** parameter values set to **Local** might not respond when the **lb-provider** value is set to **"ovn"**.



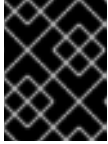

## IMPORTANT

For installations that use Kuryr, Kuryr handles relevant services. There is no need to configure Octavia load balancing in the cloud provider.

4. Save the changes to the file and proceed with installation.

## TIP

You can update your cloud provider configuration after you run the installer. On a command line, run:

```
$ oc edit configmap -n openshift-config cloud-provider-config
```

After you save your changes, your cluster will take some time to reconfigure itself. The process is complete if none of your nodes have a **SchedulingDisabled** status.

### 18.2.8.1. External load balancers that use pre-defined floating IP addresses

Commonly, Red Hat OpenStack Platform (RHOSP) deployments disallow non-administrator users from creating specific floating IP addresses. If such a policy is in place and you use a floating IP address in your service specification, the cloud provider will fail to handle IP address assignment to load balancers.

If you use an external cloud provider, you can avoid this problem by pre-creating a floating IP address and specifying it in your service specification. The in-tree cloud provider does not support this method.

Alternatively, you can [modify the RHOSP Networking service \(Neutron\) to allow non-administrator users to create specific floating IP addresses](#).

#### Additional resources

- For more information about cloud provider configuration, see [OpenStack cloud provider options](#).

### 18.2.9. Obtaining the installation program

Before you install OpenShift Container Platform, download the installation file on a local computer.

#### Prerequisites

- You have a computer that runs Linux or macOS, with 500 MB of local disk space

#### Procedure

1. Access the [Infrastructure Provider](#) page on the OpenShift Cluster Manager site. If you have a Red Hat account, log in with your credentials. If you do not, create an account.
2. Select your infrastructure provider.
3. Navigate to the page for your installation type, download the installation program that corresponds with your host operating system and architecture, and place the file in the directory where you will store the installation configuration files.

**IMPORTANT**

The installation program creates several files on the computer that you use to install your cluster. You must keep the installation program and the files that the installation program creates after you finish installing the cluster. Both files are required to delete the cluster.

**IMPORTANT**

Deleting the files created by the installation program does not remove your cluster, even if the cluster failed during installation. To remove your cluster, complete the OpenShift Container Platform uninstallation procedures for your specific cloud provider.

4. Extract the installation program. For example, on a computer that uses a Linux operating system, run the following command:

```
$ tar -xvf openshift-install-linux.tar.gz
```

5. Download your installation [pull secret from the Red Hat OpenShift Cluster Manager](#) . This pull secret allows you to authenticate with the services that are provided by the included authorities, including Quay.io, which serves the container images for OpenShift Container Platform components.

### 18.2.10. Creating the installation configuration file

You can customize the OpenShift Container Platform cluster you install on Red Hat OpenStack Platform (RHOSP).

#### Prerequisites

- Obtain the OpenShift Container Platform installation program and the pull secret for your cluster.
- Obtain service principal permissions at the subscription level.

#### Procedure

1. Create the **install-config.yaml** file.
  - a. Change to the directory that contains the installation program and run the following command:

```
$ ./openshift-install create install-config --dir <installation_directory> 1
```

- 1** For **<installation\_directory>**, specify the directory name to store the files that the installation program creates.

**IMPORTANT**

Specify an empty directory. Some installation assets, like bootstrap X.509 certificates have short expiration intervals, so you must not reuse an installation directory. If you want to reuse individual files from another cluster installation, you can copy them into your directory. However, the file names for the installation assets might change between releases. Use caution when copying installation files from an earlier OpenShift Container Platform version.

- b. At the prompts, provide the configuration details for your cloud:
  - i. Optional: Select an SSH key to use to access your cluster machines.

**NOTE**

For production OpenShift Container Platform clusters on which you want to perform installation debugging or disaster recovery, specify an SSH key that your **ssh-agent** process uses.

- ii. Select **openstack** as the platform to target.
  - iii. Specify the Red Hat OpenStack Platform (RHOSP) external network name to use for installing the cluster.
  - iv. Specify the floating IP address to use for external access to the OpenShift API.
  - v. Specify a RHOSP flavor with at least 16 GB RAM to use for control plane nodes and 8 GB RAM for compute nodes.
  - vi. Select the base domain to deploy the cluster to. All DNS records will be sub-domains of this base and will also include the cluster name.
  - vii. Enter a name for your cluster. The name must be 14 or fewer characters long.
  - viii. Paste the [pull secret from the Red Hat OpenShift Cluster Manager](#) .
2. Modify the **install-config.yaml** file. You can find more information about the available parameters in the "Installation configuration parameters" section.
  3. Back up the **install-config.yaml** file so that you can use it to install multiple clusters.

**IMPORTANT**

The **install-config.yaml** file is consumed during the installation process. If you want to reuse the file, you must back it up now.

**Additional resources**

See [Installation configuration parameters section](#) for more information about the available parameters.

**18.2.10.1. Configuring the cluster-wide proxy during installation**

Production environments can deny direct access to the internet and instead have an HTTP or HTTPS proxy available. You can configure a new OpenShift Container Platform cluster to use a proxy by configuring the proxy settings in the **install-config.yaml** file.

## Prerequisites

- You have an existing **install-config.yaml** file.
- You reviewed the sites that your cluster requires access to and determined whether any of them need to bypass the proxy. By default, all cluster egress traffic is proxied, including calls to hosting cloud provider APIs. You added sites to the **Proxy** object's **spec.noProxy** field to bypass the proxy if necessary.



### NOTE

The **Proxy** object **status.noProxy** field is populated with the values of the **networking.machineNetwork[].cidr**, **networking.clusterNetwork[].cidr**, and **networking.serviceNetwork[]** fields from your installation configuration.

For installations on Amazon Web Services (AWS), Google Cloud Platform (GCP), Microsoft Azure, and Red Hat OpenStack Platform (RHOSP), the **Proxy** object **status.noProxy** field is also populated with the instance metadata endpoint (**169.254.169.254**).

## Procedure

1. Edit your **install-config.yaml** file and add the proxy settings. For example:

```
apiVersion: v1
baseDomain: my.domain.com
proxy:
  httpProxy: http://<username>:<pswd>@<ip>:<port> 1
  httpsProxy: https://<username>:<pswd>@<ip>:<port> 2
  noProxy: example.com 3
  additionalTrustBundle: | 4
    -----BEGIN CERTIFICATE-----
    <MY_TRUSTED_CA_CERT>
    -----END CERTIFICATE-----
  ...
```

- 1 A proxy URL to use for creating HTTP connections outside the cluster. The URL scheme must be **http**.
- 2 A proxy URL to use for creating HTTPS connections outside the cluster.
- 3 A comma-separated list of destination domain names, IP addresses, or other network CIDRs to exclude from proxying. Preface a domain with **.** to match subdomains only. For example, **.y.com** matches **x.y.com**, but not **y.com**. Use **\*** to bypass the proxy for all destinations.
- 4 If provided, the installation program generates a config map that is named **user-ca-bundle** in the **openshift-config** namespace that contains one or more additional CA certificates that are required for proxying HTTPS connections. The Cluster Network Operator then creates a **trusted-ca-bundle** config map that merges these contents with the Red Hat Enterprise Linux CoreOS (RHCOS) trust bundle, and this config map is referenced in the

**trustedCA** field of the **Proxy** object. The **additionalTrustBundle** field is required unless the proxy's identity certificate is signed by an authority from the RHCOS trust bundle.



#### NOTE

The installation program does not support the proxy **readinessEndpoints** field.

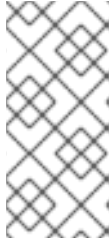

#### NOTE

If the installer times out, restart and then complete the deployment by using the **wait-for** command of the installer. For example:

```
$ ./openshift-install wait-for install-complete --log-level debug
```

2. Save the file and reference it when installing OpenShift Container Platform.

The installation program creates a cluster-wide proxy that is named **cluster** that uses the proxy settings in the provided **install-config.yaml** file. If no proxy settings are provided, a **cluster Proxy** object is still created, but it will have a nil **spec**.



#### NOTE

Only the **Proxy** object named **cluster** is supported, and no additional proxies can be created.

## 18.2.11. Installation configuration parameters

Before you deploy an OpenShift Container Platform cluster, you provide parameter values to describe your account on the cloud platform that hosts your cluster and optionally customize your cluster's platform. When you create the **install-config.yaml** installation configuration file, you provide values for the required parameters through the command line. If you customize your cluster, you can modify the **install-config.yaml** file to provide more details about the platform.



#### NOTE

After installation, you cannot modify these parameters in the **install-config.yaml** file.

### 18.2.11.1. Required configuration parameters

Required installation configuration parameters are described in the following table:

Table 18.2. Required parameters

Parameter	Description	Values
<b>apiVersion</b>	The API version for the <b>install-config.yaml</b> content. The current version is <b>v1</b> . The installer may also support older API versions.	String

Parameter	Description	Values
<b>baseDomain</b>	The base domain of your cloud provider. The base domain is used to create routes to your OpenShift Container Platform cluster components. The full DNS name for your cluster is a combination of the <b>baseDomain</b> and <b>metadata.name</b> parameter values that uses the <b>&lt;metadata.name&gt;.&lt;baseDomain&gt;</b> format.	A fully-qualified domain or subdomain name, such as <b>example.com</b> .
<b>metadata</b>	Kubernetes resource <b>ObjectMeta</b> , from which only the <b>name</b> parameter is consumed.	Object
<b>metadata.name</b>	The name of the cluster. DNS records for the cluster are all subdomains of <b>{{.metadata.name}}.{{.baseDomain}}</b> .	String of lowercase letters, hyphens (-), and periods (.), such as <b>dev</b> . The string must be 14 characters or fewer long.
<b>platform</b>	The configuration for the specific platform upon which to perform the installation: <b>alibabacloud, aws, baremetal, azure, gcp, ibmcloud, openstack, ovirt, vsphere</b> , or <b>{}</b> . For additional information about <b>platform.&lt;platform&gt;</b> parameters, consult the table for your specific platform that follows.	Object

Parameter	Description	Values
<b>pullSecret</b>	Get a <a href="#">pull secret from the Red Hat OpenShift Cluster Manager</a> to authenticate downloading container images for OpenShift Container Platform components from services such as Quay.io.	<pre>{   "auths":{     "cloud.openshift.com":{       "auth":"b3Blb=",       "email":"you@example.com"     },     "quay.io":{       "auth":"b3Blb=",       "email":"you@example.com"     }   } }</pre>

### 18.2.11.2. Network configuration parameters

You can customize your installation configuration based on the requirements of your existing network infrastructure. For example, you can expand the IP address block for the cluster network or provide different IP address blocks than the defaults.

Only IPv4 addresses are supported.

Table 18.3. Network parameters

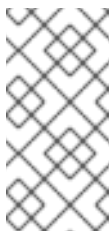
Parameter	Description	Values
<b>networking</b>	The configuration for the cluster network.	Object  <div style="margin-left: 20px;"> <p><b>NOTE</b></p> <p>You cannot modify parameters specified by the <b>networking</b> object after installation.</p> </div>
<b>networking.networkType</b>	The cluster network provider Container Network Interface (CNI) plugin to install.	Either <b>OpenShiftSDN</b> or <b>OVNKubernetes</b> . <b>OpenShiftSDN</b> is a CNI provider for all-Linux networks. <b>OVNKubernetes</b> is a CNI provider for Linux networks and hybrid networks that contain both Linux and Windows servers. The default value is <b>OpenShiftSDN</b> .

Parameter	Description	Values
<b>networking.clusterNetwork</b>	<p>The IP address blocks for pods.</p> <p>The default value is <b>10.128.0.0/14</b> with a host prefix of <b>/23</b>.</p> <p>If you specify multiple IP address blocks, the blocks must not overlap.</p>	<p>An array of objects. For example:</p> <pre>networking:   clusterNetwork:     - cidr: 10.128.0.0/14       hostPrefix: 23</pre>
<b>networking.clusterNetwork.cidr</b>	<p>Required if you use <b>networking.clusterNetwork</b>. An IP address block.</p> <p>An IPv4 network.</p>	<p>An IP address block in Classless Inter-Domain Routing (CIDR) notation. The prefix length for an IPv4 block is between <b>0</b> and <b>32</b>.</p>
<b>networking.clusterNetwork.hostPrefix</b>	<p>The subnet prefix length to assign to each individual node. For example, if <b>hostPrefix</b> is set to <b>23</b> then each node is assigned a <b>/23</b> subnet out of the given <b>cidr</b>. A <b>hostPrefix</b> value of <b>23</b> provides 510 (<math>2^{(32 - 23)} - 2</math>) pod IP addresses.</p>	<p>A subnet prefix.</p> <p>The default value is <b>23</b>.</p>
<b>networking.serviceNetwork</b>	<p>The IP address block for services. The default value is <b>172.30.0.0/16</b>.</p> <p>The OpenShift SDN and OVN-Kubernetes network providers support only a single IP address block for the service network.</p>	<p>An array with an IP address block in CIDR format. For example:</p> <pre>networking:   serviceNetwork:     - 172.30.0.0/16</pre>
<b>networking.machineNetwork</b>	<p>The IP address blocks for machines.</p> <p>If you specify multiple IP address blocks, the blocks must not overlap.</p>	<p>An array of objects. For example:</p> <pre>networking:   machineNetwork:     - cidr: 10.0.0.0/16</pre>
<b>networking.machineNetwork.cidr</b>	<p>Required if you use <b>networking.machineNetwork</b>. An IP address block. The default value is <b>10.0.0.0/16</b> for all platforms other than libvirt. For libvirt, the default value is <b>192.168.126.0/24</b>.</p>	<p>An IP network block in CIDR notation.</p> <p>For example, <b>10.0.0.0/16</b>.</p> <div style="display: flex; align-items: flex-start;">  <div> <p><b>NOTE</b></p> <p>Set the <b>networking.machineNetwork</b> to match the CIDR that the preferred NIC resides in.</p> </div> </div>

### 18.2.11.3. Optional configuration parameters





Optional installation configuration parameters are described in the following table:



**Table 18.4. Optional parameters**

Parameter	Description	Values
<b>additionalTrustBundle</b>	A PEM-encoded X.509 certificate bundle that is added to the nodes' trusted certificate store. This trust bundle may also be used when a proxy has been configured.	String
<b>cgroupsV2</b>	Enables <a href="#">Linux control groups version 2</a> (cgroups v2) on specific nodes in your cluster. The OpenShift Container Platform process for enabling cgroups v2 disables all cgroup version 1 controllers and hierarchies. The OpenShift Container Platform cgroups version 2 feature is in Developer Preview and is not supported by Red Hat at this time.	<b>true</b>
<b>compute</b>	The configuration for the machines that comprise the compute nodes.	Array of <b>MachinePool</b> objects.
<b>compute.architecture</b>	Determines the instruction set architecture of the machines in the pool. Currently, clusters with varied architectures are not supported. All pools must specify the same architecture. Valid values are <b>amd64</b> (the default).	String
<b>compute.hyperthreading</b>	Whether to enable or disable simultaneous multithreading, or <b>hyperthreading</b> , on compute machines. By default, simultaneous multithreading is enabled to increase the performance of your machines' cores.	<b>Enabled</b> or <b>Disabled</b>
	 <p><b>IMPORTANT</b></p> <p>If you disable simultaneous multithreading, ensure that your capacity planning accounts for the dramatically decreased machine performance.</p>	

Parameter	Description	Values
<b>compute.name</b>	Required if you use <b>compute</b> . The name of the machine pool.	<b>worker</b>
<b>compute.platform</b>	Required if you use <b>compute</b> . Use this parameter to specify the cloud provider to host the worker machines. This parameter value must match the <b>controlPlane.platform</b> parameter value.	<b>alibabacloud, aws, azure, gcp, ibmcloud, openstack, ovirt, vsphere, or {}</b>
<b>compute.replicas</b>	The number of compute machines, which are also known as worker machines, to provision.	A positive integer greater than or equal to <b>2</b> . The default value is <b>3</b> .
<b>controlPlane</b>	The configuration for the machines that comprise the control plane.	Array of <b>MachinePool</b> objects.
<b>controlPlane.architecture</b>	Determines the instruction set architecture of the machines in the pool. Currently, clusters with varied architectures are not supported. All pools must specify the same architecture. Valid values are <b>amd64</b> (the default).	String
<b>controlPlane.hyperthreading</b>	<p>Whether to enable or disable simultaneous multithreading, or <b>hyperthreading</b>, on control plane machines. By default, simultaneous multithreading is enabled to increase the performance of your machines' cores.</p> <div style="display: flex; align-items: flex-start;"> <div style="width: 40px; height: 100px; background: repeating-linear-gradient(45deg, transparent, transparent 2px, black 2px, black 4px); margin-right: 10px;"></div> <div> <p><b>IMPORTANT</b></p> <p>If you disable simultaneous multithreading, ensure that your capacity planning accounts for the dramatically decreased machine performance.</p> </div> </div>	<b>Enabled</b> or <b>Disabled</b>
<b>controlPlane.name</b>	Required if you use <b>controlPlane</b> . The name of the machine pool.	<b>master</b>

Parameter	Description	Values
<b>controlPlane.platform</b>	Required if you use <b>controlPlane</b> . Use this parameter to specify the cloud provider that hosts the control plane machines. This parameter value must match the <b>compute.platform</b> parameter value.	<b>alibabacloud, aws, azure, gcp, ibmcloud, openstack, ovirt, vsphere</b> , or <code>{}</code>
<b>controlPlane.replicas</b>	The number of control plane machines to provision.	The only supported value is <b>3</b> , which is the default value.
<b>credentialsMode</b>	<p>The Cloud Credential Operator (CCO) mode. If no mode is specified, the CCO dynamically tries to determine the capabilities of the provided credentials, with a preference for mint mode on the platforms where multiple modes are supported.</p> <div style="display: flex; align-items: flex-start;"> <div style="flex: 1;">  </div> <div style="flex: 2;"> <p><b>NOTE</b></p> <p>Not all CCO modes are supported for all cloud providers. For more information on CCO modes, see the <i>Cloud Credential Operator</i> entry in the <i>Cluster Operators reference</i> content.</p> </div> </div> <div style="display: flex; align-items: flex-start; margin-top: 10px;"> <div style="flex: 1;">  </div> <div style="flex: 2;"> <p><b>NOTE</b></p> <p>If your AWS account has service control policies (SCP) enabled, you must configure the <b>credentialsMode</b> parameter to <b>Mint</b>, <b>Passthrough</b> or <b>Manual</b>.</p> </div> </div>	<b>Mint, Passthrough, Manual</b> or an empty string ( <code>""</code> ).

Parameter	Description	Values
<b>fips</b>	<p>Enable or disable FIPS mode. The default is <b>false</b> (disabled). If FIPS mode is enabled, the Red Hat Enterprise Linux CoreOS (RHCOS) machines that OpenShift Container Platform runs on bypass the default Kubernetes cryptography suite and use the cryptography modules that are provided with RHCOS instead.</p> <div data-bbox="486 584 592 1361" style="background-color: black; color: white; padding: 5px; margin-bottom: 10px;"> <p><b>IMPORTANT</b></p> <p>To enable FIPS mode for your cluster, you must run the installation program from a Red Hat Enterprise Linux (RHEL) computer configured to operate in FIPS mode. For more information about configuring FIPS mode on RHEL, see <a href="#">Installing the system in FIPS mode</a>. The use of FIPS validated or Modules In Process cryptographic libraries is only supported on OpenShift Container Platform deployments on the <b>x86_64</b> architecture.</p> </div> <div data-bbox="486 1406 592 1608" style="background-color: black; color: white; padding: 5px;"> <p><b>NOTE</b></p> <p>If you are using Azure File storage, you cannot enable FIPS mode.</p> </div>	<b>false</b> or <b>true</b>

Parameter	Description	Values
<b>imageContentSources</b>	Sources and repositories for the release-image content.	Array of objects. Includes a <b>source</b> and, optionally, <b>mirrors</b> , as described in the following rows of this table.
<b>imageContentSources.source</b>	Required if you use <b>imageContentSources</b> . Specify the repository that users refer to, for example, in image pull specifications.	String
<b>imageContentSources.mirrors</b>	Specify one or more repositories that may also contain the same images.	Array of strings
<b>publish</b>	How to publish or expose the user-facing endpoints of your cluster, such as the Kubernetes API, OpenShift routes.	<p><b>Internal</b> or <b>External</b>. The default value is <b>External</b>.</p> <p>Setting this field to <b>Internal</b> is not supported on non-cloud platforms and IBM Cloud VPC.</p> <div style="display: flex; align-items: flex-start;">  <div> <p><b>IMPORTANT</b></p> <p>If the value of the field is set to <b>Internal</b>, the cluster will become non-functional. For more information, refer to <a href="#">BZ#1953035</a>.</p> </div> </div>
<b>sshKey</b>	<p>The SSH key or keys to authenticate access your cluster machines.</p> <div style="display: flex; align-items: flex-start;">  <div> <p><b>NOTE</b></p> <p>For production OpenShift Container Platform clusters on which you want to perform installation debugging or disaster recovery, specify an SSH key that your <b>ssh-agent</b> process uses.</p> </div> </div>	<p>One or more keys. For example:</p> <pre>sshKey:   &lt;key1&gt;   &lt;key2&gt;   &lt;key3&gt;</pre>

#### 18.2.11.4. Additional Red Hat OpenStack Platform (RHOSP) configuration parameters

Additional RHOSP configuration parameters are described in the following table:

**Table 18.5. Additional RHOSP parameters**

Parameter	Description	Values
<b>compute.platform.openstack.rootVolume.size</b>	For compute machines, the size in gigabytes of the root volume. If you do not set this value, machines use ephemeral storage.	Integer, for example <b>30</b> .
<b>compute.platform.openstack.rootVolume.type</b>	For compute machines, the root volume's type.	String, for example <b>performance</b> .
<b>controlPlane.platform.openstack.rootVolume.size</b>	For control plane machines, the size in gigabytes of the root volume. If you do not set this value, machines use ephemeral storage.	Integer, for example <b>30</b> .
<b>controlPlane.platform.openstack.rootVolume.type</b>	For control plane machines, the root volume's type.	String, for example <b>performance</b> .
<b>platform.openstack.cloud</b>	The name of the RHOSP cloud to use from the list of clouds in the <b>clouds.yaml</b> file.	String, for example <b>MyCloud</b> .
<b>platform.openstack.externalNetwork</b>	The RHOSP external network name to be used for installation.	String, for example <b>external</b> .
<b>platform.openstack.computeFlavor</b>	<p>The RHOSP flavor to use for control plane and compute machines.</p> <p>This property is deprecated. To use a flavor as the default for all machine pools, add it as the value of the <b>type</b> key in the <b>platform.openstack.defaultMachinePlatform</b> property. You can also set a flavor value for each machine pool individually.</p>	String, for example <b>m1.xlarge</b> .

### 18.2.11.5. Optional RHOSP configuration parameters

Optional RHOSP configuration parameters are described in the following table:

**Table 18.6. Optional RHOSP parameters**

Parameter	Description	Values
<b>compute.platform.openstack.additionalNetworkIds</b>	Additional networks that are associated with compute machines. Allowed address pairs are not created for additional networks.	A list of one or more UUIDs as strings. For example, <b>fa806b2f-ac49-4bce-b9db-124bc64209bf</b> .
<b>compute.platform.openstack.additionalSecurityGroupIds</b>	Additional security groups that are associated with compute machines.	A list of one or more UUIDs as strings. For example, <b>7ee219f3-d2e9-48a1-96c2-e7429f1b0da7</b> .
<b>compute.platform.openstack.zones</b>	<p>RHOSP Compute (Nova) availability zones (AZs) to install machines on. If this parameter is not set, the installer relies on the default settings for Nova that the RHOSP administrator configured.</p> <p>On clusters that use Kuryr, RHOSP Octavia does not support availability zones. Load balancers and, if you are using the Amphora provider driver, OpenShift Container Platform services that rely on Amphora VMs, are not created according to the value of this property.</p>	A list of strings. For example, <b>["zone-1", "zone-2"]</b> .
<b>compute.platform.openstack.rootVolume.zones</b>	For compute machines, the availability zone to install root volumes on. If you do not set a value for this parameter, the installer selects the default availability zone.	A list of strings, for example <b>["zone-1", "zone-2"]</b> .

Parameter	Description	Values
<b>compute.platform.openstack.serverGroupPolicy</b>	<p>Server group policy to apply to the group that will contain the compute machines in the pool. You cannot change server group policies or affiliations after creation. Supported options include <b>anti-affinity</b>, <b>soft-affinity</b>, and <b>soft-anti-affinity</b>. The default value is <b>soft-anti-affinity</b>.</p> <p>An <b>affinity</b> policy prevents migrations and therefore affects RHOSP upgrades. The <b>affinity</b> policy is not supported.</p> <p>If you use a strict <b>anti-affinity</b> policy, an additional RHOSP host is required during instance migration.</p>	A server group policy to apply to the machine pool. For example, <b>soft-affinity</b> .
<b>controlPlane.platform.openstack.additionalNetworkIDs</b>	Additional networks that are associated with control plane machines. Allowed address pairs are not created for additional networks.	A list of one or more UUIDs as strings. For example, <b>fa806b2f-ac49-4bce-b9db-124bc64209bf</b> .
<b>controlPlane.platform.openstack.additionalSecurityGroupIDs</b>	Additional security groups that are associated with control plane machines.	A list of one or more UUIDs as strings. For example, <b>7ee219f3-d2e9-48a1-96c2-e7429f1b0da7</b> .



Parameter	Description	Values
<b>controlPlane.placement.openstack.zones</b>	<p>RHOSP Compute (Nova) availability zones (AZs) to install machines on. If this parameter is not set, the installer relies on the default settings for Nova that the RHOSP administrator configured.</p> <p>On clusters that use Kuryr, RHOSP Octavia does not support availability zones. Load balancers and, if you are using the Amphora provider driver, OpenShift Container Platform services that rely on Amphora VMs, are not created according to the value of this property.</p>	A list of strings. For example, <b>["zone-1", "zone-2"]</b> .
<b>controlPlane.placement.openstack.rootVolume.zones</b>	For control plane machines, the availability zone to install root volumes on. If you do not set this value, the installer selects the default availability zone.	A list of strings, for example <b>["zone-1", "zone-2"]</b> .
<b>controlPlane.placement.openstack.serverGroupPolicy</b>	<p>Server group policy to apply to the group that will contain the control plane machines in the pool. You cannot change server group policies or affiliations after creation. Supported options include <b>anti-affinity</b>, <b>soft-affinity</b>, and <b>soft-anti-affinity</b>. The default value is <b>soft-anti-affinity</b>.</p> <p>An <b>affinity</b> policy prevents migrations, and therefore affects RHOSP upgrades. The <b>affinity</b> policy is not supported.</p> <p>If you use a strict <b>anti-affinity</b> policy, an additional RHOSP host is required during instance migration.</p>	A server group policy to apply to the machine pool. For example, <b>soft-affinity</b> .

Parameter	Description	Values
<b>platform.openstack.clusterOSImage</b>	<p>The location from which the installer downloads the RHCOS image.</p> <p>You must set this parameter to perform an installation in a restricted network.</p>	<p>An HTTP or HTTPS URL, optionally with an SHA-256 checksum.</p> <p>For example,  <b>http://mirror.example.com/images/rhcos-43.81.201912131630.0-openstack.x86_64.qcow2.gz?sha256=ffebbd68e8a1f2a245ca19522c16c86f67f9ac8e4e0c1f0a812b068b16f7265d</b>. The value can also be the name of an existing Glance image, for example <b>my-rhcos</b>.</p>
<b>platform.openstack.clusterOSImageProperties</b>	<p>Properties to add to the installer-uploaded ClusterOSImage in Glance. This property is ignored if <b>platform.openstack.clusterOSImage</b> is set to an existing Glance image.</p> <p>You can use this property to exceed the default persistent volume (PV) limit for RHOSP of 26 PVs per node. To exceed the limit, set the <b>hw_scsi_model</b> property value to <b>virtio-scsi</b> and the <b>hw_disk_bus</b> value to <b>scsi</b>.</p> <p>You can also use this property to enable the QEMU guest agent by including the <b>hw_qemu_guest_agent</b> property with a value of <b>yes</b>.</p>	<p>A list of key-value string pairs. For example,  <b>["hw_scsi_model": "virtio-scsi", "hw_disk_bus": "scsi"]</b>.</p>
<b>platform.openstack.defaultMachinePlatform</b>	<p>The default machine pool platform configuration.</p>	<pre>{   "type": "ml.large",   "rootVolume": {     "size": 30,     "type": "performance"   } }</pre>

Parameter	Description	Values
<b>platform.openstack.ingressFloatingIP</b>	An existing floating IP address to associate with the Ingress port. To use this property, you must also define the <b>platform.openstack.externalNetwork</b> property.	An IP address, for example <b>128.0.0.1</b> .
<b>platform.openstack.apiFloatingIP</b>	An existing floating IP address to associate with the API load balancer. To use this property, you must also define the <b>platform.openstack.externalNetwork</b> property.	An IP address, for example <b>128.0.0.1</b> .
<b>platform.openstack.externalDNS</b>	IP addresses for external DNS servers that cluster instances use for DNS resolution.	A list of IP addresses as strings. For example, <b>["8.8.8.8", "192.168.1.12"]</b> .
<b>platform.openstack.machinesSubnet</b>	<p>The UUID of a RHOSP subnet that the cluster's nodes use. Nodes and virtual IP (VIP) ports are created on this subnet.</p> <p>The first item in <b>networking.machineNetwork</b> must match the value of <b>machinesSubnet</b>.</p> <p>If you deploy to a custom subnet, you cannot specify an external DNS server to the OpenShift Container Platform installer. Instead, <a href="#">add DNS to the subnet in RHOSP</a>.</p>	A UUID as a string. For example, <b>fa806b2f-ac49-4bce-b9db-124bc64209bf</b> .

### 18.2.11.6. Custom subnets in RHOSP deployments

Optionally, you can deploy a cluster on a Red Hat OpenStack Platform (RHOSP) subnet of your choice. The subnet's GUID is passed as the value of **platform.openstack.machinesSubnet** in the **install-config.yaml** file.

This subnet is used as the cluster's primary subnet. By default, nodes and ports are created on it. You can create nodes and ports on a different RHOSP subnet by setting the value of the **platform.openstack.machinesSubnet** property to the subnet's UUID.

Before you run the OpenShift Container Platform installer with a custom subnet, verify that your configuration meets the following requirements:

- The subnet that is used by **platform.openstack.machinesSubnet** has DHCP enabled.

- The CIDR of **platform.openstack.machinesSubnet** matches the CIDR of **networking.machineNetwork**.
- The installation program user has permission to create ports on this network, including ports with fixed IP addresses.

Clusters that use custom subnets have the following limitations:

- If you plan to install a cluster that uses floating IP addresses, the **platform.openstack.machinesSubnet** subnet must be attached to a router that is connected to the **externalNetwork** network.
- If the **platform.openstack.machinesSubnet** value is set in the **install-config.yaml** file, the installation program does not create a private network or subnet for your RHOSP machines.
- You cannot use the **platform.openstack.externalDNS** property at the same time as a custom subnet. To add DNS to a cluster that uses a custom subnet, configure DNS on the RHOSP network.



#### NOTE

By default, the API VIP takes x.x.x.5 and the Ingress VIP takes x.x.x.7 from your network's CIDR block. To override these default values, set values for **platform.openstack.apiVIP** and **platform.openstack.ingressVIP** that are outside of the DHCP allocation pool.

### 18.2.11.7. Deploying a cluster with bare metal machines

If you want your cluster to use bare metal machines, modify the **install-config.yaml** file. Your cluster can have both control plane and compute machines running on bare metal, or just compute machines.

Bare-metal compute machines are not supported on clusters that use Kuryr.



#### NOTE

Be sure that your **install-config.yaml** file reflects whether the RHOSP network that you use for bare metal workers supports floating IP addresses or not.

#### Prerequisites

- The RHOSP [Bare Metal service \(Ironic\)](#) is enabled and accessible via the RHOSP Compute API.
- Bare metal is available as a [RHOSP flavor](#).
- The RHOSP network supports both VM and bare metal server attachment.
- Your network configuration does not rely on a provider network. Provider networks are not supported.
- If you want to deploy the machines on a pre-existing network, a RHOSP subnet is provisioned.
- If you want to deploy the machines on an installer-provisioned network, the RHOSP Bare Metal service (Ironic) is able to listen for and interact with Preboot eXecution Environment (PXE) boot machines that run on tenant networks.
- You created an **install-config.yaml** file as part of the OpenShift Container Platform installation process.

## Procedure

1. In the **install-config.yaml** file, edit the flavors for machines:
  - a. If you want to use bare-metal control plane machines, change the value of **controlPlane.platform.openstack.type** to a bare metal flavor.
  - b. Change the value of **compute.platform.openstack.type** to a bare metal flavor.
  - c. If you want to deploy your machines on a pre-existing network, change the value of **platform.openstack.machinesSubnet** to the RHOSP subnet UUID of the network. Control plane and compute machines must use the same subnet.

### An example bare metal **install-config.yaml** file

```
controlPlane:
  platform:
    openstack:
      type: <bare_metal_control_plane_flavor> 1
  ...

compute:
  - architecture: amd64
    hyperthreading: Enabled
    name: worker
    platform:
      openstack:
        type: <bare_metal_compute_flavor> 2
    replicas: 3
  ...

platform:
  openstack:
    machinesSubnet: <subnet_UUID> 3
  ...
```

- 1 If you want to have bare-metal control plane machines, change this value to a bare metal flavor.
- 2 Change this value to a bare metal flavor to use for compute machines.
- 3 If you want to use a pre-existing network, change this value to the UUID of the RHOSP subnet.

Use the updated **install-config.yaml** file to complete the installation process. The compute machines that are created during deployment use the flavor that you added to the file.



**NOTE**

The installer may time out while waiting for bare metal machines to boot.

If the installer times out, restart and then complete the deployment by using the **wait-for** command of the installer. For example:

```

$ ./openshift-install wait-for install-complete --log-level debug
    
```

**18.2.11.8. Cluster deployment on RHOSP provider networks**

You can deploy your OpenShift Container Platform clusters on Red Hat OpenStack Platform (RHOSP) with a primary network interface on a provider network. Provider networks are commonly used to give projects direct access to a public network that can be used to reach the internet. You can also share provider networks among projects as part of the network creation process.

RHOSP provider networks map directly to an existing physical network in the data center. A RHOSP administrator must create them.

In the following example, OpenShift Container Platform workloads are connected to a data center by using a provider network:

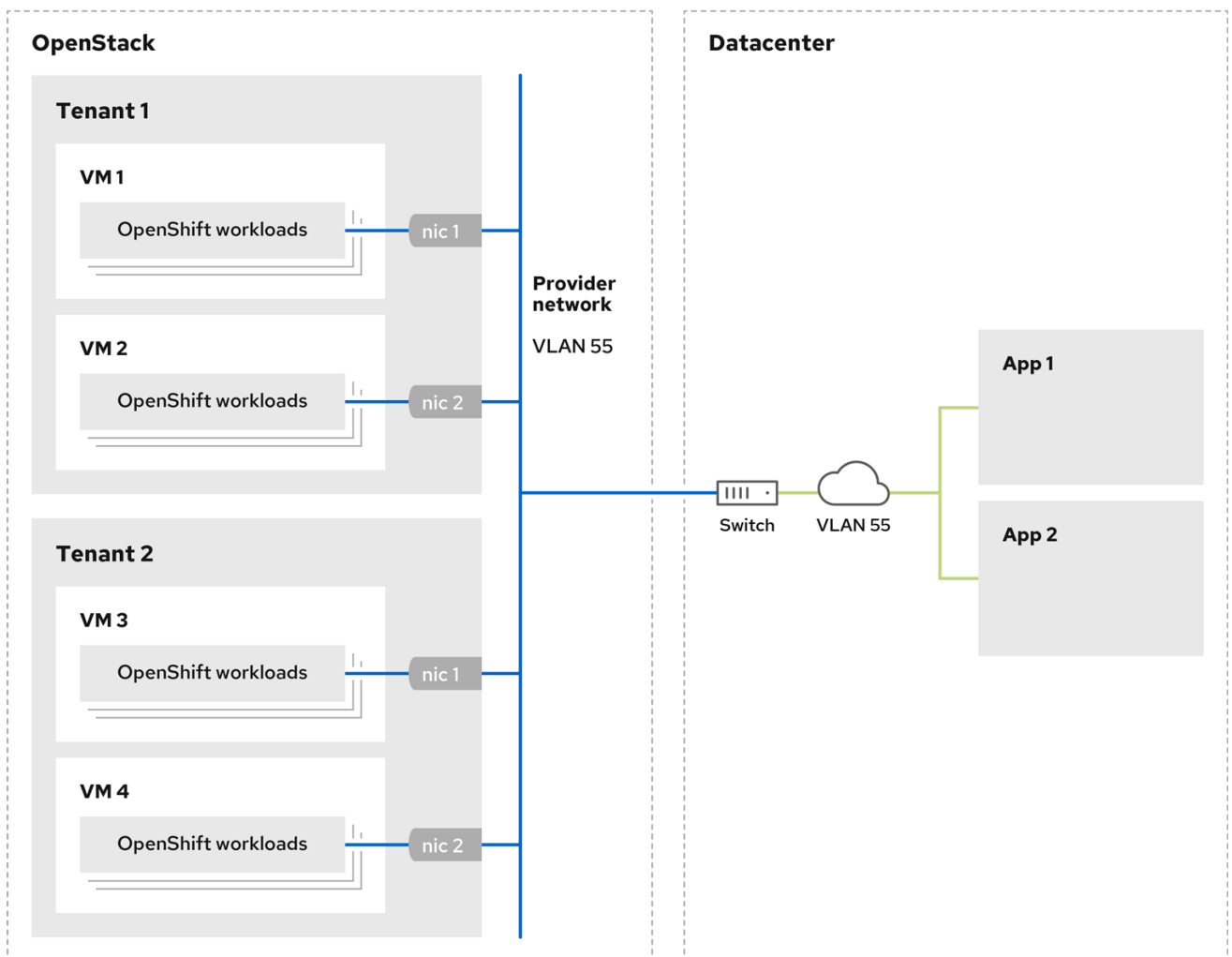

I70\_OpenShift\_0621

OpenShift Container Platform clusters that are installed on provider networks do not require tenant networks or floating IP addresses. The installer does not create these resources during installation.

Example provider network types include flat (untagged) and VLAN (802.1Q tagged).

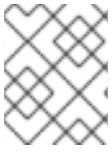

#### NOTE

A cluster can support as many provider network connections as the network type allows. For example, VLAN networks typically support up to 4096 connections.

You can learn more about provider and tenant networks in [the RHOSP documentation](#).

#### 18.2.11.8.1. RHOSP provider network requirements for cluster installation

Before you install an OpenShift Container Platform cluster, your Red Hat OpenStack Platform (RHOSP) deployment and provider network must meet a number of conditions:

- The [RHOSP networking service \(Neutron\) is enabled](#) and accessible through the RHOSP networking API.
- The RHOSP networking service has the [port security and allowed address pairs extensions enabled](#).
- The provider network can be shared with other tenants.

#### TIP

Use the **openstack network create** command with the **--share** flag to create a network that can be shared.

- The RHOSP project that you use to install the cluster must own the provider network, as well as an appropriate subnet.

#### TIP

To create a network for a project that is named "openshift," enter the following command

```
$ openstack network create --project openshift
```

To create a subnet for a project that is named "openshift," enter the following command

```
$ openstack subnet create --project openshift
```

To learn more about creating networks on RHOSP, read [the provider networks documentation](#).

If the cluster is owned by the **admin** user, you must run the installer as that user to create ports on the network.

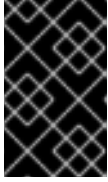
**IMPORTANT**

Provider networks must be owned by the RHOSP project that is used to create the cluster. If they are not, the RHOSP Compute service (Nova) cannot request a port from that network.

- Verify that the provider network can reach the RHOSP metadata service IP address, which is **169.254.169.254** by default.  
Depending on your RHOSP SDN and networking service configuration, you might need to provide the route when you create the subnet. For example:

```
$ openstack subnet create --dhcp --host-route
destination=169.254.169.254/32,gateway=192.0.2.2 ...
```

- Optional: To secure the network, create [role-based access control \(RBAC\)](#) rules that limit network access to a single project.

**18.2.11.8.2. Deploying a cluster that has a primary interface on a provider network**

You can deploy an OpenShift Container Platform cluster that has its primary network interface on an Red Hat OpenStack Platform (RHOSP) provider network.

**Prerequisites**

- Your Red Hat OpenStack Platform (RHOSP) deployment is configured as described by "RHOSP provider network requirements for cluster installation".

**Procedure**

1. In a text editor, open the **install-config.yaml** file.
2. Set the value of the **platform.openstack.apiVIP** property to the IP address for the API VIP.
3. Set the value of the **platform.openstack.ingressVIP** property to the IP address for the Ingress VIP.
4. Set the value of the **platform.openstack.machinesSubnet** property to the UUID of the provider network subnet.
5. Set the value of the **networking.machineNetwork.cidr** property to the CIDR block of the provider network subnet.

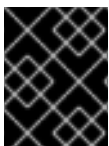
**IMPORTANT**

The **platform.openstack.apiVIP** and **platform.openstack.ingressVIP** properties must both be unassigned IP addresses from the **networking.machineNetwork.cidr** block.

**Section of an installation configuration file for a cluster that relies on a RHOSP provider network**

```
...
platform:
  openstack:
    apiVIP: 192.0.2.13
```



```

ingressVIP: 192.0.2.23
machinesSubnet: fa806b2f-ac49-4bce-b9db-124bc64209bf
# ...
networking:
  machineNetwork:
    - cidr: 192.0.2.0/24

```



### WARNING

You cannot set the **platform.openstack.externalNetwork** or **platform.openstack.externalDNS** parameters while using a provider network for the primary network interface.

When you deploy the cluster, the installer uses the **install-config.yaml** file to deploy the cluster on the provider network.

### TIP

You can add additional networks, including provider networks, to the **platform.openstack.additionalNetworkIDs** list.

After you deploy your cluster, you can attach pods to additional networks. For more information, see [Understanding multiple networks](#).

#### 18.2.11.9. Sample customized **install-config.yaml** file for RHOSP

This sample **install-config.yaml** demonstrates all of the possible Red Hat OpenStack Platform (RHOSP) customization options.

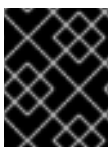

### IMPORTANT

This sample file is provided for reference only. You must obtain your **install-config.yaml** file by using the installation program.

```

apiVersion: v1
baseDomain: example.com
controlPlane:
  name: master
  platform: {}
  replicas: 3
compute:
  - name: worker
    platform:
      openstack:
        type: ml.large
      replicas: 3
metadata:
  name: example
networking:

```

```

clusterNetwork:
- cidr: 10.128.0.0/14
  hostPrefix: 23
machineNetwork:
- cidr: 10.0.0.0/16
serviceNetwork:
- 172.30.0.0/16
networkType: OpenShiftSDN
platform:
openstack:
  cloud: mycloud
  externalNetwork: external
  computeFlavor: m1.xlarge
  apiFloatingIP: 128.0.0.1
fips: false
pullSecret: '{"auths": ...}'
sshKey: ssh-ed25519 AAAA...

```

### 18.2.12. Generating a key pair for cluster node SSH access

During an OpenShift Container Platform installation, you can provide an SSH public key to the installation program. The key is passed to the Red Hat Enterprise Linux CoreOS (RHCOS) nodes through their Ignition config files and is used to authenticate SSH access to the nodes. The key is added to the `~/.ssh/authorized_keys` list for the **core** user on each node, which enables password-less authentication.

After the key is passed to the nodes, you can use the key pair to SSH in to the RHCOS nodes as the user **core**. To access the nodes through SSH, the private key identity must be managed by SSH for your local user.

If you want to SSH in to your cluster nodes to perform installation debugging or disaster recovery, you must provide the SSH public key during the installation process. The `./openshift-install gather` command also requires the SSH public key to be in place on the cluster nodes.



#### IMPORTANT

Do not skip this procedure in production environments, where disaster recovery and debugging is required.

#### Procedure

1. If you do not have an existing SSH key pair on your local machine to use for authentication onto your cluster nodes, create one. For example, on a computer that uses a Linux operating system, run the following command:

```
$ ssh-keygen -t ed25519 -N "" -f <path>/<file_name> 1
```

- 1 Specify the path and file name, such as `~/.ssh/id_ed25519`, of the new SSH key. If you have an existing key pair, ensure your public key is in the your `~/.ssh` directory.

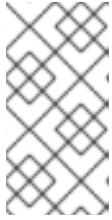
**NOTE**

If you plan to install an OpenShift Container Platform cluster that uses FIPS validated or Modules In Process cryptographic libraries on the **x86\_64** architecture, do not create a key that uses the **ed25519** algorithm. Instead, create a key that uses the **rsa** or **ecdsa** algorithm.

2. View the public SSH key:

```
$ cat <path>/<file_name>.pub
```

For example, run the following to view the `~/.ssh/id_ed25519.pub` public key:

```
$ cat ~/.ssh/id_ed25519.pub
```

3. Add the SSH private key identity to the SSH agent for your local user, if it has not already been added. SSH agent management of the key is required for password-less SSH authentication onto your cluster nodes, or if you want to use the `./openshift-install gather` command.

**NOTE**

On some distributions, default SSH private key identities such as `~/.ssh/id_rsa` and `~/.ssh/id_dsa` are managed automatically.

- a. If the **ssh-agent** process is not already running for your local user, start it as a background task:

```
$ eval "$(ssh-agent -s)"
```

**Example output**

```
Agent pid 31874
```

**NOTE**

If your cluster is in FIPS mode, only use FIPS-compliant algorithms to generate the SSH key. The key must be either RSA or ECDSA.

4. Add your SSH private key to the **ssh-agent**:

```
$ ssh-add <path>/<file_name> 1
```

- 1** Specify the path and file name for your SSH private key, such as `~/.ssh/id_ed25519`

**Example output**

```
Identity added: /home/<you>/<path>/<file_name> (<computer_name>)
```

**Next steps**

- When you install OpenShift Container Platform, provide the SSH public key to the installation program.

### 18.2.13. Enabling access to the environment

At deployment, all OpenShift Container Platform machines are created in a Red Hat OpenStack Platform (RHOSP)-tenant network. Therefore, they are not accessible directly in most RHOSP deployments.

You can configure OpenShift Container Platform API and application access by using floating IP addresses (FIPs) during installation. You can also complete an installation without configuring FIPs, but the installer will not configure a way to reach the API or applications externally.

#### 18.2.13.1. Enabling access with floating IP addresses

Create floating IP (FIP) addresses for external access to the OpenShift Container Platform API and cluster applications.

##### Procedure

1. Using the Red Hat OpenStack Platform (RHOSP) CLI, create the API FIP:

```
$ openstack floating ip create --description "API <cluster_name>.<base_domain>"  
<external_network>
```

2. Using the Red Hat OpenStack Platform (RHOSP) CLI, create the apps, or Ingress, FIP:

```
$ openstack floating ip create --description "Ingress <cluster_name>.<base_domain>"  
<external_network>
```

3. Add records that follow these patterns to your DNS server for the API and Ingress FIPs:

```
api.<cluster_name>.<base_domain>. IN A <API_FIP>  
*.apps.<cluster_name>.<base_domain>. IN A <apps_FIP>
```



## NOTE

If you do not control the DNS server, you can access the cluster by adding the cluster domain names such as the following to your `/etc/hosts` file:

- `<api_floating_ip> api.<cluster_name>.<base_domain>`
- `<application_floating_ip> grafana-openshift-monitoring.apps.<cluster_name>.<base_domain>`
- `<application_floating_ip> prometheus-k8s-openshift-monitoring.apps.<cluster_name>.<base_domain>`
- `<application_floating_ip> oauth-openshift.apps.<cluster_name>.<base_domain>`
- `<application_floating_ip> console-openshift-console.apps.<cluster_name>.<base_domain>`
- `application_floating_ip integrated-oauth-server-openshift-authentication.apps.<cluster_name>.<base_domain>`

The cluster domain names in the `/etc/hosts` file grant access to the web console and the monitoring interface of your cluster locally. You can also use the `kubectl` or `oc`. You can access the user applications by using the additional entries pointing to the `<application_floating_ip>`. This action makes the API and applications accessible to only you, which is not suitable for production deployment, but does allow installation for development and testing.

4. Add the FIPs to the `install-config.yaml` file as the values of the following parameters:

- `platform.openstack.ingressFloatingIP`
- `platform.openstack.apiFloatingIP`

If you use these values, you must also enter an external network as the value of the `platform.openstack.externalNetwork` parameter in the `install-config.yaml` file.

## TIP

You can make OpenShift Container Platform resources available outside of the cluster by assigning a floating IP address and updating your firewall configuration.

### 18.2.13.2. Completing installation without floating IP addresses

You can install OpenShift Container Platform on Red Hat OpenStack Platform (RHOSP) without providing floating IP addresses.

In the `install-config.yaml` file, do not define the following parameters:

- `platform.openstack.ingressFloatingIP`
- `platform.openstack.apiFloatingIP`

If you cannot provide an external network, you can also leave `platform.openstack.externalNetwork` blank. If you do not provide a value for `platform.openstack.externalNetwork`, a router is not created for

you, and, without additional action, the installer will fail to retrieve an image from Glance. You must configure external connectivity on your own.

If you run the installer from a system that cannot reach the cluster API due to a lack of floating IP addresses or name resolution, installation fails. To prevent installation failure in these cases, you can use a proxy network or run the installer from a system that is on the same network as your machines.



## NOTE

You can enable name resolution by creating DNS records for the API and Ingress ports. For example:

```
api.<cluster_name>.<base_domain>. IN A <api_port_IP>
*.apps.<cluster_name>.<base_domain>. IN A <ingress_port_IP>
```

If you do not control the DNS server, you can add the record to your `/etc/hosts` file. This action makes the API accessible to only you, which is not suitable for production deployment but does allow installation for development and testing.

## 18.2.14. Deploying the cluster

You can install OpenShift Container Platform on a compatible cloud platform.



## IMPORTANT

You can run the **create cluster** command of the installation program only once, during initial installation.

### Prerequisites

- Obtain the OpenShift Container Platform installation program and the pull secret for your cluster.

### Procedure

1. Change to the directory that contains the installation program and initialize the cluster deployment:

```
$ ./openshift-install create cluster --dir <installation_directory> \ 1
--log-level=info 2
```

- 1 For **<installation\_directory>**, specify the location of your customized `./install-config.yaml` file.
- 2 To view different installation details, specify **warn**, **debug**, or **error** instead of **info**.



## NOTE

If the cloud provider account that you configured on your host does not have sufficient permissions to deploy the cluster, the installation process stops, and the missing permissions are displayed.

When the cluster deployment completes, directions for accessing your cluster, including a link to its web console and credentials for the **kubeadmin** user, display in your terminal.

### Example output

```
...
INFO Install complete!
INFO To access the cluster as the system:admin user when using 'oc', run 'export
KUBECONFIG=/home/myuser/install_dir/auth/kubeconfig'
INFO Access the OpenShift web-console here: https://console-openshift-
console.apps.mycluster.example.com
INFO Login to the console with user: "kubeadmin", and password: "4vYBz-Ee6gm-ymBZj-
Wt5AL"
INFO Time elapsed: 36m22s
```



### NOTE

The cluster access and credential information also outputs to **<installation\_directory>/openshift\_install.log** when an installation succeeds.

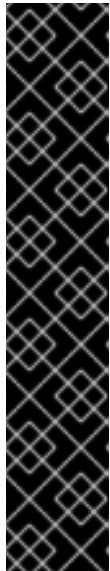

### IMPORTANT

- The Ignition config files that the installation program generates contain certificates that expire after 24 hours, which are then renewed at that time. If the cluster is shut down before renewing the certificates and the cluster is later restarted after the 24 hours have elapsed, the cluster automatically recovers the expired certificates. The exception is that you must manually approve the pending **node-bootstrapper** certificate signing requests (CSRs) to recover kubelet certificates. See the documentation for *Recovering from expired control plane certificates* for more information.
- It is recommended that you use Ignition config files within 12 hours after they are generated because the 24-hour certificate rotates from 16 to 22 hours after the cluster is installed. By using the Ignition config files within 12 hours, you can avoid installation failure if the certificate update runs during installation.

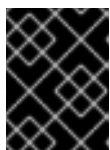

### IMPORTANT

You must not delete the installation program or the files that the installation program creates. Both are required to delete the cluster.

## 18.2.15. Verifying cluster status

You can verify your OpenShift Container Platform cluster's status during or after installation.

### Procedure

1. In the cluster environment, export the administrator's kubeconfig file:

```
$ export KUBECONFIG=<installation_directory>/auth/kubeconfig 1
```

- 1** For **<installation\_directory>**, specify the path to the directory that you stored the installation files in.

The **kubeconfig** file contains information about the cluster that is used by the CLI to connect a client to the correct cluster and API server.

2. View the control plane and compute machines created after a deployment:

```
$ oc get nodes
```

3. View your cluster's version:

```
$ oc get clusterversion
```

4. View your Operators' status:

```
$ oc get clusteroperator
```

5. View all running pods in the cluster:

```
$ oc get pods -A
```

## 18.2.16. Logging in to the cluster by using the CLI

You can log in to your cluster as a default system user by exporting the cluster **kubeconfig** file. The **kubeconfig** file contains information about the cluster that is used by the CLI to connect a client to the correct cluster and API server. The file is specific to a cluster and is created during OpenShift Container Platform installation.

### Prerequisites

- You deployed an OpenShift Container Platform cluster.
- You installed the **oc** CLI.

### Procedure

1. Export the **kubeadmin** credentials:

```
$ export KUBECONFIG=<installation_directory>/auth/kubeconfig 1
```

- 1** For **<installation\_directory>**, specify the path to the directory that you stored the installation files in.

2. Verify you can run **oc** commands successfully using the exported configuration:

```
$ oc whoami
```

### Example output

```
system:admin
```

### Additional resources



- See [Accessing the web console](#) for more details about accessing and understanding the OpenShift Container Platform web console.

### 18.2.17. Telemetry access for OpenShift Container Platform

In OpenShift Container Platform 4.10, the Telemetry service, which runs by default to provide metrics about cluster health and the success of updates, requires internet access. If your cluster is connected to the internet, Telemetry runs automatically, and your cluster is registered to [OpenShift Cluster Manager](#).

After you confirm that your [OpenShift Cluster Manager](#) inventory is correct, either maintained automatically by Telemetry or manually by using OpenShift Cluster Manager, [use subscription watch](#) to track your OpenShift Container Platform subscriptions at the account or multi-cluster level.

#### Additional resources

- See [About remote health monitoring](#) for more information about the Telemetry service

### 18.2.18. Next steps

- [Customize your cluster](#).
- If necessary, you can [opt out of remote health reporting](#).
- If you need to enable external access to node ports, [configure ingress cluster traffic by using a node port](#).
- If you did not configure RHOSP to accept application traffic over floating IP addresses, [configure RHOSP access with floating IP addresses](#).

## 18.3. INSTALLING A CLUSTER ON OPENSTACK WITH KURYR

In OpenShift Container Platform version 4.10, you can install a customized cluster on Red Hat OpenStack Platform (RHOSP) that uses Kuryr SDN. To customize the installation, modify parameters in the `install-config.yaml` before you install the cluster.

### 18.3.1. Prerequisites

- You reviewed details about the [OpenShift Container Platform installation and update](#) processes.
- You read the documentation on [selecting a cluster installation method and preparing it for users](#).
- You verified that OpenShift Container Platform 4.10 is compatible with your RHOSP version by using the [Supported platforms for OpenShift clusters](#) section. You can also compare platform support across different versions by viewing the [OpenShift Container Platform on RHOSP support matrix](#).
- You have a storage service installed in RHOSP, such as block storage (Cinder) or object storage (Swift). Object storage is the recommended storage technology for OpenShift Container Platform registry cluster deployment. For more information, see [Optimizing storage](#).
- You understand performance and scalability practices for cluster scaling, control plane sizing, and etcd. For more information, see [Recommended host practices](#).

### 18.3.2. About Kuryr SDN

**Kuryr** is a container network interface (CNI) plugin solution that uses the [Neutron](#) and [Octavia](#) Red Hat OpenStack Platform (RHOSP) services to provide networking for pods and Services.

Kuryr and OpenShift Container Platform integration is primarily designed for OpenShift Container Platform clusters running on RHOSP VMs. Kuryr improves the network performance by plugging OpenShift Container Platform pods into RHOSP SDN. In addition, it provides interconnectivity between pods and RHOSP virtual instances.

Kuryr components are installed as pods in OpenShift Container Platform using the **openshift-kuryr** namespace:

- **kuryr-controller** - a single service instance installed on a **master** node. This is modeled in OpenShift Container Platform as a **Deployment** object.
- **kuryr-cni** - a container installing and configuring Kuryr as a CNI driver on each OpenShift Container Platform node. This is modeled in OpenShift Container Platform as a **DaemonSet** object.

The Kuryr controller watches the OpenShift Container Platform API server for pod, service, and namespace create, update, and delete events. It maps the OpenShift Container Platform API calls to corresponding objects in Neutron and Octavia. This means that every network solution that implements the Neutron trunk port functionality can be used to back OpenShift Container Platform via Kuryr. This includes open source solutions such as Open vSwitch (OVS) and Open Virtual Network (OVN) as well as Neutron-compatible commercial SDNs.

Kuryr is recommended for OpenShift Container Platform deployments on encapsulated RHOSP tenant networks to avoid double encapsulation, such as running an encapsulated OpenShift Container Platform SDN over an RHOSP network.

If you use provider networks or tenant VLANs, you do not need to use Kuryr to avoid double encapsulation. The performance benefit is negligible. Depending on your configuration, though, using Kuryr to avoid having two overlays might still be beneficial.

Kuryr is not recommended in deployments where all of the following criteria are true:

- The RHOSP version is less than 16.
- The deployment uses UDP services, or a large number of TCP services on few hypervisors.

or

- The **ovn-octavia** Octavia driver is disabled.
- The deployment uses a large number of TCP services on few hypervisors.

### 18.3.3. Resource guidelines for installing OpenShift Container Platform on RHOSP with Kuryr

When using Kuryr SDN, the pods, services, namespaces, and network policies are using resources from the RHOSP quota; this increases the minimum requirements. Kuryr also has some additional requirements on top of what a default install requires.

Use the following quota to satisfy a default cluster's minimum requirements:

**Table 18.7. Recommended resources for a default OpenShift Container Platform cluster on RHOSP with Kuryr**

Resource	Value
Floating IP addresses	3 - plus the expected number of Services of LoadBalancer type
Ports	1500 - 1 needed per Pod
Routers	1
Subnets	250 - 1 needed per Namespace/Project
Networks	250 - 1 needed per Namespace/Project
RAM	112 GB
vCPUs	28
Volume storage	275 GB
Instances	7
Security groups	250 - 1 needed per Service and per NetworkPolicy
Security group rules	1000
Server groups	2 - plus 1 for each additional availability zone in each machine pool
Load balancers	100 - 1 needed per Service
Load balancer listeners	500 - 1 needed per Service-exposed port
Load balancer pools	500 - 1 needed per Service-exposed port

A cluster might function with fewer than recommended resources, but its performance is not guaranteed.



### IMPORTANT

If RHOSP object storage (Swift) is available and operated by a user account with the **swiftoperator** role, it is used as the default backend for the OpenShift Container Platform image registry. In this case, the volume storage requirement is 175 GB. Swift space requirements vary depending on the size of the image registry.

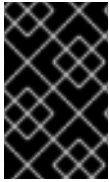

## IMPORTANT

If you are using Red Hat OpenStack Platform (RHOSP) version 16 with the Amphora driver rather than the OVN Octavia driver, security groups are associated with service accounts instead of user projects.

Take the following notes into consideration when setting resources:

- The number of ports that are required is larger than the number of pods. Kuryr uses ports pools to have pre-created ports ready to be used by pods and speed up the pods' booting time.
- Each network policy is mapped into an RHOSP security group, and depending on the **NetworkPolicy** spec, one or more rules are added to the security group.
- Each service is mapped to an RHOSP load balancer. Consider this requirement when estimating the number of security groups required for the quota.  
If you are using RHOSP version 15 or earlier, or the **ovn-octavia driver**, each load balancer has a security group with the user project.
- The quota does not account for load balancer resources (such as VM resources), but you must consider these resources when you decide the RHOSP deployment's size. The default installation will have more than 50 load balancers; the clusters must be able to accommodate them.  
If you are using RHOSP version 16 with the OVN Octavia driver enabled, only one load balancer VM is generated; services are load balanced through OVN flows.

An OpenShift Container Platform deployment comprises control plane machines, compute machines, and a bootstrap machine.

To enable Kuryr SDN, your environment must meet the following requirements:

- Run RHOSP 13+.
- Have Overcloud with Octavia.
- Use Neutron Trunk ports extension.
- Use **openvswitch** firewall driver if ML2/OVS Neutron driver is used instead of **ovs-hybrid**.

### 18.3.3.1. Increasing quota

When using Kuryr SDN, you must increase quotas to satisfy the Red Hat OpenStack Platform (RHOSP) resources used by pods, services, namespaces, and network policies.

#### Procedure

- Increase the quotas for a project by running the following command:

```
$ sudo openstack quota set --secgroups 250 --secgroup-rules 1000 --ports 1500 --subnets 250 --networks 250 <project>
```

### 18.3.3.2. Configuring Neutron

Kuryr CNI leverages the Neutron Trunks extension to plug containers into the Red Hat OpenStack Platform (RHOSP) SDN, so you must use the **trunks** extension for Kuryr to properly work.

In addition, if you leverage the default ML2/OVS Neutron driver, the firewall must be set to **openvswitch** instead of **ovs\_hybrid** so that security groups are enforced on trunk subports and Kuryr can properly handle network policies.

### 18.3.3.3. Configuring Octavia

Kuryr SDN uses Red Hat OpenStack Platform (RHOSP)'s Octavia LBaaS to implement OpenShift Container Platform services. Thus, you must install and configure Octavia components in RHOSP to use Kuryr SDN.

To enable Octavia, you must include the Octavia service during the installation of the RHOSP Overcloud, or upgrade the Octavia service if the Overcloud already exists. The following steps for enabling Octavia apply to both a clean install of the Overcloud or an Overcloud update.



#### NOTE

The following steps only capture the key pieces required during the [deployment of RHOSP](#) when dealing with Octavia. It is also important to note that [registry methods](#) vary.

This example uses the local registry method.

#### Procedure

1. If you are using the local registry, create a template to upload the images to the registry. For example:

```
(undercloud) $ openstack overcloud container image prepare \
-e /usr/share/openstack-tripleo-heat-templates/environments/services-docker/octavia.yaml \
--namespace=registry.access.redhat.com/rhosp13 \
--push-destination=<local-ip-from-undercloud.conf>:8787 \
--prefix=openstack- \
--tag-from-label {version}-{product-version} \
--output-env-file=/home/stack/templates/overcloud_images.yaml \
--output-images-file /home/stack/local_registry_images.yaml
```

2. Verify that the **local\_registry\_images.yaml** file contains the Octavia images. For example:

```
...
- imagename: registry.access.redhat.com/rhosp13/openstack-octavia-api:13.0-43
  push_destination: <local-ip-from-undercloud.conf>:8787
- imagename: registry.access.redhat.com/rhosp13/openstack-octavia-health-manager:13.0-45
  push_destination: <local-ip-from-undercloud.conf>:8787
- imagename: registry.access.redhat.com/rhosp13/openstack-octavia-housekeeping:13.0-45
  push_destination: <local-ip-from-undercloud.conf>:8787
- imagename: registry.access.redhat.com/rhosp13/openstack-octavia-worker:13.0-44
  push_destination: <local-ip-from-undercloud.conf>:8787
```



#### NOTE

The Octavia container versions vary depending upon the specific RHOSP release installed.

3. Pull the container images from **registry.redhat.io** to the Undercloud node:

```
(undercloud) $ sudo openstack overcloud container image upload \
  --config-file /home/stack/local_registry_images.yaml \
  --verbose
```

This may take some time depending on the speed of your network and Undercloud disk.

4. Since an Octavia load balancer is used to access the OpenShift Container Platform API, you must increase their listeners' default timeouts for the connections. The default timeout is 50 seconds. Increase the timeout to 20 minutes by passing the following file to the Overcloud deploy command:

```
(undercloud) $ cat octavia_timeouts.yaml
parameter_defaults:
  OctaviaTimeoutClientData: 1200000
  OctaviaTimeoutMemberData: 1200000
```



#### NOTE

This is not needed for RHOSP 13.0.13+.

5. Install or update your Overcloud environment with Octavia:

```
$ openstack overcloud deploy --templates \
  -e /usr/share/openstack-tripleo-heat-templates/environments/services-docker/octavia.yaml \
  -e octavia_timeouts.yaml
```

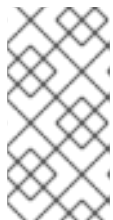

#### NOTE

This command only includes the files associated with Octavia; it varies based on your specific installation of RHOSP. See the RHOSP documentation for further information. For more information on customizing your Octavia installation, see [installation of Octavia using Director](#).

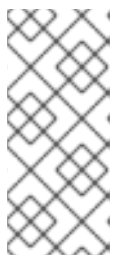

#### NOTE

When leveraging Kuryr SDN, the Overcloud installation requires the Neutron **trunk** extension. This is available by default on director deployments. Use the **openvswitch** firewall instead of the default **ovs-hybrid** when the Neutron backend is ML2/OVS. There is no need for modifications if the backend is ML2/OVN.

6. In RHOSP versions earlier than 13.0.13, add the project ID to the **octavia.conf** configuration file after you create the project.
  - To enforce network policies across services, like when traffic goes through the Octavia load balancer, you must ensure Octavia creates the Amphora VM security groups on the user project. This change ensures that required load balancer security groups belong to that project, and that they can be updated to enforce services isolation.

**NOTE**

This task is unnecessary in RHOSP version 13.0.13 or later.

Octavia implements a new ACL API that restricts access to the load balancers VIP.

- a. Get the project ID

```
$ openstack project show <project>
```

**Example output**

```
+-----+-----+
| Field | Value |
+-----+-----+
| description |
| domain_id | default |
| enabled | True |
| id | PROJECT_ID |
| is_domain | False |
| name | *<project>* |
| parent_id | default |
| tags | [] |
+-----+-----+
```

- b. Add the project ID to **octavia.conf** for the controllers.
  - i. Source the **stackrc** file:

```
$ source stackrc # Undercloud credentials
```

- ii. List the Overcloud controllers:

```
$ openstack server list
```

**Example output**

```
+-----+-----+-----+-----+-----+
| ID | Name | Status | Networks |
| Image | Flavor |
+-----+-----+-----+-----+-----+
| 6bef8e73-2ba5-4860-a0b1-3937f8ca7e01 | controller-0 | ACTIVE |
ctlplane=192.168.24.8 | overcloud-full | controller |
| dda3173a-ab26-47f8-a2dc-8473b4a67ab9 | compute-0 | ACTIVE |
ctlplane=192.168.24.6 | overcloud-full | compute |
```

```
|
+-----+-----+-----+-----+
-----+
```

- iii. SSH into the controller(s).

```
$ ssh heat-admin@192.168.24.8
```

- iv. Edit the **octavia.conf** file to add the project into the list of projects where Amphora security groups are on the user's account.

```
# List of project IDs that are allowed to have Load balancer security groups
# belonging to them.
amp_secgroup_allowed_projects = PROJECT_ID
```

- c. Restart the Octavia worker so the new configuration loads.

```
controller-0$ sudo docker restart octavia_worker
```



#### NOTE

Depending on your RHOSP environment, Octavia might not support UDP listeners. If you use Kuryr SDN on RHOSP version 13.0.13 or earlier, UDP services are not supported. RHOSP version 16 or later support UDP.

#### 18.3.3.3.1. The Octavia OVN Driver

Octavia supports multiple provider drivers through the Octavia API.

To see all available Octavia provider drivers, on a command line, enter:

```
$ openstack loadbalancer provider list
```

#### Example output

```
+-----+-----+-----+-----+
| name | description |
+-----+-----+-----+-----+
| amphora | The Octavia Amphora driver. |
| octavia | Deprecated alias of the Octavia Amphora driver. |
| ovn | Octavia OVN driver. |
+-----+-----+-----+-----+
```

Beginning with RHOSP version 16, the Octavia OVN provider driver (**ovn**) is supported on OpenShift Container Platform on RHOSP deployments.

**ovn** is an integration driver for the load balancing that Octavia and OVN provide. It supports basic load balancing capabilities, and is based on OpenFlow rules. The driver is automatically enabled in Octavia by Director on deployments that use OVN Neutron ML2.

The Amphora provider driver is the default driver. If **ovn** is enabled, however, Kuryr uses it.

If Kuryr uses **ovn** instead of Amphora, it offers the following benefits:



- Decreased resource requirements. Kuryr does not require a load balancer VM for each service.
- Reduced network latency.
- Increased service creation speed by using OpenFlow rules instead of a VM for each service.
- Distributed load balancing actions across all nodes instead of centralized on Amphora VMs.

You can [configure your cluster to use the Octavia OVN driver](#) after your RHOSP cloud is upgraded from version 13 to version 16.

#### 18.3.3.4. Known limitations of installing with Kuryr

Using OpenShift Container Platform with Kuryr SDN has several known limitations.

##### RHOSP general limitations

Using OpenShift Container Platform with Kuryr SDN has several limitations that apply to all versions and environments:

- **Service** objects with the **NodePort** type are not supported.
- Clusters that use the OVN Octavia provider driver support **Service** objects for which the **.spec.selector** property is unspecified only if the **.subsets.addresses** property of the **Endpoints** object includes the subnet of the nodes or pods.
- If the subnet on which machines are created is not connected to a router, or if the subnet is connected, but the router has no external gateway set, Kuryr cannot create floating IPs for **Service** objects with type **LoadBalancer**.
- Configuring the **sessionAffinity=ClientIP** property on **Service** objects does not have an effect. Kuryr does not support this setting.

##### RHOSP version limitations

Using OpenShift Container Platform with Kuryr SDN has several limitations that depend on the RHOSP version.

- RHOSP versions before 16 use the default Octavia load balancer driver (Amphora). This driver requires that one Amphora load balancer VM is deployed per OpenShift Container Platform service. Creating too many services can cause you to run out of resources. Deployments of later versions of RHOSP that have the OVN Octavia driver disabled also use the Amphora driver. They are subject to the same resource concerns as earlier versions of RHOSP.
- Octavia RHOSP versions before 13.0.13 do not support UDP listeners. Therefore, OpenShift Container Platform UDP services are not supported.
- Octavia RHOSP versions before 13.0.13 cannot listen to multiple protocols on the same port. Services that expose the same port to different protocols, like TCP and UDP, are not supported.
- Kuryr SDN does not support automatic unidling by a service.

##### RHOSP environment limitations

There are limitations when using Kuryr SDN that depend on your deployment environment.

Because of Octavia's lack of support for the UDP protocol and multiple listeners, if the RHOSP version is earlier than 13.0.13, Kuryr forces pods to use TCP for DNS resolution.

In Go versions 1.12 and earlier, applications that are compiled with CGO support disabled use UDP only. In this case, the native Go resolver does not recognize the **use-vc** option in **resolv.conf**, which controls whether TCP is forced for DNS resolution. As a result, UDP is still used for DNS resolution, which fails.

To ensure that TCP forcing is allowed, compile applications either with the environment variable **CGO\_ENABLED** set to **1**, i.e. **CGO\_ENABLED=1**, or ensure that the variable is absent.

In Go versions 1.13 and later, TCP is used automatically if DNS resolution using UDP fails.



#### NOTE

musl-based containers, including Alpine-based containers, do not support the **use-vc** option.

#### RHOSP upgrade limitations

As a result of the RHOSP upgrade process, the Octavia API might be changed, and upgrades to the Amphora images that are used for load balancers might be required.

You can address API changes on an individual basis.

If the Amphora image is upgraded, the RHOSP operator can handle existing load balancer VMs in two ways:

- Upgrade each VM by triggering a [load balancer failover](#).
- Leave responsibility for upgrading the VMs to users.

If the operator takes the first option, there might be short downtimes during failovers.

If the operator takes the second option, the existing load balancers will not support upgraded Octavia API features, like UDP listeners. In this case, users must recreate their Services to use these features.



#### IMPORTANT

If OpenShift Container Platform detects a new Octavia version that supports UDP load balancing, it recreates the DNS service automatically. The service recreation ensures that the service default supports UDP load balancing.

The recreation causes the DNS service approximately one minute of downtime.

#### 18.3.3.5. Control plane machines

By default, the OpenShift Container Platform installation process creates three control plane machines.

Each machine requires:

- An instance from the RHOSP quota
- A port from the RHOSP quota
- A flavor with at least 16 GB memory and 4 vCPUs
- At least 100 GB storage space from the RHOSP quota

#### 18.3.3.6. Compute machines

By default, the OpenShift Container Platform installation process creates three compute machines.

Each machine requires:

- An instance from the RHOSP quota
- A port from the RHOSP quota
- A flavor with at least 8 GB memory and 2 vCPUs
- At least 100 GB storage space from the RHOSP quota

## TIP

Compute machines host the applications that you run on OpenShift Container Platform; aim to run as many as you can.

### 18.3.3.7. Bootstrap machine

During installation, a bootstrap machine is temporarily provisioned to stand up the control plane. After the production control plane is ready, the bootstrap machine is deprovisioned.

The bootstrap machine requires:

- An instance from the RHOSP quota
- A port from the RHOSP quota
- A flavor with at least 16 GB memory and 4 vCPUs
- At least 100 GB storage space from the RHOSP quota

### 18.3.4. Internet access for OpenShift Container Platform

In OpenShift Container Platform 4.10, you require access to the internet to install your cluster.

You must have internet access to:

- Access [OpenShift Cluster Manager](#) to download the installation program and perform subscription management. If the cluster has internet access and you do not disable Telemetry, that service automatically entitles your cluster.
- Access [Quay.io](#) to obtain the packages that are required to install your cluster.
- Obtain the packages that are required to perform cluster updates.

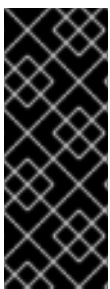

## IMPORTANT

If your cluster cannot have direct internet access, you can perform a restricted network installation on some types of infrastructure that you provision. During that process, you download the required content and use it to populate a mirror registry with the installation packages. With some installation types, the environment that you install your cluster in will not require internet access. Before you update the cluster, you update the content of the mirror registry.

### 18.3.5. Enabling Swift on RHOSP

Swift is operated by a user account with the **swiftoperator** role. Add the role to an account before you run the installation program.



#### IMPORTANT

If [the Red Hat OpenStack Platform \(RHOSP\) object storage service](#), commonly known as Swift, is available, OpenShift Container Platform uses it as the image registry storage. If it is unavailable, the installation program relies on the RHOSP block storage service, commonly known as Cinder.

If Swift is present and you want to use it, you must enable access to it. If it is not present, or if you do not want to use it, skip this section.

#### Prerequisites

- You have a RHOSP administrator account on the target environment.
- The Swift service is installed.
- On [Ceph RGW](#), the **account in url** option is enabled.

#### Procedure

To enable Swift on RHOSP:

1. As an administrator in the RHOSP CLI, add the **swiftoperator** role to the account that will access Swift:

```
$ openstack role add --user <user> --project <project> swiftoperator
```

Your RHOSP deployment can now use Swift for the image registry.

### 18.3.6. Verifying external network access

The OpenShift Container Platform installation process requires external network access. You must provide an external network value to it, or deployment fails. Before you begin the process, verify that a network with the external router type exists in Red Hat OpenStack Platform (RHOSP).

#### Prerequisites

- [Configure OpenStack's networking service to have DHCP agents forward instances' DNS queries](#)

#### Procedure

1. Using the RHOSP CLI, verify the name and ID of the 'External' network:

```
$ openstack network list --long -c ID -c Name -c "Router Type"
```

#### Example output

```
+-----+-----+-----+
```

ID	Name	Router Type
148a8023-62a7-4672-b018-003462f8d7dc	public_network	External

A network with an external router type appears in the network list. If at least one does not, see [Creating a default floating IP network](#) and [Creating a default provider network](#).

## IMPORTANT

If the external network's CIDR range overlaps one of the default network ranges, you must change the matching network ranges in the **install-config.yaml** file before you start the installation process.

The default network ranges are:

Network	Range
<b>machineNetwork</b>	10.0.0.0/16
<b>serviceNetwork</b>	172.30.0.0/16
<b>clusterNetwork</b>	10.128.0.0/14



## WARNING

If the installation program finds multiple networks with the same name, it sets one of them at random. To avoid this behavior, create unique names for resources in RHOSP.



## NOTE

If the Neutron trunk service plugin is enabled, a trunk port is created by default. For more information, see [Neutron trunk port](#).

### 18.3.7. Defining parameters for the installation program

The OpenShift Container Platform installation program relies on a file that is called **clouds.yaml**. The file describes Red Hat OpenStack Platform (RHOSP) configuration parameters, including the project name, log in information, and authorization service URLs.

#### Procedure

1. Create the **clouds.yaml** file:
  - If your RHOSP distribution includes the Horizon web UI, generate a **clouds.yaml** file in it.



## IMPORTANT

Remember to add a password to the **auth** field. You can also keep secrets in a [separate file](#) from **clouds.yaml**.

- If your RHOSP distribution does not include the Horizon web UI, or you do not want to use Horizon, create the file yourself. For detailed information about **clouds.yaml**, see [Config files](#) in the RHOSP documentation.

```
clouds:
  shiftstack:
    auth:
      auth_url: http://10.10.14.42:5000/v3
      project_name: shiftstack
      username: <username>
      password: <password>
      user_domain_name: Default
      project_domain_name: Default
  dev-env:
    region_name: RegionOne
    auth:
      username: <username>
      password: <password>
      project_name: 'devonly'
      auth_url: 'https://10.10.14.22:5001/v2.0'
```

2. If your RHOSP installation uses self-signed certificate authority (CA) certificates for endpoint authentication:
  - a. Copy the certificate authority file to your machine.
  - b. Add the **cacerts** key to the **clouds.yaml** file. The value must be an absolute, non-root-accessible path to the CA certificate:

```
clouds:
  shiftstack:
    ...
    cacert: "/etc/pki/ca-trust/source/anchors/ca.crt.pem"
```

## TIP

After you run the installer with a custom CA certificate, you can update the certificate by editing the value of the **ca-cert.pem** key in the **cloud-provider-config** keymap. On a command line, run:

```
$ oc edit configmap -n openshift-config cloud-provider-config
```

3. Place the **clouds.yaml** file in one of the following locations:
  - a. The value of the **OS\_CLIENT\_CONFIG\_FILE** environment variable
  - b. The current directory
  - c. A Unix-specific user configuration directory, for example **~/.config/openstack/clouds.yaml**

- d. A Unix-specific site configuration directory, for example `/etc/openstack/clouds.yaml`  
The installation program searches for `clouds.yaml` in that order.

### 18.3.8. Setting cloud provider options

Optionally, you can edit the cloud provider configuration for your cluster. The cloud provider configuration controls how OpenShift Container Platform interacts with Red Hat OpenStack Platform (RHOSP).

For a complete list of cloud provider configuration parameters, see the "OpenStack cloud configuration reference guide" page in the "Installing on OpenStack" documentation.

#### Procedure

1. If you have not already generated manifest files for your cluster, generate them by running the following command:

```
$ openshift-install --dir <destination_directory> create manifests
```

2. In a text editor, open the cloud-provider configuration manifest file. For example:

```
$ vi openshift/manifests/cloud-provider-config.yaml
```

3. Modify the options based on the cloud configuration specification.

Configuring Octavia for load balancing is a common case for clusters that do not use Kuryr. For example:

```
#...
[LoadBalancer]
use-octavia=true 1
lb-provider = "amphora" 2
floating-network-id="d3deb660-4190-40a3-91f1-37326fe6ec4a" 3
create-monitor = True 4
monitor-delay = 10s 5
monitor-timeout = 10s 6
monitor-max-retries = 1 7
#...
```

- 1 This property enables Octavia integration.
- 2 This property sets the Octavia provider that your load balancer uses. It accepts "ovn" or "amphora" as values. If you choose to use OVN, you must also set `lb-method` to `SOURCE_IP_PORT`.
- 3 This property is required if you want to use multiple external networks with your cluster. The cloud provider creates floating IP addresses on the network that is specified here.
- 4 This property controls whether the cloud provider creates health monitors for Octavia load balancers. Set the value to `True` to create health monitors. As of RHOSP 16.1 and 16.2, this feature is only available for the Amphora provider.
- 5 This property sets the frequency with which endpoints are monitored. The value must be in the `time.ParseDuration()` format. This property is required if the value of the `create-monitor` property is `True`.

- 6 This property sets the time that monitoring requests are open before timing out. The value must be in the **time.ParseDuration()** format. This property is required if the value of the
- 7 This property defines how many successful monitoring requests are required before a load balancer is marked as online. The value must be an integer. This property is required if the value of the **create-monitor** property is **True**.

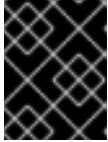

### IMPORTANT

Prior to saving your changes, verify that the file is structured correctly. Clusters might fail if properties are not placed in the appropriate section.



### IMPORTANT

You must set the value of the **create-monitor** property to **True** if you use services that have the value of the **.spec.externalTrafficPolicy** property set to **Local**. The OVN Octavia provider in RHOSP 16.1 and 16.2 does not support health monitors. Therefore, services that have **ETP** parameter values set to **Local** might not respond when the **lb-provider** value is set to **"ovn"**.

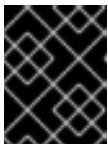

### IMPORTANT

For installations that use Kuryr, Kuryr handles relevant services. There is no need to configure Octavia load balancing in the cloud provider.

4. Save the changes to the file and proceed with installation.

### TIP

You can update your cloud provider configuration after you run the installer. On a command line, run:

```
$ oc edit configmap -n openshift-config cloud-provider-config
```

After you save your changes, your cluster will take some time to reconfigure itself. The process is complete if none of your nodes have a **SchedulingDisabled** status.

#### 18.3.8.1. External load balancers that use pre-defined floating IP addresses

Commonly, Red Hat OpenStack Platform (RHOSP) deployments disallow non-administrator users from creating specific floating IP addresses. If such a policy is in place and you use a floating IP address in your service specification, the cloud provider will fail to handle IP address assignment to load balancers.

If you use an external cloud provider, you can avoid this problem by pre-creating a floating IP address and specifying it in your service specification. The in-tree cloud provider does not support this method.

Alternatively, you can [modify the RHOSP Networking service \(Neutron\) to allow non-administrator users to create specific floating IP addresses](#).

#### Additional resources

- For more information about cloud provider configuration, see [OpenStack cloud provider options](#).



### 18.3.9. Obtaining the installation program

Before you install OpenShift Container Platform, download the installation file on a local computer.

#### Prerequisites

- You have a computer that runs Linux or macOS, with 500 MB of local disk space

#### Procedure

1. Access the [Infrastructure Provider](#) page on the OpenShift Cluster Manager site. If you have a Red Hat account, log in with your credentials. If you do not, create an account.
2. Select your infrastructure provider.
3. Navigate to the page for your installation type, download the installation program that corresponds with your host operating system and architecture, and place the file in the directory where you will store the installation configuration files.

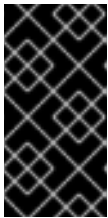

#### IMPORTANT

The installation program creates several files on the computer that you use to install your cluster. You must keep the installation program and the files that the installation program creates after you finish installing the cluster. Both files are required to delete the cluster.

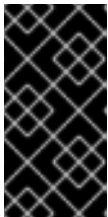

#### IMPORTANT

Deleting the files created by the installation program does not remove your cluster, even if the cluster failed during installation. To remove your cluster, complete the OpenShift Container Platform uninstallation procedures for your specific cloud provider.

4. Extract the installation program. For example, on a computer that uses a Linux operating system, run the following command:

```
$ tar -xvf openshift-install-linux.tar.gz
```

5. Download your installation [pull secret from the Red Hat OpenShift Cluster Manager](#) . This pull secret allows you to authenticate with the services that are provided by the included authorities, including Quay.io, which serves the container images for OpenShift Container Platform components.

### 18.3.10. Creating the installation configuration file

You can customize the OpenShift Container Platform cluster you install on Red Hat OpenStack Platform (RHOSP).

#### Prerequisites

- Obtain the OpenShift Container Platform installation program and the pull secret for your cluster.
- Obtain service principal permissions at the subscription level.

## Procedure

1. Create the **install-config.yaml** file.
  - a. Change to the directory that contains the installation program and run the following command:

```
$ ./openshift-install create install-config --dir <installation_directory> 1
```

- 1** For **<installation\_directory>**, specify the directory name to store the files that the installation program creates.



### IMPORTANT

Specify an empty directory. Some installation assets, like bootstrap X.509 certificates have short expiration intervals, so you must not reuse an installation directory. If you want to reuse individual files from another cluster installation, you can copy them into your directory. However, the file names for the installation assets might change between releases. Use caution when copying installation files from an earlier OpenShift Container Platform version.

- b. At the prompts, provide the configuration details for your cloud:
    - i. Optional: Select an SSH key to use to access your cluster machines.



### NOTE

For production OpenShift Container Platform clusters on which you want to perform installation debugging or disaster recovery, specify an SSH key that your **ssh-agent** process uses.

- ii. Select **openstack** as the platform to target.
        - iii. Specify the Red Hat OpenStack Platform (RHOSP) external network name to use for installing the cluster.
        - iv. Specify the floating IP address to use for external access to the OpenShift API.
        - v. Specify a RHOSP flavor with at least 16 GB RAM to use for control plane nodes and 8 GB RAM for compute nodes.
        - vi. Select the base domain to deploy the cluster to. All DNS records will be sub-domains of this base and will also include the cluster name.
        - vii. Enter a name for your cluster. The name must be 14 or fewer characters long.
        - viii. Paste the [pull secret from the Red Hat OpenShift Cluster Manager](#) .
2. Modify the **install-config.yaml** file. You can find more information about the available parameters in the "Installation configuration parameters" section.
  3. Back up the **install-config.yaml** file so that you can use it to install multiple clusters.

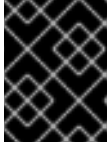
**IMPORTANT**

The **install-config.yaml** file is consumed during the installation process. If you want to reuse the file, you must back it up now.

**18.3.10.1. Configuring the cluster-wide proxy during installation**

Production environments can deny direct access to the internet and instead have an HTTP or HTTPS proxy available. You can configure a new OpenShift Container Platform cluster to use a proxy by configuring the proxy settings in the **install-config.yaml** file.

**NOTE**

Kuryr installations default to HTTP proxies.

**Prerequisites**

- For Kuryr installations on restricted networks that use the **Proxy** object, the proxy must be able to reply to the router that the cluster uses. To add a static route for the proxy configuration, from a command line as the root user, enter:

```
$ ip route add <cluster_network_cidr> via <installer_subnet_gateway>
```

- The restricted subnet must have a gateway that is defined and available to be linked to the **Router** resource that Kuryr creates.
- You have an existing **install-config.yaml** file.
- You reviewed the sites that your cluster requires access to and determined whether any of them need to bypass the proxy. By default, all cluster egress traffic is proxied, including calls to hosting cloud provider APIs. You added sites to the **Proxy** object's **spec.noProxy** field to bypass the proxy if necessary.

**NOTE**

The **Proxy** object **status.noProxy** field is populated with the values of the **networking.machineNetwork[].cidr**, **networking.clusterNetwork[].cidr**, and **networking.serviceNetwork[]** fields from your installation configuration.

For installations on Amazon Web Services (AWS), Google Cloud Platform (GCP), Microsoft Azure, and Red Hat OpenStack Platform (RHOSP), the **Proxy** object **status.noProxy** field is also populated with the instance metadata endpoint (**169.254.169.254**).

**Procedure**

1. Edit your **install-config.yaml** file and add the proxy settings. For example:

```
apiVersion: v1
baseDomain: my.domain.com
proxy:
  httpProxy: http://<username>:<pswd>@<ip>:<port> 1
  httpsProxy: https://<username>:<pswd>@<ip>:<port> 2
  noProxy: example.com 3
```

```

additionalTrustBundle: | 4
-----BEGIN CERTIFICATE-----
<MY_TRUSTED_CA_CERT>
-----END CERTIFICATE-----
...

```

- 1 A proxy URL to use for creating HTTP connections outside the cluster. The URL scheme must be **http**.
- 2 A proxy URL to use for creating HTTPS connections outside the cluster.
- 3 A comma-separated list of destination domain names, IP addresses, or other network CIDRs to exclude from proxying. Preface a domain with **.** to match subdomains only. For example, **.y.com** matches **x.y.com**, but not **y.com**. Use **\*** to bypass the proxy for all destinations.
- 4 If provided, the installation program generates a config map that is named **user-ca-bundle** in the **openshift-config** namespace that contains one or more additional CA certificates that are required for proxying HTTPS connections. The Cluster Network Operator then creates a **trusted-ca-bundle** config map that merges these contents with the Red Hat Enterprise Linux CoreOS (RHCOS) trust bundle, and this config map is referenced in the **trustedCA** field of the **Proxy** object. The **additionalTrustBundle** field is required unless the proxy's identity certificate is signed by an authority from the RHCOS trust bundle.



#### NOTE

The installation program does not support the proxy **readinessEndpoints** field.



#### NOTE

If the installer times out, restart and then complete the deployment by using the **wait-for** command of the installer. For example:

```
$ ./openshift-install wait-for install-complete --log-level debug
```

2. Save the file and reference it when installing OpenShift Container Platform.

The installation program creates a cluster-wide proxy that is named **cluster** that uses the proxy settings in the provided **install-config.yaml** file. If no proxy settings are provided, a **cluster Proxy** object is still created, but it will have a nil **spec**.



#### NOTE

Only the **Proxy** object named **cluster** is supported, and no additional proxies can be created.

### 18.3.11. Installation configuration parameters

Before you deploy an OpenShift Container Platform cluster, you provide parameter values to describe your account on the cloud platform that hosts your cluster and optionally customize your cluster's platform. When you create the **install-config.yaml** installation configuration file, you provide values for the required parameters through the command line. If you customize your cluster, you can modify the **install-config.yaml** file to provide more details about the platform.

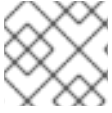
**NOTE**

After installation, you cannot modify these parameters in the **install-config.yaml** file.

**18.3.11.1. Required configuration parameters**

Required installation configuration parameters are described in the following table:

**Table 18.8. Required parameters**

Parameter	Description	Values
<b>apiVersion</b>	The API version for the <b>install-config.yaml</b> content. The current version is <b>v1</b> . The installer may also support older API versions.	String
<b>baseDomain</b>	The base domain of your cloud provider. The base domain is used to create routes to your OpenShift Container Platform cluster components. The full DNS name for your cluster is a combination of the <b>baseDomain</b> and <b>metadata.name</b> parameter values that uses the <b>&lt;metadata.name&gt;. &lt;baseDomain&gt;</b> format.	A fully-qualified domain or subdomain name, such as <b>example.com</b> .
<b>metadata</b>	Kubernetes resource <b>ObjectMeta</b> , from which only the <b>name</b> parameter is consumed.	Object
<b>metadata.name</b>	The name of the cluster. DNS records for the cluster are all subdomains of <b>{{.metadata.name}}. {{.baseDomain}}</b> .	String of lowercase letters, hyphens (-), and periods (.), such as <b>dev</b> . The string must be 14 characters or fewer long.

Parameter	Description	Values
<b>platform</b>	The configuration for the specific platform upon which to perform the installation: <b>alibabacloud</b> , <b>aws</b> , <b>baremetal</b> , <b>azure</b> , <b>gcp</b> , <b>ibmcloud</b> , <b>openstack</b> , <b>ovirt</b> , <b>vsphere</b> , or <b>{}</b> . For additional information about <b>platform.&lt;platform&gt;</b> parameters, consult the table for your specific platform that follows.	Object
<b>pullSecret</b>	Get a <a href="#">pull secret from the Red Hat OpenShift Cluster Manager</a> to authenticate downloading container images for OpenShift Container Platform components from services such as Quay.io.	<pre>{   "auths":{     "cloud.openshift.com":{       "auth":"b3Blb=",       "email":"you@example.com"     },     "quay.io":{       "auth":"b3Blb=",       "email":"you@example.com"     }   } }</pre>

### 18.3.11.2. Network configuration parameters

You can customize your installation configuration based on the requirements of your existing network infrastructure. For example, you can expand the IP address block for the cluster network or provide different IP address blocks than the defaults.

Only IPv4 addresses are supported.

Table 18.9. Network parameters

Parameter	Description	Values
<b>networking</b>	The configuration for the cluster network.	<p>Object</p>  <p><b>NOTE</b></p> <p>You cannot modify parameters specified by the <b>networking</b> object after installation.</p>

Parameter	Description	Values
<b>networking.networkType</b>	The cluster network provider Container Network Interface (CNI) plugin to install.	Either <b>OpenShiftSDN</b> or <b>OVNKubernetes</b> . <b>OpenShiftSDN</b> is a CNI provider for all-Linux networks. <b>OVNKubernetes</b> is a CNI provider for Linux networks and hybrid networks that contain both Linux and Windows servers. The default value is <b>OpenShiftSDN</b> .
<b>networking.clusterNetwork</b>	The IP address blocks for pods.  The default value is <b>10.128.0.0/14</b> with a host prefix of <b>/23</b> .  If you specify multiple IP address blocks, the blocks must not overlap.	An array of objects. For example:  <pre>networking:   clusterNetwork:     - cidr: 10.128.0.0/14       hostPrefix: 23</pre>
<b>networking.clusterNetwork.cidr</b>	Required if you use <b>networking.clusterNetwork</b> . An IP address block.  An IPv4 network.	An IP address block in Classless Inter-Domain Routing (CIDR) notation. The prefix length for an IPv4 block is between <b>0</b> and <b>32</b> .
<b>networking.clusterNetwork.hostPrefix</b>	The subnet prefix length to assign to each individual node. For example, if <b>hostPrefix</b> is set to <b>23</b> then each node is assigned a <b>/23</b> subnet out of the given <b>cidr</b> . A <b>hostPrefix</b> value of <b>23</b> provides 510 ( $2^{(32 - 23)} - 2$ ) pod IP addresses.	A subnet prefix.  The default value is <b>23</b> .
<b>networking.serviceNetwork</b>	The IP address block for services. The default value is <b>172.30.0.0/16</b> .  The OpenShift SDN and OVN-Kubernetes network providers support only a single IP address block for the service network.	An array with an IP address block in CIDR format. For example:  <pre>networking:   serviceNetwork:     - 172.30.0.0/16</pre>
<b>networking.machineNetwork</b>	The IP address blocks for machines.  If you specify multiple IP address blocks, the blocks must not overlap.	An array of objects. For example:  <pre>networking:   machineNetwork:     - cidr: 10.0.0.0/16</pre>

Parameter	Description	Values
<b>networking.machineNetwork.cidr</b>	Required if you use <b>networking.machineNetwork</b> . An IP address block. The default value is <b>10.0.0.0/16</b> for all platforms other than libvirt. For libvirt, the default value is <b>192.168.126.0/24</b> .	An IP network block in CIDR notation. For example, <b>10.0.0.0/16</b> .  <b>NOTE</b> Set the <b>networking.machineNetwork</b> to match the CIDR that the preferred NIC resides in.

### 18.3.11.3. Optional configuration parameters

Optional installation configuration parameters are described in the following table:



Table 18.10. Optional parameters

Parameter	Description	Values
<b>additionalTrustBundle</b>	A PEM-encoded X.509 certificate bundle that is added to the nodes' trusted certificate store. This trust bundle may also be used when a proxy has been configured.	String
<b>cgroupsV2</b>	Enables <a href="#">Linux control groups version 2</a> (cgroups v2) on specific nodes in your cluster. The OpenShift Container Platform process for enabling cgroups v2 disables all cgroup version 1 controllers and hierarchies. The OpenShift Container Platform cgroups version 2 feature is in Developer Preview and is not supported by Red Hat at this time.	<b>true</b>
<b>compute</b>	The configuration for the machines that comprise the compute nodes.	Array of <b>MachinePool</b> objects.





Parameter	Description	Values
<b>compute.architecture</b>	Determines the instruction set architecture of the machines in the pool. Currently, clusters with varied architectures are not supported. All pools must specify the same architecture. Valid values are <b>amd64</b> (the default).	String
<b>compute.hypertreading</b>	Whether to enable or disable simultaneous multithreading, or <b>hypertreading</b> , on compute machines. By default, simultaneous multithreading is enabled to increase the performance of your machines' cores.   <b>IMPORTANT</b> If you disable simultaneous multithreading, ensure that your capacity planning accounts for the dramatically decreased machine performance.	<b>Enabled</b> or <b>Disabled</b>
<b>compute.name</b>	Required if you use <b>compute</b> . The name of the machine pool.	<b>worker</b>
<b>compute.platform</b>	Required if you use <b>compute</b> . Use this parameter to specify the cloud provider to host the worker machines. This parameter value must match the <b>controlPlane.platform</b> parameter value.	<b>alibabacloud, aws, azure, gcp, ibmcloud, openstack, ovirt, vsphere</b> , or <b>{}</b>
<b>compute.replicas</b>	The number of compute machines, which are also known as worker machines, to provision.	A positive integer greater than or equal to <b>2</b> . The default value is <b>3</b> .
<b>controlPlane</b>	The configuration for the machines that comprise the control plane.	Array of <b>MachinePool</b> objects.

Parameter	Description	Values
<b>controlPlane.architecture</b>	Determines the instruction set architecture of the machines in the pool. Currently, clusters with varied architectures are not supported. All pools must specify the same architecture. Valid values are <b>amd64</b> (the default).	String
<b>controlPlane.hyperthreading</b>	Whether to enable or disable simultaneous multithreading, or <b>hyperthreading</b> , on control plane machines. By default, simultaneous multithreading is enabled to increase the performance of your machines' cores.   <b>IMPORTANT</b>  If you disable simultaneous multithreading, ensure that your capacity planning accounts for the dramatically decreased machine performance.	<b>Enabled</b> or <b>Disabled</b>
<b>controlPlane.name</b>	Required if you use <b>controlPlane</b> . The name of the machine pool.	<b>master</b>
<b>controlPlane.platform</b>	Required if you use <b>controlPlane</b> . Use this parameter to specify the cloud provider that hosts the control plane machines. This parameter value must match the <b>compute.platform</b> parameter value.	<b>alibabacloud, aws, azure, gcp, ibmcloud, openstack, ovirt, vsphere, or {}</b>
<b>controlPlane.replicas</b>	The number of control plane machines to provision.	The only supported value is <b>3</b> , which is the default value.

Parameter	Description	Values
<b>credentialsMode</b>	<p>The Cloud Credential Operator (CCO) mode. If no mode is specified, the CCO dynamically tries to determine the capabilities of the provided credentials, with a preference for mint mode on the platforms where multiple modes are supported.</p> <div data-bbox="486 517 595 864" style="border: 1px solid black; padding: 5px; margin-bottom: 10px;">  </div> <p><b>NOTE</b></p> <p>Not all CCO modes are supported for all cloud providers. For more information on CCO modes, see the <i>Cloud Credential Operator</i> entry in the <i>Cluster Operators reference content</i>.</p> <div data-bbox="486 913 595 1261" style="border: 1px solid black; padding: 5px;">  </div> <p><b>NOTE</b></p> <p>If your AWS account has service control policies (SCP) enabled, you must configure the <b>credentialsMode</b> parameter to <b>Mint</b>, <b>Passthrough</b> or <b>Manual</b>.</p>	<b>Mint, Passthrough, Manual</b> or an empty string ("").

Parameter	Description	Values
<b>fips</b>	<p>Enable or disable FIPS mode. The default is <b>false</b> (disabled). If FIPS mode is enabled, the Red Hat Enterprise Linux CoreOS (RHCOS) machines that OpenShift Container Platform runs on bypass the default Kubernetes cryptography suite and use the cryptography modules that are provided with RHCOS instead.</p> <div style="display: flex; align-items: flex-start;"> <div style="width: 20px; height: 100px; background: repeating-linear-gradient(45deg, transparent, transparent 2px, black 2px, black 4px); margin-right: 10px;"></div> <div> <p><b>IMPORTANT</b></p> <p>To enable FIPS mode for your cluster, you must run the installation program from a Red Hat Enterprise Linux (RHEL) computer configured to operate in FIPS mode. For more information about configuring FIPS mode on RHEL, see <a href="#">Installing the system in FIPS mode</a>. The use of FIPS validated or Modules In Process cryptographic libraries is only supported on OpenShift Container Platform deployments on the <b>x86_64</b> architecture.</p> </div> </div> <div style="display: flex; align-items: flex-start; margin-top: 20px;"> <div style="width: 20px; height: 50px; background: repeating-linear-gradient(45deg, transparent, transparent 2px, black 2px, black 4px); margin-right: 10px;"></div> <div> <p><b>NOTE</b></p> <p>If you are using Azure File storage, you cannot enable FIPS mode.</p> </div> </div>	<b>false</b> or <b>true</b>
<b>imageContentSources</b>	Sources and repositories for the release-image content.	Array of objects. Includes a <b>source</b> and, optionally, <b>mirrors</b> , as described in the following rows of this table.
<b>imageContentSources.source</b>	Required if you use <b>imageContentSources</b> . Specify the repository that users refer to, for example, in image pull specifications.	String
<b>imageContentSources.mirrors</b>	Specify one or more repositories that may also contain the same images.	Array of strings

Parameter	Description	Values
<b>publish</b>	How to publish or expose the user-facing endpoints of your cluster, such as the Kubernetes API, OpenShift routes.	<p><b>Internal</b> or <b>External</b>. The default value is <b>External</b>.</p> <p>Setting this field to <b>Internal</b> is not supported on non-cloud platforms and IBM Cloud VPC.</p> <div style="display: flex; align-items: flex-start;">  <div> <p><b>IMPORTANT</b></p> <p>If the value of the field is set to <b>Internal</b>, the cluster will become non-functional. For more information, refer to <a href="#">BZ#1953035</a>.</p> </div> </div>
<b>sshKey</b>	<p>The SSH key or keys to authenticate access your cluster machines.</p> <div style="display: flex; align-items: flex-start;">  <div> <p><b>NOTE</b></p> <p>For production OpenShift Container Platform clusters on which you want to perform installation debugging or disaster recovery, specify an SSH key that your <b>ssh-agent</b> process uses.</p> </div> </div>	<p>One or more keys. For example:</p> <pre>sshKey:   &lt;key1&gt;   &lt;key2&gt;   &lt;key3&gt;</pre>

#### 18.3.11.4. Additional Red Hat OpenStack Platform (RHOSP) configuration parameters

Additional RHOSP configuration parameters are described in the following table:

Table 18.11. Additional RHOSP parameters

Parameter	Description	Values
<b>compute.platform.openstack.rotoVolume.size</b>	For compute machines, the size in gigabytes of the root volume. If you do not set this value, machines use ephemeral storage.	Integer, for example <b>30</b> .
<b>compute.platform.openstack.rotoVolume.type</b>	For compute machines, the root volume's type.	String, for example <b>performance</b> .

Parameter	Description	Values
<b>controlPlane.platform.openstack.rootVolume.size</b>	For control plane machines, the size in gigabytes of the root volume. If you do not set this value, machines use ephemeral storage.	Integer, for example <b>30</b> .
<b>controlPlane.platform.openstack.rootVolume.type</b>	For control plane machines, the root volume's type.	String, for example <b>performance</b> .
<b>platform.openstack.cloud</b>	The name of the RHOSP cloud to use from the list of clouds in the <b>clouds.yaml</b> file.	String, for example <b>MyCloud</b> .
<b>platform.openstack.externalNetwork</b>	The RHOSP external network name to be used for installation.	String, for example <b>external</b> .
<b>platform.openstack.computeFlavor</b>	The RHOSP flavor to use for control plane and compute machines.  This property is deprecated. To use a flavor as the default for all machine pools, add it as the value of the <b>type</b> key in the <b>platform.openstack.defaultMachinePlatform</b> property. You can also set a flavor value for each machine pool individually.	String, for example <b>m1.xlarge</b> .

### 18.3.11.5. Optional RHOSP configuration parameters

Optional RHOSP configuration parameters are described in the following table:

Table 18.12. Optional RHOSP parameters

Parameter	Description	Values
<b>compute.platform.openstack.additionalNetworkIds</b>	Additional networks that are associated with compute machines. Allowed address pairs are not created for additional networks.	A list of one or more UUIDs as strings. For example, <b>fa806b2f-ac49-4bce-b9db-124bc64209bf</b> .

Parameter	Description	Values
<b>compute.platform.openstack.additionalSecurityGroupIDs</b>	Additional security groups that are associated with compute machines.	A list of one or more UUIDs as strings. For example, <b>7ee219f3-d2e9-48a1-96c2-e7429f1b0da7</b> .
<b>compute.platform.openstack.zones</b>	<p>RHOSP Compute (Nova) availability zones (AZs) to install machines on. If this parameter is not set, the installer relies on the default settings for Nova that the RHOSP administrator configured.</p> <p>On clusters that use Kuryr, RHOSP Octavia does not support availability zones. Load balancers and, if you are using the Amphora provider driver, OpenShift Container Platform services that rely on Amphora VMs, are not created according to the value of this property.</p>	A list of strings. For example, <b>["zone-1", "zone-2"]</b> .
<b>compute.platform.openstack.rootVolume.zones</b>	For compute machines, the availability zone to install root volumes on. If you do not set a value for this parameter, the installer selects the default availability zone.	A list of strings, for example <b>["zone-1", "zone-2"]</b> .

Parameter	Description	Values
<b>compute.platform.openstack.serverGroupPolicy</b>	<p>Server group policy to apply to the group that will contain the compute machines in the pool. You cannot change server group policies or affiliations after creation. Supported options include <b>anti-affinity</b>, <b>soft-affinity</b>, and <b>soft-anti-affinity</b>. The default value is <b>soft-anti-affinity</b>.</p> <p>An <b>affinity</b> policy prevents migrations and therefore affects RHOSP upgrades. The <b>affinity</b> policy is not supported.</p> <p>If you use a strict <b>anti-affinity</b> policy, an additional RHOSP host is required during instance migration.</p>	<p>A server group policy to apply to the machine pool. For example, <b>soft-affinity</b>.</p>
<b>controlPlane.platform.openstack.additionalNetworkIDs</b>	<p>Additional networks that are associated with control plane machines. Allowed address pairs are not created for additional networks.</p>	<p>A list of one or more UUIDs as strings. For example, <b>fa806b2f-ac49-4bce-b9db-124bc64209bf</b>.</p>
<b>controlPlane.platform.openstack.additionalSecurityGroupIDs</b>	<p>Additional security groups that are associated with control plane machines.</p>	<p>A list of one or more UUIDs as strings. For example, <b>7ee219f3-d2e9-48a1-96c2-e7429f1b0da7</b>.</p>



Parameter	Description	Values
<b>controlPlane.placement.openstack.zones</b>	<p>RHOSP Compute (Nova) availability zones (AZs) to install machines on. If this parameter is not set, the installer relies on the default settings for Nova that the RHOSP administrator configured.</p> <p>On clusters that use Kuryr, RHOSP Octavia does not support availability zones. Load balancers and, if you are using the Amphora provider driver, OpenShift Container Platform services that rely on Amphora VMs, are not created according to the value of this property.</p>	A list of strings. For example, <b>["zone-1", "zone-2"]</b> .
<b>controlPlane.placement.openstack.rootVolume.zones</b>	For control plane machines, the availability zone to install root volumes on. If you do not set this value, the installer selects the default availability zone.	A list of strings, for example <b>["zone-1", "zone-2"]</b> .
<b>controlPlane.placement.openstack.serverGroupPolicy</b>	<p>Server group policy to apply to the group that will contain the control plane machines in the pool. You cannot change server group policies or affiliations after creation. Supported options include <b>anti-affinity</b>, <b>soft-affinity</b>, and <b>soft-anti-affinity</b>. The default value is <b>soft-anti-affinity</b>.</p> <p>An <b>affinity</b> policy prevents migrations, and therefore affects RHOSP upgrades. The <b>affinity</b> policy is not supported.</p> <p>If you use a strict <b>anti-affinity</b> policy, an additional RHOSP host is required during instance migration.</p>	A server group policy to apply to the machine pool. For example, <b>soft-affinity</b> .

Parameter	Description	Values
<b>platform.openstack.clusterOSImage</b>	<p>The location from which the installer downloads the RHCOS image.</p> <p>You must set this parameter to perform an installation in a restricted network.</p>	<p>An HTTP or HTTPS URL, optionally with an SHA-256 checksum.</p> <p>For example,  <b>http://mirror.example.com/images/rhcos-43.81.201912131630.0-openstack.x86_64.qcow2.gz?sha256=ffebbd68e8a1f2a245ca19522c16c86f67f9ac8e4e0c1f0a812b068b16f7265d</b>. The value can also be the name of an existing Glance image, for example <b>my-rhcos</b>.</p>
<b>platform.openstack.clusterOSImageProperties</b>	<p>Properties to add to the installer-uploaded ClusterOSImage in Glance. This property is ignored if <b>platform.openstack.clusterOSImage</b> is set to an existing Glance image.</p> <p>You can use this property to exceed the default persistent volume (PV) limit for RHOSP of 26 PVs per node. To exceed the limit, set the <b>hw_scsi_model</b> property value to <b>virtio-scsi</b> and the <b>hw_disk_bus</b> value to <b>scsi</b>.</p> <p>You can also use this property to enable the QEMU guest agent by including the <b>hw_qemu_guest_agent</b> property with a value of <b>yes</b>.</p>	<p>A list of key-value string pairs. For example,  <b>[{"hw_scsi_model": "virtio-scsi", "hw_disk_bus": "scsi"}]</b>.</p>
<b>platform.openstack.defaultMachinePlatform</b>	<p>The default machine pool platform configuration.</p>	<pre>{   "type": "ml.large",   "rootVolume": {     "size": 30,     "type": "performance"   } }</pre>
<b>platform.openstack.ingressFloatingIP</b>	<p>An existing floating IP address to associate with the Ingress port. To use this property, you must also define the <b>platform.openstack.externalNetwork</b> property.</p>	<p>An IP address, for example <b>128.0.0.1</b>.</p>

Parameter	Description	Values
<b>platform.openstack.apiFloatingIP</b>	An existing floating IP address to associate with the API load balancer. To use this property, you must also define the <b>platform.openstack.externalNetwork</b> property.	An IP address, for example <b>128.0.0.1</b> .
<b>platform.openstack.externalDNS</b>	IP addresses for external DNS servers that cluster instances use for DNS resolution.	A list of IP addresses as strings. For example, <b>["8.8.8.8", "192.168.1.12"]</b> .
<b>platform.openstack.machinesSubnet</b>	<p>The UUID of a RHOSP subnet that the cluster's nodes use. Nodes and virtual IP (VIP) ports are created on this subnet.</p> <p>The first item in <b>networking.machineNetwork</b> must match the value of <b>machinesSubnet</b>.</p> <p>If you deploy to a custom subnet, you cannot specify an external DNS server to the OpenShift Container Platform installer. Instead, <a href="#">add DNS to the subnet in RHOSP</a>.</p>	A UUID as a string. For example, <b>fa806b2f-ac49-4bce-b9db-124bc64209bf</b> .

### 18.3.11.6. Custom subnets in RHOSP deployments

Optionally, you can deploy a cluster on a Red Hat OpenStack Platform (RHOSP) subnet of your choice. The subnet's GUID is passed as the value of **platform.openstack.machinesSubnet** in the **install-config.yaml** file.

This subnet is used as the cluster's primary subnet. By default, nodes and ports are created on it. You can create nodes and ports on a different RHOSP subnet by setting the value of the **platform.openstack.machinesSubnet** property to the subnet's UUID.

Before you run the OpenShift Container Platform installer with a custom subnet, verify that your configuration meets the following requirements:

- The subnet that is used by **platform.openstack.machinesSubnet** has DHCP enabled.
- The CIDR of **platform.openstack.machinesSubnet** matches the CIDR of **networking.machineNetwork**.
- The installation program user has permission to create ports on this network, including ports with fixed IP addresses.

Clusters that use custom subnets have the following limitations:

- If you plan to install a cluster that uses floating IP addresses, the **platform.openstack.machinesSubnet** subnet must be attached to a router that is connected to the **externalNetwork** network.
- If the **platform.openstack.machinesSubnet** value is set in the **install-config.yaml** file, the installation program does not create a private network or subnet for your RHOSP machines.
- You cannot use the **platform.openstack.externalDNS** property at the same time as a custom subnet. To add DNS to a cluster that uses a custom subnet, configure DNS on the RHOSP network.



#### NOTE

By default, the API VIP takes x.x.x.5 and the Ingress VIP takes x.x.x.7 from your network's CIDR block. To override these default values, set values for **platform.openstack.apiVIP** and **platform.openstack.ingressVIP** that are outside of the DHCP allocation pool.

#### 18.3.11.7. Sample customized install-config.yaml file for RHOSP with Kuryr

To deploy with Kuryr SDN instead of the default OpenShift SDN, you must modify the **install-config.yaml** file to include **Kuryr** as the desired **networking.networkType** and proceed with the default OpenShift Container Platform SDN installation steps. This sample **install-config.yaml** demonstrates all of the possible Red Hat OpenStack Platform (RHOSP) customization options.



#### IMPORTANT

This sample file is provided for reference only. You must obtain your **install-config.yaml** file by using the installation program.

```
apiVersion: v1
baseDomain: example.com
controlPlane:
  name: master
  platform: {}
  replicas: 3
compute:
- name: worker
  platform:
    openstack:
      type: ml.large
  replicas: 3
metadata:
  name: example
networking:
  clusterNetwork:
  - cidr: 10.128.0.0/14
    hostPrefix: 23
  machineNetwork:
  - cidr: 10.0.0.0/16
  serviceNetwork:
  - 172.30.0.0/16 1
  networkType: Kuryr
platform:
  openstack:
```

```
cloud: mycloud
externalNetwork: external
computeFlavor: m1.xlarge
apiFloatingIP: 128.0.0.1
trunkSupport: true 2
octaviaSupport: true 3
pullSecret: '{"auths": ...}'
sshKey: ssh-ed25519 AAAA...
```

- 1 The Amphora Octavia driver creates two ports per load balancer. As a result, the service subnet that the installer creates is twice the size of the CIDR that is specified as the value of the **serviceNetwork** property. The larger range is required to prevent IP address conflicts.
- 2 3 Both **trunkSupport** and **octaviaSupport** are automatically discovered by the installer, so there is no need to set them. But if your environment does not meet both requirements, Kuryr SDN will not properly work. Trunks are needed to connect the pods to the RHOSP network and Octavia is required to create the OpenShift Container Platform services.

### 18.3.11.8. Cluster deployment on RHOSP provider networks

You can deploy your OpenShift Container Platform clusters on Red Hat OpenStack Platform (RHOSP) with a primary network interface on a provider network. Provider networks are commonly used to give projects direct access to a public network that can be used to reach the internet. You can also share provider networks among projects as part of the network creation process.

RHOSP provider networks map directly to an existing physical network in the data center. A RHOSP administrator must create them.

In the following example, OpenShift Container Platform workloads are connected to a data center by using a provider network:

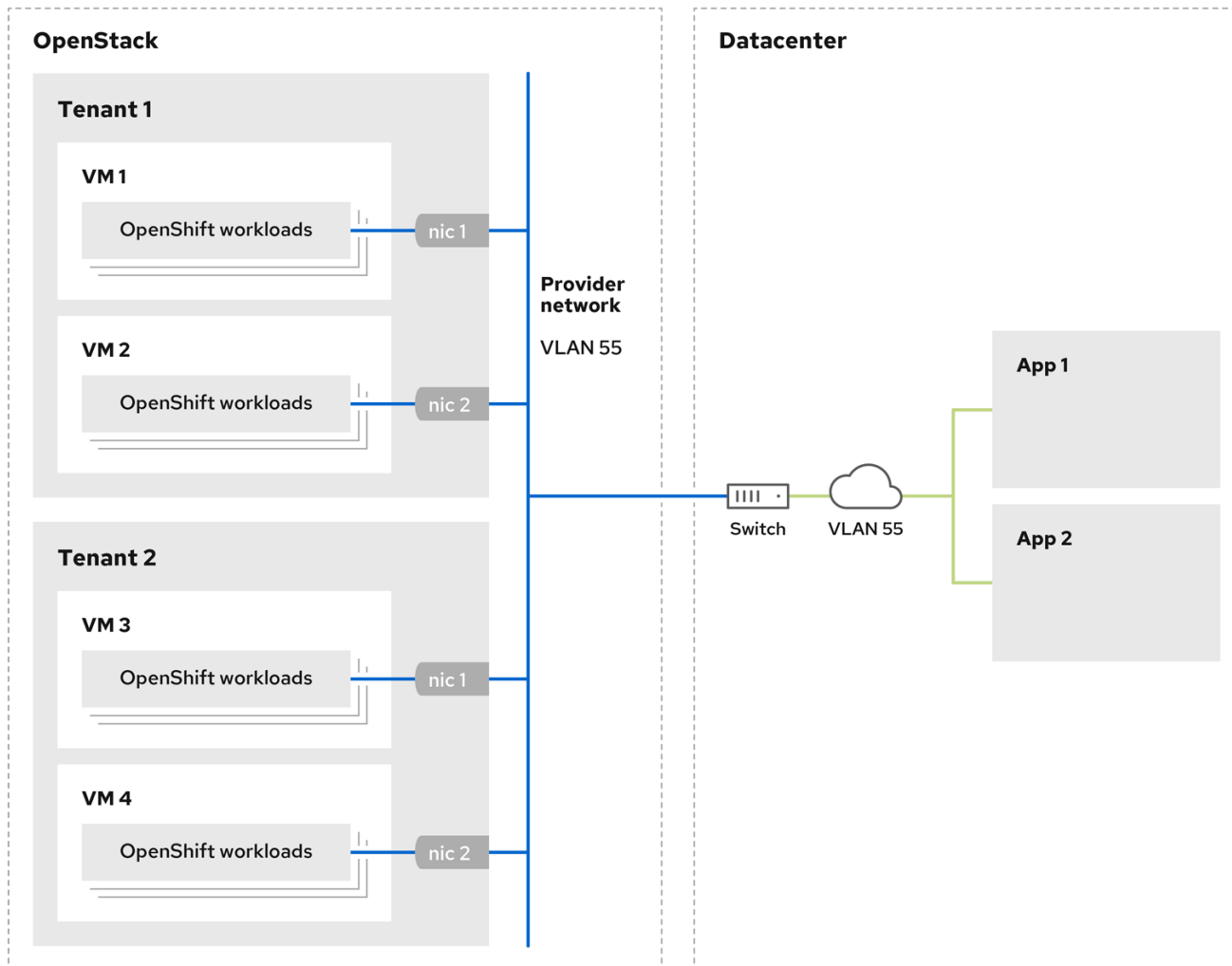

170\_OpenShift\_0621

OpenShift Container Platform clusters that are installed on provider networks do not require tenant networks or floating IP addresses. The installer does not create these resources during installation.

Example provider network types include flat (untagged) and VLAN (802.1Q tagged).



## NOTE

A cluster can support as many provider network connections as the network type allows. For example, VLAN networks typically support up to 4096 connections.

You can learn more about provider and tenant networks in [the RHOSP documentation](#).

### 18.3.11.8.1. RHOSP provider network requirements for cluster installation

Before you install an OpenShift Container Platform cluster, your Red Hat OpenStack Platform (RHOSP) deployment and provider network must meet a number of conditions:

- The [RHOSP networking service \(Neutron\) is enabled](#) and accessible through the RHOSP networking API.
- The RHOSP networking service has the [port security and allowed address pairs extensions enabled](#).

- The provider network can be shared with other tenants.

### TIP

Use the **openstack network create** command with the **--share** flag to create a network that can be shared.

- The RHOSP project that you use to install the cluster must own the provider network, as well as an appropriate subnet.

### TIP

To create a network for a project that is named "openshift," enter the following command

```
$ openstack network create --project openshift
```

To create a subnet for a project that is named "openshift," enter the following command

```
$ openstack subnet create --project openshift
```

To learn more about creating networks on RHOSP, read [the provider networks documentation](#).

If the cluster is owned by the **admin** user, you must run the installer as that user to create ports on the network.

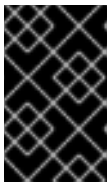

### IMPORTANT

Provider networks must be owned by the RHOSP project that is used to create the cluster. If they are not, the RHOSP Compute service (Nova) cannot request a port from that network.

- Verify that the provider network can reach the RHOSP metadata service IP address, which is **169.254.169.254** by default.

Depending on your RHOSP SDN and networking service configuration, you might need to provide the route when you create the subnet. For example:

```
$ openstack subnet create --dhcp --host-route
destination=169.254.169.254/32,gateway=192.0.2.2 ...
```

- Optional: To secure the network, create [role-based access control \(RBAC\)](#) rules that limit network access to a single project.

#### 18.3.11.8.2. Deploying a cluster that has a primary interface on a provider network

You can deploy an OpenShift Container Platform cluster that has its primary network interface on an Red Hat OpenStack Platform (RHOSP) provider network.

#### Prerequisites

- Your Red Hat OpenStack Platform (RHOSP) deployment is configured as described by "RHOSP provider network requirements for cluster installation".

## Procedure

1. In a text editor, open the **install-config.yaml** file.
2. Set the value of the **platform.openstack.apiVIP** property to the IP address for the API VIP.
3. Set the value of the **platform.openstack.ingressVIP** property to the IP address for the Ingress VIP.
4. Set the value of the **platform.openstack.machinesSubnet** property to the UUID of the provider network subnet.
5. Set the value of the **networking.machineNetwork.cidr** property to the CIDR block of the provider network subnet.



### IMPORTANT

The **platform.openstack.apiVIP** and **platform.openstack.ingressVIP** properties must both be unassigned IP addresses from the **networking.machineNetwork.cidr** block.

## Section of an installation configuration file for a cluster that relies on a RHOSP provider network

```
...
platform:
  openstack:
    apiVIP: 192.0.2.13
    ingressVIP: 192.0.2.23
    machinesSubnet: fa806b2f-ac49-4bce-b9db-124bc64209bf
    # ...
networking:
  machineNetwork:
    - cidr: 192.0.2.0/24
```



### WARNING

You cannot set the **platform.openstack.externalNetwork** or **platform.openstack.externalDNS** parameters while using a provider network for the primary network interface.

When you deploy the cluster, the installer uses the **install-config.yaml** file to deploy the cluster on the provider network.



**TIP**

You can add additional networks, including provider networks, to the **platform.openstack.additionalNetworkIDs** list.

After you deploy your cluster, you can attach pods to additional networks. For more information, see [Understanding multiple networks](#).

**18.3.11.9. Kuryr ports pools**

A Kuryr ports pool maintains a number of ports on standby for pod creation.

Keeping ports on standby minimizes pod creation time. Without ports pools, Kuryr must explicitly request port creation or deletion whenever a pod is created or deleted.

The Neutron ports that Kuryr uses are created in subnets that are tied to namespaces. These pod ports are also added as subports to the primary port of OpenShift Container Platform cluster nodes.

Because Kuryr keeps each namespace in a separate subnet, a separate ports pool is maintained for each namespace-worker pair.

Prior to installing a cluster, you can set the following parameters in the **cluster-network-03-config.yml** manifest file to configure ports pool behavior:

- The **enablePortPoolsPrepopulation** parameter controls pool prepopulation, which forces Kuryr to add Neutron ports to the pools when the first pod that is configured to use the dedicated network for pods is created in a namespace. The default value is **false**.
- The **poolMinPorts** parameter is the minimum number of free ports that are kept in the pool. The default value is **1**.
- The **poolMaxPorts** parameter is the maximum number of free ports that are kept in the pool. A value of **0** disables that upper bound. This is the default setting.  
If your OpenStack port quota is low, or you have a limited number of IP addresses on the pod network, consider setting this option to ensure that unneeded ports are deleted.
- The **poolBatchPorts** parameter defines the maximum number of Neutron ports that can be created at once. The default value is **3**.

**18.3.11.10. Adjusting Kuryr ports pools during installation**

During installation, you can configure how Kuryr manages Red Hat OpenStack Platform (RHOSP) Neutron ports to control the speed and efficiency of pod creation.

**Prerequisites**

- Create and modify the **install-config.yaml** file.

**Procedure**

1. From a command line, create the manifest files:

```
$ ./openshift-install create manifests --dir <installation_directory> 1
```

- 1 For **<installation\_directory>**, specify the name of the directory that contains the **install-config.yaml** file for your cluster.
2. Create a file that is named **cluster-network-03-config.yml** in the **<installation\_directory>/manifests/** directory:

```
$ touch <installation_directory>/manifests/cluster-network-03-config.yml 1
```

- 1 For **<installation\_directory>**, specify the directory name that contains the **manifests/** directory for your cluster.

After creating the file, several network configuration files are in the **manifests/** directory, as shown:

```
$ ls <installation_directory>/manifests/cluster-network-*
```

### Example output

```
cluster-network-01-crd.yml
cluster-network-02-config.yml
cluster-network-03-config.yml
```

3. Open the **cluster-network-03-config.yml** file in an editor, and enter a custom resource (CR) that describes the Cluster Network Operator configuration that you want:

```
$ oc edit networks.operator.openshift.io cluster
```

4. Edit the settings to meet your requirements. The following file is provided as an example:

```
apiVersion: operator.openshift.io/v1
kind: Network
metadata:
  name: cluster
spec:
  clusterNetwork:
  - cidr: 10.128.0.0/14
    hostPrefix: 23
  serviceNetwork:
  - 172.30.0.0/16
  defaultNetwork:
    type: Kuryr
    kuryrConfig:
      enablePortPoolsPrepopulation: false 1
      poolMinPorts: 1 2
      poolBatchPorts: 3 3
      poolMaxPorts: 5 4
      openstackServiceNetwork: 172.30.0.0/15 5
```

- 1 Set **enablePortPoolsPrepopulation** to **true** to make Kuryr create new Neutron ports when the first pod on the network for pods is created in a namespace. This setting raises the Neutron ports quota but can reduce the time that is required to spawn pods. The default

value is **false**.

- 2 Kuryr creates new ports for a pool if the number of free ports in that pool is lower than the value of **poolMinPorts**. The default value is **1**.
- 3 **poolBatchPorts** controls the number of new ports that are created if the number of free ports is lower than the value of **poolMinPorts**. The default value is **3**.
- 4 If the number of free ports in a pool is higher than the value of **poolMaxPorts**, Kuryr deletes them until the number matches that value. Setting this value to **0** disables this upper bound, preventing pools from shrinking. The default value is **0**.
- 5 The **openStackServiceNetwork** parameter defines the CIDR range of the network from which IP addresses are allocated to RHOSP Octavia's LoadBalancers.

If this parameter is used with the Amphora driver, Octavia takes two IP addresses from this network for each load balancer: one for OpenShift and the other for VRRP connections. Because these IP addresses are managed by OpenShift Container Platform and Neutron respectively, they must come from different pools. Therefore, the value of **openStackServiceNetwork** must be at least twice the size of the value of **serviceNetwork**, and the value of **serviceNetwork** must overlap entirely with the range that is defined by **openStackServiceNetwork**.

The CNO verifies that VRRP IP addresses that are taken from the range that is defined by this parameter do not overlap with the range that is defined by the **serviceNetwork** parameter.

If this parameter is not set, the CNO uses an expanded value of **serviceNetwork** that is determined by decrementing the prefix size by 1.

5. Save the **cluster-network-03-config.yml** file, and exit the text editor.
6. Optional: Back up the **manifests/cluster-network-03-config.yml** file. The installation program deletes the **manifests/** directory while creating the cluster.

### 18.3.12. Generating a key pair for cluster node SSH access

During an OpenShift Container Platform installation, you can provide an SSH public key to the installation program. The key is passed to the Red Hat Enterprise Linux CoreOS (RHCOS) nodes through their Ignition config files and is used to authenticate SSH access to the nodes. The key is added to the **~/.ssh/authorized\_keys** list for the **core** user on each node, which enables password-less authentication.

After the key is passed to the nodes, you can use the key pair to SSH in to the RHCOS nodes as the user **core**. To access the nodes through SSH, the private key identity must be managed by SSH for your local user.

If you want to SSH in to your cluster nodes to perform installation debugging or disaster recovery, you must provide the SSH public key during the installation process. The **./openshift-install gather** command also requires the SSH public key to be in place on the cluster nodes.

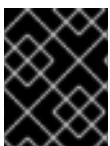

#### IMPORTANT

Do not skip this procedure in production environments, where disaster recovery and debugging is required.

## Procedure

1. If you do not have an existing SSH key pair on your local machine to use for authentication onto your cluster nodes, create one. For example, on a computer that uses a Linux operating system, run the following command:

```
$ ssh-keygen -t ed25519 -N "" -f <path>/<file_name> 1
```

- 1 Specify the path and file name, such as `~/.ssh/id_ed25519`, of the new SSH key. If you have an existing key pair, ensure your public key is in the your `~/.ssh` directory.

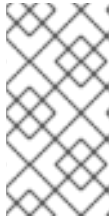

### NOTE

If you plan to install an OpenShift Container Platform cluster that uses FIPS validated or Modules In Process cryptographic libraries on the **x86\_64** architecture, do not create a key that uses the **ed25519** algorithm. Instead, create a key that uses the **rsa** or **ecdsa** algorithm.

2. View the public SSH key:

```
$ cat <path>/<file_name>.pub
```

For example, run the following to view the `~/.ssh/id_ed25519.pub` public key:

```
$ cat ~/.ssh/id_ed25519.pub
```

3. Add the SSH private key identity to the SSH agent for your local user, if it has not already been added. SSH agent management of the key is required for password-less SSH authentication onto your cluster nodes, or if you want to use the `./openshift-install gather` command.



### NOTE

On some distributions, default SSH private key identities such as `~/.ssh/id_rsa` and `~/.ssh/id_dsa` are managed automatically.

- a. If the **ssh-agent** process is not already running for your local user, start it as a background task:

```
$ eval "$(ssh-agent -s)"
```

### Example output

```
Agent pid 31874
```



### NOTE

If your cluster is in FIPS mode, only use FIPS-compliant algorithms to generate the SSH key. The key must be either RSA or ECDSA.

4. Add your SSH private key to the **ssh-agent**:

■

```
$ ssh-add <path>/<file_name> 1
```

- 1 Specify the path and file name for your SSH private key, such as `~/.ssh/id_ed25519`

### Example output

```
Identity added: /home/<you>/<path>/<file_name> (<computer_name>)
```

### Next steps

- When you install OpenShift Container Platform, provide the SSH public key to the installation program.

## 18.3.13. Enabling access to the environment

At deployment, all OpenShift Container Platform machines are created in a Red Hat OpenStack Platform (RHOSP)-tenant network. Therefore, they are not accessible directly in most RHOSP deployments.

You can configure OpenShift Container Platform API and application access by using floating IP addresses (FIPs) during installation. You can also complete an installation without configuring FIPs, but the installer will not configure a way to reach the API or applications externally.

### 18.3.13.1. Enabling access with floating IP addresses

Create floating IP (FIP) addresses for external access to the OpenShift Container Platform API and cluster applications.

#### Procedure

1. Using the Red Hat OpenStack Platform (RHOSP) CLI, create the API FIP:

```
$ openstack floating ip create --description "API <cluster_name>.<base_domain>"
<external_network>
```

2. Using the Red Hat OpenStack Platform (RHOSP) CLI, create the apps, or Ingress, FIP:

```
$ openstack floating ip create --description "Ingress <cluster_name>.<base_domain>"
<external_network>
```

3. Add records that follow these patterns to your DNS server for the API and Ingress FIPs:

```
api.<cluster_name>.<base_domain>. IN A <API_FIP>
*.apps.<cluster_name>.<base_domain>. IN A <apps_FIP>
```



## NOTE

If you do not control the DNS server, you can access the cluster by adding the cluster domain names such as the following to your `/etc/hosts` file:

- `<api_floating_ip> api.<cluster_name>.<base_domain>`
- `<application_floating_ip> grafana-openshift-monitoring.apps.<cluster_name>.<base_domain>`
- `<application_floating_ip> prometheus-k8s-openshift-monitoring.apps.<cluster_name>.<base_domain>`
- `<application_floating_ip> oauth-openshift.apps.<cluster_name>.<base_domain>`
- `<application_floating_ip> console-openshift-console.apps.<cluster_name>.<base_domain>`
- `application_floating_ip integrated-oauth-server-openshift-authentication.apps.<cluster_name>.<base_domain>`

The cluster domain names in the `/etc/hosts` file grant access to the web console and the monitoring interface of your cluster locally. You can also use the `kubectl` or `oc`. You can access the user applications by using the additional entries pointing to the `<application_floating_ip>`. This action makes the API and applications accessible to only you, which is not suitable for production deployment, but does allow installation for development and testing.

4. Add the FIPs to the `install-config.yaml` file as the values of the following parameters:

- `platform.openstack.ingressFloatingIP`
- `platform.openstack.apiFloatingIP`

If you use these values, you must also enter an external network as the value of the `platform.openstack.externalNetwork` parameter in the `install-config.yaml` file.

## TIP

You can make OpenShift Container Platform resources available outside of the cluster by assigning a floating IP address and updating your firewall configuration.

### 18.3.13.2. Completing installation without floating IP addresses

You can install OpenShift Container Platform on Red Hat OpenStack Platform (RHOSP) without providing floating IP addresses.

In the `install-config.yaml` file, do not define the following parameters:

- `platform.openstack.ingressFloatingIP`
- `platform.openstack.apiFloatingIP`

If you cannot provide an external network, you can also leave `platform.openstack.externalNetwork` blank. If you do not provide a value for `platform.openstack.externalNetwork`, a router is not created for

you, and, without additional action, the installer will fail to retrieve an image from Glance. You must configure external connectivity on your own.

If you run the installer from a system that cannot reach the cluster API due to a lack of floating IP addresses or name resolution, installation fails. To prevent installation failure in these cases, you can use a proxy network or run the installer from a system that is on the same network as your machines.



## NOTE

You can enable name resolution by creating DNS records for the API and Ingress ports. For example:

```
api.<cluster_name>.<base_domain>. IN A <api_port_IP>
*.apps.<cluster_name>.<base_domain>. IN A <ingress_port_IP>
```

If you do not control the DNS server, you can add the record to your `/etc/hosts` file. This action makes the API accessible to only you, which is not suitable for production deployment but does allow installation for development and testing.

### 18.3.14. Deploying the cluster

You can install OpenShift Container Platform on a compatible cloud platform.

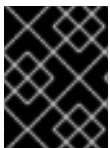

## IMPORTANT

You can run the **create cluster** command of the installation program only once, during initial installation.

### Prerequisites

- Obtain the OpenShift Container Platform installation program and the pull secret for your cluster.

### Procedure

1. Change to the directory that contains the installation program and initialize the cluster deployment:

```
$ ./openshift-install create cluster --dir <installation_directory> \ 1
--log-level=info 2
```

- 1 For **<installation\_directory>**, specify the location of your customized `./install-config.yaml` file.
- 2 To view different installation details, specify **warn**, **debug**, or **error** instead of **info**.



## NOTE

If the cloud provider account that you configured on your host does not have sufficient permissions to deploy the cluster, the installation process stops, and the missing permissions are displayed.

When the cluster deployment completes, directions for accessing your cluster, including a link to its web console and credentials for the **kubeadmin** user, display in your terminal.

### Example output

```
...
INFO Install complete!
INFO To access the cluster as the system:admin user when using 'oc', run 'export
KUBECONFIG=/home/myuser/install_dir/auth/kubeconfig'
INFO Access the OpenShift web-console here: https://console-openshift-
console.apps.mycluster.example.com
INFO Login to the console with user: "kubeadmin", and password: "4vYBz-Ee6gm-ymBZj-
Wt5AL"
INFO Time elapsed: 36m22s
```



### NOTE

The cluster access and credential information also outputs to **<installation\_directory>/openshift\_install.log** when an installation succeeds.



### IMPORTANT

- The Ignition config files that the installation program generates contain certificates that expire after 24 hours, which are then renewed at that time. If the cluster is shut down before renewing the certificates and the cluster is later restarted after the 24 hours have elapsed, the cluster automatically recovers the expired certificates. The exception is that you must manually approve the pending **node-bootstrapper** certificate signing requests (CSRs) to recover kubelet certificates. See the documentation for *Recovering from expired control plane certificates* for more information.
- It is recommended that you use Ignition config files within 12 hours after they are generated because the 24-hour certificate rotates from 16 to 22 hours after the cluster is installed. By using the Ignition config files within 12 hours, you can avoid installation failure if the certificate update runs during installation.



### IMPORTANT

You must not delete the installation program or the files that the installation program creates. Both are required to delete the cluster.

## 18.3.15. Verifying cluster status

You can verify your OpenShift Container Platform cluster's status during or after installation.

### Procedure

1. In the cluster environment, export the administrator's kubeconfig file:

```
$ export KUBECONFIG=<installation_directory>/auth/kubeconfig 1
```



For **<installation\_directory>**, specify the path to the directory that you stored the installation files in.



The **kubeconfig** file contains information about the cluster that is used by the CLI to connect a client to the correct cluster and API server.

2. View the control plane and compute machines created after a deployment:

```
$ oc get nodes
```

3. View your cluster's version:

```
$ oc get clusterversion
```

4. View your Operators' status:

```
$ oc get clusteroperator
```

5. View all running pods in the cluster:

```
$ oc get pods -A
```

### 18.3.16. Logging in to the cluster by using the CLI

You can log in to your cluster as a default system user by exporting the cluster **kubeconfig** file. The **kubeconfig** file contains information about the cluster that is used by the CLI to connect a client to the correct cluster and API server. The file is specific to a cluster and is created during OpenShift Container Platform installation.

#### Prerequisites

- You deployed an OpenShift Container Platform cluster.
- You installed the **oc** CLI.

#### Procedure

1. Export the **kubeadmin** credentials:

```
$ export KUBECONFIG=<installation_directory>/auth/kubeconfig 1
```

- 1** For **<installation\_directory>**, specify the path to the directory that you stored the installation files in.

2. Verify you can run **oc** commands successfully using the exported configuration:

```
$ oc whoami
```

#### Example output

```
system:admin
```

#### Additional resources

- See [Accessing the web console](#) for more details about accessing and understanding the OpenShift Container Platform web console.

### 18.3.17. Telemetry access for OpenShift Container Platform

In OpenShift Container Platform 4.10, the Telemetry service, which runs by default to provide metrics about cluster health and the success of updates, requires internet access. If your cluster is connected to the internet, Telemetry runs automatically, and your cluster is registered to [OpenShift Cluster Manager](#).

After you confirm that your [OpenShift Cluster Manager](#) inventory is correct, either maintained automatically by Telemetry or manually by using OpenShift Cluster Manager, [use subscription watch](#) to track your OpenShift Container Platform subscriptions at the account or multi-cluster level.

#### Additional resources

- See [About remote health monitoring](#) for more information about the Telemetry service

### 18.3.18. Next steps

- [Customize your cluster](#).
- If necessary, you can [opt out of remote health reporting](#).
- If you need to enable external access to node ports, [configure ingress cluster traffic by using a node port](#).
- If you did not configure RHOSP to accept application traffic over floating IP addresses, [configure RHOSP access with floating IP addresses](#).

## 18.4. INSTALLING A CLUSTER ON OPENSTACK THAT SUPPORTS SR-IOV-CONNECTED COMPUTE MACHINES

In OpenShift Container Platform version 4.10, you can install a cluster on Red Hat OpenStack Platform (RHOSP) that can use compute machines with single-root I/O virtualization (SR-IOV) technology.

### 18.4.1. Prerequisites

- Review details about the [OpenShift Container Platform installation and update](#) processes.
  - Verify that OpenShift Container Platform 4.10 is compatible with your RHOSP version by using the "Supported platforms for OpenShift clusters" section. You can also compare platform support across different versions by viewing the [OpenShift Container Platform on RHOSP support matrix](#).
- Verify that your network configuration does not rely on a provider network. Provider networks are not supported.
- Have a storage service installed in RHOSP, like block storage (Cinder) or object storage (Swift). Object storage is the recommended storage technology for OpenShift Container Platform registry cluster deployment. For more information, see [Optimizing storage](#).
- Have metadata service enabled in RHOSP

### 18.4.2. Resource guidelines for installing OpenShift Container Platform on RHOSP

To support an OpenShift Container Platform installation, your Red Hat OpenStack Platform (RHOSP) quota must meet the following requirements:

**Table 18.13. Recommended resources for a default OpenShift Container Platform cluster on RHOSP**

Resource	Value
Floating IP addresses	3
Ports	15
Routers	1
Subnets	1
RAM	88 GB
vCPUs	22
Volume storage	275 GB
Instances	7
Security groups	3
Security group rules	60
Server groups	2 - plus 1 for each additional availability zone in each machine pool

A cluster might function with fewer than recommended resources, but its performance is not guaranteed.

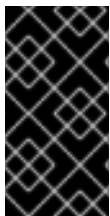

### IMPORTANT

If RHOSP object storage (Swift) is available and operated by a user account with the **swiftoperator** role, it is used as the default backend for the OpenShift Container Platform image registry. In this case, the volume storage requirement is 175 GB. Swift space requirements vary depending on the size of the image registry.



### NOTE

By default, your security group and security group rule quotas might be low. If you encounter problems, run **openstack quota set --secgroups 3 --secgroup-rules 60 <project>** as an administrator to increase them.

An OpenShift Container Platform deployment comprises control plane machines, compute machines, and a bootstrap machine.

### 18.4.2.1. Control plane machines

By default, the OpenShift Container Platform installation process creates three control plane machines.

Each machine requires:

- An instance from the RHOSP quota
- A port from the RHOSP quota
- A flavor with at least 16 GB memory and 4 vCPUs
- At least 100 GB storage space from the RHOSP quota

### 18.4.2.2. Compute machines

By default, the OpenShift Container Platform installation process creates three compute machines.

Each machine requires:

- An instance from the RHOSP quota
- A port from the RHOSP quota
- A flavor with at least 8 GB memory and 2 vCPUs
- At least 100 GB storage space from the RHOSP quota

#### TIP

Compute machines host the applications that you run on OpenShift Container Platform; aim to run as many as you can.

Additionally, for clusters that use single-root input/output virtualization (SR-IOV), RHOSP compute nodes require a flavor that supports [huge pages](#).

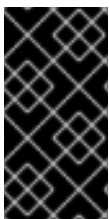

#### IMPORTANT

SR-IOV deployments often employ performance optimizations, such as dedicated or isolated CPUs. For maximum performance, configure your underlying RHOSP deployment to use these optimizations, and then run OpenShift Container Platform compute machines on the optimized infrastructure.

#### Additional resources

- For more information about configuring performant RHOSP compute nodes, see [Configuring Compute nodes for performance](#).

### 18.4.2.3. Bootstrap machine

During installation, a bootstrap machine is temporarily provisioned to stand up the control plane. After the production control plane is ready, the bootstrap machine is deprovisioned.

The bootstrap machine requires:

- An instance from the RHOSP quota
- A port from the RHOSP quota
- A flavor with at least 16 GB memory and 4 vCPUs
- At least 100 GB storage space from the RHOSP quota

### 18.4.3. Internet access for OpenShift Container Platform

In OpenShift Container Platform 4.10, you require access to the internet to install your cluster.

You must have internet access to:

- Access [OpenShift Cluster Manager](#) to download the installation program and perform subscription management. If the cluster has internet access and you do not disable Telemetry, that service automatically entitles your cluster.
- Access [Quay.io](#) to obtain the packages that are required to install your cluster.
- Obtain the packages that are required to perform cluster updates.

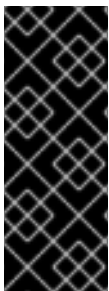

#### IMPORTANT

If your cluster cannot have direct internet access, you can perform a restricted network installation on some types of infrastructure that you provision. During that process, you download the required content and use it to populate a mirror registry with the installation packages. With some installation types, the environment that you install your cluster in will not require internet access. Before you update the cluster, you update the content of the mirror registry.

### 18.4.4. Enabling Swift on RHOSP

Swift is operated by a user account with the **swiftoperator** role. Add the role to an account before you run the installation program.

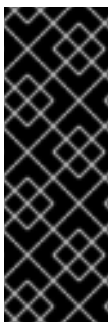

#### IMPORTANT

If [the Red Hat OpenStack Platform \(RHOSP\) object storage service](#), commonly known as Swift, is available, OpenShift Container Platform uses it as the image registry storage. If it is unavailable, the installation program relies on the RHOSP block storage service, commonly known as Cinder.

If Swift is present and you want to use it, you must enable access to it. If it is not present, or if you do not want to use it, skip this section.

#### Prerequisites

- You have a RHOSP administrator account on the target environment.
- The Swift service is installed.
- On [Ceph RGW](#), the **account in url** option is enabled.

#### Procedure

To enable Swift on RHOSP:

1. As an administrator in the RHOSP CLI, add the **swiftoperator** role to the account that will access Swift:

```
$ openstack role add --user <user> --project <project> swiftoperator
```

Your RHOSP deployment can now use Swift for the image registry.

### 18.4.5. Verifying external network access

The OpenShift Container Platform installation process requires external network access. You must provide an external network value to it, or deployment fails. Before you begin the process, verify that a network with the external router type exists in Red Hat OpenStack Platform (RHOSP).

#### Prerequisites

- [Configure OpenStack's networking service to have DHCP agents forward instances' DNS queries](#)

#### Procedure

1. Using the RHOSP CLI, verify the name and ID of the 'External' network:

```
$ openstack network list --long -c ID -c Name -c "Router Type"
```

#### Example output

```
+-----+-----+-----+
| ID                | Name          | Router Type |
+-----+-----+-----+
| 148a8023-62a7-4672-b018-003462f8d7dc | public_network | External    |
+-----+-----+-----+
```

A network with an external router type appears in the network list. If at least one does not, see [Creating a default floating IP network](#) and [Creating a default provider network](#).



#### NOTE

If the Neutron trunk service plugin is enabled, a trunk port is created by default. For more information, see [Neutron trunk port](#).

### 18.4.6. Defining parameters for the installation program

The OpenShift Container Platform installation program relies on a file that is called **clouds.yaml**. The file describes Red Hat OpenStack Platform (RHOSP) configuration parameters, including the project name, log in information, and authorization service URLs.

#### Procedure

1. Create the **clouds.yaml** file:
  - If your RHOSP distribution includes the Horizon web UI, generate a **clouds.yaml** file in it.



## IMPORTANT

Remember to add a password to the **auth** field. You can also keep secrets in [a separate file](#) from **clouds.yaml**.

- If your RHOSP distribution does not include the Horizon web UI, or you do not want to use Horizon, create the file yourself. For detailed information about **clouds.yaml**, see [Config files](#) in the RHOSP documentation.

```
clouds:
  shiftstack:
    auth:
      auth_url: http://10.10.14.42:5000/v3
      project_name: shiftstack
      username: <username>
      password: <password>
      user_domain_name: Default
      project_domain_name: Default
  dev-env:
    region_name: RegionOne
    auth:
      username: <username>
      password: <password>
      project_name: 'devonly'
      auth_url: 'https://10.10.14.22:5001/v2.0'
```

2. If your RHOSP installation uses self-signed certificate authority (CA) certificates for endpoint authentication:
  - a. Copy the certificate authority file to your machine.
  - b. Add the **cacerts** key to the **clouds.yaml** file. The value must be an absolute, non-root-accessible path to the CA certificate:

```
clouds:
  shiftstack:
    ...
    cacert: "/etc/pki/ca-trust/source/anchors/ca.crt.pem"
```

## TIP

After you run the installer with a custom CA certificate, you can update the certificate by editing the value of the **ca-cert.pem** key in the **cloud-provider-config** keymap. On a command line, run:

```
$ oc edit configmap -n openshift-config cloud-provider-config
```

3. Place the **clouds.yaml** file in one of the following locations:
  - a. The value of the **OS\_CLIENT\_CONFIG\_FILE** environment variable
  - b. The current directory
  - c. A Unix-specific user configuration directory, for example **~/.config/openstack/clouds.yaml**

- d. A Unix-specific site configuration directory, for example `/etc/openstack/clouds.yaml`. The installation program searches for `clouds.yaml` in that order.

### 18.4.7. Obtaining the installation program

Before you install OpenShift Container Platform, download the installation file on a local computer.

#### Prerequisites

- You have a computer that runs Linux or macOS, with 500 MB of local disk space

#### Procedure

1. Access the [Infrastructure Provider](#) page on the OpenShift Cluster Manager site. If you have a Red Hat account, log in with your credentials. If you do not, create an account.
2. Select your infrastructure provider.
3. Navigate to the page for your installation type, download the installation program that corresponds with your host operating system and architecture, and place the file in the directory where you will store the installation configuration files.

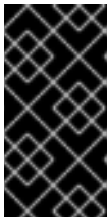

#### IMPORTANT

The installation program creates several files on the computer that you use to install your cluster. You must keep the installation program and the files that the installation program creates after you finish installing the cluster. Both files are required to delete the cluster.

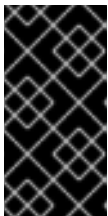

#### IMPORTANT

Deleting the files created by the installation program does not remove your cluster, even if the cluster failed during installation. To remove your cluster, complete the OpenShift Container Platform uninstallation procedures for your specific cloud provider.

4. Extract the installation program. For example, on a computer that uses a Linux operating system, run the following command:

```
$ tar -xvf openshift-install-linux.tar.gz
```

5. Download your installation [pull secret from the Red Hat OpenShift Cluster Manager](#). This pull secret allows you to authenticate with the services that are provided by the included authorities, including Quay.io, which serves the container images for OpenShift Container Platform components.

### 18.4.8. Creating the installation configuration file

You can customize the OpenShift Container Platform cluster you install on

#### Prerequisites



- Obtain the OpenShift Container Platform installation program and the pull secret for your cluster.
- Obtain service principal permissions at the subscription level.

## Procedure

1. Create the **install-config.yaml** file.
  - a. Change to the directory that contains the installation program and run the following command:

```
$ ./openshift-install create install-config --dir <installation_directory> 1
```

- 1** For **<installation\_directory>**, specify the directory name to store the files that the installation program creates.



### IMPORTANT

Specify an empty directory. Some installation assets, like bootstrap X.509 certificates have short expiration intervals, so you must not reuse an installation directory. If you want to reuse individual files from another cluster installation, you can copy them into your directory. However, the file names for the installation assets might change between releases. Use caution when copying installation files from an earlier OpenShift Container Platform version.

- b. At the prompts, provide the configuration details for your cloud:
  - i. Optional: Select an SSH key to use to access your cluster machines.



### NOTE

For production OpenShift Container Platform clusters on which you want to perform installation debugging or disaster recovery, specify an SSH key that your **ssh-agent** process uses.

- ii. Enter a descriptive name for your cluster.
  - iii. Paste the [pull secret from the Red Hat OpenShift Cluster Manager](#) .
2. Modify the **install-config.yaml** file. You can find more information about the available parameters in the "Installation configuration parameters" section.
  3. Back up the **install-config.yaml** file so that you can use it to install multiple clusters.



### IMPORTANT

The **install-config.yaml** file is consumed during the installation process. If you want to reuse the file, you must back it up now.

#### 18.4.8.1. Configuring the cluster-wide proxy during installation

Production environments can deny direct access to the internet and instead have an HTTP or HTTPS proxy available. You can configure a new OpenShift Container Platform cluster to use a proxy by configuring the proxy settings in the **install-config.yaml** file.

## Prerequisites

- You have an existing **install-config.yaml** file.
- You reviewed the sites that your cluster requires access to and determined whether any of them need to bypass the proxy. By default, all cluster egress traffic is proxied, including calls to hosting cloud provider APIs. You added sites to the **Proxy** object's **spec.noProxy** field to bypass the proxy if necessary.



### NOTE

The **Proxy** object **status.noProxy** field is populated with the values of the **networking.machineNetwork[].cidr**, **networking.clusterNetwork[].cidr**, and **networking.serviceNetwork[]** fields from your installation configuration.

For installations on Amazon Web Services (AWS), Google Cloud Platform (GCP), Microsoft Azure, and Red Hat OpenStack Platform (RHOSP), the **Proxy** object **status.noProxy** field is also populated with the instance metadata endpoint (**169.254.169.254**).

## Procedure

1. Edit your **install-config.yaml** file and add the proxy settings. For example:

```
apiVersion: v1
baseDomain: my.domain.com
proxy:
  httpProxy: http://<username>:<pswd>@<ip>:<port> 1
  httpsProxy: https://<username>:<pswd>@<ip>:<port> 2
  noProxy: example.com 3
  additionalTrustBundle: | 4
    -----BEGIN CERTIFICATE-----
    <MY_TRUSTED_CA_CERT>
    -----END CERTIFICATE-----
  ...
```

- 1 A proxy URL to use for creating HTTP connections outside the cluster. The URL scheme must be **http**.
- 2 A proxy URL to use for creating HTTPS connections outside the cluster.
- 3 A comma-separated list of destination domain names, IP addresses, or other network CIDRs to exclude from proxying. Preface a domain with **.** to match subdomains only. For example, **.y.com** matches **x.y.com**, but not **y.com**. Use **\*** to bypass the proxy for all destinations.
- 4 If provided, the installation program generates a config map that is named **user-ca-bundle** in the **openshift-config** namespace that contains one or more additional CA certificates that are required for proxying HTTPS connections. The Cluster Network Operator then creates a **trusted-ca-bundle** config map that merges these contents with the Red Hat Enterprise Linux CoreOS (RHCOS) trust bundle, and this config map is referenced in the

**trustedCA** field of the **Proxy** object. The **additionalTrustBundle** field is required unless the proxy's identity certificate is signed by an authority from the RHCOS trust bundle.

**NOTE**

The installation program does not support the proxy **readinessEndpoints** field.

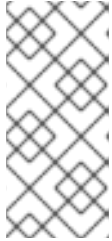
**NOTE**

If the installer times out, restart and then complete the deployment by using the **wait-for** command of the installer. For example:

```
$ ./openshift-install wait-for install-complete --log-level debug
```

2. Save the file and reference it when installing OpenShift Container Platform.

The installation program creates a cluster-wide proxy that is named **cluster** that uses the proxy settings in the provided **install-config.yaml** file. If no proxy settings are provided, a **cluster Proxy** object is still created, but it will have a nil **spec**.

**NOTE**

Only the **Proxy** object named **cluster** is supported, and no additional proxies can be created.

### 18.4.9. Installation configuration parameters

Before you deploy an OpenShift Container Platform cluster, you provide parameter values to describe your account on the cloud platform that hosts your cluster and optionally customize your cluster's platform. When you create the **install-config.yaml** installation configuration file, you provide values for the required parameters through the command line. If you customize your cluster, you can modify the **install-config.yaml** file to provide more details about the platform.

**NOTE**

After installation, you cannot modify these parameters in the **install-config.yaml** file.

#### 18.4.9.1. Required configuration parameters

Required installation configuration parameters are described in the following table:

**Table 18.14. Required parameters**

Parameter	Description	Values
<b>apiVersion</b>	The API version for the <b>install-config.yaml</b> content. The current version is <b>v1</b> . The installer may also support older API versions.	String

Parameter	Description	Values
<b>baseDomain</b>	The base domain of your cloud provider. The base domain is used to create routes to your OpenShift Container Platform cluster components. The full DNS name for your cluster is a combination of the <b>baseDomain</b> and <b>metadata.name</b> parameter values that uses the <b>&lt;metadata.name&gt;.&lt;baseDomain&gt;</b> format.	A fully-qualified domain or subdomain name, such as <b>example.com</b> .
<b>metadata</b>	Kubernetes resource <b>ObjectMeta</b> , from which only the <b>name</b> parameter is consumed.	Object
<b>metadata.name</b>	The name of the cluster. DNS records for the cluster are all subdomains of <b>{{.metadata.name}}.{{.baseDomain}}</b> .	String of lowercase letters, hyphens (-), and periods (.), such as <b>dev</b> .
<b>platform</b>	The configuration for the specific platform upon which to perform the installation: <b>alibabacloud, aws, baremetal, azure, gcp, ibmcloud, openstack, ovirt, vsphere</b> , or <b>{}</b> . For additional information about <b>platform.&lt;platform&gt;</b> parameters, consult the table for your specific platform that follows.	Object

Parameter	Description	Values
<b>pullSecret</b>	Get a <a href="#">pull secret from the Red Hat OpenShift Cluster Manager</a> to authenticate downloading container images for OpenShift Container Platform components from services such as Quay.io.	<pre>{   "auths":{     "cloud.openshift.com":{       "auth":"b3Blb=",       "email":"you@example.com"     },     "quay.io":{       "auth":"b3Blb=",       "email":"you@example.com"     }   } }</pre>

### 18.4.9.2. Network configuration parameters

You can customize your installation configuration based on the requirements of your existing network infrastructure. For example, you can expand the IP address block for the cluster network or provide different IP address blocks than the defaults.

Only IPv4 addresses are supported.

Table 18.15. Network parameters

Parameter	Description	Values
<b>networking</b>	The configuration for the cluster network.	Object  <p><b>NOTE</b></p> <p>You cannot modify parameters specified by the <b>networking</b> object after installation.</p>
<b>networking.networkType</b>	The cluster network provider Container Network Interface (CNI) plugin to install.	Either <b>OpenShiftSDN</b> or <b>OVNKubernetes</b> . <b>OpenShiftSDN</b> is a CNI provider for all-Linux networks. <b>OVNKubernetes</b> is a CNI provider for Linux networks and hybrid networks that contain both Linux and Windows servers. The default value is <b>OpenShiftSDN</b> .

Parameter	Description	Values
<b>networking.clusterNetwork</b>	<p>The IP address blocks for pods.</p> <p>The default value is <b>10.128.0.0/14</b> with a host prefix of <b>/23</b>.</p> <p>If you specify multiple IP address blocks, the blocks must not overlap.</p>	<p>An array of objects. For example:</p> <pre>networking:   clusterNetwork:     - cidr: 10.128.0.0/14       hostPrefix: 23</pre>
<b>networking.clusterNetwork.cidr</b>	<p>Required if you use <b>networking.clusterNetwork</b>. An IP address block.</p> <p>An IPv4 network.</p>	<p>An IP address block in Classless Inter-Domain Routing (CIDR) notation. The prefix length for an IPv4 block is between <b>0</b> and <b>32</b>.</p>
<b>networking.clusterNetwork.hostPrefix</b>	<p>The subnet prefix length to assign to each individual node. For example, if <b>hostPrefix</b> is set to <b>23</b> then each node is assigned a <b>/23</b> subnet out of the given <b>cidr</b>. A <b>hostPrefix</b> value of <b>23</b> provides 510 (<math>2^{(32 - 23)} - 2</math>) pod IP addresses.</p>	<p>A subnet prefix.</p> <p>The default value is <b>23</b>.</p>
<b>networking.serviceNetwork</b>	<p>The IP address block for services. The default value is <b>172.30.0.0/16</b>.</p> <p>The OpenShift SDN and OVN-Kubernetes network providers support only a single IP address block for the service network.</p>	<p>An array with an IP address block in CIDR format. For example:</p> <pre>networking:   serviceNetwork:     - 172.30.0.0/16</pre>
<b>networking.machineNetwork</b>	<p>The IP address blocks for machines.</p> <p>If you specify multiple IP address blocks, the blocks must not overlap.</p>	<p>An array of objects. For example:</p> <pre>networking:   machineNetwork:     - cidr: 10.0.0.0/16</pre>
<b>networking.machineNetwork.cidr</b>	<p>Required if you use <b>networking.machineNetwork</b>. An IP address block. The default value is <b>10.0.0.0/16</b> for all platforms other than libvirt. For libvirt, the default value is <b>192.168.126.0/24</b>.</p>	<p>An IP network block in CIDR notation.</p> <p>For example, <b>10.0.0.0/16</b>.</p> <div style="display: flex; align-items: flex-start;">  <div> <p><b>NOTE</b></p> <p>Set the <b>networking.machineNetwork</b> to match the CIDR that the preferred NIC resides in.</p> </div> </div>

### 18.4.9.3. Optional configuration parameters

Optional installation configuration parameters are described in the following table:

**Table 18.16. Optional parameters**



Parameter	Description	Values
<b>additionalTrustBundle</b>	A PEM-encoded X.509 certificate bundle that is added to the nodes' trusted certificate store. This trust bundle may also be used when a proxy has been configured.	String
<b>cgroupsV2</b>	Enables <a href="#">Linux control groups version 2</a> (cgroups v2) on specific nodes in your cluster. The OpenShift Container Platform process for enabling cgroups v2 disables all cgroup version 1 controllers and hierarchies. The OpenShift Container Platform cgroups version 2 feature is in Developer Preview and is not supported by Red Hat at this time.	<b>true</b>
<b>compute</b>	The configuration for the machines that comprise the compute nodes.	Array of <b>MachinePool</b> objects.
<b>compute.architecture</b>	Determines the instruction set architecture of the machines in the pool. Currently, clusters with varied architectures are not supported. All pools must specify the same architecture. Valid values are <b>amd64</b> (the default).	String
<b>compute.hyperthreading</b>	Whether to enable or disable simultaneous multithreading, or <b>hyperthreading</b> , on compute machines. By default, simultaneous multithreading is enabled to increase the performance of your machines' cores.	<b>Enabled</b> or <b>Disabled</b>
	 <p><b>IMPORTANT</b></p> <p>If you disable simultaneous multithreading, ensure that your capacity planning accounts for the dramatically decreased machine performance.</p>	

Parameter	Description	Values
<b>compute.name</b>	Required if you use <b>compute</b> . The name of the machine pool.	<b>worker</b>
<b>compute.platform</b>	Required if you use <b>compute</b> . Use this parameter to specify the cloud provider to host the worker machines. This parameter value must match the <b>controlPlane.platform</b> parameter value.	<b>alibabacloud, aws, azure, gcp, ibmcloud, openstack, ovirt, vsphere, or {}</b>
<b>compute.replicas</b>	The number of compute machines, which are also known as worker machines, to provision.	A positive integer greater than or equal to <b>2</b> . The default value is <b>3</b> .
<b>controlPlane</b>	The configuration for the machines that comprise the control plane.	Array of <b>MachinePool</b> objects.
<b>controlPlane.architecture</b>	Determines the instruction set architecture of the machines in the pool. Currently, clusters with varied architectures are not supported. All pools must specify the same architecture. Valid values are <b>amd64</b> (the default).	String
<b>controlPlane.hyperthreading</b>	Whether to enable or disable simultaneous multithreading, or <b>hyperthreading</b> , on control plane machines. By default, simultaneous multithreading is enabled to increase the performance of your machines' cores.   <b>IMPORTANT</b> If you disable simultaneous multithreading, ensure that your capacity planning accounts for the dramatically decreased machine performance.	<b>Enabled</b> or <b>Disabled</b>
<b>controlPlane.name</b>	Required if you use <b>controlPlane</b> . The name of the machine pool.	<b>master</b>



Parameter	Description	Values
<b>controlPlane.platform</b>	Required if you use <b>controlPlane</b> . Use this parameter to specify the cloud provider that hosts the control plane machines. This parameter value must match the <b>compute.platform</b> parameter value.	<b>alibabacloud, aws, azure, gcp, ibmcloud, openstack, ovirt, vsphere</b> , or <b>{}</b>
<b>controlPlane.replicas</b>	The number of control plane machines to provision.	The only supported value is <b>3</b> , which is the default value.
<b>credentialsMode</b>	<p>The Cloud Credential Operator (CCO) mode. If no mode is specified, the CCO dynamically tries to determine the capabilities of the provided credentials, with a preference for mint mode on the platforms where multiple modes are supported.</p> <div data-bbox="485 936 593 1283" style="border: 1px solid black; padding: 5px; margin-bottom: 10px;"> <p><b>NOTE</b></p> <p>Not all CCO modes are supported for all cloud providers. For more information on CCO modes, see the <i>Cloud Credential Operator</i> entry in the <i>Cluster Operators reference</i> content.</p> </div> <div data-bbox="485 1330 593 1677" style="border: 1px solid black; padding: 5px;"> <p><b>NOTE</b></p> <p>If your AWS account has service control policies (SCP) enabled, you must configure the <b>credentialsMode</b> parameter to <b>Mint</b>, <b>Passthrough</b> or <b>Manual</b>.</p> </div>	<b>Mint, Passthrough, Manual</b> or an empty string ( <b>""</b> ).

Parameter	Description	Values
<b>fips</b>	<p>Enable or disable FIPS mode. The default is <b>false</b> (disabled). If FIPS mode is enabled, the Red Hat Enterprise Linux CoreOS (RHCOS) machines that OpenShift Container Platform runs on bypass the default Kubernetes cryptography suite and use the cryptography modules that are provided with RHCOS instead.</p> <div data-bbox="486 584 592 1361" style="background-color: black; color: white; padding: 5px; margin-bottom: 10px;"> <p><b>IMPORTANT</b></p> <p>To enable FIPS mode for your cluster, you must run the installation program from a Red Hat Enterprise Linux (RHEL) computer configured to operate in FIPS mode. For more information about configuring FIPS mode on RHEL, see <a href="#">Installing the system in FIPS mode</a>. The use of FIPS validated or Modules In Process cryptographic libraries is only supported on OpenShift Container Platform deployments on the <b>x86_64</b> architecture.</p> </div> <div data-bbox="486 1406 592 1608" style="background-color: #f0f0f0; padding: 5px;"> <p><b>NOTE</b></p> <p>If you are using Azure File storage, you cannot enable FIPS mode.</p> </div>	<b>false</b> or <b>true</b>

Parameter	Description	Values
<b>imageContentSources</b>	Sources and repositories for the release-image content.	Array of objects. Includes a <b>source</b> and, optionally, <b>mirrors</b> , as described in the following rows of this table.
<b>imageContentSources.source</b>	Required if you use <b>imageContentSources</b> . Specify the repository that users refer to, for example, in image pull specifications.	String
<b>imageContentSources.mirrors</b>	Specify one or more repositories that may also contain the same images.	Array of strings
<b>publish</b>	How to publish or expose the user-facing endpoints of your cluster, such as the Kubernetes API, OpenShift routes.	<p><b>Internal</b> or <b>External</b>. The default value is <b>External</b>.</p> <p>Setting this field to <b>Internal</b> is not supported on non-cloud platforms and IBM Cloud VPC.</p> <div style="display: flex; align-items: flex-start;">  <div> <p><b>IMPORTANT</b></p> <p>If the value of the field is set to <b>Internal</b>, the cluster will become non-functional. For more information, refer to <a href="#">BZ#1953035</a>.</p> </div> </div>
<b>sshKey</b>	<p>The SSH key or keys to authenticate access your cluster machines.</p> <div style="display: flex; align-items: flex-start;">  <div> <p><b>NOTE</b></p> <p>For production OpenShift Container Platform clusters on which you want to perform installation debugging or disaster recovery, specify an SSH key that your <b>ssh-agent</b> process uses.</p> </div> </div>	<p>One or more keys. For example:</p> <pre>sshKey:   &lt;key1&gt;   &lt;key2&gt;   &lt;key3&gt;</pre>

#### 18.4.9.4. Custom subnets in RHOSP deployments

Optionally, you can deploy a cluster on a Red Hat OpenStack Platform (RHOSP) subnet of your choice. The subnet's GUID is passed as the value of **platform.openstack.machinesSubnet** in the **install-config.yaml** file.

This subnet is used as the cluster's primary subnet. By default, nodes and ports are created on it. You can create nodes and ports on a different RHOSP subnet by setting the value of the **platform.openstack.machinesSubnet** property to the subnet's UUID.

Before you run the OpenShift Container Platform installer with a custom subnet, verify that your configuration meets the following requirements:

- The subnet that is used by **platform.openstack.machinesSubnet** has DHCP enabled.
- The CIDR of **platform.openstack.machinesSubnet** matches the CIDR of **networking.machineNetwork**.
- The installation program user has permission to create ports on this network, including ports with fixed IP addresses.

Clusters that use custom subnets have the following limitations:

- If you plan to install a cluster that uses floating IP addresses, the **platform.openstack.machinesSubnet** subnet must be attached to a router that is connected to the **externalNetwork** network.
- If the **platform.openstack.machinesSubnet** value is set in the **install-config.yaml** file, the installation program does not create a private network or subnet for your RHOSP machines.
- You cannot use the **platform.openstack.externalDNS** property at the same time as a custom subnet. To add DNS to a cluster that uses a custom subnet, configure DNS on the RHOSP network.



#### NOTE

By default, the API VIP takes x.x.x.5 and the Ingress VIP takes x.x.x.7 from your network's CIDR block. To override these default values, set values for **platform.openstack.apiVIP** and **platform.openstack.ingressVIP** that are outside of the DHCP allocation pool.

#### 18.4.9.5. Deploying a cluster with bare metal machines

If you want your cluster to use bare metal machines, modify the **inventory.yaml** file. Your cluster can have both control plane and compute machines running on bare metal, or just compute machines.

Bare-metal compute machines are not supported on clusters that use Kuryr.



#### NOTE

Be sure that your **install-config.yaml** file reflects whether the RHOSP network that you use for bare metal workers supports floating IP addresses or not.

#### Prerequisites

- The RHOSP [Bare Metal service \(Ironic\)](#) is enabled and accessible via the RHOSP Compute API.
- Bare metal is available as a [RHOSP flavor](#).

- The RHOSP network supports both VM and bare metal server attachment.
- Your network configuration does not rely on a provider network. Provider networks are not supported.
- If you want to deploy the machines on a pre-existing network, a RHOSP subnet is provisioned.
- If you want to deploy the machines on an installer-provisioned network, the RHOSP Bare Metal service (Ironic) is able to listen for and interact with Preboot eXecution Environment (PXE) boot machines that run on tenant networks.
- You created an **inventory.yaml** file as part of the OpenShift Container Platform installation process.

## Procedure

1. In the **inventory.yaml** file, edit the flavors for machines:
  - a. If you want to use bare-metal control plane machines, change the value of **os\_flavor\_master** to a bare metal flavor.
  - b. Change the value of **os\_flavor\_worker** to a bare metal flavor.

### An example bare metal inventory.yaml file

```
all:
  hosts:
    localhost:
      ansible_connection: local
      ansible_python_interpreter: "{{ansible_playbook_python}}"

      # User-provided values
      os_subnet_range: '10.0.0.0/16'
      os_flavor_master: 'my-bare-metal-flavor' 1
      os_flavor_worker: 'my-bare-metal-flavor' 2
      os_image_rhcos: 'rhcos'
      os_external_network: 'external'

  ...
```

- 1 If you want to have bare-metal control plane machines, change this value to a bare metal flavor.
- 2 Change this value to a bare metal flavor to use for compute machines.

Use the updated **inventory.yaml** file to complete the installation process. Machines that are created during deployment use the flavor that you added to the file.

**NOTE**

The installer may time out while waiting for bare metal machines to boot.

If the installer times out, restart and then complete the deployment by using the **wait-for** command of the installer. For example:

```
$. /openshift-install wait-for install-complete --log-level debug
```

**18.4.9.6. Sample customized install-config.yaml file for RHOSP**

This sample **install-config.yaml** demonstrates all of the possible Red Hat OpenStack Platform (RHOSP) customization options.

**IMPORTANT**

This sample file is provided for reference only. You must obtain your **install-config.yaml** file by using the installation program.

```
apiVersion: v1
baseDomain: example.com
controlPlane:
  name: master
  platform: {}
  replicas: 3
compute:
- name: worker
  platform:
    openstack:
      type: m1.large
  replicas: 3
metadata:
  name: example
networking:
  clusterNetwork:
  - cidr: 10.128.0.0/14
    hostPrefix: 23
  machineNetwork:
  - cidr: 10.0.0.0/16
  serviceNetwork:
  - 172.30.0.0/16
  networkType: OpenShiftSDN
platform:
  openstack:
    cloud: mycloud
    externalNetwork: external
    computeFlavor: m1.xlarge
    apiFloatingIP: 128.0.0.1
fips: false
pullSecret: '{"auths": ...}'
sshKey: ssh-ed25519 AAAA...
```

**18.4.10. Generating a key pair for cluster node SSH access**

During an OpenShift Container Platform installation, you can provide an SSH public key to the installation program. The key is passed to the Red Hat Enterprise Linux CoreOS (RHCOS) nodes through their Ignition config files and is used to authenticate SSH access to the nodes. The key is added to the `~/.ssh/authorized_keys` list for the **core** user on each node, which enables password-less authentication.

After the key is passed to the nodes, you can use the key pair to SSH in to the RHCOS nodes as the user **core**. To access the nodes through SSH, the private key identity must be managed by SSH for your local user.

If you want to SSH in to your cluster nodes to perform installation debugging or disaster recovery, you must provide the SSH public key during the installation process. The `./openshift-install gather` command also requires the SSH public key to be in place on the cluster nodes.



### IMPORTANT

Do not skip this procedure in production environments, where disaster recovery and debugging is required.



### NOTE

You must use a local key, not one that you configured with platform-specific approaches such as [AWS key pairs](#).

## Procedure

1. If you do not have an existing SSH key pair on your local machine to use for authentication onto your cluster nodes, create one. For example, on a computer that uses a Linux operating system, run the following command:

```
$ ssh-keygen -t ed25519 -N "" -f <path>/<file_name> 1
```

- 1 Specify the path and file name, such as `~/.ssh/id_ed25519`, of the new SSH key. If you have an existing key pair, ensure your public key is in the your `~/.ssh` directory.

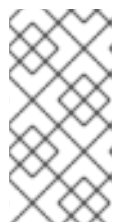

### NOTE

If you plan to install an OpenShift Container Platform cluster that uses FIPS validated or Modules In Process cryptographic libraries on the **x86\_64** architecture, do not create a key that uses the **ed25519** algorithm. Instead, create a key that uses the **rsa** or **ecdsa** algorithm.

2. View the public SSH key:

```
$ cat <path>/<file_name>.pub
```

For example, run the following to view the `~/.ssh/id_ed25519.pub` public key:

```
$ cat ~/.ssh/id_ed25519.pub
```

3. Add the SSH private key identity to the SSH agent for your local user, if it has not already been added. SSH agent management of the key is required for password-less SSH authentication onto your cluster nodes, or if you want to use the `./openshift-install gather` command.

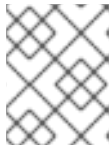
**NOTE**

On some distributions, default SSH private key identities such as `~/.ssh/id_rsa` and `~/.ssh/id_dsa` are managed automatically.

- a. If the **ssh-agent** process is not already running for your local user, start it as a background task:

```
$ eval "$(ssh-agent -s)"
```

**Example output**

```
Agent pid 31874
```

**NOTE**

If your cluster is in FIPS mode, only use FIPS-compliant algorithms to generate the SSH key. The key must be either RSA or ECDSA.

4. Add your SSH private key to the **ssh-agent**:

```
$ ssh-add <path>/<file_name> 1
```

- 1** Specify the path and file name for your SSH private key, such as `~/.ssh/id_ed25519`

**Example output**

```
Identity added: /home/<you>/<path>/<file_name> (<computer_name>)
```

**Next steps**

- When you install OpenShift Container Platform, provide the SSH public key to the installation program.

**18.4.11. Enabling access to the environment**

At deployment, all OpenShift Container Platform machines are created in a Red Hat OpenStack Platform (RHOSP)-tenant network. Therefore, they are not accessible directly in most RHOSP deployments.

You can configure OpenShift Container Platform API and application access by using floating IP addresses (FIPs) during installation. You can also complete an installation without configuring FIPs, but the installer will not configure a way to reach the API or applications externally.

**18.4.11.1. Enabling access with floating IP addresses**



Create floating IP (FIP) addresses for external access to the OpenShift Container Platform API and cluster applications.

## Procedure

1. Using the Red Hat OpenStack Platform (RHOSP) CLI, create the API FIP:

```
$ openstack floating ip create --description "API <cluster_name>.<base_domain>"
<external_network>
```

2. Using the Red Hat OpenStack Platform (RHOSP) CLI, create the apps, or Ingress, FIP:

```
$ openstack floating ip create --description "Ingress <cluster_name>.<base_domain>"
<external_network>
```

3. Add records that follow these patterns to your DNS server for the API and Ingress FIPs:

```
api.<cluster_name>.<base_domain>. IN A <API_FIP>
*.apps.<cluster_name>.<base_domain>. IN A <apps_FIP>
```

## NOTE

If you do not control the DNS server, you can access the cluster by adding the cluster domain names such as the following to your **/etc/hosts** file:

- **<api\_floating\_ip> api.<cluster\_name>.<base\_domain>**
- **<application\_floating\_ip> grafana-openshift-monitoring.apps.<cluster\_name>.<base\_domain>**
- **<application\_floating\_ip> prometheus-k8s-openshift-monitoring.apps.<cluster\_name>.<base\_domain>**
- **<application\_floating\_ip> oauth-openshift.apps.<cluster\_name>.<base\_domain>**
- **<application\_floating\_ip> console-openshift-console.apps.<cluster\_name>.<base\_domain>**
- **application\_floating\_ip integrated-oauth-server-openshift-authentication.apps.<cluster\_name>.<base\_domain>**

The cluster domain names in the **/etc/hosts** file grant access to the web console and the monitoring interface of your cluster locally. You can also use the **kubectl** or **oc**. You can access the user applications by using the additional entries pointing to the **<application\_floating\_ip>**. This action makes the API and applications accessible to only you, which is not suitable for production deployment, but does allow installation for development and testing.

4. Add the FIPs to the **install-config.yaml** file as the values of the following parameters:

- **platform.openstack.ingressFloatingIP**
- **platform.openstack.apiFloatingIP**

If you use these values, you must also enter an external network as the value of the `platform.openstack.externalNetwork` parameter in the `install-config.yaml` file.

## TIP

You can make OpenShift Container Platform resources available outside of the cluster by assigning a floating IP address and updating your firewall configuration.

### 18.4.11.2. Completing installation without floating IP addresses

You can install OpenShift Container Platform on Red Hat OpenStack Platform (RHOSP) without providing floating IP addresses.

In the file, do not define the following

If you run the installer from a system that cannot reach the cluster API due to a lack of floating IP addresses or name resolution, installation fails. To prevent installation failure in these cases, you can use a proxy network or run the installer from a system that is on the same network as your machines.



## NOTE

You can enable name resolution by creating DNS records for the API and Ingress ports. For example:

```
api.<cluster_name>.<base_domain>. IN A <api_port_IP>
*.apps.<cluster_name>.<base_domain>. IN A <ingress_port_IP>
```

If you do not control the DNS server, you can add the record to your `/etc/hosts` file. This action makes the API accessible to only you, which is not suitable for production deployment but does allow installation for development and testing.

### 18.4.12. Creating SR-IOV networks for compute machines

If your Red Hat OpenStack Platform (RHOSP) deployment supports [single root I/O virtualization \(SR-IOV\)](#), you can provision SR-IOV networks that compute machines run on.



## NOTE

The following instructions entail creating an external flat network and an external, VLAN-based network that can be attached to a compute machine. Depending on your RHOSP deployment, other network types might be required.

## Prerequisites

- Your cluster supports SR-IOV.



## NOTE

If you are unsure about what your cluster supports, review the OpenShift Container Platform SR-IOV hardware networks documentation.

- You created radio and uplink provider networks as part of your RHOSP deployment. The names **radio** and **uplink** are used in all example commands to represent these networks.

## Procedure

1. On a command line, create a radio RHOSP network:

```
$ openstack network create radio --provider-physical-network radio --provider-network-type flat --external
```

2. Create an uplink RHOSP network:

```
$ openstack network create uplink --provider-physical-network uplink --provider-network-type vlan --external
```

3. Create a subnet for the radio network:

```
$ openstack subnet create --network radio --subnet-range <radio_network_subnet_range> radio
```

4. Create a subnet for the uplink network:

```
$ openstack subnet create --network uplink --subnet-range <uplink_network_subnet_range> uplink
```

### 18.4.13. Deploying the cluster

You can install OpenShift Container Platform on a compatible cloud platform.



#### IMPORTANT

You can run the **create cluster** command of the installation program only once, during initial installation.

## Prerequisites

- Obtain the OpenShift Container Platform installation program and the pull secret for your cluster.

## Procedure

1. Change to the directory that contains the installation program and initialize the cluster deployment:

```
$ ./openshift-install create cluster --dir <installation_directory> \ 1  
--log-level=info 2
```

- 1** For **<installation\_directory>**, specify the location of your customized **./install-config.yaml** file.
- 2** To view different installation details, specify **warn**, **debug**, or **error** instead of **info**.

**NOTE**

If the cloud provider account that you configured on your host does not have sufficient permissions to deploy the cluster, the installation process stops, and the missing permissions are displayed.

When the cluster deployment completes, directions for accessing your cluster, including a link to its web console and credentials for the **kubeadmin** user, display in your terminal.

**Example output**

```
...
INFO Install complete!
INFO To access the cluster as the system:admin user when using 'oc', run 'export
KUBECONFIG=/home/myuser/install_dir/auth/kubeconfig'
INFO Access the OpenShift web-console here: https://console-openshift-
console.apps.mycluster.example.com
INFO Login to the console with user: "kubeadmin", and password: "4vYBz-Ee6gm-ymBZj-
Wt5AL"
INFO Time elapsed: 36m22s
```

**NOTE**

The cluster access and credential information also outputs to **<installation\_directory>/openshift\_install.log** when an installation succeeds.

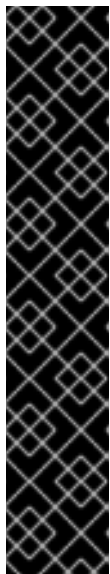
**IMPORTANT**

- The Ignition config files that the installation program generates contain certificates that expire after 24 hours, which are then renewed at that time. If the cluster is shut down before renewing the certificates and the cluster is later restarted after the 24 hours have elapsed, the cluster automatically recovers the expired certificates. The exception is that you must manually approve the pending **node-bootstrapper** certificate signing requests (CSRs) to recover kubelet certificates. See the documentation for *Recovering from expired control plane certificates* for more information.
- It is recommended that you use Ignition config files within 12 hours after they are generated because the 24-hour certificate rotates from 16 to 22 hours after the cluster is installed. By using the Ignition config files within 12 hours, you can avoid installation failure if the certificate update runs during installation.

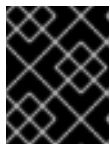
**IMPORTANT**

You must not delete the installation program or the files that the installation program creates. Both are required to delete the cluster.

**18.4.14. Verifying cluster status**

You can verify your OpenShift Container Platform cluster's status during or after installation.

**Procedure**

1. In the cluster environment, export the administrator's kubeconfig file:

```
$ export KUBECONFIG=<installation_directory>/auth/kubeconfig 1
```

- 1 For **<installation\_directory>**, specify the path to the directory that you stored the installation files in.

The **kubeconfig** file contains information about the cluster that is used by the CLI to connect a client to the correct cluster and API server.

2. View the control plane and compute machines created after a deployment:

```
$ oc get nodes
```

3. View your cluster's version:

```
$ oc get clusterversion
```

4. View your Operators' status:

```
$ oc get clusteroperator
```

5. View all running pods in the cluster:

```
$ oc get pods -A
```

### 18.4.15. Logging in to the cluster by using the CLI

You can log in to your cluster as a default system user by exporting the cluster **kubeconfig** file. The **kubeconfig** file contains information about the cluster that is used by the CLI to connect a client to the correct cluster and API server. The file is specific to a cluster and is created during OpenShift Container Platform installation.

#### Prerequisites

- You deployed an OpenShift Container Platform cluster.
- You installed the **oc** CLI.

#### Procedure

1. Export the **kubeadmin** credentials:

```
$ export KUBECONFIG=<installation_directory>/auth/kubeconfig 1
```

- 1 For **<installation\_directory>**, specify the path to the directory that you stored the installation files in.

2. Verify you can run **oc** commands successfully using the exported configuration:

```
$ oc whoami
```

## Example output

```
system:admin
```

The cluster is operational. Before you can add SR-IOV compute machines though, you must perform additional tasks.

### 18.4.16. Preparing a cluster that runs on RHOSP for SR-IOV

Before you use [single root I/O virtualization \(SR-IOV\)](#) on a cluster that runs on Red Hat OpenStack Platform (RHOSP), make the RHOSP metadata service mountable as a drive and enable the No-IOMMU Operator for the virtual function I/O (VFIO) driver.

#### 18.4.16.1. Enabling the RHOSP metadata service as a mountable drive

You can apply a machine config to your machine pool that makes the Red Hat OpenStack Platform (RHOSP) metadata service available as a mountable drive.

The following machine config enables the display of RHOSP network UUIDs from within the SR-IOV Network Operator. This configuration simplifies the association of SR-IOV resources to cluster SR-IOV resources.

#### Procedure

1. Create a machine config file from the following template:

#### A mountable metadata service machine config file

```

kind: MachineConfig
apiVersion: machineconfiguration.openshift.io/v1
metadata:
  name: 20-mount-config 1
  labels:
    machineconfiguration.openshift.io/role: worker
spec:
  config:
    ignition:
      version: 3.2.0
    systemd:
      units:
        - name: create-mountpoint-var-config.service
          enabled: true
          contents: |
            [Unit]
            Description=Create mountpoint /var/config
            Before=kubelet.service

            [Service]
            ExecStart=/bin/mkdir -p /var/config

            [Install]
            WantedBy=var-config.mount
        - name: var-config.mount

```

```

enabled: true
contents: |
[Unit]
Before=local-fs.target
[Mount]
Where=/var/config
What=/dev/disk/by-label/config-2
[Install]
WantedBy=local-fs.target

```

1 You can substitute a name of your choice.

2. From a command line, apply the machine config:

```
$ oc apply -f <machine_config_file_name>.yaml
```

### 18.4.16.2. Enabling the No-IOMMU feature for the RHOSP VFIO driver

You can apply a machine config to your machine pool that enables the No-IOMMU feature for the Red Hat OpenStack Platform (RHOSP) virtual function I/O (VFIO) driver. The RHOSP vfio-pci driver requires this feature.

#### Procedure

1. Create a machine config file from the following template:

#### A No-IOMMU VFIO machine config file

```

kind: MachineConfig
apiVersion: machineconfiguration.openshift.io/v1
metadata:
  name: 99-vfio-noiommu 1
  labels:
    machineconfiguration.openshift.io/role: worker
spec:
  config:
    ignition:
      version: 3.2.0
    storage:
      files:
        - path: /etc/modprobe.d/vfio-noiommu.conf
          mode: 0644
          contents:
            source:
              data:;base64,b3B0aW9ucyB2ZmlvIGVuYWJsZV91bnNhZmVfbm9pb21tdV9tb2RIPTEK

```

1 You can substitute a name of your choice.

2. From a command line, apply the machine config:

```
$ oc apply -f <machine_config_file_name>.yaml
```

The cluster is installed and prepared for SR-IOV configuration. Complete the post-installation SR-IOV tasks that are listed in the "Next steps" section.

### 18.4.17. Telemetry access for OpenShift Container Platform

In OpenShift Container Platform 4.10, the Telemetry service, which runs by default to provide metrics about cluster health and the success of updates, requires internet access. If your cluster is connected to the internet, Telemetry runs automatically, and your cluster is registered to [OpenShift Cluster Manager](#).

After you confirm that your [OpenShift Cluster Manager](#) inventory is correct, either maintained automatically by Telemetry or manually by using OpenShift Cluster Manager, [use subscription watch](#) to track your OpenShift Container Platform subscriptions at the account or multi-cluster level.

#### Additional resources

- See [About remote health monitoring](#) for more information about the Telemetry service

### 18.4.18. Next steps

- To complete SR-IOV configuration for your cluster:
  - [Install the Performance Addon Operator](#).
  - [Configure the Performance Addon Operator with huge pages support](#).
  - [Install the SR-IOV Operator](#).
  - [Configure your SR-IOV network device](#).
  - [Add an SR-IOV compute machine set](#).
- [Customize your cluster](#).
- If necessary, you can [opt out of remote health reporting](#).
- If you need to enable external access to node ports, [configure ingress cluster traffic by using a node port](#).
- If you did not configure RHOSP to accept application traffic over floating IP addresses, [configure RHOSP access with floating IP addresses](#).

## 18.5. INSTALLING A CLUSTER ON OPENSTACK THAT SUPPORTS OVS-DPDK-CONNECTED COMPUTE MACHINES

If your Red Hat OpenStack Platform (RHOSP) deployment has Open vSwitch with the Data Plane Development Kit (OVS-DPDK) enabled, you can install an OpenShift Container Platform cluster on it. Clusters that run on such RHOSP deployments use OVS-DPDK features by providing access to [poll mode drivers](#).

### 18.5.1. Prerequisites

- Review details about the [OpenShift Container Platform installation and update](#) processes.
  - Verify that OpenShift Container Platform 4.10 is compatible with your RHOSP version by using the "Supported platforms for OpenShift clusters" section. You can also compare



platform support across different versions by viewing the [OpenShift Container Platform on RHOSP support matrix](#).

- You have a storage service installed in RHOSP, such as block storage (Cinder) or object storage (Swift). Object storage is the recommended storage technology for OpenShift Container Platform registry cluster deployment. For more information, see [Optimizing storage](#).
- Have the metadata service enabled in RHOSP.
- Plan your RHOSP OVS-DPDK deployment by referring to [Planning your OVS-DPDK deployment](#) in the Network Functions Virtualization Planning and Configuration Guide.
- Configure your RHOSP OVS-DPDK deployment according to [Configuring an OVS-DPDK deployment](#) in the Network Functions Virtualization Planning and Configuration Guide.
  - You must complete [Creating a flavor and deploying an instance for OVS-DPDK](#) before you install a cluster on RHOSP.

### 18.5.2. Resource guidelines for installing OpenShift Container Platform on RHOSP

To support an OpenShift Container Platform installation, your Red Hat OpenStack Platform (RHOSP) quota must meet the following requirements:

**Table 18.17. Recommended resources for a default OpenShift Container Platform cluster on RHOSP**

Resource	Value
Floating IP addresses	3
Ports	15
Routers	1
Subnets	1
RAM	88 GB
vCPUs	22
Volume storage	275 GB
Instances	7
Security groups	3
Security group rules	60
Server groups	2 - plus 1 for each additional availability zone in each machine pool

A cluster might function with fewer than recommended resources, but its performance is not guaranteed.



### IMPORTANT

If RHOSP object storage (Swift) is available and operated by a user account with the **swiftoperator** role, it is used as the default backend for the OpenShift Container Platform image registry. In this case, the volume storage requirement is 175 GB. Swift space requirements vary depending on the size of the image registry.



### NOTE

By default, your security group and security group rule quotas might be low. If you encounter problems, run **openstack quota set --secgroups 3 --secgroup-rules 60 <project>** as an administrator to increase them.

An OpenShift Container Platform deployment comprises control plane machines, compute machines, and a bootstrap machine.

#### 18.5.2.1. Control plane machines

By default, the OpenShift Container Platform installation process creates three control plane machines.

Each machine requires:

- An instance from the RHOSP quota
- A port from the RHOSP quota
- A flavor with at least 16 GB memory and 4 vCPUs
- At least 100 GB storage space from the RHOSP quota

#### 18.5.2.2. Compute machines

By default, the OpenShift Container Platform installation process creates three compute machines.

Each machine requires:

- An instance from the RHOSP quota
- A port from the RHOSP quota
- A flavor with at least 8 GB memory and 2 vCPUs
- At least 100 GB storage space from the RHOSP quota

### TIP

Compute machines host the applications that you run on OpenShift Container Platform; aim to run as many as you can.

Additionally, for clusters that use single-root input/output virtualization (SR-IOV), RHOSP compute nodes require a flavor that supports [huge pages](#).

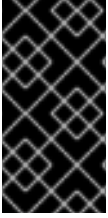

## IMPORTANT

SR-IOV deployments often employ performance optimizations, such as dedicated or isolated CPUs. For maximum performance, configure your underlying RHOSP deployment to use these optimizations, and then run OpenShift Container Platform compute machines on the optimized infrastructure.

### Additional resources

- For more information about configuring performant RHOSP compute nodes, see [Configuring Compute nodes for performance](#).

### 18.5.2.3. Bootstrap machine

During installation, a bootstrap machine is temporarily provisioned to stand up the control plane. After the production control plane is ready, the bootstrap machine is deprovisioned.

The bootstrap machine requires:

- An instance from the RHOSP quota
- A port from the RHOSP quota
- A flavor with at least 16 GB memory and 4 vCPUs
- At least 100 GB storage space from the RHOSP quota

### 18.5.3. Internet access for OpenShift Container Platform

In OpenShift Container Platform 4.10, you require access to the internet to install your cluster.

You must have internet access to:

- Access [OpenShift Cluster Manager](#) to download the installation program and perform subscription management. If the cluster has internet access and you do not disable Telemetry, that service automatically entitles your cluster.
- Access [Quay.io](#) to obtain the packages that are required to install your cluster.
- Obtain the packages that are required to perform cluster updates.



## IMPORTANT

If your cluster cannot have direct internet access, you can perform a restricted network installation on some types of infrastructure that you provision. During that process, you download the required content and use it to populate a mirror registry with the installation packages. With some installation types, the environment that you install your cluster in will not require internet access. Before you update the cluster, you update the content of the mirror registry.

### 18.5.4. Enabling Swift on RHOSP

Swift is operated by a user account with the **swiftoperator** role. Add the role to an account before you run the installation program.

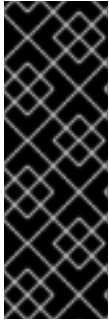

## IMPORTANT

If the [Red Hat OpenStack Platform \(RHOSP\) object storage service](#), commonly known as Swift, is available, OpenShift Container Platform uses it as the image registry storage. If it is unavailable, the installation program relies on the RHOSP block storage service, commonly known as Cinder.

If Swift is present and you want to use it, you must enable access to it. If it is not present, or if you do not want to use it, skip this section.

### Prerequisites

- You have a RHOSP administrator account on the target environment.
- The Swift service is installed.
- On [Ceph RGW](#), the **account in url** option is enabled.

### Procedure

To enable Swift on RHOSP:

1. As an administrator in the RHOSP CLI, add the **swiftoperator** role to the account that will access Swift:

```
$ openstack role add --user <user> --project <project> swiftoperator
```

Your RHOSP deployment can now use Swift for the image registry.

## 18.5.5. Verifying external network access

The OpenShift Container Platform installation process requires external network access. You must provide an external network value to it, or deployment fails. Before you begin the process, verify that a network with the external router type exists in Red Hat OpenStack Platform (RHOSP).

### Prerequisites

- [Configure OpenStack's networking service to have DHCP agents forward instances' DNS queries](#)

### Procedure

1. Using the RHOSP CLI, verify the name and ID of the 'External' network:

```
$ openstack network list --long -c ID -c Name -c "Router Type"
```

### Example output

```
+-----+-----+-----+
| ID                | Name          | Router Type |
+-----+-----+-----+
| 148a8023-62a7-4672-b018-003462f8d7dc | public_network | External    |
+-----+-----+-----+
```

A network with an external router type appears in the network list. If at least one does not, see [Creating a default floating IP network](#) and [Creating a default provider network](#).



## NOTE

If the Neutron trunk service plugin is enabled, a trunk port is created by default. For more information, see [Neutron trunk port](#).

### 18.5.6. Defining parameters for the installation program

The OpenShift Container Platform installation program relies on a file that is called **clouds.yaml**. The file describes Red Hat OpenStack Platform (RHOSP) configuration parameters, including the project name, log in information, and authorization service URLs.

#### Procedure

1. Create the **clouds.yaml** file:

- If your RHOSP distribution includes the Horizon web UI, generate a **clouds.yaml** file in it.



## IMPORTANT

Remember to add a password to the **auth** field. You can also keep secrets in [a separate file](#) from **clouds.yaml**.

- If your RHOSP distribution does not include the Horizon web UI, or you do not want to use Horizon, create the file yourself. For detailed information about **clouds.yaml**, see [Config files](#) in the RHOSP documentation.

```
clouds:
  shiftstack:
    auth:
      auth_url: http://10.10.14.42:5000/v3
      project_name: shiftstack
      username: <username>
      password: <password>
      user_domain_name: Default
      project_domain_name: Default
  dev-env:
    region_name: RegionOne
    auth:
      username: <username>
      password: <password>
      project_name: 'devonly'
      auth_url: 'https://10.10.14.22:5001/v2.0'
```

2. If your RHOSP installation uses self-signed certificate authority (CA) certificates for endpoint authentication:
  - a. Copy the certificate authority file to your machine.
  - b. Add the **cacerts** key to the **clouds.yaml** file. The value must be an absolute, non-root-accessible path to the CA certificate:

```
clouds:
  shiftstack:
    ...
  cacert: "/etc/pki/ca-trust/source/anchors/ca.crt.pem"
```

**TIP**

After you run the installer with a custom CA certificate, you can update the certificate by editing the value of the **ca-cert.pem** key in the **cloud-provider-config** keymap. On a command line, run:

```
$ oc edit configmap -n openshift-config cloud-provider-config
```

3. Place the **clouds.yaml** file in one of the following locations:
  - a. The value of the **OS\_CLIENT\_CONFIG\_FILE** environment variable
  - b. The current directory
  - c. A Unix-specific user configuration directory, for example **~/.config/openstack/clouds.yaml**
  - d. A Unix-specific site configuration directory, for example **/etc/openstack/clouds.yaml**
 The installation program searches for **clouds.yaml** in that order.

**18.5.7. Obtaining the installation program**

Before you install OpenShift Container Platform, download the installation file on a local computer.

**Prerequisites**

- You have a computer that runs Linux or macOS, with 500 MB of local disk space

**Procedure**

1. Access the [Infrastructure Provider](#) page on the OpenShift Cluster Manager site. If you have a Red Hat account, log in with your credentials. If you do not, create an account.
2. Select your infrastructure provider.
3. Navigate to the page for your installation type, download the installation program that corresponds with your host operating system and architecture, and place the file in the directory where you will store the installation configuration files.

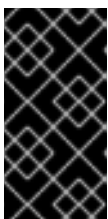
**IMPORTANT**

The installation program creates several files on the computer that you use to install your cluster. You must keep the installation program and the files that the installation program creates after you finish installing the cluster. Both files are required to delete the cluster.

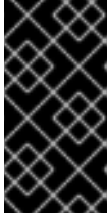

## IMPORTANT

Deleting the files created by the installation program does not remove your cluster, even if the cluster failed during installation. To remove your cluster, complete the OpenShift Container Platform uninstallation procedures for your specific cloud provider.

4. Extract the installation program. For example, on a computer that uses a Linux operating system, run the following command:

```
$ tar -xvf openshift-install-linux.tar.gz
```

5. Download your installation [pull secret from the Red Hat OpenShift Cluster Manager](#) . This pull secret allows you to authenticate with the services that are provided by the included authorities, including Quay.io, which serves the container images for OpenShift Container Platform components.

### 18.5.8. Creating the installation configuration file

You can customize the OpenShift Container Platform cluster you install on

#### Prerequisites

- Obtain the OpenShift Container Platform installation program and the pull secret for your cluster.
- Obtain service principal permissions at the subscription level.

#### Procedure

1. Create the **install-config.yaml** file.
  - a. Change to the directory that contains the installation program and run the following command:

```
$ ./openshift-install create install-config --dir <installation_directory> 1
```

- 1** For **<installation\_directory>**, specify the directory name to store the files that the installation program creates.



## IMPORTANT

Specify an empty directory. Some installation assets, like bootstrap X.509 certificates have short expiration intervals, so you must not reuse an installation directory. If you want to reuse individual files from another cluster installation, you can copy them into your directory. However, the file names for the installation assets might change between releases. Use caution when copying installation files from an earlier OpenShift Container Platform version.

- b. At the prompts, provide the configuration details for your cloud:
  - i. Optional: Select an SSH key to use to access your cluster machines.

**NOTE**

For production OpenShift Container Platform clusters on which you want to perform installation debugging or disaster recovery, specify an SSH key that your **ssh-agent** process uses.

- ii. Enter a descriptive name for your cluster.
  - iii. Paste the [pull secret from the Red Hat OpenShift Cluster Manager](#) .
2. Modify the **install-config.yaml** file. You can find more information about the available parameters in the "Installation configuration parameters" section.
  3. Back up the **install-config.yaml** file so that you can use it to install multiple clusters.

**IMPORTANT**

The **install-config.yaml** file is consumed during the installation process. If you want to reuse the file, you must back it up now.

**18.5.8.1. Configuring the cluster-wide proxy during installation**

Production environments can deny direct access to the internet and instead have an HTTP or HTTPS proxy available. You can configure a new OpenShift Container Platform cluster to use a proxy by configuring the proxy settings in the **install-config.yaml** file.

**Prerequisites**

- You have an existing **install-config.yaml** file.
- You reviewed the sites that your cluster requires access to and determined whether any of them need to bypass the proxy. By default, all cluster egress traffic is proxied, including calls to hosting cloud provider APIs. You added sites to the **Proxy** object's **spec.noProxy** field to bypass the proxy if necessary.

**NOTE**

The **Proxy** object **status.noProxy** field is populated with the values of the **networking.machineNetwork[].cidr**, **networking.clusterNetwork[].cidr**, and **networking.serviceNetwork[]** fields from your installation configuration.

For installations on Amazon Web Services (AWS), Google Cloud Platform (GCP), Microsoft Azure, and Red Hat OpenStack Platform (RHOSP), the **Proxy** object **status.noProxy** field is also populated with the instance metadata endpoint (**169.254.169.254**).

**Procedure**

1. Edit your **install-config.yaml** file and add the proxy settings. For example:

```
apiVersion: v1
baseDomain: my.domain.com
proxy:
  httpProxy: http://<username>:<pswd>@<ip>:<port> 1
```



```

httpsProxy: https://<username>:<pswd>@<ip>:<port> 2
noProxy: example.com 3
additionalTrustBundle: | 4
  -----BEGIN CERTIFICATE-----
  <MY_TRUSTED_CA_CERT>
  -----END CERTIFICATE-----
...

```

- 1 A proxy URL to use for creating HTTP connections outside the cluster. The URL scheme must be **http**.
- 2 A proxy URL to use for creating HTTPS connections outside the cluster.
- 3 A comma-separated list of destination domain names, IP addresses, or other network CIDRs to exclude from proxying. Preface a domain with **.** to match subdomains only. For example, **.y.com** matches **x.y.com**, but not **y.com**. Use **\*** to bypass the proxy for all destinations.
- 4 If provided, the installation program generates a config map that is named **user-ca-bundle** in the **openshift-config** namespace that contains one or more additional CA certificates that are required for proxying HTTPS connections. The Cluster Network Operator then creates a **trusted-ca-bundle** config map that merges these contents with the Red Hat Enterprise Linux CoreOS (RHCOS) trust bundle, and this config map is referenced in the **trustedCA** field of the **Proxy** object. The **additionalTrustBundle** field is required unless the proxy's identity certificate is signed by an authority from the RHCOS trust bundle.

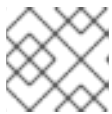

#### NOTE

The installation program does not support the proxy **readinessEndpoints** field.

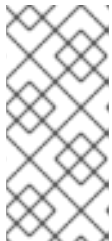

#### NOTE

If the installer times out, restart and then complete the deployment by using the **wait-for** command of the installer. For example:

```
$ ./openshift-install wait-for install-complete --log-level debug
```

2. Save the file and reference it when installing OpenShift Container Platform.

The installation program creates a cluster-wide proxy that is named **cluster** that uses the proxy settings in the provided **install-config.yaml** file. If no proxy settings are provided, a **cluster Proxy** object is still created, but it will have a nil **spec**.



#### NOTE

Only the **Proxy** object named **cluster** is supported, and no additional proxies can be created.

### 18.5.9. Installation configuration parameters

Before you deploy an OpenShift Container Platform cluster, you provide parameter values to describe your account on the cloud platform that hosts your cluster and optionally customize your cluster's

platform. When you create the **install-config.yaml** installation configuration file, you provide values for the required parameters through the command line. If you customize your cluster, you can modify the **install-config.yaml** file to provide more details about the platform.

**NOTE**

After installation, you cannot modify these parameters in the **install-config.yaml** file.

**18.5.9.1. Required configuration parameters**

Required installation configuration parameters are described in the following table:

**Table 18.18. Required parameters**

Parameter	Description	Values
<b>apiVersion</b>	The API version for the <b>install-config.yaml</b> content. The current version is <b>v1</b> . The installer may also support older API versions.	String
<b>baseDomain</b>	The base domain of your cloud provider. The base domain is used to create routes to your OpenShift Container Platform cluster components. The full DNS name for your cluster is a combination of the <b>baseDomain</b> and <b>metadata.name</b> parameter values that uses the <b>&lt;metadata.name&gt;</b> . <b>&lt;baseDomain&gt;</b> format.	A fully-qualified domain or subdomain name, such as <b>example.com</b> .
<b>metadata</b>	Kubernetes resource <b>ObjectMeta</b> , from which only the <b>name</b> parameter is consumed.	Object
<b>metadata.name</b>	The name of the cluster. DNS records for the cluster are all subdomains of <b>{{.metadata.name}}</b> . <b>{{.baseDomain}}</b> .	String of lowercase letters, hyphens (-), and periods (.), such as <b>dev</b> .

Parameter	Description	Values
<b>platform</b>	The configuration for the specific platform upon which to perform the installation: <b>alibabacloud</b> , <b>aws</b> , <b>baremetal</b> , <b>azure</b> , <b>gcp</b> , <b>ibmcloud</b> , <b>openstack</b> , <b>ovirt</b> , <b>vsphere</b> , or <b>{}</b> . For additional information about <b>platform.&lt;platform&gt;</b> parameters, consult the table for your specific platform that follows.	Object
<b>pullSecret</b>	Get a <a href="#">pull secret from the Red Hat OpenShift Cluster Manager</a> to authenticate downloading container images for OpenShift Container Platform components from services such as Quay.io.	<pre>{   "auths":{     "cloud.openshift.com":{       "auth":"b3Blb=",       "email":"you@example.com"     },     "quay.io":{       "auth":"b3Blb=",       "email":"you@example.com"     }   } }</pre>

### 18.5.9.2. Network configuration parameters

You can customize your installation configuration based on the requirements of your existing network infrastructure. For example, you can expand the IP address block for the cluster network or provide different IP address blocks than the defaults.

Only IPv4 addresses are supported.

Table 18.19. Network parameters

Parameter	Description	Values
<b>networking</b>	The configuration for the cluster network.	Object <div style="display: flex; align-items: center; margin-top: 10px;">  <div style="border: 1px solid black; padding: 5px;"> <p><b>NOTE</b></p> <p>You cannot modify parameters specified by the <b>networking</b> object after installation.</p> </div> </div>

Parameter	Description	Values
<b>networking.networkType</b>	The cluster network provider Container Network Interface (CNI) plugin to install.	Either <b>OpenShiftSDN</b> or <b>OVNKubernetes</b> . <b>OpenShiftSDN</b> is a CNI provider for all-Linux networks. <b>OVNKubernetes</b> is a CNI provider for Linux networks and hybrid networks that contain both Linux and Windows servers. The default value is <b>OpenShiftSDN</b> .
<b>networking.clusterNetwork</b>	The IP address blocks for pods.  The default value is <b>10.128.0.0/14</b> with a host prefix of <b>/23</b> .  If you specify multiple IP address blocks, the blocks must not overlap.	An array of objects. For example:  <pre>networking:   clusterNetwork:     - cidr: 10.128.0.0/14       hostPrefix: 23</pre>
<b>networking.clusterNetwork.cidr</b>	Required if you use <b>networking.clusterNetwork</b> . An IP address block.  An IPv4 network.	An IP address block in Classless Inter-Domain Routing (CIDR) notation. The prefix length for an IPv4 block is between <b>0</b> and <b>32</b> .
<b>networking.clusterNetwork.hostPrefix</b>	The subnet prefix length to assign to each individual node. For example, if <b>hostPrefix</b> is set to <b>23</b> then each node is assigned a <b>/23</b> subnet out of the given <b>cidr</b> . A <b>hostPrefix</b> value of <b>23</b> provides 510 ( $2^{(32 - 23)} - 2$ ) pod IP addresses.	A subnet prefix.  The default value is <b>23</b> .
<b>networking.serviceNetwork</b>	The IP address block for services. The default value is <b>172.30.0.0/16</b> .  The OpenShift SDN and OVN-Kubernetes network providers support only a single IP address block for the service network.	An array with an IP address block in CIDR format. For example:  <pre>networking:   serviceNetwork:     - 172.30.0.0/16</pre>
<b>networking.machineNetwork</b>	The IP address blocks for machines.  If you specify multiple IP address blocks, the blocks must not overlap.	An array of objects. For example:  <pre>networking:   machineNetwork:     - cidr: 10.0.0.0/16</pre>

Parameter	Description	Values
<b>networking.machineNetwork.cidr</b>	Required if you use <b>networking.machineNetwork</b> . An IP address block. The default value is <b>10.0.0.0/16</b> for all platforms other than libvirt. For libvirt, the default value is <b>192.168.126.0/24</b> .	<p>An IP network block in CIDR notation.</p> <p>For example, <b>10.0.0.0/16</b>.</p>  <p><b>NOTE</b></p> <p>Set the <b>networking.machineNetwork</b> to match the CIDR that the preferred NIC resides in.</p>

### 18.5.9.3. Optional configuration parameters



Optional installation configuration parameters are described in the following table:

Table 18.20. Optional parameters

Parameter	Description	Values
<b>additionalTrustBundle</b>	A PEM-encoded X.509 certificate bundle that is added to the nodes' trusted certificate store. This trust bundle may also be used when a proxy has been configured.	String
<b>cgroupsV2</b>	Enables <a href="#">Linux control groups version 2</a> (cgroups v2) on specific nodes in your cluster. The OpenShift Container Platform process for enabling cgroups v2 disables all cgroup version 1 controllers and hierarchies. The OpenShift Container Platform cgroups version 2 feature is in Developer Preview and is not supported by Red Hat at this time.	<b>true</b>
<b>compute</b>	The configuration for the machines that comprise the compute nodes.	Array of <b>MachinePool</b> objects.



Parameter	Description	Values
<b>compute.architecture</b>	Determines the instruction set architecture of the machines in the pool. Currently, clusters with varied architectures are not supported. All pools must specify the same architecture. Valid values are <b>amd64</b> (the default).	String
<b>compute.hyperthreading</b>	Whether to enable or disable simultaneous multithreading, or <b>hyperthreading</b> , on compute machines. By default, simultaneous multithreading is enabled to increase the performance of your machines' cores.   <b>IMPORTANT</b> If you disable simultaneous multithreading, ensure that your capacity planning accounts for the dramatically decreased machine performance.	<b>Enabled</b> or <b>Disabled</b>
<b>compute.name</b>	Required if you use <b>compute</b> . The name of the machine pool.	<b>worker</b>
<b>compute.platform</b>	Required if you use <b>compute</b> . Use this parameter to specify the cloud provider to host the worker machines. This parameter value must match the <b>controlPlane.platform</b> parameter value.	<b>alibabacloud, aws, azure, gcp, ibmcloud, openstack, ovirt, vsphere</b> , or <b>{}</b>
<b>compute.replicas</b>	The number of compute machines, which are also known as worker machines, to provision.	A positive integer greater than or equal to <b>2</b> . The default value is <b>3</b> .
<b>controlPlane</b>	The configuration for the machines that comprise the control plane.	Array of <b>MachinePool</b> objects.

Parameter	Description	Values
<b>controlPlane.architecture</b>	Determines the instruction set architecture of the machines in the pool. Currently, clusters with varied architectures are not supported. All pools must specify the same architecture. Valid values are <b>amd64</b> (the default).	String
<b>controlPlane.hypertreading</b>	Whether to enable or disable simultaneous multithreading, or <b>hyperthreading</b> , on control plane machines. By default, simultaneous multithreading is enabled to increase the performance of your machines' cores.   <b>IMPORTANT</b>  If you disable simultaneous multithreading, ensure that your capacity planning accounts for the dramatically decreased machine performance.	<b>Enabled</b> or <b>Disabled</b>
<b>controlPlane.name</b>	Required if you use <b>controlPlane</b> . The name of the machine pool.	<b>master</b>
<b>controlPlane.platform</b>	Required if you use <b>controlPlane</b> . Use this parameter to specify the cloud provider that hosts the control plane machines. This parameter value must match the <b>compute.platform</b> parameter value.	<b>alibabacloud, aws, azure, gcp, ibmcloud, openstack, ovirt, vsphere, or {}</b>
<b>controlPlane.replicas</b>	The number of control plane machines to provision.	The only supported value is <b>3</b> , which is the default value.

Parameter	Description	Values
<b>credentialsMode</b>	<p>The Cloud Credential Operator (CCO) mode. If no mode is specified, the CCO dynamically tries to determine the capabilities of the provided credentials, with a preference for mint mode on the platforms where multiple modes are supported.</p> <p> <b>NOTE</b></p> <p>Not all CCO modes are supported for all cloud providers. For more information on CCO modes, see the <i>Cloud Credential Operator</i> entry in the <i>Cluster Operators reference content</i>.</p> <p> <b>NOTE</b></p> <p>If your AWS account has service control policies (SCP) enabled, you must configure the <b>credentialsMode</b> parameter to <b>Mint</b>, <b>Passthrough</b> or <b>Manual</b>.</p>	<b>Mint, Passthrough, Manual</b> or an empty string ("").



Parameter	Description	Values
<b>fips</b>	<p>Enable or disable FIPS mode. The default is <b>false</b> (disabled). If FIPS mode is enabled, the Red Hat Enterprise Linux CoreOS (RHCOS) machines that OpenShift Container Platform runs on bypass the default Kubernetes cryptography suite and use the cryptography modules that are provided with RHCOS instead.</p> <div style="display: flex; align-items: flex-start;"> <div style="width: 20px; height: 100px; background: repeating-linear-gradient(45deg, transparent, transparent 2px, black 2px, black 4px); margin-right: 10px;"></div> <div> <p><b>IMPORTANT</b></p> <p>To enable FIPS mode for your cluster, you must run the installation program from a Red Hat Enterprise Linux (RHEL) computer configured to operate in FIPS mode. For more information about configuring FIPS mode on RHEL, see <a href="#">Installing the system in FIPS mode</a>. The use of FIPS validated or Modules In Process cryptographic libraries is only supported on OpenShift Container Platform deployments on the <b>x86_64</b> architecture.</p> </div> </div> <div style="display: flex; align-items: flex-start; margin-top: 20px;"> <div style="width: 20px; height: 50px; background: repeating-linear-gradient(45deg, transparent, transparent 2px, black 2px, black 4px); margin-right: 10px;"></div> <div> <p><b>NOTE</b></p> <p>If you are using Azure File storage, you cannot enable FIPS mode.</p> </div> </div>	<b>false</b> or <b>true</b>
<b>imageContentSources</b>	Sources and repositories for the release-image content.	Array of objects. Includes a <b>source</b> and, optionally, <b>mirrors</b> , as described in the following rows of this table.
<b>imageContentSources.source</b>	Required if you use <b>imageContentSources</b> . Specify the repository that users refer to, for example, in image pull specifications.	String
<b>imageContentSources.mirrors</b>	Specify one or more repositories that may also contain the same images.	Array of strings

Parameter	Description	Values
<b>publish</b>	How to publish or expose the user-facing endpoints of your cluster, such as the Kubernetes API, OpenShift routes.	<p><b>Internal</b> or <b>External</b>. The default value is <b>External</b>.</p> <p>Setting this field to <b>Internal</b> is not supported on non-cloud platforms and IBM Cloud VPC.</p> <div style="display: flex; align-items: flex-start;">  <p><b>IMPORTANT</b></p> <p>If the value of the field is set to <b>Internal</b>, the cluster will become non-functional. For more information, refer to <a href="#">BZ#1953035</a>.</p> </div>
<b>sshKey</b>	<p>The SSH key or keys to authenticate access your cluster machines.</p> <div style="display: flex; align-items: flex-start;">  <p><b>NOTE</b></p> <p>For production OpenShift Container Platform clusters on which you want to perform installation debugging or disaster recovery, specify an SSH key that your <b>ssh-agent</b> process uses.</p> </div>	<p>One or more keys. For example:</p> <pre>sshKey:   &lt;key1&gt;   &lt;key2&gt;   &lt;key3&gt;</pre>

#### 18.5.9.4. Custom subnets in RHOSP deployments

Optionally, you can deploy a cluster on a Red Hat OpenStack Platform (RHOSP) subnet of your choice. The subnet's GUID is passed as the value of **platform.openstack.machinesSubnet** in the **install-config.yaml** file.

This subnet is used as the cluster's primary subnet. By default, nodes and ports are created on it. You can create nodes and ports on a different RHOSP subnet by setting the value of the **platform.openstack.machinesSubnet** property to the subnet's UUID.

Before you run the OpenShift Container Platform installer with a custom subnet, verify that your configuration meets the following requirements:

- The subnet that is used by **platform.openstack.machinesSubnet** has DHCP enabled.
- The CIDR of **platform.openstack.machinesSubnet** matches the CIDR of **networking.machineNetwork**.
- The installation program user has permission to create ports on this network, including ports with fixed IP addresses.

Clusters that use custom subnets have the following limitations:

- If you plan to install a cluster that uses floating IP addresses, the **platform.openstack.machinesSubnet** subnet must be attached to a router that is connected to the **externalNetwork** network.
- If the **platform.openstack.machinesSubnet** value is set in the **install-config.yaml** file, the installation program does not create a private network or subnet for your RHOSP machines.
- You cannot use the **platform.openstack.externalDNS** property at the same time as a custom subnet. To add DNS to a cluster that uses a custom subnet, configure DNS on the RHOSP network.



#### NOTE

By default, the API VIP takes x.x.x.5 and the Ingress VIP takes x.x.x.7 from your network's CIDR block. To override these default values, set values for **platform.openstack.apiVIP** and **platform.openstack.ingressVIP** that are outside of the DHCP allocation pool.

### 18.5.9.5. Deploying a cluster with bare metal machines

If you want your cluster to use bare metal machines, modify the **inventory.yaml** file. Your cluster can have both control plane and compute machines running on bare metal, or just compute machines.

Bare-metal compute machines are not supported on clusters that use Kuryr.



#### NOTE

Be sure that your **install-config.yaml** file reflects whether the RHOSP network that you use for bare metal workers supports floating IP addresses or not.

#### Prerequisites

- The RHOSP [Bare Metal service \(Ironic\)](#) is enabled and accessible via the RHOSP Compute API.
- Bare metal is available as [a RHOSP flavor](#).
- The RHOSP network supports both VM and bare metal server attachment.
- Your network configuration does not rely on a provider network. Provider networks are not supported.
- If you want to deploy the machines on a pre-existing network, a RHOSP subnet is provisioned.
- If you want to deploy the machines on an installer-provisioned network, the RHOSP Bare Metal service (Ironic) is able to listen for and interact with Preboot eXecution Environment (PXE) boot machines that run on tenant networks.
- You created an **inventory.yaml** file as part of the OpenShift Container Platform installation process.

#### Procedure

1. In the **inventory.yaml** file, edit the flavors for machines:
  - a. If you want to use bare-metal control plane machines, change the value of

**os\_flavor\_master** to a bare metal flavor.

- b. Change the value of **os\_flavor\_worker** to a bare metal flavor.

### An example bare metal inventory.yaml file

```
all:
  hosts:
    localhost:
      ansible_connection: local
      ansible_python_interpreter: "{{ansible_playbook_python}}"

      # User-provided values
      os_subnet_range: '10.0.0.0/16'
      os_flavor_master: 'my-bare-metal-flavor' 1
      os_flavor_worker: 'my-bare-metal-flavor' 2
      os_image_rhcos: 'rhcos'
      os_external_network: 'external'

  ...
```

- 1 If you want to have bare-metal control plane machines, change this value to a bare metal flavor.
- 2 Change this value to a bare metal flavor to use for compute machines.

Use the updated **inventory.yaml** file to complete the installation process. Machines that are created during deployment use the flavor that you added to the file.



#### NOTE

The installer may time out while waiting for bare metal machines to boot.

If the installer times out, restart and then complete the deployment by using the **wait-for** command of the installer. For example:

```
$ ./openshift-install wait-for install-complete --log-level debug
```

#### 18.5.9.6. Sample customized install-config.yaml file for RHOSP

This sample **install-config.yaml** demonstrates all of the possible Red Hat OpenStack Platform (RHOSP) customization options.



#### IMPORTANT

This sample file is provided for reference only. You must obtain your **install-config.yaml** file by using the installation program.

```
apiVersion: v1
baseDomain: example.com
controlPlane:
  name: master
  platform: {}
```

```

  replicas: 3
compute:
- name: worker
  platform:
    openstack:
      type: m1.large
  replicas: 3
metadata:
  name: example
networking:
  clusterNetwork:
  - cidr: 10.128.0.0/14
    hostPrefix: 23
  machineNetwork:
  - cidr: 10.0.0.0/16
  serviceNetwork:
  - 172.30.0.0/16
  networkType: OpenShiftSDN
platform:
  openstack:
    cloud: mycloud
    externalNetwork: external
    computeFlavor: m1.xlarge
    apiFloatingIP: 128.0.0.1
fips: false
pullSecret: '{"auths": ...}'
sshKey: ssh-ed25519 AAAA...

```

### 18.5.10. Generating a key pair for cluster node SSH access

During an OpenShift Container Platform installation, you can provide an SSH public key to the installation program. The key is passed to the Red Hat Enterprise Linux CoreOS (RHCOS) nodes through their Ignition config files and is used to authenticate SSH access to the nodes. The key is added to the `~/.ssh/authorized_keys` list for the **core** user on each node, which enables password-less authentication.

After the key is passed to the nodes, you can use the key pair to SSH in to the RHCOS nodes as the user **core**. To access the nodes through SSH, the private key identity must be managed by SSH for your local user.

If you want to SSH in to your cluster nodes to perform installation debugging or disaster recovery, you must provide the SSH public key during the installation process. The `./openshift-install gather` command also requires the SSH public key to be in place on the cluster nodes.

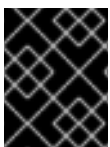

#### IMPORTANT

Do not skip this procedure in production environments, where disaster recovery and debugging is required.



#### NOTE

You must use a local key, not one that you configured with platform-specific approaches such as [AWS key pairs](#).

## Procedure

1. If you do not have an existing SSH key pair on your local machine to use for authentication onto your cluster nodes, create one. For example, on a computer that uses a Linux operating system, run the following command:

```
$ ssh-keygen -t ed25519 -N "" -f <path>/<file_name> 1
```

- 1 Specify the path and file name, such as `~/.ssh/id_ed25519`, of the new SSH key. If you have an existing key pair, ensure your public key is in the your `~/.ssh` directory.



### NOTE

If you plan to install an OpenShift Container Platform cluster that uses FIPS validated or Modules In Process cryptographic libraries on the **x86\_64** architecture, do not create a key that uses the **ed25519** algorithm. Instead, create a key that uses the **rsa** or **ecdsa** algorithm.

2. View the public SSH key:

```
$ cat <path>/<file_name>.pub
```

For example, run the following to view the `~/.ssh/id_ed25519.pub` public key:

```
$ cat ~/.ssh/id_ed25519.pub
```

3. Add the SSH private key identity to the SSH agent for your local user, if it has not already been added. SSH agent management of the key is required for password-less SSH authentication onto your cluster nodes, or if you want to use the `./openshift-install gather` command.

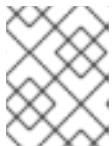

### NOTE

On some distributions, default SSH private key identities such as `~/.ssh/id_rsa` and `~/.ssh/id_dsa` are managed automatically.

- a. If the **ssh-agent** process is not already running for your local user, start it as a background task:

```
$ eval "$(ssh-agent -s)"
```

### Example output

```
Agent pid 31874
```



### NOTE

If your cluster is in FIPS mode, only use FIPS-compliant algorithms to generate the SSH key. The key must be either RSA or ECDSA.

4. Add your SSH private key to the **ssh-agent**:

■

```
$ ssh-add <path>/<file_name> 1
```

- 1 Specify the path and file name for your SSH private key, such as `~/.ssh/id_ed25519`

### Example output

```
Identity added: /home/<you>/<path>/<file_name> (<computer_name>)
```

### Next steps

- When you install OpenShift Container Platform, provide the SSH public key to the installation program.

## 18.5.11. Enabling access to the environment

At deployment, all OpenShift Container Platform machines are created in a Red Hat OpenStack Platform (RHOSP)-tenant network. Therefore, they are not accessible directly in most RHOSP deployments.

You can configure OpenShift Container Platform API and application access by using floating IP addresses (FIPs) during installation. You can also complete an installation without configuring FIPs, but the installer will not configure a way to reach the API or applications externally.

### 18.5.11.1. Enabling access with floating IP addresses

Create floating IP (FIP) addresses for external access to the OpenShift Container Platform API and cluster applications.

#### Procedure

1. Using the Red Hat OpenStack Platform (RHOSP) CLI, create the API FIP:

```
$ openstack floating ip create --description "API <cluster_name>.<base_domain>"
<external_network>
```

2. Using the Red Hat OpenStack Platform (RHOSP) CLI, create the apps, or Ingress, FIP:

```
$ openstack floating ip create --description "Ingress <cluster_name>.<base_domain>"
<external_network>
```

3. Add records that follow these patterns to your DNS server for the API and Ingress FIPs:

```
api.<cluster_name>.<base_domain>. IN A <API_FIP>
*.apps.<cluster_name>.<base_domain>. IN A <apps_FIP>
```



## NOTE

If you do not control the DNS server, you can access the cluster by adding the cluster domain names such as the following to your `/etc/hosts` file:

- `<api_floating_ip> api.<cluster_name>.<base_domain>`
- `<application_floating_ip> grafana-openshift-monitoring.apps.<cluster_name>.<base_domain>`
- `<application_floating_ip> prometheus-k8s-openshift-monitoring.apps.<cluster_name>.<base_domain>`
- `<application_floating_ip> oauth-openshift.apps.<cluster_name>.<base_domain>`
- `<application_floating_ip> console-openshift-console.apps.<cluster_name>.<base_domain>`
- `application_floating_ip integrated-oauth-server-openshift-authentication.apps.<cluster_name>.<base_domain>`

The cluster domain names in the `/etc/hosts` file grant access to the web console and the monitoring interface of your cluster locally. You can also use the `kubectl` or `oc`. You can access the user applications by using the additional entries pointing to the `<application_floating_ip>`. This action makes the API and applications accessible to only you, which is not suitable for production deployment, but does allow installation for development and testing.

4. Add the FIPs to the `install-config.yaml` file as the values of the following parameters:

- `platform.openstack.ingressFloatingIP`
- `platform.openstack.apiFloatingIP`

If you use these values, you must also enter an external network as the value of the `platform.openstack.externalNetwork` parameter in the `install-config.yaml` file.

## TIP

You can make OpenShift Container Platform resources available outside of the cluster by assigning a floating IP address and updating your firewall configuration.

### 18.5.11.2. Completing installation without floating IP addresses

You can install OpenShift Container Platform on Red Hat OpenStack Platform (RHOSP) without providing floating IP addresses.

In the file, do not define the following

If you run the installer from a system that cannot reach the cluster API due to a lack of floating IP addresses or name resolution, installation fails. To prevent installation failure in these cases, you can use a proxy network or run the installer from a system that is on the same network as your machines.



**NOTE**

You can enable name resolution by creating DNS records for the API and Ingress ports. For example:

```
api.<cluster_name>.<base_domain>. IN A <api_port_IP>
*.apps.<cluster_name>.<base_domain>. IN A <ingress_port_IP>
```

If you do not control the DNS server, you can add the record to your `/etc/hosts` file. This action makes the API accessible to only you, which is not suitable for production deployment but does allow installation for development and testing.

### 18.5.12. Creating SR-IOV networks for compute machines

If your Red Hat OpenStack Platform (RHOSP) deployment supports [single root I/O virtualization \(SR-IOV\)](#), you can provision SR-IOV networks that compute machines run on.

**NOTE**

The following instructions entail creating an external flat network and an external, VLAN-based network that can be attached to a compute machine. Depending on your RHOSP deployment, other network types might be required.

#### Prerequisites

- Your cluster supports SR-IOV.

**NOTE**

If you are unsure about what your cluster supports, review the OpenShift Container Platform SR-IOV hardware networks documentation.

- You created radio and uplink provider networks as part of your RHOSP deployment. The names **radio** and **uplink** are used in all example commands to represent these networks.

#### Procedure

1. On a command line, create a radio RHOSP network:

```
$ openstack network create radio --provider-physical-network radio --provider-network-type flat --external
```

2. Create an uplink RHOSP network:

```
$ openstack network create uplink --provider-physical-network uplink --provider-network-type vlan --external
```

3. Create a subnet for the radio network:

```
$ openstack subnet create --network radio --subnet-range <radio_network_subnet_range> radio
```

4. Create a subnet for the uplink network:

```
$ openstack subnet create --network uplink --subnet-range <uplink_network_subnet_range>
uplink
```

### 18.5.13. Deploying the cluster

You can install OpenShift Container Platform on a compatible cloud platform.

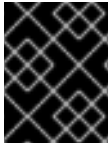

#### IMPORTANT

You can run the **create cluster** command of the installation program only once, during initial installation.

#### Prerequisites

- Obtain the OpenShift Container Platform installation program and the pull secret for your cluster.

#### Procedure

1. Change to the directory that contains the installation program and initialize the cluster deployment:

```
$ ./openshift-install create cluster --dir <installation_directory> \ 1
--log-level=info 2
```

- 1 For **<installation\_directory>**, specify the location of your customized **./install-config.yaml** file.
- 2 To view different installation details, specify **warn**, **debug**, or **error** instead of **info**.

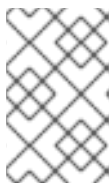

#### NOTE

If the cloud provider account that you configured on your host does not have sufficient permissions to deploy the cluster, the installation process stops, and the missing permissions are displayed.

When the cluster deployment completes, directions for accessing your cluster, including a link to its web console and credentials for the **kubeadmin** user, display in your terminal.

#### Example output

```
...
INFO Install complete!
INFO To access the cluster as the system:admin user when using 'oc', run 'export
KUBECONFIG=/home/myuser/install_dir/auth/kubeconfig'
INFO Access the OpenShift web-console here: https://console-openshift-
console.apps.mycluster.example.com
INFO Login to the console with user: "kubeadmin", and password: "4vYBz-Ee6gm-ymBZj-
Wt5AL"
INFO Time elapsed: 36m22s
```

**NOTE**

The cluster access and credential information also outputs to `<installation_directory>/openshift_install.log` when an installation succeeds.

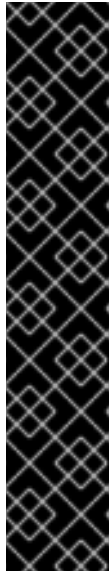
**IMPORTANT**

- The Ignition config files that the installation program generates contain certificates that expire after 24 hours, which are then renewed at that time. If the cluster is shut down before renewing the certificates and the cluster is later restarted after the 24 hours have elapsed, the cluster automatically recovers the expired certificates. The exception is that you must manually approve the pending **node-bootstrap** certificate signing requests (CSRs) to recover kubelet certificates. See the documentation for *Recovering from expired control plane certificates* for more information.
- It is recommended that you use Ignition config files within 12 hours after they are generated because the 24-hour certificate rotates from 16 to 22 hours after the cluster is installed. By using the Ignition config files within 12 hours, you can avoid installation failure if the certificate update runs during installation.

**IMPORTANT**

You must not delete the installation program or the files that the installation program creates. Both are required to delete the cluster.

### 18.5.14. Verifying cluster status

You can verify your OpenShift Container Platform cluster's status during or after installation.

#### Procedure

1. In the cluster environment, export the administrator's kubeconfig file:

```
$ export KUBECONFIG=<installation_directory>/auth/kubeconfig 1
```

- 1** For `<installation_directory>`, specify the path to the directory that you stored the installation files in.

The **kubeconfig** file contains information about the cluster that is used by the CLI to connect a client to the correct cluster and API server.

2. View the control plane and compute machines created after a deployment:

```
$ oc get nodes
```

3. View your cluster's version:

```
$ oc get clusterversion
```

4. View your Operators' status:

```
$ oc get clusteroperator
```

5. View all running pods in the cluster:

```
$ oc get pods -A
```

### 18.5.15. Logging in to the cluster by using the CLI

You can log in to your cluster as a default system user by exporting the cluster **kubeconfig** file. The **kubeconfig** file contains information about the cluster that is used by the CLI to connect a client to the correct cluster and API server. The file is specific to a cluster and is created during OpenShift Container Platform installation.

#### Prerequisites

- You deployed an OpenShift Container Platform cluster.
- You installed the **oc** CLI.

#### Procedure

1. Export the **kubeadmin** credentials:

```
$ export KUBECONFIG=<installation_directory>/auth/kubeconfig 1
```

- 1** For **<installation\_directory>**, specify the path to the directory that you stored the installation files in.

2. Verify you can run **oc** commands successfully using the exported configuration:

```
$ oc whoami
```

#### Example output

```
system:admin
```

The cluster is operational. Before you can add OVS-DPDK compute machines though, you must perform additional tasks.

### 18.5.16. Enabling the RHOSP metadata service as a mountable drive

You can apply a machine config to your machine pool that makes the Red Hat OpenStack Platform (RHOSP) metadata service available as a mountable drive.

The following machine config enables the display of RHOSP network UUIDs from within the SR-IOV Network Operator. This configuration simplifies the association of SR-IOV resources to cluster SR-IOV resources.

#### Procedure

1. Create a machine config file from the following template:

## A mountable metadata service machine config file

```

kind: MachineConfig
apiVersion: machineconfiguration.openshift.io/v1
metadata:
  name: 20-mount-config 1
  labels:
    machineconfiguration.openshift.io/role: worker
spec:
  config:
    ignition:
      version: 3.2.0
    systemd:
      units:
        - name: create-mountpoint-var-config.service
          enabled: true
          contents: |
            [Unit]
            Description=Create mountpoint /var/config
            Before=kubelet.service

            [Service]
            ExecStart=/bin/mkdir -p /var/config

            [Install]
            WantedBy=var-config.mount

        - name: var-config.mount
          enabled: true
          contents: |
            [Unit]
            Before=local-fs.target
            [Mount]
            Where=/var/config
            What=/dev/disk/by-label/config-2
            [Install]
            WantedBy=local-fs.target

```

**1** You can substitute a name of your choice.

2. From a command line, apply the machine config:

```
$ oc apply -f <machine_config_file_name>.yaml
```

### 18.5.17. Enabling the No-IOMMU feature for the RHOSP VFIO driver

You can apply a machine config to your machine pool that enables the No-IOMMU feature for the Red Hat OpenStack Platform (RHOSP) virtual function I/O (VFIO) driver. The RHOSP vfio-pci driver requires this feature.

#### Procedure

1. Create a machine config file from the following template:

## A No-IOMMU VFIO machine config file

```
kind: MachineConfig
apiVersion: machineconfiguration.openshift.io/v1
metadata:
  name: 99-vfio-noiommu 1
  labels:
    machineconfiguration.openshift.io/role: worker
spec:
  config:
    ignition:
      version: 3.2.0
    storage:
      files:
        - path: /etc/modprobe.d/vfio-noiommu.conf
          mode: 0644
          contents:
            source:
              data:;base64,b3B0aW9ucyB2ZmlvIGVuYWJsZV91bnNhZmVfbm9pb21tdV9tb2RIPTEK
```

1 You can substitute a name of your choice.

- From a command line, apply the machine config:

```
$ oc apply -f <machine_config_file_name>.yaml
```

### 18.5.18. Binding the vfio-pci kernel driver to NICs

Compute machines that connect to a virtual function I/O (VFIO) network require the **vfio-pci** kernel driver to be bound to the ports that are attached to a configured network. Create a machine set for workers that attach to this VFIO network.

#### Procedure

- From a command line, retrieve VFIO network UUIDs:

```
$ openstack network show <VFIO_network_name> -f value -c id
```

- Create a machine set on your cluster from the following template:

```
apiVersion: machineconfiguration.openshift.io/v1
kind: MachineConfig
metadata:
  labels:
    machineconfiguration.openshift.io/role: worker
  name: 99-vhostuser-bind
spec:
  config:
    ignition:
      version: 2.2.0
    systemd:
      units:
        - name: vhostuser-bind.service
```

```

enabled: true
contents: |
[Unit]
Description=Vhostuser Interface vfio-pci Bind
Wants=network-online.target
After=network-online.target ignition-firstboot-complete.service
[Service]
Type=oneshot
EnvironmentFile=/etc/vhostuser-bind.conf
ExecStart=/usr/local/bin/vhostuser $ARG
[Install]
WantedBy=multi-user.target
storage:
files:
- contents:
  inline: vfio-pci
  filesystem: root
  mode: 0644
  path: /etc/modules-load.d/vfio-pci.conf
- contents:
  inline: |
  #!/bin/bash
  set -e
  if [[ "$#" -lt 1 ]]; then
    echo "Network ID not provided, nothing to do"
    exit
  fi

  source /etc/vhostuser-bind.conf

  NW_DATA="/var/config/openstack/latest/network_data.json"
  if [ ! -f ${NW_DATA} ]; then
    echo "Network data file not found, trying to download it from nova metadata"
    if ! curl http://169.254.169.254/openstack/latest/network_data.json >
/tmp/network_data.json; then
      echo "Failed to download network data file"
      exit 1
    fi
    NW_DATA="/tmp/network_data.json"
  fi
  function parseNetwork() {
    local nwid=$1
    local pcis=()
    echo "Network ID is $nwid"
    links=$(jq '.networks[] | select(.network_id == "$nwid") | .link' $NW_DATA)
    if [ ${#links} -gt 0 ]; then
      for link in $links; do
        echo "Link Name: $link"
        mac=$(jq -r '.links[] | select(.id == '$link') | .ethernet_mac_address'
$NW_DATA)
        if [ -n $mac ]; then
          pci=$(bindDriver $mac)
          pci_ret=$?
          if [[ "$pci_ret" -eq 0 ]]; then
            echo "$pci bind succesful"
          fi
        fi
      done
    fi
  }

```

```

        fi
    done
fi
}

function bindDriver() {
    local mac=$1
    for file in /sys/class/net/*; do
        dev_mac=$(cat $file/address)
        if [ "$mac" == "$dev_mac" ]; then
            name=${file##*/}
            bus_str=$(ethtool -i $name | grep bus)
            dev_t=${bus_str#*:}
            dev=${dev_t#[[:space:]]}

            echo $dev

            devlink="/sys/bus/pci/devices/$dev"
            syspath=$(realpath "$devlink")
            if [ ! -f "$syspath/driver/unbind" ]; then
                echo "File $syspath/driver/unbind not found"
                return 1
            fi
            if ! echo "$dev">"$syspath/driver/unbind"; then
                return 1
            fi

            if [ ! -f "$syspath/driver_override" ]; then
                echo "File $syspath/driver_override not found"
                return 1
            fi
            if ! echo "vfio-pci">"$syspath/driver_override"; then
                return 1
            fi

            if [ ! -f "/sys/bus/pci/drivers/vfio-pci/bind" ]; then
                echo "File /sys/bus/pci/drivers/vfio-pci/bind not found"
                return 1
            fi
            if ! echo "$dev">"/sys/bus/pci/drivers/vfio-pci/bind"; then
                return 1
            fi
            return 0
        fi
    done
    return 1
}

for nwid in "$@"; do
    parseNetwork $nwid
done
filesystem: root
mode: 0744
path: /usr/local/bin/vhostuser
- contents:
    inline: |

```



```
ARG="be22563c-041e-44a0-9cbd-aa391b439a39,ec200105-fb85-4181-a6af-
35816da6baf7" ❶
filesystem: root
mode: 0644
path: /etc/vhostuser-bind.conf
```

- ❶ Replace this value with a comma-separated list of VFIO network UUIDs.

On boot for machines that are part of this set, the MAC addresses of ports are translated into PCI bus IDs. The **vfio-pci** module is bound to any port that is associated with a network that is identified by the RHOSP network ID.

## Verification

1. On a compute node, from a command line, retrieve the name of the node by entering:

```
$ oc get nodes
```

2. Create a shell to debug the node:

```
$ oc debug node/<node_name>
```

3. Change the root directory for the current running process:

```
$ chroot /host
```

4. Enter the following command to list the kernel drivers that are handling each device on your machine:

```
$ lspci -k
```

## Example output

```
00:07.0 Ethernet controller: Red Hat, Inc. Virtio network device
Subsystem: Red Hat, Inc. Device 0001
Kernel driver in use: vfio-pci
```

In the output of the command, VFIO ethernet controllers use the **vfio-pci** kernel driver.

## 18.5.19. Exposing the host-device interface to the pod

You can use the Container Network Interface (CNI) plugin to expose an interface that is on the host to the pod. The plugin moves the interface from the namespace of the host network to the namespace of the pod. The pod then has direct control of the interface.

### Procedure

- Create an additional network attachment with the host-device CNI plugin by using the following object as an example:

```
apiVersion: k8s.cni.cncf.io/v1
kind: NetworkAttachmentDefinition
```

```
metadata:
  name: vhostuser1
  namespace: default
spec:
  config: '{ "cniVersion": "0.3.1", "name": "hostonly", "type": "host-device", "pciBusId":
"0000:00:04.0", "ipam": { } }'
```

## Verification

- From a command line, run the following command to see if networks are created in the namespace:

```
$ oc -n <your_cnf_namespace> get net-attach-def
```

## Additional resources

- [Creating an additional network attachment with the Cluster Network Operator](#)

The cluster is installed and prepared for configuration. You must now perform the OVS-DPDK configuration tasks in [Next steps](#).

## 18.5.20. Telemetry access for OpenShift Container Platform

In OpenShift Container Platform 4.10, the Telemetry service, which runs by default to provide metrics about cluster health and the success of updates, requires internet access. If your cluster is connected to the internet, Telemetry runs automatically, and your cluster is registered to [OpenShift Cluster Manager](#).

After you confirm that your [OpenShift Cluster Manager](#) inventory is correct, either maintained automatically by Telemetry or manually by using OpenShift Cluster Manager, [use subscription watch](#) to track your OpenShift Container Platform subscriptions at the account or multi-cluster level.

## Additional resources

- See [About remote health monitoring](#) for more information about the Telemetry service

## 18.5.21. Additional resources

- See [Performance Addon Operator for low latency nodes](#) for information about configuring your deployment for real-time running and low latency.

## 18.5.22. Next steps

- To complete OVS-DPDK configuration for your cluster:
  - [Install the Performance Addon Operator](#).
  - [Configure the Performance Addon Operator with huge pages support](#).
- [Customize your cluster](#).
- If necessary, you can [opt out of remote health reporting](#).
- If you need to enable external access to node ports, [configure ingress cluster traffic by using a node port](#).

- If you did not configure RHOSP to accept application traffic over floating IP addresses, [configure RHOSP access with floating IP addresses](#).

## 18.6. INSTALLING A CLUSTER ON OPENSTACK ON YOUR OWN INFRASTRUCTURE

In OpenShift Container Platform version 4.10, you can install a cluster on Red Hat OpenStack Platform (RHOSP) that runs on user-provisioned infrastructure.

Using your own infrastructure allows you to integrate your cluster with existing infrastructure and modifications. The process requires more labor on your part than installer-provisioned installations, because you must create all RHOSP resources, like Nova servers, Neutron ports, and security groups. However, Red Hat provides Ansible playbooks to help you in the deployment process.

### 18.6.1. Prerequisites

- You reviewed details about the [OpenShift Container Platform installation and update](#) processes.
- You read the documentation on [selecting a cluster installation method and preparing it for users](#).
- You verified that OpenShift Container Platform 4.10 is compatible with your RHOSP version by using the [Supported platforms for OpenShift clusters](#) section. You can also compare platform support across different versions by viewing the [OpenShift Container Platform on RHOSP support matrix](#).
- You have an RHOSP account where you want to install OpenShift Container Platform.
- You understand performance and scalability practices for cluster scaling, control plane sizing, and etcd. For more information, see [Recommended host practices](#).
- On the machine from which you run the installation program, you have:
  - A single directory in which you can keep the files you create during the installation process
  - Python 3

### 18.6.2. Internet access for OpenShift Container Platform

In OpenShift Container Platform 4.10, you require access to the internet to install your cluster.

You must have internet access to:

- Access [OpenShift Cluster Manager](#) to download the installation program and perform subscription management. If the cluster has internet access and you do not disable Telemetry, that service automatically entitles your cluster.
- Access [Quay.io](#) to obtain the packages that are required to install your cluster.
- Obtain the packages that are required to perform cluster updates.

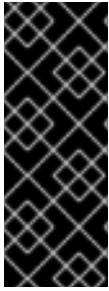

## IMPORTANT

If your cluster cannot have direct internet access, you can perform a restricted network installation on some types of infrastructure that you provision. During that process, you download the required content and use it to populate a mirror registry with the installation packages. With some installation types, the environment that you install your cluster in will not require internet access. Before you update the cluster, you update the content of the mirror registry.

### 18.6.3. Resource guidelines for installing OpenShift Container Platform on RHOSP

To support an OpenShift Container Platform installation, your Red Hat OpenStack Platform (RHOSP) quota must meet the following requirements:

**Table 18.21. Recommended resources for a default OpenShift Container Platform cluster on RHOSP**

Resource	Value
Floating IP addresses	3
Ports	15
Routers	1
Subnets	1
RAM	88 GB
vCPUs	22
Volume storage	275 GB
Instances	7
Security groups	3
Security group rules	60
Server groups	2 - plus 1 for each additional availability zone in each machine pool

A cluster might function with fewer than recommended resources, but its performance is not guaranteed.

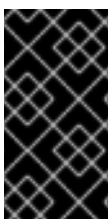

## IMPORTANT

If RHOSP object storage (Swift) is available and operated by a user account with the **swiftoperator** role, it is used as the default backend for the OpenShift Container Platform image registry. In this case, the volume storage requirement is 175 GB. Swift space requirements vary depending on the size of the image registry.

**NOTE**

By default, your security group and security group rule quotas might be low. If you encounter problems, run **openstack quota set --secgroups 3 --secgroup-rules 60 <project>** as an administrator to increase them.

An OpenShift Container Platform deployment comprises control plane machines, compute machines, and a bootstrap machine.

**18.6.3.1. Control plane machines**

By default, the OpenShift Container Platform installation process creates three control plane machines.

Each machine requires:

- An instance from the RHOSP quota
- A port from the RHOSP quota
- A flavor with at least 16 GB memory and 4 vCPUs
- At least 100 GB storage space from the RHOSP quota

**18.6.3.2. Compute machines**

By default, the OpenShift Container Platform installation process creates three compute machines.

Each machine requires:

- An instance from the RHOSP quota
- A port from the RHOSP quota
- A flavor with at least 8 GB memory and 2 vCPUs
- At least 100 GB storage space from the RHOSP quota

**TIP**

Compute machines host the applications that you run on OpenShift Container Platform; aim to run as many as you can.

**18.6.3.3. Bootstrap machine**

During installation, a bootstrap machine is temporarily provisioned to stand up the control plane. After the production control plane is ready, the bootstrap machine is deprovisioned.

The bootstrap machine requires:

- An instance from the RHOSP quota
- A port from the RHOSP quota
- A flavor with at least 16 GB memory and 4 vCPUs
- At least 100 GB storage space from the RHOSP quota

### 18.6.4. Downloading playbook dependencies

The Ansible playbooks that simplify the installation process on user-provisioned infrastructure require several Python modules. On the machine where you will run the installer, add the modules' repositories and then download them.



#### NOTE

These instructions assume that you are using Red Hat Enterprise Linux (RHEL) 8.

#### Prerequisites

- Python 3 is installed on your machine.

#### Procedure

1. On a command line, add the repositories:

- a. Register with Red Hat Subscription Manager:

```
$ sudo subscription-manager register # If not done already
```

- b. Pull the latest subscription data:

```
$ sudo subscription-manager attach --pool=$YOUR_POOLID # If not done already
```

- c. Disable the current repositories:

```
$ sudo subscription-manager repos --disable=* # If not done already
```

- d. Add the required repositories:

```
$ sudo subscription-manager repos \  
--enable=rhel-8-for-x86_64-baseos-rpms \  
--enable=openstack-16-tools-for-rhel-8-x86_64-rpms \  
--enable=ansible-2.9-for-rhel-8-x86_64-rpms \  
--enable=rhel-8-for-x86_64-appstream-rpms
```

2. Install the modules:

```
$ sudo yum install python3-openstackclient ansible python3-openstacksdk python3-netaddr
```

3. Ensure that the **python** command points to **python3**:

```
$ sudo alternatives --set python /usr/bin/python3
```

### 18.6.5. Downloading the installation playbooks

Download Ansible playbooks that you can use to install OpenShift Container Platform on your own Red Hat OpenStack Platform (RHOSP) infrastructure.

#### Prerequisites

- The curl command-line tool is available on your machine.

## Procedure

- To download the playbooks to your working directory, run the following script from a command line:

```
$ xargs -n 1 curl -O <<< '
  https://raw.githubusercontent.com/openshift/installer/release-
4.10/upi/openstack/bootstrap.yaml
  https://raw.githubusercontent.com/openshift/installer/release-
4.10/upi/openstack/common.yaml
  https://raw.githubusercontent.com/openshift/installer/release-
4.10/upi/openstack/compute-nodes.yaml
  https://raw.githubusercontent.com/openshift/installer/release-4.10/upi/openstack/control-
plane.yaml
  https://raw.githubusercontent.com/openshift/installer/release-
4.10/upi/openstack/inventory.yaml
  https://raw.githubusercontent.com/openshift/installer/release-
4.10/upi/openstack/network.yaml
  https://raw.githubusercontent.com/openshift/installer/release-
4.10/upi/openstack/security-groups.yaml
  https://raw.githubusercontent.com/openshift/installer/release-4.10/upi/openstack/down-
bootstrap.yaml
  https://raw.githubusercontent.com/openshift/installer/release-4.10/upi/openstack/down-
compute-nodes.yaml
  https://raw.githubusercontent.com/openshift/installer/release-4.10/upi/openstack/down-
control-plane.yaml
  https://raw.githubusercontent.com/openshift/installer/release-4.10/upi/openstack/down-
load-balancers.yaml
  https://raw.githubusercontent.com/openshift/installer/release-4.10/upi/openstack/down-
network.yaml
  https://raw.githubusercontent.com/openshift/installer/release-4.10/upi/openstack/down-
security-groups.yaml
  https://raw.githubusercontent.com/openshift/installer/release-4.10/upi/openstack/down-
containers.yaml'
```

The playbooks are downloaded to your machine.



### IMPORTANT

During the installation process, you can modify the playbooks to configure your deployment.

Retain all playbooks for the life of your cluster. You must have the playbooks to remove your OpenShift Container Platform cluster from RHOSP.

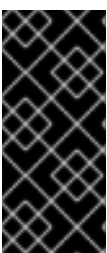

### IMPORTANT

You must match any edits you make in the **bootstrap.yaml**, **compute-nodes.yaml**, **control-plane.yaml**, **network.yaml**, and **security-groups.yaml** files to the corresponding playbooks that are prefixed with **down-**. For example, edits to the **bootstrap.yaml** file must be reflected in the **down-bootstrap.yaml** file, too. If you do not edit both files, the supported cluster removal process will fail.

## 18.6.6. Obtaining the installation program

Before you install OpenShift Container Platform, download the installation file on a local computer.

### Prerequisites

- You have a computer that runs Linux or macOS, with 500 MB of local disk space

### Procedure

1. Access the [Infrastructure Provider](#) page on the OpenShift Cluster Manager site. If you have a Red Hat account, log in with your credentials. If you do not, create an account.
2. Select your infrastructure provider.
3. Navigate to the page for your installation type, download the installation program that corresponds with your host operating system and architecture, and place the file in the directory where you will store the installation configuration files.



#### IMPORTANT

The installation program creates several files on the computer that you use to install your cluster. You must keep the installation program and the files that the installation program creates after you finish installing the cluster. Both files are required to delete the cluster.



#### IMPORTANT

Deleting the files created by the installation program does not remove your cluster, even if the cluster failed during installation. To remove your cluster, complete the OpenShift Container Platform uninstallation procedures for your specific cloud provider.

4. Extract the installation program. For example, on a computer that uses a Linux operating system, run the following command:

```
$ tar -xvf openshift-install-linux.tar.gz
```

5. Download your installation [pull secret from the Red Hat OpenShift Cluster Manager](#) . This pull secret allows you to authenticate with the services that are provided by the included authorities, including Quay.io, which serves the container images for OpenShift Container Platform components.

## 18.6.7. Generating a key pair for cluster node SSH access

During an OpenShift Container Platform installation, you can provide an SSH public key to the installation program. The key is passed to the Red Hat Enterprise Linux CoreOS (RHCOS) nodes through their Ignition config files and is used to authenticate SSH access to the nodes. The key is added to the `~/.ssh/authorized_keys` list for the **core** user on each node, which enables password-less authentication.

After the key is passed to the nodes, you can use the key pair to SSH in to the RHCOS nodes as the user **core**. To access the nodes through SSH, the private key identity must be managed by SSH for your local user.



If you want to SSH in to your cluster nodes to perform installation debugging or disaster recovery, you must provide the SSH public key during the installation process. The `./openshift-install gather` command also requires the SSH public key to be in place on the cluster nodes.



### IMPORTANT

Do not skip this procedure in production environments, where disaster recovery and debugging is required.



### NOTE

You must use a local key, not one that you configured with platform-specific approaches such as [AWS key pairs](#).

## Procedure

1. If you do not have an existing SSH key pair on your local machine to use for authentication onto your cluster nodes, create one. For example, on a computer that uses a Linux operating system, run the following command:

```
$ ssh-keygen -t ed25519 -N "" -f <path>/<file_name> 1
```

- 1 Specify the path and file name, such as `~/.ssh/id_ed25519`, of the new SSH key. If you have an existing key pair, ensure your public key is in the your `~/.ssh` directory.



### NOTE

If you plan to install an OpenShift Container Platform cluster that uses FIPS validated or Modules In Process cryptographic libraries on the `x86_64` architecture, do not create a key that uses the `ed25519` algorithm. Instead, create a key that uses the `rsa` or `ecdsa` algorithm.

2. View the public SSH key:

```
$ cat <path>/<file_name>.pub
```

For example, run the following to view the `~/.ssh/id_ed25519.pub` public key:

```
$ cat ~/.ssh/id_ed25519.pub
```

3. Add the SSH private key identity to the SSH agent for your local user, if it has not already been added. SSH agent management of the key is required for password-less SSH authentication onto your cluster nodes, or if you want to use the `./openshift-install gather` command.



### NOTE

On some distributions, default SSH private key identities such as `~/.ssh/id_rsa` and `~/.ssh/id_dsa` are managed automatically.

- a. If the `ssh-agent` process is not already running for your local user, start it as a background task:

■

```
$ eval "$(ssh-agent -s)"
```

### Example output

```
Agent pid 31874
```



### NOTE

If your cluster is in FIPS mode, only use FIPS-compliant algorithms to generate the SSH key. The key must be either RSA or ECDSA.

4. Add your SSH private key to the **ssh-agent**:

```
$ ssh-add <path>/<file_name> 1
```

- 1** Specify the path and file name for your SSH private key, such as `~/.ssh/id_ed25519`

### Example output

```
Identity added: /home/<you>/<path>/<file_name> (<computer_name>)
```

### Next steps

- When you install OpenShift Container Platform, provide the SSH public key to the installation program.

## 18.6.8. Creating the Red Hat Enterprise Linux CoreOS (RHCOS) image

The OpenShift Container Platform installation program requires that a Red Hat Enterprise Linux CoreOS (RHCOS) image be present in the Red Hat OpenStack Platform (RHOSP) cluster. Retrieve the latest RHCOS image, then upload it using the RHOSP CLI.

### Prerequisites

- The RHOSP CLI is installed.

### Procedure

1. Log in to the Red Hat Customer Portal's [Product Downloads page](#).
2. Under **Version**, select the most recent release of OpenShift Container Platform 4.10 for Red Hat Enterprise Linux (RHEL) 8.

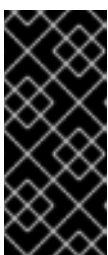

### IMPORTANT

The RHCOS images might not change with every release of OpenShift Container Platform. You must download images with the highest version that is less than or equal to the OpenShift Container Platform version that you install. Use the image versions that match your OpenShift Container Platform version if they are available.

3. Download the *Red Hat Enterprise Linux CoreOS (RHCOS) - OpenStack Image (QCOW)* .
4. Decompress the image.

**NOTE**

You must decompress the RHOSP image before the cluster can use it. The name of the downloaded file might not contain a compression extension, like **.gz** or **.tgz**. To find out if or how the file is compressed, in a command line, enter:

```
$ file <name_of_downloaded_file>
```

5. From the image that you downloaded, create an image that is named **rhcos** in your cluster by using the RHOSP CLI:

```
$ openstack image create --container-format=bare --disk-format=qcow2 --file rhcos-
${RHCOS_VERSION}-openstack.qcow2 rhcos
```

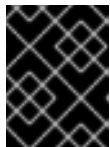
**IMPORTANT**

Depending on your RHOSP environment, you might be able to upload the image in either **.raw** or **.qcow2** formats. If you use Ceph, you must use the **.raw** format.

**WARNING**

If the installation program finds multiple images with the same name, it chooses one of them at random. To avoid this behavior, create unique names for resources in RHOSP.

After you upload the image to RHOSP, it is usable in the installation process.

### 18.6.9. Verifying external network access

The OpenShift Container Platform installation process requires external network access. You must provide an external network value to it, or deployment fails. Before you begin the process, verify that a network with the external router type exists in Red Hat OpenStack Platform (RHOSP).

#### Prerequisites

- [Configure OpenStack's networking service to have DHCP agents forward instances' DNS queries](#)

#### Procedure

1. Using the RHOSP CLI, verify the name and ID of the 'External' network:

```
$ openstack network list --long -c ID -c Name -c "Router Type"
```

## Example output

```

+-----+-----+-----+
| ID              | Name      | Router Type |
+-----+-----+-----+
| 148a8023-62a7-4672-b018-003462f8d7dc | public_network | External   |
+-----+-----+-----+

```

A network with an external router type appears in the network list. If at least one does not, see [Creating a default floating IP network](#) and [Creating a default provider network](#).



### NOTE

If the Neutron trunk service plugin is enabled, a trunk port is created by default. For more information, see [Neutron trunk port](#).

## 18.6.10. Enabling access to the environment

At deployment, all OpenShift Container Platform machines are created in a Red Hat OpenStack Platform (RHOSP)-tenant network. Therefore, they are not accessible directly in most RHOSP deployments.

You can configure OpenShift Container Platform API and application access by using floating IP addresses (FIPs) during installation. You can also complete an installation without configuring FIPs, but the installer will not configure a way to reach the API or applications externally.

### 18.6.10.1. Enabling access with floating IP addresses

Create floating IP (FIP) addresses for external access to the OpenShift Container Platform API, cluster applications, and the bootstrap process.

#### Procedure

1. Using the Red Hat OpenStack Platform (RHOSP) CLI, create the API FIP:

```
$ openstack floating ip create --description "API <cluster_name>.<base_domain>"
<external_network>
```

2. Using the Red Hat OpenStack Platform (RHOSP) CLI, create the apps, or Ingress, FIP:

```
$ openstack floating ip create --description "Ingress <cluster_name>.<base_domain>"
<external_network>
```

3. By using the Red Hat OpenStack Platform (RHOSP) CLI, create the bootstrap FIP:

```
$ openstack floating ip create --description "bootstrap machine" <external_network>
```

4. Add records that follow these patterns to your DNS server for the API and Ingress FIPs:

```
api.<cluster_name>.<base_domain>. IN A <API_FIP>
*.apps.<cluster_name>.<base_domain>. IN A <apps_FIP>
```



## NOTE

If you do not control the DNS server, you can access the cluster by adding the cluster domain names such as the following to your `/etc/hosts` file:

- `<api_floating_ip> api.<cluster_name>.<base_domain>`
- `<application_floating_ip> grafana-openshift-monitoring.apps.<cluster_name>.<base_domain>`
- `<application_floating_ip> prometheus-k8s-openshift-monitoring.apps.<cluster_name>.<base_domain>`
- `<application_floating_ip> oauth-openshift.apps.<cluster_name>.<base_domain>`
- `<application_floating_ip> console-openshift-console.apps.<cluster_name>.<base_domain>`
- `application_floating_ip integrated-oauth-server-openshift-authentication.apps.<cluster_name>.<base_domain>`

The cluster domain names in the `/etc/hosts` file grant access to the web console and the monitoring interface of your cluster locally. You can also use the `kubectl` or `oc`. You can access the user applications by using the additional entries pointing to the `<application_floating_ip>`. This action makes the API and applications accessible to only you, which is not suitable for production deployment, but does allow installation for development and testing.

5. Add the FIPs to the `inventory.yaml` file as the values of the following variables:

- `os_api_fip`
- `os_bootstrap_fip`
- `os_ingress_fip`

If you use these values, you must also enter an external network as the value of the `os_external_network` variable in the `inventory.yaml` file.

## TIP

You can make OpenShift Container Platform resources available outside of the cluster by assigning a floating IP address and updating your firewall configuration.

### 18.6.10.2. Completing installation without floating IP addresses

You can install OpenShift Container Platform on Red Hat OpenStack Platform (RHOSP) without providing floating IP addresses.

In the `inventory.yaml` file, do not define the following variables:

- `os_api_fip`
- `os_bootstrap_fip`

- **os\_ingress\_fip**

If you cannot provide an external network, you can also leave **os\_external\_network** blank. If you do not provide a value for **os\_external\_network**, a router is not created for you, and, without additional action, the installer will fail to retrieve an image from Glance. Later in the installation process, when you create network resources, you must configure external connectivity on your own.

If you run the installer with the **wait-for** command from a system that cannot reach the cluster API due to a lack of floating IP addresses or name resolution, installation fails. To prevent installation failure in these cases, you can use a proxy network or run the installer from a system that is on the same network as your machines.

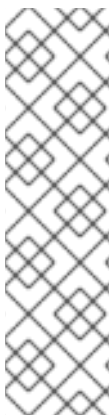

### NOTE

You can enable name resolution by creating DNS records for the API and Ingress ports. For example:

```
api.<cluster_name>.<base_domain>. IN A <api_port_IP>
*.apps.<cluster_name>.<base_domain>. IN A <ingress_port_IP>
```

If you do not control the DNS server, you can add the record to your **/etc/hosts** file. This action makes the API accessible to only you, which is not suitable for production deployment but does allow installation for development and testing.

## 18.6.11. Defining parameters for the installation program

The OpenShift Container Platform installation program relies on a file that is called **clouds.yaml**. The file describes Red Hat OpenStack Platform (RHOSP) configuration parameters, including the project name, log in information, and authorization service URLs.

### Procedure

1. Create the **clouds.yaml** file:
  - If your RHOSP distribution includes the Horizon web UI, generate a **clouds.yaml** file in it.



### IMPORTANT

Remember to add a password to the **auth** field. You can also keep secrets in [a separate file](#) from **clouds.yaml**.

- If your RHOSP distribution does not include the Horizon web UI, or you do not want to use Horizon, create the file yourself. For detailed information about **clouds.yaml**, see [Config files](#) in the RHOSP documentation.

```
clouds:
  shiftstack:
    auth:
      auth_url: http://10.10.14.42:5000/v3
      project_name: shiftstack
      username: <username>
      password: <password>
      user_domain_name: Default
      project_domain_name: Default
```

```
dev-env:
  region_name: RegionOne
  auth:
    username: <username>
    password: <password>
    project_name: 'devonly'
    auth_url: 'https://10.10.14.22:5001/v2.0'
```

2. If your RHOSP installation uses self-signed certificate authority (CA) certificates for endpoint authentication:
  - a. Copy the certificate authority file to your machine.
  - b. Add the **cacerts** key to the **clouds.yaml** file. The value must be an absolute, non-root-accessible path to the CA certificate:

```
clouds:
  shiftstack:
  ...
  cacert: "/etc/pki/ca-trust/source/anchors/ca.crt.pem"
```

### TIP

After you run the installer with a custom CA certificate, you can update the certificate by editing the value of the **ca-cert.pem** key in the **cloud-provider-config** keymap. On a command line, run:

```
$ oc edit configmap -n openshift-config cloud-provider-config
```

3. Place the **clouds.yaml** file in one of the following locations:
  - a. The value of the **OS\_CLIENT\_CONFIG\_FILE** environment variable
  - b. The current directory
  - c. A Unix-specific user configuration directory, for example **~/.config/openstack/clouds.yaml**
  - d. A Unix-specific site configuration directory, for example **/etc/openstack/clouds.yaml**  
The installation program searches for **clouds.yaml** in that order.

## 18.6.12. Creating the installation configuration file

You can customize the OpenShift Container Platform cluster you install on Red Hat OpenStack Platform (RHOSP).

### Prerequisites

- Obtain the OpenShift Container Platform installation program and the pull secret for your cluster.
- Obtain service principal permissions at the subscription level.

### Procedure

1. Create the **install-config.yaml** file.
  - a. Change to the directory that contains the installation program and run the following command:

```
$ ./openshift-install create install-config --dir <installation_directory> 1
```

- 1** For **<installation\_directory>**, specify the directory name to store the files that the installation program creates.



### IMPORTANT

Specify an empty directory. Some installation assets, like bootstrap X.509 certificates have short expiration intervals, so you must not reuse an installation directory. If you want to reuse individual files from another cluster installation, you can copy them into your directory. However, the file names for the installation assets might change between releases. Use caution when copying installation files from an earlier OpenShift Container Platform version.

- b. At the prompts, provide the configuration details for your cloud:
    - i. Optional: Select an SSH key to use to access your cluster machines.



### NOTE

For production OpenShift Container Platform clusters on which you want to perform installation debugging or disaster recovery, specify an SSH key that your **ssh-agent** process uses.

- ii. Select **openstack** as the platform to target.
        - iii. Specify the Red Hat OpenStack Platform (RHOSP) external network name to use for installing the cluster.
        - iv. Specify the floating IP address to use for external access to the OpenShift API.
        - v. Specify a RHOSP flavor with at least 16 GB RAM to use for control plane nodes and 8 GB RAM for compute nodes.
        - vi. Select the base domain to deploy the cluster to. All DNS records will be sub-domains of this base and will also include the cluster name.
        - vii. Enter a name for your cluster. The name must be 14 or fewer characters long.
        - viii. Paste the [pull secret from the Red Hat OpenShift Cluster Manager](#) .
2. Modify the **install-config.yaml** file. You can find more information about the available parameters in the "Installation configuration parameters" section.
  3. Back up the **install-config.yaml** file so that you can use it to install multiple clusters.

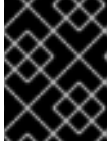

**IMPORTANT**

The **install-config.yaml** file is consumed during the installation process. If you want to reuse the file, you must back it up now.

You now have the file **install-config.yaml** in the directory that you specified.

### 18.6.13. Installation configuration parameters

Before you deploy an OpenShift Container Platform cluster, you provide parameter values to describe your account on the cloud platform that hosts your cluster and optionally customize your cluster's platform. When you create the **install-config.yaml** installation configuration file, you provide values for the required parameters through the command line. If you customize your cluster, you can modify the **install-config.yaml** file to provide more details about the platform.

**NOTE**

After installation, you cannot modify these parameters in the **install-config.yaml** file.

#### 18.6.13.1. Required configuration parameters

Required installation configuration parameters are described in the following table:

Table 18.22. Required parameters

Parameter	Description	Values
<b>apiVersion</b>	The API version for the <b>install-config.yaml</b> content. The current version is <b>v1</b> . The installer may also support older API versions.	String
<b>baseDomain</b>	The base domain of your cloud provider. The base domain is used to create routes to your OpenShift Container Platform cluster components. The full DNS name for your cluster is a combination of the <b>baseDomain</b> and <b>metadata.name</b> parameter values that uses the <b>&lt;metadata.name&gt;</b> . <b>&lt;baseDomain&gt;</b> format.	A fully-qualified domain or subdomain name, such as <b>example.com</b> .
<b>metadata</b>	Kubernetes resource <b>ObjectMeta</b> , from which only the <b>name</b> parameter is consumed.	Object

Parameter	Description	Values
<b>metadata.name</b>	The name of the cluster. DNS records for the cluster are all subdomains of <b>{{.metadata.name}}.{{.baseDomain}}</b> .	String of lowercase letters, hyphens (-), and periods (.), such as <b>dev</b> . The string must be 14 characters or fewer long.
<b>platform</b>	The configuration for the specific platform upon which to perform the installation: <b>alibabacloud, aws, baremetal, azure, gcp, ibmcloud, openstack, ovirt, vsphere</b> , or <b>{}</b> . For additional information about <b>platform.&lt;platform&gt;</b> parameters, consult the table for your specific platform that follows.	Object
<b>pullSecret</b>	Get a <a href="#">pull secret from the Red Hat OpenShift Cluster Manager</a> to authenticate downloading container images for OpenShift Container Platform components from services such as Quay.io.	<pre>{   "auths":{     "cloud.openshift.com":{       "auth":"b3Blb=",       "email":"you@example.com"     },     "quay.io":{       "auth":"b3Blb=",       "email":"you@example.com"     }   } }</pre>

### 18.6.13.2. Network configuration parameters

You can customize your installation configuration based on the requirements of your existing network infrastructure. For example, you can expand the IP address block for the cluster network or provide different IP address blocks than the defaults.

Only IPv4 addresses are supported.

Table 18.23. Network parameters

Parameter	Description	Values
-----------	-------------	--------

Parameter	Description	Values
<b>networking</b>	The configuration for the cluster network.	Object  <b>NOTE</b> You cannot modify parameters specified by the <b>networking</b> object after installation.
<b>networking.networkType</b>	The cluster network provider Container Network Interface (CNI) plugin to install.	Either <b>OpenShiftSDN</b> or <b>OVNKubernetes</b> . <b>OpenShiftSDN</b> is a CNI provider for all-Linux networks. <b>OVNKubernetes</b> is a CNI provider for Linux networks and hybrid networks that contain both Linux and Windows servers. The default value is <b>OpenShiftSDN</b> .
<b>networking.clusterNetwork</b>	The IP address blocks for pods.  The default value is <b>10.128.0.0/14</b> with a host prefix of <b>/23</b> .  If you specify multiple IP address blocks, the blocks must not overlap.	An array of objects. For example:  <pre>networking:   clusterNetwork:     - cidr: 10.128.0.0/14       hostPrefix: 23</pre>
<b>networking.clusterNetwork.cidr</b>	Required if you use <b>networking.clusterNetwork</b> . An IP address block.  An IPv4 network.	An IP address block in Classless Inter-Domain Routing (CIDR) notation. The prefix length for an IPv4 block is between <b>0</b> and <b>32</b> .
<b>networking.clusterNetwork.hostPrefix</b>	The subnet prefix length to assign to each individual node. For example, if <b>hostPrefix</b> is set to <b>23</b> then each node is assigned a <b>/23</b> subnet out of the given <b>cidr</b> . A <b>hostPrefix</b> value of <b>23</b> provides 510 ( $2^{(32 - 23)} - 2$ ) pod IP addresses.	A subnet prefix.  The default value is <b>23</b> .
<b>networking.serviceNetwork</b>	The IP address block for services. The default value is <b>172.30.0.0/16</b> .  The OpenShift SDN and OVN-Kubernetes network providers support only a single IP address block for the service network.	An array with an IP address block in CIDR format. For example:  <pre>networking:   serviceNetwork:     - 172.30.0.0/16</pre>

Parameter	Description	Values
<b>networking.machineNetwork</b>	The IP address blocks for machines.  If you specify multiple IP address blocks, the blocks must not overlap.	An array of objects. For example:  <pre>networking:   machineNetwork:   - cidr: 10.0.0.0/16</pre>
<b>networking.machineNetwork.cidr</b>	Required if you use <b>networking.machineNetwork</b> . An IP address block. The default value is <b>10.0.0.0/16</b> for all platforms other than libvirt. For libvirt, the default value is <b>192.168.126.0/24</b> .	An IP network block in CIDR notation.  For example, <b>10.0.0.0/16</b> .   <p><b>NOTE</b></p> <p>Set the <b>networking.machineNetwork</b> to match the CIDR that the preferred NIC resides in.</p>

### 18.6.13.3. Optional configuration parameters



Optional installation configuration parameters are described in the following table:

Table 18.24. Optional parameters

Parameter	Description	Values
<b>additionalTrustBundle</b>	A PEM-encoded X.509 certificate bundle that is added to the nodes' trusted certificate store. This trust bundle may also be used when a proxy has been configured.	String
<b>cgroupsV2</b>	Enables <a href="#">Linux control groups version 2</a> (cgroups v2) on specific nodes in your cluster. The OpenShift Container Platform process for enabling cgroups v2 disables all cgroup version 1 controllers and hierarchies. The OpenShift Container Platform cgroups version 2 feature is in Developer Preview and is not supported by Red Hat at this time.	<b>true</b>
<b>compute</b>	The configuration for the machines that comprise the compute nodes.	Array of <b>MachinePool</b> objects.



Parameter	Description	Values
<b>compute.architecture</b>	Determines the instruction set architecture of the machines in the pool. Currently, clusters with varied architectures are not supported. All pools must specify the same architecture. Valid values are <b>amd64</b> (the default).	String
<b>compute.hyperthreading</b>	Whether to enable or disable simultaneous multithreading, or <b>hyperthreading</b> , on compute machines. By default, simultaneous multithreading is enabled to increase the performance of your machines' cores.   <b>IMPORTANT</b> If you disable simultaneous multithreading, ensure that your capacity planning accounts for the dramatically decreased machine performance.	<b>Enabled</b> or <b>Disabled</b>
<b>compute.name</b>	Required if you use <b>compute</b> . The name of the machine pool.	<b>worker</b>
<b>compute.platform</b>	Required if you use <b>compute</b> . Use this parameter to specify the cloud provider to host the worker machines. This parameter value must match the <b>controlPlane.platform</b> parameter value.	<b>alibabacloud, aws, azure, gcp, ibmcloud, openstack, ovirt, vsphere</b> , or <b>{}</b>
<b>compute.replicas</b>	The number of compute machines, which are also known as worker machines, to provision.	A positive integer greater than or equal to <b>2</b> . The default value is <b>3</b> .
<b>controlPlane</b>	The configuration for the machines that comprise the control plane.	Array of <b>MachinePool</b> objects.

Parameter	Description	Values
<b>controlPlane.architecture</b>	Determines the instruction set architecture of the machines in the pool. Currently, clusters with varied architectures are not supported. All pools must specify the same architecture. Valid values are <b>amd64</b> (the default).	String
<b>controlPlane.hypertreading</b>	Whether to enable or disable simultaneous multithreading, or <b>hyperthreading</b> , on control plane machines. By default, simultaneous multithreading is enabled to increase the performance of your machines' cores.   <b>IMPORTANT</b> If you disable simultaneous multithreading, ensure that your capacity planning accounts for the dramatically decreased machine performance.	<b>Enabled</b> or <b>Disabled</b>
<b>controlPlane.name</b>	Required if you use <b>controlPlane</b> . The name of the machine pool.	<b>master</b>
<b>controlPlane.platform</b>	Required if you use <b>controlPlane</b> . Use this parameter to specify the cloud provider that hosts the control plane machines. This parameter value must match the <b>compute.platform</b> parameter value.	<b>alibabacloud, aws, azure, gcp, ibmcloud, openstack, ovirt, vsphere, or {}</b>
<b>controlPlane.replicas</b>	The number of control plane machines to provision.	The only supported value is <b>3</b> , which is the default value.

Parameter	Description	Values
<b>credentialsMode</b>	<p>The Cloud Credential Operator (CCO) mode. If no mode is specified, the CCO dynamically tries to determine the capabilities of the provided credentials, with a preference for mint mode on the platforms where multiple modes are supported.</p> <div data-bbox="485 510 595 864" style="border: 1px solid black; padding: 5px; margin-bottom: 10px;">  </div> <p><b>NOTE</b></p> <p>Not all CCO modes are supported for all cloud providers. For more information on CCO modes, see the <i>Cloud Credential Operator</i> entry in the <i>Cluster Operators reference</i> content.</p> <div data-bbox="485 909 595 1263" style="border: 1px solid black; padding: 5px;">  </div> <p><b>NOTE</b></p> <p>If your AWS account has service control policies (SCP) enabled, you must configure the <b>credentialsMode</b> parameter to <b>Mint</b>, <b>Passthrough</b> or <b>Manual</b>.</p>	<b>Mint, Passthrough, Manual</b> or an empty string ("").

Parameter	Description	Values
<b>fips</b>	<p>Enable or disable FIPS mode. The default is <b>false</b> (disabled). If FIPS mode is enabled, the Red Hat Enterprise Linux CoreOS (RHCOS) machines that OpenShift Container Platform runs on bypass the default Kubernetes cryptography suite and use the cryptography modules that are provided with RHCOS instead.</p> <div style="display: flex; align-items: flex-start;"> <div style="width: 60px; height: 100px; background: repeating-linear-gradient(45deg, transparent, transparent 2px, black 2px, black 4px); margin-right: 10px;"></div> <div> <p><b>IMPORTANT</b></p> <p>To enable FIPS mode for your cluster, you must run the installation program from a Red Hat Enterprise Linux (RHEL) computer configured to operate in FIPS mode. For more information about configuring FIPS mode on RHEL, see <a href="#">Installing the system in FIPS mode</a>. The use of FIPS validated or Modules In Process cryptographic libraries is only supported on OpenShift Container Platform deployments on the <b>x86_64</b> architecture.</p> </div> </div> <div style="display: flex; align-items: flex-start; margin-top: 10px;"> <div style="width: 60px; height: 60px; background: repeating-linear-gradient(45deg, transparent, transparent 2px, black 2px, black 4px); margin-right: 10px;"></div> <div> <p><b>NOTE</b></p> <p>If you are using Azure File storage, you cannot enable FIPS mode.</p> </div> </div>	<b>false</b> or <b>true</b>
<b>imageContentSources</b>	Sources and repositories for the release-image content.	Array of objects. Includes a <b>source</b> and, optionally, <b>mirrors</b> , as described in the following rows of this table.
<b>imageContentSources.source</b>	Required if you use <b>imageContentSources</b> . Specify the repository that users refer to, for example, in image pull specifications.	String
<b>imageContentSources.mirrors</b>	Specify one or more repositories that may also contain the same images.	Array of strings



Parameter	Description	Values
<b>publish</b>	How to publish or expose the user-facing endpoints of your cluster, such as the Kubernetes API, OpenShift routes.	<p><b>Internal</b> or <b>External</b>. The default value is <b>External</b>.</p> <p>Setting this field to <b>Internal</b> is not supported on non-cloud platforms and IBM Cloud VPC.</p> <div style="display: flex; align-items: flex-start;">  <div> <p><b>IMPORTANT</b></p> <p>If the value of the field is set to <b>Internal</b>, the cluster will become non-functional. For more information, refer to <a href="#">BZ#1953035</a>.</p> </div> </div>
<b>sshKey</b>	<p>The SSH key or keys to authenticate access your cluster machines.</p> <div style="display: flex; align-items: flex-start;">  <div> <p><b>NOTE</b></p> <p>For production OpenShift Container Platform clusters on which you want to perform installation debugging or disaster recovery, specify an SSH key that your <b>ssh-agent</b> process uses.</p> </div> </div>	<p>One or more keys. For example:</p> <pre>sshKey:   &lt;key1&gt;   &lt;key2&gt;   &lt;key3&gt;</pre>

#### 18.6.13.4. Additional Red Hat OpenStack Platform (RHOSP) configuration parameters

Additional RHOSP configuration parameters are described in the following table:

Table 18.25. Additional RHOSP parameters

Parameter	Description	Values
<b>compute.platform.openstack.rootVolume.size</b>	For compute machines, the size in gigabytes of the root volume. If you do not set this value, machines use ephemeral storage.	Integer, for example <b>30</b> .
<b>compute.platform.openstack.rootVolume.type</b>	For compute machines, the root volume's type.	String, for example <b>performance</b> .

Parameter	Description	Values
<b>controlPlane.platform.openstack.rootVolume.size</b>	For control plane machines, the size in gigabytes of the root volume. If you do not set this value, machines use ephemeral storage.	Integer, for example <b>30</b> .
<b>controlPlane.platform.openstack.rootVolume.type</b>	For control plane machines, the root volume's type.	String, for example <b>performance</b> .
<b>platform.openstack.cloud</b>	The name of the RHOSP cloud to use from the list of clouds in the <b>clouds.yaml</b> file.	String, for example <b>MyCloud</b> .
<b>platform.openstack.externalNetwork</b>	The RHOSP external network name to be used for installation.	String, for example <b>external</b> .
<b>platform.openstack.computeFlavor</b>	<p>The RHOSP flavor to use for control plane and compute machines.</p> <p>This property is deprecated. To use a flavor as the default for all machine pools, add it as the value of the <b>type</b> key in the <b>platform.openstack.defaultMachinePlatform</b> property. You can also set a flavor value for each machine pool individually.</p>	String, for example <b>m1.xlarge</b> .

### 18.6.13.5. Optional RHOSP configuration parameters

Optional RHOSP configuration parameters are described in the following table:

Table 18.26. Optional RHOSP parameters

Parameter	Description	Values
<b>compute.platform.openstack.additionalNetworkIds</b>	Additional networks that are associated with compute machines. Allowed address pairs are not created for additional networks.	A list of one or more UUIDs as strings. For example, <b>fa806b2f-ac49-4bce-b9db-124bc64209bf</b> .

Parameter	Description	Values
<b>compute.platform.openstack.additionalSecurityGroupIDs</b>	Additional security groups that are associated with compute machines.	A list of one or more UUIDs as strings. For example, <b>7ee219f3-d2e9-48a1-96c2-e7429f1b0da7</b> .
<b>compute.platform.openstack.zones</b>	<p>RHOSP Compute (Nova) availability zones (AZs) to install machines on. If this parameter is not set, the installer relies on the default settings for Nova that the RHOSP administrator configured.</p> <p>On clusters that use Kuryr, RHOSP Octavia does not support availability zones. Load balancers and, if you are using the Amphora provider driver, OpenShift Container Platform services that rely on Amphora VMs, are not created according to the value of this property.</p>	A list of strings. For example, <b>["zone-1", "zone-2"]</b> .
<b>compute.platform.openstack.rootVolume.zones</b>	For compute machines, the availability zone to install root volumes on. If you do not set a value for this parameter, the installer selects the default availability zone.	A list of strings, for example <b>["zone-1", "zone-2"]</b> .

Parameter	Description	Values
<b>compute.platform.openstack.serverGroupPolicy</b>	<p>Server group policy to apply to the group that will contain the compute machines in the pool. You cannot change server group policies or affiliations after creation. Supported options include <b>anti-affinity</b>, <b>soft-affinity</b>, and <b>soft-anti-affinity</b>. The default value is <b>soft-anti-affinity</b>.</p> <p>An <b>affinity</b> policy prevents migrations and therefore affects RHOSP upgrades. The <b>affinity</b> policy is not supported.</p> <p>If you use a strict <b>anti-affinity</b> policy, an additional RHOSP host is required during instance migration.</p>	<p>A server group policy to apply to the machine pool. For example, <b>soft-affinity</b>.</p>
<b>controlPlane.platform.openstack.additionalNetworkIDs</b>	<p>Additional networks that are associated with control plane machines. Allowed address pairs are not created for additional networks.</p>	<p>A list of one or more UUIDs as strings. For example, <b>fa806b2f-ac49-4bce-b9db-124bc64209bf</b>.</p>
<b>controlPlane.platform.openstack.additionalSecurityGroupIDs</b>	<p>Additional security groups that are associated with control plane machines.</p>	<p>A list of one or more UUIDs as strings. For example, <b>7ee219f3-d2e9-48a1-96c2-e7429f1b0da7</b>.</p>

Parameter	Description	Values
<b>controlPlane.placement.openstack.zones</b>	<p>RHOSP Compute (Nova) availability zones (AZs) to install machines on. If this parameter is not set, the installer relies on the default settings for Nova that the RHOSP administrator configured.</p> <p>On clusters that use Kuryr, RHOSP Octavia does not support availability zones. Load balancers and, if you are using the Amphora provider driver, OpenShift Container Platform services that rely on Amphora VMs, are not created according to the value of this property.</p>	<p>A list of strings. For example, <b>["zone-1", "zone-2"]</b>.</p>
<b>controlPlane.placement.openstack.rootVolume.zones</b>	<p>For control plane machines, the availability zone to install root volumes on. If you do not set this value, the installer selects the default availability zone.</p>	<p>A list of strings, for example <b>["zone-1", "zone-2"]</b>.</p>
<b>controlPlane.placement.openstack.serverGroupPolicy</b>	<p>Server group policy to apply to the group that will contain the control plane machines in the pool. You cannot change server group policies or affiliations after creation. Supported options include <b>anti-affinity</b>, <b>soft-affinity</b>, and <b>soft-anti-affinity</b>. The default value is <b>soft-anti-affinity</b>.</p> <p>An <b>affinity</b> policy prevents migrations, and therefore affects RHOSP upgrades. The <b>affinity</b> policy is not supported.</p> <p>If you use a strict <b>anti-affinity</b> policy, an additional RHOSP host is required during instance migration.</p>	<p>A server group policy to apply to the machine pool. For example, <b>soft-affinity</b>.</p>

Parameter	Description	Values
<b>platform.openstack.clusterOSImage</b>	<p>The location from which the installer downloads the RHCOS image.</p> <p>You must set this parameter to perform an installation in a restricted network.</p>	<p>An HTTP or HTTPS URL, optionally with an SHA-256 checksum.</p> <p>For example,  <b>http://mirror.example.com/images/rhcos-43.81.201912131630.0-openstack.x86_64.qcow2.gz?sha256=ffebbd68e8a1f2a245ca19522c16c86f67f9ac8e4e0c1f0a812b068b16f7265d</b>. The value can also be the name of an existing Glance image, for example <b>my-rhcos</b>.</p>
<b>platform.openstack.clusterOSImageProperties</b>	<p>Properties to add to the installer-uploaded ClusterOSImage in Glance. This property is ignored if <b>platform.openstack.clusterOSImage</b> is set to an existing Glance image.</p> <p>You can use this property to exceed the default persistent volume (PV) limit for RHOSP of 26 PVs per node. To exceed the limit, set the <b>hw_scsi_model</b> property value to <b>virtio-scsi</b> and the <b>hw_disk_bus</b> value to <b>scsi</b>.</p> <p>You can also use this property to enable the QEMU guest agent by including the <b>hw_qemu_guest_agent</b> property with a value of <b>yes</b>.</p>	<p>A list of key-value string pairs. For example,  <b>[{"hw_scsi_model": "virtio-scsi", "hw_disk_bus": "scsi"}]</b>.</p>
<b>platform.openstack.defaultMachinePlatform</b>	<p>The default machine pool platform configuration.</p>	<pre>{   "type": "ml.large",   "rootVolume": {     "size": 30,     "type": "performance"   } }</pre>
<b>platform.openstack.ingressFloatingIP</b>	<p>An existing floating IP address to associate with the Ingress port. To use this property, you must also define the <b>platform.openstack.externalNetwork</b> property.</p>	<p>An IP address, for example <b>128.0.0.1</b>.</p>

Parameter	Description	Values
<b>platform.openstack.apiFloatingIP</b>	An existing floating IP address to associate with the API load balancer. To use this property, you must also define the <b>platform.openstack.externalNetwork</b> property.	An IP address, for example <b>128.0.0.1</b> .
<b>platform.openstack.externalDNS</b>	IP addresses for external DNS servers that cluster instances use for DNS resolution.	A list of IP addresses as strings. For example, <b>["8.8.8.8", "192.168.1.12"]</b> .
<b>platform.openstack.machinesSubnet</b>	<p>The UUID of a RHOSP subnet that the cluster's nodes use. Nodes and virtual IP (VIP) ports are created on this subnet.</p> <p>The first item in <b>networking.machineNetwork</b> must match the value of <b>machinesSubnet</b>.</p> <p>If you deploy to a custom subnet, you cannot specify an external DNS server to the OpenShift Container Platform installer. Instead, <a href="#">add DNS to the subnet in RHOSP</a>.</p>	A UUID as a string. For example, <b>fa806b2f-ac49-4bce-b9db-124bc64209bf</b> .

#### 18.6.13.6. Custom subnets in RHOSP deployments

Optionally, you can deploy a cluster on a Red Hat OpenStack Platform (RHOSP) subnet of your choice. The subnet's GUID is passed as the value of **platform.openstack.machinesSubnet** in the **install-config.yaml** file.

This subnet is used as the cluster's primary subnet. By default, nodes and ports are created on it. You can create nodes and ports on a different RHOSP subnet by setting the value of the **platform.openstack.machinesSubnet** property to the subnet's UUID.

Before you run the OpenShift Container Platform installer with a custom subnet, verify that your configuration meets the following requirements:

- The subnet that is used by **platform.openstack.machinesSubnet** has DHCP enabled.
- The CIDR of **platform.openstack.machinesSubnet** matches the CIDR of **networking.machineNetwork**.
- The installation program user has permission to create ports on this network, including ports with fixed IP addresses.

Clusters that use custom subnets have the following limitations:

- If you plan to install a cluster that uses floating IP addresses, the **platform.openstack.machinesSubnet** subnet must be attached to a router that is connected to the **externalNetwork** network.
- If the **platform.openstack.machinesSubnet** value is set in the **install-config.yaml** file, the installation program does not create a private network or subnet for your RHOSP machines.
- You cannot use the **platform.openstack.externalDNS** property at the same time as a custom subnet. To add DNS to a cluster that uses a custom subnet, configure DNS on the RHOSP network.



## NOTE

By default, the API VIP takes x.x.x.5 and the Ingress VIP takes x.x.x.7 from your network's CIDR block. To override these default values, set values for **platform.openstack.apiVIP** and **platform.openstack.ingressVIP** that are outside of the DHCP allocation pool.

### 18.6.13.7. Sample customized install-config.yaml file for RHOSP

This sample **install-config.yaml** demonstrates all of the possible Red Hat OpenStack Platform (RHOSP) customization options.



## IMPORTANT

This sample file is provided for reference only. You must obtain your **install-config.yaml** file by using the installation program.

```

apiVersion: v1
baseDomain: example.com
controlPlane:
  name: master
  platform: {}
  replicas: 3
compute:
- name: worker
  platform:
    openstack:
      type: ml.large
  replicas: 3
metadata:
  name: example
networking:
  clusterNetwork:
  - cidr: 10.128.0.0/14
    hostPrefix: 23
  machineNetwork:
  - cidr: 10.0.0.0/16
  serviceNetwork:
  - 172.30.0.0/16
  networkType: OpenShiftSDN
platform:
  openstack:
    cloud: mycloud
    externalNetwork: external

```



```

computeFlavor: m1.xlarge
apiFloatingIP: 128.0.0.1
fips: false
pullSecret: '{"auths": ...}'
sshKey: ssh-ed25519 AAAA...

```

### 18.6.13.8. Setting a custom subnet for machines

The IP range that the installation program uses by default might not match the Neutron subnet that you create when you install OpenShift Container Platform. If necessary, update the CIDR value for new machines by editing the installation configuration file.

#### Prerequisites

- You have the **install-config.yaml** file that was generated by the OpenShift Container Platform installation program.

#### Procedure

- On a command line, browse to the directory that contains **install-config.yaml**.
- From that directory, either run a script to edit the **install-config.yaml** file or update the file manually:
  - To set the value by using a script, run:

```

$ python -c '
import yaml;
path = "install-config.yaml";
data = yaml.safe_load(open(path));
data["networking"]["machineNetwork"] = [{"cidr": "192.168.0.0/18"}]; 1
open(path, "w").write(yaml.dump(data, default_flow_style=False))'

```

- 1** Insert a value that matches your intended Neutron subnet, e.g. **192.0.2.0/24**.

- To set the value manually, open the file and set the value of **networking.machineCIDR** to something that matches your intended Neutron subnet.

### 18.6.13.9. Emptying compute machine pools

To proceed with an installation that uses your own infrastructure, set the number of compute machines in the installation configuration file to zero. Later, you create these machines manually.

#### Prerequisites

- You have the **install-config.yaml** file that was generated by the OpenShift Container Platform installation program.

#### Procedure

- On a command line, browse to the directory that contains **install-config.yaml**.

2. From that directory, either run a script to edit the **install-config.yaml** file or update the file manually:

- To set the value by using a script, run:

```
$ python -c '
import yaml;
path = "install-config.yaml";
data = yaml.safe_load(open(path));
data["compute"][0]["replicas"] = 0;
open(path, "w").write(yaml.dump(data, default_flow_style=False))'
```

- To set the value manually, open the file and set the value of **compute.<first entry>.replicas** to **0**.

### 18.6.13.10. Cluster deployment on RHOSP provider networks

You can deploy your OpenShift Container Platform clusters on Red Hat OpenStack Platform (RHOSP) with a primary network interface on a provider network. Provider networks are commonly used to give projects direct access to a public network that can be used to reach the internet. You can also share provider networks among projects as part of the network creation process.

RHOSP provider networks map directly to an existing physical network in the data center. A RHOSP administrator must create them.

In the following example, OpenShift Container Platform workloads are connected to a data center by using a provider network:

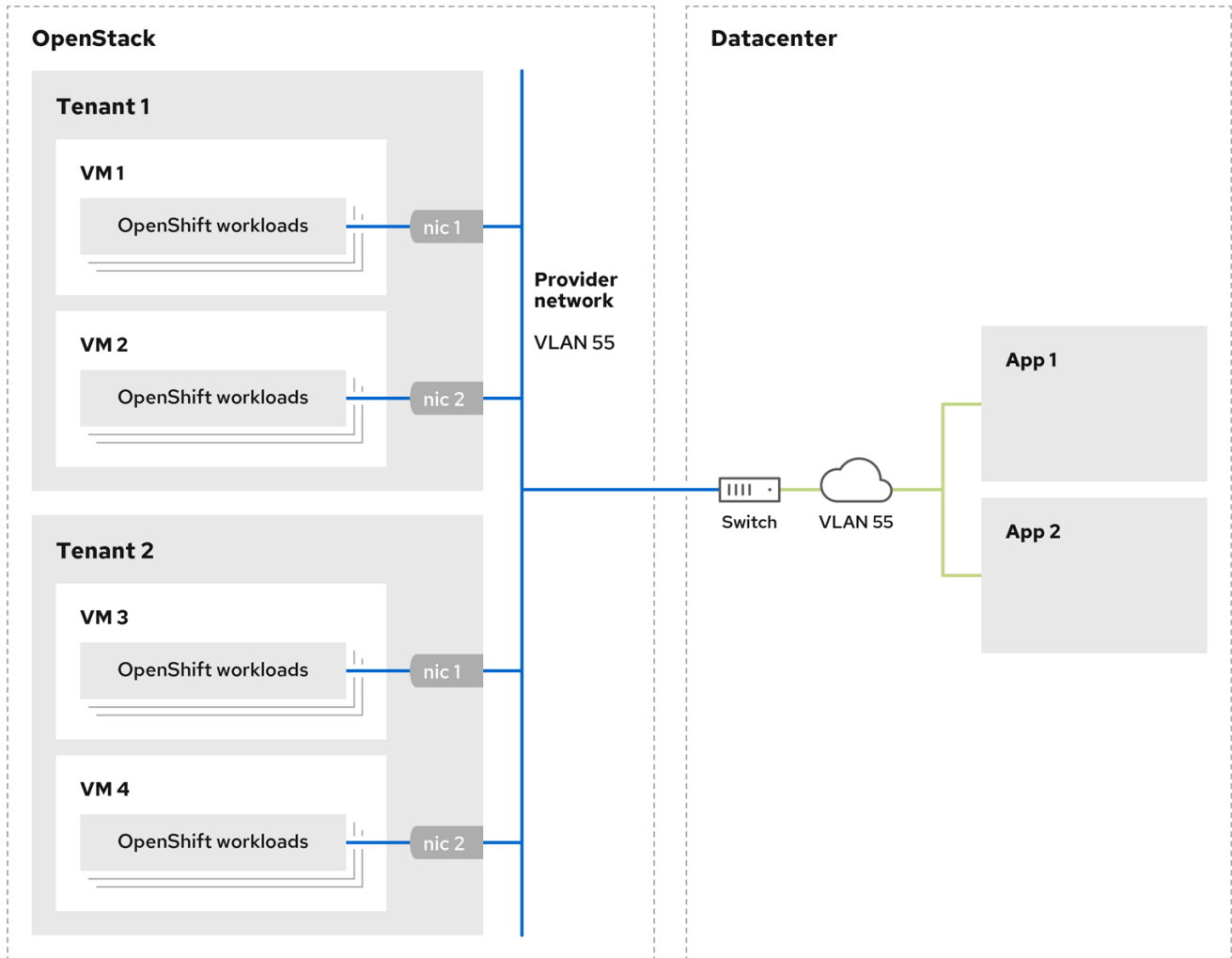

170\_OpenShift\_0621

OpenShift Container Platform clusters that are installed on provider networks do not require tenant networks or floating IP addresses. The installer does not create these resources during installation.

Example provider network types include flat (untagged) and VLAN (802.1Q tagged).



#### NOTE

A cluster can support as many provider network connections as the network type allows. For example, VLAN networks typically support up to 4096 connections.

You can learn more about provider and tenant networks in [the RHOSP documentation](#).

#### 18.6.13.10.1. RHOSP provider network requirements for cluster installation

Before you install an OpenShift Container Platform cluster, your Red Hat OpenStack Platform (RHOSP) deployment and provider network must meet a number of conditions:

- The [RHOSP networking service \(Neutron\) is enabled](#) and accessible through the RHOSP networking API.
- The RHOSP networking service has the [port security and allowed address pairs extensions enabled](#).

- The provider network can be shared with other tenants.

### TIP

Use the **openstack network create** command with the **--share** flag to create a network that can be shared.

- The RHOSP project that you use to install the cluster must own the provider network, as well as an appropriate subnet.

### TIP

To create a network for a project that is named "openshift," enter the following command

```
$ openstack network create --project openshift
```

To create a subnet for a project that is named "openshift," enter the following command

```
$ openstack subnet create --project openshift
```

To learn more about creating networks on RHOSP, read [the provider networks documentation](#).

If the cluster is owned by the **admin** user, you must run the installer as that user to create ports on the network.



### IMPORTANT

Provider networks must be owned by the RHOSP project that is used to create the cluster. If they are not, the RHOSP Compute service (Nova) cannot request a port from that network.

- Verify that the provider network can reach the RHOSP metadata service IP address, which is **169.254.169.254** by default.

Depending on your RHOSP SDN and networking service configuration, you might need to provide the route when you create the subnet. For example:

```
$ openstack subnet create --dhcp --host-route  
destination=169.254.169.254/32,gateway=192.0.2.2 ...
```

- Optional: To secure the network, create [role-based access control \(RBAC\)](#) rules that limit network access to a single project.

#### 18.6.13.10.2. Deploying a cluster that has a primary interface on a provider network

You can deploy an OpenShift Container Platform cluster that has its primary network interface on an Red Hat OpenStack Platform (RHOSP) provider network.

#### Prerequisites

- Your Red Hat OpenStack Platform (RHOSP) deployment is configured as described by "RHOSP provider network requirements for cluster installation".

## Procedure

1. In a text editor, open the **install-config.yaml** file.
2. Set the value of the **platform.openstack.apiVIP** property to the IP address for the API VIP.
3. Set the value of the **platform.openstack.ingressVIP** property to the IP address for the Ingress VIP.
4. Set the value of the **platform.openstack.machinesSubnet** property to the UUID of the provider network subnet.
5. Set the value of the **networking.machineNetwork.cidr** property to the CIDR block of the provider network subnet.

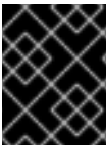

### IMPORTANT

The **platform.openstack.apiVIP** and **platform.openstack.ingressVIP** properties must both be unassigned IP addresses from the **networking.machineNetwork.cidr** block.

## Section of an installation configuration file for a cluster that relies on a RHOSP provider network

```
...
platform:
  openstack:
    apiVIP: 192.0.2.13
    ingressVIP: 192.0.2.23
    machinesSubnet: fa806b2f-ac49-4bce-b9db-124bc64209bf
    # ...
networking:
  machineNetwork:
    - cidr: 192.0.2.0/24
```



### WARNING

You cannot set the **platform.openstack.externalNetwork** or **platform.openstack.externalDNS** parameters while using a provider network for the primary network interface.

When you deploy the cluster, the installer uses the **install-config.yaml** file to deploy the cluster on the provider network.

**TIP**

You can add additional networks, including provider networks, to the **platform.openstack.additionalNetworkIDs** list.

After you deploy your cluster, you can attach pods to additional networks. For more information, see [Understanding multiple networks](#).

**18.6.14. Creating the Kubernetes manifest and Ignition config files**

Because you must modify some cluster definition files and manually start the cluster machines, you must generate the Kubernetes manifest and Ignition config files that the cluster needs to configure the machines.

The installation configuration file transforms into the Kubernetes manifests. The manifests wrap into the Ignition configuration files, which are later used to configure the cluster machines.

**IMPORTANT**

- The Ignition config files that the OpenShift Container Platform installation program generates contain certificates that expire after 24 hours, which are then renewed at that time. If the cluster is shut down before renewing the certificates and the cluster is later restarted after the 24 hours have elapsed, the cluster automatically recovers the expired certificates. The exception is that you must manually approve the pending **node-bootstrapper** certificate signing requests (CSRs) to recover kubelet certificates. See the documentation for *Recovering from expired control plane certificates* for more information.
- It is recommended that you use Ignition config files within 12 hours after they are generated because the 24-hour certificate rotates from 16 to 22 hours after the cluster is installed. By using the Ignition config files within 12 hours, you can avoid installation failure if the certificate update runs during installation.

**Prerequisites**

- You obtained the OpenShift Container Platform installation program.
- You created the **install-config.yaml** installation configuration file.

**Procedure**

1. Change to the directory that contains the OpenShift Container Platform installation program and generate the Kubernetes manifests for the cluster:

```
$ ./openshift-install create manifests --dir <installation_directory> 1
```

- 1** For **<installation\_directory>**, specify the installation directory that contains the **install-config.yaml** file you created.

2. Remove the Kubernetes manifest files that define the control plane machines and compute machine sets:

```
$ rm -f openshift/99_openshift-cluster-api_master-machines-*.yaml openshift/99_openshift-cluster-api_worker-machineset-*.yaml
```

Because you create and manage these resources yourself, you do not have to initialize them.

- You can preserve the machine set files to create compute machines by using the machine API, but you must update references to them to match your environment.
3. Check that the **mastersSchedulable** parameter in the `<installation_directory>/manifests/cluster-scheduler-02-config.yml` Kubernetes manifest file is set to **false**. This setting prevents pods from being scheduled on the control plane machines:
    - a. Open the `<installation_directory>/manifests/cluster-scheduler-02-config.yml` file.
    - b. Locate the **mastersSchedulable** parameter and ensure that it is set to **false**.
    - c. Save and exit the file.
  4. To create the Ignition configuration files, run the following command from the directory that contains the installation program:

```
$ ./openshift-install create ignition-configs --dir <installation_directory> 1
```

- 1 For `<installation_directory>`, specify the same installation directory.

Ignition config files are created for the bootstrap, control plane, and compute nodes in the installation directory. The **kubeadmin-password** and **kubeconfig** files are created in the `./<installation_directory>/auth` directory:

```
.
├── auth
│   ├── kubeadmin-password
│   └── kubeconfig
├── bootstrap.ign
├── master.ign
├── metadata.json
└── worker.ign
```

5. Export the metadata file's **infraID** key as an environment variable:

```
$ export INFRA_ID=$(jq -r .infraID metadata.json)
```

## TIP

Extract the **infraID** key from **metadata.json** and use it as a prefix for all of the RHOSP resources that you create. By doing so, you avoid name conflicts when making multiple deployments in the same project.

### 18.6.15. Preparing the bootstrap Ignition files

The OpenShift Container Platform installation process relies on bootstrap machines that are created from a bootstrap Ignition configuration file.

Edit the file and upload it. Then, create a secondary bootstrap Ignition configuration file that Red Hat OpenStack Platform (RHOSP) uses to download the primary file.

## Prerequisites

- You have the bootstrap Ignition file that the installer program generates, **bootstrap.ign**.
- The infrastructure ID from the installer's metadata file is set as an environment variable (**\$INFRA\_ID**).
  - If the variable is not set, see **Creating the Kubernetes manifest and Ignition config files**
- You have an HTTP(S)-accessible way to store the bootstrap Ignition file.
  - The documented procedure uses the RHOSP image service (Glance), but you can also use the RHOSP storage service (Swift), Amazon S3, an internal HTTP server, or an ad hoc Nova server.

## Procedure

1. Run the following Python script. The script modifies the bootstrap Ignition file to set the hostname and, if available, CA certificate file when it runs:

```
import base64
import json
import os

with open('bootstrap.ign', 'r') as f:
    ignition = json.load(f)

files = ignition['storage'].get('files', [])

infra_id = os.environ.get('INFRA_ID', 'openshift').encode()
hostname_b64 = base64.standard_b64encode(infra_id + b'-bootstrap\n').decode().strip()
files.append(
    {
        'path': '/etc/hostname',
        'mode': 420,
        'contents': {
            'source': 'data:text/plain;charset=utf-8;base64,' + hostname_b64
        }
    }
)

ca_cert_path = os.environ.get('OS_CACERT', "")
if ca_cert_path:
    with open(ca_cert_path, 'r') as f:
        ca_cert = f.read().encode()
        ca_cert_b64 = base64.standard_b64encode(ca_cert).decode().strip()

files.append(
    {
        'path': '/opt/openshift/tls/cloud-ca-cert.pem',
        'mode': 420,
        'contents': {
            'source': 'data:text/plain;charset=utf-8;base64,' + ca_cert_b64
        }
    }
)

ignition['storage']['files'] = files;
```



```
with open('bootstrap.ign', 'w') as f:
    json.dump(ignition, f)
```

- Using the RHOSP CLI, create an image that uses the bootstrap Ignition file:

```
$ openstack image create --disk-format=raw --container-format=bare --file bootstrap.ign
<image_name>
```

- Get the image's details:

```
$ openstack image show <image_name>
```

Make a note of the **file** value; it follows the pattern **v2/images/<image\_ID>/file**.



#### NOTE

Verify that the image you created is active.

- Retrieve the image service's public address:

```
$ openstack catalog show image
```

- Combine the public address with the image **file** value and save the result as the storage location. The location follows the pattern **<image\_service\_public\_URL>/v2/images/<image\_ID>/file**.

- Generate an auth token and save the token ID:

```
$ openstack token issue -c id -f value
```

- Insert the following content into a file called **\$INFRA\_ID-bootstrap-ignition.json** and edit the placeholders to match your own values:

```
{
  "ignition": {
    "config": {
      "merge": [{
        "source": "<storage_url>", 1
        "httpHeaders": [{
          "name": "X-Auth-Token", 2
          "value": "<token_ID>" 3
        }]
      }]
    },
    "security": {
      "tls": {
        "certificateAuthorities": [{
          "source": "data:text/plain;charset=utf-8;base64,<base64_encoded_certificate>" 4
        }]
      }
    }
  },
}
```

```
"version": "3.2.0"
  }
}
```

- 1 Replace the value of **ignition.config.merge.source** with the bootstrap Ignition file storage URL.
- 2 Set **name** in **httpHeaders** to **"X-Auth-Token"**.
- 3 Set **value** in **httpHeaders** to your token's ID.
- 4 If the bootstrap Ignition file server uses a self-signed certificate, include the base64-encoded certificate.

8. Save the secondary Ignition config file.

The bootstrap Ignition data will be passed to RHOSP during installation.



#### WARNING

The bootstrap Ignition file contains sensitive information, like **clouds.yaml** credentials. Ensure that you store it in a secure place, and delete it after you complete the installation process.

### 18.6.16. Creating control plane Ignition config files on RHOSP

Installing OpenShift Container Platform on Red Hat OpenStack Platform (RHOSP) on your own infrastructure requires control plane Ignition config files. You must create multiple config files.



#### NOTE

As with the bootstrap Ignition configuration, you must explicitly define a hostname for each control plane machine.

#### Prerequisites

- The infrastructure ID from the installation program's metadata file is set as an environment variable (**\$INFRA\_ID**).
  - If the variable is not set, see "Creating the Kubernetes manifest and Ignition config files".

#### Procedure

- On a command line, run the following Python script:

```
$ for index in $(seq 0 2); do
  MASTER_HOSTNAME="$INFRA_ID-master-$index\n"
  python -c "import base64, json, sys;
  ignition = json.load(sys.stdin);
  storage = ignition.get('storage', {});
```

```

files = storage.get('files', []);
files.append({'path': '/etc/hostname', 'mode': 420, 'contents': {'source':
'data:text/plain;charset=utf-8;base64,' +
base64.standard_b64encode(b'$MASTER_HOSTNAME').decode().strip(), 'verification': {}},
'filesystem': 'root'});
storage['files'] = files;
ignition['storage'] = storage
json.dump(ignition, sys.stdout) <master.ign >"$INFRA_ID-master-$index-ignition.json"
done

```

You now have three control plane Ignition files: **<INFRA\_ID>-master-0-ignition.json**, **<INFRA\_ID>-master-1-ignition.json**, and **<INFRA\_ID>-master-2-ignition.json**.

### 18.6.17. Creating network resources on RHOSP

Create the network resources that an OpenShift Container Platform on Red Hat OpenStack Platform (RHOSP) installation on your own infrastructure requires. To save time, run supplied Ansible playbooks that generate security groups, networks, subnets, routers, and ports.

#### Prerequisites

- Python 3 is installed on your machine.
- You downloaded the modules in "Downloading playbook dependencies".
- You downloaded the playbooks in "Downloading the installation playbooks".

#### Procedure

1. Optional: Add an external network value to the **inventory.yaml** playbook:

#### Example external network value in the **inventory.yaml** Ansible playbook

```

...
# The public network providing connectivity to the cluster. If not
# provided, the cluster external connectivity must be provided in another
# way.

# Required for os_api_fip, os_ingress_fip, os_bootstrap_fip.
os_external_network: 'external'
...

```



#### IMPORTANT

If you did not provide a value for **os\_external\_network** in the **inventory.yaml** file, you must ensure that VMs can access Glance and an external connection yourself.

2. Optional: Add external network and floating IP (FIP) address values to the **inventory.yaml** playbook:

#### Example FIP values in the **inventory.yaml** Ansible playbook

```

...

```

```

# OpenShift API floating IP address. If this value is non-empty, the
# corresponding floating IP will be attached to the Control Plane to
# serve the OpenShift API.
os_api_fip: '203.0.113.23'

# OpenShift Ingress floating IP address. If this value is non-empty, the
# corresponding floating IP will be attached to the worker nodes to serve
# the applications.
os_ingress_fip: '203.0.113.19'

# If this value is non-empty, the corresponding floating IP will be
# attached to the bootstrap machine. This is needed for collecting logs
# in case of install failure.
os_bootstrap_fip: '203.0.113.20'

```

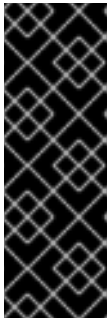

### IMPORTANT

If you do not define values for **os\_api\_fip** and **os\_ingress\_fip**, you must perform post-installation network configuration.

If you do not define a value for **os\_bootstrap\_fip**, the installer cannot download debugging information from failed installations.

See "Enabling access to the environment" for more information.

3. On a command line, create security groups by running the **security-groups.yaml** playbook:

```
$ ansible-playbook -i inventory.yaml security-groups.yaml
```

4. On a command line, create a network, subnet, and router by running the **network.yaml** playbook:

```
$ ansible-playbook -i inventory.yaml network.yaml
```

5. Optional: If you want to control the default resolvers that Nova servers use, run the RHOSP CLI command:

```
$ openstack subnet set --dns-nameserver <server_1> --dns-nameserver <server_2>
"$INFRA_ID-nodes"
```

Optionally, you can use the **inventory.yaml** file that you created to customize your installation. For example, you can deploy a cluster that uses bare metal machines.

#### 18.6.17.1. Deploying a cluster with bare metal machines

If you want your cluster to use bare metal machines, modify the **inventory.yaml** file. Your cluster can have both control plane and compute machines running on bare metal, or just compute machines.

Bare-metal compute machines are not supported on clusters that use Kuryr.



## NOTE

Be sure that your **install-config.yaml** file reflects whether the RHOSP network that you use for bare metal workers supports floating IP addresses or not.

## Prerequisites

- The RHOSP [Bare Metal service \(Ironic\)](#) is enabled and accessible via the RHOSP Compute API.
- Bare metal is available as [a RHOSP flavor](#).
- The RHOSP network supports both VM and bare metal server attachment.
- Your network configuration does not rely on a provider network. Provider networks are not supported.
- If you want to deploy the machines on a pre-existing network, a RHOSP subnet is provisioned.
- If you want to deploy the machines on an installer-provisioned network, the RHOSP Bare Metal service (Ironic) is able to listen for and interact with Preboot eXecution Environment (PXE) boot machines that run on tenant networks.
- You created an **inventory.yaml** file as part of the OpenShift Container Platform installation process.

## Procedure

1. In the **inventory.yaml** file, edit the flavors for machines:
  - a. If you want to use bare-metal control plane machines, change the value of **os\_flavor\_master** to a bare metal flavor.
  - b. Change the value of **os\_flavor\_worker** to a bare metal flavor.

### An example bare metal inventory.yaml file

```
all:
  hosts:
    localhost:
      ansible_connection: local
      ansible_python_interpreter: "{{ansible_playbook_python}}"

      # User-provided values
      os_subnet_range: '10.0.0.0/16'
      os_flavor_master: 'my-bare-metal-flavor' 1
      os_flavor_worker: 'my-bare-metal-flavor' 2
      os_image_rhcos: 'rhcos'
      os_external_network: 'external'

  ...
```

- 1 If you want to have bare-metal control plane machines, change this value to a bare metal flavor.
- 2 Change this value to a bare metal flavor to use for compute machines.

Use the updated **inventory.yaml** file to complete the installation process. Machines that are created during deployment use the flavor that you added to the file.



#### NOTE

The installer may time out while waiting for bare metal machines to boot.

If the installer times out, restart and then complete the deployment by using the **wait-for** command of the installer. For example:

```
┌ $ ./openshift-install wait-for install-complete --log-level debug
```

### 18.6.18. Creating the bootstrap machine on RHOSP

Create a bootstrap machine and give it the network access it needs to run on Red Hat OpenStack Platform (RHOSP). Red Hat provides an Ansible playbook that you run to simplify this process.

#### Prerequisites

- You downloaded the modules in "Downloading playbook dependencies".
- You downloaded the playbooks in "Downloading the installation playbooks".
- The **inventory.yaml**, **common.yaml**, and **bootstrap.yaml** Ansible playbooks are in a common directory.
- The **metadata.json** file that the installation program created is in the same directory as the Ansible playbooks.

#### Procedure

1. On a command line, change the working directory to the location of the playbooks.
2. On a command line, run the **bootstrap.yaml** playbook:

```
┌ $ ansible-playbook -i inventory.yaml bootstrap.yaml
```

3. After the bootstrap server is active, view the logs to verify that the Ignition files were received:

```
┌ $ openstack console log show "$INFRA_ID-bootstrap"
```

### 18.6.19. Creating the control plane machines on RHOSP

Create three control plane machines by using the Ignition config files that you generated. Red Hat provides an Ansible playbook that you run to simplify this process.

#### Prerequisites

- You downloaded the modules in "Downloading playbook dependencies".
- You downloaded the playbooks in "Downloading the installation playbooks".

- The infrastructure ID from the installation program's metadata file is set as an environment variable (**\$INFRA\_ID**).
- The **inventory.yaml**, **common.yaml**, and **control-plane.yaml** Ansible playbooks are in a common directory.
- You have the three Ignition files that were created in "Creating control plane Ignition config files".

### Procedure

1. On a command line, change the working directory to the location of the playbooks.
2. If the control plane Ignition config files aren't already in your working directory, copy them into it.
3. On a command line, run the **control-plane.yaml** playbook:

```
$ ansible-playbook -i inventory.yaml control-plane.yaml
```

4. Run the following command to monitor the bootstrapping process:

```
$ openshift-install wait-for bootstrap-complete
```

You will see messages that confirm that the control plane machines are running and have joined the cluster:

```
INFO API v1.23.0 up
INFO Waiting up to 30m0s for bootstrapping to complete...
...
INFO It is now safe to remove the bootstrap resources
```

### 18.6.20. Logging in to the cluster by using the CLI

You can log in to your cluster as a default system user by exporting the cluster **kubeconfig** file. The **kubeconfig** file contains information about the cluster that is used by the CLI to connect a client to the correct cluster and API server. The file is specific to a cluster and is created during OpenShift Container Platform installation.

#### Prerequisites

- You deployed an OpenShift Container Platform cluster.
- You installed the **oc** CLI.

#### Procedure

1. Export the **kubeadmin** credentials:

```
$ export KUBECONFIG=<installation_directory>/auth/kubeconfig 1
```

- 1** For **<installation\_directory>**, specify the path to the directory that you stored the installation files in.

2. Verify you can run **oc** commands successfully using the exported configuration:

```
$ oc whoami
```

#### Example output

```
system:admin
```

## 18.6.21. Deleting bootstrap resources from RHOSP

Delete the bootstrap resources that you no longer need.

### Prerequisites

- You downloaded the modules in "Downloading playbook dependencies".
- You downloaded the playbooks in "Downloading the installation playbooks".
- The **inventory.yaml**, **common.yaml**, and **down-bootstrap.yaml** Ansible playbooks are in a common directory.
- The control plane machines are running.
  - If you do not know the status of the machines, see "Verifying cluster status".

### Procedure

1. On a command line, change the working directory to the location of the playbooks.
2. On a command line, run the **down-bootstrap.yaml** playbook:

```
$ ansible-playbook -i inventory.yaml down-bootstrap.yaml
```

The bootstrap port, server, and floating IP address are deleted.



### WARNING

If you did not disable the bootstrap Ignition file URL earlier, do so now.

## 18.6.22. Creating compute machines on RHOSP

After standing up the control plane, create compute machines. Red Hat provides an Ansible playbook that you run to simplify this process.

### Prerequisites

- You downloaded the modules in "Downloading playbook dependencies".
- You downloaded the playbooks in "Downloading the installation playbooks".



- The **inventory.yaml**, **common.yaml**, and **compute-nodes.yaml** Ansible playbooks are in a common directory.
- The **metadata.json** file that the installation program created is in the same directory as the Ansible playbooks.
- The control plane is active.

### Procedure

1. On a command line, change the working directory to the location of the playbooks.
2. On a command line, run the playbook:

```
$ ansible-playbook -i inventory.yaml compute-nodes.yaml
```

### Next steps

- Approve the certificate signing requests for the machines.

### 18.6.23. Approving the certificate signing requests for your machines

When you add machines to a cluster, two pending certificate signing requests (CSRs) are generated for each machine that you added. You must confirm that these CSRs are approved or, if necessary, approve them yourself. The client requests must be approved first, followed by the server requests.

### Prerequisites

- You added machines to your cluster.

### Procedure

1. Confirm that the cluster recognizes the machines:

```
$ oc get nodes
```

### Example output

```
NAME      STATUS    ROLES    AGE    VERSION
master-0  Ready     master   63m    v1.23.0
master-1  Ready     master   63m    v1.23.0
master-2  Ready     master   64m    v1.23.0
```

The output lists all of the machines that you created.

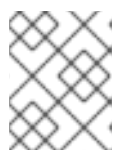

### NOTE

The preceding output might not include the compute nodes, also known as worker nodes, until some CSRs are approved.

2. Review the pending CSRs and ensure that you see the client requests with the **Pending** or **Approved** status for each machine that you added to the cluster:

```
$ oc get csr
```

### Example output

```
NAME      AGE   REQUESTOR                                     CONDITION
csr-8b2br 15m   system:serviceaccount:openshift-machine-config-operator:node-
bootstrapper Pending
csr-8vnps 15m   system:serviceaccount:openshift-machine-config-operator:node-
bootstrapper Pending
...
```

In this example, two machines are joining the cluster. You might see more approved CSRs in the list.

- If the CSRs were not approved, after all of the pending CSRs for the machines you added are in **Pending** status, approve the CSRs for your cluster machines:



#### NOTE

Because the CSRs rotate automatically, approve your CSRs within an hour of adding the machines to the cluster. If you do not approve them within an hour, the certificates will rotate, and more than two certificates will be present for each node. You must approve all of these certificates. After the client CSR is approved, the Kubelet creates a secondary CSR for the serving certificate, which requires manual approval. Then, subsequent serving certificate renewal requests are automatically approved by the **machine-approver** if the Kubelet requests a new certificate with identical parameters.



#### NOTE

For clusters running on platforms that are not machine API enabled, such as bare metal and other user-provisioned infrastructure, you must implement a method of automatically approving the kubelet serving certificate requests (CSRs). If a request is not approved, then the **oc exec**, **oc rsh**, and **oc logs** commands cannot succeed, because a serving certificate is required when the API server connects to the kubelet. Any operation that contacts the Kubelet endpoint requires this certificate approval to be in place. The method must watch for new CSRs, confirm that the CSR was submitted by the **node-bootstrapper** service account in the **system:node** or **system:admin** groups, and confirm the identity of the node.

- To approve them individually, run the following command for each valid CSR:

```
$ oc adm certificate approve <csr_name> 1
```

- 1** **<csr\_name>** is the name of a CSR from the list of current CSRs.

- To approve all pending CSRs, run the following command:

```
$ oc get csr -o go-template='{{range .items}}{{if not .status}}{{.metadata.name}}{\n"}\n{{end}}\n{{end}}' | xargs --no-run-if-empty oc adm certificate approve
```

**NOTE**

Some Operators might not become available until some CSRs are approved.

- Now that your client requests are approved, you must review the server requests for each machine that you added to the cluster:

```
$ oc get csr
```

**Example output**

```
NAME      AGE   REQUESTOR                                     CONDITION
csr-bfd72 5m26s system:node:ip-10-0-50-126.us-east-2.compute.internal
Pending
csr-c57lv 5m26s system:node:ip-10-0-95-157.us-east-2.compute.internal
Pending
...
```

- If the remaining CSRs are not approved, and are in the **Pending** status, approve the CSRs for your cluster machines:

- To approve them individually, run the following command for each valid CSR:

```
$ oc adm certificate approve <csr_name> 1
```

**1** **<csr\_name>** is the name of a CSR from the list of current CSRs.

- To approve all pending CSRs, run the following command:

```
$ oc get csr -o go-template='{{range .items}}{{if not .status}}{{.metadata.name}}{"\n"}\n{{end}}{{end}}' | xargs oc adm certificate approve
```

- After all client and server CSRs have been approved, the machines have the **Ready** status. Verify this by running the following command:

```
$ oc get nodes
```

**Example output**

```
NAME      STATUS  ROLES  AGE  VERSION
master-0  Ready   master 73m  v1.23.0
master-1  Ready   master 73m  v1.23.0
master-2  Ready   master 74m  v1.23.0
worker-0  Ready   worker 11m  v1.23.0
worker-1  Ready   worker 11m  v1.23.0
```

**NOTE**

It can take a few minutes after approval of the server CSRs for the machines to transition to the **Ready** status.

### Additional information

- For more information on CSRs, see [Certificate Signing Requests](#).

### 18.6.24. Verifying a successful installation

Verify that the OpenShift Container Platform installation is complete.

#### Prerequisites

- You have the installation program (**openshift-install**)

#### Procedure

- On a command line, enter:

```
$ openshift-install --log-level debug wait-for install-complete
```

The program outputs the console URL, as well as the administrator's login information.

### 18.6.25. Telemetry access for OpenShift Container Platform

In OpenShift Container Platform 4.10, the Telemetry service, which runs by default to provide metrics about cluster health and the success of updates, requires internet access. If your cluster is connected to the internet, Telemetry runs automatically, and your cluster is registered to [OpenShift Cluster Manager](#).

After you confirm that your [OpenShift Cluster Manager](#) inventory is correct, either maintained automatically by Telemetry or manually by using OpenShift Cluster Manager, [use subscription watch](#) to track your OpenShift Container Platform subscriptions at the account or multi-cluster level.

#### Additional resources

- See [About remote health monitoring](#) for more information about the Telemetry service

### 18.6.26. Next steps

- [Customize your cluster](#).
- If necessary, you can [opt out of remote health reporting](#).
- If you need to enable external access to node ports, [configure ingress cluster traffic by using a node port](#).
- If you did not configure RHOSP to accept application traffic over floating IP addresses, [configure RHOSP access with floating IP addresses](#).

## 18.7. INSTALLING A CLUSTER ON OPENSTACK WITH KURYR ON YOUR OWN INFRASTRUCTURE

In OpenShift Container Platform version 4.10, you can install a cluster on Red Hat OpenStack Platform (RHOSP) that runs on user-provisioned infrastructure.

Using your own infrastructure allows you to integrate your cluster with existing infrastructure and modifications. The process requires more labor on your part than installer-provisioned installations,

because you must create all RHOSP resources, like Nova servers, Neutron ports, and security groups. However, Red Hat provides Ansible playbooks to help you in the deployment process.

### 18.7.1. Prerequisites

- You reviewed details about the [OpenShift Container Platform installation and update](#) processes.
- You read the documentation on [selecting a cluster installation method and preparing it for users](#).
- You verified that OpenShift Container Platform 4.10 is compatible with your RHOSP version by using the [Supported platforms for OpenShift clusters](#) section. You can also compare platform support across different versions by viewing the [OpenShift Container Platform on RHOSP support matrix](#).
- You have an RHOSP account where you want to install OpenShift Container Platform.
- You understand performance and scalability practices for cluster scaling, control plane sizing, and etcd. For more information, see [Recommended host practices](#).
- On the machine from which you run the installation program, you have:
  - A single directory in which you can keep the files you create during the installation process
  - Python 3

### 18.7.2. About Kuryr SDN

[Kuryr](#) is a container network interface (CNI) plugin solution that uses the [Neutron](#) and [Octavia](#) Red Hat OpenStack Platform (RHOSP) services to provide networking for pods and Services.

Kuryr and OpenShift Container Platform integration is primarily designed for OpenShift Container Platform clusters running on RHOSP VMs. Kuryr improves the network performance by plugging OpenShift Container Platform pods into RHOSP SDN. In addition, it provides interconnectivity between pods and RHOSP virtual instances.

Kuryr components are installed as pods in OpenShift Container Platform using the **openshift-kuryr** namespace:

- **kuryr-controller** - a single service instance installed on a **master** node. This is modeled in OpenShift Container Platform as a **Deployment** object.
- **kuryr-cni** - a container installing and configuring Kuryr as a CNI driver on each OpenShift Container Platform node. This is modeled in OpenShift Container Platform as a **DaemonSet** object.

The Kuryr controller watches the OpenShift Container Platform API server for pod, service, and namespace create, update, and delete events. It maps the OpenShift Container Platform API calls to corresponding objects in Neutron and Octavia. This means that every network solution that implements the Neutron trunk port functionality can be used to back OpenShift Container Platform via Kuryr. This includes open source solutions such as Open vSwitch (OVS) and Open Virtual Network (OVN) as well as Neutron-compatible commercial SDNs.

Kuryr is recommended for OpenShift Container Platform deployments on encapsulated RHOSP tenant networks to avoid double encapsulation, such as running an encapsulated OpenShift Container Platform SDN over an RHOSP network.

If you use provider networks or tenant VLANs, you do not need to use Kuryr to avoid double encapsulation. The performance benefit is negligible. Depending on your configuration, though, using Kuryr to avoid having two overlays might still be beneficial.

Kuryr is not recommended in deployments where all of the following criteria are true:

- The RHOSP version is less than 16.
- The deployment uses UDP services, or a large number of TCP services on few hypervisors.

or

- The **ovn-octavia** Octavia driver is disabled.
- The deployment uses a large number of TCP services on few hypervisors.

### 18.7.3. Resource guidelines for installing OpenShift Container Platform on RHOSP with Kuryr

When using Kuryr SDN, the pods, services, namespaces, and network policies are using resources from the RHOSP quota; this increases the minimum requirements. Kuryr also has some additional requirements on top of what a default install requires.

Use the following quota to satisfy a default cluster's minimum requirements:

**Table 18.27. Recommended resources for a default OpenShift Container Platform cluster on RHOSP with Kuryr**

Resource	Value
Floating IP addresses	3 - plus the expected number of Services of LoadBalancer type
Ports	1500 - 1 needed per Pod
Routers	1
Subnets	250 - 1 needed per Namespace/Project
Networks	250 - 1 needed per Namespace/Project
RAM	112 GB
vCPUs	28
Volume storage	275 GB
Instances	7

Resource	Value
Security groups	250 - 1 needed per Service and per NetworkPolicy
Security group rules	1000
Server groups	2 - plus 1 for each additional availability zone in each machine pool
Load balancers	100 - 1 needed per Service
Load balancer listeners	500 - 1 needed per Service-exposed port
Load balancer pools	500 - 1 needed per Service-exposed port

A cluster might function with fewer than recommended resources, but its performance is not guaranteed.

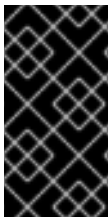

### IMPORTANT

If RHOSP object storage (Swift) is available and operated by a user account with the **swiftoperator** role, it is used as the default backend for the OpenShift Container Platform image registry. In this case, the volume storage requirement is 175 GB. Swift space requirements vary depending on the size of the image registry.

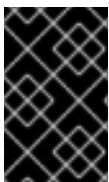

### IMPORTANT

If you are using Red Hat OpenStack Platform (RHOSP) version 16 with the Amphora driver rather than the OVN Octavia driver, security groups are associated with service accounts instead of user projects.

Take the following notes into consideration when setting resources:

- The number of ports that are required is larger than the number of pods. Kuryr uses ports pools to have pre-created ports ready to be used by pods and speed up the pods' booting time.
- Each network policy is mapped into an RHOSP security group, and depending on the **NetworkPolicy** spec, one or more rules are added to the security group.
- Each service is mapped to an RHOSP load balancer. Consider this requirement when estimating the number of security groups required for the quota.  
If you are using RHOSP version 15 or earlier, or the **ovn-octavia driver**, each load balancer has a security group with the user project.
- The quota does not account for load balancer resources (such as VM resources), but you must consider these resources when you decide the RHOSP deployment's size. The default installation will have more than 50 load balancers; the clusters must be able to accommodate them.  
If you are using RHOSP version 16 with the OVN Octavia driver enabled, only one load balancer VM is generated; services are load balanced through OVN flows.

An OpenShift Container Platform deployment comprises control plane machines, compute machines, and a bootstrap machine.

To enable Kuryr SDN, your environment must meet the following requirements:

- Run RHOSP 13+.
- Have Overcloud with Octavia.
- Use Neutron Trunk ports extension.
- Use **openvswitch** firewall driver if ML2/OVS Neutron driver is used instead of **ovs-hybrid**.

### 18.7.3.1. Increasing quota

When using Kuryr SDN, you must increase quotas to satisfy the Red Hat OpenStack Platform (RHOSP) resources used by pods, services, namespaces, and network policies.

#### Procedure

- Increase the quotas for a project by running the following command:

```
$ sudo openstack quota set --secgroups 250 --secgroup-rules 1000 --ports 1500 --subnets 250 --networks 250 <project>
```

### 18.7.3.2. Configuring Neutron

Kuryr CNI leverages the Neutron Trunks extension to plug containers into the Red Hat OpenStack Platform (RHOSP) SDN, so you must use the **trunks** extension for Kuryr to properly work.

In addition, if you leverage the default ML2/OVS Neutron driver, the firewall must be set to **openvswitch** instead of **ovs\_hybrid** so that security groups are enforced on trunk subports and Kuryr can properly handle network policies.

### 18.7.3.3. Configuring Octavia

Kuryr SDN uses Red Hat OpenStack Platform (RHOSP)'s Octavia LBaaS to implement OpenShift Container Platform services. Thus, you must install and configure Octavia components in RHOSP to use Kuryr SDN.

To enable Octavia, you must include the Octavia service during the installation of the RHOSP Overcloud, or upgrade the Octavia service if the Overcloud already exists. The following steps for enabling Octavia apply to both a clean install of the Overcloud or an Overcloud update.



#### NOTE

The following steps only capture the key pieces required during the [deployment of RHOSP](#) when dealing with Octavia. It is also important to note that [registry methods](#) vary.

This example uses the local registry method.

#### Procedure

1. If you are using the local registry, create a template to upload the images to the registry. For example:



```
(undercloud) $ openstack overcloud container image prepare \
-e /usr/share/openstack-tripleo-heat-templates/environments/services-docker/octavia.yaml \
--namespace=registry.access.redhat.com/rhosp13 \
--push-destination=<local-ip-from-undercloud.conf>:8787 \
--prefix=openstack- \
--tag-from-label {version}-{product-version} \
--output-env-file=/home/stack/templates/overcloud_images.yaml \
--output-images-file /home/stack/local_registry_images.yaml
```

2. Verify that the **local\_registry\_images.yaml** file contains the Octavia images. For example:

```
...
- imagename: registry.access.redhat.com/rhosp13/openstack-octavia-api:13.0-43
  push_destination: <local-ip-from-undercloud.conf>:8787
- imagename: registry.access.redhat.com/rhosp13/openstack-octavia-health-manager:13.0-45
  push_destination: <local-ip-from-undercloud.conf>:8787
- imagename: registry.access.redhat.com/rhosp13/openstack-octavia-housekeeping:13.0-45
  push_destination: <local-ip-from-undercloud.conf>:8787
- imagename: registry.access.redhat.com/rhosp13/openstack-octavia-worker:13.0-44
  push_destination: <local-ip-from-undercloud.conf>:8787
```

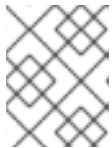

#### NOTE

The Octavia container versions vary depending upon the specific RHOSP release installed.

3. Pull the container images from **registry.redhat.io** to the Undercloud node:

```
(undercloud) $ sudo openstack overcloud container image upload \
--config-file /home/stack/local_registry_images.yaml \
--verbose
```

This may take some time depending on the speed of your network and Undercloud disk.

4. Since an Octavia load balancer is used to access the OpenShift Container Platform API, you must increase their listeners' default timeouts for the connections. The default timeout is 50 seconds. Increase the timeout to 20 minutes by passing the following file to the Overcloud deploy command:

```
(undercloud) $ cat octavia_timeouts.yaml
parameter_defaults:
  OctaviaTimeoutClientData: 1200000
  OctaviaTimeoutMemberData: 1200000
```



#### NOTE

This is not needed for RHOSP 13.0.13+.

5. Install or update your Overcloud environment with Octavia:

```
$ openstack overcloud deploy --templates \
  -e /usr/share/openstack-tripleo-heat-templates/environments/services-docker/octavia.yaml \
  -e octavia_timeouts.yaml
```

**NOTE**

This command only includes the files associated with Octavia; it varies based on your specific installation of RHOSP. See the RHOSP documentation for further information. For more information on customizing your Octavia installation, see [installation of Octavia using Director](#).

**NOTE**

When leveraging Kuryr SDN, the Overcloud installation requires the Neutron **trunk** extension. This is available by default on director deployments. Use the **openvswitch** firewall instead of the default **ovs-hybrid** when the Neutron backend is ML2/OVS. There is no need for modifications if the backend is ML2/OVN.

6. In RHOSP versions earlier than 13.0.13, add the project ID to the **octavia.conf** configuration file after you create the project.
  - To enforce network policies across services, like when traffic goes through the Octavia load balancer, you must ensure Octavia creates the Amphora VM security groups on the user project. This change ensures that required load balancer security groups belong to that project, and that they can be updated to enforce services isolation.

**NOTE**

This task is unnecessary in RHOSP version 13.0.13 or later.

Octavia implements a new ACL API that restricts access to the load balancers VIP.

- a. Get the project ID

```
$ openstack project show <project>
```

**Example output**

```
+-----+-----+
| Field  | Value                |
+-----+-----+
| description |                    |
| domain_id | default              |
| enabled   | True                 |
| id       | PROJECT_ID          |
| is_domain | False                |
| name     | *<project>*         |
| parent_id | default              |
| tags    | []                   |
+-----+-----+
```

b. Add the project ID to **octavia.conf** for the controllers.

i. Source the **stackrc** file:

```
$ source stackrc # Undercloud credentials
```

ii. List the Openstack controllers:

```
$ openstack server list
```

### Example output

```
+-----+-----+-----+-----+-----+
| ID              | Name      | Status | Networks |
| Image          | Flavor   |        |          |
+-----+-----+-----+-----+-----+
| 6bef8e73-2ba5-4860-a0b1-3937f8ca7e01 | controller-0 | ACTIVE | ctlplane=192.168.24.8 |
| overcloud-full | controller |
+-----+-----+-----+-----+-----+
| dda3173a-ab26-47f8-a2dc-8473b4a67ab9 | compute-0   | ACTIVE | ctlplane=192.168.24.6 |
| overcloud-full | compute    |
+-----+-----+-----+-----+-----+
```

iii. SSH into the controller(s).

```
$ ssh heat-admin@192.168.24.8
```

iv. Edit the **octavia.conf** file to add the project into the list of projects where Amphora security groups are on the user's account.

```
# List of project IDs that are allowed to have Load balancer security groups
# belonging to them.
amp_secgroup_allowed_projects = PROJECT_ID
```

c. Restart the Octavia worker so the new configuration loads.

```
controller-0$ sudo docker restart octavia_worker
```



### NOTE

Depending on your RHOSP environment, Octavia might not support UDP listeners. If you use Kuryr SDN on RHOSP version 13.0.13 or earlier, UDP services are not supported. RHOSP version 16 or later support UDP.

Octavia supports multiple provider drivers through the Octavia API.

To see all available Octavia provider drivers, on a command line, enter:

```
$ openstack loadbalancer provider list
```

### Example output

```
+-----+-----+
| name | description |
+-----+-----+
| amphora | The Octavia Amphora driver. |
| octavia | Deprecated alias of the Octavia Amphora driver. |
| ovn | Octavia OVN driver. |
+-----+-----+
```

Beginning with RHOSP version 16, the Octavia OVN provider driver (**ovn**) is supported on OpenShift Container Platform on RHOSP deployments.

**ovn** is an integration driver for the load balancing that Octavia and OVN provide. It supports basic load balancing capabilities, and is based on OpenFlow rules. The driver is automatically enabled in Octavia by Director on deployments that use OVN Neutron ML2.

The Amphora provider driver is the default driver. If **ovn** is enabled, however, Kuryr uses it.

If Kuryr uses **ovn** instead of Amphora, it offers the following benefits:

- Decreased resource requirements. Kuryr does not require a load balancer VM for each service.
- Reduced network latency.
- Increased service creation speed by using OpenFlow rules instead of a VM for each service.
- Distributed load balancing actions across all nodes instead of centralized on Amphora VMs.

#### 18.7.3.4. Known limitations of installing with Kuryr

Using OpenShift Container Platform with Kuryr SDN has several known limitations.

##### RHOSP general limitations

Using OpenShift Container Platform with Kuryr SDN has several limitations that apply to all versions and environments:

- **Service** objects with the **NodePort** type are not supported.
- Clusters that use the OVN Octavia provider driver support **Service** objects for which the **.spec.selector** property is unspecified only if the **.subsets.addresses** property of the **Endpoints** object includes the subnet of the nodes or pods.
- If the subnet on which machines are created is not connected to a router, or if the subnet is connected, but the router has no external gateway set, Kuryr cannot create floating IPs for **Service** objects with type **LoadBalancer**.
- Configuring the **sessionAffinity=ClientIP** property on **Service** objects does not have an effect. Kuryr does not support this setting.

### RHOSP version limitations

Using OpenShift Container Platform with Kuryr SDN has several limitations that depend on the RHOSP version.

- RHOSP versions before 16 use the default Octavia load balancer driver (Amphora). This driver requires that one Amphora load balancer VM is deployed per OpenShift Container Platform service. Creating too many services can cause you to run out of resources. Deployments of later versions of RHOSP that have the OVN Octavia driver disabled also use the Amphora driver. They are subject to the same resource concerns as earlier versions of RHOSP.
- Octavia RHOSP versions before 13.0.13 do not support UDP listeners. Therefore, OpenShift Container Platform UDP services are not supported.
- Octavia RHOSP versions before 13.0.13 cannot listen to multiple protocols on the same port. Services that expose the same port to different protocols, like TCP and UDP, are not supported.
- Kuryr SDN does not support automatic unidling by a service.

### RHOSP environment limitations

There are limitations when using Kuryr SDN that depend on your deployment environment.

Because of Octavia's lack of support for the UDP protocol and multiple listeners, if the RHOSP version is earlier than 13.0.13, Kuryr forces pods to use TCP for DNS resolution.

In Go versions 1.12 and earlier, applications that are compiled with CGO support disabled use UDP only. In this case, the native Go resolver does not recognize the **use-vc** option in **resolv.conf**, which controls whether TCP is forced for DNS resolution. As a result, UDP is still used for DNS resolution, which fails.

To ensure that TCP forcing is allowed, compile applications either with the environment variable **CGO\_ENABLED** set to **1**, i.e. **CGO\_ENABLED=1**, or ensure that the variable is absent.

In Go versions 1.13 and later, TCP is used automatically if DNS resolution using UDP fails.



#### NOTE

musl-based containers, including Alpine-based containers, do not support the **use-vc** option.

### RHOSP upgrade limitations

As a result of the RHOSP upgrade process, the Octavia API might be changed, and upgrades to the Amphora images that are used for load balancers might be required.

You can address API changes on an individual basis.

If the Amphora image is upgraded, the RHOSP operator can handle existing load balancer VMs in two ways:

- Upgrade each VM by triggering a [load balancer failover](#).
- Leave responsibility for upgrading the VMs to users.

If the operator takes the first option, there might be short downtimes during failovers.

If the operator takes the second option, the existing load balancers will not support upgraded Octavia API features, like UDP listeners. In this case, users must recreate their Services to use these features.

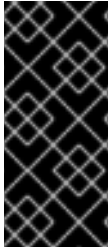

### IMPORTANT

If OpenShift Container Platform detects a new Octavia version that supports UDP load balancing, it recreates the DNS service automatically. The service recreation ensures that the service default supports UDP load balancing.

The recreation causes the DNS service approximately one minute of downtime.

#### 18.7.3.5. Control plane machines

By default, the OpenShift Container Platform installation process creates three control plane machines.

Each machine requires:

- An instance from the RHOSP quota
- A port from the RHOSP quota
- A flavor with at least 16 GB memory and 4 vCPUs
- At least 100 GB storage space from the RHOSP quota

#### 18.7.3.6. Compute machines

By default, the OpenShift Container Platform installation process creates three compute machines.

Each machine requires:

- An instance from the RHOSP quota
- A port from the RHOSP quota
- A flavor with at least 8 GB memory and 2 vCPUs
- At least 100 GB storage space from the RHOSP quota

### TIP

Compute machines host the applications that you run on OpenShift Container Platform; aim to run as many as you can.

#### 18.7.3.7. Bootstrap machine

During installation, a bootstrap machine is temporarily provisioned to stand up the control plane. After the production control plane is ready, the bootstrap machine is deprovisioned.

The bootstrap machine requires:

- An instance from the RHOSP quota
- A port from the RHOSP quota
- A flavor with at least 16 GB memory and 4 vCPUs

- At least 100 GB storage space from the RHOSP quota

### 18.7.4. Internet access for OpenShift Container Platform

In OpenShift Container Platform 4.10, you require access to the internet to install your cluster.

You must have internet access to:

- Access [OpenShift Cluster Manager](#) to download the installation program and perform subscription management. If the cluster has internet access and you do not disable Telemetry, that service automatically entitles your cluster.
- Access [Quay.io](#) to obtain the packages that are required to install your cluster.
- Obtain the packages that are required to perform cluster updates.



#### IMPORTANT

If your cluster cannot have direct internet access, you can perform a restricted network installation on some types of infrastructure that you provision. During that process, you download the required content and use it to populate a mirror registry with the installation packages. With some installation types, the environment that you install your cluster in will not require internet access. Before you update the cluster, you update the content of the mirror registry.

### 18.7.5. Downloading playbook dependencies

The Ansible playbooks that simplify the installation process on user-provisioned infrastructure require several Python modules. On the machine where you will run the installer, add the modules' repositories and then download them.



#### NOTE

These instructions assume that you are using Red Hat Enterprise Linux (RHEL) 8.

#### Prerequisites

- Python 3 is installed on your machine.

#### Procedure

1. On a command line, add the repositories:
  - a. Register with Red Hat Subscription Manager:

```
$ sudo subscription-manager register # If not done already
```

- b. Pull the latest subscription data:

```
$ sudo subscription-manager attach --pool=$YOUR_POOLID # If not done already
```

- c. Disable the current repositories:

```
$ sudo subscription-manager repos --disable=* # If not done already
```

- d. Add the required repositories:

```
$ sudo subscription-manager repos \
--enable=rhel-8-for-x86_64-baseos-rpms \
--enable=openstack-16-tools-for-rhel-8-x86_64-rpms \
--enable=ansible-2.9-for-rhel-8-x86_64-rpms \
--enable=rhel-8-for-x86_64-appstream-rpms
```

2. Install the modules:

```
$ sudo yum install python3-openstackclient ansible python3-openstacksdk python3-netaddr
```

3. Ensure that the **python** command points to **python3**:

```
$ sudo alternatives --set python /usr/bin/python3
```

### 18.7.6. Downloading the installation playbooks

Download Ansible playbooks that you can use to install OpenShift Container Platform on your own Red Hat OpenStack Platform (RHOSP) infrastructure.

#### Prerequisites

- The curl command-line tool is available on your machine.

#### Procedure

- To download the playbooks to your working directory, run the following script from a command line:

```
$ xargs -n 1 curl -O <<< '
  https://raw.githubusercontent.com/openshift/installer/release-
4.10/upi/openstack/bootstrap.yaml
  https://raw.githubusercontent.com/openshift/installer/release-
4.10/upi/openstack/common.yaml
  https://raw.githubusercontent.com/openshift/installer/release-
4.10/upi/openstack/compute-nodes.yaml
  https://raw.githubusercontent.com/openshift/installer/release-4.10/upi/openstack/control-
plane.yaml
  https://raw.githubusercontent.com/openshift/installer/release-
4.10/upi/openstack/inventory.yaml
  https://raw.githubusercontent.com/openshift/installer/release-
4.10/upi/openstack/network.yaml
  https://raw.githubusercontent.com/openshift/installer/release-
4.10/upi/openstack/security-groups.yaml
  https://raw.githubusercontent.com/openshift/installer/release-4.10/upi/openstack/down-
bootstrap.yaml
  https://raw.githubusercontent.com/openshift/installer/release-4.10/upi/openstack/down-
compute-nodes.yaml
  https://raw.githubusercontent.com/openshift/installer/release-4.10/upi/openstack/down-
control-plane.yaml
  https://raw.githubusercontent.com/openshift/installer/release-4.10/upi/openstack/down-
load-balancers.yaml
```



```

https://raw.githubusercontent.com/openshift/installer/release-4.10/upi/openstack/down-
network.yaml
https://raw.githubusercontent.com/openshift/installer/release-4.10/upi/openstack/down-
security-groups.yaml
https://raw.githubusercontent.com/openshift/installer/release-4.10/upi/openstack/down-
containers.yaml'

```

The playbooks are downloaded to your machine.



### IMPORTANT

During the installation process, you can modify the playbooks to configure your deployment.

Retain all playbooks for the life of your cluster. You must have the playbooks to remove your OpenShift Container Platform cluster from RHOSP.



### IMPORTANT

You must match any edits you make in the **bootstrap.yaml**, **compute-nodes.yaml**, **control-plane.yaml**, **network.yaml**, and **security-groups.yaml** files to the corresponding playbooks that are prefixed with **down-**. For example, edits to the **bootstrap.yaml** file must be reflected in the **down-bootstrap.yaml** file, too. If you do not edit both files, the supported cluster removal process will fail.

## 18.7.7. Obtaining the installation program

Before you install OpenShift Container Platform, download the installation file on a local computer.

### Prerequisites

- You have a computer that runs Linux or macOS, with 500 MB of local disk space

### Procedure

1. Access the [Infrastructure Provider](#) page on the OpenShift Cluster Manager site. If you have a Red Hat account, log in with your credentials. If you do not, create an account.
2. Select your infrastructure provider.
3. Navigate to the page for your installation type, download the installation program that corresponds with your host operating system and architecture, and place the file in the directory where you will store the installation configuration files.

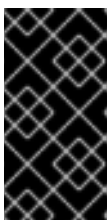

### IMPORTANT

The installation program creates several files on the computer that you use to install your cluster. You must keep the installation program and the files that the installation program creates after you finish installing the cluster. Both files are required to delete the cluster.



## IMPORTANT

Deleting the files created by the installation program does not remove your cluster, even if the cluster failed during installation. To remove your cluster, complete the OpenShift Container Platform uninstallation procedures for your specific cloud provider.

4. Extract the installation program. For example, on a computer that uses a Linux operating system, run the following command:

```
$ tar -xvf openshift-install-linux.tar.gz
```

5. Download your installation [pull secret from the Red Hat OpenShift Cluster Manager](#) . This pull secret allows you to authenticate with the services that are provided by the included authorities, including Quay.io, which serves the container images for OpenShift Container Platform components.

### 18.7.8. Generating a key pair for cluster node SSH access

During an OpenShift Container Platform installation, you can provide an SSH public key to the installation program. The key is passed to the Red Hat Enterprise Linux CoreOS (RHCOS) nodes through their Ignition config files and is used to authenticate SSH access to the nodes. The key is added to the `~/.ssh/authorized_keys` list for the **core** user on each node, which enables password-less authentication.

After the key is passed to the nodes, you can use the key pair to SSH in to the RHCOS nodes as the user **core**. To access the nodes through SSH, the private key identity must be managed by SSH for your local user.

If you want to SSH in to your cluster nodes to perform installation debugging or disaster recovery, you must provide the SSH public key during the installation process. The `./openshift-install gather` command also requires the SSH public key to be in place on the cluster nodes.



## IMPORTANT

Do not skip this procedure in production environments, where disaster recovery and debugging is required.

### Procedure

1. If you do not have an existing SSH key pair on your local machine to use for authentication onto your cluster nodes, create one. For example, on a computer that uses a Linux operating system, run the following command:

```
$ ssh-keygen -t ed25519 -N "" -f <path>/<file_name> 1
```

- 1** Specify the path and file name, such as `~/.ssh/id_ed25519`, of the new SSH key. If you have an existing key pair, ensure your public key is in the your `~/.ssh` directory.

**NOTE**

If you plan to install an OpenShift Container Platform cluster that uses FIPS validated or Modules In Process cryptographic libraries on the **x86\_64** architecture, do not create a key that uses the **ed25519** algorithm. Instead, create a key that uses the **rsa** or **ecdsa** algorithm.

- View the public SSH key:

```
$ cat <path>/<file_name>.pub
```

For example, run the following to view the `~/.ssh/id_ed25519.pub` public key:

```
$ cat ~/.ssh/id_ed25519.pub
```

- Add the SSH private key identity to the SSH agent for your local user, if it has not already been added. SSH agent management of the key is required for password-less SSH authentication onto your cluster nodes, or if you want to use the `./openshift-install gather` command.

**NOTE**

On some distributions, default SSH private key identities such as `~/.ssh/id_rsa` and `~/.ssh/id_dsa` are managed automatically.

- If the **ssh-agent** process is not already running for your local user, start it as a background task:

```
$ eval "$(ssh-agent -s)"
```

**Example output**

```
Agent pid 31874
```

**NOTE**

If your cluster is in FIPS mode, only use FIPS-compliant algorithms to generate the SSH key. The key must be either RSA or ECDSA.

- Add your SSH private key to the **ssh-agent**:

```
$ ssh-add <path>/<file_name> 1
```

- 1** Specify the path and file name for your SSH private key, such as `~/.ssh/id_ed25519`

**Example output**

```
Identity added: /home/<you>/<path>/<file_name> (<computer_name>)
```

**Next steps**

- When you install OpenShift Container Platform, provide the SSH public key to the installation program.

### 18.7.9. Creating the Red Hat Enterprise Linux CoreOS (RHCOS) image

The OpenShift Container Platform installation program requires that a Red Hat Enterprise Linux CoreOS (RHCOS) image be present in the Red Hat OpenStack Platform (RHOSP) cluster. Retrieve the latest RHCOS image, then upload it using the RHOSP CLI.

#### Prerequisites

- The RHOSP CLI is installed.

#### Procedure

1. Log in to the Red Hat Customer Portal's [Product Downloads page](#).
2. Under **Version**, select the most recent release of OpenShift Container Platform 4.10 for Red Hat Enterprise Linux (RHEL) 8.

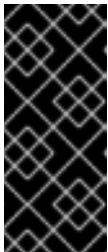

#### IMPORTANT

The RHCOS images might not change with every release of OpenShift Container Platform. You must download images with the highest version that is less than or equal to the OpenShift Container Platform version that you install. Use the image versions that match your OpenShift Container Platform version if they are available.

3. Download the *Red Hat Enterprise Linux CoreOS (RHCOS) - OpenStack Image (QCOW)*.
4. Decompress the image.



#### NOTE

You must decompress the RHOSP image before the cluster can use it. The name of the downloaded file might not contain a compression extension, like **.gz** or **.tgz**. To find out if or how the file is compressed, in a command line, enter:

```
$ file <name_of_downloaded_file>
```

5. From the image that you downloaded, create an image that is named **rhcos** in your cluster by using the RHOSP CLI:

```
$ openstack image create --container-format=bare --disk-format=qcow2 --file rhcos-
${RHCOS_VERSION}-openstack.qcow2 rhcos
```

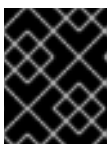

#### IMPORTANT

Depending on your RHOSP environment, you might be able to upload the image in either **.raw** or **.qcow2** formats. If you use Ceph, you must use the **.raw** format.

**WARNING**

If the installation program finds multiple images with the same name, it chooses one of them at random. To avoid this behavior, create unique names for resources in RHOSP.

After you upload the image to RHOSP, it is usable in the installation process.

**18.7.10. Verifying external network access**

The OpenShift Container Platform installation process requires external network access. You must provide an external network value to it, or deployment fails. Before you begin the process, verify that a network with the external router type exists in Red Hat OpenStack Platform (RHOSP).

**Prerequisites**

- [Configure OpenStack's networking service to have DHCP agents forward instances' DNS queries](#)

**Procedure**

1. Using the RHOSP CLI, verify the name and ID of the 'External' network:

```
$ openstack network list --long -c ID -c Name -c "Router Type"
```

**Example output**

```
+-----+-----+-----+
| ID                | Name          | Router Type |
+-----+-----+-----+
| 148a8023-62a7-4672-b018-003462f8d7dc | public_network | External    |
+-----+-----+-----+
```

A network with an external router type appears in the network list. If at least one does not, see [Creating a default floating IP network](#) and [Creating a default provider network](#).

**NOTE**

If the Neutron trunk service plugin is enabled, a trunk port is created by default. For more information, see [Neutron trunk port](#).

**18.7.11. Enabling access to the environment**

At deployment, all OpenShift Container Platform machines are created in a Red Hat OpenStack Platform (RHOSP)-tenant network. Therefore, they are not accessible directly in most RHOSP deployments.

You can configure OpenShift Container Platform API and application access by using floating IP addresses (FIPs) during installation. You can also complete an installation without configuring FIPs, but the installer will not configure a way to reach the API or applications externally.

### 18.7.11.1. Enabling access with floating IP addresses

Create floating IP (FIP) addresses for external access to the OpenShift Container Platform API, cluster applications, and the bootstrap process.

#### Procedure

1. Using the Red Hat OpenStack Platform (RHOSP) CLI, create the API FIP:

```
$ openstack floating ip create --description "API <cluster_name>.<base_domain>"  
<external_network>
```

2. Using the Red Hat OpenStack Platform (RHOSP) CLI, create the apps, or Ingress, FIP:

```
$ openstack floating ip create --description "Ingress <cluster_name>.<base_domain>"  
<external_network>
```

3. By using the Red Hat OpenStack Platform (RHOSP) CLI, create the bootstrap FIP:

```
$ openstack floating ip create --description "bootstrap machine" <external_network>
```

4. Add records that follow these patterns to your DNS server for the API and Ingress FIPs:

```
api.<cluster_name>.<base_domain>. IN A <API_FIP>  
*.apps.<cluster_name>.<base_domain>. IN A <apps_FIP>
```



## NOTE

If you do not control the DNS server, you can access the cluster by adding the cluster domain names such as the following to your `/etc/hosts` file:

- `<api_floating_ip> api.<cluster_name>.<base_domain>`
- `<application_floating_ip> grafana-openshift-monitoring.apps.<cluster_name>.<base_domain>`
- `<application_floating_ip> prometheus-k8s-openshift-monitoring.apps.<cluster_name>.<base_domain>`
- `<application_floating_ip> oauth-openshift.apps.<cluster_name>.<base_domain>`
- `<application_floating_ip> console-openshift-console.apps.<cluster_name>.<base_domain>`
- `application_floating_ip integrated-oauth-server-openshift-authentication.apps.<cluster_name>.<base_domain>`

The cluster domain names in the `/etc/hosts` file grant access to the web console and the monitoring interface of your cluster locally. You can also use the `kubectl` or `oc`. You can access the user applications by using the additional entries pointing to the `<application_floating_ip>`. This action makes the API and applications accessible to only you, which is not suitable for production deployment, but does allow installation for development and testing.

5. Add the FIPs to the `inventory.yaml` file as the values of the following variables:

- `os_api_fip`
- `os_bootstrap_fip`
- `os_ingress_fip`

If you use these values, you must also enter an external network as the value of the `os_external_network` variable in the `inventory.yaml` file.

## TIP

You can make OpenShift Container Platform resources available outside of the cluster by assigning a floating IP address and updating your firewall configuration.

### 18.7.11.2. Completing installation without floating IP addresses

You can install OpenShift Container Platform on Red Hat OpenStack Platform (RHOSP) without providing floating IP addresses.

In the `inventory.yaml` file, do not define the following variables:

- `os_api_fip`
- `os_bootstrap_fip`

- **os\_ingress\_fip**

If you cannot provide an external network, you can also leave **os\_external\_network** blank. If you do not provide a value for **os\_external\_network**, a router is not created for you, and, without additional action, the installer will fail to retrieve an image from Glance. Later in the installation process, when you create network resources, you must configure external connectivity on your own.

If you run the installer with the **wait-for** command from a system that cannot reach the cluster API due to a lack of floating IP addresses or name resolution, installation fails. To prevent installation failure in these cases, you can use a proxy network or run the installer from a system that is on the same network as your machines.



#### NOTE

You can enable name resolution by creating DNS records for the API and Ingress ports. For example:

```
api.<cluster_name>.<base_domain>. IN A <api_port_IP>
*.apps.<cluster_name>.<base_domain>. IN A <ingress_port_IP>
```

If you do not control the DNS server, you can add the record to your **/etc/hosts** file. This action makes the API accessible to only you, which is not suitable for production deployment but does allow installation for development and testing.

## 18.7.12. Defining parameters for the installation program

The OpenShift Container Platform installation program relies on a file that is called **clouds.yaml**. The file describes Red Hat OpenStack Platform (RHOSP) configuration parameters, including the project name, log in information, and authorization service URLs.

### Procedure

1. Create the **clouds.yaml** file:
  - If your RHOSP distribution includes the Horizon web UI, generate a **clouds.yaml** file in it.



#### IMPORTANT

Remember to add a password to the **auth** field. You can also keep secrets in [a separate file](#) from **clouds.yaml**.

- If your RHOSP distribution does not include the Horizon web UI, or you do not want to use Horizon, create the file yourself. For detailed information about **clouds.yaml**, see [Config files](#) in the RHOSP documentation.

```
clouds:
  shiftstack:
    auth:
      auth_url: http://10.10.14.42:5000/v3
      project_name: shiftstack
      username: <username>
      password: <password>
      user_domain_name: Default
      project_domain_name: Default
```



```
dev-env:
  region_name: RegionOne
  auth:
    username: <username>
    password: <password>
    project_name: 'devonly'
    auth_url: 'https://10.10.14.22:5001/v2.0'
```

2. If your RHOSP installation uses self-signed certificate authority (CA) certificates for endpoint authentication:
  - a. Copy the certificate authority file to your machine.
  - b. Add the **cacerts** key to the **clouds.yaml** file. The value must be an absolute, non-root-accessible path to the CA certificate:

```
clouds:
  shiftstack:
  ...
  cacert: "/etc/pki/ca-trust/source/anchors/ca.crt.pem"
```

### TIP

After you run the installer with a custom CA certificate, you can update the certificate by editing the value of the **ca-cert.pem** key in the **cloud-provider-config** keymap. On a command line, run:

```
$ oc edit configmap -n openshift-config cloud-provider-config
```

3. Place the **clouds.yaml** file in one of the following locations:
  - a. The value of the **OS\_CLIENT\_CONFIG\_FILE** environment variable
  - b. The current directory
  - c. A Unix-specific user configuration directory, for example **~/.config/openstack/clouds.yaml**
  - d. A Unix-specific site configuration directory, for example **/etc/openstack/clouds.yaml**  
The installation program searches for **clouds.yaml** in that order.

### 18.7.13. Creating the installation configuration file

You can customize the OpenShift Container Platform cluster you install on Red Hat OpenStack Platform (RHOSP).

#### Prerequisites

- Obtain the OpenShift Container Platform installation program and the pull secret for your cluster.
- Obtain service principal permissions at the subscription level.

#### Procedure

1. Create the **install-config.yaml** file.
  - a. Change to the directory that contains the installation program and run the following command:

```
$ ./openshift-install create install-config --dir <installation_directory> 1
```

- 1** For **<installation\_directory>**, specify the directory name to store the files that the installation program creates.



### IMPORTANT

Specify an empty directory. Some installation assets, like bootstrap X.509 certificates have short expiration intervals, so you must not reuse an installation directory. If you want to reuse individual files from another cluster installation, you can copy them into your directory. However, the file names for the installation assets might change between releases. Use caution when copying installation files from an earlier OpenShift Container Platform version.

- b. At the prompts, provide the configuration details for your cloud:
    - i. Optional: Select an SSH key to use to access your cluster machines.



### NOTE

For production OpenShift Container Platform clusters on which you want to perform installation debugging or disaster recovery, specify an SSH key that your **ssh-agent** process uses.

- ii. Select **openstack** as the platform to target.
        - iii. Specify the Red Hat OpenStack Platform (RHOSP) external network name to use for installing the cluster.
        - iv. Specify the floating IP address to use for external access to the OpenShift API.
        - v. Specify a RHOSP flavor with at least 16 GB RAM to use for control plane nodes and 8 GB RAM for compute nodes.
        - vi. Select the base domain to deploy the cluster to. All DNS records will be sub-domains of this base and will also include the cluster name.
        - vii. Enter a name for your cluster. The name must be 14 or fewer characters long.
        - viii. Paste the [pull secret from the Red Hat OpenShift Cluster Manager](#) .
2. Modify the **install-config.yaml** file. You can find more information about the available parameters in the "Installation configuration parameters" section.
  3. Back up the **install-config.yaml** file so that you can use it to install multiple clusters.

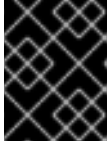
**IMPORTANT**

The **install-config.yaml** file is consumed during the installation process. If you want to reuse the file, you must back it up now.

You now have the file **install-config.yaml** in the directory that you specified.

### 18.7.14. Installation configuration parameters

Before you deploy an OpenShift Container Platform cluster, you provide parameter values to describe your account on the cloud platform that hosts your cluster and optionally customize your cluster's platform. When you create the **install-config.yaml** installation configuration file, you provide values for the required parameters through the command line. If you customize your cluster, you can modify the **install-config.yaml** file to provide more details about the platform.

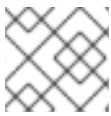
**NOTE**

After installation, you cannot modify these parameters in the **install-config.yaml** file.

#### 18.7.14.1. Required configuration parameters

Required installation configuration parameters are described in the following table:

Table 18.28. Required parameters

Parameter	Description	Values
<b>apiVersion</b>	The API version for the <b>install-config.yaml</b> content. The current version is <b>v1</b> . The installer may also support older API versions.	String
<b>baseDomain</b>	The base domain of your cloud provider. The base domain is used to create routes to your OpenShift Container Platform cluster components. The full DNS name for your cluster is a combination of the <b>baseDomain</b> and <b>metadata.name</b> parameter values that uses the <b>&lt;metadata.name&gt;</b> . <b>&lt;baseDomain&gt;</b> format.	A fully-qualified domain or subdomain name, such as <b>example.com</b> .
<b>metadata</b>	Kubernetes resource <b>ObjectMeta</b> , from which only the <b>name</b> parameter is consumed.	Object

Parameter	Description	Values
<b>metadata.name</b>	The name of the cluster. DNS records for the cluster are all subdomains of <b>{{.metadata.name}}.{{.baseDomain}}</b> .	String of lowercase letters, hyphens (-), and periods (.), such as <b>dev</b> . The string must be 14 characters or fewer long.
<b>platform</b>	The configuration for the specific platform upon which to perform the installation: <b>alibabacloud, aws, baremetal, azure, gcp, ibmcloud, openstack, ovirt, vsphere</b> , or <b>{}</b> . For additional information about <b>platform.&lt;platform&gt;</b> parameters, consult the table for your specific platform that follows.	Object
<b>pullSecret</b>	Get a <a href="#">pull secret from the Red Hat OpenShift Cluster Manager</a> to authenticate downloading container images for OpenShift Container Platform components from services such as Quay.io.	<pre>{   "auths":{     "cloud.openshift.com":{       "auth":"b3Blb=",       "email":"you@example.com"     },     "quay.io":{       "auth":"b3Blb=",       "email":"you@example.com"     }   } }</pre>

### 18.7.14.2. Network configuration parameters

You can customize your installation configuration based on the requirements of your existing network infrastructure. For example, you can expand the IP address block for the cluster network or provide different IP address blocks than the defaults.

Only IPv4 addresses are supported.

Table 18.29. Network parameters

Parameter	Description	Values
-----------	-------------	--------

Parameter	Description	Values
<b>networking</b>	The configuration for the cluster network.	Object  <b>NOTE</b> You cannot modify parameters specified by the <b>networking</b> object after installation.
<b>networking.networkType</b>	The cluster network provider Container Network Interface (CNI) plugin to install.	Either <b>OpenShiftSDN</b> or <b>OVNKubernetes</b> . <b>OpenShiftSDN</b> is a CNI provider for all-Linux networks. <b>OVNKubernetes</b> is a CNI provider for Linux networks and hybrid networks that contain both Linux and Windows servers. The default value is <b>OpenShiftSDN</b> .
<b>networking.clusterNetwork</b>	The IP address blocks for pods.  The default value is <b>10.128.0.0/14</b> with a host prefix of <b>/23</b> .  If you specify multiple IP address blocks, the blocks must not overlap.	An array of objects. For example:  <pre>networking:   clusterNetwork:     - cidr: 10.128.0.0/14       hostPrefix: 23</pre>
<b>networking.clusterNetwork.cidr</b>	Required if you use <b>networking.clusterNetwork</b> . An IP address block.  An IPv4 network.	An IP address block in Classless Inter-Domain Routing (CIDR) notation. The prefix length for an IPv4 block is between <b>0</b> and <b>32</b> .
<b>networking.clusterNetwork.hostPrefix</b>	The subnet prefix length to assign to each individual node. For example, if <b>hostPrefix</b> is set to <b>23</b> then each node is assigned a <b>/23</b> subnet out of the given <b>cidr</b> . A <b>hostPrefix</b> value of <b>23</b> provides 510 ( $2^{(32 - 23)} - 2$ ) pod IP addresses.	A subnet prefix.  The default value is <b>23</b> .
<b>networking.serviceNetwork</b>	The IP address block for services. The default value is <b>172.30.0.0/16</b> .  The OpenShift SDN and OVN-Kubernetes network providers support only a single IP address block for the service network.	An array with an IP address block in CIDR format. For example:  <pre>networking:   serviceNetwork:     - 172.30.0.0/16</pre>

Parameter	Description	Values
<b>networking.machineNetwork</b>	The IP address blocks for machines.  If you specify multiple IP address blocks, the blocks must not overlap.	An array of objects. For example:  <pre>networking:   machineNetwork:   - cidr: 10.0.0.0/16</pre>
<b>networking.machineNetwork.cidr</b>	Required if you use <b>networking.machineNetwork</b> . An IP address block. The default value is <b>10.0.0.0/16</b> for all platforms other than libvirt. For libvirt, the default value is <b>192.168.126.0/24</b> .	An IP network block in CIDR notation.  For example, <b>10.0.0.0/16</b> .   <p><b>NOTE</b></p> <p>Set the <b>networking.machineNetwork</b> to match the CIDR that the preferred NIC resides in.</p>

### 18.7.14.3. Optional configuration parameters

Optional installation configuration parameters are described in the following table:



Table 18.30. Optional parameters

Parameter	Description	Values
<b>additionalTrustBundle</b>	A PEM-encoded X.509 certificate bundle that is added to the nodes' trusted certificate store. This trust bundle may also be used when a proxy has been configured.	String
<b>cgroupsV2</b>	Enables <a href="#">Linux control groups version 2</a> (cgroups v2) on specific nodes in your cluster. The OpenShift Container Platform process for enabling cgroups v2 disables all cgroup version 1 controllers and hierarchies. The OpenShift Container Platform cgroups version 2 feature is in Developer Preview and is not supported by Red Hat at this time.	<b>true</b>
<b>compute</b>	The configuration for the machines that comprise the compute nodes.	Array of <b>MachinePool</b> objects.



Parameter	Description	Values
<b>compute.architecture</b>	Determines the instruction set architecture of the machines in the pool. Currently, clusters with varied architectures are not supported. All pools must specify the same architecture. Valid values are <b>amd64</b> (the default).	String
<b>compute.hyperthreading</b>	<p>Whether to enable or disable simultaneous multithreading, or <b>hyperthreading</b>, on compute machines. By default, simultaneous multithreading is enabled to increase the performance of your machines' cores.</p> <div style="display: flex; align-items: center;">  <div> <p><b>IMPORTANT</b></p> <p>If you disable simultaneous multithreading, ensure that your capacity planning accounts for the dramatically decreased machine performance.</p> </div> </div>	<b>Enabled</b> or <b>Disabled</b>
<b>compute.name</b>	Required if you use <b>compute</b> . The name of the machine pool.	<b>worker</b>
<b>compute.platform</b>	Required if you use <b>compute</b> . Use this parameter to specify the cloud provider to host the worker machines. This parameter value must match the <b>controlPlane.platform</b> parameter value.	<b>alibabacloud, aws, azure, gcp, ibmcloud, openstack, ovirt, vsphere</b> , or <b>{}</b>
<b>compute.replicas</b>	The number of compute machines, which are also known as worker machines, to provision.	A positive integer greater than or equal to <b>2</b> . The default value is <b>3</b> .
<b>controlPlane</b>	The configuration for the machines that comprise the control plane.	Array of <b>MachinePool</b> objects.

Parameter	Description	Values
<b>controlPlane.architecture</b>	Determines the instruction set architecture of the machines in the pool. Currently, clusters with varied architectures are not supported. All pools must specify the same architecture. Valid values are <b>amd64</b> (the default).	String
<b>controlPlane.hyperthreading</b>	<p>Whether to enable or disable simultaneous multithreading, or <b>hyperthreading</b>, on control plane machines. By default, simultaneous multithreading is enabled to increase the performance of your machines' cores.</p> <div style="display: flex; align-items: center;">  <div> <p><b>IMPORTANT</b></p> <p>If you disable simultaneous multithreading, ensure that your capacity planning accounts for the dramatically decreased machine performance.</p> </div> </div>	<b>Enabled</b> or <b>Disabled</b>
<b>controlPlane.name</b>	Required if you use <b>controlPlane</b> . The name of the machine pool.	<b>master</b>
<b>controlPlane.platform</b>	Required if you use <b>controlPlane</b> . Use this parameter to specify the cloud provider that hosts the control plane machines. This parameter value must match the <b>compute.platform</b> parameter value.	<b>alibabacloud, aws, azure, gcp, ibmcloud, openstack, ovirt, vsphere, or {}</b>
<b>controlPlane.replicas</b>	The number of control plane machines to provision.	The only supported value is <b>3</b> , which is the default value.



Parameter	Description	Values
<b>credentialsMode</b>	<p>The Cloud Credential Operator (CCO) mode. If no mode is specified, the CCO dynamically tries to determine the capabilities of the provided credentials, with a preference for mint mode on the platforms where multiple modes are supported.</p> <div data-bbox="485 512 595 864" style="border: 1px solid black; padding: 5px; margin-bottom: 10px;">  </div> <p><b>NOTE</b></p> <p>Not all CCO modes are supported for all cloud providers. For more information on CCO modes, see the <i>Cloud Credential Operator</i> entry in the <i>Cluster Operators reference content</i>.</p> <div data-bbox="485 909 595 1261" style="border: 1px solid black; padding: 5px;">  </div> <p><b>NOTE</b></p> <p>If your AWS account has service control policies (SCP) enabled, you must configure the <b>credentialsMode</b> parameter to <b>Mint</b>, <b>Passthrough</b> or <b>Manual</b>.</p>	<b>Mint, Passthrough, Manual</b> or an empty string ("").

Parameter	Description	Values
<b>fips</b>	<p>Enable or disable FIPS mode. The default is <b>false</b> (disabled). If FIPS mode is enabled, the Red Hat Enterprise Linux CoreOS (RHCOS) machines that OpenShift Container Platform runs on bypass the default Kubernetes cryptography suite and use the cryptography modules that are provided with RHCOS instead.</p> <div style="display: flex; align-items: flex-start;"> <div style="width: 20px; height: 100px; background: repeating-linear-gradient(45deg, transparent, transparent 2px, black 2px, black 4px); margin-right: 10px;"></div> <div> <p><b>IMPORTANT</b></p> <p>To enable FIPS mode for your cluster, you must run the installation program from a Red Hat Enterprise Linux (RHEL) computer configured to operate in FIPS mode. For more information about configuring FIPS mode on RHEL, see <a href="#">Installing the system in FIPS mode</a>. The use of FIPS validated or Modules In Process cryptographic libraries is only supported on OpenShift Container Platform deployments on the <b>x86_64</b> architecture.</p> </div> </div> <div style="display: flex; align-items: flex-start; margin-top: 10px;"> <div style="width: 20px; height: 100px; background: repeating-linear-gradient(45deg, transparent, transparent 2px, black 2px, black 4px); margin-right: 10px;"></div> <div> <p><b>NOTE</b></p> <p>If you are using Azure File storage, you cannot enable FIPS mode.</p> </div> </div>	<b>false</b> or <b>true</b>
<b>imageContentSources</b>	Sources and repositories for the release-image content.	Array of objects. Includes a <b>source</b> and, optionally, <b>mirrors</b> , as described in the following rows of this table.
<b>imageContentSources.source</b>	Required if you use <b>imageContentSources</b> . Specify the repository that users refer to, for example, in image pull specifications.	String
<b>imageContentSources.mirrors</b>	Specify one or more repositories that may also contain the same images.	Array of strings

Parameter	Description	Values
<b>publish</b>	How to publish or expose the user-facing endpoints of your cluster, such as the Kubernetes API, OpenShift routes.	<p><b>Internal</b> or <b>External</b>. The default value is <b>External</b>.</p> <p>Setting this field to <b>Internal</b> is not supported on non-cloud platforms and IBM Cloud VPC.</p> <div style="display: flex; align-items: flex-start;">  <div> <p><b>IMPORTANT</b></p> <p>If the value of the field is set to <b>Internal</b>, the cluster will become non-functional. For more information, refer to <a href="#">BZ#1953035</a>.</p> </div> </div>
<b>sshKey</b>	<p>The SSH key or keys to authenticate access your cluster machines.</p> <div style="display: flex; align-items: flex-start;">  <div> <p><b>NOTE</b></p> <p>For production OpenShift Container Platform clusters on which you want to perform installation debugging or disaster recovery, specify an SSH key that your <b>ssh-agent</b> process uses.</p> </div> </div>	<p>One or more keys. For example:</p> <pre>sshKey:   &lt;key1&gt;   &lt;key2&gt;   &lt;key3&gt;</pre>

#### 18.7.14.4. Additional Red Hat OpenStack Platform (RHOSP) configuration parameters

Additional RHOSP configuration parameters are described in the following table:

Table 18.31. Additional RHOSP parameters

Parameter	Description	Values
<b>compute.platform.openstack.rootVolume.size</b>	For compute machines, the size in gigabytes of the root volume. If you do not set this value, machines use ephemeral storage.	Integer, for example <b>30</b> .
<b>compute.platform.openstack.rootVolume.type</b>	For compute machines, the root volume's type.	String, for example <b>performance</b> .

Parameter	Description	Values
<b>controlPlane.platform.openstack.rootVolume.size</b>	For control plane machines, the size in gigabytes of the root volume. If you do not set this value, machines use ephemeral storage.	Integer, for example <b>30</b> .
<b>controlPlane.platform.openstack.rootVolume.type</b>	For control plane machines, the root volume's type.	String, for example <b>performance</b> .
<b>platform.openstack.cloud</b>	The name of the RHOSP cloud to use from the list of clouds in the <b>clouds.yaml</b> file.	String, for example <b>MyCloud</b> .
<b>platform.openstack.externalNetwork</b>	The RHOSP external network name to be used for installation.	String, for example <b>external</b> .
<b>platform.openstack.computeFlavor</b>	<p>The RHOSP flavor to use for control plane and compute machines.</p> <p>This property is deprecated. To use a flavor as the default for all machine pools, add it as the value of the <b>type</b> key in the <b>platform.openstack.defaultMachinePlatform</b> property. You can also set a flavor value for each machine pool individually.</p>	String, for example <b>m1.xlarge</b> .

#### 18.7.14.5. Optional RHOSP configuration parameters

Optional RHOSP configuration parameters are described in the following table:

Table 18.32. Optional RHOSP parameters

Parameter	Description	Values
<b>compute.platform.openstack.additionalNetworkIds</b>	Additional networks that are associated with compute machines. Allowed address pairs are not created for additional networks.	A list of one or more UUIDs as strings. For example, <b>fa806b2f-ac49-4bce-b9db-124bc64209bf</b> .

Parameter	Description	Values
<b>compute.platform.openstack.additionalSecurityGroupIDs</b>	Additional security groups that are associated with compute machines.	A list of one or more UUIDs as strings. For example, <b>7ee219f3-d2e9-48a1-96c2-e7429f1b0da7</b> .
<b>compute.platform.openstack.zones</b>	<p>RHOSP Compute (Nova) availability zones (AZs) to install machines on. If this parameter is not set, the installer relies on the default settings for Nova that the RHOSP administrator configured.</p> <p>On clusters that use Kuryr, RHOSP Octavia does not support availability zones. Load balancers and, if you are using the Amphora provider driver, OpenShift Container Platform services that rely on Amphora VMs, are not created according to the value of this property.</p>	A list of strings. For example, <b>["zone-1", "zone-2"]</b> .
<b>compute.platform.openstack.rootVolume.zones</b>	For compute machines, the availability zone to install root volumes on. If you do not set a value for this parameter, the installer selects the default availability zone.	A list of strings, for example <b>["zone-1", "zone-2"]</b> .

Parameter	Description	Values
<b>compute.platform.openstack.serverGroupPolicy</b>	<p>Server group policy to apply to the group that will contain the compute machines in the pool. You cannot change server group policies or affiliations after creation. Supported options include <b>anti-affinity</b>, <b>soft-affinity</b>, and <b>soft-anti-affinity</b>. The default value is <b>soft-anti-affinity</b>.</p> <p>An <b>affinity</b> policy prevents migrations and therefore affects RHOSP upgrades. The <b>affinity</b> policy is not supported.</p> <p>If you use a strict <b>anti-affinity</b> policy, an additional RHOSP host is required during instance migration.</p>	A server group policy to apply to the machine pool. For example, <b>soft-affinity</b> .
<b>controlPlane.platform.openstack.additionalNetworkIDs</b>	Additional networks that are associated with control plane machines. Allowed address pairs are not created for additional networks.	A list of one or more UUIDs as strings. For example, <b>fa806b2f-ac49-4bce-b9db-124bc64209bf</b> .
<b>controlPlane.platform.openstack.additionalSecurityGroupIDs</b>	Additional security groups that are associated with control plane machines.	A list of one or more UUIDs as strings. For example, <b>7ee219f3-d2e9-48a1-96c2-e7429f1b0da7</b> .

Parameter	Description	Values
<b>controlPlane.placement.openstack.zones</b>	<p>RHOSP Compute (Nova) availability zones (AZs) to install machines on. If this parameter is not set, the installer relies on the default settings for Nova that the RHOSP administrator configured.</p> <p>On clusters that use Kuryr, RHOSP Octavia does not support availability zones. Load balancers and, if you are using the Amphora provider driver, OpenShift Container Platform services that rely on Amphora VMs, are not created according to the value of this property.</p>	<p>A list of strings. For example, <b>["zone-1", "zone-2"]</b>.</p>
<b>controlPlane.placement.openstack.rootVolume.zones</b>	<p>For control plane machines, the availability zone to install root volumes on. If you do not set this value, the installer selects the default availability zone.</p>	<p>A list of strings, for example <b>["zone-1", "zone-2"]</b>.</p>
<b>controlPlane.placement.openstack.serverGroupPolicy</b>	<p>Server group policy to apply to the group that will contain the control plane machines in the pool. You cannot change server group policies or affiliations after creation. Supported options include <b>anti-affinity</b>, <b>soft-affinity</b>, and <b>soft-anti-affinity</b>. The default value is <b>soft-anti-affinity</b>.</p> <p>An <b>affinity</b> policy prevents migrations, and therefore affects RHOSP upgrades. The <b>affinity</b> policy is not supported.</p> <p>If you use a strict <b>anti-affinity</b> policy, an additional RHOSP host is required during instance migration.</p>	<p>A server group policy to apply to the machine pool. For example, <b>soft-affinity</b>.</p>

Parameter	Description	Values
<b>platform.openstack.clusterOSImage</b>	<p>The location from which the installer downloads the RHCOS image.</p> <p>You must set this parameter to perform an installation in a restricted network.</p>	<p>An HTTP or HTTPS URL, optionally with an SHA-256 checksum.</p> <p>For example,  <b>http://mirror.example.com/images/rhcos-43.81.201912131630.0-openstack.x86_64.qcow2.gz?sha256=ffebbd68e8a1f2a245ca19522c16c86f67f9ac8e4e0c1f0a812b068b16f7265d</b>. The value can also be the name of an existing Glance image, for example <b>my-rhcos</b>.</p>
<b>platform.openstack.clusterOSImageProperties</b>	<p>Properties to add to the installer-uploaded ClusterOSImage in Glance. This property is ignored if <b>platform.openstack.clusterOSImage</b> is set to an existing Glance image.</p> <p>You can use this property to exceed the default persistent volume (PV) limit for RHOSP of 26 PVs per node. To exceed the limit, set the <b>hw_scsi_model</b> property value to <b>virtio-scsi</b> and the <b>hw_disk_bus</b> value to <b>scsi</b>.</p> <p>You can also use this property to enable the QEMU guest agent by including the <b>hw_qemu_guest_agent</b> property with a value of <b>yes</b>.</p>	<p>A list of key-value string pairs. For example, <b>["hw_scsi_model": "virtio-scsi", "hw_disk_bus": "scsi"]</b>.</p>
<b>platform.openstack.defaultMachinePlatform</b>	<p>The default machine pool platform configuration.</p>	<pre>{   "type": "ml.large",   "rootVolume": {     "size": 30,     "type": "performance"   } }</pre>
<b>platform.openstack.ingressFloatingIP</b>	<p>An existing floating IP address to associate with the Ingress port. To use this property, you must also define the <b>platform.openstack.externalNetwork</b> property.</p>	<p>An IP address, for example <b>128.0.0.1</b>.</p>



Parameter	Description	Values
<b>platform.openstack.apiFloatingIP</b>	An existing floating IP address to associate with the API load balancer. To use this property, you must also define the <b>platform.openstack.externalNetwork</b> property.	An IP address, for example <b>128.0.0.1</b> .
<b>platform.openstack.externalDNS</b>	IP addresses for external DNS servers that cluster instances use for DNS resolution.	A list of IP addresses as strings. For example, <b>["8.8.8.8", "192.168.1.12"]</b> .
<b>platform.openstack.machinesSubnet</b>	<p>The UUID of a RHOSP subnet that the cluster's nodes use. Nodes and virtual IP (VIP) ports are created on this subnet.</p> <p>The first item in <b>networking.machineNetwork</b> must match the value of <b>machinesSubnet</b>.</p> <p>If you deploy to a custom subnet, you cannot specify an external DNS server to the OpenShift Container Platform installer. Instead, <a href="#">add DNS to the subnet in RHOSP</a>.</p>	A UUID as a string. For example, <b>fa806b2f-ac49-4bce-b9db-124bc64209bf</b> .

#### 18.7.14.6. Custom subnets in RHOSP deployments

Optionally, you can deploy a cluster on a Red Hat OpenStack Platform (RHOSP) subnet of your choice. The subnet's GUID is passed as the value of **platform.openstack.machinesSubnet** in the **install-config.yaml** file.

This subnet is used as the cluster's primary subnet. By default, nodes and ports are created on it. You can create nodes and ports on a different RHOSP subnet by setting the value of the **platform.openstack.machinesSubnet** property to the subnet's UUID.

Before you run the OpenShift Container Platform installer with a custom subnet, verify that your configuration meets the following requirements:

- The subnet that is used by **platform.openstack.machinesSubnet** has DHCP enabled.
- The CIDR of **platform.openstack.machinesSubnet** matches the CIDR of **networking.machineNetwork**.
- The installation program user has permission to create ports on this network, including ports with fixed IP addresses.

Clusters that use custom subnets have the following limitations:

- If you plan to install a cluster that uses floating IP addresses, the **platform.openstack.machinesSubnet** subnet must be attached to a router that is connected to the **externalNetwork** network.
- If the **platform.openstack.machinesSubnet** value is set in the **install-config.yaml** file, the installation program does not create a private network or subnet for your RHOSP machines.
- You cannot use the **platform.openstack.externalDNS** property at the same time as a custom subnet. To add DNS to a cluster that uses a custom subnet, configure DNS on the RHOSP network.



#### NOTE

By default, the API VIP takes x.x.x.5 and the Ingress VIP takes x.x.x.7 from your network's CIDR block. To override these default values, set values for **platform.openstack.apiVIP** and **platform.openstack.ingressVIP** that are outside of the DHCP allocation pool.

#### 18.7.14.7. Sample customized install-config.yaml file for RHOSP with Kuryr

To deploy with Kuryr SDN instead of the default OpenShift SDN, you must modify the **install-config.yaml** file to include **Kuryr** as the desired **networking.networkType** and proceed with the default OpenShift Container Platform SDN installation steps. This sample **install-config.yaml** demonstrates all of the possible Red Hat OpenStack Platform (RHOSP) customization options.



#### IMPORTANT

This sample file is provided for reference only. You must obtain your **install-config.yaml** file by using the installation program.

```
apiVersion: v1
baseDomain: example.com
controlPlane:
  name: master
  platform: {}
  replicas: 3
compute:
- name: worker
  platform:
    openstack:
      type: ml.large
  replicas: 3
metadata:
  name: example
networking:
  clusterNetwork:
  - cidr: 10.128.0.0/14
    hostPrefix: 23
  machineNetwork:
  - cidr: 10.0.0.0/16
  serviceNetwork:
  - 172.30.0.0/16 1
  networkType: Kuryr
platform:
  openstack:
```

```

cloud: mycloud
externalNetwork: external
computeFlavor: m1.xlarge
apiFloatingIP: 128.0.0.1
trunkSupport: true 2
octaviaSupport: true 3
pullSecret: '{"auths": ...}'
sshKey: ssh-ed25519 AAAA...

```

- 1 The Amphora Octavia driver creates two ports per load balancer. As a result, the service subnet that the installer creates is twice the size of the CIDR that is specified as the value of the **serviceNetwork** property. The larger range is required to prevent IP address conflicts.
- 2 3 Both **trunkSupport** and **octaviaSupport** are automatically discovered by the installer, so there is no need to set them. But if your environment does not meet both requirements, Kuryr SDN will not properly work. Trunks are needed to connect the pods to the RHOSP network and Octavia is required to create the OpenShift Container Platform services.

#### 18.7.14.8. Cluster deployment on RHOSP provider networks

You can deploy your OpenShift Container Platform clusters on Red Hat OpenStack Platform (RHOSP) with a primary network interface on a provider network. Provider networks are commonly used to give projects direct access to a public network that can be used to reach the internet. You can also share provider networks among projects as part of the network creation process.

RHOSP provider networks map directly to an existing physical network in the data center. A RHOSP administrator must create them.

In the following example, OpenShift Container Platform workloads are connected to a data center by using a provider network:

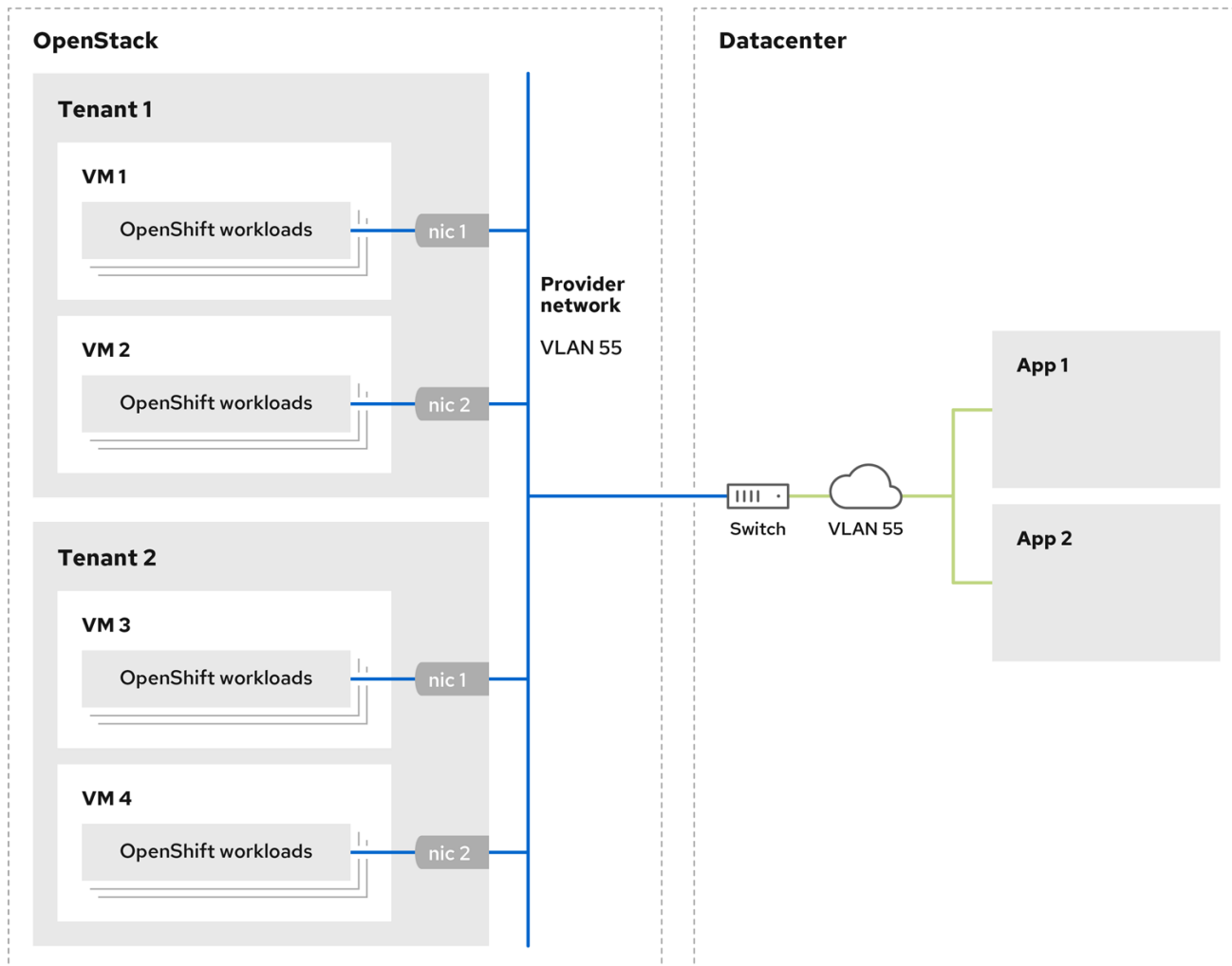

170\_OpenShift\_0621

OpenShift Container Platform clusters that are installed on provider networks do not require tenant networks or floating IP addresses. The installer does not create these resources during installation.

Example provider network types include flat (untagged) and VLAN (802.1Q tagged).



## NOTE

A cluster can support as many provider network connections as the network type allows. For example, VLAN networks typically support up to 4096 connections.

You can learn more about provider and tenant networks in [the RHOSP documentation](#).

### 18.7.14.8.1. RHOSP provider network requirements for cluster installation

Before you install an OpenShift Container Platform cluster, your Red Hat OpenStack Platform (RHOSP) deployment and provider network must meet a number of conditions:

- The [RHOSP networking service \(Neutron\) is enabled](#) and accessible through the RHOSP networking API.
- The RHOSP networking service has the [port security and allowed address pairs extensions enabled](#).

- The provider network can be shared with other tenants.

### TIP

Use the **openstack network create** command with the **--share** flag to create a network that can be shared.

- The RHOSP project that you use to install the cluster must own the provider network, as well as an appropriate subnet.

### TIP

To create a network for a project that is named "openshift," enter the following command

```
$ openstack network create --project openshift
```

To create a subnet for a project that is named "openshift," enter the following command

```
$ openstack subnet create --project openshift
```

To learn more about creating networks on RHOSP, read [the provider networks documentation](#).

If the cluster is owned by the **admin** user, you must run the installer as that user to create ports on the network.

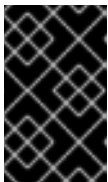

### IMPORTANT

Provider networks must be owned by the RHOSP project that is used to create the cluster. If they are not, the RHOSP Compute service (Nova) cannot request a port from that network.

- Verify that the provider network can reach the RHOSP metadata service IP address, which is **169.254.169.254** by default.

Depending on your RHOSP SDN and networking service configuration, you might need to provide the route when you create the subnet. For example:

```
$ openstack subnet create --dhcp --host-route
destination=169.254.169.254/32,gateway=192.0.2.2 ...
```

- Optional: To secure the network, create [role-based access control \(RBAC\)](#) rules that limit network access to a single project.

#### 18.7.14.8.2. Deploying a cluster that has a primary interface on a provider network

You can deploy an OpenShift Container Platform cluster that has its primary network interface on an Red Hat OpenStack Platform (RHOSP) provider network.

#### Prerequisites

- Your Red Hat OpenStack Platform (RHOSP) deployment is configured as described by "RHOSP provider network requirements for cluster installation".

## Procedure

1. In a text editor, open the **install-config.yaml** file.
2. Set the value of the **platform.openstack.apiVIP** property to the IP address for the API VIP.
3. Set the value of the **platform.openstack.ingressVIP** property to the IP address for the Ingress VIP.
4. Set the value of the **platform.openstack.machinesSubnet** property to the UUID of the provider network subnet.
5. Set the value of the **networking.machineNetwork.cidr** property to the CIDR block of the provider network subnet.



### IMPORTANT

The **platform.openstack.apiVIP** and **platform.openstack.ingressVIP** properties must both be unassigned IP addresses from the **networking.machineNetwork.cidr** block.

## Section of an installation configuration file for a cluster that relies on a RHOSP provider network

```
...
platform:
  openstack:
    apiVIP: 192.0.2.13
    ingressVIP: 192.0.2.23
    machinesSubnet: fa806b2f-ac49-4bce-b9db-124bc64209bf
    # ...
networking:
  machineNetwork:
    - cidr: 192.0.2.0/24
```



### WARNING

You cannot set the **platform.openstack.externalNetwork** or **platform.openstack.externalDNS** parameters while using a provider network for the primary network interface.

When you deploy the cluster, the installer uses the **install-config.yaml** file to deploy the cluster on the provider network.

**TIP**

You can add additional networks, including provider networks, to the **platform.openstack.additionalNetworkIDs** list.

After you deploy your cluster, you can attach pods to additional networks. For more information, see [Understanding multiple networks](#).

**18.7.14.9. Kuryr ports pools**

A Kuryr ports pool maintains a number of ports on standby for pod creation.

Keeping ports on standby minimizes pod creation time. Without ports pools, Kuryr must explicitly request port creation or deletion whenever a pod is created or deleted.

The Neutron ports that Kuryr uses are created in subnets that are tied to namespaces. These pod ports are also added as subports to the primary port of OpenShift Container Platform cluster nodes.

Because Kuryr keeps each namespace in a separate subnet, a separate ports pool is maintained for each namespace-worker pair.

Prior to installing a cluster, you can set the following parameters in the **cluster-network-03-config.yml** manifest file to configure ports pool behavior:

- The **enablePortPoolsPrepopulation** parameter controls pool prepopulation, which forces Kuryr to add Neutron ports to the pools when the first pod that is configured to use the dedicated network for pods is created in a namespace. The default value is **false**.
- The **poolMinPorts** parameter is the minimum number of free ports that are kept in the pool. The default value is **1**.
- The **poolMaxPorts** parameter is the maximum number of free ports that are kept in the pool. A value of **0** disables that upper bound. This is the default setting.  
If your OpenStack port quota is low, or you have a limited number of IP addresses on the pod network, consider setting this option to ensure that unneeded ports are deleted.
- The **poolBatchPorts** parameter defines the maximum number of Neutron ports that can be created at once. The default value is **3**.

**18.7.14.10. Adjusting Kuryr ports pools during installation**

During installation, you can configure how Kuryr manages Red Hat OpenStack Platform (RHOSP) Neutron ports to control the speed and efficiency of pod creation.

**Prerequisites**

- Create and modify the **install-config.yaml** file.

**Procedure**

1. From a command line, create the manifest files:

```
$ ./openshift-install create manifests --dir <installation_directory> 1
```

- 1 For **<installation\_directory>**, specify the name of the directory that contains the **install-config.yaml** file for your cluster.
2. Create a file that is named **cluster-network-03-config.yml** in the **<installation\_directory>/manifests/** directory:

```
$ touch <installation_directory>/manifests/cluster-network-03-config.yml 1
```

- 1 For **<installation\_directory>**, specify the directory name that contains the **manifests/** directory for your cluster.

After creating the file, several network configuration files are in the **manifests/** directory, as shown:

```
$ ls <installation_directory>/manifests/cluster-network-*
```

### Example output

```
cluster-network-01-crd.yml
cluster-network-02-config.yml
cluster-network-03-config.yml
```

3. Open the **cluster-network-03-config.yml** file in an editor, and enter a custom resource (CR) that describes the Cluster Network Operator configuration that you want:

```
$ oc edit networks.operator.openshift.io cluster
```

4. Edit the settings to meet your requirements. The following file is provided as an example:

```
apiVersion: operator.openshift.io/v1
kind: Network
metadata:
  name: cluster
spec:
  clusterNetwork:
    - cidr: 10.128.0.0/14
      hostPrefix: 23
  serviceNetwork:
    - 172.30.0.0/16
  defaultNetwork:
    type: Kuryr
    kuryrConfig:
      enablePortPoolsPrepopulation: false 1
      poolMinPorts: 1 2
      poolBatchPorts: 3 3
      poolMaxPorts: 5 4
      openstackServiceNetwork: 172.30.0.0/15 5
```

- 1 Set **enablePortPoolsPrepopulation** to **true** to make Kuryr create new Neutron ports when the first pod on the network for pods is created in a namespace. This setting raises the Neutron ports quota but can reduce the time that is required to spawn pods. The default value is **false**.



- 2 Kuryr creates new ports for a pool if the number of free ports in that pool is lower than the value of **poolMinPorts**. The default value is **1**.
- 3 **poolBatchPorts** controls the number of new ports that are created if the number of free ports is lower than the value of **poolMinPorts**. The default value is **3**.
- 4 If the number of free ports in a pool is higher than the value of **poolMaxPorts**, Kuryr deletes them until the number matches that value. Setting this value to **0** disables this upper bound, preventing pools from shrinking. The default value is **0**.
- 5 The **openStackServiceNetwork** parameter defines the CIDR range of the network from which IP addresses are allocated to RHOSP Octavia's LoadBalancers.

If this parameter is used with the Amphora driver, Octavia takes two IP addresses from this network for each load balancer: one for OpenShift and the other for VRRP connections. Because these IP addresses are managed by OpenShift Container Platform and Neutron respectively, they must come from different pools. Therefore, the value of **openStackServiceNetwork** must be at least twice the size of the value of **serviceNetwork**, and the value of **serviceNetwork** must overlap entirely with the range that is defined by **openStackServiceNetwork**.

The CNO verifies that VRRP IP addresses that are taken from the range that is defined by this parameter do not overlap with the range that is defined by the **serviceNetwork** parameter.

If this parameter is not set, the CNO uses an expanded value of **serviceNetwork** that is determined by decrementing the prefix size by 1.

5. Save the **cluster-network-03-config.yml** file, and exit the text editor.
6. Optional: Back up the **manifests/cluster-network-03-config.yml** file. The installation program deletes the **manifests/** directory while creating the cluster.

#### 18.7.14.11. Setting a custom subnet for machines

The IP range that the installation program uses by default might not match the Neutron subnet that you create when you install OpenShift Container Platform. If necessary, update the CIDR value for new machines by editing the installation configuration file.

#### Prerequisites

- You have the **install-config.yaml** file that was generated by the OpenShift Container Platform installation program.

#### Procedure

1. On a command line, browse to the directory that contains **install-config.yaml**.
2. From that directory, either run a script to edit the **install-config.yaml** file or update the file manually:
  - To set the value by using a script, run:

```
$ python -c '
import yaml;
path = "install-config.yaml";
```

```
data = yaml.safe_load(open(path));
data["networking"]["machineNetwork"] = [{"cidr": "192.168.0.0/18"}]; 1
open(path, "w").write(yaml.dump(data, default_flow_style=False))'
```

- 1** Insert a value that matches your intended Neutron subnet, e.g. **192.0.2.0/24**.

- To set the value manually, open the file and set the value of **networking.machineCIDR** to something that matches your intended Neutron subnet.

### 18.7.14.12. Emptying compute machine pools

To proceed with an installation that uses your own infrastructure, set the number of compute machines in the installation configuration file to zero. Later, you create these machines manually.

#### Prerequisites

- You have the **install-config.yaml** file that was generated by the OpenShift Container Platform installation program.

#### Procedure

1. On a command line, browse to the directory that contains **install-config.yaml**.
2. From that directory, either run a script to edit the **install-config.yaml** file or update the file manually:
  - To set the value by using a script, run:

```
$ python -c '
import yaml;
path = "install-config.yaml";
data = yaml.safe_load(open(path));
data["compute"][0]["replicas"] = 0;
open(path, "w").write(yaml.dump(data, default_flow_style=False))'
```

- To set the value manually, open the file and set the value of **compute.<first entry>.replicas** to **0**.

### 18.7.14.13. Modifying the network type

By default, the installation program selects the **OpenShiftSDN** network type. To use Kuryr instead, change the value in the installation configuration file that the program generated.

#### Prerequisites

- You have the file **install-config.yaml** that was generated by the OpenShift Container Platform installation program

#### Procedure

1. In a command prompt, browse to the directory that contains **install-config.yaml**.
2. From that directory, either run a script to edit the **install-config.yaml** file or update the file manually:

- To set the value by using a script, run:

```
$ python -c '
import yaml;
path = "install-config.yaml";
data = yaml.safe_load(open(path));
data["networking"]["networkType"] = "Kuryr";
open(path, "w").write(yaml.dump(data, default_flow_style=False))'
```

- To set the value manually, open the file and set **networking.networkType** to **"Kuryr"**.

### 18.7.15. Creating the Kubernetes manifest and Ignition config files

Because you must modify some cluster definition files and manually start the cluster machines, you must generate the Kubernetes manifest and Ignition config files that the cluster needs to configure the machines.

The installation configuration file transforms into the Kubernetes manifests. The manifests wrap into the Ignition configuration files, which are later used to configure the cluster machines.

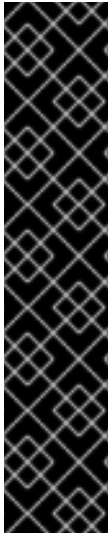

#### IMPORTANT

- The Ignition config files that the OpenShift Container Platform installation program generates contain certificates that expire after 24 hours, which are then renewed at that time. If the cluster is shut down before renewing the certificates and the cluster is later restarted after the 24 hours have elapsed, the cluster automatically recovers the expired certificates. The exception is that you must manually approve the pending **node-bootstrapper** certificate signing requests (CSRs) to recover kubelet certificates. See the documentation for *Recovering from expired control plane certificates* for more information.
- It is recommended that you use Ignition config files within 12 hours after they are generated because the 24-hour certificate rotates from 16 to 22 hours after the cluster is installed. By using the Ignition config files within 12 hours, you can avoid installation failure if the certificate update runs during installation.

#### Prerequisites

- You obtained the OpenShift Container Platform installation program.
- You created the **install-config.yaml** installation configuration file.

#### Procedure

1. Change to the directory that contains the OpenShift Container Platform installation program and generate the Kubernetes manifests for the cluster:

```
$ ./openshift-install create manifests --dir <installation_directory> 1
```

- 1** For **<installation\_directory>**, specify the installation directory that contains the **install-config.yaml** file you created.

- Remove the Kubernetes manifest files that define the control plane machines and compute machine sets:

```
$ rm -f openshift/99_openshift-cluster-api_master-machines-*.yaml openshift/99_openshift-cluster-api_worker-machineset-*.yaml
```

Because you create and manage these resources yourself, you do not have to initialize them.

- You can preserve the machine set files to create compute machines by using the machine API, but you must update references to them to match your environment.
- Check that the **mastersSchedulable** parameter in the `<installation_directory>/manifests/cluster-scheduler-02-config.yml` Kubernetes manifest file is set to **false**. This setting prevents pods from being scheduled on the control plane machines:
    - Open the `<installation_directory>/manifests/cluster-scheduler-02-config.yml` file.
    - Locate the **mastersSchedulable** parameter and ensure that it is set to **false**.
    - Save and exit the file.
  - To create the Ignition configuration files, run the following command from the directory that contains the installation program:

```
$ ./openshift-install create ignition-configs --dir <installation_directory> 1
```

- For `<installation_directory>`, specify the same installation directory.

Ignition config files are created for the bootstrap, control plane, and compute nodes in the installation directory. The **kubeadmin-password** and **kubeconfig** files are created in the `./<installation_directory>/auth` directory:

```
.
├── auth
│   ├── kubeadmin-password
│   └── kubeconfig
├── bootstrap.ign
├── master.ign
├── metadata.json
└── worker.ign
```

- Export the metadata file's **infraID** key as an environment variable:

```
$ export INFRA_ID=$(jq -r .infraID metadata.json)
```

## TIP

Extract the **infraID** key from **metadata.json** and use it as a prefix for all of the RHOSP resources that you create. By doing so, you avoid name conflicts when making multiple deployments in the same project.

### 18.7.16. Preparing the bootstrap Ignition files

The OpenShift Container Platform installation process relies on bootstrap machines that are created from a bootstrap Ignition configuration file.

Edit the file and upload it. Then, create a secondary bootstrap Ignition configuration file that Red Hat OpenStack Platform (RHOSP) uses to download the primary file.

## Prerequisites

- You have the bootstrap Ignition file that the installer program generates, **bootstrap.ign**.
- The infrastructure ID from the installer's metadata file is set as an environment variable (**\$INFRA\_ID**).
  - If the variable is not set, see **Creating the Kubernetes manifest and Ignition config files**
- You have an HTTP(S)-accessible way to store the bootstrap Ignition file.
  - The documented procedure uses the RHOSP image service (Glance), but you can also use the RHOSP storage service (Swift), Amazon S3, an internal HTTP server, or an ad hoc Nova server.

## Procedure

1. Run the following Python script. The script modifies the bootstrap Ignition file to set the hostname and, if available, CA certificate file when it runs:

```
import base64
import json
import os

with open('bootstrap.ign', 'r') as f:
    ignition = json.load(f)

files = ignition['storage'].get('files', [])

infra_id = os.environ.get('INFRA_ID', 'openshift').encode()
hostname_b64 = base64.standard_b64encode(infra_id + b'-bootstrap\n').decode().strip()
files.append(
{
    'path': '/etc/hostname',
    'mode': 420,
    'contents': {
        'source': 'data:text/plain;charset=utf-8;base64,' + hostname_b64
    }
})

ca_cert_path = os.environ.get('OS_CACERT', "")
if ca_cert_path:
    with open(ca_cert_path, 'r') as f:
        ca_cert = f.read().encode()
        ca_cert_b64 = base64.standard_b64encode(ca_cert).decode().strip()

files.append(
{
    'path': '/opt/openshift/tls/cloud-ca-cert.pem',
    'mode': 420,
```

```
'contents': {
  'source': 'data:text/plain;charset=utf-8;base64,' + ca_cert_b64
}
})

ignition['storage']['files'] = files;

with open('bootstrap.ign', 'w') as f:
    json.dump(ignition, f)
```

- Using the RHOSP CLI, create an image that uses the bootstrap ignition file:

```
$ openstack image create --disk-format=raw --container-format=bare --file bootstrap.ign
<image_name>
```

- Get the image's details:

```
$ openstack image show <image_name>
```

Make a note of the **file** value; it follows the pattern **v2/images/<image\_ID>/file**.



#### NOTE

Verify that the image you created is active.

- Retrieve the image service's public address:

```
$ openstack catalog show image
```

- Combine the public address with the image **file** value and save the result as the storage location. The location follows the pattern **<image\_service\_public\_URL>/v2/images/<image\_ID>/file**.

- Generate an auth token and save the token ID:

```
$ openstack token issue -c id -f value
```

- Insert the following content into a file called **\$INFRA\_ID-bootstrap-ignition.json** and edit the placeholders to match your own values:

```
{
  "ignition": {
    "config": {
      "merge": [{
        "source": "<storage_url>", 1
        "httpHeaders": [{
          "name": "X-Auth-Token", 2
          "value": "<token_ID>" 3
        }]
      }]
    },
    "security": {
      "tls": {
```

```

"certificateAuthorities": [{
  "source": "data:text/plain;charset=utf-8;base64,<base64_encoded_certificate>" 4
}]
}
},
"version": "3.2.0"
}
}

```

- 1 Replace the value of **ignition.config.merge.source** with the bootstrap Ignition file storage URL.
- 2 Set **name** in **httpHeaders** to **"X-Auth-Token"**.
- 3 Set **value** in **httpHeaders** to your token's ID.
- 4 If the bootstrap Ignition file server uses a self-signed certificate, include the base64-encoded certificate.

8. Save the secondary Ignition config file.

The bootstrap Ignition data will be passed to RHOSP during installation.



#### WARNING

The bootstrap Ignition file contains sensitive information, like **clouds.yaml** credentials. Ensure that you store it in a secure place, and delete it after you complete the installation process.

### 18.7.17. Creating control plane Ignition config files on RHOSP

Installing OpenShift Container Platform on Red Hat OpenStack Platform (RHOSP) on your own infrastructure requires control plane Ignition config files. You must create multiple config files.

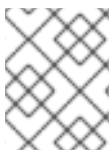

#### NOTE

As with the bootstrap Ignition configuration, you must explicitly define a hostname for each control plane machine.

#### Prerequisites

- The infrastructure ID from the installation program's metadata file is set as an environment variable (**\$INFRA\_ID**).
  - If the variable is not set, see "Creating the Kubernetes manifest and Ignition config files".

#### Procedure

- On a command line, run the following Python script:
  -

```

$ for index in $(seq 0 2); do
  MASTER_HOSTNAME="$INFRA_ID-master-$index\n"
  python -c "import base64, json, sys;
  ignition = json.load(sys.stdin);
  storage = ignition.get('storage', {});
  files = storage.get('files', []);
  files.append({'path': '/etc/hostname', 'mode': 420, 'contents': {'source':
'data:text/plain;charset=utf-8;base64,' +
base64.standard_b64encode(b'$MASTER_HOSTNAME').decode().strip(), 'verification': {}},
'filesystem': 'root'});
  storage['files'] = files;
  ignition['storage'] = storage;
  json.dump(ignition, sys.stdout) <master.ign >"$INFRA_ID-master-$index-ignition.json"
done

```

You now have three control plane Ignition files: **<INFRA\_ID>-master-0-ignition.json**, **<INFRA\_ID>-master-1-ignition.json**, and **<INFRA\_ID>-master-2-ignition.json**.

### 18.7.18. Creating network resources on RHOSP

Create the network resources that an OpenShift Container Platform on Red Hat OpenStack Platform (RHOSP) installation on your own infrastructure requires. To save time, run supplied Ansible playbooks that generate security groups, networks, subnets, routers, and ports.

#### Prerequisites

- Python 3 is installed on your machine.
- You downloaded the modules in "Downloading playbook dependencies".
- You downloaded the playbooks in "Downloading the installation playbooks".

#### Procedure

1. Optional: Add an external network value to the **inventory.yaml** playbook:

#### Example external network value in the **inventory.yaml** Ansible playbook

```

...
# The public network providing connectivity to the cluster. If not
# provided, the cluster external connectivity must be provided in another
# way.

# Required for os_api_fip, os_ingress_fip, os_bootstrap_fip.
os_external_network: 'external'
...

```



#### IMPORTANT

If you did not provide a value for **os\_external\_network** in the **inventory.yaml** file, you must ensure that VMs can access Glance and an external connection yourself.



- Optional: Add external network and floating IP (FIP) address values to the **inventory.yaml** playbook:

### Example FIP values in the **inventory.yaml** Ansible playbook

```
...
# OpenShift API floating IP address. If this value is non-empty, the
# corresponding floating IP will be attached to the Control Plane to
# serve the OpenShift API.
os_api_fip: '203.0.113.23'

# OpenShift Ingress floating IP address. If this value is non-empty, the
# corresponding floating IP will be attached to the worker nodes to serve
# the applications.
os_ingress_fip: '203.0.113.19'

# If this value is non-empty, the corresponding floating IP will be
# attached to the bootstrap machine. This is needed for collecting logs
# in case of install failure.
os_bootstrap_fip: '203.0.113.20'
```



### IMPORTANT

If you do not define values for **os\_api\_fip** and **os\_ingress\_fip**, you must perform post-installation network configuration.

If you do not define a value for **os\_bootstrap\_fip**, the installer cannot download debugging information from failed installations.

See "Enabling access to the environment" for more information.

- On a command line, create security groups by running the **security-groups.yaml** playbook:

```
$ ansible-playbook -i inventory.yaml security-groups.yaml
```

- On a command line, create a network, subnet, and router by running the **network.yaml** playbook:

```
$ ansible-playbook -i inventory.yaml network.yaml
```

- Optional: If you want to control the default resolvers that Nova servers use, run the RHOSP CLI command:

```
$ openstack subnet set --dns-nameserver <server_1> --dns-nameserver <server_2>
"$INFRA_ID-nodes"
```

## 18.7.19. Creating the bootstrap machine on RHOSP

Create a bootstrap machine and give it the network access it needs to run on Red Hat OpenStack Platform (RHOSP). Red Hat provides an Ansible playbook that you run to simplify this process.

### Prerequisites

- You downloaded the modules in "Downloading playbook dependencies".
- You downloaded the playbooks in "Downloading the installation playbooks".
- The **inventory.yaml**, **common.yaml**, and **bootstrap.yaml** Ansible playbooks are in a common directory.
- The **metadata.json** file that the installation program created is in the same directory as the Ansible playbooks.

### Procedure

1. On a command line, change the working directory to the location of the playbooks.
2. On a command line, run the **bootstrap.yaml** playbook:

```
$ ansible-playbook -i inventory.yaml bootstrap.yaml
```

3. After the bootstrap server is active, view the logs to verify that the Ignition files were received:

```
$ openstack console log show "$INFRA_ID-bootstrap"
```

## 18.7.20. Creating the control plane machines on RHOSP

Create three control plane machines by using the Ignition config files that you generated. Red Hat provides an Ansible playbook that you run to simplify this process.

### Prerequisites

- You downloaded the modules in "Downloading playbook dependencies".
- You downloaded the playbooks in "Downloading the installation playbooks".
- The infrastructure ID from the installation program's metadata file is set as an environment variable (**\$INFRA\_ID**).
- The **inventory.yaml**, **common.yaml**, and **control-plane.yaml** Ansible playbooks are in a common directory.
- You have the three Ignition files that were created in "Creating control plane Ignition config files".

### Procedure

1. On a command line, change the working directory to the location of the playbooks.
2. If the control plane Ignition config files aren't already in your working directory, copy them into it.
3. On a command line, run the **control-plane.yaml** playbook:

```
$ ansible-playbook -i inventory.yaml control-plane.yaml
```

4. Run the following command to monitor the bootstrapping process:

■

```
$ openshift-install wait-for bootstrap-complete
```

You will see messages that confirm that the control plane machines are running and have joined the cluster:

```
INFO API v1.23.0 up
INFO Waiting up to 30m0s for bootstrapping to complete...
...
INFO It is now safe to remove the bootstrap resources
```

### 18.7.21. Logging in to the cluster by using the CLI

You can log in to your cluster as a default system user by exporting the cluster **kubeconfig** file. The **kubeconfig** file contains information about the cluster that is used by the CLI to connect a client to the correct cluster and API server. The file is specific to a cluster and is created during OpenShift Container Platform installation.

#### Prerequisites

- You deployed an OpenShift Container Platform cluster.
- You installed the **oc** CLI.

#### Procedure

1. Export the **kubeadmin** credentials:

```
$ export KUBECONFIG=<installation_directory>/auth/kubeconfig 1
```

- 1** For **<installation\_directory>**, specify the path to the directory that you stored the installation files in.

2. Verify you can run **oc** commands successfully using the exported configuration:

```
$ oc whoami
```

#### Example output

```
system:admin
```

### 18.7.22. Deleting bootstrap resources from RHOSP

Delete the bootstrap resources that you no longer need.

#### Prerequisites

- You downloaded the modules in "Downloading playbook dependencies".
- You downloaded the playbooks in "Downloading the installation playbooks".
- The **inventory.yaml**, **common.yaml**, and **down-bootstrap.yaml** Ansible playbooks are in a common directory.

- The control plane machines are running.
  - If you do not know the status of the machines, see "Verifying cluster status".

### Procedure

1. On a command line, change the working directory to the location of the playbooks.
2. On a command line, run the **down-bootstrap.yaml** playbook:

```
$ ansible-playbook -i inventory.yaml down-bootstrap.yaml
```

The bootstrap port, server, and floating IP address are deleted.



### WARNING

If you did not disable the bootstrap Ignition file URL earlier, do so now.

## 18.7.23. Creating compute machines on RHOSP

After standing up the control plane, create compute machines. Red Hat provides an Ansible playbook that you run to simplify this process.

### Prerequisites

- You downloaded the modules in "Downloading playbook dependencies".
- You downloaded the playbooks in "Downloading the installation playbooks".
- The **inventory.yaml**, **common.yaml**, and **compute-nodes.yaml** Ansible playbooks are in a common directory.
- The **metadata.json** file that the installation program created is in the same directory as the Ansible playbooks.
- The control plane is active.

### Procedure

1. On a command line, change the working directory to the location of the playbooks.
2. On a command line, run the playbook:

```
$ ansible-playbook -i inventory.yaml compute-nodes.yaml
```

### Next steps

- Approve the certificate signing requests for the machines.

## 18.7.24. Approving the certificate signing requests for your machines

When you add machines to a cluster, two pending certificate signing requests (CSRs) are generated for each machine that you added. You must confirm that these CSRs are approved or, if necessary, approve them yourself. The client requests must be approved first, followed by the server requests.

### Prerequisites

- You added machines to your cluster.

### Procedure

- Confirm that the cluster recognizes the machines:

```
$ oc get nodes
```

#### Example output

```
NAME      STATUS   ROLES    AGE   VERSION
master-0  Ready    master   63m   v1.23.0
master-1  Ready    master   63m   v1.23.0
master-2  Ready    master   64m   v1.23.0
```

The output lists all of the machines that you created.



#### NOTE

The preceding output might not include the compute nodes, also known as worker nodes, until some CSRs are approved.

- Review the pending CSRs and ensure that you see the client requests with the **Pending** or **Approved** status for each machine that you added to the cluster:

```
$ oc get csr
```

#### Example output

```
NAME      AGE   REQUESTOR                                     CONDITION
csr-8b2br  15m   system:serviceaccount:openshift-machine-config-operator:node-
bootstrapper  Pending
csr-8vnps  15m   system:serviceaccount:openshift-machine-config-operator:node-
bootstrapper  Pending
...
```

In this example, two machines are joining the cluster. You might see more approved CSRs in the list.

- If the CSRs were not approved, after all of the pending CSRs for the machines you added are in **Pending** status, approve the CSRs for your cluster machines:

**NOTE**

Because the CSRs rotate automatically, approve your CSRs within an hour of adding the machines to the cluster. If you do not approve them within an hour, the certificates will rotate, and more than two certificates will be present for each node. You must approve all of these certificates. After the client CSR is approved, the Kubelet creates a secondary CSR for the serving certificate, which requires manual approval. Then, subsequent serving certificate renewal requests are automatically approved by the **machine-approver** if the Kubelet requests a new certificate with identical parameters.

**NOTE**

For clusters running on platforms that are not machine API enabled, such as bare metal and other user-provisioned infrastructure, you must implement a method of automatically approving the kubelet serving certificate requests (CSRs). If a request is not approved, then the **oc exec**, **oc rsh**, and **oc logs** commands cannot succeed, because a serving certificate is required when the API server connects to the kubelet. Any operation that contacts the Kubelet endpoint requires this certificate approval to be in place. The method must watch for new CSRs, confirm that the CSR was submitted by the **node-bootstrap** service account in the **system:node** or **system:admin** groups, and confirm the identity of the node.

- To approve them individually, run the following command for each valid CSR:

```
$ oc adm certificate approve <csr_name> 1
```

- 1** **<csr\_name>** is the name of a CSR from the list of current CSRs.

- To approve all pending CSRs, run the following command:

```
$ oc get csr -o go-template='{{range .items}}{{if not .status}}{{.metadata.name}}{"\n"}{{end}}{{end}}' | xargs --no-run-if-empty oc adm certificate approve
```

**NOTE**

Some Operators might not become available until some CSRs are approved.

- Now that your client requests are approved, you must review the server requests for each machine that you added to the cluster:

```
$ oc get csr
```

**Example output**

```
NAME      AGE   REQUESTOR                                     CONDITION
csr-bfd72 5m26s system:node:ip-10-0-50-126.us-east-2.compute.internal
Pending
csr-c57lv 5m26s system:node:ip-10-0-95-157.us-east-2.compute.internal
Pending
...
```

5. If the remaining CSRs are not approved, and are in the **Pending** status, approve the CSRs for your cluster machines:

- To approve them individually, run the following command for each valid CSR:

```
$ oc adm certificate approve <csr_name> 1
```

**1** **<csr\_name>** is the name of a CSR from the list of current CSRs.

- To approve all pending CSRs, run the following command:

```
$ oc get csr -o go-template='{{range .items}}{{if not .status}}{{.metadata.name}}{\n"}\n{{end}}' | xargs oc adm certificate approve
```

6. After all client and server CSRs have been approved, the machines have the **Ready** status. Verify this by running the following command:

```
$ oc get nodes
```

### Example output

```
NAME      STATUS   ROLES    AGE   VERSION
master-0  Ready   master   73m   v1.23.0
master-1  Ready   master   73m   v1.23.0
master-2  Ready   master   74m   v1.23.0
worker-0  Ready   worker   11m   v1.23.0
worker-1  Ready   worker   11m   v1.23.0
```



### NOTE

It can take a few minutes after approval of the server CSRs for the machines to transition to the **Ready** status.

### Additional information

- For more information on CSRs, see [Certificate Signing Requests](#).

## 18.7.25. Verifying a successful installation

Verify that the OpenShift Container Platform installation is complete.

### Prerequisites

- You have the installation program (**openshift-install**)

### Procedure

- On a command line, enter:

```
$ openshift-install --log-level debug wait-for install-complete
```

The program outputs the console URL, as well as the administrator's login information.

### 18.7.26. Telemetry access for OpenShift Container Platform

In OpenShift Container Platform 4.10, the Telemetry service, which runs by default to provide metrics about cluster health and the success of updates, requires internet access. If your cluster is connected to the internet, Telemetry runs automatically, and your cluster is registered to [OpenShift Cluster Manager](#).

After you confirm that your [OpenShift Cluster Manager](#) inventory is correct, either maintained automatically by Telemetry or manually by using OpenShift Cluster Manager, [use subscription watch](#) to track your OpenShift Container Platform subscriptions at the account or multi-cluster level.

#### Additional resources

- See [About remote health monitoring](#) for more information about the Telemetry service

### 18.7.27. Next steps

- [Customize your cluster](#).
- If necessary, you can [opt out of remote health reporting](#).
- If you need to enable external access to node ports, [configure ingress cluster traffic by using a node port](#).
- If you did not configure RHOSP to accept application traffic over floating IP addresses, [configure RHOSP access with floating IP addresses](#).

## 18.8. INSTALLING A CLUSTER ON OPENSTACK ON YOUR OWN SR-IOV INFRASTRUCTURE

In OpenShift Container Platform 4.10, you can install a cluster on Red Hat OpenStack Platform (RHOSP) that runs on user-provisioned infrastructure and uses single-root input/output virtualization (SR-IOV) networks to run compute machines.

Using your own infrastructure allows you to integrate your cluster with existing infrastructure and modifications. The process requires more labor on your part than installer-provisioned installations, because you must create all RHOSP resources, such as Nova servers, Neutron ports, and security groups. However, Red Hat provides Ansible playbooks to help you in the deployment process.

### 18.8.1. Prerequisites

- You reviewed details about the [OpenShift Container Platform installation and update](#) processes.
- You read the documentation on [selecting a cluster installation method and preparing it for users](#).
- You verified that OpenShift Container Platform 4.10 is compatible with your RHOSP version by using the [Supported platforms for OpenShift clusters](#) section. You can also compare platform support across different versions by viewing the [OpenShift Container Platform on RHOSP support matrix](#).
- Your network configuration does not rely on a provider network. Provider networks are not supported.
- You have an RHOSP account where you want to install OpenShift Container Platform.



- You understand performance and scalability practices for cluster scaling, control plane sizing, and etcd. For more information, see [Recommended host practices](#).
- On the machine where you run the installation program, you have:
  - A single directory in which you can keep the files you create during the installation process
  - Python 3

### 18.8.2. Internet access for OpenShift Container Platform

In OpenShift Container Platform 4.10, you require access to the internet to install your cluster.

You must have internet access to:

- Access [OpenShift Cluster Manager](#) to download the installation program and perform subscription management. If the cluster has internet access and you do not disable Telemetry, that service automatically entitles your cluster.
- Access [Quay.io](#) to obtain the packages that are required to install your cluster.
- Obtain the packages that are required to perform cluster updates.

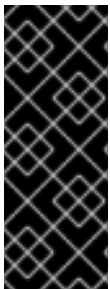

#### IMPORTANT

If your cluster cannot have direct internet access, you can perform a restricted network installation on some types of infrastructure that you provision. During that process, you download the required content and use it to populate a mirror registry with the installation packages. With some installation types, the environment that you install your cluster in will not require internet access. Before you update the cluster, you update the content of the mirror registry.

### 18.8.3. Resource guidelines for installing OpenShift Container Platform on RHOSP

To support an OpenShift Container Platform installation, your Red Hat OpenStack Platform (RHOSP) quota must meet the following requirements:

**Table 18.33. Recommended resources for a default OpenShift Container Platform cluster on RHOSP**

Resource	Value
Floating IP addresses	3
Ports	15
Routers	1
Subnets	1
RAM	88 GB
vCPUs	22

Resource	Value
Volume storage	275 GB
Instances	7
Security groups	3
Security group rules	60
Server groups	2 - plus 1 for each additional availability zone in each machine pool

A cluster might function with fewer than recommended resources, but its performance is not guaranteed.

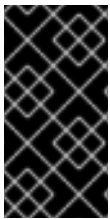

### IMPORTANT

If RHOSP object storage (Swift) is available and operated by a user account with the **swiftoperator** role, it is used as the default backend for the OpenShift Container Platform image registry. In this case, the volume storage requirement is 175 GB. Swift space requirements vary depending on the size of the image registry.



### NOTE

By default, your security group and security group rule quotas might be low. If you encounter problems, run **openstack quota set --secgroups 3 --secgroup-rules 60 <project>** as an administrator to increase them.

An OpenShift Container Platform deployment comprises control plane machines, compute machines, and a bootstrap machine.

#### 18.8.3.1. Control plane machines

By default, the OpenShift Container Platform installation process creates three control plane machines.

Each machine requires:

- An instance from the RHOSP quota
- A port from the RHOSP quota
- A flavor with at least 16 GB memory and 4 vCPUs
- At least 100 GB storage space from the RHOSP quota

#### 18.8.3.2. Compute machines

By default, the OpenShift Container Platform installation process creates three compute machines.

Each machine requires:

- An instance from the RHOSP quota
- A port from the RHOSP quota
- A flavor with at least 8 GB memory and 2 vCPUs
- At least 100 GB storage space from the RHOSP quota

## TIP

Compute machines host the applications that you run on OpenShift Container Platform; aim to run as many as you can.

Additionally, for clusters that use single-root input/output virtualization (SR-IOV), RHOSP compute nodes require a flavor that supports [huge pages](#).

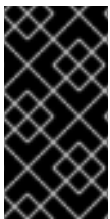

## IMPORTANT

SR-IOV deployments often employ performance optimizations, such as dedicated or isolated CPUs. For maximum performance, configure your underlying RHOSP deployment to use these optimizations, and then run OpenShift Container Platform compute machines on the optimized infrastructure.

## Additional resources

- For more information about configuring performant RHOSP compute nodes, see [Configuring Compute nodes for performance](#).

### 18.8.3.3. Bootstrap machine

During installation, a bootstrap machine is temporarily provisioned to stand up the control plane. After the production control plane is ready, the bootstrap machine is deprovisioned.

The bootstrap machine requires:

- An instance from the RHOSP quota
- A port from the RHOSP quota
- A flavor with at least 16 GB memory and 4 vCPUs
- At least 100 GB storage space from the RHOSP quota

### 18.8.4. Downloading playbook dependencies

The Ansible playbooks that simplify the installation process on user-provisioned infrastructure require several Python modules. On the machine where you will run the installer, add the modules' repositories and then download them.

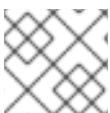

## NOTE

These instructions assume that you are using Red Hat Enterprise Linux (RHEL) 8.

## Prerequisites

- Python 3 is installed on your machine.

## Procedure

1. On a command line, add the repositories:

- a. Register with Red Hat Subscription Manager:

```
$ sudo subscription-manager register # If not done already
```

- b. Pull the latest subscription data:

```
$ sudo subscription-manager attach --pool=$YOUR_POOLID # If not done already
```

- c. Disable the current repositories:

```
$ sudo subscription-manager repos --disable=* # If not done already
```

- d. Add the required repositories:

```
$ sudo subscription-manager repos \  
--enable=rhel-8-for-x86_64-baseos-rpms \  
--enable=openstack-16-tools-for-rhel-8-x86_64-rpms \  
--enable=ansible-2.9-for-rhel-8-x86_64-rpms \  
--enable=rhel-8-for-x86_64-appstream-rpms
```

2. Install the modules:

```
$ sudo yum install python3-openstackclient ansible python3-openstacksdk python3-netaddr
```

3. Ensure that the **python** command points to **python3**:

```
$ sudo alternatives --set python /usr/bin/python3
```

### 18.8.5. Downloading the installation playbooks

Download Ansible playbooks that you can use to install OpenShift Container Platform on your own Red Hat OpenStack Platform (RHOSP) infrastructure.

#### Prerequisites

- The curl command-line tool is available on your machine.

#### Procedure

- To download the playbooks to your working directory, run the following script from a command line:

```
$ xargs -n 1 curl -O <<< '  
https://raw.githubusercontent.com/openshift/installer/release-  
4.10/upi/openstack/bootstrap.yaml  
https://raw.githubusercontent.com/openshift/installer/release-  
4.10/upi/openstack/common.yaml
```

```

https://raw.githubusercontent.com/openshift/installer/release-
4.10/upi/openstack/compute-nodes.yaml
https://raw.githubusercontent.com/openshift/installer/release-4.10/upi/openstack/control-
plane.yaml
https://raw.githubusercontent.com/openshift/installer/release-
4.10/upi/openstack/inventory.yaml
https://raw.githubusercontent.com/openshift/installer/release-
4.10/upi/openstack/network.yaml
https://raw.githubusercontent.com/openshift/installer/release-
4.10/upi/openstack/security-groups.yaml
https://raw.githubusercontent.com/openshift/installer/release-4.10/upi/openstack/down-
bootstrap.yaml
https://raw.githubusercontent.com/openshift/installer/release-4.10/upi/openstack/down-
compute-nodes.yaml
https://raw.githubusercontent.com/openshift/installer/release-4.10/upi/openstack/down-
control-plane.yaml
https://raw.githubusercontent.com/openshift/installer/release-4.10/upi/openstack/down-
load-balancers.yaml
https://raw.githubusercontent.com/openshift/installer/release-4.10/upi/openstack/down-
network.yaml
https://raw.githubusercontent.com/openshift/installer/release-4.10/upi/openstack/down-
security-groups.yaml
https://raw.githubusercontent.com/openshift/installer/release-4.10/upi/openstack/down-
containers.yaml'

```

The playbooks are downloaded to your machine.

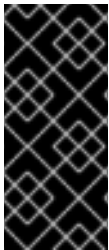

### IMPORTANT

During the installation process, you can modify the playbooks to configure your deployment.

Retain all playbooks for the life of your cluster. You must have the playbooks to remove your OpenShift Container Platform cluster from RHOSP.

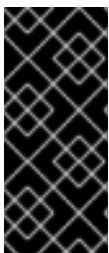

### IMPORTANT

You must match any edits you make in the **bootstrap.yaml**, **compute-nodes.yaml**, **control-plane.yaml**, **network.yaml**, and **security-groups.yaml** files to the corresponding playbooks that are prefixed with **down-**. For example, edits to the **bootstrap.yaml** file must be reflected in the **down-bootstrap.yaml** file, too. If you do not edit both files, the supported cluster removal process will fail.

## 18.8.6. Obtaining the installation program

Before you install OpenShift Container Platform, download the installation file on a local computer.

### Prerequisites

- You have a computer that runs Linux or macOS, with 500 MB of local disk space

### Procedure

1. Access the [Infrastructure Provider](#) page on the OpenShift Cluster Manager site. If you have a Red Hat account, log in with your credentials. If you do not, create an account.
2. Select your infrastructure provider.
3. Navigate to the page for your installation type, download the installation program that corresponds with your host operating system and architecture, and place the file in the directory where you will store the installation configuration files.

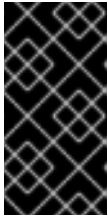

#### IMPORTANT

The installation program creates several files on the computer that you use to install your cluster. You must keep the installation program and the files that the installation program creates after you finish installing the cluster. Both files are required to delete the cluster.

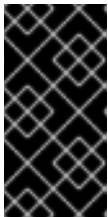

#### IMPORTANT

Deleting the files created by the installation program does not remove your cluster, even if the cluster failed during installation. To remove your cluster, complete the OpenShift Container Platform uninstallation procedures for your specific cloud provider.

4. Extract the installation program. For example, on a computer that uses a Linux operating system, run the following command:

```
$ tar -xvf openshift-install-linux.tar.gz
```

5. Download your installation [pull secret from the Red Hat OpenShift Cluster Manager](#) . This pull secret allows you to authenticate with the services that are provided by the included authorities, including Quay.io, which serves the container images for OpenShift Container Platform components.

### 18.8.7. Generating a key pair for cluster node SSH access

During an OpenShift Container Platform installation, you can provide an SSH public key to the installation program. The key is passed to the Red Hat Enterprise Linux CoreOS (RHCOS) nodes through their Ignition config files and is used to authenticate SSH access to the nodes. The key is added to the `~/.ssh/authorized_keys` list for the **core** user on each node, which enables password-less authentication.

After the key is passed to the nodes, you can use the key pair to SSH in to the RHCOS nodes as the user **core**. To access the nodes through SSH, the private key identity must be managed by SSH for your local user.

If you want to SSH in to your cluster nodes to perform installation debugging or disaster recovery, you must provide the SSH public key during the installation process. The `./openshift-install gather` command also requires the SSH public key to be in place on the cluster nodes.

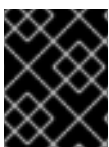

#### IMPORTANT

Do not skip this procedure in production environments, where disaster recovery and debugging is required.

**NOTE**

You must use a local key, not one that you configured with platform-specific approaches such as [AWS key pairs](#).

**Procedure**

1. If you do not have an existing SSH key pair on your local machine to use for authentication onto your cluster nodes, create one. For example, on a computer that uses a Linux operating system, run the following command:

```
$ ssh-keygen -t ed25519 -N "" -f <path>/<file_name> 1
```

- 1 Specify the path and file name, such as `~/.ssh/id_ed25519`, of the new SSH key. If you have an existing key pair, ensure your public key is in the your `~/.ssh` directory.

**NOTE**

If you plan to install an OpenShift Container Platform cluster that uses FIPS validated or Modules In Process cryptographic libraries on the **x86\_64** architecture, do not create a key that uses the **ed25519** algorithm. Instead, create a key that uses the **rsa** or **ecdsa** algorithm.

2. View the public SSH key:

```
$ cat <path>/<file_name>.pub
```

For example, run the following to view the `~/.ssh/id_ed25519.pub` public key:

```
$ cat ~/.ssh/id_ed25519.pub
```

3. Add the SSH private key identity to the SSH agent for your local user, if it has not already been added. SSH agent management of the key is required for password-less SSH authentication onto your cluster nodes, or if you want to use the `./openshift-install gather` command.

**NOTE**

On some distributions, default SSH private key identities such as `~/.ssh/id_rsa` and `~/.ssh/id_dsa` are managed automatically.

- a. If the **ssh-agent** process is not already running for your local user, start it as a background task:

```
$ eval "$(ssh-agent -s)"
```

**Example output**

```
Agent pid 31874
```

**NOTE**

If your cluster is in FIPS mode, only use FIPS-compliant algorithms to generate the SSH key. The key must be either RSA or ECDSA.

4. Add your SSH private key to the **ssh-agent**:

```
$ ssh-add <path>/<file_name> 1
```

- 1** Specify the path and file name for your SSH private key, such as `~/.ssh/id_ed25519`

**Example output**

```
Identity added: /home/<you>/<path>/<file_name> (<computer_name>)
```

**Next steps**

- When you install OpenShift Container Platform, provide the SSH public key to the installation program.

**18.8.8. Creating the Red Hat Enterprise Linux CoreOS (RHCOS) image**

The OpenShift Container Platform installation program requires that a Red Hat Enterprise Linux CoreOS (RHCOS) image be present in the Red Hat OpenStack Platform (RHOSP) cluster. Retrieve the latest RHCOS image, then upload it using the RHOSP CLI.

**Prerequisites**

- The RHOSP CLI is installed.

**Procedure**

1. Log in to the Red Hat Customer Portal's [Product Downloads page](#).
2. Under **Version**, select the most recent release of OpenShift Container Platform 4.10 for Red Hat Enterprise Linux (RHEL) 8.

**IMPORTANT**

The RHCOS images might not change with every release of OpenShift Container Platform. You must download images with the highest version that is less than or equal to the OpenShift Container Platform version that you install. Use the image versions that match your OpenShift Container Platform version if they are available.

3. Download the *Red Hat Enterprise Linux CoreOS (RHCOS) - OpenStack Image (QCOW)* .
4. Decompress the image.



**NOTE**

You must decompress the RHOSP image before the cluster can use it. The name of the downloaded file might not contain a compression extension, like **.gz** or **.tgz**. To find out if or how the file is compressed, in a command line, enter:

```
$ file <name_of_downloaded_file>
```

- From the image that you downloaded, create an image that is named **rhcos** in your cluster by using the RHOSP CLI:

```
$ openstack image create --container-format=bare --disk-format=qcow2 --file rhcos-
${RHCOS_VERSION}-openstack.qcow2 rhcos
```

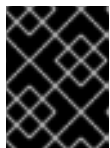
**IMPORTANT**

Depending on your RHOSP environment, you might be able to upload the image in either **.raw** or **.qcow2** formats. If you use Ceph, you must use the **.raw** format.

**WARNING**

If the installation program finds multiple images with the same name, it chooses one of them at random. To avoid this behavior, create unique names for resources in RHOSP.

After you upload the image to RHOSP, it is usable in the installation process.

**18.8.9. Verifying external network access**

The OpenShift Container Platform installation process requires external network access. You must provide an external network value to it, or deployment fails. Before you begin the process, verify that a network with the external router type exists in Red Hat OpenStack Platform (RHOSP).

**Prerequisites**

- Configure OpenStack's networking service to have DHCP agents forward instances' DNS queries

**Procedure**

- Using the RHOSP CLI, verify the name and ID of the 'External' network:

```
$ openstack network list --long -c ID -c Name -c "Router Type"
```

**Example output**

```
+-----+-----+-----+
```

ID	Name	Router Type
148a8023-62a7-4672-b018-003462f8d7dc	public_network	External

A network with an external router type appears in the network list. If at least one does not, see [Creating a default floating IP network](#) and [Creating a default provider network](#).



#### NOTE

If the Neutron trunk service plugin is enabled, a trunk port is created by default. For more information, see [Neutron trunk port](#).

## 18.8.10. Enabling access to the environment

At deployment, all OpenShift Container Platform machines are created in a Red Hat OpenStack Platform (RHOSP)-tenant network. Therefore, they are not accessible directly in most RHOSP deployments.

You can configure OpenShift Container Platform API and application access by using floating IP addresses (FIPs) during installation. You can also complete an installation without configuring FIPs, but the installer will not configure a way to reach the API or applications externally.

### 18.8.10.1. Enabling access with floating IP addresses

Create floating IP (FIP) addresses for external access to the OpenShift Container Platform API, cluster applications, and the bootstrap process.

#### Procedure

1. Using the Red Hat OpenStack Platform (RHOSP) CLI, create the API FIP:

```
$ openstack floating ip create --description "API <cluster_name>.<base_domain>"
<external_network>
```

2. Using the Red Hat OpenStack Platform (RHOSP) CLI, create the apps, or Ingress, FIP:

```
$ openstack floating ip create --description "Ingress <cluster_name>.<base_domain>"
<external_network>
```

3. By using the Red Hat OpenStack Platform (RHOSP) CLI, create the bootstrap FIP:

```
$ openstack floating ip create --description "bootstrap machine" <external_network>
```

4. Add records that follow these patterns to your DNS server for the API and Ingress FIPs:

```
api.<cluster_name>.<base_domain>. IN A <API_FIP>
*.apps.<cluster_name>.<base_domain>. IN A <apps_FIP>
```



## NOTE

If you do not control the DNS server, you can access the cluster by adding the cluster domain names such as the following to your **/etc/hosts** file:

- **<api\_floating\_ip> api.<cluster\_name>.<base\_domain>**
- **<application\_floating\_ip> grafana-openshift-monitoring.apps.<cluster\_name>.<base\_domain>**
- **<application\_floating\_ip> prometheus-k8s-openshift-monitoring.apps.<cluster\_name>.<base\_domain>**
- **<application\_floating\_ip> oauth-openshift.apps.<cluster\_name>.<base\_domain>**
- **<application\_floating\_ip> console-openshift-console.apps.<cluster\_name>.<base\_domain>**
- **application\_floating\_ip integrated-oauth-server-openshift-authentication.apps.<cluster\_name>.<base\_domain>**

The cluster domain names in the **/etc/hosts** file grant access to the web console and the monitoring interface of your cluster locally. You can also use the **kubectl** or **oc**. You can access the user applications by using the additional entries pointing to the **<application\_floating\_ip>**. This action makes the API and applications accessible to only you, which is not suitable for production deployment, but does allow installation for development and testing.

5. Add the FIPs to the **inventory.yaml** file as the values of the following variables:

- **os\_api\_fip**
- **os\_bootstrap\_fip**
- **os\_ingress\_fip**

If you use these values, you must also enter an external network as the value of the **os\_external\_network** variable in the **inventory.yaml** file.

## TIP

You can make OpenShift Container Platform resources available outside of the cluster by assigning a floating IP address and updating your firewall configuration.

### 18.8.10.2. Completing installation without floating IP addresses

You can install OpenShift Container Platform on Red Hat OpenStack Platform (RHOSP) without providing floating IP addresses.

In the **inventory.yaml** file, do not define the following variables:

- **os\_api\_fip**
- **os\_bootstrap\_fip**

- **os\_ingress\_fip**

If you cannot provide an external network, you can also leave **os\_external\_network** blank. If you do not provide a value for **os\_external\_network**, a router is not created for you, and, without additional action, the installer will fail to retrieve an image from Glance. Later in the installation process, when you create network resources, you must configure external connectivity on your own.

If you run the installer with the **wait-for** command from a system that cannot reach the cluster API due to a lack of floating IP addresses or name resolution, installation fails. To prevent installation failure in these cases, you can use a proxy network or run the installer from a system that is on the same network as your machines.



#### NOTE

You can enable name resolution by creating DNS records for the API and Ingress ports. For example:

```
api.<cluster_name>.<base_domain>. IN A <api_port_IP>
*.apps.<cluster_name>.<base_domain>. IN A <ingress_port_IP>
```

If you do not control the DNS server, you can add the record to your **/etc/hosts** file. This action makes the API accessible to only you, which is not suitable for production deployment but does allow installation for development and testing.

### 18.8.11. Defining parameters for the installation program

The OpenShift Container Platform installation program relies on a file that is called **clouds.yaml**. The file describes Red Hat OpenStack Platform (RHOSP) configuration parameters, including the project name, log in information, and authorization service URLs.

#### Procedure

1. Create the **clouds.yaml** file:
  - If your RHOSP distribution includes the Horizon web UI, generate a **clouds.yaml** file in it.



#### IMPORTANT

Remember to add a password to the **auth** field. You can also keep secrets in [a separate file](#) from **clouds.yaml**.

- If your RHOSP distribution does not include the Horizon web UI, or you do not want to use Horizon, create the file yourself. For detailed information about **clouds.yaml**, see [Config files](#) in the RHOSP documentation.

```
clouds:
  shiftstack:
    auth:
      auth_url: http://10.10.14.42:5000/v3
      project_name: shiftstack
      username: <username>
      password: <password>
      user_domain_name: Default
      project_domain_name: Default
```

```
dev-env:
  region_name: RegionOne
  auth:
    username: <username>
    password: <password>
    project_name: 'devonly'
    auth_url: 'https://10.10.14.22:5001/v2.0'
```

2. If your RHOSP installation uses self-signed certificate authority (CA) certificates for endpoint authentication:
  - a. Copy the certificate authority file to your machine.
  - b. Add the **cacerts** key to the **clouds.yaml** file. The value must be an absolute, non-root-accessible path to the CA certificate:

```
clouds:
  shiftstack:
    ...
  cacert: "/etc/pki/ca-trust/source/anchors/ca.crt.pem"
```

### TIP

After you run the installer with a custom CA certificate, you can update the certificate by editing the value of the **ca-cert.pem** key in the **cloud-provider-config** keymap. On a command line, run:

```
$ oc edit configmap -n openshift-config cloud-provider-config
```

3. Place the **clouds.yaml** file in one of the following locations:
  - a. The value of the **OS\_CLIENT\_CONFIG\_FILE** environment variable
  - b. The current directory
  - c. A Unix-specific user configuration directory, for example **~/.config/openstack/clouds.yaml**
  - d. A Unix-specific site configuration directory, for example **/etc/openstack/clouds.yaml**  
The installation program searches for **clouds.yaml** in that order.

## 18.8.12. Creating the installation configuration file

You can customize the OpenShift Container Platform cluster you install on Red Hat OpenStack Platform (RHOSP).

### Prerequisites

- Obtain the OpenShift Container Platform installation program and the pull secret for your cluster.
- Obtain service principal permissions at the subscription level.

### Procedure

1. Create the **install-config.yaml** file.
  - a. Change to the directory that contains the installation program and run the following command:

```
$ ./openshift-install create install-config --dir <installation_directory> 1
```

- 1** For **<installation\_directory>**, specify the directory name to store the files that the installation program creates.



### IMPORTANT

Specify an empty directory. Some installation assets, like bootstrap X.509 certificates have short expiration intervals, so you must not reuse an installation directory. If you want to reuse individual files from another cluster installation, you can copy them into your directory. However, the file names for the installation assets might change between releases. Use caution when copying installation files from an earlier OpenShift Container Platform version.

- b. At the prompts, provide the configuration details for your cloud:
    - i. Optional: Select an SSH key to use to access your cluster machines.



### NOTE

For production OpenShift Container Platform clusters on which you want to perform installation debugging or disaster recovery, specify an SSH key that your **ssh-agent** process uses.

- ii. Select **openstack** as the platform to target.
        - iii. Specify the Red Hat OpenStack Platform (RHOSP) external network name to use for installing the cluster.
        - iv. Specify the floating IP address to use for external access to the OpenShift API.
        - v. Specify a RHOSP flavor with at least 16 GB RAM to use for control plane nodes and 8 GB RAM for compute nodes.
        - vi. Select the base domain to deploy the cluster to. All DNS records will be sub-domains of this base and will also include the cluster name.
        - vii. Enter a name for your cluster. The name must be 14 or fewer characters long.
        - viii. Paste the [pull secret from the Red Hat OpenShift Cluster Manager](#) .
2. Modify the **install-config.yaml** file. You can find more information about the available parameters in the "Installation configuration parameters" section.
  3. Back up the **install-config.yaml** file so that you can use it to install multiple clusters.

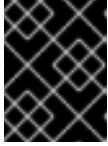
**IMPORTANT**

The **install-config.yaml** file is consumed during the installation process. If you want to reuse the file, you must back it up now.

You now have the file **install-config.yaml** in the directory that you specified.

**18.8.13. Installation configuration parameters**

Before you deploy an OpenShift Container Platform cluster, you provide parameter values to describe your account on the cloud platform that hosts your cluster and optionally customize your cluster's platform. When you create the **install-config.yaml** installation configuration file, you provide values for the required parameters through the command line. If you customize your cluster, you can modify the **install-config.yaml** file to provide more details about the platform.

**NOTE**

After installation, you cannot modify these parameters in the **install-config.yaml** file.

**18.8.13.1. Required configuration parameters**

Required installation configuration parameters are described in the following table:

**Table 18.34. Required parameters**

Parameter	Description	Values
<b>apiVersion</b>	The API version for the <b>install-config.yaml</b> content. The current version is <b>v1</b> . The installer may also support older API versions.	String
<b>baseDomain</b>	The base domain of your cloud provider. The base domain is used to create routes to your OpenShift Container Platform cluster components. The full DNS name for your cluster is a combination of the <b>baseDomain</b> and <b>metadata.name</b> parameter values that uses the <b>&lt;metadata.name&gt;</b> . <b>&lt;baseDomain&gt;</b> format.	A fully-qualified domain or subdomain name, such as <b>example.com</b> .
<b>metadata</b>	Kubernetes resource <b>ObjectMeta</b> , from which only the <b>name</b> parameter is consumed.	Object

Parameter	Description	Values
<b>metadata.name</b>	The name of the cluster. DNS records for the cluster are all subdomains of <b>{{.metadata.name}}.{{.baseDomain}}</b> .	String of lowercase letters, hyphens (-), and periods (.), such as <b>dev</b> . The string must be 14 characters or fewer long.
<b>platform</b>	The configuration for the specific platform upon which to perform the installation: <b>alibabacloud, aws, baremetal, azure, gcp, ibmcloud, openstack, ovirt, vsphere</b> , or <b>{}</b> . For additional information about <b>platform.&lt;platform&gt;</b> parameters, consult the table for your specific platform that follows.	Object
<b>pullSecret</b>	Get a <a href="#">pull secret from the Red Hat OpenShift Cluster Manager</a> to authenticate downloading container images for OpenShift Container Platform components from services such as Quay.io.	<pre>{   "auths":{     "cloud.openshift.com":{       "auth":"b3Blb=",       "email":"you@example.com"     },     "quay.io":{       "auth":"b3Blb=",       "email":"you@example.com"     }   } }</pre>

### 18.8.13.2. Network configuration parameters

You can customize your installation configuration based on the requirements of your existing network infrastructure. For example, you can expand the IP address block for the cluster network or provide different IP address blocks than the defaults.

Only IPv4 addresses are supported.

Table 18.35. Network parameters

Parameter	Description	Values
-----------	-------------	--------



Parameter	Description	Values
<b>networking</b>	The configuration for the cluster network.	Object  <b>NOTE</b> You cannot modify parameters specified by the <b>networking</b> object after installation.
<b>networking.networkType</b>	The cluster network provider Container Network Interface (CNI) plugin to install.	Either <b>OpenShiftSDN</b> or <b>OVNKubernetes</b> . <b>OpenShiftSDN</b> is a CNI provider for all-Linux networks. <b>OVNKubernetes</b> is a CNI provider for Linux networks and hybrid networks that contain both Linux and Windows servers. The default value is <b>OpenShiftSDN</b> .
<b>networking.clusterNetwork</b>	The IP address blocks for pods.  The default value is <b>10.128.0.0/14</b> with a host prefix of <b>/23</b> .  If you specify multiple IP address blocks, the blocks must not overlap.	An array of objects. For example:  <pre>networking:   clusterNetwork:     - cidr: 10.128.0.0/14       hostPrefix: 23</pre>
<b>networking.clusterNetwork.cidr</b>	Required if you use <b>networking.clusterNetwork</b> . An IP address block.  An IPv4 network.	An IP address block in Classless Inter-Domain Routing (CIDR) notation. The prefix length for an IPv4 block is between <b>0</b> and <b>32</b> .
<b>networking.clusterNetwork.hostPrefix</b>	The subnet prefix length to assign to each individual node. For example, if <b>hostPrefix</b> is set to <b>23</b> then each node is assigned a <b>/23</b> subnet out of the given <b>cidr</b> . A <b>hostPrefix</b> value of <b>23</b> provides 510 ( $2^{(32 - 23)} - 2$ ) pod IP addresses.	A subnet prefix.  The default value is <b>23</b> .
<b>networking.serviceNetwork</b>	The IP address block for services. The default value is <b>172.30.0.0/16</b> .  The OpenShift SDN and OVN-Kubernetes network providers support only a single IP address block for the service network.	An array with an IP address block in CIDR format. For example:  <pre>networking:   serviceNetwork:     - 172.30.0.0/16</pre>

Parameter	Description	Values
<b>networking.machineNetwork</b>	The IP address blocks for machines.  If you specify multiple IP address blocks, the blocks must not overlap.	An array of objects. For example:  <pre>networking:   machineNetwork:   - cidr: 10.0.0.0/16</pre>
<b>networking.machineNetwork.cidr</b>	Required if you use <b>networking.machineNetwork</b> . An IP address block. The default value is <b>10.0.0.0/16</b> for all platforms other than libvirt. For libvirt, the default value is <b>192.168.126.0/24</b> .	An IP network block in CIDR notation.  For example, <b>10.0.0.0/16</b> .   <p><b>NOTE</b></p> <p>Set the <b>networking.machineNetwork</b> to match the CIDR that the preferred NIC resides in.</p>

### 18.8.13.3. Optional configuration parameters



Optional installation configuration parameters are described in the following table:

Table 18.36. Optional parameters



Parameter	Description	Values
<b>additionalTrustBundle</b>	A PEM-encoded X.509 certificate bundle that is added to the nodes' trusted certificate store. This trust bundle may also be used when a proxy has been configured.	String
<b>cgroupsV2</b>	Enables <a href="#">Linux control groups version 2</a> (cgroups v2) on specific nodes in your cluster. The OpenShift Container Platform process for enabling cgroups v2 disables all cgroup version 1 controllers and hierarchies. The OpenShift Container Platform cgroups version 2 feature is in Developer Preview and is not supported by Red Hat at this time.	<b>true</b>
<b>compute</b>	The configuration for the machines that comprise the compute nodes.	Array of <b>MachinePool</b> objects.

Parameter	Description	Values
<b>compute.architecture</b>	Determines the instruction set architecture of the machines in the pool. Currently, clusters with varied architectures are not supported. All pools must specify the same architecture. Valid values are <b>amd64</b> (the default).	String
<b>compute.hyperthreading</b>	<p>Whether to enable or disable simultaneous multithreading, or <b>hyperthreading</b>, on compute machines. By default, simultaneous multithreading is enabled to increase the performance of your machines' cores.</p> <div style="display: flex; align-items: center;">  <div> <p><b>IMPORTANT</b></p> <p>If you disable simultaneous multithreading, ensure that your capacity planning accounts for the dramatically decreased machine performance.</p> </div> </div>	<b>Enabled</b> or <b>Disabled</b>
<b>compute.name</b>	Required if you use <b>compute</b> . The name of the machine pool.	<b>worker</b>
<b>compute.platform</b>	Required if you use <b>compute</b> . Use this parameter to specify the cloud provider to host the worker machines. This parameter value must match the <b>controlPlane.platform</b> parameter value.	<b>alibabacloud, aws, azure, gcp, ibmcloud, openstack, ovirt, vsphere</b> , or <b>{}</b>
<b>compute.replicas</b>	The number of compute machines, which are also known as worker machines, to provision.	A positive integer greater than or equal to <b>2</b> . The default value is <b>3</b> .
<b>controlPlane</b>	The configuration for the machines that comprise the control plane.	Array of <b>MachinePool</b> objects.

Parameter	Description	Values
<b>controlPlane.architecture</b>	Determines the instruction set architecture of the machines in the pool. Currently, clusters with varied architectures are not supported. All pools must specify the same architecture. Valid values are <b>amd64</b> (the default).	String
<b>controlPlane.hypertreading</b>	Whether to enable or disable simultaneous multithreading, or <b>hyperthreading</b> , on control plane machines. By default, simultaneous multithreading is enabled to increase the performance of your machines' cores.   <b>IMPORTANT</b>  If you disable simultaneous multithreading, ensure that your capacity planning accounts for the dramatically decreased machine performance.	<b>Enabled</b> or <b>Disabled</b>
<b>controlPlane.name</b>	Required if you use <b>controlPlane</b> . The name of the machine pool.	<b>master</b>
<b>controlPlane.platform</b>	Required if you use <b>controlPlane</b> . Use this parameter to specify the cloud provider that hosts the control plane machines. This parameter value must match the <b>compute.platform</b> parameter value.	<b>alibabacloud, aws, azure, gcp, ibmcloud, openstack, ovirt, vsphere, or {}</b>
<b>controlPlane.replicas</b>	The number of control plane machines to provision.	The only supported value is <b>3</b> , which is the default value.

Parameter	Description	Values
<b>credentialsMode</b>	<p>The Cloud Credential Operator (CCO) mode. If no mode is specified, the CCO dynamically tries to determine the capabilities of the provided credentials, with a preference for mint mode on the platforms where multiple modes are supported.</p> <div data-bbox="485 517 595 864" style="border: 1px solid black; padding: 5px; margin-bottom: 10px;">  </div> <p><b>NOTE</b></p> <p>Not all CCO modes are supported for all cloud providers. For more information on CCO modes, see the <i>Cloud Credential Operator</i> entry in the <i>Cluster Operators reference</i> content.</p> <div data-bbox="485 909 595 1256" style="border: 1px solid black; padding: 5px;">  </div> <p><b>NOTE</b></p> <p>If your AWS account has service control policies (SCP) enabled, you must configure the <b>credentialsMode</b> parameter to <b>Mint</b>, <b>Passthrough</b> or <b>Manual</b>.</p>	<b>Mint, Passthrough, Manual</b> or an empty string ("").

Parameter	Description	Values
<b>fips</b>	<p>Enable or disable FIPS mode. The default is <b>false</b> (disabled). If FIPS mode is enabled, the Red Hat Enterprise Linux CoreOS (RHCOS) machines that OpenShift Container Platform runs on bypass the default Kubernetes cryptography suite and use the cryptography modules that are provided with RHCOS instead.</p> <div style="display: flex; align-items: flex-start;"> <div style="width: 20px; height: 100px; background: repeating-linear-gradient(45deg, transparent, transparent 2px, black 2px, black 4px); margin-right: 10px;"></div> <div> <p><b>IMPORTANT</b></p> <p>To enable FIPS mode for your cluster, you must run the installation program from a Red Hat Enterprise Linux (RHEL) computer configured to operate in FIPS mode. For more information about configuring FIPS mode on RHEL, see <a href="#">Installing the system in FIPS mode</a>. The use of FIPS validated or Modules In Process cryptographic libraries is only supported on OpenShift Container Platform deployments on the <b>x86_64</b> architecture.</p> </div> </div> <div style="display: flex; align-items: flex-start; margin-top: 10px;"> <div style="width: 20px; height: 40px; background: repeating-linear-gradient(45deg, transparent, transparent 2px, black 2px, black 4px); margin-right: 10px;"></div> <div> <p><b>NOTE</b></p> <p>If you are using Azure File storage, you cannot enable FIPS mode.</p> </div> </div>	<b>false</b> or <b>true</b>
<b>imageContentSources</b>	Sources and repositories for the release-image content.	Array of objects. Includes a <b>source</b> and, optionally, <b>mirrors</b> , as described in the following rows of this table.
<b>imageContentSources.source</b>	Required if you use <b>imageContentSources</b> . Specify the repository that users refer to, for example, in image pull specifications.	String
<b>imageContentSources.mirrors</b>	Specify one or more repositories that may also contain the same images.	Array of strings

Parameter	Description	Values
<b>publish</b>	How to publish or expose the user-facing endpoints of your cluster, such as the Kubernetes API, OpenShift routes.	<p><b>Internal</b> or <b>External</b>. The default value is <b>External</b>.</p> <p>Setting this field to <b>Internal</b> is not supported on non-cloud platforms and IBM Cloud VPC.</p> <div style="display: flex; align-items: flex-start;">  <div> <p><b>IMPORTANT</b></p> <p>If the value of the field is set to <b>Internal</b>, the cluster will become non-functional. For more information, refer to <a href="#">BZ#1953035</a>.</p> </div> </div>
<b>sshKey</b>	<p>The SSH key or keys to authenticate access your cluster machines.</p> <div style="display: flex; align-items: flex-start;">  <div> <p><b>NOTE</b></p> <p>For production OpenShift Container Platform clusters on which you want to perform installation debugging or disaster recovery, specify an SSH key that your <b>ssh-agent</b> process uses.</p> </div> </div>	<p>One or more keys. For example:</p> <pre>sshKey:   &lt;key1&gt;   &lt;key2&gt;   &lt;key3&gt;</pre>

#### 18.8.13.4. Additional Red Hat OpenStack Platform (RHOSP) configuration parameters

Additional RHOSP configuration parameters are described in the following table:

Table 18.37. Additional RHOSP parameters

Parameter	Description	Values
<b>compute.platform.openstack.rotoVolume.size</b>	For compute machines, the size in gigabytes of the root volume. If you do not set this value, machines use ephemeral storage.	Integer, for example <b>30</b> .
<b>compute.platform.openstack.rotoVolume.type</b>	For compute machines, the root volume's type.	String, for example <b>performance</b> .

Parameter	Description	Values
<b>controlPlane.platform.openstack.rootVolume.size</b>	For control plane machines, the size in gigabytes of the root volume. If you do not set this value, machines use ephemeral storage.	Integer, for example <b>30</b> .
<b>controlPlane.platform.openstack.rootVolume.type</b>	For control plane machines, the root volume's type.	String, for example <b>performance</b> .
<b>platform.openstack.cloud</b>	The name of the RHOSP cloud to use from the list of clouds in the <b>clouds.yaml</b> file.	String, for example <b>MyCloud</b> .
<b>platform.openstack.externalNetwork</b>	The RHOSP external network name to be used for installation.	String, for example <b>external</b> .
<b>platform.openstack.computeFlavor</b>	<p>The RHOSP flavor to use for control plane and compute machines.</p> <p>This property is deprecated. To use a flavor as the default for all machine pools, add it as the value of the <b>type</b> key in the <b>platform.openstack.defaultMachinePlatform</b> property. You can also set a flavor value for each machine pool individually.</p>	String, for example <b>m1.xlarge</b> .

### 18.8.13.5. Optional RHOSP configuration parameters

Optional RHOSP configuration parameters are described in the following table:

Table 18.38. Optional RHOSP parameters

Parameter	Description	Values
<b>compute.platform.openstack.additionalNetworkIds</b>	Additional networks that are associated with compute machines. Allowed address pairs are not created for additional networks.	A list of one or more UUIDs as strings. For example, <b>fa806b2f-ac49-4bce-b9db-124bc64209bf</b> .



Parameter	Description	Values
<b>compute.platform.openstack.additionalSecurityGroupIDs</b>	Additional security groups that are associated with compute machines.	A list of one or more UUIDs as strings. For example, <b>7ee219f3-d2e9-48a1-96c2-e7429f1b0da7</b> .
<b>compute.platform.openstack.zones</b>	<p>RHOSP Compute (Nova) availability zones (AZs) to install machines on. If this parameter is not set, the installer relies on the default settings for Nova that the RHOSP administrator configured.</p> <p>On clusters that use Kuryr, RHOSP Octavia does not support availability zones. Load balancers and, if you are using the Amphora provider driver, OpenShift Container Platform services that rely on Amphora VMs, are not created according to the value of this property.</p>	A list of strings. For example, <b>["zone-1", "zone-2"]</b> .
<b>compute.platform.openstack.rootVolume.zones</b>	For compute machines, the availability zone to install root volumes on. If you do not set a value for this parameter, the installer selects the default availability zone.	A list of strings, for example <b>["zone-1", "zone-2"]</b> .

Parameter	Description	Values
<b>compute.platform.openstack.serverGroupPolicy</b>	<p>Server group policy to apply to the group that will contain the compute machines in the pool. You cannot change server group policies or affiliations after creation. Supported options include <b>anti-affinity</b>, <b>soft-affinity</b>, and <b>soft-anti-affinity</b>. The default value is <b>soft-anti-affinity</b>.</p> <p>An <b>affinity</b> policy prevents migrations and therefore affects RHOSP upgrades. The <b>affinity</b> policy is not supported.</p> <p>If you use a strict <b>anti-affinity</b> policy, an additional RHOSP host is required during instance migration.</p>	A server group policy to apply to the machine pool. For example, <b>soft-affinity</b> .
<b>controlPlane.platform.openstack.additionalNetworkIDs</b>	Additional networks that are associated with control plane machines. Allowed address pairs are not created for additional networks.	A list of one or more UUIDs as strings. For example, <b>fa806b2f-ac49-4bce-b9db-124bc64209bf</b> .
<b>controlPlane.platform.openstack.additionalSecurityGroupIDs</b>	Additional security groups that are associated with control plane machines.	A list of one or more UUIDs as strings. For example, <b>7ee219f3-d2e9-48a1-96c2-e7429f1b0da7</b> .

Parameter	Description	Values
<b>controlPlane.placement.openstack.zones</b>	<p>RHOSP Compute (Nova) availability zones (AZs) to install machines on. If this parameter is not set, the installer relies on the default settings for Nova that the RHOSP administrator configured.</p> <p>On clusters that use Kuryr, RHOSP Octavia does not support availability zones. Load balancers and, if you are using the Amphora provider driver, OpenShift Container Platform services that rely on Amphora VMs, are not created according to the value of this property.</p>	A list of strings. For example, <b>["zone-1", "zone-2"]</b> .
<b>controlPlane.placement.openstack.rootVolume.zones</b>	For control plane machines, the availability zone to install root volumes on. If you do not set this value, the installer selects the default availability zone.	A list of strings, for example <b>["zone-1", "zone-2"]</b> .
<b>controlPlane.placement.openstack.serverGroupPolicy</b>	<p>Server group policy to apply to the group that will contain the control plane machines in the pool. You cannot change server group policies or affiliations after creation. Supported options include <b>anti-affinity</b>, <b>soft-affinity</b>, and <b>soft-anti-affinity</b>. The default value is <b>soft-anti-affinity</b>.</p> <p>An <b>affinity</b> policy prevents migrations, and therefore affects RHOSP upgrades. The <b>affinity</b> policy is not supported.</p> <p>If you use a strict <b>anti-affinity</b> policy, an additional RHOSP host is required during instance migration.</p>	A server group policy to apply to the machine pool. For example, <b>soft-affinity</b> .

Parameter	Description	Values
<b>platform.openstack.clusterOSImage</b>	<p>The location from which the installer downloads the RHCOS image.</p> <p>You must set this parameter to perform an installation in a restricted network.</p>	<p>An HTTP or HTTPS URL, optionally with an SHA-256 checksum.</p> <p>For example,  <b>http://mirror.example.com/images/rhcos-43.81.201912131630.0-openstack.x86_64.qcow2.gz?sha256=ffebbd68e8a1f2a245ca19522c16c86f67f9ac8e4e0c1f0a812b068b16f7265d</b>. The value can also be the name of an existing Glance image, for example <b>my-rhcos</b>.</p>
<b>platform.openstack.clusterOSImageProperties</b>	<p>Properties to add to the installer-uploaded ClusterOSImage in Glance. This property is ignored if <b>platform.openstack.clusterOSImage</b> is set to an existing Glance image.</p> <p>You can use this property to exceed the default persistent volume (PV) limit for RHOSP of 26 PVs per node. To exceed the limit, set the <b>hw_scsi_model</b> property value to <b>virtio-scsi</b> and the <b>hw_disk_bus</b> value to <b>scsi</b>.</p> <p>You can also use this property to enable the QEMU guest agent by including the <b>hw_qemu_guest_agent</b> property with a value of <b>yes</b>.</p>	<p>A list of key-value string pairs. For example, <b>["hw_scsi_model": "virtio-scsi", "hw_disk_bus": "scsi"]</b>.</p>
<b>platform.openstack.defaultMachinePlatform</b>	<p>The default machine pool platform configuration.</p>	<pre>{   "type": "ml.large",   "rootVolume": {     "size": 30,     "type": "performance"   } }</pre>
<b>platform.openstack.ingressFloatingIP</b>	<p>An existing floating IP address to associate with the Ingress port. To use this property, you must also define the <b>platform.openstack.externalNetwork</b> property.</p>	<p>An IP address, for example <b>128.0.0.1</b>.</p>

Parameter	Description	Values
<b>platform.openstack.apiFloatingIP</b>	An existing floating IP address to associate with the API load balancer. To use this property, you must also define the <b>platform.openstack.externalNetwork</b> property.	An IP address, for example <b>128.0.0.1</b> .
<b>platform.openstack.externalDNS</b>	IP addresses for external DNS servers that cluster instances use for DNS resolution.	A list of IP addresses as strings. For example, <b>["8.8.8.8", "192.168.1.12"]</b> .
<b>platform.openstack.machinesSubnet</b>	<p>The UUID of a RHOSP subnet that the cluster's nodes use. Nodes and virtual IP (VIP) ports are created on this subnet.</p> <p>The first item in <b>networking.machineNetwork</b> must match the value of <b>machinesSubnet</b>.</p> <p>If you deploy to a custom subnet, you cannot specify an external DNS server to the OpenShift Container Platform installer. Instead, <a href="#">add DNS to the subnet in RHOSP</a>.</p>	A UUID as a string. For example, <b>fa806b2f-ac49-4bce-b9db-124bc64209bf</b> .

### 18.8.13.6. Sample customized `install-config.yaml` file for RHOSP

This sample **`install-config.yaml`** demonstrates all of the possible Red Hat OpenStack Platform (RHOSP) customization options.

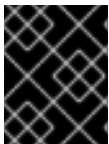

#### IMPORTANT

This sample file is provided for reference only. You must obtain your **`install-config.yaml`** file by using the installation program.

```
apiVersion: v1
baseDomain: example.com
controlPlane:
  name: master
  platform: {}
  replicas: 3
compute:
- name: worker
  platform:
    openstack:
      type: ml.large
```

```

replicas: 3
metadata:
  name: example
networking:
  clusterNetwork:
  - cidr: 10.128.0.0/14
    hostPrefix: 23
  machineNetwork:
  - cidr: 10.0.0.0/16
  serviceNetwork:
  - 172.30.0.0/16
  networkType: OpenShiftSDN
platform:
  openstack:
    cloud: mycloud
    externalNetwork: external
    computeFlavor: m1.xlarge
    apiFloatingIP: 128.0.0.1
  fips: false
  pullSecret: '{"auths": ...}'
  sshKey: ssh-ed25519 AAAA...

```

### 18.8.13.7. Custom subnets in RHOSP deployments

Optionally, you can deploy a cluster on a Red Hat OpenStack Platform (RHOSP) subnet of your choice. The subnet's GUID is passed as the value of **platform.openstack.machinesSubnet** in the **install-config.yaml** file.

This subnet is used as the cluster's primary subnet. By default, nodes and ports are created on it. You can create nodes and ports on a different RHOSP subnet by setting the value of the **platform.openstack.machinesSubnet** property to the subnet's UUID.

Before you run the OpenShift Container Platform installer with a custom subnet, verify that your configuration meets the following requirements:

- The subnet that is used by **platform.openstack.machinesSubnet** has DHCP enabled.
- The CIDR of **platform.openstack.machinesSubnet** matches the CIDR of **networking.machineNetwork**.
- The installation program user has permission to create ports on this network, including ports with fixed IP addresses.

Clusters that use custom subnets have the following limitations:

- If you plan to install a cluster that uses floating IP addresses, the **platform.openstack.machinesSubnet** subnet must be attached to a router that is connected to the **externalNetwork** network.
- If the **platform.openstack.machinesSubnet** value is set in the **install-config.yaml** file, the installation program does not create a private network or subnet for your RHOSP machines.
- You cannot use the **platform.openstack.externalDNS** property at the same time as a custom subnet. To add DNS to a cluster that uses a custom subnet, configure DNS on the RHOSP network.



## NOTE

By default, the API VIP takes x.x.x.5 and the Ingress VIP takes x.x.x.7 from your network's CIDR block. To override these default values, set values for **platform.openstack.apiVIP** and **platform.openstack.ingressVIP** that are outside of the DHCP allocation pool.

### 18.8.13.8. Setting a custom subnet for machines

The IP range that the installation program uses by default might not match the Neutron subnet that you create when you install OpenShift Container Platform. If necessary, update the CIDR value for new machines by editing the installation configuration file.

#### Prerequisites

- You have the **install-config.yaml** file that was generated by the OpenShift Container Platform installation program.

#### Procedure

- On a command line, browse to the directory that contains **install-config.yaml**.
- From that directory, either run a script to edit the **install-config.yaml** file or update the file manually:
  - To set the value by using a script, run:

```
$ python -c '
import yaml;
path = "install-config.yaml";
data = yaml.safe_load(open(path));
data["networking"]["machineNetwork"] = [{"cidr": "192.168.0.0/18"}]; 1
open(path, "w").write(yaml.dump(data, default_flow_style=False))'
```

- 1** Insert a value that matches your intended Neutron subnet, e.g. **192.0.2.0/24**.

- To set the value manually, open the file and set the value of **networking.machineCIDR** to something that matches your intended Neutron subnet.

### 18.8.13.9. Emptying compute machine pools

To proceed with an installation that uses your own infrastructure, set the number of compute machines in the installation configuration file to zero. Later, you create these machines manually.

#### Prerequisites

- You have the **install-config.yaml** file that was generated by the OpenShift Container Platform installation program.

#### Procedure

- On a command line, browse to the directory that contains **install-config.yaml**.
- From that directory, either run a script to edit the **install-config.yaml** file or update the file manually:

- To set the value by using a script, run:

```
$ python -c '
import yaml;
path = "install-config.yaml";
data = yaml.safe_load(open(path));
data["compute"][0]["replicas"] = 0;
open(path, "w").write(yaml.dump(data, default_flow_style=False))'
```

- To set the value manually, open the file and set the value of **compute.<first entry>.replicas** to **0**.

### 18.8.14. Creating the Kubernetes manifest and Ignition config files

Because you must modify some cluster definition files and manually start the cluster machines, you must generate the Kubernetes manifest and Ignition config files that the cluster needs to configure the machines.

The installation configuration file transforms into the Kubernetes manifests. The manifests wrap into the Ignition configuration files, which are later used to configure the cluster machines.

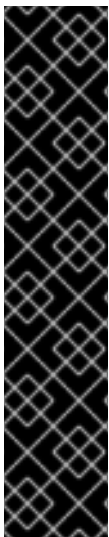

#### IMPORTANT

- The Ignition config files that the OpenShift Container Platform installation program generates contain certificates that expire after 24 hours, which are then renewed at that time. If the cluster is shut down before renewing the certificates and the cluster is later restarted after the 24 hours have elapsed, the cluster automatically recovers the expired certificates. The exception is that you must manually approve the pending **node-bootstrapper** certificate signing requests (CSRs) to recover kubelet certificates. See the documentation for *Recovering from expired control plane certificates* for more information.
- It is recommended that you use Ignition config files within 12 hours after they are generated because the 24-hour certificate rotates from 16 to 22 hours after the cluster is installed. By using the Ignition config files within 12 hours, you can avoid installation failure if the certificate update runs during installation.

#### Prerequisites

- You obtained the OpenShift Container Platform installation program.
- You created the **install-config.yaml** installation configuration file.

#### Procedure

1. Change to the directory that contains the OpenShift Container Platform installation program and generate the Kubernetes manifests for the cluster:

```
$ ./openshift-install create manifests --dir <installation_directory> 1
```

- 1** For **<installation\_directory>**, specify the installation directory that contains the **install-config.yaml** file you created.



- Remove the Kubernetes manifest files that define the control plane machines and compute machine sets:

```
$ rm -f openshift/99_openshift-cluster-api_master-machines-*.yaml openshift/99_openshift-cluster-api_worker-machineset-*.yaml
```

Because you create and manage these resources yourself, you do not have to initialize them.

- You can preserve the machine set files to create compute machines by using the machine API, but you must update references to them to match your environment.
- Check that the **mastersSchedulable** parameter in the `<installation_directory>/manifests/cluster-scheduler-02-config.yml` Kubernetes manifest file is set to **false**. This setting prevents pods from being scheduled on the control plane machines:
    - Open the `<installation_directory>/manifests/cluster-scheduler-02-config.yml` file.
    - Locate the **mastersSchedulable** parameter and ensure that it is set to **false**.
    - Save and exit the file.
  - To create the Ignition configuration files, run the following command from the directory that contains the installation program:

```
$ ./openshift-install create ignition-configs --dir <installation_directory> 1
```

- For `<installation_directory>`, specify the same installation directory.

Ignition config files are created for the bootstrap, control plane, and compute nodes in the installation directory. The **kubeadmin-password** and **kubeconfig** files are created in the `./<installation_directory>/auth` directory:

```
.
├── auth
│   ├── kubeadmin-password
│   └── kubeconfig
├── bootstrap.ign
├── master.ign
├── metadata.json
└── worker.ign
```

- Export the metadata file's **infraID** key as an environment variable:

```
$ export INFRA_ID=$(jq -r .infraID metadata.json)
```

## TIP

Extract the **infraID** key from **metadata.json** and use it as a prefix for all of the RHOSP resources that you create. By doing so, you avoid name conflicts when making multiple deployments in the same project.

### 18.8.15. Preparing the bootstrap Ignition files

The OpenShift Container Platform installation process relies on bootstrap machines that are created from a bootstrap Ignition configuration file.

Edit the file and upload it. Then, create a secondary bootstrap Ignition configuration file that Red Hat OpenStack Platform (RHOSP) uses to download the primary file.

## Prerequisites

- You have the bootstrap Ignition file that the installer program generates, **bootstrap.ign**.
- The infrastructure ID from the installer's metadata file is set as an environment variable (**\$INFRA\_ID**).
  - If the variable is not set, see **Creating the Kubernetes manifest and Ignition config files**
- You have an HTTP(S)-accessible way to store the bootstrap Ignition file.
  - The documented procedure uses the RHOSP image service (Glance), but you can also use the RHOSP storage service (Swift), Amazon S3, an internal HTTP server, or an ad hoc Nova server.

## Procedure

1. Run the following Python script. The script modifies the bootstrap Ignition file to set the hostname and, if available, CA certificate file when it runs:

```
import base64
import json
import os

with open('bootstrap.ign', 'r') as f:
    ignition = json.load(f)

files = ignition['storage'].get('files', [])

infra_id = os.environ.get('INFRA_ID', 'openshift').encode()
hostname_b64 = base64.standard_b64encode(infra_id + b'-bootstrap\n').decode().strip()
files.append(
{
    'path': '/etc/hostname',
    'mode': 420,
    'contents': {
        'source': 'data:text/plain;charset=utf-8;base64,' + hostname_b64
    }
})

ca_cert_path = os.environ.get('OS_CACERT', "")
if ca_cert_path:
    with open(ca_cert_path, 'r') as f:
        ca_cert = f.read().encode()
        ca_cert_b64 = base64.standard_b64encode(ca_cert).decode().strip()

files.append(
{
    'path': '/opt/openshift/tls/cloud-ca-cert.pem',
    'mode': 420,
```

```

        'contents': {
            'source': 'data:text/plain;charset=utf-8;base64,' + ca_cert_b64
        }
    })

    ignition['storage']['files'] = files;

    with open('bootstrap.ign', 'w') as f:
        json.dump(ignition, f)

```

- Using the RHOSP CLI, create an image that uses the bootstrap ignition file:

```
$ openstack image create --disk-format=raw --container-format=bare --file bootstrap.ign
<image_name>
```

- Get the image's details:

```
$ openstack image show <image_name>
```

Make a note of the **file** value; it follows the pattern **v2/images/<image\_ID>/file**.



#### NOTE

Verify that the image you created is active.

- Retrieve the image service's public address:

```
$ openstack catalog show image
```

- Combine the public address with the image **file** value and save the result as the storage location. The location follows the pattern **<image\_service\_public\_URL>/v2/images/<image\_ID>/file**.

- Generate an auth token and save the token ID:

```
$ openstack token issue -c id -f value
```

- Insert the following content into a file called **\$INFRA\_ID-bootstrap-ignition.json** and edit the placeholders to match your own values:

```

{
  "ignition": {
    "config": {
      "merge": [{
        "source": "<storage_url>", 1
        "httpHeaders": [{
          "name": "X-Auth-Token", 2
          "value": "<token_ID>" 3
        }]
      }]
    },
    "security": {
      "tls": {

```

```

    "certificateAuthorities": [{
      "source": "data:text/plain;charset=utf-8;base64,<base64_encoded_certificate>" 4
    }]
  }
},
"version": "3.2.0"
}
}

```

- 1 Replace the value of **ignition.config.merge.source** with the bootstrap Ignition file storage URL.
- 2 Set **name** in **httpHeaders** to **"X-Auth-Token"**.
- 3 Set **value** in **httpHeaders** to your token's ID.
- 4 If the bootstrap Ignition file server uses a self-signed certificate, include the base64-encoded certificate.

8. Save the secondary Ignition config file.

The bootstrap Ignition data will be passed to RHOSP during installation.



#### WARNING

The bootstrap Ignition file contains sensitive information, like **clouds.yaml** credentials. Ensure that you store it in a secure place, and delete it after you complete the installation process.

### 18.8.16. Creating control plane Ignition config files on RHOSP

Installing OpenShift Container Platform on Red Hat OpenStack Platform (RHOSP) on your own infrastructure requires control plane Ignition config files. You must create multiple config files.



#### NOTE

As with the bootstrap Ignition configuration, you must explicitly define a hostname for each control plane machine.

#### Prerequisites

- The infrastructure ID from the installation program's metadata file is set as an environment variable (**\$INFRA\_ID**).
  - If the variable is not set, see "Creating the Kubernetes manifest and Ignition config files".

#### Procedure

- On a command line, run the following Python script:
  -

```

$ for index in $(seq 0 2); do
  MASTER_HOSTNAME="$INFRA_ID-master-$index\n"
  python -c "import base64, json, sys;
  ignition = json.load(sys.stdin);
  storage = ignition.get('storage', {});
  files = storage.get('files', []);
  files.append({'path': '/etc/hostname', 'mode': 420, 'contents': {'source':
'data:text/plain;charset=utf-8;base64,' +
base64.standard_b64encode(b'$MASTER_HOSTNAME').decode().strip(), 'verification': {}},
'filesystem': 'root'});
  storage['files'] = files;
  ignition['storage'] = storage;
  json.dump(ignition, sys.stdout) <master.ign >"$INFRA_ID-master-$index-ignition.json"
done

```

You now have three control plane Ignition files: **<INFRA\_ID>-master-0-ignition.json**, **<INFRA\_ID>-master-1-ignition.json**, and **<INFRA\_ID>-master-2-ignition.json**.

### 18.8.17. Creating network resources on RHOSP

Create the network resources that an OpenShift Container Platform on Red Hat OpenStack Platform (RHOSP) installation on your own infrastructure requires. To save time, run supplied Ansible playbooks that generate security groups, networks, subnets, routers, and ports.

#### Prerequisites

- Python 3 is installed on your machine.
- You downloaded the modules in "Downloading playbook dependencies".
- You downloaded the playbooks in "Downloading the installation playbooks".

#### Procedure

1. Optional: Add an external network value to the **inventory.yaml** playbook:

#### Example external network value in the **inventory.yaml** Ansible playbook

```

...
# The public network providing connectivity to the cluster. If not
# provided, the cluster external connectivity must be provided in another
# way.

# Required for os_api_fip, os_ingress_fip, os_bootstrap_fip.
os_external_network: 'external'
...

```



#### IMPORTANT

If you did not provide a value for **os\_external\_network** in the **inventory.yaml** file, you must ensure that VMs can access Glance and an external connection yourself.

- Optional: Add external network and floating IP (FIP) address values to the **inventory.yaml** playbook:

### Example FIP values in the **inventory.yaml** Ansible playbook

```
...
# OpenShift API floating IP address. If this value is non-empty, the
# corresponding floating IP will be attached to the Control Plane to
# serve the OpenShift API.
os_api_fip: '203.0.113.23'

# OpenShift Ingress floating IP address. If this value is non-empty, the
# corresponding floating IP will be attached to the worker nodes to serve
# the applications.
os_ingress_fip: '203.0.113.19'

# If this value is non-empty, the corresponding floating IP will be
# attached to the bootstrap machine. This is needed for collecting logs
# in case of install failure.
os_bootstrap_fip: '203.0.113.20'
```



### IMPORTANT

If you do not define values for **os\_api\_fip** and **os\_ingress\_fip**, you must perform post-installation network configuration.

If you do not define a value for **os\_bootstrap\_fip**, the installer cannot download debugging information from failed installations.

See "Enabling access to the environment" for more information.

- On a command line, create security groups by running the **security-groups.yaml** playbook:

```
$ ansible-playbook -i inventory.yaml security-groups.yaml
```

- On a command line, create a network, subnet, and router by running the **network.yaml** playbook:

```
$ ansible-playbook -i inventory.yaml network.yaml
```

- Optional: If you want to control the default resolvers that Nova servers use, run the RHOSP CLI command:

```
$ openstack subnet set --dns-nameserver <server_1> --dns-nameserver <server_2>
"$INFRA_ID-nodes"
```

Optionally, you can use the **inventory.yaml** file that you created to customize your installation. For example, you can deploy a cluster that uses bare metal machines.

#### 18.8.17.1. Deploying a cluster with bare metal machines

If you want your cluster to use bare metal machines, modify the **inventory.yaml** file. Your cluster can have both control plane and compute machines running on bare metal, or just compute machines.

Bare-metal compute machines are not supported on clusters that use Kuryr.



## NOTE

Be sure that your **install-config.yaml** file reflects whether the RHOSP network that you use for bare metal workers supports floating IP addresses or not.

## Prerequisites

- The RHOSP [Bare Metal service \(Ironic\)](#) is enabled and accessible via the RHOSP Compute API.
- Bare metal is available as a [RHOSP flavor](#).
- The RHOSP network supports both VM and bare metal server attachment.
- Your network configuration does not rely on a provider network. Provider networks are not supported.
- If you want to deploy the machines on a pre-existing network, a RHOSP subnet is provisioned.
- If you want to deploy the machines on an installer-provisioned network, the RHOSP Bare Metal service (Ironic) is able to listen for and interact with Preboot eXecution Environment (PXE) boot machines that run on tenant networks.
- You created an **inventory.yaml** file as part of the OpenShift Container Platform installation process.

## Procedure

1. In the **inventory.yaml** file, edit the flavors for machines:
  - a. If you want to use bare-metal control plane machines, change the value of **os\_flavor\_master** to a bare metal flavor.
  - b. Change the value of **os\_flavor\_worker** to a bare metal flavor.

### An example bare metal inventory.yaml file

```
all:
  hosts:
    localhost:
      ansible_connection: local
      ansible_python_interpreter: "{{ansible_playbook_python}}"

      # User-provided values
      os_subnet_range: '10.0.0.0/16'
      os_flavor_master: 'my-bare-metal-flavor' 1
      os_flavor_worker: 'my-bare-metal-flavor' 2
      os_image_rhcos: 'rhcos'
      os_external_network: 'external'

  ...
```

- 1 If you want to have bare-metal control plane machines, change this value to a bare metal flavor.

- 2 Change this value to a bare metal flavor to use for compute machines.

Use the updated **inventory.yaml** file to complete the installation process. Machines that are created during deployment use the flavor that you added to the file.

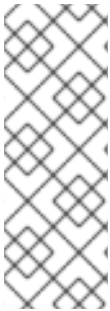

#### NOTE

The installer may time out while waiting for bare metal machines to boot.

If the installer times out, restart and then complete the deployment by using the **wait-for** command of the installer. For example:

```
$ ./openshift-install wait-for install-complete --log-level debug
```

### 18.8.18. Creating the bootstrap machine on RHOSP

Create a bootstrap machine and give it the network access it needs to run on Red Hat OpenStack Platform (RHOSP). Red Hat provides an Ansible playbook that you run to simplify this process.

#### Prerequisites

- You downloaded the modules in "Downloading playbook dependencies".
- You downloaded the playbooks in "Downloading the installation playbooks".
- The **inventory.yaml**, **common.yaml**, and **bootstrap.yaml** Ansible playbooks are in a common directory.
- The **metadata.json** file that the installation program created is in the same directory as the Ansible playbooks.

#### Procedure

1. On a command line, change the working directory to the location of the playbooks.
2. On a command line, run the **bootstrap.yaml** playbook:

```
$ ansible-playbook -i inventory.yaml bootstrap.yaml
```

3. After the bootstrap server is active, view the logs to verify that the Ignition files were received:

```
$ openstack console log show "$INFRA_ID-bootstrap"
```

### 18.8.19. Creating the control plane machines on RHOSP

Create three control plane machines by using the Ignition config files that you generated. Red Hat provides an Ansible playbook that you run to simplify this process.

#### Prerequisites

- You downloaded the modules in "Downloading playbook dependencies".



- You downloaded the playbooks in "Downloading the installation playbooks".
- The infrastructure ID from the installation program's metadata file is set as an environment variable (**\$INFRA\_ID**).
- The **inventory.yaml**, **common.yaml**, and **control-plane.yaml** Ansible playbooks are in a common directory.
- You have the three Ignition files that were created in "Creating control plane Ignition config files".

## Procedure

1. On a command line, change the working directory to the location of the playbooks.
2. If the control plane Ignition config files aren't already in your working directory, copy them into it.
3. On a command line, run the **control-plane.yaml** playbook:

```
$ ansible-playbook -i inventory.yaml control-plane.yaml
```

4. Run the following command to monitor the bootstrapping process:

```
$ openshift-install wait-for bootstrap-complete
```

You will see messages that confirm that the control plane machines are running and have joined the cluster:

```
INFO API v1.23.0 up
INFO Waiting up to 30m0s for bootstrapping to complete...
...
INFO It is now safe to remove the bootstrap resources
```

### 18.8.20. Logging in to the cluster by using the CLI

You can log in to your cluster as a default system user by exporting the cluster **kubeconfig** file. The **kubeconfig** file contains information about the cluster that is used by the CLI to connect a client to the correct cluster and API server. The file is specific to a cluster and is created during OpenShift Container Platform installation.

#### Prerequisites

- You deployed an OpenShift Container Platform cluster.
- You installed the **oc** CLI.

#### Procedure

1. Export the **kubeadmin** credentials:

```
$ export KUBECONFIG=<installation_directory>/auth/kubeconfig 1
```

- 1 For **<installation\_directory>**, specify the path to the directory that you stored the installation files in.

2. Verify you can run **oc** commands successfully using the exported configuration:

```
$ oc whoami
```

#### Example output

```
system:admin
```

## 18.8.21. Deleting bootstrap resources from RHOSP

Delete the bootstrap resources that you no longer need.

### Prerequisites

- You downloaded the modules in "Downloading playbook dependencies".
- You downloaded the playbooks in "Downloading the installation playbooks".
- The **inventory.yaml**, **common.yaml**, and **down-bootstrap.yaml** Ansible playbooks are in a common directory.
- The control plane machines are running.
  - If you do not know the status of the machines, see "Verifying cluster status".

### Procedure

1. On a command line, change the working directory to the location of the playbooks.
2. On a command line, run the **down-bootstrap.yaml** playbook:

```
$ ansible-playbook -i inventory.yaml down-bootstrap.yaml
```

The bootstrap port, server, and floating IP address are deleted.



#### WARNING

If you did not disable the bootstrap Ignition file URL earlier, do so now.

## 18.8.22. Creating SR-IOV networks for compute machines

If your Red Hat OpenStack Platform (RHOSP) deployment supports [single root I/O virtualization \(SR-IOV\)](#), you can provision SR-IOV networks that compute machines run on.

**NOTE**

The following instructions entail creating an external flat network and an external, VLAN-based network that can be attached to a compute machine. Depending on your RHOSP deployment, other network types might be required.

**Prerequisites**

- Your cluster supports SR-IOV.

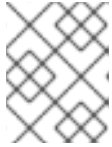
**NOTE**

If you are unsure about what your cluster supports, review the OpenShift Container Platform SR-IOV hardware networks documentation.

- You created radio and uplink provider networks as part of your RHOSP deployment. The names **radio** and **uplink** are used in all example commands to represent these networks.

**Procedure**

1. On a command line, create a radio RHOSP network:

```
$ openstack network create radio --provider-physical-network radio --provider-network-type flat --external
```

2. Create an uplink RHOSP network:

```
$ openstack network create uplink --provider-physical-network uplink --provider-network-type vlan --external
```

3. Create a subnet for the radio network:

```
$ openstack subnet create --network radio --subnet-range <radio_network_subnet_range> radio
```

4. Create a subnet for the uplink network:

```
$ openstack subnet create --network uplink --subnet-range <uplink_network_subnet_range> uplink
```

**18.8.23. Creating compute machines that run on SR-IOV networks**

After standing up the control plane, create compute machines that run on the SR-IOV networks that you created in "Creating SR-IOV networks for compute machines".

**Prerequisites**

- You downloaded the modules in "Downloading playbook dependencies".
- You downloaded the playbooks in "Downloading the installation playbooks".
- The **metadata.yaml** file that the installation program created is in the same directory as the Ansible playbooks.

- The control plane is active.
- You created **radio** and **uplink** SR-IOV networks as described in "Creating SR-IOV networks for compute machines".

## Procedure

1. On a command line, change the working directory to the location of the **inventory.yaml** and **common.yaml** files.
2. Add the **radio** and **uplink** networks to the end of the **inventory.yaml** file by using the **additionalNetworks** parameter:

```
....
# If this value is non-empty, the corresponding floating IP will be
# attached to the bootstrap machine. This is needed for collecting logs
# in case of install failure.
os_bootstrap_fip: '203.0.113.20'

additionalNetworks:
- id: radio
  count: 4 1
  type: direct
  port_security_enabled: no
- id: uplink
  count: 4 2
  type: direct
  port_security_enabled: no
```

- 1 2** The **count** parameter defines the number of SR-IOV virtual functions (VFs) to attach to each worker node. In this case, each network has four VFs.

3. Replace the content of the **compute-nodes.yaml** file with the following text:

### Example 18.1. compute-nodes.yaml

```
- import_playbook: common.yaml

- hosts: all
  gather_facts: no

vars:
  worker_list: []
  port_name_list: []
  nic_list: []

tasks:
  # Create the SDN/primary port for each worker node
  - name: 'Create the Compute ports'
    os_port:
      name: "{{ item.1 }}-{{ item.0 }}"
      network: "{{ os_network }}"
      security_groups:
        - "{{ os_sg_worker }}"
      allowed_address_pairs:
```

```

- ip_address: "{{ os_ingressVIP }}"
with_indexed_items: "{{ [os_port_worker] * os_compute_nodes_number }}"
register: ports

# Tag each SDN/primary port with cluster name
- name: 'Set Compute ports tag'
  command:
    cmd: "openstack port set --tag {{ cluster_id_tag }} {{ item.1 }}-{{ item.0 }}"
  with_indexed_items: "{{ [os_port_worker] * os_compute_nodes_number }}"

- name: 'List the Compute Trunks'
  command:
    cmd: "openstack network trunk list"
  when: os_networking_type == "Kuryr"
  register: compute_trunks

- name: 'Create the Compute trunks'
  command:
    cmd: "openstack network trunk create --parent-port {{ item.1.id }} {{
os_compute_trunk_name }}-{{ item.0 }}"
  with_indexed_items: "{{ ports.results }}"
  when:
    - os_networking_type == "Kuryr"
    - "os_compute_trunk_name|string not in compute_trunks.stdout"

- name: 'Call additional-port processing'
  include_tasks: additional-ports.yaml

# Create additional ports in OpenStack
- name: 'Create additionalNetworks ports'
  os_port:
    name: "{{ item.0 }}-{{ item.1.name }}"
    vnic_type: "{{ item.1.type }}"
    network: "{{ item.1.uuid }}"
    port_security_enabled: "{{ item.1.port_security_enabled|default(omit) }}"
    no_security_groups: "{{ 'true' if item.1.security_groups is not defined else omit }}"
    security_groups: "{{ item.1.security_groups | default(omit) }}"
  with_nested:
    - "{{ worker_list }}"
    - "{{ port_name_list }}"

# Tag the ports with the cluster info
- name: 'Set additionalNetworks ports tag'
  command:
    cmd: "openstack port set --tag {{ cluster_id_tag }} {{ item.0 }}-{{ item.1.name }}"
  with_nested:
    - "{{ worker_list }}"
    - "{{ port_name_list }}"

# Build the nic list to use for server create
- name: Build nic list
  set_fact:
    nic_list: "{{ nic_list | default([]) + [ item.name ] }}"
  with_items: "{{ port_name_list }}"

# Create the servers

```

```

- name: 'Create the Compute servers'
  vars:
    worker_nics: "{{ [ item.1 ] | product(nic_list) | map('join','-') | map('regex_replace','(.*)',
'port-name=\\1') | list }}"
    os_server:
      name: "{{ item.1 }}"
      image: "{{ os_image_rhcos }}"
      flavor: "{{ os_flavor_worker }}"
      auto_ip: no
      userdata: "{{ lookup('file', 'worker.ign') | string }}"
      security_groups: []
      nics: "{{ [ 'port-name=' + os_port_worker + '-' + item.0|string ] + worker_nics }}"
      config_drive: yes
      with_indexed_items: "{{ worker_list }}"

```

4. Insert the following content into a local file that is called **additional-ports.yaml**:

#### Example 18.2. additional-ports.yaml

```

# Build a list of worker nodes with indexes
- name: 'Build worker list'
  set_fact:
    worker_list: "{{ worker_list | default([]) + [ item.1 + '-' + item.0 | string ] }}"
    with_indexed_items: "{{ [ os_compute_server_name ] * os_compute_nodes_number }}"

# Ensure that each network specified in additionalNetworks exists
- name: 'Verify additionalNetworks'
  os_networks_info:
    name: "{{ item.id }}"
    with_items: "{{ additionalNetworks }}"
    register: network_info

# Expand additionalNetworks by the count parameter in each network definition
- name: 'Build port and port index list for additionalNetworks'
  set_fact:
    port_list: "{{ port_list | default([]) + [ {
      'net_name' : item.1.id,
      'uuid' : network_info.results[item.0].openstack_networks[0].id,
      'type' : item.1.type|default('normal'),
      'security_groups' : item.1.security_groups|default(omit),
      'port_security_enabled' : item.1.port_security_enabled|default(omit)
    } ] * item.1.count|default(1) }}"
    index_list: "{{ index_list | default([]) + range(item.1.count|default(1)) | list }}"
    with_indexed_items: "{{ additionalNetworks }}"

# Calculate and save the name of the port
# The format of the name is cluster_name-worker-workerID-networkUUID(partial)-count
# i.e. fdp-nz995-worker-1-99bcd111-1
- name: 'Calculate port name'
  set_fact:
    port_name_list: "{{ port_name_list | default([]) + [ item.1 | combine( {'name' : item.1.uuid
| regex_search('[^~]+') + '-' + index_list[item.0]|string } ) ] }}"
    with_indexed_items: "{{ port_list }}"
    when: port_list is defined

```

5. On a command line, run the **compute-nodes.yaml** playbook:

```
$ ansible-playbook -i inventory.yaml compute-nodes.yaml
```

### 18.8.24. Approving the certificate signing requests for your machines

When you add machines to a cluster, two pending certificate signing requests (CSRs) are generated for each machine that you added. You must confirm that these CSRs are approved or, if necessary, approve them yourself. The client requests must be approved first, followed by the server requests.

#### Prerequisites

- You added machines to your cluster.

#### Procedure

- Confirm that the cluster recognizes the machines:

```
$ oc get nodes
```

#### Example output

```
NAME      STATUS    ROLES    AGE    VERSION
master-0  Ready     master   63m    v1.23.0
master-1  Ready     master   63m    v1.23.0
master-2  Ready     master   64m    v1.23.0
```

The output lists all of the machines that you created.

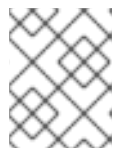

#### NOTE

The preceding output might not include the compute nodes, also known as worker nodes, until some CSRs are approved.

- Review the pending CSRs and ensure that you see the client requests with the **Pending** or **Approved** status for each machine that you added to the cluster:

```
$ oc get csr
```

#### Example output

```
NAME      AGE    REQUESTOR                                     CONDITION
csr-8b2br  15m    system:serviceaccount:openshift-machine-config-operator:node-
bootstrapper  Pending
csr-8vnps  15m    system:serviceaccount:openshift-machine-config-operator:node-
bootstrapper  Pending
...
```

In this example, two machines are joining the cluster. You might see more approved CSRs in the list.

- If the CSRs were not approved, after all of the pending CSRs for the machines you added are in **Pending** status, approve the CSRs for your cluster machines:



#### NOTE

Because the CSRs rotate automatically, approve your CSRs within an hour of adding the machines to the cluster. If you do not approve them within an hour, the certificates will rotate, and more than two certificates will be present for each node. You must approve all of these certificates. After the client CSR is approved, the Kubelet creates a secondary CSR for the serving certificate, which requires manual approval. Then, subsequent serving certificate renewal requests are automatically approved by the **machine-approver** if the Kubelet requests a new certificate with identical parameters.

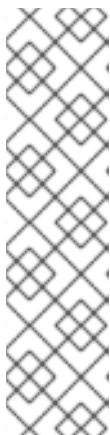

#### NOTE

For clusters running on platforms that are not machine API enabled, such as bare metal and other user-provisioned infrastructure, you must implement a method of automatically approving the kubelet serving certificate requests (CSRs). If a request is not approved, then the **oc exec**, **oc rsh**, and **oc logs** commands cannot succeed, because a serving certificate is required when the API server connects to the kubelet. Any operation that contacts the Kubelet endpoint requires this certificate approval to be in place. The method must watch for new CSRs, confirm that the CSR was submitted by the **node-bootstrapper** service account in the **system:node** or **system:admin** groups, and confirm the identity of the node.

- To approve them individually, run the following command for each valid CSR:

```
$ oc adm certificate approve <csr_name> 1
```

- 1** **<csr\_name>** is the name of a CSR from the list of current CSRs.

- To approve all pending CSRs, run the following command:

```
$ oc get csr -o go-template='{{range .items}}{{if not .status}}{{.metadata.name}}{"\n"}{{end}}{{end}}' | xargs --no-run-if-empty oc adm certificate approve
```



#### NOTE

Some Operators might not become available until some CSRs are approved.

- Now that your client requests are approved, you must review the server requests for each machine that you added to the cluster:

```
$ oc get csr
```

#### Example output

```
NAME      AGE   REQUESTOR                                     CONDITION
csr-bfd72 5m26s system:node:ip-10-0-50-126.us-east-2.compute.internal
Pending
```



```
csr-c57lv 5m26s system:node:ip-10-0-95-157.us-east-2.compute.internal
Pending
...
```

- If the remaining CSRs are not approved, and are in the **Pending** status, approve the CSRs for your cluster machines:

- To approve them individually, run the following command for each valid CSR:

```
$ oc adm certificate approve <csr_name> 1
```

- 1** **<csr\_name>** is the name of a CSR from the list of current CSRs.

- To approve all pending CSRs, run the following command:

```
$ oc get csr -o go-template='{{range .items}}{{if not .status}}{{.metadata.name}}{\n"}\n{{end}}\n' | xargs oc adm certificate approve
```

- After all client and server CSRs have been approved, the machines have the **Ready** status. Verify this by running the following command:

```
$ oc get nodes
```

### Example output

```
NAME      STATUS  ROLES  AGE  VERSION
master-0  Ready   master 73m  v1.23.0
master-1  Ready   master 73m  v1.23.0
master-2  Ready   master 74m  v1.23.0
worker-0  Ready   worker 11m  v1.23.0
worker-1  Ready   worker 11m  v1.23.0
```

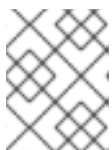

### NOTE

It can take a few minutes after approval of the server CSRs for the machines to transition to the **Ready** status.

### Additional information

- For more information on CSRs, see [Certificate Signing Requests](#).

## 18.8.25. Verifying a successful installation

Verify that the OpenShift Container Platform installation is complete.

### Prerequisites

- You have the installation program (**openshift-install**)

### Procedure

- On a command line, enter:

```
$ openshift-install --log-level debug wait-for install-complete
```

The program outputs the console URL, as well as the administrator's login information.

The cluster is operational. Before you can configure it for SR-IOV networks though, you must perform additional tasks.

## 18.8.26. Preparing a cluster that runs on RHOSP for SR-IOV

Before you use [single root I/O virtualization \(SR-IOV\)](#) on a cluster that runs on Red Hat OpenStack Platform (RHOSP), make the RHOSP metadata service mountable as a drive and enable the No-IOMMU Operator for the virtual function I/O (VFIO) driver.

### 18.8.26.1. Enabling the RHOSP metadata service as a mountable drive

You can apply a machine config to your machine pool that makes the Red Hat OpenStack Platform (RHOSP) metadata service available as a mountable drive.

The following machine config enables the display of RHOSP network UUIDs from within the SR-IOV Network Operator. This configuration simplifies the association of SR-IOV resources to cluster SR-IOV resources.

#### Procedure

1. Create a machine config file from the following template:

#### A mountable metadata service machine config file

```
kind: MachineConfig
apiVersion: machineconfiguration.openshift.io/v1
metadata:
  name: 20-mount-config 1
  labels:
    machineconfiguration.openshift.io/role: worker
spec:
  config:
    ignition:
      version: 3.2.0
    systemd:
      units:
        - name: create-mountpoint-var-config.service
          enabled: true
          contents: |
            [Unit]
            Description=Create mountpoint /var/config
            Before=kubelet.service

            [Service]
            ExecStart=/bin/mkdir -p /var/config

            [Install]
            WantedBy=var-config.mount
        - name: var-config.mount
```

```

enabled: true
contents: |
  [Unit]
  Before=local-fs.target
  [Mount]
  Where=/var/config
  What=/dev/disk/by-label/config-2
  [Install]
  WantedBy=local-fs.target

```

1 You can substitute a name of your choice.

2. From a command line, apply the machine config:

```
$ oc apply -f <machine_config_file_name>.yaml
```

### 18.8.26.2. Enabling the No-IOMMU feature for the RHOSP VFIO driver

You can apply a machine config to your machine pool that enables the No-IOMMU feature for the Red Hat OpenStack Platform (RHOSP) virtual function I/O (VFIO) driver. The RHOSP vfio-pci driver requires this feature.

#### Procedure

1. Create a machine config file from the following template:

#### A No-IOMMU VFIO machine config file

```

kind: MachineConfig
apiVersion: machineconfiguration.openshift.io/v1
metadata:
  name: 99-vfio-noiommu 1
  labels:
    machineconfiguration.openshift.io/role: worker
spec:
  config:
    ignition:
      version: 3.2.0
    storage:
      files:
        - path: /etc/modprobe.d/vfio-noiommu.conf
          mode: 0644
          contents:
            source:
              data:;base64,b3B0aW9ucyB2ZmlvIGVuYWJsZV91bnNhZmVfbm9pb21tdV9tb2RIPTEK

```

1 You can substitute a name of your choice.

2. From a command line, apply the machine config:

```
$ oc apply -f <machine_config_file_name>.yaml
```

**NOTE**

After you apply the machine config to the machine pool, you can [watch the machine config pool status](#) to see when the machines are available.

The cluster is installed and prepared for SR-IOV configuration. You must now perform the SR-IOV configuration tasks in "Next steps".

### 18.8.27. Telemetry access for OpenShift Container Platform

In OpenShift Container Platform 4.10, the Telemetry service, which runs by default to provide metrics about cluster health and the success of updates, requires internet access. If your cluster is connected to the internet, Telemetry runs automatically, and your cluster is registered to [OpenShift Cluster Manager](#).

After you confirm that your [OpenShift Cluster Manager](#) inventory is correct, either maintained automatically by Telemetry or manually by using OpenShift Cluster Manager, [use subscription watch](#) to track your OpenShift Container Platform subscriptions at the account or multi-cluster level.

#### Additional resources

- See [About remote health monitoring](#) for more information about the Telemetry service

### 18.8.28. Additional resources

- See [Performance Addon Operator for low latency nodes](#) for information about configuring your deployment for real-time running and low latency.

### 18.8.29. Next steps

- To complete SR-IOV configuration for your cluster:
  - [Install the Performance Addon Operator](#).
  - [Configure the Performance Addon Operator with huge pages support](#).
  - [Install the SR-IOV Operator](#).
  - [Configure your SR-IOV network device](#).
- [Customize your cluster](#).
- If necessary, you can [opt out of remote health reporting](#).
- If you need to enable external access to node ports, [configure ingress cluster traffic by using a node port](#).
- If you did not configure RHOSP to accept application traffic over floating IP addresses, [configure RHOSP access with floating IP addresses](#).

## 18.9. INSTALLING A CLUSTER ON OPENSTACK IN A RESTRICTED NETWORK

In OpenShift Container Platform 4.10, you can install a cluster on Red Hat OpenStack Platform (RHOSP) in a restricted network by creating an internal mirror of the installation release content.

### 18.9.1. Prerequisites

- You reviewed details about the [OpenShift Container Platform installation and update processes](#).
- You read the documentation on [selecting a cluster installation method and preparing it for users](#).
- You verified that OpenShift Container Platform 4.10 is compatible with your RHOSP version by using the [Supported platforms for OpenShift clusters](#) section. You can also compare platform support across different versions by viewing the [OpenShift Container Platform on RHOSP support matrix](#).
- You [created a registry on your mirror host](#) and obtained the **imageContentSources** data for your version of OpenShift Container Platform.



#### IMPORTANT

Because the installation media is on the mirror host, you can use that computer to complete all installation steps.

- You understand performance and scalability practices for cluster scaling, control plane sizing, and etcd. For more information, see [Recommended host practices](#).
- You have the metadata service enabled in RHOSP.

### 18.9.2. About installations in restricted networks

In OpenShift Container Platform 4.10, you can perform an installation that does not require an active connection to the internet to obtain software components. Restricted network installations can be completed using installer-provisioned infrastructure or user-provisioned infrastructure, depending on the cloud platform to which you are installing the cluster.

If you choose to perform a restricted network installation on a cloud platform, you still require access to its cloud APIs. Some cloud functions, like Amazon Web Service's Route 53 DNS and IAM services, require internet access. Depending on your network, you might require less internet access for an installation on bare metal hardware or on VMware vSphere.

To complete a restricted network installation, you must create a registry that mirrors the contents of the OpenShift image registry and contains the installation media. You can create this registry on a mirror host, which can access both the internet and your closed network, or by using other methods that meet your restrictions.

#### 18.9.2.1. Additional limits

Clusters in restricted networks have the following additional limitations and restrictions:

- The **ClusterVersion** status includes an **Unable to retrieve available updates** error.
- By default, you cannot use the contents of the Developer Catalog because you cannot access the required image stream tags.

### 18.9.3. Resource guidelines for installing OpenShift Container Platform on RHOSP

To support an OpenShift Container Platform installation, your Red Hat OpenStack Platform (RHOSP) quota must meet the following requirements:

**Table 18.39. Recommended resources for a default OpenShift Container Platform cluster on RHOSP**

Resource	Value
Floating IP addresses	3
Ports	15
Routers	1
Subnets	1
RAM	88 GB
vCPUs	22
Volume storage	275 GB
Instances	7
Security groups	3
Security group rules	60
Server groups	2 - plus 1 for each additional availability zone in each machine pool

A cluster might function with fewer than recommended resources, but its performance is not guaranteed.

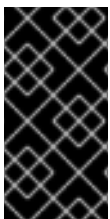

### IMPORTANT

If RHOSP object storage (Swift) is available and operated by a user account with the **swiftoperator** role, it is used as the default backend for the OpenShift Container Platform image registry. In this case, the volume storage requirement is 175 GB. Swift space requirements vary depending on the size of the image registry.



### NOTE

By default, your security group and security group rule quotas might be low. If you encounter problems, run **openstack quota set --secgroups 3 --secgroup-rules 60 <project>** as an administrator to increase them.

An OpenShift Container Platform deployment comprises control plane machines, compute machines, and a bootstrap machine.

### 18.9.3.1. Control plane machines

By default, the OpenShift Container Platform installation process creates three control plane machines.

Each machine requires:

- An instance from the RHOSP quota
- A port from the RHOSP quota
- A flavor with at least 16 GB memory and 4 vCPUs
- At least 100 GB storage space from the RHOSP quota

### 18.9.3.2. Compute machines

By default, the OpenShift Container Platform installation process creates three compute machines.

Each machine requires:

- An instance from the RHOSP quota
- A port from the RHOSP quota
- A flavor with at least 8 GB memory and 2 vCPUs
- At least 100 GB storage space from the RHOSP quota

#### TIP

Compute machines host the applications that you run on OpenShift Container Platform; aim to run as many as you can.

### 18.9.3.3. Bootstrap machine

During installation, a bootstrap machine is temporarily provisioned to stand up the control plane. After the production control plane is ready, the bootstrap machine is deprovisioned.

The bootstrap machine requires:

- An instance from the RHOSP quota
- A port from the RHOSP quota
- A flavor with at least 16 GB memory and 4 vCPUs
- At least 100 GB storage space from the RHOSP quota

### 18.9.4. Internet access for OpenShift Container Platform

In OpenShift Container Platform 4.10, you require access to the internet to obtain the images that are necessary to install your cluster.

You must have internet access to:

- Access [OpenShift Cluster Manager](#) to download the installation program and perform subscription management. If the cluster has internet access and you do not disable Telemetry, that service automatically entitles your cluster.
- Access [Quay.io](#) to obtain the packages that are required to install your cluster.
- Obtain the packages that are required to perform cluster updates.

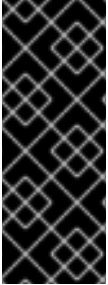

### IMPORTANT

If your cluster cannot have direct internet access, you can perform a restricted network installation on some types of infrastructure that you provision. During that process, you download the required content and use it to populate a mirror registry with the installation packages. With some installation types, the environment that you install your cluster in will not require internet access. Before you update the cluster, you update the content of the mirror registry.

## 18.9.5. Enabling Swift on RHOSP

Swift is operated by a user account with the **swiftoperator** role. Add the role to an account before you run the installation program.



### IMPORTANT

If [the Red Hat OpenStack Platform \(RHOSP\) object storage service](#), commonly known as Swift, is available, OpenShift Container Platform uses it as the image registry storage. If it is unavailable, the installation program relies on the RHOSP block storage service, commonly known as Cinder.

If Swift is present and you want to use it, you must enable access to it. If it is not present, or if you do not want to use it, skip this section.

### Prerequisites

- You have a RHOSP administrator account on the target environment.
- The Swift service is installed.
- On [Ceph RGW](#), the **account in url** option is enabled.

### Procedure

To enable Swift on RHOSP:

1. As an administrator in the RHOSP CLI, add the **swiftoperator** role to the account that will access Swift:

```
$ openstack role add --user <user> --project <project> swiftoperator
```

Your RHOSP deployment can now use Swift for the image registry.

## 18.9.6. Defining parameters for the installation program



The OpenShift Container Platform installation program relies on a file that is called **clouds.yaml**. The file describes Red Hat OpenStack Platform (RHOSP) configuration parameters, including the project name, log in information, and authorization service URLs.

## Procedure

### 1. Create the **clouds.yaml** file:

- If your RHOSP distribution includes the Horizon web UI, generate a **clouds.yaml** file in it.



### IMPORTANT

Remember to add a password to the **auth** field. You can also keep secrets in [a separate file](#) from **clouds.yaml**.

- If your RHOSP distribution does not include the Horizon web UI, or you do not want to use Horizon, create the file yourself. For detailed information about **clouds.yaml**, see [Config files](#) in the RHOSP documentation.

```
clouds:
  shiftstack:
    auth:
      auth_url: http://10.10.14.42:5000/v3
      project_name: shiftstack
      username: <username>
      password: <password>
      user_domain_name: Default
      project_domain_name: Default
  dev-env:
    region_name: RegionOne
    auth:
      username: <username>
      password: <password>
      project_name: 'devonly'
      auth_url: 'https://10.10.14.22:5001/v2.0'
```

### 2. If your RHOSP installation uses self-signed certificate authority (CA) certificates for endpoint authentication:

- a. Copy the certificate authority file to your machine.
- b. Add the **cacerts** key to the **clouds.yaml** file. The value must be an absolute, non-root-accessible path to the CA certificate:

```
clouds:
  shiftstack:
    ...
    cacert: "/etc/pki/ca-trust/source/anchors/ca.crt.pem"
```

**TIP**

After you run the installer with a custom CA certificate, you can update the certificate by editing the value of the **ca-cert.pem** key in the **cloud-provider-config** keymap. On a command line, run:

```
$ oc edit configmap -n openshift-config cloud-provider-config
```

3. Place the **clouds.yaml** file in one of the following locations:
  - a. The value of the **OS\_CLIENT\_CONFIG\_FILE** environment variable
  - b. The current directory
  - c. A Unix-specific user configuration directory, for example **~/.config/openstack/clouds.yaml**
  - d. A Unix-specific site configuration directory, for example **/etc/openstack/clouds.yaml**

The installation program searches for **clouds.yaml** in that order.

### 18.9.7. Setting cloud provider options

Optionally, you can edit the cloud provider configuration for your cluster. The cloud provider configuration controls how OpenShift Container Platform interacts with Red Hat OpenStack Platform (RHOSP).

For a complete list of cloud provider configuration parameters, see the "OpenStack cloud configuration reference guide" page in the "Installing on OpenStack" documentation.

#### Procedure

1. If you have not already generated manifest files for your cluster, generate them by running the following command:

```
$ openshift-install --dir <destination_directory> create manifests
```

2. In a text editor, open the cloud-provider configuration manifest file. For example:

```
$ vi openshift/manifests/cloud-provider-config.yaml
```

3. Modify the options based on the cloud configuration specification. Configuring Octavia for load balancing is a common case for clusters that do not use Kuryr. For example:

```
#...
[LoadBalancer]
use-octavia=true 1
lb-provider = "amphora" 2
floating-network-id="d3deb660-4190-40a3-91f1-37326fe6ec4a" 3
create-monitor = True 4
monitor-delay = 10s 5
monitor-timeout = 10s 6
monitor-max-retries = 1 7
#...
```

- 1 This property enables Octavia integration.
- 2 This property sets the Octavia provider that your load balancer uses. It accepts **"ovn"** or **"amphora"** as values. If you choose to use OVN, you must also set **lb-method** to **SOURCE\_IP\_PORT**.
- 3 This property is required if you want to use multiple external networks with your cluster. The cloud provider creates floating IP addresses on the network that is specified here.
- 4 This property controls whether the cloud provider creates health monitors for Octavia load balancers. Set the value to **True** to create health monitors. As of RHOSP 16.1 and 16.2, this feature is only available for the Amphora provider.
- 5 This property sets the frequency with which endpoints are monitored. The value must be in the **time.ParseDuration()** format. This property is required if the value of the **create-monitor** property is **True**.
- 6 This property sets the time that monitoring requests are open before timing out. The value must be in the **time.ParseDuration()** format. This property is required if the value of the **create-monitor** property is **True**.
- 7 This property defines how many successful monitoring requests are required before a load balancer is marked as online. The value must be an integer. This property is required if the value of the **create-monitor** property is **True**.

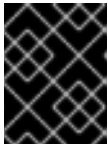

#### IMPORTANT

Prior to saving your changes, verify that the file is structured correctly. Clusters might fail if properties are not placed in the appropriate section.

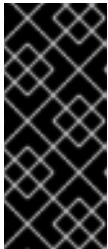

#### IMPORTANT

You must set the value of the **create-monitor** property to **True** if you use services that have the value of the **.spec.externalTrafficPolicy** property set to **Local**. The OVN Octavia provider in RHOSP 16.1 and 16.2 does not support health monitors. Therefore, services that have **ETP** parameter values set to **Local** might not respond when the **lb-provider** value is set to **"ovn"**.

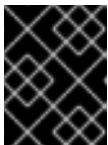

#### IMPORTANT

For installations that use Kuryr, Kuryr handles relevant services. There is no need to configure Octavia load balancing in the cloud provider.

4. Save the changes to the file and proceed with installation.

**TIP**

You can update your cloud provider configuration after you run the installer. On a command line, run:

```
$ oc edit configmap -n openshift-config cloud-provider-config
```

After you save your changes, your cluster will take some time to reconfigure itself. The process is complete if none of your nodes have a **SchedulingDisabled** status.

### 18.9.7.1. External load balancers that use pre-defined floating IP addresses

Commonly, Red Hat OpenStack Platform (RHOSP) deployments disallow non-administrator users from creating specific floating IP addresses. If such a policy is in place and you use a floating IP address in your service specification, the cloud provider will fail to handle IP address assignment to load balancers.

If you use an external cloud provider, you can avoid this problem by pre-creating a floating IP address and specifying it in your service specification. The in-tree cloud provider does not support this method.

Alternatively, you can [modify the RHOSP Networking service \(Neutron\) to allow non-administrator users to create specific floating IP addresses](#).

#### Additional resources

- For more information about cloud provider configuration, see [OpenStack cloud provider options](#).

### 18.9.8. Creating the RHCOS image for restricted network installations

Download the Red Hat Enterprise Linux CoreOS (RHCOS) image to install OpenShift Container Platform on a restricted network Red Hat OpenStack Platform (RHOSP) environment.

#### Prerequisites

- Obtain the OpenShift Container Platform installation program. For a restricted network installation, the program is on your mirror registry host.

#### Procedure

1. Log in to the Red Hat Customer Portal's [Product Downloads page](#).
2. Under **Version**, select the most recent release of OpenShift Container Platform 4.10 for RHEL 8.



#### IMPORTANT

The RHCOS images might not change with every release of OpenShift Container Platform. You must download images with the highest version that is less than or equal to the OpenShift Container Platform version that you install. Use the image versions that match your OpenShift Container Platform version if they are available.

3. Download the **Red Hat Enterprise Linux CoreOS (RHCOS) - OpenStack Image (QCOW)** image.

- Decompress the image.



### NOTE

You must decompress the image before the cluster can use it. The name of the downloaded file might not contain a compression extension, like **.gz** or **.tgz**. To find out if or how the file is compressed, in a command line, enter:

```
$ file <name_of_downloaded_file>
```

- Upload the image that you decompressed to a location that is accessible from the bastion server, like Glance. For example:

```
$ openstack image create --file rhcos-44.81.202003110027-0-openstack.x86_64.qcow2 --
disk-format qcow2 rhcos- $\{RHCOS\_VERSION\}$ 
```



### IMPORTANT

Depending on your RHOSP environment, you might be able to upload the image in either **.raw** or **.qcow2** formats. If you use Ceph, you must use the **.raw** format.



### WARNING

If the installation program finds multiple images with the same name, it chooses one of them at random. To avoid this behavior, create unique names for resources in RHOSP.

The image is now available for a restricted installation. Note the image name or location for use in OpenShift Container Platform deployment.

## 18.9.9. Creating the installation configuration file

You can customize the OpenShift Container Platform cluster you install on Red Hat OpenStack Platform (RHOSP).

### Prerequisites

- Obtain the OpenShift Container Platform installation program and the pull secret for your cluster. For a restricted network installation, these files are on your mirror host.
- Have the **imageContentSources** values that were generated during mirror registry creation.
- Obtain the contents of the certificate for your mirror registry.
- Retrieve a Red Hat Enterprise Linux CoreOS (RHCOS) image and upload it to an accessible location.
- Obtain service principal permissions at the subscription level.

## Procedure

1. Create the **install-config.yaml** file.
  - a. Change to the directory that contains the installation program and run the following command:

```
$. /openshift-install create install-config --dir <installation_directory> 1
```

- 1** For **<installation\_directory>**, specify the directory name to store the files that the installation program creates.



### IMPORTANT

Specify an empty directory. Some installation assets, like bootstrap X.509 certificates have short expiration intervals, so you must not reuse an installation directory. If you want to reuse individual files from another cluster installation, you can copy them into your directory. However, the file names for the installation assets might change between releases. Use caution when copying installation files from an earlier OpenShift Container Platform version.

- b. At the prompts, provide the configuration details for your cloud:
    - i. Optional: Select an SSH key to use to access your cluster machines.



### NOTE

For production OpenShift Container Platform clusters on which you want to perform installation debugging or disaster recovery, specify an SSH key that your **ssh-agent** process uses.

- ii. Select **openstack** as the platform to target.
        - iii. Specify the Red Hat OpenStack Platform (RHOSP) external network name to use for installing the cluster.
        - iv. Specify the floating IP address to use for external access to the OpenShift API.
        - v. Specify a RHOSP flavor with at least 16 GB RAM to use for control plane nodes and 8 GB RAM for compute nodes.
        - vi. Select the base domain to deploy the cluster to. All DNS records will be sub-domains of this base and will also include the cluster name.
        - vii. Enter a name for your cluster. The name must be 14 or fewer characters long.
        - viii. Paste the [pull secret from the Red Hat OpenShift Cluster Manager](#) .
2. In the **install-config.yaml** file, set the value of **platform.openstack.clusterOSImage** to the image location or name. For example:

```
platform:
  openstack:
```

```
clusterOSImage: http://mirror.example.com/images/rhcos-43.81.201912131630.0-
openstack.x86_64.qcow2.gz?
sha256=ffebbd68e8a1f2a245ca19522c16c86f67f9ac8e4e0c1f0a812b068b16f7265d
```

3. Edit the **install-config.yaml** file to give the additional information that is required for an installation in a restricted network.
  - a. Update the **pullSecret** value to contain the authentication information for your registry:

```
pullSecret: '{"auths":{"<mirror_host_name>:5000": {"auth": "<credentials>","email":
"you@example.com"}}}'
```

For **<mirror\_host\_name>**, specify the registry domain name that you specified in the certificate for your mirror registry, and for **<credentials>**, specify the base64-encoded user name and password for your mirror registry.

- b. Add the **additionalTrustBundle** parameter and value.

```
additionalTrustBundle: |
-----BEGIN CERTIFICATE-----

////////////////////////////////////
-----END CERTIFICATE-----
```

The value must be the contents of the certificate file that you used for your mirror registry. The certificate file can be an existing, trusted certificate authority, or the self-signed certificate that you generated for the mirror registry.

- c. Add the image content resources, which resemble the following YAML excerpt:

```
imageContentSources:
- mirrors:
  - <mirror_host_name>:5000/<repo_name>/release
    source: quay.io/openshift-release-dev/ocp-release
- mirrors:
  - <mirror_host_name>:5000/<repo_name>/release
    source: registry.redhat.io/ocp/release
```

For these values, use the **imageContentSources** that you recorded during mirror registry creation.

4. Make any other modifications to the **install-config.yaml** file that you require. You can find more information about the available parameters in the **Installation configuration parameters** section.
5. Back up the **install-config.yaml** file so that you can use it to install multiple clusters.



### IMPORTANT

The **install-config.yaml** file is consumed during the installation process. If you want to reuse the file, you must back it up now.

#### 18.9.9.1. Configuring the cluster-wide proxy during installation

Production environments can deny direct access to the internet and instead have an HTTP or HTTPS proxy available. You can configure a new OpenShift Container Platform cluster to use a proxy by configuring the proxy settings in the **install-config.yaml** file.



## NOTE

Kuryr installations default to HTTP proxies.

## Prerequisites

- For Kuryr installations on restricted networks that use the **Proxy** object, the proxy must be able to reply to the router that the cluster uses. To add a static route for the proxy configuration, from a command line as the root user, enter:

```
$ ip route add <cluster_network_cidr> via <installer_subnet_gateway>
```

- The restricted subnet must have a gateway that is defined and available to be linked to the **Router** resource that Kuryr creates.
- You have an existing **install-config.yaml** file.
- You reviewed the sites that your cluster requires access to and determined whether any of them need to bypass the proxy. By default, all cluster egress traffic is proxied, including calls to hosting cloud provider APIs. You added sites to the **Proxy** object's **spec.noProxy** field to bypass the proxy if necessary.



## NOTE

The **Proxy** object **status.noProxy** field is populated with the values of the **networking.machineNetwork[].cidr**, **networking.clusterNetwork[].cidr**, and **networking.serviceNetwork[]** fields from your installation configuration.

For installations on Amazon Web Services (AWS), Google Cloud Platform (GCP), Microsoft Azure, and Red Hat OpenStack Platform (RHOSP), the **Proxy** object **status.noProxy** field is also populated with the instance metadata endpoint (**169.254.169.254**).

## Procedure

- Edit your **install-config.yaml** file and add the proxy settings. For example:

```
apiVersion: v1
baseDomain: my.domain.com
proxy:
  httpProxy: http://<username>:<pswd>@<ip>:<port> 1
  httpsProxy: https://<username>:<pswd>@<ip>:<port> 2
  noProxy: example.com 3
  additionalTrustBundle: | 4
    -----BEGIN CERTIFICATE-----
    <MY_TRUSTED_CA_CERT>
    -----END CERTIFICATE-----
  ...
```



- 1 A proxy URL to use for creating HTTP connections outside the cluster. The URL scheme must be **http**.
- 2 A proxy URL to use for creating HTTPS connections outside the cluster.
- 3 A comma-separated list of destination domain names, IP addresses, or other network CIDRs to exclude from proxying. Preface a domain with **.** to match subdomains only. For example, **.y.com** matches **x.y.com**, but not **y.com**. Use **\*** to bypass the proxy for all destinations.
- 4 If provided, the installation program generates a config map that is named **user-ca-bundle** in the **openshift-config** namespace that contains one or more additional CA certificates that are required for proxying HTTPS connections. The Cluster Network Operator then creates a **trusted-ca-bundle** config map that merges these contents with the Red Hat Enterprise Linux CoreOS (RHCOS) trust bundle, and this config map is referenced in the **trustedCA** field of the **Proxy** object. The **additionalTrustBundle** field is required unless the proxy's identity certificate is signed by an authority from the RHCOS trust bundle.

**NOTE**

The installation program does not support the proxy **readinessEndpoints** field.

**NOTE**

If the installer times out, restart and then complete the deployment by using the **wait-for** command of the installer. For example:

```
$ ./openshift-install wait-for install-complete --log-level debug
```

2. Save the file and reference it when installing OpenShift Container Platform.

The installation program creates a cluster-wide proxy that is named **cluster** that uses the proxy settings in the provided **install-config.yaml** file. If no proxy settings are provided, a **cluster Proxy** object is still created, but it will have a nil **spec**.

**NOTE**

Only the **Proxy** object named **cluster** is supported, and no additional proxies can be created.

### 18.9.9.2. Installation configuration parameters

Before you deploy an OpenShift Container Platform cluster, you provide parameter values to describe your account on the cloud platform that hosts your cluster and optionally customize your cluster's platform. When you create the **install-config.yaml** installation configuration file, you provide values for the required parameters through the command line. If you customize your cluster, you can modify the **install-config.yaml** file to provide more details about the platform.

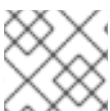
**NOTE**

After installation, you cannot modify these parameters in the **install-config.yaml** file.

## 18.9.9.2.1. Required configuration parameters

Required installation configuration parameters are described in the following table:

Table 18.40. Required parameters

Parameter	Description	Values
<b>apiVersion</b>	The API version for the <b>install-config.yaml</b> content. The current version is <b>v1</b> . The installer may also support older API versions.	String
<b>baseDomain</b>	The base domain of your cloud provider. The base domain is used to create routes to your OpenShift Container Platform cluster components. The full DNS name for your cluster is a combination of the <b>baseDomain</b> and <b>metadata.name</b> parameter values that uses the <b>&lt;metadata.name&gt;</b> . <b>&lt;baseDomain&gt;</b> format.	A fully-qualified domain or subdomain name, such as <b>example.com</b> .
<b>metadata</b>	Kubernetes resource <b>ObjectMeta</b> , from which only the <b>name</b> parameter is consumed.	Object
<b>metadata.name</b>	The name of the cluster. DNS records for the cluster are all subdomains of <b>{{.metadata.name}}</b> . <b>{{.baseDomain}}</b> .	String of lowercase letters, hyphens (-), and periods (.), such as <b>dev</b> . The string must be 14 characters or fewer long.
<b>platform</b>	The configuration for the specific platform upon which to perform the installation: <b>alibabacloud</b> , <b>aws</b> , <b>baremetal</b> , <b>azure</b> , <b>gcp</b> , <b>ibmcloud</b> , <b>openstack</b> , <b>ovirt</b> , <b>vsphere</b> , or <b>{}</b> . For additional information about <b>platform.&lt;platform&gt;</b> parameters, consult the table for your specific platform that follows.	Object

Parameter	Description	Values
<b>pullSecret</b>	Get a <a href="#">pull secret from the Red Hat OpenShift Cluster Manager</a> to authenticate downloading container images for OpenShift Container Platform components from services such as Quay.io.	<pre>{   "auths":{     "cloud.openshift.com":{       "auth":"b3Blb=",       "email":"you@example.com"     },     "quay.io":{       "auth":"b3Blb=",       "email":"you@example.com"     }   } }</pre>

### 18.9.9.2.2. Network configuration parameters

You can customize your installation configuration based on the requirements of your existing network infrastructure. For example, you can expand the IP address block for the cluster network or provide different IP address blocks than the defaults.

Only IPv4 addresses are supported.

Table 18.41. Network parameters

Parameter	Description	Values
<b>networking</b>	The configuration for the cluster network.	Object  <div style="margin-left: 20px;"> <p><b>NOTE</b></p> <p>You cannot modify parameters specified by the <b>networking</b> object after installation.</p> </div>
<b>networking.networkType</b>	The cluster network provider Container Network Interface (CNI) plugin to install.	Either <b>OpenShiftSDN</b> or <b>OVNKubernetes</b> . <b>OpenShiftSDN</b> is a CNI provider for all-Linux networks. <b>OVNKubernetes</b> is a CNI provider for Linux networks and hybrid networks that contain both Linux and Windows servers. The default value is <b>OpenShiftSDN</b> .

Parameter	Description	Values
<b>networking.clusterNetwork</b>	<p>The IP address blocks for pods.</p> <p>The default value is <b>10.128.0.0/14</b> with a host prefix of <b>/23</b>.</p> <p>If you specify multiple IP address blocks, the blocks must not overlap.</p>	<p>An array of objects. For example:</p> <pre>networking:   clusterNetwork:   - cidr: 10.128.0.0/14     hostPrefix: 23</pre>
<b>networking.clusterNetwork.cidr</b>	<p>Required if you use <b>networking.clusterNetwork</b>. An IP address block.</p> <p>An IPv4 network.</p>	<p>An IP address block in Classless Inter-Domain Routing (CIDR) notation. The prefix length for an IPv4 block is between <b>0</b> and <b>32</b>.</p>
<b>networking.clusterNetwork.hostPrefix</b>	<p>The subnet prefix length to assign to each individual node. For example, if <b>hostPrefix</b> is set to <b>23</b> then each node is assigned a <b>/23</b> subnet out of the given <b>cidr</b>. A <b>hostPrefix</b> value of <b>23</b> provides 510 (<math>2^{(32 - 23)} - 2</math>) pod IP addresses.</p>	<p>A subnet prefix.</p> <p>The default value is <b>23</b>.</p>
<b>networking.serviceNetwork</b>	<p>The IP address block for services. The default value is <b>172.30.0.0/16</b>.</p> <p>The OpenShift SDN and OVN-Kubernetes network providers support only a single IP address block for the service network.</p>	<p>An array with an IP address block in CIDR format. For example:</p> <pre>networking:   serviceNetwork:   - 172.30.0.0/16</pre>
<b>networking.machineNetwork</b>	<p>The IP address blocks for machines.</p> <p>If you specify multiple IP address blocks, the blocks must not overlap.</p>	<p>An array of objects. For example:</p> <pre>networking:   machineNetwork:   - cidr: 10.0.0.0/16</pre>
<b>networking.machineNetwork.cidr</b>	<p>Required if you use <b>networking.machineNetwork</b>. An IP address block. The default value is <b>10.0.0.0/16</b> for all platforms other than libvirt. For libvirt, the default value is <b>192.168.126.0/24</b>.</p>	<p>An IP network block in CIDR notation.</p> <p>For example, <b>10.0.0.0/16</b>.</p> <div style="display: flex; align-items: flex-start;">  <div> <p><b>NOTE</b></p> <p>Set the <b>networking.machineNetwork</b> to match the CIDR that the preferred NIC resides in.</p> </div> </div>

## 18.9.9.2.3. Optional configuration parameters

Optional installation configuration parameters are described in the following table:

Table 18.42. Optional parameters

Parameter	Description	Values
<b>additionalTrustBundle</b>	A PEM-encoded X.509 certificate bundle that is added to the nodes' trusted certificate store. This trust bundle may also be used when a proxy has been configured.	String
<b>cgroupsV2</b>	Enables <a href="#">Linux control groups version 2</a> (cgroups v2) on specific nodes in your cluster. The OpenShift Container Platform process for enabling cgroups v2 disables all cgroup version 1 controllers and hierarchies. The OpenShift Container Platform cgroups version 2 feature is in Developer Preview and is not supported by Red Hat at this time.	<b>true</b>
<b>compute</b>	The configuration for the machines that comprise the compute nodes.	Array of <b>MachinePool</b> objects.
<b>compute.architecture</b>	Determines the instruction set architecture of the machines in the pool. Currently, clusters with varied architectures are not supported. All pools must specify the same architecture. Valid values are <b>amd64</b> (the default).	String
<b>compute.hyperthreading</b>	Whether to enable or disable simultaneous multithreading, or <b>hyperthreading</b> , on compute machines. By default, simultaneous multithreading is enabled to increase the performance of your machines' cores.	<b>Enabled</b> or <b>Disabled</b>
	 <p><b>IMPORTANT</b></p> <p>If you disable simultaneous multithreading, ensure that your capacity planning accounts for the dramatically decreased machine performance.</p>	

Parameter	Description	Values
<b>compute.name</b>	Required if you use <b>compute</b> . The name of the machine pool.	<b>worker</b>
<b>compute.platform</b>	Required if you use <b>compute</b> . Use this parameter to specify the cloud provider to host the worker machines. This parameter value must match the <b>controlPlane.platform</b> parameter value.	<b>alibabacloud, aws, azure, gcp, ibmcloud, openstack, ovirt, vsphere</b> , or <b>{}</b>
<b>compute.replicas</b>	The number of compute machines, which are also known as worker machines, to provision.	A positive integer greater than or equal to <b>2</b> . The default value is <b>3</b> .
<b>controlPlane</b>	The configuration for the machines that comprise the control plane.	Array of <b>MachinePool</b> objects.
<b>controlPlane.architecture</b>	Determines the instruction set architecture of the machines in the pool. Currently, clusters with varied architectures are not supported. All pools must specify the same architecture. Valid values are <b>amd64</b> (the default).	String
<b>controlPlane.hyperthreading</b>	<p>Whether to enable or disable simultaneous multithreading, or <b>hyperthreading</b>, on control plane machines. By default, simultaneous multithreading is enabled to increase the performance of your machines' cores.</p> <div style="display: flex; align-items: center;">  <div> <p><b>IMPORTANT</b></p> <p>If you disable simultaneous multithreading, ensure that your capacity planning accounts for the dramatically decreased machine performance.</p> </div> </div>	<b>Enabled</b> or <b>Disabled</b>
<b>controlPlane.name</b>	Required if you use <b>controlPlane</b> . The name of the machine pool.	<b>master</b>

Parameter	Description	Values
<b>controlPlane.platform</b>	Required if you use <b>controlPlane</b> . Use this parameter to specify the cloud provider that hosts the control plane machines. This parameter value must match the <b>compute.platform</b> parameter value.	<b>alibabacloud, aws, azure, gcp, ibmcloud, openstack, ovirt, vsphere</b> , or {}
<b>controlPlane.replicas</b>	The number of control plane machines to provision.	The only supported value is <b>3</b> , which is the default value.
<b>credentialsMode</b>	<p>The Cloud Credential Operator (CCO) mode. If no mode is specified, the CCO dynamically tries to determine the capabilities of the provided credentials, with a preference for mint mode on the platforms where multiple modes are supported.</p> <div style="display: flex; align-items: flex-start;"> <div style="width: 20px; height: 100px; background: repeating-linear-gradient(45deg, transparent, transparent 2px, #ccc 2px, #ccc 4px); margin-right: 10px;"></div> <div> <p><b>NOTE</b></p> <p>Not all CCO modes are supported for all cloud providers. For more information on CCO modes, see the <i>Cloud Credential Operator</i> entry in the <i>Cluster Operators</i> reference content.</p> </div> </div> <div style="display: flex; align-items: flex-start; margin-top: 10px;"> <div style="width: 20px; height: 100px; background: repeating-linear-gradient(45deg, transparent, transparent 2px, #ccc 2px, #ccc 4px); margin-right: 10px;"></div> <div> <p><b>NOTE</b></p> <p>If your AWS account has service control policies (SCP) enabled, you must configure the <b>credentialsMode</b> parameter to <b>Mint</b>, <b>Passthrough</b> or <b>Manual</b>.</p> </div> </div>	<b>Mint, Passthrough, Manual</b> or an empty string ("").

Parameter	Description	Values
<p><b>fips</b></p>	<p>Enable or disable FIPS mode. The default is <b>false</b> (disabled). If FIPS mode is enabled, the Red Hat Enterprise Linux CoreOS (RHCOS) machines that OpenShift Container Platform runs on bypass the default Kubernetes cryptography suite and use the cryptography modules that are provided with RHCOS instead.</p> <div data-bbox="486 584 593 1361" style="background-color: black; color: white; padding: 5px; margin-bottom: 10px;"> <p><b>IMPORTANT</b></p> <p>To enable FIPS mode for your cluster, you must run the installation program from a Red Hat Enterprise Linux (RHEL) computer configured to operate in FIPS mode. For more information about configuring FIPS mode on RHEL, see <a href="#">Installing the system in FIPS mode</a>. The use of FIPS validated or Modules In Process cryptographic libraries is only supported on OpenShift Container Platform deployments on the <b>x86_64</b> architecture.</p> </div> <div data-bbox="486 1406 593 1608" style="background-color: #f0f0f0; padding: 5px;"> <p><b>NOTE</b></p> <p>If you are using Azure File storage, you cannot enable FIPS mode.</p> </div>	<p><b>false</b> or <b>true</b></p>



Parameter	Description	Values
<b>imageContentSources</b>	Sources and repositories for the release-image content.	Array of objects. Includes a <b>source</b> and, optionally, <b>mirrors</b> , as described in the following rows of this table.
<b>imageContentSources.source</b>	Required if you use <b>imageContentSources</b> . Specify the repository that users refer to, for example, in image pull specifications.	String
<b>imageContentSources.mirrors</b>	Specify one or more repositories that may also contain the same images.	Array of strings
<b>publish</b>	How to publish or expose the user-facing endpoints of your cluster, such as the Kubernetes API, OpenShift routes.	<p><b>Internal</b> or <b>External</b>. The default value is <b>External</b>.</p> <p>Setting this field to <b>Internal</b> is not supported on non-cloud platforms and IBM Cloud VPC.</p> <div style="display: flex; align-items: flex-start;">  <div> <p><b>IMPORTANT</b></p> <p>If the value of the field is set to <b>Internal</b>, the cluster will become non-functional. For more information, refer to <a href="#">BZ#1953035</a>.</p> </div> </div>
<b>sshKey</b>	<p>The SSH key or keys to authenticate access your cluster machines.</p> <div style="display: flex; align-items: flex-start;">  <div> <p><b>NOTE</b></p> <p>For production OpenShift Container Platform clusters on which you want to perform installation debugging or disaster recovery, specify an SSH key that your <b>ssh-agent</b> process uses.</p> </div> </div>	<p>One or more keys. For example:</p> <pre>sshKey:   &lt;key1&gt;   &lt;key2&gt;   &lt;key3&gt;</pre>

#### 18.9.9.2.4. Additional Red Hat OpenStack Platform (RHOSP) configuration parameters

Additional RHOSP configuration parameters are described in the following table:

Table 18.43. Additional RHOSP parameters

Parameter	Description	Values
<b>compute.platform.openstack.rootVolume.size</b>	For compute machines, the size in gigabytes of the root volume. If you do not set this value, machines use ephemeral storage.	Integer, for example <b>30</b> .
<b>compute.platform.openstack.rootVolume.type</b>	For compute machines, the root volume's type.	String, for example <b>performance</b> .
<b>controlPlane.platform.openstack.rootVolume.size</b>	For control plane machines, the size in gigabytes of the root volume. If you do not set this value, machines use ephemeral storage.	Integer, for example <b>30</b> .
<b>controlPlane.platform.openstack.rootVolume.type</b>	For control plane machines, the root volume's type.	String, for example <b>performance</b> .
<b>platform.openstack.cloud</b>	The name of the RHOSP cloud to use from the list of clouds in the <b>clouds.yaml</b> file.	String, for example <b>MyCloud</b> .
<b>platform.openstack.externalNetwork</b>	The RHOSP external network name to be used for installation.	String, for example <b>external</b> .
<b>platform.openstack.computeFlavor</b>	<p>The RHOSP flavor to use for control plane and compute machines.</p> <p>This property is deprecated. To use a flavor as the default for all machine pools, add it as the value of the <b>type</b> key in the <b>platform.openstack.defaultMachinePlatform</b> property. You can also set a flavor value for each machine pool individually.</p>	String, for example <b>m1.xlarge</b> .

#### 18.9.9.2.5. Optional RHOSP configuration parameters

Optional RHOSP configuration parameters are described in the following table:

Table 18.44. Optional RHOSP parameters

Parameter	Description	Values
<b>compute.platform.openstack.additionalNetworkIds</b>	Additional networks that are associated with compute machines. Allowed address pairs are not created for additional networks.	A list of one or more UUIDs as strings. For example, <b>fa806b2f-ac49-4bce-b9db-124bc64209bf</b> .
<b>compute.platform.openstack.additionalSecurityGroupIds</b>	Additional security groups that are associated with compute machines.	A list of one or more UUIDs as strings. For example, <b>7ee219f3-d2e9-48a1-96c2-e7429f1b0da7</b> .
<b>compute.platform.openstack.zones</b>	<p>RHOSP Compute (Nova) availability zones (AZs) to install machines on. If this parameter is not set, the installer relies on the default settings for Nova that the RHOSP administrator configured.</p> <p>On clusters that use Kuryr, RHOSP Octavia does not support availability zones. Load balancers and, if you are using the Amphora provider driver, OpenShift Container Platform services that rely on Amphora VMs, are not created according to the value of this property.</p>	A list of strings. For example, <b>["zone-1", "zone-2"]</b> .
<b>compute.platform.openstack.rootVolume.zones</b>	For compute machines, the availability zone to install root volumes on. If you do not set a value for this parameter, the installer selects the default availability zone.	A list of strings, for example <b>["zone-1", "zone-2"]</b> .

Parameter	Description	Values
<b>compute.platform.openstack.serverGroupPolicy</b>	<p>Server group policy to apply to the group that will contain the compute machines in the pool. You cannot change server group policies or affiliations after creation. Supported options include <b>anti-affinity</b>, <b>soft-affinity</b>, and <b>soft-anti-affinity</b>. The default value is <b>soft-anti-affinity</b>.</p> <p>An <b>affinity</b> policy prevents migrations and therefore affects RHOSP upgrades. The <b>affinity</b> policy is not supported.</p> <p>If you use a strict <b>anti-affinity</b> policy, an additional RHOSP host is required during instance migration.</p>	<p>A server group policy to apply to the machine pool. For example, <b>soft-affinity</b>.</p>
<b>controlPlane.platform.openstack.additionalNetworkIDs</b>	<p>Additional networks that are associated with control plane machines. Allowed address pairs are not created for additional networks.</p>	<p>A list of one or more UUIDs as strings. For example, <b>fa806b2f-ac49-4bce-b9db-124bc64209bf</b>.</p>
<b>controlPlane.platform.openstack.additionalSecurityGroupIDs</b>	<p>Additional security groups that are associated with control plane machines.</p>	<p>A list of one or more UUIDs as strings. For example, <b>7ee219f3-d2e9-48a1-96c2-e7429f1b0da7</b>.</p>

Parameter	Description	Values
<b>controlPlane.placement.openstack.zones</b>	<p>RHOSP Compute (Nova) availability zones (AZs) to install machines on. If this parameter is not set, the installer relies on the default settings for Nova that the RHOSP administrator configured.</p> <p>On clusters that use Kuryr, RHOSP Octavia does not support availability zones. Load balancers and, if you are using the Amphora provider driver, OpenShift Container Platform services that rely on Amphora VMs, are not created according to the value of this property.</p>	A list of strings. For example, <b>["zone-1", "zone-2"]</b> .
<b>controlPlane.placement.openstack.rootVolume.zones</b>	For control plane machines, the availability zone to install root volumes on. If you do not set this value, the installer selects the default availability zone.	A list of strings, for example <b>["zone-1", "zone-2"]</b> .
<b>controlPlane.placement.openstack.serverGroupPolicy</b>	<p>Server group policy to apply to the group that will contain the control plane machines in the pool. You cannot change server group policies or affiliations after creation. Supported options include <b>anti-affinity</b>, <b>soft-affinity</b>, and <b>soft-anti-affinity</b>. The default value is <b>soft-anti-affinity</b>.</p> <p>An <b>affinity</b> policy prevents migrations, and therefore affects RHOSP upgrades. The <b>affinity</b> policy is not supported.</p> <p>If you use a strict <b>anti-affinity</b> policy, an additional RHOSP host is required during instance migration.</p>	A server group policy to apply to the machine pool. For example, <b>soft-affinity</b> .

Parameter	Description	Values
<b>platform.openstack.clusterOSImage</b>	<p>The location from which the installer downloads the RHCOS image.</p> <p>You must set this parameter to perform an installation in a restricted network.</p>	<p>An HTTP or HTTPS URL, optionally with an SHA-256 checksum.</p> <p>For example,  <b>http://mirror.example.com/images/rhcos-43.81.201912131630.0-openstack.x86_64.qcow2.gz?sha256=ffebbd68e8a1f2a245ca19522c16c86f67f9ac8e4e0c1f0a812b068b16f7265d</b>. The value can also be the name of an existing Glance image, for example <b>my-rhcos</b>.</p>
<b>platform.openstack.clusterOSImageProperties</b>	<p>Properties to add to the installer-uploaded ClusterOSImage in Glance. This property is ignored if <b>platform.openstack.clusterOSImage</b> is set to an existing Glance image.</p> <p>You can use this property to exceed the default persistent volume (PV) limit for RHOSP of 26 PVs per node. To exceed the limit, set the <b>hw_scsi_model</b> property value to <b>virtio-scsi</b> and the <b>hw_disk_bus</b> value to <b>scsi</b>.</p> <p>You can also use this property to enable the QEMU guest agent by including the <b>hw_qemu_guest_agent</b> property with a value of <b>yes</b>.</p>	<p>A list of key-value string pairs. For example,  <b>[{"hw_scsi_model": "virtio-scsi", "hw_disk_bus": "scsi"}]</b>.</p>
<b>platform.openstack.defaultMachinePlatform</b>	<p>The default machine pool platform configuration.</p>	<pre>{   "type": "ml.large",   "rootVolume": {     "size": 30,     "type": "performance"   } }</pre>
<b>platform.openstack.ingressFloatingIP</b>	<p>An existing floating IP address to associate with the Ingress port. To use this property, you must also define the <b>platform.openstack.externalNetwork</b> property.</p>	<p>An IP address, for example <b>128.0.0.1</b>.</p>

Parameter	Description	Values
<b>platform.openstack.apiFloatingIP</b>	An existing floating IP address to associate with the API load balancer. To use this property, you must also define the <b>platform.openstack.externalNetwork</b> property.	An IP address, for example <b>128.0.0.1</b> .
<b>platform.openstack.externalDNS</b>	IP addresses for external DNS servers that cluster instances use for DNS resolution.	A list of IP addresses as strings. For example, <b>["8.8.8.8", "192.168.1.12"]</b> .
<b>platform.openstack.machinesSubnet</b>	<p>The UUID of a RHOSP subnet that the cluster's nodes use. Nodes and virtual IP (VIP) ports are created on this subnet.</p> <p>The first item in <b>networking.machineNetwork</b> must match the value of <b>machinesSubnet</b>.</p> <p>If you deploy to a custom subnet, you cannot specify an external DNS server to the OpenShift Container Platform installer. Instead, <a href="#">add DNS to the subnet in RHOSP</a>.</p>	A UUID as a string. For example, <b>fa806b2f-ac49-4bce-b9db-124bc64209bf</b> .

### 18.9.9.3. Sample customized `install-config.yaml` file for restricted OpenStack installations

This sample **`install-config.yaml`** demonstrates all of the possible Red Hat OpenStack Platform (RHOSP) customization options.



#### IMPORTANT

This sample file is provided for reference only. You must obtain your **`install-config.yaml`** file by using the installation program.

```
apiVersion: v1
baseDomain: example.com
controlPlane:
  name: master
  platform: {}
  replicas: 3
compute:
- name: worker
  platform:
    openstack:
      type: ml.large
```

```

replicas: 3
metadata:
  name: example
networking:
  clusterNetwork:
  - cidr: 10.128.0.0/14
    hostPrefix: 23
  machineNetwork:
  - cidr: 10.0.0.0/16
  serviceNetwork:
  - 172.30.0.0/16
  networkType: OpenShiftSDN
platform:
  openstack:
    region: region1
    cloud: mycloud
    externalNetwork: external
    computeFlavor: m1.xlarge
    apiFloatingIP: 128.0.0.1
  fips: false
  pullSecret: '{"auths": ...}'
  sshKey: ssh-ed25519 AAAA...
  additionalTrustBundle: |

  -----BEGIN CERTIFICATE-----

  /-----END CERTIFICATE-----

imageContentSources:
- mirrors:
  - <mirror_registry>/<repo_name>/release
  source: quay.io/openshift-release-dev/ocp-release
- mirrors:
  - <mirror_registry>/<repo_name>/release
  source: quay.io/openshift-release-dev/ocp-v4.0-art-dev

```

### 18.9.10. Generating a key pair for cluster node SSH access

During an OpenShift Container Platform installation, you can provide an SSH public key to the installation program. The key is passed to the Red Hat Enterprise Linux CoreOS (RHCOS) nodes through their Ignition config files and is used to authenticate SSH access to the nodes. The key is added to the `~/.ssh/authorized_keys` list for the **core** user on each node, which enables password-less authentication.

After the key is passed to the nodes, you can use the key pair to SSH in to the RHCOS nodes as the user **core**. To access the nodes through SSH, the private key identity must be managed by SSH for your local user.

If you want to SSH in to your cluster nodes to perform installation debugging or disaster recovery, you must provide the SSH public key during the installation process. The `./openshift-install gather` command also requires the SSH public key to be in place on the cluster nodes.



**IMPORTANT**

Do not skip this procedure in production environments, where disaster recovery and debugging is required.

**NOTE**

You must use a local key, not one that you configured with platform-specific approaches such as [AWS key pairs](#).

**Procedure**

1. If you do not have an existing SSH key pair on your local machine to use for authentication onto your cluster nodes, create one. For example, on a computer that uses a Linux operating system, run the following command:

```
$ ssh-keygen -t ed25519 -N "" -f <path>/<file_name> 1
```

- 1 Specify the path and file name, such as `~/.ssh/id_ed25519`, of the new SSH key. If you have an existing key pair, ensure your public key is in the your `~/.ssh` directory.

**NOTE**

If you plan to install an OpenShift Container Platform cluster that uses FIPS validated or Modules In Process cryptographic libraries on the **x86\_64** architecture, do not create a key that uses the **ed25519** algorithm. Instead, create a key that uses the **rsa** or **ecdsa** algorithm.

2. View the public SSH key:

```
$ cat <path>/<file_name>.pub
```

For example, run the following to view the `~/.ssh/id_ed25519.pub` public key:

```
$ cat ~/.ssh/id_ed25519.pub
```

3. Add the SSH private key identity to the SSH agent for your local user, if it has not already been added. SSH agent management of the key is required for password-less SSH authentication onto your cluster nodes, or if you want to use the `./openshift-install gather` command.

**NOTE**

On some distributions, default SSH private key identities such as `~/.ssh/id_rsa` and `~/.ssh/id_dsa` are managed automatically.

- a. If the **ssh-agent** process is not already running for your local user, start it as a background task:

```
$ eval "$(ssh-agent -s)"
```

**Example output**

```
Agent pid 31874
```

**NOTE**

If your cluster is in FIPS mode, only use FIPS-compliant algorithms to generate the SSH key. The key must be either RSA or ECDSA.

4. Add your SSH private key to the **ssh-agent**:

```
$ ssh-add <path>/<file_name> 1
```

- 1** Specify the path and file name for your SSH private key, such as `~/.ssh/id_ed25519`

**Example output**

```
Identity added: /home/<you>/<path>/<file_name> (<computer_name>)
```

**Next steps**

- When you install OpenShift Container Platform, provide the SSH public key to the installation program.

**18.9.11. Enabling access to the environment**

At deployment, all OpenShift Container Platform machines are created in a Red Hat OpenStack Platform (RHOSP)-tenant network. Therefore, they are not accessible directly in most RHOSP deployments.

You can configure OpenShift Container Platform API and application access by using floating IP addresses (FIPs) during installation. You can also complete an installation without configuring FIPs, but the installer will not configure a way to reach the API or applications externally.

**18.9.11.1. Enabling access with floating IP addresses**

Create floating IP (FIP) addresses for external access to the OpenShift Container Platform API and cluster applications.

**Procedure**

1. Using the Red Hat OpenStack Platform (RHOSP) CLI, create the API FIP:

```
$ openstack floating ip create --description "API <cluster_name>.<base_domain>"
<external_network>
```

2. Using the Red Hat OpenStack Platform (RHOSP) CLI, create the apps, or Ingress, FIP:

```
$ openstack floating ip create --description "Ingress <cluster_name>.<base_domain>"
<external_network>
```

3. Add records that follow these patterns to your DNS server for the API and Ingress FIPs:

```
api.<cluster_name>.<base_domain>. IN A <API_FIP>
*.apps.<cluster_name>.<base_domain>. IN A <apps_FIP>
```



## NOTE

If you do not control the DNS server, you can access the cluster by adding the cluster domain names such as the following to your `/etc/hosts` file:

- `<api_floating_ip> api.<cluster_name>.<base_domain>`
- `<application_floating_ip> grafana-openshift-monitoring.apps.<cluster_name>.<base_domain>`
- `<application_floating_ip> prometheus-k8s-openshift-monitoring.apps.<cluster_name>.<base_domain>`
- `<application_floating_ip> oauth-openshift.apps.<cluster_name>.<base_domain>`
- `<application_floating_ip> console-openshift-console.apps.<cluster_name>.<base_domain>`
- `application_floating_ip integrated-oauth-server-openshift-authentication.apps.<cluster_name>.<base_domain>`

The cluster domain names in the `/etc/hosts` file grant access to the web console and the monitoring interface of your cluster locally. You can also use the **kubectl** or **oc**. You can access the user applications by using the additional entries pointing to the `<application_floating_ip>`. This action makes the API and applications accessible to only you, which is not suitable for production deployment, but does allow installation for development and testing.

4. Add the FIPs to the `install-config.yaml` file as the values of the following parameters:

- `platform.openstack.ingressFloatingIP`
- `platform.openstack.apiFloatingIP`

If you use these values, you must also enter an external network as the value of the `platform.openstack.externalNetwork` parameter in the `install-config.yaml` file.

## TIP

You can make OpenShift Container Platform resources available outside of the cluster by assigning a floating IP address and updating your firewall configuration.

### 18.9.11.2. Completing installation without floating IP addresses

You can install OpenShift Container Platform on Red Hat OpenStack Platform (RHOSP) without providing floating IP addresses.

In the `install-config.yaml` file, do not define the following parameters:

- `platform.openstack.ingressFloatingIP`

- **platform.openstack.apiFloatingIP**

If you cannot provide an external network, you can also leave **platform.openstack.externalNetwork** blank. If you do not provide a value for **platform.openstack.externalNetwork**, a router is not created for you, and, without additional action, the installer will fail to retrieve an image from Glance. You must configure external connectivity on your own.

If you run the installer from a system that cannot reach the cluster API due to a lack of floating IP addresses or name resolution, installation fails. To prevent installation failure in these cases, you can use a proxy network or run the installer from a system that is on the same network as your machines.



### NOTE

You can enable name resolution by creating DNS records for the API and Ingress ports. For example:

```
api.<cluster_name>.<base_domain>. IN A <api_port_IP>
*.apps.<cluster_name>.<base_domain>. IN A <ingress_port_IP>
```

If you do not control the DNS server, you can add the record to your **/etc/hosts** file. This action makes the API accessible to only you, which is not suitable for production deployment but does allow installation for development and testing.

## 18.9.12. Deploying the cluster

You can install OpenShift Container Platform on a compatible cloud platform.

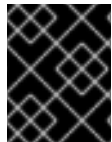

### IMPORTANT

You can run the **create cluster** command of the installation program only once, during initial installation.

### Prerequisites

- Obtain the OpenShift Container Platform installation program and the pull secret for your cluster.

### Procedure

1. Change to the directory that contains the installation program and initialize the cluster deployment:

```
$ ./openshift-install create cluster --dir <installation_directory> \ 1
--log-level=info 2
```

- 1 For **<installation\_directory>**, specify the location of your customized **./install-config.yaml** file.
- 2 To view different installation details, specify **warn**, **debug**, or **error** instead of **info**.

**NOTE**

If the cloud provider account that you configured on your host does not have sufficient permissions to deploy the cluster, the installation process stops, and the missing permissions are displayed.

When the cluster deployment completes, directions for accessing your cluster, including a link to its web console and credentials for the **kubeadmin** user, display in your terminal.

**Example output**

```
...
INFO Install complete!
INFO To access the cluster as the system:admin user when using 'oc', run 'export
KUBECONFIG=/home/myuser/install_dir/auth/kubeconfig'
INFO Access the OpenShift web-console here: https://console-openshift-
console.apps.mycluster.example.com
INFO Login to the console with user: "kubeadmin", and password: "4vYBz-Ee6gm-ymBZj-
Wt5AL"
INFO Time elapsed: 36m22s
```

**NOTE**

The cluster access and credential information also outputs to **<installation\_directory>/openshift\_install.log** when an installation succeeds.

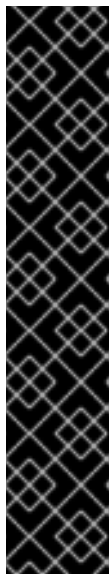
**IMPORTANT**

- The Ignition config files that the installation program generates contain certificates that expire after 24 hours, which are then renewed at that time. If the cluster is shut down before renewing the certificates and the cluster is later restarted after the 24 hours have elapsed, the cluster automatically recovers the expired certificates. The exception is that you must manually approve the pending **node-bootstrapper** certificate signing requests (CSRs) to recover kubelet certificates. See the documentation for *Recovering from expired control plane certificates* for more information.
- It is recommended that you use Ignition config files within 12 hours after they are generated because the 24-hour certificate rotates from 16 to 22 hours after the cluster is installed. By using the Ignition config files within 12 hours, you can avoid installation failure if the certificate update runs during installation.

**IMPORTANT**

You must not delete the installation program or the files that the installation program creates. Both are required to delete the cluster.

**18.9.13. Verifying cluster status**

You can verify your OpenShift Container Platform cluster's status during or after installation.

**Procedure**

1. In the cluster environment, export the administrator's kubeconfig file:

```
$ export KUBECONFIG=<installation_directory>/auth/kubeconfig 1
```

- 1 For **<installation\_directory>**, specify the path to the directory that you stored the installation files in.

The **kubeconfig** file contains information about the cluster that is used by the CLI to connect a client to the correct cluster and API server.

2. View the control plane and compute machines created after a deployment:

```
$ oc get nodes
```

3. View your cluster's version:

```
$ oc get clusterversion
```

4. View your Operators' status:

```
$ oc get clusteroperator
```

5. View all running pods in the cluster:

```
$ oc get pods -A
```

### 18.9.14. Logging in to the cluster by using the CLI

You can log in to your cluster as a default system user by exporting the cluster **kubeconfig** file. The **kubeconfig** file contains information about the cluster that is used by the CLI to connect a client to the correct cluster and API server. The file is specific to a cluster and is created during OpenShift Container Platform installation.

#### Prerequisites

- You deployed an OpenShift Container Platform cluster.
- You installed the **oc** CLI.

#### Procedure

1. Export the **kubeadmin** credentials:

```
$ export KUBECONFIG=<installation_directory>/auth/kubeconfig 1
```

- 1 For **<installation\_directory>**, specify the path to the directory that you stored the installation files in.

2. Verify you can run **oc** commands successfully using the exported configuration:

```
$ oc whoami
```

## Example output

```
system:admin
```

### Additional resources

- See [Accessing the web console](#) for more details about accessing and understanding the OpenShift Container Platform web console.

## 18.9.15. Disabling the default OperatorHub sources

Operator catalogs that source content provided by Red Hat and community projects are configured for OperatorHub by default during an OpenShift Container Platform installation. In a restricted network environment, you must disable the default catalogs as a cluster administrator.

### Procedure

- Disable the sources for the default catalogs by adding **disableAllDefaultSources: true** to the **OperatorHub** object:

```
$ oc patch OperatorHub cluster --type json \
  -p '[{"op": "add", "path": "/spec/disableAllDefaultSources", "value": true}]'
```

### TIP

Alternatively, you can use the web console to manage catalog sources. From the **Administration** → **Cluster Settings** → **Configuration** → **OperatorHub** page, click the **Sources** tab, where you can create, delete, disable, and enable individual sources.

## 18.9.16. Telemetry access for OpenShift Container Platform

In OpenShift Container Platform 4.10, the Telemetry service, which runs by default to provide metrics about cluster health and the success of updates, requires internet access. If your cluster is connected to the internet, Telemetry runs automatically, and your cluster is registered to [OpenShift Cluster Manager](#).

After you confirm that your [OpenShift Cluster Manager](#) inventory is correct, either maintained automatically by Telemetry or manually by using OpenShift Cluster Manager, [use subscription watch](#) to track your OpenShift Container Platform subscriptions at the account or multi-cluster level.

### Additional resources

- See [About remote health monitoring](#) for more information about the Telemetry service

## 18.9.17. Next steps

- [Customize your cluster](#).
- If the mirror registry that you used to install your cluster has a trusted CA, add it to the cluster by [configuring additional trust stores](#).
- If necessary, you can [opt out of remote health reporting](#).
- If necessary, see [Registering your disconnected cluster](#)

- [Configure image streams](#) for the Cluster Samples Operator and the **must-gather** tool.
- Learn how to [use Operator Lifecycle Manager \(OLM\) on restricted networks](#).
- If you did not configure RHOSP to accept application traffic over floating IP addresses, [configure RHOSP access with floating IP addresses](#).

## 18.10. OPENSTACK CLOUD CONFIGURATION REFERENCE GUIDE

A cloud provider configuration controls how OpenShift Container Platform interacts with Red Hat OpenStack Platform (RHOSP). Use the following parameters in a cloud-provider configuration manifest file to configure your cluster.

### 18.10.1. OpenStack cloud provider options

The cloud provider configuration, typically stored as a file named **cloud.conf**, controls how OpenShift Container Platform interacts with Red Hat OpenStack Platform (RHOSP).

You can create a valid **cloud.conf** file by specifying the following options in it.

#### 18.10.1.1. Global options

The following options are used for RHOSP CCM authentication with the RHOSP Identity service, also known as Keystone. They are similar to the global options that you can set by using the **openstack** CLI.

Option	Description
<b>auth-url</b>	The RHOSP Identity service URL. For example, <b>http://128.110.154.166/identity</b> .
<b>ca-file</b>	Optional. The CA certificate bundle file for communication with the RHOSP Identity service. If you use the HTTPS protocol with The Identity service URL, this option is required.
<b>domain-id</b>	The Identity service user domain ID.  Leave this option unset if you are using Identity service application credentials.
<b>domain-name</b>	The Identity service user domain name.  This option is not required if you set <b>domain-id</b> .
<b>tenant-id</b>	The Identity service project ID. Leave this option unset if you are using Identity service application credentials.  In version 3 of the Identity API, which changed the identifier <b>tenant</b> to <b>project</b> , the value of <b>tenant-id</b> is automatically mapped to the project construct in the API.



Option	Description
<b>tenant-name</b>	The Identity service project name.
<b>username</b>	The Identity service user name.  Leave this option unset if you are using Identity service application credentials.
<b>password</b>	The Identity service user password.  Leave this option unset if you are using Identity service application credentials.
<b>region</b>	The Identity service region name.
<b>trust-id</b>	The Identity service trust ID. A trust represents the authorization of a user, or trustor, to delegate roles to another user, or trustee. Optionally, a trust authorizes the trustee to impersonate the trustor. You can find available trusts by querying the <b>/v3/OS-TRUST/trusts</b> endpoint of the Identity service API.

### 18.10.1.2. Load balancer options

The cloud provider supports several load balancer options for deployments that use Octavia.

Option	Description
<b>use-octavia</b>	Whether or not to use Octavia for the <b>LoadBalancer</b> type of the service implementation rather than Neutron-LBaaS. The default value is <b>true</b> .
<b>floating-network-id</b>	Optional. The external network used to create floating IP addresses for load balancer virtual IP addresses (VIPs). If there are multiple external networks in the cloud, this option must be set or the user must specify <b>loadbalancer.openstack.org/floating-network-id</b> in the service annotation.

Option	Description
<b>lb-method</b>	<p>The load balancing algorithm used to create the load balancer pool. For the Amphora provider the value can be <b>ROUND_ROBIN</b>, <b>LEAST_CONNECTIONS</b>, or <b>SOURCE_IP</b>. The default value is <b>ROUND_ROBIN</b>.</p> <p>For the OVN provider, only the <b>SOURCE_IP_PORT</b> algorithm is supported.</p> <p>For the Amphora provider, if using the <b>LEAST_CONNECTIONS</b> or <b>SOURCE_IP</b> methods, configure the <b>create-monitor</b> option as <b>true</b> in the <b>cloud-provider-config</b> config map on the <b>openshift-config</b> namespace and <b>ETP:Local</b> on the load-balancer type service to allow balancing algorithm enforcement in the client to service endpoint connections.</p>
<b>lb-provider</b>	Optional. Used to specify the provider of the load balancer, for example, <b>amphora</b> or <b>octavia</b> . Only the Amphora and Octavia providers are supported.
<b>lb-version</b>	Optional. The load balancer API version. Only <b>"v2"</b> is supported.
<b>subnet-id</b>	The ID of the Networking service subnet on which load balancer VIPs are created.
<b>create-monitor</b>	<p>Whether or not to create a health monitor for the service load balancer. A health monitor is required for services that declare <b>externalTrafficPolicy: Local</b>. The default value is <b>false</b>.</p> <p>This option is unsupported if you use RHOSP earlier than version 17 with the <b>ovn</b> provider.</p>
<b>monitor-delay</b>	The interval in seconds by which probes are sent to members of the load balancer. The default value is <b>5</b> .
<b>monitor-max-retries</b>	The number of successful checks that are required to change the operating status of a load balancer member to <b>ONLINE</b> . The valid range is <b>1</b> to <b>10</b> , and the default value is <b>1</b> .
<b>monitor-timeout</b>	The time in seconds that a monitor waits to connect to the back end before it times out. The default value is <b>3</b> .

### 18.10.1.3. Metadata options

Option	Description
<b>search-order</b>	<p>This configuration key affects the way that the provider retrieves metadata that relates to the instances in which it runs. The default value of <b>configDrive,metadataService</b> results in the provider retrieving instance metadata from the configuration drive first if available, and then the metadata service. Alternative values are:</p> <ul style="list-style-type: none"> <li>● <b>configDrive</b>: Only retrieve instance metadata from the configuration drive.</li> <li>● <b>metadataService</b>: Only retrieve instance metadata from the metadata service.</li> <li>● <b>metadataService,configDrive</b>: Retrieve instance metadata from the metadata service first if available, and then retrieve instance metadata from the configuration drive.</li> </ul>

## 18.11. UNINSTALLING A CLUSTER ON OPENSTACK

You can remove a cluster that you deployed to Red Hat OpenStack Platform (RHOSP).

### 18.11.1. Removing a cluster that uses installer-provisioned infrastructure

You can remove a cluster that uses installer-provisioned infrastructure from your cloud.



#### NOTE

After uninstallation, check your cloud provider for any resources not removed properly, especially with User Provisioned Infrastructure (UPI) clusters. There might be resources that the installer did not create or that the installer is unable to access.

#### Prerequisites

- Have a copy of the installation program that you used to deploy the cluster.
- Have the files that the installation program generated when you created your cluster.

#### Procedure

1. From the directory that contains the installation program on the computer that you used to install the cluster, run the following command:

```

$ ./openshift-install destroy cluster \
--dir <installation_directory> --log-level info 1 2

```

- 1 For **<installation\_directory>**, specify the path to the directory that you stored the installation files in.

- 2 To view different details, specify **warn**, **debug**, or **error** instead of **info**.



## NOTE

You must specify the directory that contains the cluster definition files for your cluster. The installation program requires the **metadata.json** file in this directory to delete the cluster.

- Optional: Delete the **<installation\_directory>** directory and the OpenShift Container Platform installation program.

## 18.12. UNINSTALLING A CLUSTER ON RHOSP FROM YOUR OWN INFRASTRUCTURE

You can remove a cluster that you deployed to Red Hat OpenStack Platform (RHOSP) on user-provisioned infrastructure.

### 18.12.1. Downloading playbook dependencies

The Ansible playbooks that simplify the removal process on user-provisioned infrastructure require several Python modules. On the machine where you will run the process, add the modules' repositories and then download them.



## NOTE

These instructions assume that you are using Red Hat Enterprise Linux (RHEL) 8.

### Prerequisites

- Python 3 is installed on your machine.

### Procedure

- On a command line, add the repositories:

- Register with Red Hat Subscription Manager:

```
$ sudo subscription-manager register # If not done already
```

- Pull the latest subscription data:

```
$ sudo subscription-manager attach --pool=$YOUR_POOLID # If not done already
```

- Disable the current repositories:

```
$ sudo subscription-manager repos --disable=* # If not done already
```

- Add the required repositories:

```
$ sudo subscription-manager repos \
--enable=rhel-8-for-x86_64-baseos-rpms \
```

```
--enable=openstack-16-tools-for-rhel-8-x86_64-rpms \
--enable=ansible-2.9-for-rhel-8-x86_64-rpms \
--enable=rhel-8-for-x86_64-appstream-rpms
```

2. Install the modules:

```
$ sudo yum install python3-openstackclient ansible python3-openstacksdk
```

3. Ensure that the **python** command points to **python3**:

```
$ sudo alternatives --set python /usr/bin/python3
```

### 18.12.2. Removing a cluster from RHOSP that uses your own infrastructure

You can remove an OpenShift Container Platform cluster on Red Hat OpenStack Platform (RHOSP) that uses your own infrastructure. To complete the removal process quickly, run several Ansible playbooks.

#### Prerequisites

- Python 3 is installed on your machine.
- You downloaded the modules in "Downloading playbook dependencies."
- You have the playbooks that you used to install the cluster.
- You modified the playbooks that are prefixed with **down-** to reflect any changes that you made to their corresponding installation playbooks. For example, changes to the **bootstrap.yaml** file are reflected in the **down-bootstrap.yaml** file.
- All of the playbooks are in a common directory.

#### Procedure

1. On a command line, run the playbooks that you downloaded:

```
$ ansible-playbook -i inventory.yaml \
  down-bootstrap.yaml \
  down-control-plane.yaml \
  down-compute-nodes.yaml \
  down-load-balancers.yaml \
  down-network.yaml \
  down-security-groups
```

2. Remove any DNS record changes you made for the OpenShift Container Platform installation.

OpenShift Container Platform is removed from your infrastructure.

## CHAPTER 19. INSTALLING ON RHV

### 19.1. PREPARING TO INSTALL ON RED HAT VIRTUALIZATION (RHV)

#### 19.1.1. Prerequisites

- You reviewed details about the [OpenShift Container Platform installation and update](#) processes.
- You have a supported combination of versions in the [Support Matrix for OpenShift Container Platform on Red Hat Virtualization \(RHV\)](#).
- You read the documentation on [selecting a cluster installation method and preparing it for users](#).

#### 19.1.2. Choosing a method to install OpenShift Container Platform on RHV

You can install OpenShift Container Platform on installer-provisioned or user-provisioned infrastructure. The default installation type uses installer-provisioned infrastructure, where the installation program provisions the underlying infrastructure for the cluster. You can also install OpenShift Container Platform on infrastructure that you provision. If you do not use infrastructure that the installation program provisions, you must manage and maintain the cluster resources yourself.

See [Installation process](#) for more information about installer-provisioned and user-provisioned installation processes.

##### 19.1.2.1. Installing a cluster on installer-provisioned infrastructure

You can install a cluster on Red Hat Virtualization (RHV) virtual machines that are provisioned by the OpenShift Container Platform installation program, by using one of the following methods:

- **Installing a cluster quickly on RHV** You can quickly install OpenShift Container Platform on RHV virtual machines that the OpenShift Container Platform installation program provisions.
- **Installing a cluster on RHV with customizations** You can install a customized OpenShift Container Platform cluster on installer-provisioned guests on RHV. The installation program allows for some customization to be applied at the installation stage. Many other customization options are available [post-installation](#).

##### 19.1.2.2. Installing a cluster on user-provisioned infrastructure

You can install a cluster on RHV virtual machines that you provision, by using one of the following methods:

- **Installing a cluster on RHV with user-provisioned infrastructure** You can install OpenShift Container Platform on RHV virtual machines that you provision. You can use the provided Ansible playbooks to assist with the installation.
- **Installing a cluster on RHV in a restricted network** You can install OpenShift Container Platform on RHV in a restricted or disconnected network by creating an internal mirror of the installation release content. You can use this method to install a user-provisioned cluster that does not require an active internet connection to obtain the software components. You can also use this installation method to ensure that your clusters only use container images that satisfy your organizational controls on external content.

## 19.2. INSTALLING A CLUSTER QUICKLY ON RHV

You can quickly install a default, non-customized, OpenShift Container Platform cluster on a Red Hat Virtualization (RHV) cluster, similar to the one shown in the following diagram.

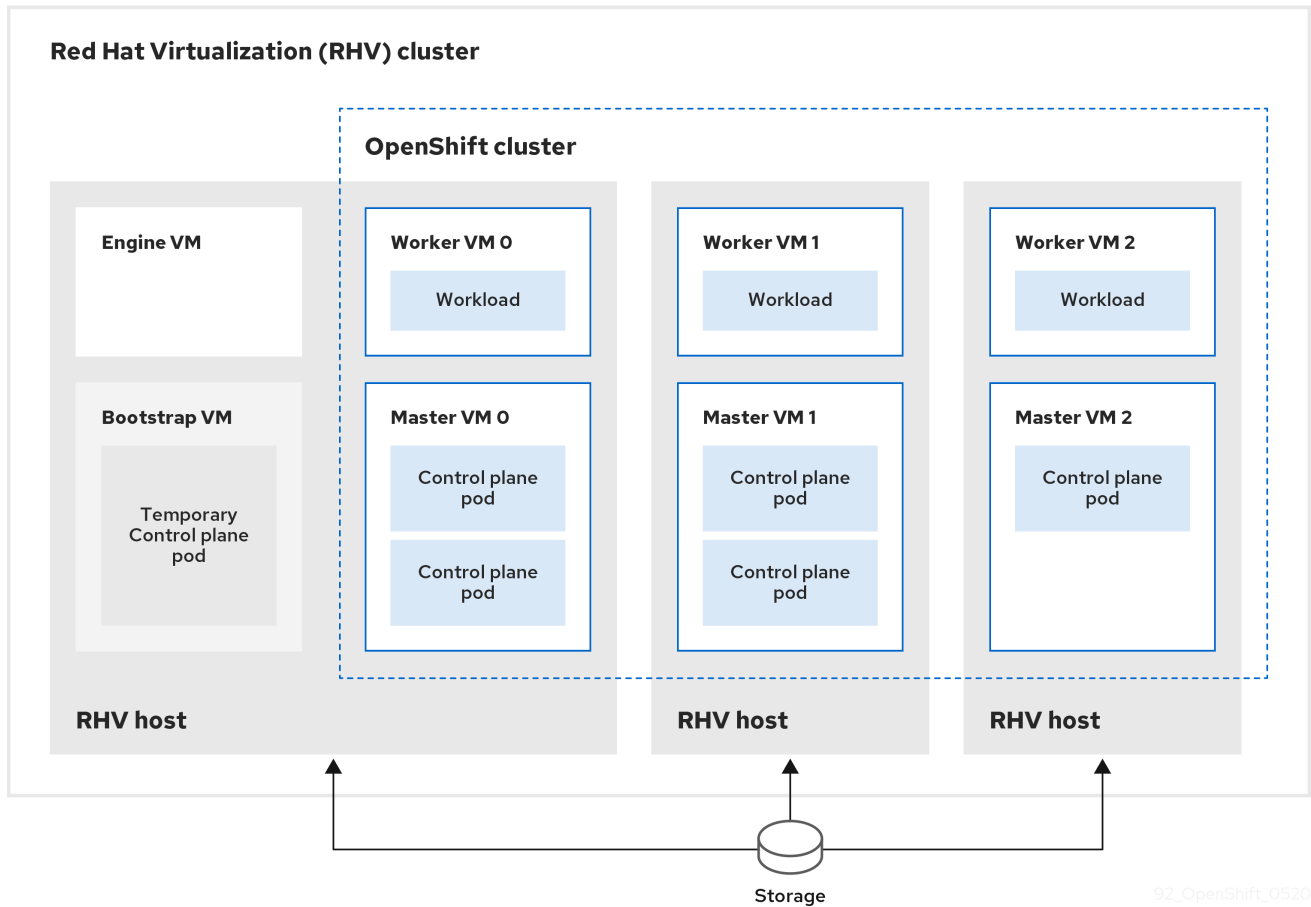

92\_OpenShift\_0520

The installation program uses installer-provisioned infrastructure to automate creating and deploying the cluster.

To install a default cluster, you prepare the environment, run the installation program and answer its prompts. Then, the installation program creates the OpenShift Container Platform cluster.

For an alternative to installing a default cluster, see [Installing a cluster with customizations](#).



### NOTE

This installation program is available for Linux and macOS only.

### 19.2.1. Prerequisites

- You reviewed details about the [OpenShift Container Platform installation and update](#) processes.
- You have a supported combination of versions in the [Support Matrix for OpenShift Container Platform on Red Hat Virtualization \(RHV\)](#).
- You read the documentation on [selecting a cluster installation method and preparing it for users](#).

- If you use a firewall, you [configured it to allow the sites](#) that your cluster requires access to.

## 19.2.2. Internet access for OpenShift Container Platform

In OpenShift Container Platform 4.10, you require access to the internet to install your cluster.

You must have internet access to:

- Access [OpenShift Cluster Manager](#) to download the installation program and perform subscription management. If the cluster has internet access and you do not disable Telemetry, that service automatically entitles your cluster.
- Access [Quay.io](#) to obtain the packages that are required to install your cluster.
- Obtain the packages that are required to perform cluster updates.

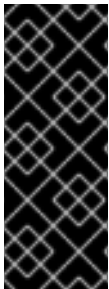

### IMPORTANT

If your cluster cannot have direct internet access, you can perform a restricted network installation on some types of infrastructure that you provision. During that process, you download the required content and use it to populate a mirror registry with the installation packages. With some installation types, the environment that you install your cluster in will not require internet access. Before you update the cluster, you update the content of the mirror registry.

## 19.2.3. Requirements for the RHV environment

To install and run an OpenShift Container Platform version 4.10 cluster, the RHV environment must meet the following requirements.

Not meeting these requirements can cause the installation or process to fail. Additionally, not meeting these requirements can cause the OpenShift Container Platform cluster to fail days or weeks after installation.

The following requirements for CPU, memory, and storage resources are based on **default** values multiplied by the default number of virtual machines the installation program creates. These resources must be available **in addition to** what the RHV environment uses for non-OpenShift Container Platform operations.

By default, the installation program creates seven virtual machines during the installation process. First, it creates a bootstrap virtual machine to provide temporary services and a control plane while it creates the rest of the OpenShift Container Platform cluster. When the installation program finishes creating the cluster, deleting the bootstrap machine frees up its resources.

If you increase the number of virtual machines in the RHV environment, you must increase the resources accordingly.

### Requirements

- The RHV version is 4.4.
- The RHV environment has one data center whose state is **Up**.
- The RHV data center contains an RHV cluster.



- The RHV cluster has the following resources exclusively for the OpenShift Container Platform cluster:
  - Minimum 28 vCPUs: four for each of the seven virtual machines created during installation.
  - 112 GiB RAM or more, including:
    - 16 GiB or more for the bootstrap machine, which provides the temporary control plane.
    - 16 GiB or more for each of the three control plane machines which provide the control plane.
    - 16 GiB or more for each of the three compute machines, which run the application workloads.
- The RHV storage domain must meet [these etcd backend performance requirements](#).
- For affinity group support: Three or more hosts in the RHV cluster. If necessary, you can disable affinity groups. For details, see *Example: Removing all affinity groups for a non-production lab setup* in *Installing a cluster on RHV with customizations*
- In production environments, each virtual machine must have 120 GiB or more. Therefore, the storage domain must provide 840 GiB or more for the default OpenShift Container Platform cluster. In resource-constrained or non-production environments, each virtual machine must have 32 GiB or more, so the storage domain must have 230 GiB or more for the default OpenShift Container Platform cluster.
- To download images from the Red Hat Ecosystem Catalog during installation and update procedures, the RHV cluster must have access to an internet connection. The Telemetry service also needs an internet connection to simplify the subscription and entitlement process.
- The RHV cluster must have a virtual network with access to the REST API on the RHV Manager. Ensure that DHCP is enabled on this network, because the VMs that the installer creates obtain their IP address by using DHCP.
- A user account and group with the following least privileges for installing and managing an OpenShift Container Platform cluster on the target RHV cluster:
  - **DiskOperator**
  - **DiskCreator**
  - **UserTemplateBasedVm**
  - **TemplateOwner**
  - **TemplateCreator**
  - **ClusterAdmin** on the target cluster

**WARNING**

Apply the principle of least privilege: Avoid using an administrator account with **SuperUser** privileges on RHV during the installation process. The installation program saves the credentials you provide to a temporary **ovirt-config.yaml** file that might be compromised.

**Additional resources**

- [Example: Removing all affinity groups for a non-production lab setup](#) .

**19.2.4. Verifying the requirements for the RHV environment**

Verify that the RHV environment meets the requirements to install and run an OpenShift Container Platform cluster. Not meeting these requirements can cause failures.

**IMPORTANT**

These requirements are based on the default resources the installation program uses to create control plane and compute machines. These resources include vCPUs, memory, and storage. If you change these resources or increase the number of OpenShift Container Platform machines, adjust these requirements accordingly.

**Procedure**

1. Check that the RHV version supports installation of OpenShift Container Platform version 4.10.
  - a. In the RHV Administration Portal, click the ? help icon in the upper-right corner and select **About**.
  - b. In the window that opens, make a note of the **RHV Software Version**
  - c. Confirm that the RHV version is 4.4. For more information about supported version combinations, see [Support Matrix for OpenShift Container Platform on RHV](#) .
2. Inspect the data center, cluster, and storage.
  - a. In the RHV Administration Portal, click **Compute → Data Centers**.
  - b. Confirm that the data center where you plan to install OpenShift Container Platform is accessible.
  - c. Click the name of that data center.
  - d. In the data center details, on the **Storage** tab, confirm the storage domain where you plan to install OpenShift Container Platform is **Active**.
  - e. Record the **Domain Name** for use later on.
  - f. Confirm **Free Space** has at least 230 GiB.

- g. Confirm that the storage domain meets [these etcd backend performance requirements](#), which you [can measure by using the fio performance benchmarking tool](#).
  - h. In the data center details, click the **Clusters** tab.
  - i. Find the RHV cluster where you plan to install OpenShift Container Platform. Record the cluster name for use later on.
3. Inspect the RHV host resources.
    - a. In the RHV Administration Portal, click **Compute > Clusters**.
    - b. Click the cluster where you plan to install OpenShift Container Platform.
    - c. In the cluster details, click the **Hosts** tab.
    - d. Inspect the hosts and confirm they have a combined total of at least 28 **Logical CPU Cores** available *exclusively* for the OpenShift Container Platform cluster.
    - e. Record the number of available **Logical CPU Cores** for use later on.
    - f. Confirm that these CPU cores are distributed so that each of the seven virtual machines created during installation can have four cores.
    - g. Confirm that, all together, the hosts have 112 GiB of **Max free Memory for scheduling new virtual machines** distributed to meet the requirements for each of the following OpenShift Container Platform machines:
      - 16 GiB required for the bootstrap machine
      - 16 GiB required for each of the three control plane machines
      - 16 GiB for each of the three compute machines
    - h. Record the amount of **Max free Memory for scheduling new virtual machines** for use later on.
  4. Verify that the virtual network for installing OpenShift Container Platform has access to the RHV Manager's REST API. From a virtual machine on this network, use curl to reach the RHV Manager's REST API:

```
$ curl -k -u <username>@<profile>:<password> \ 1
https://<engine-fqdn>/ovirt-engine/api 2
```

- 1 For **<username>**, specify the user name of an RHV account with privileges to create and manage an OpenShift Container Platform cluster on RHV. For **<profile>**, specify the login profile, which you can get by going to the RHV Administration Portal login page and reviewing the **Profile** dropdown list. For **<password>**, specify the password for that user name.

- 2 For **<engine-fqdn>**, specify the fully qualified domain name of the RHV environment.

For example:

```
$ curl -k -u ocpadmin@internal:pw123 \
https://rhv-env.virtlab.example.com/ovirt-engine/api
```

## 19.2.5. Preparing the network environment on RHV

Configure two static IP addresses for the OpenShift Container Platform cluster and create DNS entries using these addresses.

### Procedure

1. Reserve two static IP addresses
  - a. On the network where you plan to install OpenShift Container Platform, identify two static IP addresses that are outside the DHCP lease pool.
  - b. Connect to a host on this network and verify that each of the IP addresses is not in use. For example, use Address Resolution Protocol (ARP) to check that none of the IP addresses have entries:

```
$ arp 10.35.1.19
```

### Example output

```
10.35.1.19 (10.35.1.19) -- no entry
```

- c. Reserve two static IP addresses following the standard practices for your network environment.
  - d. Record these IP addresses for future reference.
2. Create DNS entries for the OpenShift Container Platform REST API and apps domain names using this format:

```
api.<cluster-name>.<base-domain> <ip-address> 1
*.apps.<cluster-name>.<base-domain> <ip-address> 2
```

- 1 For **<cluster-name>**, **<base-domain>**, and **<ip-address>**, specify the cluster name, base domain, and static IP address of your OpenShift Container Platform API.
- 2 Specify the cluster name, base domain, and static IP address of your OpenShift Container Platform apps for Ingress and the load balancer.

For example:

```
api.my-cluster.virtlab.example.com 10.35.1.19
*.apps.my-cluster.virtlab.example.com 10.35.1.20
```

## 19.2.6. Installing OpenShift Container Platform on RHV in insecure mode

By default, the installer creates a CA certificate, prompts you for confirmation, and stores the certificate to use during installation. You do not need to create or install one manually.

Although it is not recommended, you can override this functionality and install OpenShift Container Platform without verifying a certificate by installing OpenShift Container Platform on RHV in **insecure** mode.



## WARNING

Installing in **insecure** mode is not recommended, because it enables a potential attacker to perform a Man-in-the-Middle attack and capture sensitive credentials on the network.

### Procedure

1. Create a file named `~/.ovirt/ovirt-config.yaml`.
2. Add the following content to **ovirt-config.yaml**:

```
ovirt_url: https://ovirt.example.com/ovirt-engine/api 1
ovirt_fqdn: ovirt.example.com 2
ovirt_pem_url: ""
ovirt_username: ocpadmin@internal
ovirt_password: super-secret-password 3
ovirt_insecure: true
```

- 1 Specify the hostname or address of your oVirt engine.
- 2 Specify the fully qualified domain name of your oVirt engine.
- 3 Specify the admin password for your oVirt engine.

3. Run the installer.

### 19.2.7. Generating a key pair for cluster node SSH access

During an OpenShift Container Platform installation, you can provide an SSH public key to the installation program. The key is passed to the Red Hat Enterprise Linux CoreOS (RHCOS) nodes through their Ignition config files and is used to authenticate SSH access to the nodes. The key is added to the `~/.ssh/authorized_keys` list for the **core** user on each node, which enables password-less authentication.

After the key is passed to the nodes, you can use the key pair to SSH in to the RHCOS nodes as the user **core**. To access the nodes through SSH, the private key identity must be managed by SSH for your local user.

If you want to SSH in to your cluster nodes to perform installation debugging or disaster recovery, you must provide the SSH public key during the installation process. The `./openshift-install gather` command also requires the SSH public key to be in place on the cluster nodes.

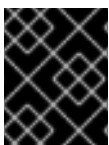

## IMPORTANT

Do not skip this procedure in production environments, where disaster recovery and debugging is required.

### Procedure

1. If you do not have an existing SSH key pair on your local machine to use for authentication onto your cluster nodes, create one. For example, on a computer that uses a Linux operating system, run the following command:

```
$ ssh-keygen -t ed25519 -N "" -f <path>/<file_name> 1
```

- 1 Specify the path and file name, such as `~/.ssh/id_ed25519`, of the new SSH key. If you have an existing key pair, ensure your public key is in the your `~/.ssh` directory.

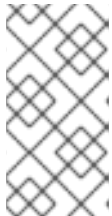

#### NOTE

If you plan to install an OpenShift Container Platform cluster that uses FIPS validated or Modules In Process cryptographic libraries on the **x86\_64** architecture, do not create a key that uses the **ed25519** algorithm. Instead, create a key that uses the **rsa** or **ecdsa** algorithm.

2. View the public SSH key:

```
$ cat <path>/<file_name>.pub
```

For example, run the following to view the `~/.ssh/id_ed25519.pub` public key:

```
$ cat ~/.ssh/id_ed25519.pub
```

3. Add the SSH private key identity to the SSH agent for your local user, if it has not already been added. SSH agent management of the key is required for password-less SSH authentication onto your cluster nodes, or if you want to use the `./openshift-install gather` command.



#### NOTE

On some distributions, default SSH private key identities such as `~/.ssh/id_rsa` and `~/.ssh/id_dsa` are managed automatically.

- a. If the **ssh-agent** process is not already running for your local user, start it as a background task:

```
$ eval "$(ssh-agent -s)"
```

#### Example output

```
Agent pid 31874
```



#### NOTE

If your cluster is in FIPS mode, only use FIPS-compliant algorithms to generate the SSH key. The key must be either RSA or ECDSA.

4. Add your SSH private key to the **ssh-agent**:

```
$ ssh-add <path>/<file_name> 1
```

- 1 Specify the path and file name for your SSH private key, such as `~/.ssh/id_ed25519`

### Example output

```
Identity added: /home/<you>/<path>/<file_name> (<computer_name>)
```

### Next steps

- When you install OpenShift Container Platform, provide the SSH public key to the installation program.

## 19.2.8. Obtaining the installation program

Before you install OpenShift Container Platform, download the installation file on a local computer.

### Prerequisites

- You have a computer that runs Linux or macOS, with 500 MB of local disk space

### Procedure

1. Access the [Infrastructure Provider](#) page on the OpenShift Cluster Manager site. If you have a Red Hat account, log in with your credentials. If you do not, create an account.
2. Select your infrastructure provider.
3. Navigate to the page for your installation type, download the installation program that corresponds with your host operating system and architecture, and place the file in the directory where you will store the installation configuration files.

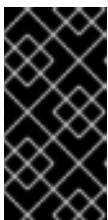

#### IMPORTANT

The installation program creates several files on the computer that you use to install your cluster. You must keep the installation program and the files that the installation program creates after you finish installing the cluster. Both files are required to delete the cluster.

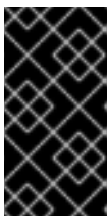

#### IMPORTANT

Deleting the files created by the installation program does not remove your cluster, even if the cluster failed during installation. To remove your cluster, complete the OpenShift Container Platform uninstallation procedures for your specific cloud provider.

4. Extract the installation program. For example, on a computer that uses a Linux operating system, run the following command:

```
$ tar -xvf openshift-install-linux.tar.gz
```

5. Download your installation [pull secret from the Red Hat OpenShift Cluster Manager](#). This pull secret allows you to authenticate with the services that are provided by the included authorities, including Quay.io, which serves the container images for OpenShift Container Platform

components.

## 19.2.9. Deploying the cluster

You can install OpenShift Container Platform on a compatible cloud platform.



### IMPORTANT

You can run the **create cluster** command of the installation program only once, during initial installation.

### Prerequisites

- Open the **ovirt-imageio** port to the Manager from the machine running the installer. By default, the port is **54322**.
- Obtain the OpenShift Container Platform installation program and the pull secret for your cluster.

### Procedure

1. Change to the directory that contains the installation program and initialize the cluster deployment:

```
$ ./openshift-install create cluster --dir <installation_directory> \ 1
--log-level=info 2
```

- 1 For **<installation\_directory>**, specify the directory name to store the files that the installation program creates.
- 2 To view different installation details, specify **warn**, **debug**, or **error** instead of **info**.



### IMPORTANT

Specify an empty directory. Some installation assets, like bootstrap X.509 certificates have short expiration intervals, so you must not reuse an installation directory. If you want to reuse individual files from another cluster installation, you can copy them into your directory. However, the file names for the installation assets might change between releases. Use caution when copying installation files from an earlier OpenShift Container Platform version.

Respond to the installation program prompts.

- a. Optional: For **SSH Public Key**, select a password-less public key, such as `~/.ssh/id_rsa.pub`. This key authenticates connections with the new OpenShift Container Platform cluster.



### NOTE

For production OpenShift Container Platform clusters on which you want to perform installation debugging or disaster recovery, select an SSH key that your **ssh-agent** process uses.



- b. For **Platform**, select **ovirt**.
- c. For **Engine FQDN[:PORT]**, enter the fully qualified domain name (FQDN) of the RHV environment.  
For example:

```
rhv-env.virtlab.example.com:443
```

- d. The installer automatically generates a CA certificate. For **Would you like to use the above certificate to connect to the Manager?**, answer **y** or **N**. If you answer **N**, you must install OpenShift Container Platform in insecure mode.
- e. For **Engine username**, enter the user name and profile of the RHV administrator using this format:

```
<username>@<profile> 1
```

- 1 For **<username>**, specify the user name of an RHV administrator. For **<profile>**, specify the login profile, which you can get by going to the RHV Administration Portal login page and reviewing the **Profile** dropdown list. For example: **admin@internal**.

- f. For **Engine password**, enter the RHV admin password.
- g. For **Cluster**, select the RHV cluster for installing OpenShift Container Platform.
- h. For **Storage domain**, select the storage domain for installing OpenShift Container Platform.
- i. For **Network**, select a virtual network that has access to the RHV Manager REST API.
- j. For **Internal API Virtual IP**, enter the static IP address you set aside for the cluster's REST API.
- k. For **Ingress virtual IP**, enter the static IP address you reserved for the wildcard apps domain.
- l. For **Base Domain**, enter the base domain of the OpenShift Container Platform cluster. If this cluster is exposed to the outside world, this must be a valid domain recognized by DNS infrastructure. For example, enter: **virtlab.example.com**
- m. For **Cluster Name**, enter the name of the cluster. For example, **my-cluster**. Use cluster name from the externally registered/resolvable DNS entries you created for the OpenShift Container Platform REST API and apps domain names. The installation program also gives this name to the cluster in the RHV environment.
- n. For **Pull Secret**, copy the pull secret from the **pull-secret.txt** file you downloaded earlier and paste it here. You can also get a copy of the same [pull secret from the Red Hat OpenShift Cluster Manager](#).

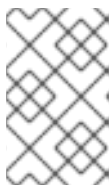

## NOTE

If the cloud provider account that you configured on your host does not have sufficient permissions to deploy the cluster, the installation process stops, and the missing permissions are displayed.

When the cluster deployment completes, directions for accessing your cluster, including a link to its web console and credentials for the **kubeadmin** user, display in your terminal.

### Example output

```
...
INFO Install complete!
INFO To access the cluster as the system:admin user when using 'oc', run 'export
KUBECONFIG=/home/myuser/install_dir/auth/kubeconfig'
INFO Access the OpenShift web-console here: https://console-openshift-
console.apps.mycluster.example.com
INFO Login to the console with user: "kubeadmin", and password: "4vYBz-Ee6gm-ymBZj-
Wt5AL"
INFO Time elapsed: 36m22s
```



### NOTE

The cluster access and credential information also outputs to **<installation\_directory>/openshift\_install.log** when an installation succeeds.



### IMPORTANT

- The Ignition config files that the installation program generates contain certificates that expire after 24 hours, which are then renewed at that time. If the cluster is shut down before renewing the certificates and the cluster is later restarted after the 24 hours have elapsed, the cluster automatically recovers the expired certificates. The exception is that you must manually approve the pending **node-bootstrapper** certificate signing requests (CSRs) to recover kubelet certificates. See the documentation for *Recovering from expired control plane certificates* for more information.
- It is recommended that you use Ignition config files within 12 hours after they are generated because the 24-hour certificate rotates from 16 to 22 hours after the cluster is installed. By using the Ignition config files within 12 hours, you can avoid installation failure if the certificate update runs during installation.



### IMPORTANT

You must not delete the installation program or the files that the installation program creates. Both are required to delete the cluster.



### IMPORTANT

You have completed the steps required to install the cluster. The remaining steps show you how to verify the cluster and troubleshoot the installation.

## 19.2.10. Installing the OpenShift CLI by downloading the binary

You can install the OpenShift CLI (**oc**) to interact with OpenShift Container Platform from a command-line interface. You can install **oc** on Linux, Windows, or macOS.

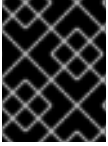

## IMPORTANT

If you installed an earlier version of **oc**, you cannot use it to complete all of the commands in OpenShift Container Platform 4.10. Download and install the new version of **oc**.

### Installing the OpenShift CLI on Linux

You can install the OpenShift CLI (**oc**) binary on Linux by using the following procedure.

#### Procedure

1. Navigate to the [OpenShift Container Platform downloads page](#) on the Red Hat Customer Portal.
2. Select the appropriate version in the **Version** drop-down menu.
3. Click **Download Now** next to the **OpenShift v4.10 Linux Client** entry and save the file.
4. Unpack the archive:

```
$ tar xvf <file>
```

5. Place the **oc** binary in a directory that is on your **PATH**.  
To check your **PATH**, execute the following command:

```
$ echo $PATH
```

After you install the OpenShift CLI, it is available using the **oc** command:

```
$ oc <command>
```

### Installing the OpenShift CLI on Windows

You can install the OpenShift CLI (**oc**) binary on Windows by using the following procedure.

#### Procedure

1. Navigate to the [OpenShift Container Platform downloads page](#) on the Red Hat Customer Portal.
2. Select the appropriate version in the **Version** drop-down menu.
3. Click **Download Now** next to the **OpenShift v4.10 Windows Client** entry and save the file.
4. Unzip the archive with a ZIP program.
5. Move the **oc** binary to a directory that is on your **PATH**.  
To check your **PATH**, open the command prompt and execute the following command:

```
C:\> path
```

After you install the OpenShift CLI, it is available using the **oc** command:

```
C:\> oc <command>
```

## Installing the OpenShift CLI on macOS

You can install the OpenShift CLI (**oc**) binary on macOS by using the following procedure.

### Procedure

1. Navigate to the [OpenShift Container Platform downloads page](#) on the Red Hat Customer Portal.
2. Select the appropriate version in the **Version** drop-down menu.
3. Click **Download Now** next to the **OpenShift v4.10 MacOSX Client** entry and save the file.
4. Unpack and unzip the archive.
5. Move the **oc** binary to a directory on your PATH.

To check your **PATH**, open a terminal and execute the following command:

```
$ echo $PATH
```

After you install the OpenShift CLI, it is available using the **oc** command:

```
$ oc <command>
```

To learn more, see [Getting started with the OpenShift CLI](#).

## 19.2.11. Logging in to the cluster by using the CLI

You can log in to your cluster as a default system user by exporting the cluster **kubeconfig** file. The **kubeconfig** file contains information about the cluster that is used by the CLI to connect a client to the correct cluster and API server. The file is specific to a cluster and is created during OpenShift Container Platform installation.

### Prerequisites

- You deployed an OpenShift Container Platform cluster.
- You installed the **oc** CLI.

### Procedure

1. Export the **kubeadmin** credentials:

```
$ export KUBECONFIG=<installation_directory>/auth/kubeconfig 1
```

- 1** For **<installation\_directory>**, specify the path to the directory that you stored the installation files in.

2. Verify you can run **oc** commands successfully using the exported configuration:

```
$ oc whoami
```

### Example output

```
■
```

```
system:admin
```

### Additional resources

- See [Accessing the web console](#) for more details about accessing and understanding the OpenShift Container Platform web console.

## 19.2.12. Verifying cluster status

You can verify your OpenShift Container Platform cluster's status during or after installation.

### Procedure

1. In the cluster environment, export the administrator's kubeconfig file:

```
$ export KUBECONFIG=<installation_directory>/auth/kubeconfig 1
```

- 1** For **<installation\_directory>**, specify the path to the directory that you stored the installation files in.

The **kubeconfig** file contains information about the cluster that is used by the CLI to connect a client to the correct cluster and API server.

2. View the control plane and compute machines created after a deployment:

```
$ oc get nodes
```

3. View your cluster's version:

```
$ oc get clusterversion
```

4. View your Operators' status:

```
$ oc get clusteroperator
```

5. View all running pods in the cluster:

```
$ oc get pods -A
```

### Troubleshooting

If the installation fails, the installation program times out and displays an error message. To learn more, see [Troubleshooting installation issues](#).

## 19.2.13. Accessing the OpenShift Container Platform web console on RHV

After the OpenShift Container Platform cluster initializes, you can log in to the OpenShift Container Platform web console.

### Procedure

1. Optional: In the Red Hat Virtualization (RHV) Administration Portal, open **Compute → Cluster**.

2. Verify that the installation program creates the virtual machines.
3. Return to the command line where the installation program is running. When the installation program finishes, it displays the user name and temporary password for logging into the OpenShift Container Platform web console.
4. In a browser, open the URL of the OpenShift Container Platform web console. The URL uses this format:

```
console-openshift-console.apps.<clustername>.<basedomain> 1
```

- 1** For **<clustername>.<basedomain>**, specify the cluster name and base domain.

For example:

```
console-openshift-console.apps.my-cluster.virtlab.example.com
```

### 19.2.14. Telemetry access for OpenShift Container Platform

In OpenShift Container Platform 4.10, the Telemetry service, which runs by default to provide metrics about cluster health and the success of updates, requires internet access. If your cluster is connected to the internet, Telemetry runs automatically, and your cluster is registered to [OpenShift Cluster Manager](#).

After you confirm that your [OpenShift Cluster Manager](#) inventory is correct, either maintained automatically by Telemetry or manually by using OpenShift Cluster Manager, [use subscription watch](#) to track your OpenShift Container Platform subscriptions at the account or multi-cluster level.

#### Additional resources

- See [About remote health monitoring](#) for more information about the Telemetry service

### 19.2.15. Troubleshooting common issues with installing on Red Hat Virtualization (RHV)

Here are some common issues you might encounter, along with proposed causes and solutions.

#### 19.2.15.1. CPU load increases and nodes go into a **Not Ready** state

- **Symptom:** CPU load increases significantly and nodes start going into a **Not Ready** state.
- **Cause:** The storage domain latency might be too high, especially for control plane nodes.
- **Solution:**  
Make the nodes ready again by restarting the kubelet service:

```
$ systemctl restart kubelet
```

Inspect the OpenShift Container Platform metrics service, which automatically gathers and reports on some valuable data such as the etcd disk sync duration. If the cluster is operational, use this data to help determine whether storage latency or throughput is the root issue. If so, consider using a storage resource that has lower latency and higher throughput.

To get raw metrics, enter the following command as kubeadmin or user with cluster-admin privileges:

```
$ oc get --insecure-skip-tls-verify --server=https://localhost:<port> --raw=/metrics
```

To learn more, see [Exploring Application Endpoints for the purposes of Debugging with OpenShift 4.x](#)

### 19.2.15.2. Trouble connecting the OpenShift Container Platform cluster API

- **Symptom:** The installation program completes but the OpenShift Container Platform cluster API is not available. The bootstrap virtual machine remains up after the bootstrap process is complete. When you enter the following command, the response will time out.

```
$ oc login -u kubeadmin -p *** <apiurl>
```

- **Cause:** The bootstrap VM was not deleted by the installation program and has not released the cluster's API IP address.
- **Solution:** Use the **wait-for** subcommand to be notified when the bootstrap process is complete:

```
$ ./openshift-install wait-for bootstrap-complete
```

When the bootstrap process is complete, delete the bootstrap virtual machine:

```
$ ./openshift-install destroy bootstrap
```

### 19.2.16. Post-installation tasks

After the OpenShift Container Platform cluster initializes, you can perform the following tasks.

- Optional: After deployment, add or replace SSH keys using the Machine Config Operator (MCO) in OpenShift Container Platform.
- Optional: Remove the **kubeadmin** user. Instead, use the authentication provider to create a user with cluster-admin privileges.

## 19.3. INSTALLING A CLUSTER ON RHV WITH CUSTOMIZATIONS

You can customize and install an OpenShift Container Platform cluster on Red Hat Virtualization (RHV), similar to the one shown in the following diagram.

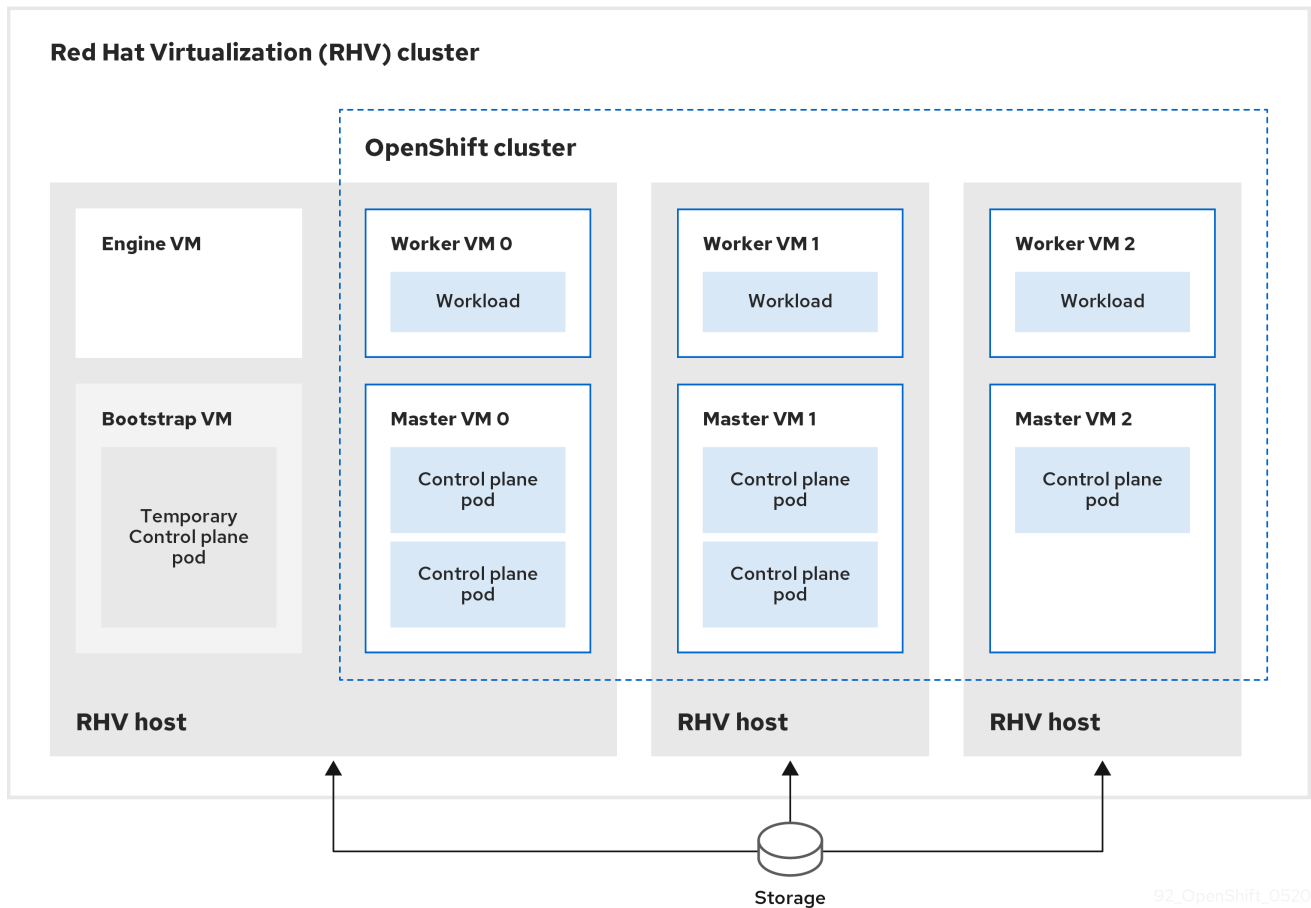

92\_OpenShift\_0520

The installation program uses installer-provisioned infrastructure to automate creating and deploying the cluster.

To install a customized cluster, you prepare the environment and perform the following steps:

1. Create an installation configuration file, the **install-config.yaml** file, by running the installation program and answering its prompts.
2. Inspect and modify parameters in the **install-config.yaml** file.
3. Make a working copy of the **install-config.yaml** file.
4. Run the installation program with a copy of the **install-config.yaml** file.

Then, the installation program creates the OpenShift Container Platform cluster.

For an alternative to installing a customized cluster, see [Installing a default cluster](#).



#### NOTE

This installation program is available for Linux and macOS only.

### 19.3.1. Prerequisites

- You reviewed details about the [OpenShift Container Platform installation and update processes](#).



- You have a supported combination of versions in the [Support Matrix for OpenShift Container Platform on Red Hat Virtualization \(RHV\)](#).
- You read the documentation on [selecting a cluster installation method and preparing it for users](#).
- If you use a firewall, you [configured it to allow the sites](#) that your cluster requires access to.

### 19.3.2. Internet access for OpenShift Container Platform

In OpenShift Container Platform 4.10, you require access to the internet to install your cluster.

You must have internet access to:

- Access [OpenShift Cluster Manager](#) to download the installation program and perform subscription management. If the cluster has internet access and you do not disable Telemetry, that service automatically entitles your cluster.
- Access [Quay.io](#) to obtain the packages that are required to install your cluster.
- Obtain the packages that are required to perform cluster updates.



#### IMPORTANT

If your cluster cannot have direct internet access, you can perform a restricted network installation on some types of infrastructure that you provision. During that process, you download the required content and use it to populate a mirror registry with the installation packages. With some installation types, the environment that you install your cluster in will not require internet access. Before you update the cluster, you update the content of the mirror registry.

### 19.3.3. Requirements for the RHV environment

To install and run an OpenShift Container Platform version 4.10 cluster, the RHV environment must meet the following requirements.

Not meeting these requirements can cause the installation or process to fail. Additionally, not meeting these requirements can cause the OpenShift Container Platform cluster to fail days or weeks after installation.

The following requirements for CPU, memory, and storage resources are based on **default** values multiplied by the default number of virtual machines the installation program creates. These resources must be available **in addition to** what the RHV environment uses for non-OpenShift Container Platform operations.

By default, the installation program creates seven virtual machines during the installation process. First, it creates a bootstrap virtual machine to provide temporary services and a control plane while it creates the rest of the OpenShift Container Platform cluster. When the installation program finishes creating the cluster, deleting the bootstrap machine frees up its resources.

If you increase the number of virtual machines in the RHV environment, you must increase the resources accordingly.

#### Requirements

- The RHV version is 4.4.

- The RHV environment has one data center whose state is **Up**.
- The RHV data center contains an RHV cluster.
- The RHV cluster has the following resources exclusively for the OpenShift Container Platform cluster:
  - Minimum 28 vCPUs: four for each of the seven virtual machines created during installation.
  - 112 GiB RAM or more, including:
    - 16 GiB or more for the bootstrap machine, which provides the temporary control plane.
    - 16 GiB or more for each of the three control plane machines which provide the control plane.
    - 16 GiB or more for each of the three compute machines, which run the application workloads.
- The RHV storage domain must meet [these etcd backend performance requirements](#).
- For affinity group support:

One physical machine per worker or control plane. Workers and control planes can be on the same physical machine. For example, if you have three workers and three control planes, you need three physical machines. If you have four workers and three control planes, you need four physical machines.

  - For hard anti-affinity (default): A minimum of three physical machines. For more than three worker nodes, one physical machine per worker or control plane. Workers and control planes can be on the same physical machine.
  - For custom affinity groups: Ensure that the resources are appropriate for the affinity group rules that you define.
- In production environments, each virtual machine must have 120 GiB or more. Therefore, the storage domain must provide 840 GiB or more for the default OpenShift Container Platform cluster. In resource-constrained or non-production environments, each virtual machine must have 32 GiB or more, so the storage domain must have 230 GiB or more for the default OpenShift Container Platform cluster.
- To download images from the Red Hat Ecosystem Catalog during installation and update procedures, the RHV cluster must have access to an internet connection. The Telemetry service also needs an internet connection to simplify the subscription and entitlement process.
- The RHV cluster must have a virtual network with access to the REST API on the RHV Manager. Ensure that DHCP is enabled on this network, because the VMs that the installer creates obtain their IP address by using DHCP.
- A user account and group with the following least privileges for installing and managing an OpenShift Container Platform cluster on the target RHV cluster:
  - **DiskOperator**
  - **DiskCreator**
  - **UserTemplateBasedVm**
  - **TemplateOwner**

- **TemplateCreator**
- **ClusterAdmin** on the target cluster



### WARNING

Apply the principle of least privilege: Avoid using an administrator account with **SuperUser** privileges on RHV during the installation process. The installation program saves the credentials you provide to a temporary **ovirt-config.yaml** file that might be compromised.

## 19.3.4. Verifying the requirements for the RHV environment

Verify that the RHV environment meets the requirements to install and run an OpenShift Container Platform cluster. Not meeting these requirements can cause failures.



### IMPORTANT

These requirements are based on the default resources the installation program uses to create control plane and compute machines. These resources include vCPUs, memory, and storage. If you change these resources or increase the number of OpenShift Container Platform machines, adjust these requirements accordingly.

### Procedure

1. Check that the RHV version supports installation of OpenShift Container Platform version 4.10.
  - a. In the RHV Administration Portal, click the ? help icon in the upper-right corner and select **About**.
  - b. In the window that opens, make a note of the **RHV Software Version**
  - c. Confirm that the RHV version is 4.4. For more information about supported version combinations, see [Support Matrix for OpenShift Container Platform on RHV](#).
2. Inspect the data center, cluster, and storage.
  - a. In the RHV Administration Portal, click **Compute → Data Centers**.
  - b. Confirm that the data center where you plan to install OpenShift Container Platform is accessible.
  - c. Click the name of that data center.
  - d. In the data center details, on the **Storage** tab, confirm the storage domain where you plan to install OpenShift Container Platform is **Active**.
  - e. Record the **Domain Name** for use later on.
  - f. Confirm **Free Space** has at least 230 GiB.

- g. Confirm that the storage domain meets [these etcd backend performance requirements](#), which you [can measure by using the fio performance benchmarking tool](#).
  - h. In the data center details, click the **Clusters** tab.
  - i. Find the RHV cluster where you plan to install OpenShift Container Platform. Record the cluster name for use later on.
3. Inspect the RHV host resources.
    - a. In the RHV Administration Portal, click **Compute > Clusters**.
    - b. Click the cluster where you plan to install OpenShift Container Platform.
    - c. In the cluster details, click the **Hosts** tab.
    - d. Inspect the hosts and confirm they have a combined total of at least 28 **Logical CPU Cores** available *exclusively* for the OpenShift Container Platform cluster.
    - e. Record the number of available **Logical CPU Cores** for use later on.
    - f. Confirm that these CPU cores are distributed so that each of the seven virtual machines created during installation can have four cores.
    - g. Confirm that, all together, the hosts have 112 GiB of **Max free Memory for scheduling new virtual machines** distributed to meet the requirements for each of the following OpenShift Container Platform machines:
      - 16 GiB required for the bootstrap machine
      - 16 GiB required for each of the three control plane machines
      - 16 GiB for each of the three compute machines
    - h. Record the amount of **Max free Memory for scheduling new virtual machines** for use later on.
  4. Verify that the virtual network for installing OpenShift Container Platform has access to the RHV Manager's REST API. From a virtual machine on this network, use curl to reach the RHV Manager's REST API:

```
$ curl -k -u <username>@<profile>:<password> \ ❶
https://<engine-fqdn>/ovirt-engine/api ❷
```

- ❶ For **<username>**, specify the user name of an RHV account with privileges to create and manage an OpenShift Container Platform cluster on RHV. For **<profile>**, specify the login profile, which you can get by going to the RHV Administration Portal login page and reviewing the **Profile** dropdown list. For **<password>**, specify the password for that user name.

- ❷ For **<engine-fqdn>**, specify the fully qualified domain name of the RHV environment.

For example:

```
$ curl -k -u ocpadmin@internal:pw123 \
https://rhv-env.virtlab.example.com/ovirt-engine/api
```

### 19.3.5. Preparing the network environment on RHV

Configure two static IP addresses for the OpenShift Container Platform cluster and create DNS entries using these addresses.

#### Procedure

1. Reserve two static IP addresses
  - a. On the network where you plan to install OpenShift Container Platform, identify two static IP addresses that are outside the DHCP lease pool.
  - b. Connect to a host on this network and verify that each of the IP addresses is not in use. For example, use Address Resolution Protocol (ARP) to check that none of the IP addresses have entries:

```
$ arp 10.35.1.19
```

#### Example output

```
10.35.1.19 (10.35.1.19) -- no entry
```

- c. Reserve two static IP addresses following the standard practices for your network environment.
  - d. Record these IP addresses for future reference.
2. Create DNS entries for the OpenShift Container Platform REST API and apps domain names using this format:

```
api.<cluster-name>.<base-domain> <ip-address> 1  
*.apps.<cluster-name>.<base-domain> <ip-address> 2
```

- 1 For **<cluster-name>**, **<base-domain>**, and **<ip-address>**, specify the cluster name, base domain, and static IP address of your OpenShift Container Platform API.
- 2 Specify the cluster name, base domain, and static IP address of your OpenShift Container Platform apps for Ingress and the load balancer.

For example:

```
api.my-cluster.virtlab.example.com 10.35.1.19  
*.apps.my-cluster.virtlab.example.com 10.35.1.20
```

### 19.3.6. Installing OpenShift Container Platform on RHV in insecure mode

By default, the installer creates a CA certificate, prompts you for confirmation, and stores the certificate to use during installation. You do not need to create or install one manually.

Although it is not recommended, you can override this functionality and install OpenShift Container Platform without verifying a certificate by installing OpenShift Container Platform on RHV in **insecure** mode.

**WARNING**

Installing in **insecure** mode is not recommended, because it enables a potential attacker to perform a Man-in-the-Middle attack and capture sensitive credentials on the network.

**Procedure**

1. Create a file named `~/.ovirt/ovirt-config.yaml`.
2. Add the following content to **ovirt-config.yaml**:

```
ovirt_url: https://ovirt.example.com/ovirt-engine/api 1
ovirt_fqdn: ovirt.example.com 2
ovirt_pem_url: ""
ovirt_username: ocpadmin@internal
ovirt_password: super-secret-password 3
ovirt_insecure: true
```

- 1 Specify the hostname or address of your oVirt engine.
- 2 Specify the fully qualified domain name of your oVirt engine.
- 3 Specify the admin password for your oVirt engine.

3. Run the installer.

**19.3.7. Generating a key pair for cluster node SSH access**

During an OpenShift Container Platform installation, you can provide an SSH public key to the installation program. The key is passed to the Red Hat Enterprise Linux CoreOS (RHCOS) nodes through their Ignition config files and is used to authenticate SSH access to the nodes. The key is added to the `~/.ssh/authorized_keys` list for the **core** user on each node, which enables password-less authentication.

After the key is passed to the nodes, you can use the key pair to SSH in to the RHCOS nodes as the user **core**. To access the nodes through SSH, the private key identity must be managed by SSH for your local user.

If you want to SSH in to your cluster nodes to perform installation debugging or disaster recovery, you must provide the SSH public key during the installation process. The `./openshift-install gather` command also requires the SSH public key to be in place on the cluster nodes.

**IMPORTANT**

Do not skip this procedure in production environments, where disaster recovery and debugging is required.

**Procedure**

1. If you do not have an existing SSH key pair on your local machine to use for authentication onto your cluster nodes, create one. For example, on a computer that uses a Linux operating system, run the following command:

```
$ ssh-keygen -t ed25519 -N "" -f <path>/<file_name> 1
```

- 1 Specify the path and file name, such as `~/.ssh/id_ed25519`, of the new SSH key. If you have an existing key pair, ensure your public key is in the your `~/.ssh` directory.



#### NOTE

If you plan to install an OpenShift Container Platform cluster that uses FIPS validated or Modules In Process cryptographic libraries on the **x86\_64** architecture, do not create a key that uses the **ed25519** algorithm. Instead, create a key that uses the **rsa** or **ecdsa** algorithm.

2. View the public SSH key:

```
$ cat <path>/<file_name>.pub
```

For example, run the following to view the `~/.ssh/id_ed25519.pub` public key:

```
$ cat ~/.ssh/id_ed25519.pub
```

3. Add the SSH private key identity to the SSH agent for your local user, if it has not already been added. SSH agent management of the key is required for password-less SSH authentication onto your cluster nodes, or if you want to use the `./openshift-install gather` command.

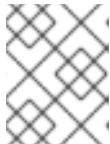

#### NOTE

On some distributions, default SSH private key identities such as `~/.ssh/id_rsa` and `~/.ssh/id_dsa` are managed automatically.

- a. If the **ssh-agent** process is not already running for your local user, start it as a background task:

```
$ eval "$(ssh-agent -s)"
```

#### Example output

```
Agent pid 31874
```



#### NOTE

If your cluster is in FIPS mode, only use FIPS-compliant algorithms to generate the SSH key. The key must be either RSA or ECDSA.

4. Add your SSH private key to the **ssh-agent**:

```
$ ssh-add <path>/<file_name> 1
```

- 1 Specify the path and file name for your SSH private key, such as `~/.ssh/id_ed25519`

### Example output

```
Identity added: /home/<you>/<path>/<file_name> (<computer_name>)
```

### Next steps

- When you install OpenShift Container Platform, provide the SSH public key to the installation program.

## 19.3.8. Obtaining the installation program

Before you install OpenShift Container Platform, download the installation file on a local computer.

### Prerequisites

- You have a computer that runs Linux or macOS, with 500 MB of local disk space

### Procedure

1. Access the [Infrastructure Provider](#) page on the OpenShift Cluster Manager site. If you have a Red Hat account, log in with your credentials. If you do not, create an account.
2. Select your infrastructure provider.
3. Navigate to the page for your installation type, download the installation program that corresponds with your host operating system and architecture, and place the file in the directory where you will store the installation configuration files.

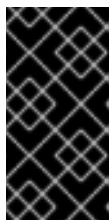

#### IMPORTANT

The installation program creates several files on the computer that you use to install your cluster. You must keep the installation program and the files that the installation program creates after you finish installing the cluster. Both files are required to delete the cluster.

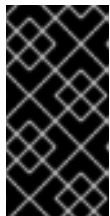

#### IMPORTANT

Deleting the files created by the installation program does not remove your cluster, even if the cluster failed during installation. To remove your cluster, complete the OpenShift Container Platform uninstallation procedures for your specific cloud provider.

4. Extract the installation program. For example, on a computer that uses a Linux operating system, run the following command:

```
$ tar -xvf openshift-install-linux.tar.gz
```

5. Download your installation [pull secret from the Red Hat OpenShift Cluster Manager](#). This pull secret allows you to authenticate with the services that are provided by the included authorities, including Quay.io, which serves the container images for OpenShift Container Platform



components.

### 19.3.9. Creating the installation configuration file

You can customize the OpenShift Container Platform cluster you install on Red Hat Virtualization (RHV).

#### Prerequisites

- Obtain the OpenShift Container Platform installation program and the pull secret for your cluster.
- Obtain service principal permissions at the subscription level.

#### Procedure

1. Create the **install-config.yaml** file.
  - a. Change to the directory that contains the installation program and run the following command:

```
$ ./openshift-install create install-config --dir <installation_directory> 1
```

- 1** For **<installation\_directory>**, specify the directory name to store the files that the installation program creates.



#### IMPORTANT

Specify an empty directory. Some installation assets, like bootstrap X.509 certificates have short expiration intervals, so you must not reuse an installation directory. If you want to reuse individual files from another cluster installation, you can copy them into your directory. However, the file names for the installation assets might change between releases. Use caution when copying installation files from an earlier OpenShift Container Platform version.

- b. Respond to the installation program prompts.
  - i. For **SSH Public Key**, select a password-less public key, such as `~/.ssh/id_rsa.pub`. This key authenticates connections with the new OpenShift Container Platform cluster.



#### NOTE

For production OpenShift Container Platform clusters on which you want to perform installation debugging or disaster recovery, select an SSH key that your **ssh-agent** process uses.

- ii. For **Platform**, select **ovirt**.
- iii. For **Enter oVirt's API endpoint URL**, enter the URL of the RHV API using this format:

```
https://<engine-fqdn>/ovirt-engine/api 1
```

- 1 For **<engine-fqdn>**, specify the fully qualified domain name of the RHV environment.

For example:

```
$ curl -k -u ocpadmin@internal:pw123 \
https://rhv-env.virtlab.example.com/ovirt-engine/api
```

- iv. For **Is the oVirt CA trusted locally?**, enter **Yes**, because you have already set up a CA certificate. Otherwise, enter **No**.
- v. For **oVirt's CA bundle**, if you entered **Yes** for the preceding question, copy the certificate content from **/etc/pki/ca-trust/source/anchors/ca.pem** and paste it here. Then, press **Enter** twice. Otherwise, if you entered **No** for the preceding question, this question does not appear.
- vi. For **oVirt engine username**, enter the user name and profile of the RHV administrator using this format:

```
<username>@<profile> 1
```

- 1 For **<username>**, specify the user name of an RHV administrator. For **<profile>**, specify the login profile, which you can get by going to the RHV Administration Portal login page and reviewing the **Profile** dropdown list. Together, the user name and profile should look similar to this example:

```
ocpadmin@internal
```

- vii. For **oVirt engine password**, enter the RHV admin password.
- viii. For **oVirt cluster**, select the cluster for installing OpenShift Container Platform.
- ix. For **oVirt storage domain**, select the storage domain for installing OpenShift Container Platform.
- x. For **oVirt network**, select a virtual network that has access to the RHV Manager REST API.
- xi. For **Internal API Virtual IP**, enter the static IP address you set aside for the cluster's REST API.
- xii. For **Ingress virtual IP**, enter the static IP address you reserved for the wildcard apps domain.
- xiii. For **Base Domain**, enter the base domain of the OpenShift Container Platform cluster. If this cluster is exposed to the outside world, this must be a valid domain recognized by DNS infrastructure. For example, enter: **virtlab.example.com**
- xiv. For **Cluster Name**, enter the name of the cluster. For example, **my-cluster**. Use cluster name from the externally registered/resolvable DNS entries you created for the OpenShift Container Platform REST API and apps domain names. The installation program also gives this name to the cluster in the RHV environment.

- xv. For **Pull Secret**, copy the pull secret from the **pull-secret.txt** file you downloaded earlier and paste it here. You can also get a copy of the same [pull secret from the Red Hat OpenShift Cluster Manager](#).
2. Modify the **install-config.yaml** file. You can find more information about the available parameters in the "Installation configuration parameters" section.



## NOTE

If you have any intermediate CA certificates on the Manager, verify that the certificates appear in the **ovirt-config.yaml** file and the **install-config.yaml** file. If they do not appear, add them as follows:

1. In the `~/ovirt/ovirt-config.yaml` file:

```
[ovirt_ca_bundle]: |
  -----BEGIN CERTIFICATE-----
  <MY_TRUSTED_CA>
  -----END CERTIFICATE-----
  -----BEGIN CERTIFICATE-----
  <INTERMEDIATE_CA>
  -----END CERTIFICATE-----
```

2. In the **install-config.yaml** file:

```
[additionalTrustBundle]: |
  -----BEGIN CERTIFICATE-----
  <MY_TRUSTED_CA>
  -----END CERTIFICATE-----
  -----BEGIN CERTIFICATE-----
  <INTERMEDIATE_CA>
  -----END CERTIFICATE-----
```

3. Back up the **install-config.yaml** file so that you can use it to install multiple clusters.

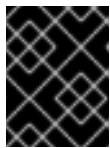

## IMPORTANT

The **install-config.yaml** file is consumed during the installation process. If you want to reuse the file, you must back it up now.

### 19.3.9.1. Example **install-config.yaml** files for Red Hat Virtualization (RHV)

You can customize the OpenShift Container Platform cluster the installation program creates by changing the parameters and parameter values in the **install-config.yaml** file.

The following examples are specific to installing OpenShift Container Platform on RHV.

**install-config.yaml** is located in `<installation_directory>`, which you specified when you ran the following command.

```
$ ./openshift-install create install-config --dir <installation_directory>
```

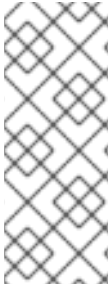
**NOTE**

- These example files are provided for reference only. You must obtain your **install-config.yaml** file by using the installation program.
- Changing the **install-config.yaml** file can increase the resources your cluster requires. Verify that your RHV environment has those additional resources. Otherwise, the installation or cluster will fail.

**Example default install-config.yaml file**

```

apiVersion: v1
baseDomain: example.com
compute:
- architecture: amd64
  hyperthreading: Enabled
  name: worker
  platform: {}
  replicas: 3
controlPlane:
  architecture: amd64
  hyperthreading: Enabled
  name: master
  platform: {}
  replicas: 3
metadata:
  creationTimestamp: null
  name: my-cluster
networking:
  clusterNetwork:
  - cidr: 10.128.0.0/14
    hostPrefix: 23
  machineNetwork:
  - cidr: 10.0.0.0/16
  networkType: OpenShiftSDN
  serviceNetwork:
  - 172.30.0.0/16
platform:
  ovirt:
    api_vip: 10.46.8.230
    ingress_vip: 192.168.1.5
    ovirt_cluster_id: 68833f9f-e89c-4891-b768-e2ba0815b76b
    ovirt_storage_domain_id: ed7b0f4e-0e96-492a-8fff-279213ee1468
    ovirt_network_name: ovirtmgmt
    vnicProfileID: 3fa86930-0be5-4052-b667-b79f0a729692
publish: External
pullSecret: '{"auths": ...}'
sshKey: ssh-ed12345 AAAA...

```

**Example minimal install-config.yaml file**

```

apiVersion: v1
baseDomain: example.com
metadata:
  name: test-cluster

```

```

platform:
  ovirt:
    api_vip: 10.46.8.230
    ingress_vip: 10.46.8.232
    ovirt_cluster_id: 68833f9f-e89c-4891-b768-e2ba0815b76b
    ovirt_storage_domain_id: ed7b0f4e-0e96-492a-8fff-279213ee1468
    ovirt_network_name: ovirtmgmt
    vnicProfileID: 3fa86930-0be5-4052-b667-b79f0a729692
pullSecret: '{"auths": ...}'
sshKey: ssh-ed12345 AAAA...

```

### Example Custom machine pools in `arinstall-config.yaml` file

```

apiVersion: v1
baseDomain: example.com
controlPlane:
  name: master
  platform:
    ovirt:
      cpu:
        cores: 4
        sockets: 2
      memoryMB: 65536
      osDisk:
        sizeGB: 100
      vmType: server
  replicas: 3
compute:
- name: worker
  platform:
    ovirt:
      cpu:
        cores: 4
        sockets: 4
      memoryMB: 65536
      osDisk:
        sizeGB: 200
      vmType: server
  replicas: 5
metadata:
  name: test-cluster
platform:
  ovirt:
    api_vip: 10.46.8.230
    ingress_vip: 10.46.8.232
    ovirt_cluster_id: 68833f9f-e89c-4891-b768-e2ba0815b76b
    ovirt_storage_domain_id: ed7b0f4e-0e96-492a-8fff-279213ee1468
    ovirt_network_name: ovirtmgmt
    vnicProfileID: 3fa86930-0be5-4052-b667-b79f0a729692
pullSecret: '{"auths": ...}'
sshKey: ssh-ed25519 AAAA...

```

### Example non-enforcing affinity group

It is recommended to add a non-enforcing affinity group to distribute the control plane and workers, if possible, to use as much of the cluster as possible.

■

```

platform:
  ovirt:
    affinityGroups:
      - description: AffinityGroup to place each compute machine on a separate host
        enforcing: true
        name: compute
        priority: 3
      - description: AffinityGroup to place each control plane machine on a separate host
        enforcing: true
        name: controlplane
        priority: 5
      - description: AffinityGroup to place worker nodes and control plane nodes on separate hosts
        enforcing: false
        name: openshift
        priority: 5
  compute:
    - architecture: amd64
      hyperthreading: Enabled
      name: worker
      platform:
        ovirt:
          affinityGroupsNames:
            - compute
            - openshift
      replicas: 3
  controlPlane:
    architecture: amd64
    hyperthreading: Enabled
    name: master
    platform:
      ovirt:
        affinityGroupsNames:
          - controlplane
          - openshift
      replicas: 3

```

### Example removing all affinity groups for a non-production lab setup

For non-production lab setups, you must remove all affinity groups to concentrate the OpenShift Container Platform cluster on the few hosts you have.

```

platform:
  ovirt:
    affinityGroups: []
  compute:
    - architecture: amd64
      hyperthreading: Enabled
      name: worker
      platform:
        ovirt:
          affinityGroupsNames: []
      replicas: 3
  controlPlane:
    architecture: amd64
    hyperthreading: Enabled
    name: master
    platform:

```

```
ovirt:
  affinityGroupsNames: []
  replicas: 3
```

### 19.3.9.2. Installation configuration parameters

Before you deploy an OpenShift Container Platform cluster, you provide parameter values to describe your account on the cloud platform that hosts your cluster and optionally customize your cluster's platform. When you create the **install-config.yaml** installation configuration file, you provide values for the required parameters through the command line. If you customize your cluster, you can modify the **install-config.yaml** file to provide more details about the platform.



#### NOTE

After installation, you cannot modify these parameters in the **install-config.yaml** file.

#### 19.3.9.2.1. Required configuration parameters

Required installation configuration parameters are described in the following table:

Table 19.1. Required parameters

Parameter	Description	Values
<b>apiVersion</b>	The API version for the <b>install-config.yaml</b> content. The current version is <b>v1</b> . The installer may also support older API versions.	String
<b>baseDomain</b>	The base domain of your cloud provider. The base domain is used to create routes to your OpenShift Container Platform cluster components. The full DNS name for your cluster is a combination of the <b>baseDomain</b> and <b>metadata.name</b> parameter values that uses the <b>&lt;metadata.name&gt;.&lt;baseDomain&gt;</b> format.	A fully-qualified domain or subdomain name, such as <b>example.com</b> .
<b>metadata</b>	Kubernetes resource <b>ObjectMeta</b> , from which only the <b>name</b> parameter is consumed.	Object

Parameter	Description	Values
<b>metadata.name</b>	The name of the cluster. DNS records for the cluster are all subdomains of <b>{{.metadata.name}}.{{.baseDomain}}</b> .	String of lowercase letters, hyphens (-), and periods (.), such as <b>dev</b> .
<b>platform</b>	The configuration for the specific platform upon which to perform the installation: <b>alibabacloud, aws, baremetal, azure, gcp, ibmcloud, openstack, ovirt, vsphere</b> , or <b>{}</b> . For additional information about <b>platform.&lt;platform&gt;</b> parameters, consult the table for your specific platform that follows.	Object
<b>pullSecret</b>	Get a <a href="#">pull secret from the Red Hat OpenShift Cluster Manager</a> to authenticate downloading container images for OpenShift Container Platform components from services such as Quay.io.	<pre>{   "auths":{     "cloud.openshift.com":{       "auth":"b3Blb=",       "email":"you@example.com"     },     "quay.io":{       "auth":"b3Blb=",       "email":"you@example.com"     }   } }</pre>

### 19.3.9.2.2. Network configuration parameters



You can customize your installation configuration based on the requirements of your existing network infrastructure. For example, you can expand the IP address block for the cluster network or provide different IP address blocks than the defaults.

Only IPv4 addresses are supported.

Table 19.2. Network parameters

Parameter	Description	Values
-----------	-------------	--------



Parameter	Description	Values
<b>networking</b>	The configuration for the cluster network.	Object  <b>NOTE</b> You cannot modify parameters specified by the <b>networking</b> object after installation.
<b>networking.networkType</b>	The cluster network provider Container Network Interface (CNI) plugin to install.	Either <b>OpenShiftSDN</b> or <b>OVNKubernetes</b> . <b>OpenShiftSDN</b> is a CNI provider for all-Linux networks. <b>OVNKubernetes</b> is a CNI provider for Linux networks and hybrid networks that contain both Linux and Windows servers. The default value is <b>OpenShiftSDN</b> .
<b>networking.clusterNetwork</b>	The IP address blocks for pods.  The default value is <b>10.128.0.0/14</b> with a host prefix of <b>/23</b> .  If you specify multiple IP address blocks, the blocks must not overlap.	An array of objects. For example:   <b>networking:</b> <b>clusterNetwork:</b> - cidr: <b>10.128.0.0/14</b> hostPrefix: <b>23</b>
<b>networking.clusterNetwork.cidr</b>	Required if you use <b>networking.clusterNetwork</b> . An IP address block.  An IPv4 network.	An IP address block in Classless Inter-Domain Routing (CIDR) notation. The prefix length for an IPv4 block is between <b>0</b> and <b>32</b> .
<b>networking.clusterNetwork.hostPrefix</b>	The subnet prefix length to assign to each individual node. For example, if <b>hostPrefix</b> is set to <b>23</b> then each node is assigned a <b>/23</b> subnet out of the given <b>cidr</b> . A <b>hostPrefix</b> value of <b>23</b> provides 510 ( $2^{(32 - 23)} - 2$ ) pod IP addresses.	A subnet prefix.  The default value is <b>23</b> .

Parameter	Description	Values
<b>networking.serviceNetwork</b>	<p>The IP address block for services. The default value is <b>172.30.0.0/16</b>.</p> <p>The OpenShift SDN and OVN-Kubernetes network providers support only a single IP address block for the service network.</p>	<p>An array with an IP address block in CIDR format. For example:</p> <pre>networking:   serviceNetwork:     - 172.30.0.0/16</pre>
<b>networking.machineNetwork</b>	<p>The IP address blocks for machines.</p> <p>If you specify multiple IP address blocks, the blocks must not overlap.</p>	<p>An array of objects. For example:</p> <pre>networking:   machineNetwork:     - cidr: 10.0.0.0/16</pre>
<b>networking.machineNetwork.cidr</b>	<p>Required if you use <b>networking.machineNetwork</b>. An IP address block. The default value is <b>10.0.0.0/16</b> for all platforms other than libvirt. For libvirt, the default value is <b>192.168.126.0/24</b>.</p>	<p>An IP network block in CIDR notation.</p> <p>For example, <b>10.0.0.0/16</b>.</p> <div style="display: flex; align-items: flex-start;">  <div> <p><b>NOTE</b></p> <p>Set the <b>networking.machineNetwork</b> to match the CIDR that the preferred NIC resides in.</p> </div> </div>

### 19.3.9.2.3. Optional configuration parameters

Optional installation configuration parameters are described in the following table:

**Table 19.3. Optional parameters**



Parameter	Description	Values
<b>additionalTrustBundle</b>	<p>A PEM-encoded X.509 certificate bundle that is added to the nodes' trusted certificate store. This trust bundle may also be used when a proxy has been configured.</p>	String

Parameter	Description	Values
<b>cgroupsV2</b>	Enables <a href="#">Linux control groups version 2</a> (cgroups v2) on specific nodes in your cluster. The OpenShift Container Platform process for enabling cgroups v2 disables all cgroup version 1 controllers and hierarchies. The OpenShift Container Platform cgroups version 2 feature is in Developer Preview and is not supported by Red Hat at this time.	<b>true</b>
<b>compute</b>	The configuration for the machines that comprise the compute nodes.	Array of <b>MachinePool</b> objects. For details, see the "Additional RHV parameters for machine pools" table.
<b>compute.architecture</b>	Determines the instruction set architecture of the machines in the pool. Currently, clusters with varied architectures are not supported. All pools must specify the same architecture. Valid values are <b>amd64</b> (the default).	String
<b>compute.hyperthreading</b>	Whether to enable or disable simultaneous multithreading, or <b>hyperthreading</b> , on compute machines. By default, simultaneous multithreading is enabled to increase the performance of your machines' cores.  <div data-bbox="486 1444 593 1765" data-label="Image"> </div> <p><b>IMPORTANT</b></p> <p>If you disable simultaneous multithreading, ensure that your capacity planning accounts for the dramatically decreased machine performance.</p>	<b>Enabled</b> or <b>Disabled</b>
<b>compute.name</b>	Required if you use <b>compute</b> . The name of the machine pool.	<b>worker</b>

Parameter	Description	Values
<b>compute.platform</b>	Required if you use <b>compute</b> . Use this parameter to specify the cloud provider to host the worker machines. This parameter value must match the <b>controlPlane.platform</b> parameter value.	<b>alibabacloud, aws, azure, gcp, ibmcloud, openstack, ovirt, vsphere</b> , or <b>{}</b>
<b>compute.replicas</b>	The number of compute machines, which are also known as worker machines, to provision.	A positive integer greater than or equal to <b>2</b> . The default value is <b>3</b> .
<b>controlPlane</b>	The configuration for the machines that comprise the control plane.	Array of <b>MachinePool</b> objects. For details, see the "Additional RHV parameters for machine pools" table.
<b>controlPlane.architecture</b>	Determines the instruction set architecture of the machines in the pool. Currently, clusters with varied architectures are not supported. All pools must specify the same architecture. Valid values are <b>amd64</b> (the default).	String
<b>controlPlane.hyperthreading</b>	<p>Whether to enable or disable simultaneous multithreading, or <b>hyperthreading</b>, on control plane machines. By default, simultaneous multithreading is enabled to increase the performance of your machines' cores.</p> <div style="display: flex; align-items: flex-start;">  <p><b>IMPORTANT</b></p> <p>If you disable simultaneous multithreading, ensure that your capacity planning accounts for the dramatically decreased machine performance.</p> </div>	<b>Enabled</b> or <b>Disabled</b>
<b>controlPlane.name</b>	Required if you use <b>controlPlane</b> . The name of the machine pool.	<b>master</b>

Parameter	Description	Values
<b>controlPlane.platform</b>	Required if you use <b>controlPlane</b> . Use this parameter to specify the cloud provider that hosts the control plane machines. This parameter value must match the <b>compute.platform</b> parameter value.	<b>alibabacloud, aws, azure, gcp, ibmcloud, openstack, ovirt, vsphere</b> , or {}
<b>controlPlane.replicas</b>	The number of control plane machines to provision.	The only supported value is <b>3</b> , which is the default value.
<b>credentialsMode</b>	<p>The Cloud Credential Operator (CCO) mode. If no mode is specified, the CCO dynamically tries to determine the capabilities of the provided credentials, with a preference for mint mode on the platforms where multiple modes are supported.</p> <div data-bbox="485 898 595 1247" data-label="Image"> </div> <p><b>NOTE</b></p> <p>Not all CCO modes are supported for all cloud providers. For more information on CCO modes, see the <i>Cloud Credential Operator</i> entry in the <i>Cluster Operators reference</i> content.</p> <div data-bbox="485 1294 595 1644" data-label="Image"> </div> <p><b>NOTE</b></p> <p>If your AWS account has service control policies (SCP) enabled, you must configure the <b>credentialsMode</b> parameter to <b>Mint, Passthrough</b> or <b>Manual</b>.</p>	<b>Mint, Passthrough, Manual</b> or an empty string ("").

Parameter	Description	Values
<b>fips</b>	<p>Enable or disable FIPS mode. The default is <b>false</b> (disabled). If FIPS mode is enabled, the Red Hat Enterprise Linux CoreOS (RHCOS) machines that OpenShift Container Platform runs on bypass the default Kubernetes cryptography suite and use the cryptography modules that are provided with RHCOS instead.</p> <div data-bbox="488 584 592 1361" style="background-color: black; width: 65px; height: 347px; margin-bottom: 10px;"></div> <p><b>IMPORTANT</b></p> <p>To enable FIPS mode for your cluster, you must run the installation program from a Red Hat Enterprise Linux (RHEL) computer configured to operate in FIPS mode. For more information about configuring FIPS mode on RHEL, see <a href="#">Installing the system in FIPS mode</a>. The use of FIPS validated or Modules In Process cryptographic libraries is only supported on OpenShift Container Platform deployments on the <b>x86_64</b> architecture.</p> <div data-bbox="488 1406 592 1608" style="background-color: black; width: 65px; height: 90px; margin-bottom: 10px;"></div> <p><b>NOTE</b></p> <p>If you are using Azure File storage, you cannot enable FIPS mode.</p>	<b>false</b> or <b>true</b>
<b>imageContentSources</b>	Sources and repositories for the release-image content.	Array of objects. Includes a <b>source</b> and, optionally, <b>mirrors</b> , as described in the following rows of this table.
<b>imageContentSources.source</b>	Required if you use <b>imageContentSources</b> . Specify the repository that users refer to, for example, in image pull specifications.	String

Parameter	Description	Values
<b>imageContentSources.mirrors</b>	Specify one or more repositories that may also contain the same images.	Array of strings
<b>publish</b>	How to publish or expose the user-facing endpoints of your cluster, such as the Kubernetes API, OpenShift routes.	<p><b>Internal</b> or <b>External</b>. The default value is <b>External</b>.</p> <p>Setting this field to <b>Internal</b> is not supported on non-cloud platforms and IBM Cloud VPC.</p> <div style="display: flex; align-items: flex-start;">  <p><b>IMPORTANT</b></p> <p>If the value of the field is set to <b>Internal</b>, the cluster will become non-functional. For more information, refer to <a href="#">BZ#1953035</a>.</p> </div>
<b>sshKey</b>	<p>The SSH key or keys to authenticate access your cluster machines.</p> <div style="display: flex; align-items: flex-start;">  <p><b>NOTE</b></p> <p>For production OpenShift Container Platform clusters on which you want to perform installation debugging or disaster recovery, specify an SSH key that your <b>ssh-agent</b> process uses.</p> </div>	<p>One or more keys. For example:</p> <pre>sshKey:   &lt;key1&gt;   &lt;key2&gt;   &lt;key3&gt;</pre>

#### 19.3.9.2.4. Additional Red Hat Virtualization (RHV) configuration parameters

Additional RHV configuration parameters are described in the following table:

Table 19.4. Additional Red Hat Virtualization (RHV) parameters for clusters

Parameter	Description	Values
<b>platform.ovirt.ovirt_cluster_id</b>	Required. The Cluster where the VMs will be created.	String. For example: <b>68833f9f-e89c-4891-b768-e2ba0815b76b</b>
<b>platform.ovirt.ovirt_storage_domain_id</b>	Required. The Storage Domain ID where the VM disks will be created.	String. For example: <b>ed7b0f4e-0e96-492a-8fff-279213ee1468</b>

Parameter	Description	Values
<b>platform.ovirt.ovirt_network_name</b>	Required. The network name where the VM nics will be created.	String. For example: <b>ocpcluster</b>
<b>platform.ovirt.vnicProfileID</b>	Required. The vNIC profile ID of the VM network interfaces. This can be inferred if the cluster network has a single profile.	String. For example: <b>3fa86930-0be5-4052-b667-b79f0a729692</b>
<b>platform.ovirt.api_vip</b>	Required. An IP address on the machine network that will be assigned to the API virtual IP (VIP). You can access the OpenShift API at this endpoint.	String. Example: <b>10.46.8.230</b>
<b>platform.ovirt.ingress_vip</b>	Required. An IP address on the machine network that will be assigned to the Ingress virtual IP (VIP).	String. Example: <b>10.46.8.232</b>
<b>platform.ovirt.affinityGroups</b>	Optional. A list of affinity groups to create during the installation process.	List of objects.
<b>platform.ovirt.affinityGroups.description</b>	Required if you include <b>platform.ovirt.affinityGroups</b> . A description of the affinity group.	String. Example: <b>AffinityGroup for spreading each compute machine to a different host</b>
<b>platform.ovirt.affinityGroups.enforcing</b>	Required if you include <b>platform.ovirt.affinityGroups</b> . When set to <b>true</b> , RHV does not provision any machines if not enough hardware nodes are available. When set to <b>false</b> , RHV does provision machines even if not enough hardware nodes are available, resulting in multiple virtual machines being hosted on the same physical machine.	String. Example: <b>true</b>
<b>platform.ovirt.affinityGroups.name</b>	Required if you include <b>platform.ovirt.affinityGroups</b> . The name of the affinity group.	String. Example: <b>compute</b>



Parameter	Description	Values
<b>platform.ovirt.affinityGroups.priority</b>	Required if you include <b>platform.ovirt.affinityGroups</b> . The priority given to an affinity group when <b>platform.ovirt.affinityGroups.enforcing = false</b> . RHV applies affinity groups in the order of priority, where a greater number takes precedence over a lesser one. If multiple affinity groups have the same priority, the order in which they are applied is not guaranteed.	Integer. Example: <b>3</b>

#### 19.3.9.2.5. Additional RHV parameters for machine pools

Additional RHV configuration parameters for machine pools are described in the following table:

Table 19.5. Additional RHV parameters for machine pools

Parameter	Description	Values
<b>&lt;machine-pool&gt;.platform.ovirt.cpu</b>	Optional. Defines the CPU of the VM.	Object
<b>&lt;machine-pool&gt;.platform.ovirt.cpu.cores</b>	Required if you use <b>&lt;machine-pool&gt;.platform.ovirt.cpu</b> . The number of cores. Total virtual CPUs (vCPUs) is cores * sockets.	Integer
<b>&lt;machine-pool&gt;.platform.ovirt.cpu.sockets</b>	Required if you use <b>&lt;machine-pool&gt;.platform.ovirt.cpu</b> . The number of sockets per core. Total virtual CPUs (vCPUs) is cores * sockets.	Integer
<b>&lt;machine-pool&gt;.platform.ovirt.memoryMB</b>	Optional. Memory of the VM in MiB.	Integer

Parameter	Description	Values
<b>&lt;machine-pool&gt;.platform.ovirt.instanceTypeID</b>	<p>Optional. An instance type UUID, such as <b>00000009-0009-0009-0009-0000000000f1</b>, which you can get from the <a href="https://&lt;engine-fqdn&gt;/ovirt-engine/api/instancetype">https://&lt;engine-fqdn&gt;/ovirt-engine/api/instancetype</a> endpoint.</p> <div data-bbox="488 517 938 958" style="background-color: #fff9c4; padding: 10px; border: 1px solid #ccc;">  <p><b>WARNING</b></p> <p>The <b>instance_type_id</b> field is deprecated and will be removed in a future release.</p> </div>	String of UUID
<b>&lt;machine-pool&gt;.platform.ovirt.osDisk</b>	Optional. Defines the first and bootable disk of the VM.	String
<b>&lt;machine-pool&gt;.platform.ovirt.osDisk.sizeGB</b>	Required if you use <b>&lt;machine-pool&gt;.platform.ovirt.osDisk</b> . Size of the disk in GiB.	Number

Parameter	Description	Values
<b>&lt;machine-pool&gt;.platform.ovirt.vmType</b>	<p>Optional. The VM workload type, such as <b>high-performance</b>, <b>server</b>, or <b>desktop</b>. By default, control plane nodes use <b>high-performance</b>, and worker nodes use <b>server</b>. For details, see <a href="#">Explanation of Settings in the New Virtual Machine and Edit Virtual Machine Windows</a> and <a href="#">Configuring High Performance Virtual Machines, Templates, and Pools</a> in the <i>Virtual Machine Management Guide</i>.</p> <div data-bbox="485 651 595 1155" style="border: 1px solid black; padding: 5px; width: fit-content;">  </div> <p><b>NOTE</b></p> <p><b>high_performance</b> improves performance on the VM, but there are limitations. For example, you cannot access the VM with a graphical console. For more information, see <a href="#">Configuring High Performance Virtual Machines, Templates, and Pools</a> in the <i>Virtual Machine Management Guide</i>.</p>	String

Parameter	Description	Values
<code>&lt;machine-pool&gt;.platform.ovirt.affinityGroupsNames</code>	<p>Optional. A list of affinity group names that should be applied to the virtual machines. The affinity groups must exist in RHV, or be created during installation as described in <i>Additional RHV parameters for clusters</i> in this topic. This entry can be empty.</p> <p><b>Example with two affinity groups</b></p> <p>This example defines two affinity groups, named <b>compute</b> and <b>clusterWideNonEnforcing</b>:</p> <pre>&lt;machine-pool&gt;: platform: ovirt:   affinityGroupNames:     - compute     - clusterWideNonEnforcing</pre> <p>This example defines no affinity groups:</p> <pre>&lt;machine-pool&gt;: platform: ovirt:   affinityGroupNames: []</pre>	String
<code>&lt;machine-pool&gt;.platform.ovirt.AutoPinningPolicy</code>	<p>Optional. <code>AutoPinningPolicy</code> defines the policy to automatically set the CPU and NUMA settings, including pinning to the host for the instance. When the field is omitted, the default is <b>none</b>. Supported values: <b>none</b>, <b>resize_and_pin</b>. For more information, see <a href="#">Setting NUMA Nodes</a> in the <i>Virtual Machine Management Guide</i>.</p>	String
<code>&lt;machine-pool&gt;.platform.ovirt.hugepages</code>	<p>Optional. <code>Hugepages</code> is the size in KiB for defining hugepages in a VM. Supported values: <b>2048</b> or <b>1048576</b>. For more information, see <a href="#">Configuring Huge Pages</a> in the <i>Virtual Machine Management Guide</i>.</p>	Integer

**NOTE**

You can replace `<machine-pool>` with **controlPlane** or **compute**.

### 19.3.10. Deploying the cluster

You can install OpenShift Container Platform on a compatible cloud platform.

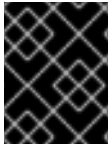

#### IMPORTANT

You can run the **create cluster** command of the installation program only once, during initial installation.

#### Prerequisites

- Open the **ovirt-imageio** port to the Manager from the machine running the installer. By default, the port is **54322**.
- Obtain the OpenShift Container Platform installation program and the pull secret for your cluster.

#### Procedure

1. Change to the directory that contains the installation program and initialize the cluster deployment:

```
$ ./openshift-install create cluster --dir <installation_directory> \ 1
--log-level=info 2
```

- 1 For **<installation\_directory>**, specify the location of your customized **./install-config.yaml** file.
- 2 To view different installation details, specify **warn**, **debug**, or **error** instead of **info**.



#### NOTE

If the cloud provider account that you configured on your host does not have sufficient permissions to deploy the cluster, the installation process stops, and the missing permissions are displayed.

When the cluster deployment completes, directions for accessing your cluster, including a link to its web console and credentials for the **kubeadmin** user, display in your terminal.

#### Example output

```
...
INFO Install complete!
INFO To access the cluster as the system:admin user when using 'oc', run 'export
KUBECONFIG=/home/myuser/install_dir/auth/kubeconfig'
INFO Access the OpenShift web-console here: https://console-openshift-
console.apps.mycluster.example.com
INFO Login to the console with user: "kubeadmin", and password: "4vYBz-Ee6gm-ymBZj-
Wt5AL"
INFO Time elapsed: 36m22s
```

**NOTE**

The cluster access and credential information also outputs to `<installation_directory>/openshift_install.log` when an installation succeeds.

**IMPORTANT**

- The Ignition config files that the installation program generates contain certificates that expire after 24 hours, which are then renewed at that time. If the cluster is shut down before renewing the certificates and the cluster is later restarted after the 24 hours have elapsed, the cluster automatically recovers the expired certificates. The exception is that you must manually approve the pending **node-bootstrapper** certificate signing requests (CSRs) to recover kubelet certificates. See the documentation for *Recovering from expired control plane certificates* for more information.
- It is recommended that you use Ignition config files within 12 hours after they are generated because the 24-hour certificate rotates from 16 to 22 hours after the cluster is installed. By using the Ignition config files within 12 hours, you can avoid installation failure if the certificate update runs during installation.

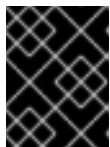
**IMPORTANT**

You must not delete the installation program or the files that the installation program creates. Both are required to delete the cluster.

**IMPORTANT**

You have completed the steps required to install the cluster. The remaining steps show you how to verify the cluster and troubleshoot the installation.

### 19.3.11. Installing the OpenShift CLI by downloading the binary

You can install the OpenShift CLI (**oc**) to interact with OpenShift Container Platform from a command-line interface. You can install **oc** on Linux, Windows, or macOS.

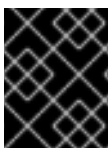
**IMPORTANT**

If you installed an earlier version of **oc**, you cannot use it to complete all of the commands in OpenShift Container Platform 4.10. Download and install the new version of **oc**.

#### Installing the OpenShift CLI on Linux

You can install the OpenShift CLI (**oc**) binary on Linux by using the following procedure.

##### Procedure

1. Navigate to the [OpenShift Container Platform downloads page](#) on the Red Hat Customer Portal.
2. Select the appropriate version in the **Version** drop-down menu.
3. Click **Download Now** next to the **OpenShift v4.10 Linux Client** entry and save the file.

4. Unpack the archive:

```
$ tar xvf <file>
```

5. Place the **oc** binary in a directory that is on your **PATH**.  
To check your **PATH**, execute the following command:

```
$ echo $PATH
```

After you install the OpenShift CLI, it is available using the **oc** command:

```
$ oc <command>
```

### Installing the OpenShift CLI on Windows

You can install the OpenShift CLI (**oc**) binary on Windows by using the following procedure.

#### Procedure

1. Navigate to the [OpenShift Container Platform downloads page](#) on the Red Hat Customer Portal.
2. Select the appropriate version in the **Version** drop-down menu.
3. Click **Download Now** next to the **OpenShift v4.10 Windows Client** entry and save the file.
4. Unzip the archive with a ZIP program.
5. Move the **oc** binary to a directory that is on your **PATH**.  
To check your **PATH**, open the command prompt and execute the following command:

```
C:\> path
```

After you install the OpenShift CLI, it is available using the **oc** command:

```
C:\> oc <command>
```

### Installing the OpenShift CLI on macOS

You can install the OpenShift CLI (**oc**) binary on macOS by using the following procedure.

#### Procedure

1. Navigate to the [OpenShift Container Platform downloads page](#) on the Red Hat Customer Portal.
2. Select the appropriate version in the **Version** drop-down menu.
3. Click **Download Now** next to the **OpenShift v4.10 MacOSX Client** entry and save the file.
4. Unpack and unzip the archive.
5. Move the **oc** binary to a directory on your **PATH**.  
To check your **PATH**, open a terminal and execute the following command:

```
$ echo $PATH
```

After you install the OpenShift CLI, it is available using the **oc** command:

```
$ oc <command>
```

### 19.3.12. Logging in to the cluster by using the CLI

You can log in to your cluster as a default system user by exporting the cluster **kubeconfig** file. The **kubeconfig** file contains information about the cluster that is used by the CLI to connect a client to the correct cluster and API server. The file is specific to a cluster and is created during OpenShift Container Platform installation.

#### Prerequisites

- You deployed an OpenShift Container Platform cluster.
- You installed the **oc** CLI.

#### Procedure

1. Export the **kubeadmin** credentials:

```
$ export KUBECONFIG=<installation_directory>/auth/kubeconfig 1
```

- 1** For **<installation\_directory>**, specify the path to the directory that you stored the installation files in.

2. Verify you can run **oc** commands successfully using the exported configuration:

```
$ oc whoami
```

#### Example output

```
system:admin
```

To learn more, see [Getting started with the OpenShift CLI](#).

### 19.3.13. Verifying cluster status

You can verify your OpenShift Container Platform cluster's status during or after installation.

#### Procedure

1. In the cluster environment, export the administrator's kubeconfig file:

```
$ export KUBECONFIG=<installation_directory>/auth/kubeconfig 1
```

- 1** For **<installation\_directory>**, specify the path to the directory that you stored the installation files in.



The **kubeconfig** file contains information about the cluster that is used by the CLI to connect a client to the correct cluster and API server.

- View the control plane and compute machines created after a deployment:

```
$ oc get nodes
```

- View your cluster's version:

```
$ oc get clusterversion
```

- View your Operators' status:

```
$ oc get clusteroperator
```

- View all running pods in the cluster:

```
$ oc get pods -A
```

## Troubleshooting

If the installation fails, the installation program times out and displays an error message. To learn more, see [Troubleshooting installation issues](#).

### 19.3.14. Accessing the OpenShift Container Platform web console on RHV

After the OpenShift Container Platform cluster initializes, you can log in to the OpenShift Container Platform web console.

#### Procedure

- Optional: In the Red Hat Virtualization (RHV) Administration Portal, open **Compute** → **Cluster**.
- Verify that the installation program creates the virtual machines.
- Return to the command line where the installation program is running. When the installation program finishes, it displays the user name and temporary password for logging into the OpenShift Container Platform web console.
- In a browser, open the URL of the OpenShift Container Platform web console. The URL uses this format:

```
console-openshift-console.apps.<clustername>.<basedomain> 1
```

- For **<clustername>.<basedomain>**, specify the cluster name and base domain.

For example:

```
console-openshift-console.apps.my-cluster.virtlab.example.com
```

### 19.3.15. Telemetry access for OpenShift Container Platform

In OpenShift Container Platform 4.10, the Telemetry service, which runs by default to provide metrics about cluster health and the success of updates, requires internet access. If your cluster is connected to the internet, Telemetry runs automatically, and your cluster is registered to [OpenShift Cluster Manager](#).

After you confirm that your [OpenShift Cluster Manager](#) inventory is correct, either maintained automatically by Telemetry or manually by using OpenShift Cluster Manager, [use subscription watch](#) to track your OpenShift Container Platform subscriptions at the account or multi-cluster level.

### Additional resources

- See [About remote health monitoring](#) for more information about the Telemetry service

## 19.3.16. Troubleshooting common issues with installing on Red Hat Virtualization (RHV)

Here are some common issues you might encounter, along with proposed causes and solutions.

### 19.3.16.1. CPU load increases and nodes go into a **Not Ready** state

- **Symptom:** CPU load increases significantly and nodes start going into a **Not Ready** state.
- **Cause:** The storage domain latency might be too high, especially for control plane nodes.

- **Solution:**

Make the nodes ready again by restarting the kubelet service:

```
$ systemctl restart kubelet
```

Inspect the OpenShift Container Platform metrics service, which automatically gathers and reports on some valuable data such as the etcd disk sync duration. If the cluster is operational, use this data to help determine whether storage latency or throughput is the root issue. If so, consider using a storage resource that has lower latency and higher throughput.

To get raw metrics, enter the following command as kubeadmin or user with cluster-admin privileges:

```
$ oc get --insecure-skip-tls-verify --server=https://localhost:<port> --raw=/metrics
```

To learn more, see [Exploring Application Endpoints for the purposes of Debugging with OpenShift 4.x](#)

### 19.3.16.2. Trouble connecting the OpenShift Container Platform cluster API

- **Symptom:** The installation program completes but the OpenShift Container Platform cluster API is not available. The bootstrap virtual machine remains up after the bootstrap process is complete. When you enter the following command, the response will time out.

```
$ oc login -u kubeadmin -p *** <apiurl>
```

- **Cause:** The bootstrap VM was not deleted by the installation program and has not released the cluster's API IP address.
- **Solution:** Use the **wait-for** subcommand to be notified when the bootstrap process is complete:

```
┆ $ ./openshift-install wait-for bootstrap-complete
```

When the bootstrap process is complete, delete the bootstrap virtual machine:

```
┆ $ ./openshift-install destroy bootstrap
```

### 19.3.17. Post-installation tasks

After the OpenShift Container Platform cluster initializes, you can perform the following tasks.

- Optional: After deployment, add or replace SSH keys using the Machine Config Operator (MCO) in OpenShift Container Platform.
- Optional: Remove the **kubeadmin** user. Instead, use the authentication provider to create a user with cluster-admin privileges.

### 19.3.18. Next steps

- [Customize your cluster](#).
- If necessary, you can [opt out of remote health reporting](#) .

## 19.4. INSTALLING A CLUSTER ON RHV WITH USER-PROVISIONED INFRASTRUCTURE

In OpenShift Container Platform version 4.10, you can install a customized OpenShift Container Platform cluster on Red Hat Virtualization (RHV) and other infrastructure that you provide. The OpenShift Container Platform documentation uses the term *user-provisioned infrastructure* to refer to this infrastructure type.

The following diagram shows an example of a potential OpenShift Container Platform cluster running on a RHV cluster.

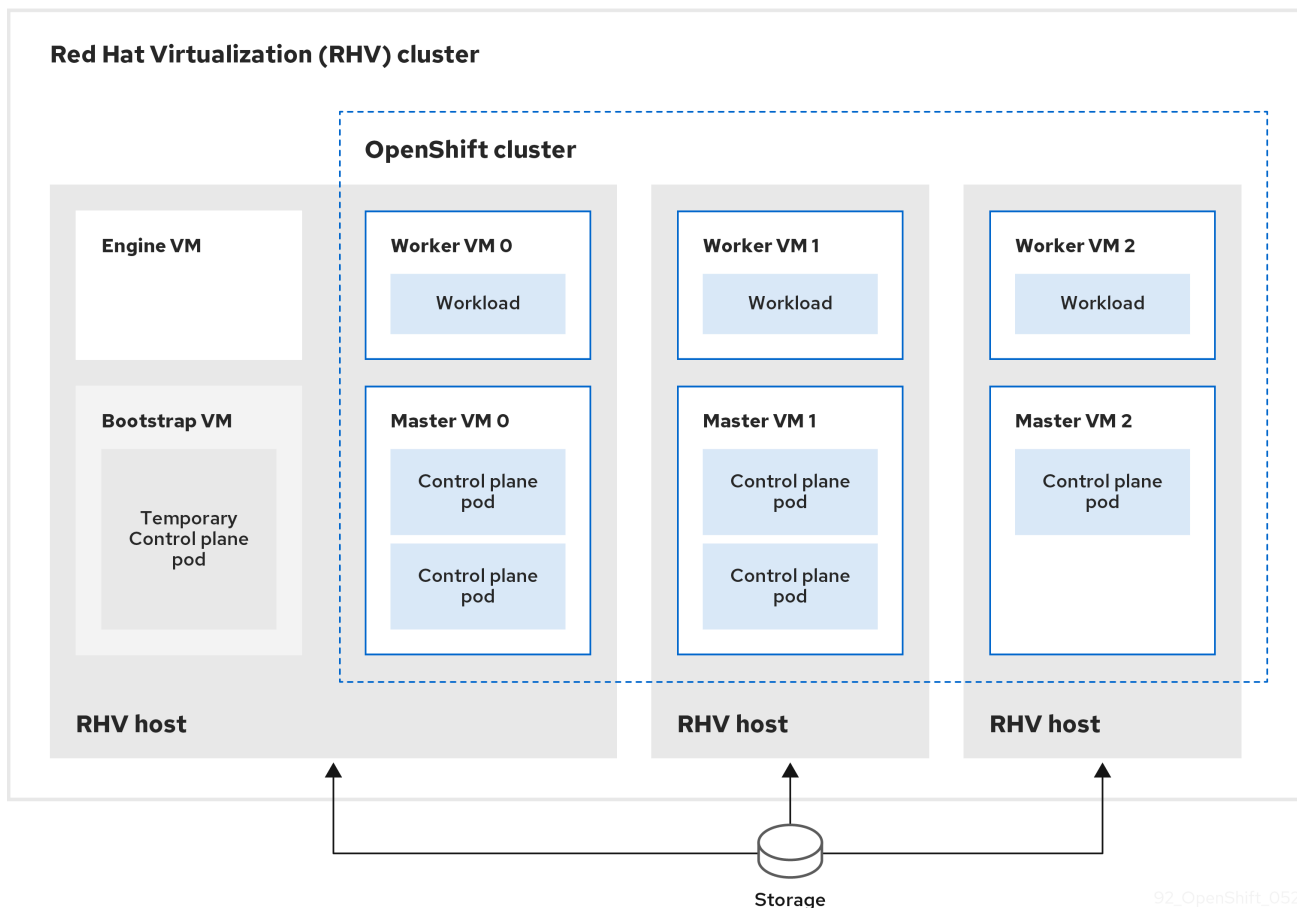

92\_OpenShift\_0520

The RHV hosts run virtual machines that contain both control plane and compute pods. One of the hosts also runs a Manager virtual machine and a bootstrap virtual machine that contains a temporary control plane pod.]

### 19.4.1. Prerequisites

The following items are required to install an OpenShift Container Platform cluster on a RHV environment.

- You reviewed details about the [OpenShift Container Platform installation and update](#) processes.
- You read the documentation on [selecting a cluster installation method and preparing it for users](#).
- You have a supported combination of versions in the [Support Matrix for OpenShift Container Platform on Red Hat Virtualization \(RHV\)](#).

### 19.4.2. Internet access for OpenShift Container Platform

In OpenShift Container Platform 4.10, you require access to the internet to install your cluster.

You must have internet access to:

- Access [OpenShift Cluster Manager](#) to download the installation program and perform subscription management. If the cluster has internet access and you do not disable Telemetry, that service automatically entitles your cluster.

- Access [Quay.io](https://quay.io) to obtain the packages that are required to install your cluster.
- Obtain the packages that are required to perform cluster updates.

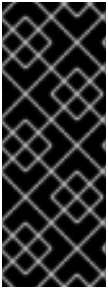

### IMPORTANT

If your cluster cannot have direct internet access, you can perform a restricted network installation on some types of infrastructure that you provision. During that process, you download the required content and use it to populate a mirror registry with the installation packages. With some installation types, the environment that you install your cluster in will not require internet access. Before you update the cluster, you update the content of the mirror registry.

### 19.4.3. Requirements for the RHV environment

To install and run an OpenShift Container Platform version 4.10 cluster, the RHV environment must meet the following requirements.

Not meeting these requirements can cause the installation or process to fail. Additionally, not meeting these requirements can cause the OpenShift Container Platform cluster to fail days or weeks after installation.

The following requirements for CPU, memory, and storage resources are based on **default** values multiplied by the default number of virtual machines the installation program creates. These resources must be available **in addition to** what the RHV environment uses for non-OpenShift Container Platform operations.

By default, the installation program creates seven virtual machines during the installation process. First, it creates a bootstrap virtual machine to provide temporary services and a control plane while it creates the rest of the OpenShift Container Platform cluster. When the installation program finishes creating the cluster, deleting the bootstrap machine frees up its resources.

If you increase the number of virtual machines in the RHV environment, you must increase the resources accordingly.

#### Requirements

- The RHV version is 4.4.
- The RHV environment has one data center whose state is **Up**.
- The RHV data center contains an RHV cluster.
- The RHV cluster has the following resources exclusively for the OpenShift Container Platform cluster:
  - Minimum 28 vCPUs: four for each of the seven virtual machines created during installation.
  - 112 GiB RAM or more, including:
    - 16 GiB or more for the bootstrap machine, which provides the temporary control plane.
    - 16 GiB or more for each of the three control plane machines which provide the control plane.

- 16 GiB or more for each of the three compute machines, which run the application workloads.
- The RHV storage domain must meet [these etcd backend performance requirements](#).
- In production environments, each virtual machine must have 120 GiB or more. Therefore, the storage domain must provide 840 GiB or more for the default OpenShift Container Platform cluster. In resource-constrained or non-production environments, each virtual machine must have 32 GiB or more, so the storage domain must have 230 GiB or more for the default OpenShift Container Platform cluster.
- To download images from the Red Hat Ecosystem Catalog during installation and update procedures, the RHV cluster must have access to an internet connection. The Telemetry service also needs an internet connection to simplify the subscription and entitlement process.
- The RHV cluster must have a virtual network with access to the REST API on the RHV Manager. Ensure that DHCP is enabled on this network, because the VMs that the installer creates obtain their IP address by using DHCP.
- A user account and group with the following least privileges for installing and managing an OpenShift Container Platform cluster on the target RHV cluster:
  - **DiskOperator**
  - **DiskCreator**
  - **UserTemplateBasedVm**
  - **TemplateOwner**
  - **TemplateCreator**
  - **ClusterAdmin** on the target cluster



#### WARNING

Apply the principle of least privilege: Avoid using an administrator account with **SuperUser** privileges on RHV during the installation process. The installation program saves the credentials you provide to a temporary **ovirt-config.yaml** file that might be compromised.

#### 19.4.4. Verifying the requirements for the RHV environment

Verify that the RHV environment meets the requirements to install and run an OpenShift Container Platform cluster. Not meeting these requirements can cause failures.

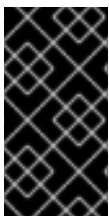

#### IMPORTANT

These requirements are based on the default resources the installation program uses to create control plane and compute machines. These resources include vCPUs, memory, and storage. If you change these resources or increase the number of OpenShift Container Platform machines, adjust these requirements accordingly.

## Procedure

1. Check that the RHV version supports installation of OpenShift Container Platform version 4.10.
  - a. In the RHV Administration Portal, click the ? help icon in the upper-right corner and select **About**.
  - b. In the window that opens, make a note of the **RHV Software Version**
  - c. Confirm that the RHV version is 4.4. For more information about supported version combinations, see [Support Matrix for OpenShift Container Platform on RHV](#).
2. Inspect the data center, cluster, and storage.
  - a. In the RHV Administration Portal, click **Compute → Data Centers**.
  - b. Confirm that the data center where you plan to install OpenShift Container Platform is accessible.
  - c. Click the name of that data center.
  - d. In the data center details, on the **Storage** tab, confirm the storage domain where you plan to install OpenShift Container Platform is **Active**.
  - e. Record the **Domain Name** for use later on.
  - f. Confirm **Free Space** has at least 230 GiB.
  - g. Confirm that the storage domain meets [these etcd backend performance requirements](#), which you [can measure by using the fio performance benchmarking tool](#).
  - h. In the data center details, click the **Clusters** tab.
    - i. Find the RHV cluster where you plan to install OpenShift Container Platform. Record the cluster name for use later on.
3. Inspect the RHV host resources.
  - a. In the RHV Administration Portal, click **Compute > Clusters**
  - b. Click the cluster where you plan to install OpenShift Container Platform.
  - c. In the cluster details, click the **Hosts** tab.
  - d. Inspect the hosts and confirm they have a combined total of at least 28 **Logical CPU Cores** available *exclusively* for the OpenShift Container Platform cluster.
  - e. Record the number of available **Logical CPU Cores** for use later on.
  - f. Confirm that these CPU cores are distributed so that each of the seven virtual machines created during installation can have four cores.
  - g. Confirm that, all together, the hosts have 112 GiB of **Max free Memory for scheduling new virtual machines** distributed to meet the requirements for each of the following OpenShift Container Platform machines:
    - 16 GiB required for the bootstrap machine
    - 16 GiB required for each of the three control plane machines

- 16 GiB for each of the three compute machines
- Record the amount of **Max free Memory for scheduling new virtual machines** for use later on.
- Verify that the virtual network for installing OpenShift Container Platform has access to the RHV Manager's REST API. From a virtual machine on this network, use curl to reach the RHV Manager's REST API:

```
$ curl -k -u <username>@<profile>:<password> \ 1
https://<engine-fqdn>/ovirt-engine/api 2
```

**1** For **<username>**, specify the user name of an RHV account with privileges to create and manage an OpenShift Container Platform cluster on RHV. For **<profile>**, specify the login profile, which you can get by going to the RHV Administration Portal login page and reviewing the **Profile** dropdown list. For **<password>**, specify the password for that user name.

**2** For **<engine-fqdn>**, specify the fully qualified domain name of the RHV environment.

For example:

```
$ curl -k -u ocpadmin@internal:pw123 \
https://rhv-env.virtlab.example.com/ovirt-engine/api
```

### 19.4.5. Networking requirements for user-provisioned infrastructure

All the Red Hat Enterprise Linux CoreOS (RHCOS) machines require networking to be configured in **initramfs** during boot to fetch their Ignition config files.

During the initial boot, the machines require an IP address configuration that is set either through a DHCP server or statically by providing the required boot options. After a network connection is established, the machines download their Ignition config files from an HTTP or HTTPS server. The Ignition config files are then used to set the exact state of each machine. The Machine Config Operator completes more changes to the machines, such as the application of new certificates or keys, after installation.

It is recommended to use a DHCP server for long-term management of the cluster machines. Ensure that the DHCP server is configured to provide persistent IP addresses, DNS server information, and hostnames to the cluster machines.



#### NOTE

If a DHCP service is not available for your user-provisioned infrastructure, you can instead provide the IP networking configuration and the address of the DNS server to the nodes at RHCOS install time. These can be passed as boot arguments if you are installing from an ISO image. See the *Installing RHCOS and starting the OpenShift Container Platform bootstrap process* section for more information about static IP provisioning and advanced networking options.

The Kubernetes API server must be able to resolve the node names of the cluster machines. If the API servers and worker nodes are in different zones, you can configure a default DNS search zone to allow the API server to resolve the node names. Another supported approach is to always refer to hosts by



their fully-qualified domain names in both the node objects and all DNS requests.

## Firewall

Configure your firewall so your cluster has access to required sites.

See also:

- [Red Hat Virtualization Manager firewall requirements](#)
- [Host firewall requirements](#)

## Load balancers

Configure one or preferably two layer-4 load balancers:

- Provide load balancing for ports **6443** and **22623** on the control plane and bootstrap machines. Port **6443** provides access to the Kubernetes API server and must be reachable both internally and externally. Port **22623** must be accessible to nodes within the cluster.
- Provide load balancing for port **443** and **80** for machines that run the Ingress router, which are usually compute nodes in the default configuration. Both ports must be accessible from within and outside the cluster.

## DNS

Configure infrastructure-provided DNS to allow the correct resolution of the main components and services. If you use only one load balancer, these DNS records can point to the same IP address.

- Create DNS records for **api.<cluster\_name>.<base\_domain>** (internal and external resolution) and **api-int.<cluster\_name>.<base\_domain>** (internal resolution) that point to the load balancer for the control plane machines.
- Create a DNS record for **\*.apps.<cluster\_name>.<base\_domain>** that points to the load balancer for the Ingress router. For example, ports **443** and **80** of the compute machines.

### 19.4.5.1. Setting the cluster node hostnames through DHCP

On Red Hat Enterprise Linux CoreOS (RHCOS) machines, the hostname is set through NetworkManager. By default, the machines obtain their hostname through DHCP. If the hostname is not provided by DHCP, set statically through kernel arguments, or another method, it is obtained through a reverse DNS lookup. Reverse DNS lookup occurs after the network has been initialized on a node and can take time to resolve. Other system services can start prior to this and detect the hostname as **localhost** or similar. You can avoid this by using DHCP to provide the hostname for each cluster node.

Additionally, setting the hostnames through DHCP can bypass any manual DNS record name configuration errors in environments that have a DNS split-horizon implementation.

### 19.4.5.2. Network connectivity requirements

You must configure the network connectivity between machines to allow OpenShift Container Platform cluster components to communicate. Each machine must be able to resolve the hostnames of all other machines in the cluster.

This section provides details about the ports that are required.



## IMPORTANT

In connected OpenShift Container Platform environments, all nodes are required to have internet access to pull images for platform containers and provide telemetry data to Red Hat.

**Table 19.6. Ports used for all-machine to all-machine communications**

Protocol	Port	Description
ICMP	N/A	Network reachability tests
TCP	<b>1936</b>	Metrics
	<b>9000-9999</b>	Host level services, including the node exporter on ports <b>9100-9101</b> and the Cluster Version Operator on port <b>9099</b> .
	<b>10250-10259</b>	The default ports that Kubernetes reserves
	<b>10256</b>	openshift-sdn
UDP	<b>4789</b>	VXLAN
	<b>6081</b>	Geneve
	<b>9000-9999</b>	Host level services, including the node exporter on ports <b>9100-9101</b> .
	<b>500</b>	IPsec IKE packets
	<b>4500</b>	IPsec NAT-T packets
TCP/UDP	<b>30000-32767</b>	Kubernetes node port
ESP	N/A	IPsec Encapsulating Security Payload (ESP)

**Table 19.7. Ports used for all-machine to control plane communications**

Protocol	Port	Description
TCP	<b>6443</b>	Kubernetes API

**Table 19.8. Ports used for control plane machine to control plane machine communications**

Protocol	Port	Description
TCP	<b>2379-2380</b>	etcd server and peer ports

### NTP configuration for user-provisioned infrastructure

OpenShift Container Platform clusters are configured to use a public Network Time Protocol (NTP) server by default. If you want to use a local enterprise NTP server, or if your cluster is being deployed in a disconnected network, you can configure the cluster to use a specific time server. For more information, see the documentation for *Configuring chrony time service*.

If a DHCP server provides NTP server information, the chrony time service on the Red Hat Enterprise Linux CoreOS (RHCOS) machines read the information and can sync the clock with the NTP servers.

## 19.4.6. Setting up the installation machine

To run the binary **openshift-install** installation program and Ansible scripts, set up the RHV Manager or an Red Hat Enterprise Linux (RHEL) computer with network access to the RHV environment and the REST API on the Manager.

### Procedure

1. Update or install Python3 and Ansible. For example:

```
# dnf update python3 ansible
```

2. Install the **python3-ovirt-engine-sdk4** package to get the Python Software Development Kit.
3. Install the **ovirt.image-template** Ansible role. On the RHV Manager and other Red Hat Enterprise Linux (RHEL) machines, this role is distributed as the **ovirt-ansible-image-template** package. For example, enter:

```
# dnf install ovirt-ansible-image-template
```

4. Install the **ovirt.vm-infra** Ansible role. On the RHV Manager and other RHEL machines, this role is distributed as the **ovirt-ansible-vm-infra** package.

```
# dnf install ovirt-ansible-vm-infra
```

5. Create an environment variable and assign an absolute or relative path to it. For example, enter:

```
$ export ASSETS_DIR=./wrk
```



### NOTE

The installation program uses this variable to create a directory where it saves important installation-related files. Later, the installation process reuses this variable to locate those asset files. Avoid deleting this assets directory; it is required for uninstalling the cluster.

## 19.4.7. Installing OpenShift Container Platform on RHV in insecure mode

By default, the installer creates a CA certificate, prompts you for confirmation, and stores the certificate to use during installation. You do not need to create or install one manually.

Although it is not recommended, you can override this functionality and install OpenShift Container Platform without verifying a certificate by installing OpenShift Container Platform on RHV in **insecure** mode.

**WARNING**

Installing in **insecure** mode is not recommended, because it enables a potential attacker to perform a Man-in-the-Middle attack and capture sensitive credentials on the network.

**Procedure**

1. Create a file named `~/.ovirt/ovirt-config.yaml`.
2. Add the following content to **ovirt-config.yaml**:

```
ovirt_url: https://ovirt.example.com/ovirt-engine/api 1
ovirt_fqdn: ovirt.example.com 2
ovirt_pem_url: ""
ovirt_username: ocpadmin@internal
ovirt_password: super-secret-password 3
ovirt_insecure: true
```

- 1 Specify the hostname or address of your oVirt engine.
- 2 Specify the fully qualified domain name of your oVirt engine.
- 3 Specify the admin password for your oVirt engine.

3. Run the installer.

**19.4.8. Generating a key pair for cluster node SSH access**

During an OpenShift Container Platform installation, you can provide an SSH public key to the installation program. The key is passed to the Red Hat Enterprise Linux CoreOS (RHCOS) nodes through their Ignition config files and is used to authenticate SSH access to the nodes. The key is added to the `~/.ssh/authorized_keys` list for the **core** user on each node, which enables password-less authentication.

After the key is passed to the nodes, you can use the key pair to SSH in to the RHCOS nodes as the user **core**. To access the nodes through SSH, the private key identity must be managed by SSH for your local user.

If you want to SSH in to your cluster nodes to perform installation debugging or disaster recovery, you must provide the SSH public key during the installation process. The `./openshift-install gather` command also requires the SSH public key to be in place on the cluster nodes.

**IMPORTANT**

Do not skip this procedure in production environments, where disaster recovery and debugging is required.

**NOTE**

You must use a local key, not one that you configured with platform-specific approaches such as [AWS key pairs](#).

**Procedure**

1. If you do not have an existing SSH key pair on your local machine to use for authentication onto your cluster nodes, create one. For example, on a computer that uses a Linux operating system, run the following command:

```
$ ssh-keygen -t ed25519 -N "" -f <path>/<file_name> 1
```

- 1 Specify the path and file name, such as `~/.ssh/id_ed25519`, of the new SSH key. If you have an existing key pair, ensure your public key is in the your `~/.ssh` directory.

**NOTE**

If you plan to install an OpenShift Container Platform cluster that uses FIPS validated or Modules In Process cryptographic libraries on the **x86\_64** architecture, do not create a key that uses the **ed25519** algorithm. Instead, create a key that uses the **rsa** or **ecdsa** algorithm.

2. View the public SSH key:

```
$ cat <path>/<file_name>.pub
```

For example, run the following to view the `~/.ssh/id_ed25519.pub` public key:

```
$ cat ~/.ssh/id_ed25519.pub
```

3. Add the SSH private key identity to the SSH agent for your local user, if it has not already been added. SSH agent management of the key is required for password-less SSH authentication onto your cluster nodes, or if you want to use the `./openshift-install gather` command.

**NOTE**

On some distributions, default SSH private key identities such as `~/.ssh/id_rsa` and `~/.ssh/id_dsa` are managed automatically.

- a. If the **ssh-agent** process is not already running for your local user, start it as a background task:

```
$ eval "$(ssh-agent -s)"
```

**Example output**

```
Agent pid 31874
```

**NOTE**

If your cluster is in FIPS mode, only use FIPS-compliant algorithms to generate the SSH key. The key must be either RSA or ECDSA.

4. Add your SSH private key to the **ssh-agent**:

```
$ ssh-add <path>/<file_name> 1
```

- 1** Specify the path and file name for your SSH private key, such as `~/.ssh/id_ed25519`

**Example output**

```
Identity added: /home/<you>/<path>/<file_name> (<computer_name>)
```

**Next steps**

- When you install OpenShift Container Platform, provide the SSH public key to the installation program.

**19.4.9. Obtaining the installation program**

Before you install OpenShift Container Platform, download the installation file on a local computer.

**Prerequisites**

- You have a computer that runs Linux or macOS, with 500 MB of local disk space

**Procedure**

1. Access the [Infrastructure Provider](#) page on the OpenShift Cluster Manager site. If you have a Red Hat account, log in with your credentials. If you do not, create an account.
2. Select your infrastructure provider.
3. Navigate to the page for your installation type, download the installation program that corresponds with your host operating system and architecture, and place the file in the directory where you will store the installation configuration files.

**IMPORTANT**

The installation program creates several files on the computer that you use to install your cluster. You must keep the installation program and the files that the installation program creates after you finish installing the cluster. Both files are required to delete the cluster.

**IMPORTANT**

Deleting the files created by the installation program does not remove your cluster, even if the cluster failed during installation. To remove your cluster, complete the OpenShift Container Platform uninstallation procedures for your specific cloud provider.

4. Extract the installation program. For example, on a computer that uses a Linux operating system, run the following command:

```
$ tar -xvf openshift-install-linux.tar.gz
```

5. Download your installation [pull secret from the Red Hat OpenShift Cluster Manager](#) . This pull secret allows you to authenticate with the services that are provided by the included authorities, including Quay.io, which serves the container images for OpenShift Container Platform components.

### 19.4.10. Downloading the Ansible playbooks

Download the Ansible playbooks for installing OpenShift Container Platform version 4.10 on RHV.

#### Procedure

- On your installation machine, run the following commands:

```
$ mkdir playbooks
```

```
$ cd playbooks
```

```
$ curl -s -L -X GET https://api.github.com/repos/openshift/installer/contents/upi/ovirt?
ref=release-4.10 |
grep 'download_url.*\.yml' |
awk '{ print $2 }' | sed -r 's/(\"|\",)//g' |
xargs -n 1 curl -O
```

#### Next steps

- After you download these Ansible playbooks, you must also create the environment variable for the assets directory and customize the **inventory.yml** file before you create an installation configuration file by running the installation program.

### 19.4.11. The inventory.yml file

You use the **inventory.yml** file to define and create elements of the OpenShift Container Platform cluster you are installing. This includes elements such as the Red Hat Enterprise Linux CoreOS (RHCOS) image, virtual machine templates, bootstrap machine, control plane nodes, and worker nodes. You also use **inventory.yml** to destroy the cluster.

The following **inventory.yml** example shows you the parameters and their default values. The quantities and numbers in these default values meet the requirements for running a production OpenShift Container Platform cluster in a RHV environment.

#### Example inventory.yml file

```
---
all:
  vars:

    ovirt_cluster: "Default"
    ocp:
```

```
assets_dir: "{{ lookup('env', 'ASSETS_DIR') }}"
ovirt_config_path: "{{ lookup('env', 'HOME') }}/.ovirt/ovirt-config.yaml"

# ---
# {op-system} section
# ---
rhcos:
  image_url: "https://mirror.openshift.com/pub/openshift-v4/dependencies/rhcos/4.10/latest/rhcos-
  openstack.x86_64.qcow2.gz"
  local_cmp_image_path: "/tmp/rhcos.qcow2.gz"
  local_image_path: "/tmp/rhcos.qcow2"

# ---
# Profiles section
# ---
control_plane:
  cluster: "{{ ovirt_cluster }}"
  memory: 16GiB
  sockets: 4
  cores: 1
  template: rhcos_tpl
  operating_system: "rhcos_x64"
  type: high_performance
  graphical_console:
    headless_mode: false
  protocol:
    - spice
    - vnc
  disks:
    - size: 120GiB
      name: os
      interface: virtio_scsi
      storage_domain: depot_nvme
  nics:
    - name: nic1
      network: lab
      profile: lab

compute:
  cluster: "{{ ovirt_cluster }}"
  memory: 16GiB
  sockets: 4
  cores: 1
  template: worker_rhcos_tpl
  operating_system: "rhcos_x64"
  type: high_performance
  graphical_console:
    headless_mode: false
  protocol:
    - spice
    - vnc
  disks:
    - size: 120GiB
      name: os
      interface: virtio_scsi
      storage_domain: depot_nvme
```



```

    nics:
    - name: nic1
      network: lab
      profile: lab

    # ---
    # Virtual machines section
    # ---
    vms:
    - name: "{{ metadata.infraID }}-bootstrap"
      ocp_type: bootstrap
      profile: "{{ control_plane }}"
      type: server
    - name: "{{ metadata.infraID }}-master0"
      ocp_type: master
      profile: "{{ control_plane }}"
    - name: "{{ metadata.infraID }}-master1"
      ocp_type: master
      profile: "{{ control_plane }}"
    - name: "{{ metadata.infraID }}-master2"
      ocp_type: master
      profile: "{{ control_plane }}"
    - name: "{{ metadata.infraID }}-worker0"
      ocp_type: worker
      profile: "{{ compute }}"
    - name: "{{ metadata.infraID }}-worker1"
      ocp_type: worker
      profile: "{{ compute }}"
    - name: "{{ metadata.infraID }}-worker2"
      ocp_type: worker
      profile: "{{ compute }}"

```

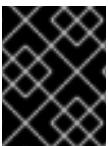

## IMPORTANT

Enter values for parameters whose descriptions begin with "Enter." Otherwise, you can use the default value or replace it with a new value.

### General section

- **ovirt\_cluster**: Enter the name of an existing RHV cluster in which to install the OpenShift Container Platform cluster.
- **ocp.assets\_dir**: The path of a directory the **openshift-install** installation program creates to store the files that it generates.
- **ocp.ovirt\_config\_path**: The path of the **ovirt-config.yaml** file the installation program generates, for example, **./wrk/install-config.yaml**. This file contains the credentials required to interact with the REST API of the Manager.

### Red Hat Enterprise Linux CoreOS (RHCOS) section

- **image\_url**: Enter the URL of the RHCOS image you specified for download.
- **local\_cmp\_image\_path**: The path of a local download directory for the compressed RHCOS image.

- **local\_image\_path**: The path of a local directory for the extracted RHCOS image.

## Profiles section

This section consists of two profiles:

- **control\_plane**: The profile of the bootstrap and control plane nodes.
- **compute**: The profile of workers nodes in the compute plane.

These profiles have the following parameters. The default values of the parameters meet the minimum requirements for running a production cluster. You can increase or customize these values to meet your workload requirements.

- **cluster**: The value gets the cluster name from **ovirt\_cluster** in the General Section.
- **memory**: The amount of memory, in GB, for the virtual machine.
- **sockets**: The number of sockets for the virtual machine.
- **cores**: The number of cores for the virtual machine.
- **template**: The name of the virtual machine template. If plan to install multiple clusters, and these clusters use templates that contain different specifications, prepend the template name with the ID of the cluster.
- **operating\_system**: The type of guest operating system in the virtual machine. With oVirt/RHV version 4.4, this value must be **rhcos\_x64** so the value of **ignition script** can be passed to the VM.
- **type**: Enter **server** as the type of the virtual machine.

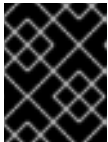

### IMPORTANT

You must change the value of the **type** parameter from **high\_performance** to **server**.

- **disks**: The disk specifications. The **control\_plane** and **compute** nodes can have different storage domains.
- **size**: The minimum disk size.
- **name**: Enter the name of a disk connected to the target cluster in RHV.
- **interface**: Enter the interface type of the disk you specified.
- **storage\_domain**: Enter the storage domain of the disk you specified.
- **nics**: Enter the **name** and **network** the virtual machines use. You can also specify the virtual network interface profile. By default, NICs obtain their MAC addresses from the oVirt/RHV MAC pool.

## Virtual machines section

This final section, **vms**, defines the virtual machines you plan to create and deploy in the cluster. By default, it provides the minimum number of control plane and worker nodes for a production environment.

**vms** contains three required elements:

- **name**: The name of the virtual machine. In this case, **metadata.infraID** prepends the virtual machine name with the infrastructure ID from the **metadata.yml** file.
- **ocp\_type**: The role of the virtual machine in the OpenShift Container Platform cluster. Possible values are **bootstrap**, **master**, **worker**.
- **profile**: The name of the profile from which each virtual machine inherits specifications. Possible values in this example are **control\_plane** or **compute**.  
You can override the value a virtual machine inherits from its profile. To do this, you add the name of the profile attribute to the virtual machine in **inventory.yml** and assign it an overriding value. To see an example of this, examine the **name: "{{ metadata.infraID }}-bootstrap"** virtual machine in the preceding **inventory.yml** example: It has a **type** attribute whose value, **server**, overrides the value of the **type** attribute this virtual machine would otherwise inherit from the **control\_plane** profile.

## Metadata variables

For virtual machines, **metadata.infraID** prepends the name of the virtual machine with the infrastructure ID from the **metadata.json** file you create when you build the Ignition files.

The playbooks use the following code to read **infraID** from the specific file located in the **ocp.assets\_dir**.

```
---
- name: include metadata.json vars
  include_vars:
    file: "{{ ocp.assets_dir }}/metadata.json"
    name: metadata
...
```

### 19.4.12. Specifying the RHCOS image settings

Update the Red Hat Enterprise Linux CoreOS (RHCOS) image settings of the **inventory.yml** file. Later, when you run this file one of the playbooks, it downloads a compressed Red Hat Enterprise Linux CoreOS (RHCOS) image from the **image\_url** URL to the **local\_cmp\_image\_path** directory. The playbook then uncompresses the image to the **local\_image\_path** directory and uses it to create oVirt/RHV templates.

#### Procedure

1. Locate the RHCOS image download page for the version of OpenShift Container Platform you are installing, such as [Index of /pub/openshift-v4/dependencies/rhcos/latest/latest](#).
2. From that download page, copy the URL of an OpenStack **qcow2** image, such as **https://mirror.openshift.com/pub/openshift-v4/dependencies/rhcos/4.10/latest/rhcos-openstack.x86\_64.qcow2.gz**.
3. Edit the **inventory.yml** playbook you downloaded earlier. In it, paste the URL as the value for **image\_url**. For example:

```
rhcos:
  "https://mirror.openshift.com/pub/openshift-v4/dependencies/rhcos/4.10/latest/rhcos-
  openstack.x86_64.qcow2.gz"
```

■

### 19.4.13. Creating the install config file

You create an installation configuration file by running the installation program, **openshift-install**, and responding to its prompts with information you specified or gathered earlier.

When you finish responding to the prompts, the installation program creates an initial version of the **install-config.yaml** file in the assets directory you specified earlier, for example, **./wrk/install-config.yaml**

The installation program also creates a file, **\$HOME/.ovirt/ovirt-config.yaml**, that contains all the connection parameters that are required to reach the Manager and use its REST API.

**NOTE:** The installation process does not use values you supply for some parameters, such as **Internal API virtual IP** and **Ingress virtual IP**, because you have already configured them in your infrastructure DNS.

It also uses the values you supply for parameters in **inventory.yml**, like the ones for **oVirt cluster**, **oVirt storage**, and **oVirt network**. And uses a script to remove or replace these same values from **install-config.yaml** with the previously mentioned **virtual IPs**.

#### Procedure

1. Run the installation program:

```
$ openshift-install create install-config --dir $ASSETS_DIR
```

2. Respond to the installation program's prompts with information about your system.

#### Example output

```
? SSH Public Key /home/user/.ssh/id_dsa.pub
? Platform <ovirt>
? Engine FQDN[:PORT] [? for help] <engine.fqdn>
? Enter ovirt-engine username <ocpadmin@internal>
? Enter password <*****>
? oVirt cluster <cluster>
? oVirt storage <storage>
? oVirt network <net>
? Internal API virtual IP <172.16.0.252>
? Ingress virtual IP <172.16.0.251>
? Base Domain <example.org>
? Cluster Name <ocp4>
? Pull Secret [? for help] <*****>
```

```
? SSH Public Key /home/user/.ssh/id_dsa.pub
? Platform <ovirt>
? Engine FQDN[:PORT] [? for help] <engine.fqdn>
? Enter ovirt-engine username <ocpadmin@internal>
? Enter password <*****>
? oVirt cluster <cluster>
? oVirt storage <storage>
? oVirt network <net>
? Internal API virtual IP <172.16.0.252>
```

```
? Ingress virtual IP <172.16.0.251>
? Base Domain <example.org>
? Cluster Name <ocp4>
? Pull Secret [? for help] <*****>
```

For **Internal API virtual IP** and **Ingress virtual IP**, supply the IP addresses you specified when you configured the DNS service.

Together, the values you enter for the **oVirt cluster** and **Base Domain** prompts form the FQDN portion of URLs for the REST API and any applications you create, such as **https://api.ocp4.example.org:6443/** and **https://console-openshift-console.apps.ocp4.example.org**.

You can get the [pull secret from the Red Hat OpenShift Cluster Manager](#) .

### 19.4.14. Customizing install-config.yaml

Here, you use three Python scripts to override some of the installation program's default behaviors:

- By default, the installation program uses the machine API to create nodes. To override this default behavior, you set the number of compute nodes to zero replicas. Later, you use Ansible playbooks to create the compute nodes.
- By default, the installation program sets the IP range of the machine network for nodes. To override this default behavior, you set the IP range to match your infrastructure.
- By default, the installation program sets the platform to **ovirt**. However, installing a cluster on user-provisioned infrastructure is more similar to installing a cluster on bare metal. Therefore, you delete the **ovirt** platform section from **install-config.yaml** and change the platform to **none**. Instead, you use **inventory.yml** to specify all of the required settings.



#### NOTE

These snippets work with Python 3 and Python 2.

#### Procedure

1. Set the number of compute nodes to zero replicas:

```
$ python3 -c 'import os, yaml
path = "%s/install-config.yaml" % os.environ["ASSETS_DIR"]
conf = yaml.safe_load(open(path))
conf["compute"][0]["replicas"] = 0
open(path, "w").write(yaml.dump(conf, default_flow_style=False))'
```

2. Set the IP range of the machine network. For example, to set the range to **172.16.0.0/16**, enter:

```
$ python3 -c 'import os, yaml
path = "%s/install-config.yaml" % os.environ["ASSETS_DIR"]
conf = yaml.safe_load(open(path))
conf["networking"]["machineNetwork"][0]["cidr"] = "172.16.0.0/16"
open(path, "w").write(yaml.dump(conf, default_flow_style=False))'
```

3. Remove the **ovirt** section and change the platform to **none**:

```
$ python3 -c 'import os, yaml
path = "%s/install-config.yaml" % os.environ["ASSETS_DIR"]
conf = yaml.safe_load(open(path))
platform = conf["platform"]
del platform["ovirt"]
platform["none"] = {}
open(path, "w").write(yaml.dump(conf, default_flow_style=False))'
```



### WARNING

Red Hat Virtualization does not currently support installation with user-provisioned infrastructure on the oVirt platform. Therefore, you must set the platform to **none**, allowing OpenShift Container Platform to identify each node as a bare-metal node and the cluster as a bare-metal cluster. This is the same as [installing a cluster on any platform](#), and has the following limitations:

1. There will be no cluster provider so you must manually add each machine and there will be no node scaling capabilities.
2. The oVirt CSI driver will not be installed and there will be no CSI capabilities.

## 19.4.15. Generate manifest files

Use the installation program to generate a set of manifest files in the assets directory.

The command to generate the manifest files displays a warning message before it consumes the **install-config.yaml** file.

If you plan to reuse the **install-config.yaml** file, create a backup copy of it before you back it up before you generate the manifest files.

### Procedure

1. Optional: Create a backup copy of the **install-config.yaml** file:

```
$ cp install-config.yaml install-config.yaml.backup
```

2. Generate a set of manifests in your assets directory:

```
$ openshift-install create manifests --dir $ASSETS_DIR
```

This command displays the following messages.

### Example output

INFO Consuming Install Config from target directory  
 WARNING Making control-plane schedulable by setting MastersSchedulable to true for Scheduler cluster settings

The command generates the following manifest files:

### Example output

```
$ tree
.
├── wrk
│   ├── manifests
│   │   ├── 04-openshift-machine-config-operator.yaml
│   │   ├── cluster-config.yaml
│   │   ├── cluster-dns-02-config.yml
│   │   ├── cluster-infrastructure-02-config.yml
│   │   ├── cluster-ingress-02-config.yml
│   │   ├── cluster-network-01-crd.yml
│   │   ├── cluster-network-02-config.yml
│   │   ├── cluster-proxy-01-config.yaml
│   │   ├── cluster-scheduler-02-config.yml
│   │   ├── cvo-overrides.yaml
│   │   ├── etcd-ca-bundle-configmap.yaml
│   │   ├── etcd-client-secret.yaml
│   │   ├── etcd-host-service-endpoints.yaml
│   │   ├── etcd-host-service.yaml
│   │   ├── etcd-metric-client-secret.yaml
│   │   ├── etcd-metric-serving-ca-configmap.yaml
│   │   ├── etcd-metric-signer-secret.yaml
│   │   ├── etcd-namespace.yaml
│   │   ├── etcd-service.yaml
│   │   ├── etcd-serving-ca-configmap.yaml
│   │   ├── etcd-signer-secret.yaml
│   │   ├── kube-cloud-config.yaml
│   │   ├── kube-system-configmap-root-ca.yaml
│   │   ├── machine-config-server-tls-secret.yaml
│   │   └── openshift-config-secret-pull-secret.yaml
│   └── openshift
│       ├── 99_kubeadmin-password-secret.yaml
│       ├── 99_openshift-cluster-api_master-user-data-secret.yaml
│       ├── 99_openshift-cluster-api_worker-user-data-secret.yaml
│       ├── 99_openshift-machineconfig_99-master-ssh.yaml
│       ├── 99_openshift-machineconfig_99-worker-ssh.yaml
│       └── openshift-install-manifests.yaml
```

### Next steps

- Make control plane nodes non-schedulable.

### 19.4.16. Making control-plane nodes non-schedulable

Because you are manually creating and deploying the control plane machines, you must configure a manifest file to make the control plane nodes non-schedulable.

#### Procedure

**Procedure**

1. To make the control plane nodes non-schedulable, enter:

```
$ python3 -c 'import os, yaml
path = "%s/manifests/cluster-scheduler-02-config.yml" % os.environ["ASSETS_DIR"]
data = yaml.safe_load(open(path))
data["spec"]["mastersSchedulable"] = False
open(path, "w").write(yaml.dump(data, default_flow_style=False))'
```

**19.4.17. Building the Ignition files**

To build the Ignition files from the manifest files you just generated and modified, you run the installation program. This action creates a Red Hat Enterprise Linux CoreOS (RHCOS) machine, **initramfs**, which fetches the Ignition files and performs the configurations needed to create a node.

In addition to the Ignition files, the installation program generates the following:

- An **auth** directory that contains the admin credentials for connecting to the cluster with the **oc** and **kubectl** utilities.
- A **metadata.json** file that contains information such as the OpenShift Container Platform cluster name, cluster ID, and infrastructure ID for the current installation.

The Ansible playbooks for this installation process use the value of **infralD** as a prefix for the virtual machines they create. This prevents naming conflicts when there are multiple installations in the same oVirt/RHV cluster.

**NOTE**

Certificates in Ignition configuration files expire after 24 hours. Complete the cluster installation and keep the cluster running in a non-degraded state for 24 hours so that the first certificate rotation can finish.

**Procedure**

1. To build the Ignition files, enter:

```
$ openshift-install create ignition-configs --dir $ASSETS_DIR
```

**Example output**

```
$ tree
.
├── wrk
│   ├── auth
│   │   ├── kubeadmin-password
│   │   └── kubeconfig
│   ├── bootstrap.ign
│   ├── master.ign
│   ├── metadata.json
│   └── worker.ign
```

**19.4.18. Creating templates and virtual machines**



After confirming the variables in the **inventory.yml**, you run the first Ansible provisioning playbook, **create-templates-and-vms.yml**.

This playbook uses the connection parameters for the RHV Manager from **\$HOME/.ovirt/ovirt-config.yml** and reads **metadata.json** in the assets directory.

If a local Red Hat Enterprise Linux CoreOS (RHCOS) image is not already present, the playbook downloads one from the URL you specified for **image\_url** in **inventory.yml**. It extracts the image and uploads it to RHV to create templates.

The playbook creates a template based on the **control\_plane** and **compute** profiles in the **inventory.yml** file. If these profiles have different names, it creates two templates.

When the playbook finishes, the virtual machines it creates are stopped. You can get information from them to help configure other infrastructure elements. For example, you can get the virtual machines' MAC addresses to configure DHCP to assign permanent IP addresses to the virtual machines.

### Procedure

1. In **inventory.yml**, under the **control\_plane** and **compute** variables, change both instances of **type: high\_performance** to **type: server**.
2. Optional: If you plan to perform multiple installations to the same cluster, create different templates for each OpenShift Container Platform installation. In the **inventory.yml** file, prepend the value of **template** with **infracID**. For example:

```
control_plane:
  cluster: "{{ ovirt_cluster }}"
  memory: 16GiB
  sockets: 4
  cores: 1
  template: "{{ metadata.infracID }}-rhcos_tpl"
  operating_system: "rhcos_x64"
  ...
```

3. Create the templates and virtual machines:

```
$ ansible-playbook -i inventory.yml create-templates-and-vms.yml
```

### 19.4.19. Creating the bootstrap machine

You create a bootstrap machine by running the **bootstrap.yml** playbook. This playbook starts the bootstrap virtual machine, and passes it the **bootstrap.ign** Ignition file from the assets directory. The bootstrap node configures itself so it can serve Ignition files to the control plane nodes.

To monitor the bootstrap process, you use the console in the RHV Administration Portal or connect to the virtual machine by using SSH.

### Procedure

1. Create the bootstrap machine:

```
$ ansible-playbook -i inventory.yml bootstrap.yml
```

2. Connect to the bootstrap machine using a console in the Administration Portal or SSH. Replace **<bootstrap\_ip>** with the bootstrap node IP address. To use SSH, enter:

```
$ ssh core@<bootstrap.ip>
```

3. Collect **bootkube.service** journald unit logs for the release image service from the bootstrap node:

```
[core@ocp4-1k6b4-bootstrap ~]$ journalctl -b -f -u release-image.service -u bootkube.service
```



#### NOTE

The **bootkube.service** log on the bootstrap node outputs etcd **connection refused** errors, indicating that the bootstrap server is unable to connect to etcd on control plane nodes. After etcd has started on each control plane node and the nodes have joined the cluster, the errors should stop.

### 19.4.20. Creating the control plane nodes

You create the control plane nodes by running the **masters.yml** playbook. This playbook passes the **master.ign** Ignition file to each of the virtual machines. The Ignition file contains a directive for the control plane node to get the Ignition from a URL such as <https://api-int.ocp4.example.org:22623/config/master>. The port number in this URL is managed by the load balancer, and is accessible only inside the cluster.

#### Procedure

1. Create the control plane nodes:

```
$ ansible-playbook -i inventory.yml masters.yml
```

2. While the playbook creates your control plane, monitor the bootstrapping process:

```
$ openshift-install wait-for bootstrap-complete --dir $ASSETS_DIR
```

#### Example output

```
INFO API v1.23.0 up
INFO Waiting up to 40m0s for bootstrapping to complete...
```

3. When all the pods on the control plane nodes and etcd are up and running, the installation program displays the following output.

#### Example output

```
INFO It is now safe to remove the bootstrap resources
```

### 19.4.21. Verifying cluster status

You can verify your OpenShift Container Platform cluster's status during or after installation.

## Procedure

1. In the cluster environment, export the administrator's kubeconfig file:

```
$ export KUBECONFIG=$ASSETS_DIR/auth/kubeconfig
```

The **kubeconfig** file contains information about the cluster that is used by the CLI to connect a client to the correct cluster and API server.

2. View the control plane and compute machines created after a deployment:

```
$ oc get nodes
```

3. View your cluster's version:

```
$ oc get clusterversion
```

4. View your Operators' status:

```
$ oc get clusteroperator
```

5. View all running pods in the cluster:

```
$ oc get pods -A
```

### 19.4.22. Removing the bootstrap machine

After the **wait-for** command shows that the bootstrap process is complete, you must remove the bootstrap virtual machine to free up compute, memory, and storage resources. Also, remove settings for the bootstrap machine from the load balancer directives.

## Procedure

1. To remove the bootstrap machine from the cluster, enter:

```
$ ansible-playbook -i inventory.yml retire-bootstrap.yml
```

2. Remove settings for the bootstrap machine from the load balancer directives.

### 19.4.23. Creating the worker nodes and completing the installation

Creating worker nodes is similar to creating control plane nodes. However, worker nodes workers do not automatically join the cluster. To add them to the cluster, you review and approve the workers' pending CSRs (Certificate Signing Requests).

After approving the first requests, you continue approving CSR until all of the worker nodes are approved. When you complete this process, the worker nodes become **Ready** and can have pods scheduled to run on them.

Finally, monitor the command line to see when the installation process completes.

## Procedure

1. Create the worker nodes:

```
$ ansible-playbook -i inventory.yml workers.yml
```

2. To list all of the CSRs, enter:

```
$ oc get csr -A
```

Eventually, this command displays one CSR per node. For example:

### Example output

```
NAME          AGE  SIGNERNAME                                REQUESTOR
CONDITION
csr-2lnxd    63m  kubernetes.io/kubelet-serving             system:node:ocp4-1k6b4-
master0.ocp4.example.org                 Approved,Issued
csr-hff4q    64m  kubernetes.io/kube-apiserver-client-kubelet
system:serviceaccount:openshift-machine-config-operator:node-bootstrapper
Approved,Issued
csr-hsn96    60m  kubernetes.io/kubelet-serving             system:node:ocp4-1k6b4-
master2.ocp4.example.org                 Approved,Issued
csr-m724n    6m2s kubernetes.io/kube-apiserver-client-kubelet
system:serviceaccount:openshift-machine-config-operator:node-bootstrapper Pending
csr-p4dz2    60m  kubernetes.io/kube-apiserver-client-kubelet
system:serviceaccount:openshift-machine-config-operator:node-bootstrapper
Approved,Issued
csr-t9vfj    60m  kubernetes.io/kubelet-serving             system:node:ocp4-1k6b4-
master1.ocp4.example.org                 Approved,Issued
csr-tggtr    61m  kubernetes.io/kube-apiserver-client-kubelet
system:serviceaccount:openshift-machine-config-operator:node-bootstrapper
Approved,Issued
csr-wcbrf    7m6s kubernetes.io/kube-apiserver-client-kubelet
system:serviceaccount:openshift-machine-config-operator:node-bootstrapper Pending
```

3. To filter the list and see only pending CSRs, enter:

```
$ watch "oc get csr -A | grep pending -i"
```

This command refreshes the output every two seconds and displays only pending CSRs. For example:

### Example output

```
Every 2.0s: oc get csr -A | grep pending -i

csr-m724n    10m  kubernetes.io/kube-apiserver-client-kubelet
system:serviceaccount:openshift-machine-config-operator:node-bootstrapper Pending
csr-wcbrf    11m  kubernetes.io/kube-apiserver-client-kubelet
system:serviceaccount:openshift-machine-config-operator:node-bootstrapper Pending
```

4. Inspect each pending request. For example:

### Example output

```
$ oc describe csr csr-m724n
```

### Example output

```
Name:          csr-m724n
Labels:        <none>
Annotations:   <none>
CreationTimestamp: Sun, 19 Jul 2020 15:59:37 +0200
Requesting User: system:serviceaccount:openshift-machine-config-operator:node-
bootstrapper
Signer:        kubernetes.io/kube-apiserver-client-kubelet
Status:        Pending
Subject:
  Common Name:  system:node:ocp4-1k6b4-worker1.ocp4.example.org
  Serial Number:
  Organization: system:nodes
Events: <none>
```

5. If the CSR information is correct, approve the request:

```
$ oc adm certificate approve csr-m724n
```

6. Wait for the installation process to finish:

```
$ openshift-install wait-for install-complete --dir $ASSETS_DIR --log-level debug
```

When the installation completes, the command line displays the URL of the OpenShift Container Platform web console and the administrator user name and password.

## 19.4.24. Telemetry access for OpenShift Container Platform

In OpenShift Container Platform 4.10, the Telemetry service, which runs by default to provide metrics about cluster health and the success of updates, requires internet access. If your cluster is connected to the internet, Telemetry runs automatically, and your cluster is registered to [OpenShift Cluster Manager](#).

After you confirm that your [OpenShift Cluster Manager](#) inventory is correct, either maintained automatically by Telemetry or manually by using OpenShift Cluster Manager, [use subscription watch](#) to track your OpenShift Container Platform subscriptions at the account or multi-cluster level.

### Additional resources

- See [About remote health monitoring](#) for more information about the Telemetry service

## 19.5. INSTALLING A CLUSTER ON RHV IN A RESTRICTED NETWORK

In OpenShift Container Platform version 4.10, you can install a customized OpenShift Container Platform cluster on Red Hat Virtualization (RHV) in a restricted network by creating an internal mirror of the installation release content.

### 19.5.1. Prerequisites

The following items are required to install an OpenShift Container Platform cluster on a RHV environment.

- You reviewed details about the [OpenShift Container Platform installation and update](#) processes.
- You read the documentation on [selecting a cluster installation method and preparing it for users](#).
- You have a supported combination of versions in the [Support Matrix for OpenShift Container Platform on RHV](#).
- You [created a registry on your mirror host](#) and obtained the **imageContentSources** data for your version of OpenShift Container Platform.

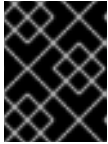

### IMPORTANT

Because the installation media is on the mirror host, you can use that computer to complete all installation steps.

- You provisioned [persistent storage](#) for your cluster. To deploy a private image registry, your storage must provide ReadWriteMany access modes.
- If you use a firewall and plan to use the Telemetry service, you [configured the firewall to allow the sites](#) that your cluster requires access to.



### NOTE

Be sure to also review this site list if you are configuring a proxy.

## 19.5.2. About installations in restricted networks

In OpenShift Container Platform 4.10, you can perform an installation that does not require an active connection to the internet to obtain software components. Restricted network installations can be completed using installer-provisioned infrastructure or user-provisioned infrastructure, depending on the cloud platform to which you are installing the cluster.

If you choose to perform a restricted network installation on a cloud platform, you still require access to its cloud APIs. Some cloud functions, like Amazon Web Service's Route 53 DNS and IAM services, require internet access. Depending on your network, you might require less internet access for an installation on bare metal hardware or on VMware vSphere.

To complete a restricted network installation, you must create a registry that mirrors the contents of the OpenShift image registry and contains the installation media. You can create this registry on a mirror host, which can access both the internet and your closed network, or by using other methods that meet your restrictions.

### 19.5.2.1. Additional limits

Clusters in restricted networks have the following additional limitations and restrictions:

- The **ClusterVersion** status includes an **Unable to retrieve available updates** error.
- By default, you cannot use the contents of the Developer Catalog because you cannot access the required image stream tags.

## 19.5.3. Internet access for OpenShift Container Platform

In OpenShift Container Platform 4.10, you require access to the internet to obtain the images that are necessary to install your cluster.

You must have internet access to:

- Access [OpenShift Cluster Manager](#) to download the installation program and perform subscription management. If the cluster has internet access and you do not disable Telemetry, that service automatically entitles your cluster.
- Access [Quay.io](#) to obtain the packages that are required to install your cluster.
- Obtain the packages that are required to perform cluster updates.

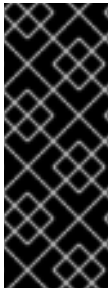

### IMPORTANT

If your cluster cannot have direct internet access, you can perform a restricted network installation on some types of infrastructure that you provision. During that process, you download the required content and use it to populate a mirror registry with the installation packages. With some installation types, the environment that you install your cluster in will not require internet access. Before you update the cluster, you update the content of the mirror registry.

#### 19.5.4. Requirements for the RHV environment

To install and run an OpenShift Container Platform version 4.10 cluster, the RHV environment must meet the following requirements.

Not meeting these requirements can cause the installation or process to fail. Additionally, not meeting these requirements can cause the OpenShift Container Platform cluster to fail days or weeks after installation.

The following requirements for CPU, memory, and storage resources are based on **default** values multiplied by the default number of virtual machines the installation program creates. These resources must be available **in addition to** what the RHV environment uses for non-OpenShift Container Platform operations.

By default, the installation program creates seven virtual machines during the installation process. First, it creates a bootstrap virtual machine to provide temporary services and a control plane while it creates the rest of the OpenShift Container Platform cluster. When the installation program finishes creating the cluster, deleting the bootstrap machine frees up its resources.

If you increase the number of virtual machines in the RHV environment, you must increase the resources accordingly.

#### Requirements

- The RHV version is 4.4.
- The RHV environment has one data center whose state is **Up**.
- The RHV data center contains an RHV cluster.
- The RHV cluster has the following resources exclusively for the OpenShift Container Platform cluster:
  - Minimum 28 vCPUs: four for each of the seven virtual machines created during installation.

- 112 GiB RAM or more, including:
  - 16 GiB or more for the bootstrap machine, which provides the temporary control plane.
  - 16 GiB or more for each of the three control plane machines which provide the control plane.
  - 16 GiB or more for each of the three compute machines, which run the application workloads.
- The RHV storage domain must meet [these etcd backend performance requirements](#).
- In production environments, each virtual machine must have 120 GiB or more. Therefore, the storage domain must provide 840 GiB or more for the default OpenShift Container Platform cluster. In resource-constrained or non-production environments, each virtual machine must have 32 GiB or more, so the storage domain must have 230 GiB or more for the default OpenShift Container Platform cluster.
- To download images from the Red Hat Ecosystem Catalog during installation and update procedures, the RHV cluster must have access to an internet connection. The Telemetry service also needs an internet connection to simplify the subscription and entitlement process.
- The RHV cluster must have a virtual network with access to the REST API on the RHV Manager. Ensure that DHCP is enabled on this network, because the VMs that the installer creates obtain their IP address by using DHCP.
- A user account and group with the following least privileges for installing and managing an OpenShift Container Platform cluster on the target RHV cluster:
  - **DiskOperator**
  - **DiskCreator**
  - **UserTemplateBasedVm**
  - **TemplateOwner**
  - **TemplateCreator**
  - **ClusterAdmin** on the target cluster



#### WARNING

Apply the principle of least privilege: Avoid using an administrator account with **SuperUser** privileges on RHV during the installation process. The installation program saves the credentials you provide to a temporary **ovirt-config.yaml** file that might be compromised.

### 19.5.5. Verifying the requirements for the RHV environment

Verify that the RHV environment meets the requirements to install and run an OpenShift Container Platform cluster. Not meeting these requirements can cause failures.



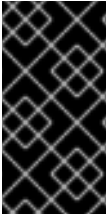

## IMPORTANT

These requirements are based on the default resources the installation program uses to create control plane and compute machines. These resources include vCPUs, memory, and storage. If you change these resources or increase the number of OpenShift Container Platform machines, adjust these requirements accordingly.

### Procedure

1. Check that the RHV version supports installation of OpenShift Container Platform version 4.10.
  - a. In the RHV Administration Portal, click the ? help icon in the upper-right corner and select **About**.
  - b. In the window that opens, make a note of the **RHV Software Version**
  - c. Confirm that the RHV version is 4.4. For more information about supported version combinations, see [Support Matrix for OpenShift Container Platform on RHV](#).
2. Inspect the data center, cluster, and storage.
  - a. In the RHV Administration Portal, click **Compute → Data Centers**.
  - b. Confirm that the data center where you plan to install OpenShift Container Platform is accessible.
  - c. Click the name of that data center.
  - d. In the data center details, on the **Storage** tab, confirm the storage domain where you plan to install OpenShift Container Platform is **Active**.
  - e. Record the **Domain Name** for use later on.
  - f. Confirm **Free Space** has at least 230 GiB.
  - g. Confirm that the storage domain meets [these etcd backend performance requirements](#), which you [can measure by using the fio performance benchmarking tool](#).
  - h. In the data center details, click the **Clusters** tab.
  - i. Find the RHV cluster where you plan to install OpenShift Container Platform. Record the cluster name for use later on.
3. Inspect the RHV host resources.
  - a. In the RHV Administration Portal, click **Compute > Clusters**.
  - b. Click the cluster where you plan to install OpenShift Container Platform.
  - c. In the cluster details, click the **Hosts** tab.
  - d. Inspect the hosts and confirm they have a combined total of at least 28 **Logical CPU Cores** available *exclusively* for the OpenShift Container Platform cluster.
  - e. Record the number of available **Logical CPU Cores** for use later on.
  - f. Confirm that these CPU cores are distributed so that each of the seven virtual machines created during installation can have four cores.

- g. Confirm that, all together, the hosts have 112 GiB of **Max free Memory for scheduling new virtual machines** distributed to meet the requirements for each of the following OpenShift Container Platform machines:
    - 16 GiB required for the bootstrap machine
    - 16 GiB required for each of the three control plane machines
    - 16 GiB for each of the three compute machines
  - h. Record the amount of **Max free Memory for scheduling new virtual machines** for use later on.
4. Verify that the virtual network for installing OpenShift Container Platform has access to the RHV Manager's REST API. From a virtual machine on this network, use curl to reach the RHV Manager's REST API:

```
$ curl -k -u <username>@<profile>:<password> \ 1  
https://<engine-fqdn>/ovirt-engine/api 2
```

- 1 For **<username>**, specify the user name of an RHV account with privileges to create and manage an OpenShift Container Platform cluster on RHV. For **<profile>**, specify the login profile, which you can get by going to the RHV Administration Portal login page and reviewing the **Profile** dropdown list. For **<password>**, specify the password for that user name.

- 2 For **<engine-fqdn>**, specify the fully qualified domain name of the RHV environment.

For example:

```
$ curl -k -u ocpadmin@internal:pw123 \  
https://rhv-env.virtlab.example.com/ovirt-engine/api
```

### 19.5.6. Networking requirements for user-provisioned infrastructure

All the Red Hat Enterprise Linux CoreOS (RHCOS) machines require networking to be configured in **initramfs** during boot to fetch their Ignition config files.

During the initial boot, the machines require an IP address configuration that is set either through a DHCP server or statically by providing the required boot options. After a network connection is established, the machines download their Ignition config files from an HTTP or HTTPS server. The Ignition config files are then used to set the exact state of each machine. The Machine Config Operator completes more changes to the machines, such as the application of new certificates or keys, after installation.

It is recommended to use a DHCP server for long-term management of the cluster machines. Ensure that the DHCP server is configured to provide persistent IP addresses, DNS server information, and hostnames to the cluster machines.



## NOTE

If a DHCP service is not available for your user-provisioned infrastructure, you can instead provide the IP networking configuration and the address of the DNS server to the nodes at RHCOS install time. These can be passed as boot arguments if you are installing from an ISO image. See the *Installing RHCOS and starting the OpenShift Container Platform bootstrap process* section for more information about static IP provisioning and advanced networking options.

The Kubernetes API server must be able to resolve the node names of the cluster machines. If the API servers and worker nodes are in different zones, you can configure a default DNS search zone to allow the API server to resolve the node names. Another supported approach is to always refer to hosts by their fully-qualified domain names in both the node objects and all DNS requests.

## Firewall

Configure your firewall so your cluster has access to required sites.

See also:

- [Red Hat Virtualization Manager firewall requirements](#)
- [Host firewall requirements](#)

## DNS

Configure infrastructure-provided DNS to allow the correct resolution of the main components and services. If you use only one load balancer, these DNS records can point to the same IP address.

- Create DNS records for **api.<cluster\_name>.<base\_domain>** (internal and external resolution) and **api-int.<cluster\_name>.<base\_domain>** (internal resolution) that point to the load balancer for the control plane machines.
- Create a DNS record for **\*.apps.<cluster\_name>.<base\_domain>** that points to the load balancer for the Ingress router. For example, ports **443** and **80** of the compute machines.

### 19.5.6.1. Setting the cluster node hostnames through DHCP

On Red Hat Enterprise Linux CoreOS (RHCOS) machines, the hostname is set through NetworkManager. By default, the machines obtain their hostname through DHCP. If the hostname is not provided by DHCP, set statically through kernel arguments, or another method, it is obtained through a reverse DNS lookup. Reverse DNS lookup occurs after the network has been initialized on a node and can take time to resolve. Other system services can start prior to this and detect the hostname as **localhost** or similar. You can avoid this by using DHCP to provide the hostname for each cluster node.

Additionally, setting the hostnames through DHCP can bypass any manual DNS record name configuration errors in environments that have a DNS split-horizon implementation.

### 19.5.6.2. Network connectivity requirements

You must configure the network connectivity between machines to allow OpenShift Container Platform cluster components to communicate. Each machine must be able to resolve the hostnames of all other machines in the cluster.

This section provides details about the ports that are required.

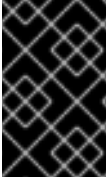

## IMPORTANT

In connected OpenShift Container Platform environments, all nodes are required to have internet access to pull images for platform containers and provide telemetry data to Red Hat.

**Table 19.9. Ports used for all-machine to all-machine communications**

Protocol	Port	Description
ICMP	N/A	Network reachability tests
TCP	<b>1936</b>	Metrics
	<b>9000-9999</b>	Host level services, including the node exporter on ports <b>9100-9101</b> and the Cluster Version Operator on port <b>9099</b> .
	<b>10250-10259</b>	The default ports that Kubernetes reserves
	<b>10256</b>	openshift-sdn
UDP	<b>4789</b>	VXLAN
	<b>6081</b>	Geneve
	<b>9000-9999</b>	Host level services, including the node exporter on ports <b>9100-9101</b> .
	<b>500</b>	IPsec IKE packets
	<b>4500</b>	IPsec NAT-T packets
TCP/UDP	<b>30000-32767</b>	Kubernetes node port
ESP	N/A	IPsec Encapsulating Security Payload (ESP)

**Table 19.10. Ports used for all-machine to control plane communications**

Protocol	Port	Description
TCP	<b>6443</b>	Kubernetes API

**Table 19.11. Ports used for control plane machine to control plane machine communications**

Protocol	Port	Description
TCP	<b>2379-2380</b>	etcd server and peer ports

### NTP configuration for user-provisioned infrastructure

OpenShift Container Platform clusters are configured to use a public Network Time Protocol (NTP) server by default. If you want to use a local enterprise NTP server, or if your cluster is being deployed in a disconnected network, you can configure the cluster to use a specific time server. For more information, see the documentation for *Configuring chrony time service*.

If a DHCP server provides NTP server information, the chrony time service on the Red Hat Enterprise Linux CoreOS (RHCOS) machines read the information and can sync the clock with the NTP servers.

### 19.5.7. User-provisioned DNS requirements

In OpenShift Container Platform deployments, DNS name resolution is required for the following components:

- The Kubernetes API
- The OpenShift Container Platform application wildcard
- The bootstrap, control plane, and compute machines

Reverse DNS resolution is also required for the Kubernetes API, the bootstrap machine, the control plane machines, and the compute machines.

DNS A/AAAA or CNAME records are used for name resolution and PTR records are used for reverse name resolution. The reverse records are important because Red Hat Enterprise Linux CoreOS (RHCOS) uses the reverse records to set the hostnames for all the nodes, unless the hostnames are provided by DHCP. Additionally, the reverse records are used to generate the certificate signing requests (CSR) that OpenShift Container Platform needs to operate.



#### NOTE

It is recommended to use a DHCP server to provide the hostnames to each cluster node. See the *DHCP recommendations for user-provisioned infrastructure* section for more information.

The following DNS records are required for a user-provisioned OpenShift Container Platform cluster and they must be in place before installation. In each record, **<cluster\_name>** is the cluster name and **<base\_domain>** is the base domain that you specify in the **install-config.yaml** file. A complete DNS record takes the form: **<component>.<cluster\_name>.<base\_domain>..**

**Table 19.12. Required DNS records**

Component	Record	Description
Kubernetes API	<b>api.&lt;cluster_name&gt;.&lt;base_domain&gt;..</b>	A DNS A/AAAA or CNAME record, and a DNS PTR record, to identify the API load balancer. These records must be resolvable by both clients external to the cluster and from all the nodes within the cluster.

Component	Record	Description
	<b>api-int.&lt;cluster_name&gt;.&lt;base_domain&gt;.</b>	<p>A DNS A/AAAA or CNAME record, and a DNS PTR record, to internally identify the API load balancer. These records must be resolvable from all the nodes within the cluster.</p> <div style="display: flex; align-items: flex-start;">  <div> <p><b>IMPORTANT</b></p> <p>The API server must be able to resolve the worker nodes by the hostnames that are recorded in Kubernetes. If the API server cannot resolve the node names, then proxied API calls can fail, and you cannot retrieve logs from pods.</p> </div> </div>
Routes	<b>*.apps.&lt;cluster_name&gt;.&lt;base_domain&gt;.</b>	<p>A wildcard DNS A/AAAA or CNAME record that refers to the application ingress load balancer. The application ingress load balancer targets the machines that run the Ingress Controller pods. The Ingress Controller pods run on the compute machines by default. These records must be resolvable by both clients external to the cluster and from all the nodes within the cluster.</p> <p>For example, <b>console-openshift-console.apps.&lt;cluster_name&gt;.&lt;base_domain&gt;</b> is used as a wildcard route to the OpenShift Container Platform console.</p>
Bootstrap machine	<b>bootstrap.&lt;cluster_name&gt;.&lt;base_domain&gt;.</b>	A DNS A/AAAA or CNAME record, and a DNS PTR record, to identify the bootstrap machine. These records must be resolvable by the nodes within the cluster.
Control plane machines	<b>&lt;master&gt;&lt;n&gt;.&lt;cluster_name&gt;.&lt;base_domain&gt;.</b>	DNS A/AAAA or CNAME records and DNS PTR records to identify each machine for the control plane nodes. These records must be resolvable by the nodes within the cluster.
Compute machines	<b>&lt;worker&gt;&lt;n&gt;.&lt;cluster_name&gt;.&lt;base_domain&gt;.</b>	DNS A/AAAA or CNAME records and DNS PTR records to identify each machine for the worker nodes. These records must be resolvable by the nodes within the cluster.



#### NOTE

In OpenShift Container Platform 4.4 and later, you do not need to specify etcd host and SRV records in your DNS configuration.

#### TIP

You can use the **dig** command to verify name and reverse name resolution. See the section on *Validating DNS resolution for user-provisioned infrastructure* for detailed validation steps.

### 19.5.7.1. Example DNS configuration for user-provisioned clusters

This section provides A and PTR record configuration samples that meet the DNS requirements for deploying OpenShift Container Platform on user-provisioned infrastructure. The samples are not meant to provide advice for choosing one DNS solution over another.

In the examples, the cluster name is **ocp4** and the base domain is **example.com**.

#### Example DNS A record configuration for a user-provisioned cluster

The following example is a BIND zone file that shows sample A records for name resolution in a user-provisioned cluster.

##### Example 19.1. Sample DNS zone database

```
$TTL 1W
@ IN SOA ns1.example.com. root (
  2019070700 ; serial
  3H ; refresh (3 hours)
  30M ; retry (30 minutes)
  2W ; expiry (2 weeks)
  1W ) ; minimum (1 week)
IN NS ns1.example.com.
IN MX 10 smtp.example.com.
;
;
ns1.example.com. IN A 192.168.1.5
smtp.example.com. IN A 192.168.1.5
;
helper.example.com. IN A 192.168.1.5
helper.ocp4.example.com. IN A 192.168.1.5
;
api.ocp4.example.com. IN A 192.168.1.5 1
api-int.ocp4.example.com. IN A 192.168.1.5 2
;
*.apps.ocp4.example.com. IN A 192.168.1.5 3
;
bootstrap.ocp4.example.com. IN A 192.168.1.96 4
;
master0.ocp4.example.com. IN A 192.168.1.97 5
master1.ocp4.example.com. IN A 192.168.1.98 6
master2.ocp4.example.com. IN A 192.168.1.99 7
;
worker0.ocp4.example.com. IN A 192.168.1.11 8
worker1.ocp4.example.com. IN A 192.168.1.7 9
;
;EOF
```

- 1 Provides name resolution for the Kubernetes API. The record refers to the IP address of the API load balancer.
- 2 Provides name resolution for the Kubernetes API. The record refers to the IP address of the API load balancer and is used for internal cluster communications.
- 3 Provides name resolution for the wildcard routes. The record refers to the IP address of the application ingress load balancer. The application ingress load balancer targets the machines

application ingress load balancer. The application ingress load balancer targets the machines that run the Ingress Controller pods. The Ingress Controller pods run on the compute machines by default.



## NOTE

In the example, the same load balancer is used for the Kubernetes API and application ingress traffic. In production scenarios, you can deploy the API and application ingress load balancers separately so that you can scale the load balancer infrastructure for each in isolation.

- 4 Provides name resolution for the bootstrap machine.
- 5 6 7 Provides name resolution for the control plane machines.
- 8 9 Provides name resolution for the compute machines.

## Example DNS PTR record configuration for a user-provisioned cluster

The following example BIND zone file shows sample PTR records for reverse name resolution in a user-provisioned cluster.

### Example 19.2. Sample DNS zone database for reverse records

```
$TTL 1W
@ IN SOA ns1.example.com. root (
  2019070700 ; serial
  3H ; refresh (3 hours)
  30M ; retry (30 minutes)
  2W ; expiry (2 weeks)
  1W ) ; minimum (1 week)
IN NS ns1.example.com.
;
5.1.168.192.in-addr.arpa. IN PTR api.ocp4.example.com. 1
5.1.168.192.in-addr.arpa. IN PTR api-int.ocp4.example.com. 2
;
96.1.168.192.in-addr.arpa. IN PTR bootstrap.ocp4.example.com. 3
;
97.1.168.192.in-addr.arpa. IN PTR master0.ocp4.example.com. 4
98.1.168.192.in-addr.arpa. IN PTR master1.ocp4.example.com. 5
99.1.168.192.in-addr.arpa. IN PTR master2.ocp4.example.com. 6
;
11.1.168.192.in-addr.arpa. IN PTR worker0.ocp4.example.com. 7
7.1.168.192.in-addr.arpa. IN PTR worker1.ocp4.example.com. 8
;
;EOF
```

- 1 Provides reverse DNS resolution for the Kubernetes API. The PTR record refers to the record name of the API load balancer.
- 2 Provides reverse DNS resolution for the Kubernetes API. The PTR record refers to the record name of the API load balancer and is used for internal cluster communications.

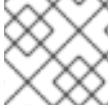

- 3 Provides reverse DNS resolution for the bootstrap machine.
- 4 5 6 Provides reverse DNS resolution for the control plane machines.
- 7 8 Provides reverse DNS resolution for the compute machines.

**NOTE**

A PTR record is not required for the OpenShift Container Platform application wildcard.

### 19.5.7.2. Load balancing requirements for user-provisioned infrastructure

Before you install OpenShift Container Platform, you must provision the API and application ingress load balancing infrastructure. In production scenarios, you can deploy the API and application ingress load balancers separately so that you can scale the load balancer infrastructure for each in isolation.

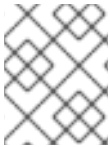
**NOTE**

If you want to deploy the API and application Ingress load balancers with a Red Hat Enterprise Linux (RHEL) instance, you must purchase the RHEL subscription separately.

The load balancing infrastructure must meet the following requirements:

1. **API load balancer.** Provides a common endpoint for users, both human and machine, to interact with and configure the platform. Configure the following conditions:
  - Layer 4 load balancing only. This can be referred to as Raw TCP, SSL Passthrough, or SSL Bridge mode. If you use SSL Bridge mode, you must enable Server Name Indication (SNI) for the API routes.
  - A stateless load balancing algorithm. The options vary based on the load balancer implementation.

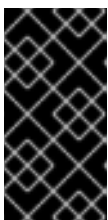
**IMPORTANT**

Do not configure session persistence for an API load balancer. Configuring session persistence for a Kubernetes API server might cause performance issues from excess application traffic for your OpenShift Container Platform cluster and the Kubernetes API that runs inside the cluster.

Configure the following ports on both the front and back of the load balancers:

**Table 19.13. API load balancer**

Port	Back-end machines (pool members)	Internal	External	Description
------	----------------------------------	----------	----------	-------------

Port	Back-end machines (pool members)	Internal	External	Description
<b>6443</b>	Bootstrap and control plane. You remove the bootstrap machine from the load balancer after the bootstrap machine initializes the cluster control plane. You must configure the <b>/readyz</b> endpoint for the API server health check probe.	X	X	Kubernetes API server
<b>22623</b>	Bootstrap and control plane. You remove the bootstrap machine from the load balancer after the bootstrap machine initializes the cluster control plane.	X		Machine config server

**NOTE**

The load balancer must be configured to take a maximum of 30 seconds from the time the API server turns off the **/readyz** endpoint to the removal of the API server instance from the pool. Within the time frame after **/readyz** returns an error or becomes healthy, the endpoint must have been removed or added. Probing every 5 or 10 seconds, with two successful requests to become healthy and three to become unhealthy, are well-tested values.

2. **Application Ingress load balancer.** Provides an ingress point for application traffic flowing in from outside the cluster. A working configuration for the Ingress router is required for an OpenShift Container Platform cluster.

Configure the following conditions:

- Layer 4 load balancing only. This can be referred to as Raw TCP, SSL Passthrough, or SSL Bridge mode. If you use SSL Bridge mode, you must enable Server Name Indication (SNI) for the ingress routes.
- A connection-based or session-based persistence is recommended, based on the options available and types of applications that will be hosted on the platform.

**TIP**

If the true IP address of the client can be seen by the application Ingress load balancer, enabling source IP-based session persistence can improve performance for applications that use end-to-end TLS encryption.

Configure the following ports on both the front and back of the load balancers:

**Table 19.14. Application Ingress load balancer**

Port	Back-end machines (pool members)	Internal	External	Description
<b>443</b>	The machines that run the Ingress Controller pods, compute, or worker, by default.	X	X	HTTPS traffic
<b>80</b>	The machines that run the Ingress Controller pods, compute, or worker, by default.	X	X	HTTP traffic

**NOTE**

If you are deploying a three-node cluster with zero compute nodes, the Ingress Controller pods run on the control plane nodes. In three-node cluster deployments, you must configure your application Ingress load balancer to route HTTP and HTTPS traffic to the control plane nodes.

**19.5.7.2.1. Example load balancer configuration for user-provisioned clusters**

This section provides an example API and application ingress load balancer configuration that meets the load balancing requirements for user-provisioned clusters. The sample is an `/etc/haproxy/haproxy.cfg` configuration for an HAProxy load balancer. The example is not meant to provide advice for choosing one load balancing solution over another.

In the example, the same load balancer is used for the Kubernetes API and application ingress traffic. In production scenarios, you can deploy the API and application ingress load balancers separately so that you can scale the load balancer infrastructure for each in isolation.

**NOTE**

If you are using HAProxy as a load balancer and SELinux is set to **enforcing**, you must ensure that the HAProxy service can bind to the configured TCP port by running **setsebool -P haproxy\_connect\_any=1**.

**Example 19.3. Sample API and application Ingress load balancer configuration**

```
global
  log      127.0.0.1 local2
  pidfile  /var/run/haproxy.pid
  maxconn 4000
  daemon
defaults
  mode          http
  log           global
  option        dontlognull
  option http-server-close
  option        redispatch
  retries       3
  timeout http-request 10s
  timeout queue 1m
  timeout connect 10s
```

```

timeout client      1m
timeout server     1m
timeout http-keep-alive 10s
timeout check      10s
maxconn            3000
listen api-server-6443 1
bind *:6443
mode tcp
server bootstrap bootstrap.ocp4.example.com:6443 check inter 1s backup 2
server master0 master0.ocp4.example.com:6443 check inter 1s
server master1 master1.ocp4.example.com:6443 check inter 1s
server master2 master2.ocp4.example.com:6443 check inter 1s
listen machine-config-server-22623 3
bind *:22623
mode tcp
server bootstrap bootstrap.ocp4.example.com:22623 check inter 1s backup 4
server master0 master0.ocp4.example.com:22623 check inter 1s
server master1 master1.ocp4.example.com:22623 check inter 1s
server master2 master2.ocp4.example.com:22623 check inter 1s
listen ingress-router-443 5
bind *:443
mode tcp
balance source
server worker0 worker0.ocp4.example.com:443 check inter 1s
server worker1 worker1.ocp4.example.com:443 check inter 1s
listen ingress-router-80 6
bind *:80
mode tcp
balance source
server worker0 worker0.ocp4.example.com:80 check inter 1s
server worker1 worker1.ocp4.example.com:80 check inter 1s

```

- 1** Port **6443** handles the Kubernetes API traffic and points to the control plane machines.
- 2** **4** The bootstrap entries must be in place before the OpenShift Container Platform cluster installation and they must be removed after the bootstrap process is complete.
- 3** Port **22623** handles the machine config server traffic and points to the control plane machines.
- 5** Port **443** handles the HTTPS traffic and points to the machines that run the Ingress Controller pods. The Ingress Controller pods run on the compute machines by default.
- 6** Port **80** handles the HTTP traffic and points to the machines that run the Ingress Controller pods. The Ingress Controller pods run on the compute machines by default.



#### NOTE

If you are deploying a three-node cluster with zero compute nodes, the Ingress Controller pods run on the control plane nodes. In three-node cluster deployments, you must configure your application Ingress load balancer to route HTTP and HTTPS traffic to the control plane nodes.

**TIP**

If you are using HAProxy as a load balancer, you can check that the **haproxy** process is listening on ports **6443**, **22623**, **443**, and **80** by running **netstat -nltpu** on the HAProxy node.

**19.5.8. Setting up the installation machine**

To run the binary **openshift-install** installation program and Ansible scripts, set up the RHV Manager or an Red Hat Enterprise Linux (RHEL) computer with network access to the RHV environment and the REST API on the Manager.

**Procedure**

1. Update or install Python3 and Ansible. For example:

```
# dnf update python3 ansible
```

2. Install the [python3-ovirt-engine-sdk4](#) package to get the Python Software Development Kit.
3. Install the **ovirt.image-template** Ansible role. On the RHV Manager and other Red Hat Enterprise Linux (RHEL) machines, this role is distributed as the **ovirt-ansible-image-template** package. For example, enter:

```
# dnf install ovirt-ansible-image-template
```

4. Install the **ovirt.vm-infra** Ansible role. On the RHV Manager and other RHEL machines, this role is distributed as the **ovirt-ansible-vm-infra** package.

```
# dnf install ovirt-ansible-vm-infra
```

5. Create an environment variable and assign an absolute or relative path to it. For example, enter:

```
$ export ASSETS_DIR=./wrk
```

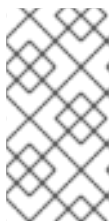
**NOTE**

The installation program uses this variable to create a directory where it saves important installation-related files. Later, the installation process reuses this variable to locate those asset files. Avoid deleting this assets directory; it is required for uninstalling the cluster.

**19.5.9. Setting up the CA certificate for RHV**

Download the CA certificate from the Red Hat Virtualization (RHV) Manager and set it up on the installation machine.

You can download the certificate from a webpage on the RHV Manager or by using a **curl** command.

Later, you provide the certificate to the installation program.

**Procedure**

1. Use either of these two methods to download the CA certificate:

- Go to the Manager's webpage, <https://<engine-fqdn>/ovirt-engine/>. Then, under **Downloads**, click the **CA Certificate** link.
- Run the following command:

```
$ curl -k 'https://<engine-fqdn>/ovirt-engine/services/pki-resource?resource=ca-certificate&format=X509-PEM-CA' -o /tmp/ca.pem 1
```

- 1** For **<engine-fqdn>**, specify the fully qualified domain name of the RHV Manager, such as **rhv-env.virtlab.example.com**.

2. Configure the CA file to grant rootless user access to the Manager. Set the CA file permissions to have an octal value of **0644** (symbolic value: **-rw-r--r--**):

```
$ sudo chmod 0644 /tmp/ca.pem
```

3. For Linux, copy the CA certificate to the directory for server certificates. Use **-p** to preserve the permissions:

```
$ sudo cp -p /tmp/ca.pem /etc/pki/ca-trust/source/anchors/ca.pem
```

4. Add the certificate to the certificate manager for your operating system:

- For macOS, double-click the certificate file and use the **Keychain Access** utility to add the file to the **System** keychain.
- For Linux, update the CA trust:

```
$ sudo update-ca-trust
```

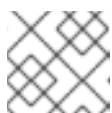

#### NOTE

If you use your own certificate authority, make sure the system trusts it.

#### Additional resources

- To learn more, see [Authentication and Security](#) in the RHV documentation.

### 19.5.10. Generating a key pair for cluster node SSH access

During an OpenShift Container Platform installation, you can provide an SSH public key to the installation program. The key is passed to the Red Hat Enterprise Linux CoreOS (RHCOS) nodes through their Ignition config files and is used to authenticate SSH access to the nodes. The key is added to the `~/.ssh/authorized_keys` list for the **core** user on each node, which enables password-less authentication.

After the key is passed to the nodes, you can use the key pair to SSH in to the RHCOS nodes as the user **core**. To access the nodes through SSH, the private key identity must be managed by SSH for your local user.

If you want to SSH in to your cluster nodes to perform installation debugging or disaster recovery, you must provide the SSH public key during the installation process. The `./openshift-install gather` command also requires the SSH public key to be in place on the cluster nodes.

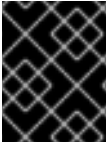
**IMPORTANT**

Do not skip this procedure in production environments, where disaster recovery and debugging is required.

**NOTE**

You must use a local key, not one that you configured with platform-specific approaches such as [AWS key pairs](#).

**Procedure**

1. If you do not have an existing SSH key pair on your local machine to use for authentication onto your cluster nodes, create one. For example, on a computer that uses a Linux operating system, run the following command:

```
$ ssh-keygen -t ed25519 -N "" -f <path>/<file_name> 1
```

- 1 Specify the path and file name, such as `~/.ssh/id_ed25519`, of the new SSH key. If you have an existing key pair, ensure your public key is in the your `~/.ssh` directory.

**NOTE**

If you plan to install an OpenShift Container Platform cluster that uses FIPS validated or Modules In Process cryptographic libraries on the **x86\_64** architecture, do not create a key that uses the **ed25519** algorithm. Instead, create a key that uses the **rsa** or **ecdsa** algorithm.

2. View the public SSH key:

```
$ cat <path>/<file_name>.pub
```

For example, run the following to view the `~/.ssh/id_ed25519.pub` public key:

```
$ cat ~/.ssh/id_ed25519.pub
```

3. Add the SSH private key identity to the SSH agent for your local user, if it has not already been added. SSH agent management of the key is required for password-less SSH authentication onto your cluster nodes, or if you want to use the `./openshift-install gather` command.

**NOTE**

On some distributions, default SSH private key identities such as `~/.ssh/id_rsa` and `~/.ssh/id_dsa` are managed automatically.

- a. If the **ssh-agent** process is not already running for your local user, start it as a background task:

```
$ eval "$(ssh-agent -s)"
```

**Example output**

```
Agent pid 31874
```

**NOTE**

If your cluster is in FIPS mode, only use FIPS-compliant algorithms to generate the SSH key. The key must be either RSA or ECDSA.

4. Add your SSH private key to the **ssh-agent**:

```
$ ssh-add <path>/<file_name> 1
```

- 1** Specify the path and file name for your SSH private key, such as `~/.ssh/id_ed25519`

**Example output**

```
Identity added: /home/<you>/<path>/<file_name> (<computer_name>)
```

**Next steps**

- When you install OpenShift Container Platform, provide the SSH public key to the installation program.

**19.5.11. Downloading the Ansible playbooks**

Download the Ansible playbooks for installing OpenShift Container Platform version 4.10 on RHV.

**Procedure**

- On your installation machine, run the following commands:

```
$ mkdir playbooks
```

```
$ cd playbooks
```

```
$ curl -s -L -X GET https://api.github.com/repos/openshift/installer/contents/upi/ovirt?
ref=release-4.10 |
grep 'download_url.*\.yml' |
awk '{ print $2 }' | sed -r 's/(\"|,)//g' |
xargs -n 1 curl -O
```

**Next steps**

- After you download these Ansible playbooks, you must also create the environment variable for the assets directory and customize the **inventory.yml** file before you create an installation configuration file by running the installation program.

**19.5.12. The inventory.yml file**

You use the **inventory.yml** file to define and create elements of the OpenShift Container Platform cluster you are installing. This includes elements such as the Red Hat Enterprise Linux CoreOS (RHCOS)



image, virtual machine templates, bootstrap machine, control plane nodes, and worker nodes. You also use **inventory.yml** to destroy the cluster.

The following **inventory.yml** example shows you the parameters and their default values. The quantities and numbers in these default values meet the requirements for running a production OpenShift Container Platform cluster in a RHV environment.

### Example inventory.yml file

```
---
all:
  vars:

    ovirt_cluster: "Default"
    ocp:
      assets_dir: "{{ lookup('env', 'ASSETS_DIR') }}"
      ovirt_config_path: "{{ lookup('env', 'HOME') }}/.ovirt/ovirt-config.yaml"

    # ---
    # {op-system} section
    # ---
    rhcos:
      image_url: "https://mirror.openshift.com/pub/openshift-v4/dependencies/rhcos/4.10/latest/rhcos-
openstack.x86_64.qcow2.gz"
      local_cmp_image_path: "/tmp/rhcos.qcow2.gz"
      local_image_path: "/tmp/rhcos.qcow2"

    # ---
    # Profiles section
    # ---
    control_plane:
      cluster: "{{ ovirt_cluster }}"
      memory: 16GiB
      sockets: 4
      cores: 1
      template: rhcos_tpl
      operating_system: "rhcos_x64"
      type: high_performance
      graphical_console:
        headless_mode: false
      protocol:
        - spice
        - vnc
      disks:
        - size: 120GiB
          name: os
          interface: virtio_scsi
          storage_domain: depot_nvme
      nics:
        - name: nic1
          network: lab
          profile: lab

    compute:
      cluster: "{{ ovirt_cluster }}"
      memory: 16GiB
```

```

sockets: 4
cores: 1
template: worker_rhcos_tpl
operating_system: "rhcos_x64"
type: high_performance
graphical_console:
  headless_mode: false
protocol:
- spice
- vnc
disks:
- size: 120GiB
  name: os
  interface: virtio_scsi
  storage_domain: depot_nvme
nics:
- name: nic1
  network: lab
  profile: lab

# ---
# Virtual machines section
# ---
vms:
- name: "{{ metadata.infraID }}-bootstrap"
  ocp_type: bootstrap
  profile: "{{ control_plane }}"
  type: server
- name: "{{ metadata.infraID }}-master0"
  ocp_type: master
  profile: "{{ control_plane }}"
- name: "{{ metadata.infraID }}-master1"
  ocp_type: master
  profile: "{{ control_plane }}"
- name: "{{ metadata.infraID }}-master2"
  ocp_type: master
  profile: "{{ control_plane }}"
- name: "{{ metadata.infraID }}-worker0"
  ocp_type: worker
  profile: "{{ compute }}"
- name: "{{ metadata.infraID }}-worker1"
  ocp_type: worker
  profile: "{{ compute }}"
- name: "{{ metadata.infraID }}-worker2"
  ocp_type: worker
  profile: "{{ compute }}"

```

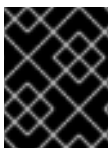

### IMPORTANT

Enter values for parameters whose descriptions begin with "Enter." Otherwise, you can use the default value or replace it with a new value.

### General section

- **ovirt\_cluster**: Enter the name of an existing RHV cluster in which to install the OpenShift Container Platform cluster.
- **ocp.assets\_dir**: The path of a directory the **openshift-install** installation program creates to store the files that it generates.
- **ocp.ovirt\_config\_path**: The path of the **ovirt-config.yaml** file the installation program generates, for example, **./wrk/install-config.yaml**. This file contains the credentials required to interact with the REST API of the Manager.

### Red Hat Enterprise Linux CoreOS (RHCOS) section

- **image\_url**: Enter the URL of the RHCOS image you specified for download.
- **local\_cmp\_image\_path**: The path of a local download directory for the compressed RHCOS image.
- **local\_image\_path**: The path of a local directory for the extracted RHCOS image.

### Profiles section

This section consists of two profiles:

- **control\_plane**: The profile of the bootstrap and control plane nodes.
- **compute**: The profile of workers nodes in the compute plane.

These profiles have the following parameters. The default values of the parameters meet the minimum requirements for running a production cluster. You can increase or customize these values to meet your workload requirements.

- **cluster**: The value gets the cluster name from **ovirt\_cluster** in the General Section.
- **memory**: The amount of memory, in GB, for the virtual machine.
- **sockets**: The number of sockets for the virtual machine.
- **cores**: The number of cores for the virtual machine.
- **template**: The name of the virtual machine template. If plan to install multiple clusters, and these clusters use templates that contain different specifications, prepend the template name with the ID of the cluster.
- **operating\_system**: The type of guest operating system in the virtual machine. With oVirt/RHV version 4.4, this value must be **rhcos\_x64** so the value of **ignition script** can be passed to the VM.
- **type**: Enter **server** as the type of the virtual machine.



#### IMPORTANT

You must change the value of the **type** parameter from **high\_performance** to **server**.

- **disks**: The disk specifications. The **control\_plane** and **compute** nodes can have different storage domains.

- **size**: The minimum disk size.
- **name**: Enter the name of a disk connected to the target cluster in RHV.
- **interface**: Enter the interface type of the disk you specified.
- **storage\_domain**: Enter the storage domain of the disk you specified.
- **nics**: Enter the **name** and **network** the virtual machines use. You can also specify the virtual network interface profile. By default, NICs obtain their MAC addresses from the oVirt/RHV MAC pool.

## Virtual machines section

This final section, **vms**, defines the virtual machines you plan to create and deploy in the cluster. By default, it provides the minimum number of control plane and worker nodes for a production environment.

**vms** contains three required elements:

- **name**: The name of the virtual machine. In this case, **metadata.infraID** prepends the virtual machine name with the infrastructure ID from the **metadata.yml** file.
- **ocp\_type**: The role of the virtual machine in the OpenShift Container Platform cluster. Possible values are **bootstrap**, **master**, **worker**.
- **profile**: The name of the profile from which each virtual machine inherits specifications. Possible values in this example are **control\_plane** or **compute**.

You can override the value a virtual machine inherits from its profile. To do this, you add the name of the profile attribute to the virtual machine in **inventory.yml** and assign it an overriding value. To see an example of this, examine the **name: "{{ metadata.infraID }}-bootstrap"** virtual machine in the preceding **inventory.yml** example: It has a **type** attribute whose value, **server**, overrides the value of the **type** attribute this virtual machine would otherwise inherit from the **control\_plane** profile.

## Metadata variables

For virtual machines, **metadata.infraID** prepends the name of the virtual machine with the infrastructure ID from the **metadata.json** file you create when you build the Ignition files.

The playbooks use the following code to read **infraID** from the specific file located in the **ocp.assets\_dir**.

```
---
- name: include metadata.json vars
  include_vars:
    file: "{{ ocp.assets_dir }}/metadata.json"
    name: metadata
...
```

### 19.5.13. Specifying the RHCOS image settings

Update the Red Hat Enterprise Linux CoreOS (RHCOS) image settings of the **inventory.yml** file. Later, when you run this file one of the playbooks, it downloads a compressed Red Hat Enterprise Linux CoreOS (RHCOS) image from the **image\_url** URL to the **local\_cmp\_image\_path** directory. The

playbook then uncompresses the image to the **local\_image\_path** directory and uses it to create oVirt/RHV templates.

## Procedure

1. Locate the RHCOS image download page for the version of OpenShift Container Platform you are installing, such as [Index of /pub/openshift-v4/dependencies/rhcos/latest/latest](#).
2. From that download page, copy the URL of an OpenStack **qcow2** image, such as **[https://mirror.openshift.com/pub/openshift-v4/dependencies/rhcos/4.10/latest/rhcos-openshift.x86\\_64.qcow2.gz](https://mirror.openshift.com/pub/openshift-v4/dependencies/rhcos/4.10/latest/rhcos-openshift.x86_64.qcow2.gz)**.
3. Edit the **inventory.yml** playbook you downloaded earlier. In it, paste the URL as the value for **image\_url**. For example:

```
rhcos:
  "https://mirror.openshift.com/pub/openshift-v4/dependencies/rhcos/4.10/latest/rhcos-
  openshift.x86_64.qcow2.gz"
```

### 19.5.14. Creating the install config file

You create an installation configuration file by running the installation program, **openshift-install**, and responding to its prompts with information you specified or gathered earlier.

When you finish responding to the prompts, the installation program creates an initial version of the **install-config.yaml** file in the assets directory you specified earlier, for example, **./wrk/install-config.yaml**

The installation program also creates a file, **\$HOME/.ovirt/ovirt-config.yaml**, that contains all the connection parameters that are required to reach the Manager and use its REST API.

**NOTE:** The installation process does not use values you supply for some parameters, such as **Internal API virtual IP** and **Ingress virtual IP**, because you have already configured them in your infrastructure DNS.

It also uses the values you supply for parameters in **inventory.yml**, like the ones for **oVirt cluster**, **oVirt storage**, and **oVirt network**. And uses a script to remove or replace these same values from **install-config.yaml** with the previously mentioned **virtual IPs**.

## Procedure

1. Run the installation program:

```
$ openshift-install create install-config --dir $ASSETS_DIR
```

2. Respond to the installation program's prompts with information about your system.

### Example output

```
? SSH Public Key /home/user/.ssh/id_dsa.pub
? Platform <ovirt>
? Engine FQDN[:PORT] [? for help] <engine.fqdn>
? Enter ovirt-engine username <ocpadmin@internal>
? Enter password <*****>
? oVirt cluster <cluster>
```

```
? oVirt storage <storage>
? oVirt network <net>
? Internal API virtual IP <172.16.0.252>
? Ingress virtual IP <172.16.0.251>
? Base Domain <example.org>
? Cluster Name <ocp4>
? Pull Secret [? for help] <*****>
```

```
? SSH Public Key /home/user/.ssh/id_dsa.pub
? Platform <ovirt>
? Engine FQDN[:PORT] [? for help] <engine.fqdn>
? Enter ovirt-engine username <ocpadmin@internal>
? Enter password <*****>
? oVirt cluster <cluster>
? oVirt storage <storage>
? oVirt network <net>
? Internal API virtual IP <172.16.0.252>
? Ingress virtual IP <172.16.0.251>
? Base Domain <example.org>
? Cluster Name <ocp4>
? Pull Secret [? for help] <*****>
```

For **Internal API virtual IP** and **Ingress virtual IP**, supply the IP addresses you specified when you configured the DNS service.

Together, the values you enter for the **oVirt cluster** and **Base Domain** prompts form the FQDN portion of URLs for the REST API and any applications you create, such as **https://api.ocp4.example.org:6443/** and **https://console-openshift-console.apps.ocp4.example.org**.

You can get the [pull secret from the Red Hat OpenShift Cluster Manager](#) .

### 19.5.15. Sample install-config.yaml file for RHV

You can customize the **install-config.yaml** file to specify more details about your OpenShift Container Platform cluster's platform or modify the values of the required parameters.

```
apiVersion: v1
baseDomain: example.com ❶
compute: ❷
- hyperthreading: Enabled ❸
  name: worker
  replicas: 0 ❹
controlPlane: ❺
  hyperthreading: Enabled ❻
  name: master
  replicas: 3 ❼
metadata:
  name: test ❽
networking:
  clusterNetwork:
  - cidr: 10.128.0.0/14 ❾
    hostPrefix: 23 ❿
  networkType: OpenShiftSDN
```

```

serviceNetwork: 11
- 172.30.0.0/16
platform:
  none: {} 12
fips: false 13
pullSecret: '{"auths": ...}' 14
sshKey: 'ssh-ed25519 AAAA...' 15

```

- 1 The base domain of the cluster. All DNS records must be sub-domains of this base and include the cluster name.
- 2 5 The **controlPlane** section is a single mapping, but the **compute** section is a sequence of mappings. To meet the requirements of the different data structures, the first line of the **compute** section must begin with a hyphen, -, and the first line of the **controlPlane** section must not. Only one control plane pool is used.
- 3 6 Specifies whether to enable or disable simultaneous multithreading (SMT), or hyperthreading. By default, SMT is enabled to increase the performance of the cores in your machines. You can disable it by setting the parameter value to **Disabled**. If you disable SMT, you must disable it in all cluster machines; this includes both control plane and compute machines.

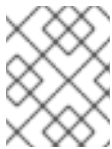

#### NOTE

Simultaneous multithreading (SMT) is enabled by default. If SMT is not enabled in your BIOS settings, the **hyperthreading** parameter has no effect.



#### IMPORTANT

If you disable **hyperthreading**, whether in the BIOS or in the **install-config.yaml** file, ensure that your capacity planning accounts for the dramatically decreased machine performance.

- 4 You must set this value to **0** when you install OpenShift Container Platform on user-provisioned infrastructure. In installer-provisioned installations, the parameter controls the number of compute machines that the cluster creates and manages for you. In user-provisioned installations, you must manually deploy the compute machines before you finish installing the cluster.

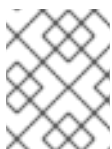

#### NOTE

If you are installing a three-node cluster, do not deploy any compute machines when you install the Red Hat Enterprise Linux CoreOS (RHCOS) machines.

- 7 The number of control plane machines that you add to the cluster. Because the cluster uses these values as the number of etcd endpoints in the cluster, the value must match the number of control plane machines that you deploy.
- 8 The cluster name that you specified in your DNS records.
- 9 A block of IP addresses from which pod IP addresses are allocated. This block must not overlap with existing physical networks. These IP addresses are used for the pod network. If you need to access the pods from an external network, you must configure load balancers and routers to manage the traffic.

**NOTE**

Class E CIDR range is reserved for a future use. To use the Class E CIDR range, you must ensure your networking environment accepts the IP addresses within the Class E CIDR range.

- 10 The subnet prefix length to assign to each individual node. For example, if **hostPrefix** is set to **23**, then each node is assigned a **/23** subnet out of the given **cidr**, which allows for 510 ( $2^{(32 - 23)} - 2$ ) pod IP addresses. If you are required to provide access to nodes from an external network, configure load balancers and routers to manage the traffic.
- 11 The IP address pool to use for service IP addresses. You can enter only one IP address pool. This block must not overlap with existing physical networks. If you need to access the services from an external network, configure load balancers and routers to manage the traffic.
- 12 You must set the platform to **none**. You cannot provide additional platform configuration variables for RHV infrastructure.

**IMPORTANT**

Clusters that are installed with the platform type **none** are unable to use some features, such as managing compute machines with the Machine API. This limitation applies even if the compute machines that are attached to the cluster are installed on a platform that would normally support the feature. This parameter cannot be changed after installation.

- 13 Whether to enable or disable FIPS mode. By default, FIPS mode is not enabled. If FIPS mode is enabled, the Red Hat Enterprise Linux CoreOS (RHCOS) machines that OpenShift Container Platform runs on bypass the default Kubernetes cryptography suite and use the cryptography modules that are provided with RHCOS instead.

**IMPORTANT**

To enable FIPS mode for your cluster, you must run the installation program from a Red Hat Enterprise Linux (RHEL) computer configured to operate in FIPS mode. For more information about configuring FIPS mode on RHEL, see [Installing the system in FIPS mode](#). The use of FIPS validated or Modules In Process cryptographic libraries is only supported on OpenShift Container Platform deployments on the **x86\_64** architecture.

- 14 The [pull secret from the Red Hat OpenShift Cluster Manager](#) . This pull secret allows you to authenticate with the services that are provided by the included authorities, including Quay.io, which serves the container images for OpenShift Container Platform components.
- 15 The SSH public key for the **core** user in Red Hat Enterprise Linux CoreOS (RHCOS).

**NOTE**

For production OpenShift Container Platform clusters on which you want to perform installation debugging or disaster recovery, specify an SSH key that your **ssh-agent** process uses.



### 19.5.15.1. Configuring the cluster-wide proxy during installation

Production environments can deny direct access to the internet and instead have an HTTP or HTTPS proxy available. You can configure a new OpenShift Container Platform cluster to use a proxy by configuring the proxy settings in the **install-config.yaml** file.

#### Prerequisites

- You have an existing **install-config.yaml** file.
- You reviewed the sites that your cluster requires access to and determined whether any of them need to bypass the proxy. By default, all cluster egress traffic is proxied, including calls to hosting cloud provider APIs. You added sites to the **Proxy** object's **spec.noProxy** field to bypass the proxy if necessary.



#### NOTE

The **Proxy** object **status.noProxy** field is populated with the values of the **networking.machineNetwork[].cidr**, **networking.clusterNetwork[].cidr**, and **networking.serviceNetwork[]** fields from your installation configuration.

For installations on Amazon Web Services (AWS), Google Cloud Platform (GCP), Microsoft Azure, and Red Hat OpenStack Platform (RHOSP), the **Proxy** object **status.noProxy** field is also populated with the instance metadata endpoint (**169.254.169.254**).

#### Procedure

1. Edit your **install-config.yaml** file and add the proxy settings. For example:

```
apiVersion: v1
baseDomain: my.domain.com
proxy:
  httpProxy: http://<username>:<pswd>@<ip>:<port> 1
  httpsProxy: https://<username>:<pswd>@<ip>:<port> 2
  noProxy: example.com 3
  additionalTrustBundle: | 4
    -----BEGIN CERTIFICATE-----
    <MY_TRUSTED_CA_CERT>
    -----END CERTIFICATE-----
  ...
```

- 1 A proxy URL to use for creating HTTP connections outside the cluster. The URL scheme must be **http**.
- 2 A proxy URL to use for creating HTTPS connections outside the cluster.
- 3 A comma-separated list of destination domain names, IP addresses, or other network CIDRs to exclude from proxying. Preface a domain with **.** to match subdomains only. For example, **.y.com** matches **x.y.com**, but not **y.com**. Use **\*** to bypass the proxy for all destinations.
- 4 If provided, the installation program generates a config map that is named **user-ca-bundle** in the **openshift-config** namespace that contains one or more additional CA certificates that are required for proxying HTTPS connections. The Cluster Network Operator then

creates a **trusted-ca-bundle** config map that merges these contents with the Red Hat Enterprise Linux CoreOS (RHCOS) trust bundle, and this config map is referenced in the **trustedCA** field of the **Proxy** object. The **additionalTrustBundle** field is required unless the proxy's identity certificate is signed by an authority from the RHCOS trust bundle.

**NOTE**

The installation program does not support the proxy **readinessEndpoints** field.

**NOTE**

If the installer times out, restart and then complete the deployment by using the **wait-for** command of the installer. For example:

```
$ ./openshift-install wait-for install-complete --log-level debug
```

2. Save the file and reference it when installing OpenShift Container Platform.

The installation program creates a cluster-wide proxy that is named **cluster** that uses the proxy settings in the provided **install-config.yaml** file. If no proxy settings are provided, a **cluster Proxy** object is still created, but it will have a nil **spec**.

**NOTE**

Only the **Proxy** object named **cluster** is supported, and no additional proxies can be created.

## 19.5.16. Customizing install-config.yaml

Here, you use three Python scripts to override some of the installation program's default behaviors:

- By default, the installation program uses the machine API to create nodes. To override this default behavior, you set the number of compute nodes to zero replicas. Later, you use Ansible playbooks to create the compute nodes.
- By default, the installation program sets the IP range of the machine network for nodes. To override this default behavior, you set the IP range to match your infrastructure.
- By default, the installation program sets the platform to **ovirt**. However, installing a cluster on user-provisioned infrastructure is more similar to installing a cluster on bare metal. Therefore, you delete the ovirt platform section from **install-config.yaml** and change the platform to **none**. Instead, you use **inventory.yml** to specify all of the required settings.

**NOTE**

These snippets work with Python 3 and Python 2.

### Procedure

1. Set the number of compute nodes to zero replicas:

```
$ python3 -c 'import os, yaml'
```

```
path = "%s/install-config.yaml" % os.environ["ASSETS_DIR"]
conf = yaml.safe_load(open(path))
conf["compute"][0]["replicas"] = 0
open(path, "w").write(yaml.dump(conf, default_flow_style=False))'
```

2. Set the IP range of the machine network. For example, to set the range to **172.16.0.0/16**, enter:

```
$ python3 -c 'import os, yaml
path = "%s/install-config.yaml" % os.environ["ASSETS_DIR"]
conf = yaml.safe_load(open(path))
conf["networking"]["machineNetwork"][0]["cidr"] = "172.16.0.0/16"
open(path, "w").write(yaml.dump(conf, default_flow_style=False))'
```

3. Remove the **ovirt** section and change the platform to **none**:

```
$ python3 -c 'import os, yaml
path = "%s/install-config.yaml" % os.environ["ASSETS_DIR"]
conf = yaml.safe_load(open(path))
platform = conf["platform"]
del platform["ovirt"]
platform["none"] = {}
open(path, "w").write(yaml.dump(conf, default_flow_style=False))'
```



### WARNING

Red Hat Virtualization does not currently support installation with user-provisioned infrastructure on the oVirt platform. Therefore, you must set the platform to **none**, allowing OpenShift Container Platform to identify each node as a bare-metal node and the cluster as a bare-metal cluster. This is the same as [installing a cluster on any platform](#), and has the following limitations:

1. There will be no cluster provider so you must manually add each machine and there will be no node scaling capabilities.
2. The oVirt CSI driver will not be installed and there will be no CSI capabilities.

## 19.5.17. Generate manifest files

Use the installation program to generate a set of manifest files in the assets directory.

The command to generate the manifest files displays a warning message before it consumes the **install-config.yaml** file.

If you plan to reuse the **install-config.yaml** file, create a backup copy of it before you back it up before you generate the manifest files.

### Procedure

1. Optional: Create a backup copy of the **install-config.yaml** file:

```
$ cp install-config.yaml install-config.yaml.backup
```

2. Generate a set of manifests in your assets directory:

```
$ openshift-install create manifests --dir $ASSETS_DIR
```

This command displays the following messages.

### Example output

```
INFO Consuming Install Config from target directory
WARNING Making control-plane schedulable by setting MastersSchedulable to true for
Scheduler cluster settings
```

The command generates the following manifest files:

### Example output

```
$ tree
├── wrk
│   ├── manifests
│   │   ├── 04-openshift-machine-config-operator.yaml
│   │   ├── cluster-config.yaml
│   │   ├── cluster-dns-02-config.yml
│   │   ├── cluster-infrastructure-02-config.yml
│   │   ├── cluster-ingress-02-config.yml
│   │   ├── cluster-network-01-crd.yml
│   │   ├── cluster-network-02-config.yml
│   │   ├── cluster-proxy-01-config.yaml
│   │   ├── cluster-scheduler-02-config.yml
│   │   ├── cvo-overrides.yaml
│   │   ├── etcd-ca-bundle-configmap.yaml
│   │   ├── etcd-client-secret.yaml
│   │   ├── etcd-host-service-endpoints.yaml
│   │   ├── etcd-host-service.yaml
│   │   ├── etcd-metric-client-secret.yaml
│   │   ├── etcd-metric-serving-ca-configmap.yaml
│   │   ├── etcd-metric-signer-secret.yaml
│   │   ├── etcd-namespace.yaml
│   │   ├── etcd-service.yaml
│   │   ├── etcd-serving-ca-configmap.yaml
│   │   ├── etcd-signer-secret.yaml
│   │   ├── kube-cloud-config.yaml
│   │   ├── kube-system-configmap-root-ca.yaml
│   │   ├── machine-config-server-tls-secret.yaml
│   │   └── openshift-config-secret-pull-secret.yaml
│   └── openshift
│       ├── 99_kubeadmin-password-secret.yaml
│       ├── 99_openshift-cluster-api_master-user-data-secret.yaml
│       └── 99_openshift-cluster-api_worker-user-data-secret.yaml
```

```

├── 99_openshift-machineconfig_99-master-ssh.yaml
├── 99_openshift-machineconfig_99-worker-ssh.yaml
└── openshift-install-manifests.yaml

```

## Next steps

- Make control plane nodes non-schedulable.

### 19.5.18. Making control-plane nodes non-schedulable

Because you are manually creating and deploying the control plane machines, you must configure a manifest file to make the control plane nodes non-schedulable.

#### Procedure

1. To make the control plane nodes non-schedulable, enter:

```

$ python3 -c 'import os, yaml
path = "%s/manifests/cluster-scheduler-02-config.yaml" % os.environ["ASSETS_DIR"]
data = yaml.safe_load(open(path))
data["spec"]["mastersSchedulable"] = False
open(path, "w").write(yaml.dump(data, default_flow_style=False))'

```

### 19.5.19. Building the Ignition files

To build the Ignition files from the manifest files you just generated and modified, you run the installation program. This action creates a Red Hat Enterprise Linux CoreOS (RHCOS) machine, **inframfs**, which fetches the Ignition files and performs the configurations needed to create a node.

In addition to the Ignition files, the installation program generates the following:

- An **auth** directory that contains the admin credentials for connecting to the cluster with the **oc** and **kubectl** utilities.
- A **metadata.json** file that contains information such as the OpenShift Container Platform cluster name, cluster ID, and infrastructure ID for the current installation.

The Ansible playbooks for this installation process use the value of **infrald** as a prefix for the virtual machines they create. This prevents naming conflicts when there are multiple installations in the same oVirt/RHV cluster.



#### NOTE

Certificates in Ignition configuration files expire after 24 hours. Complete the cluster installation and keep the cluster running in a non-degraded state for 24 hours so that the first certificate rotation can finish.

#### Procedure

1. To build the Ignition files, enter:

```

$ openshift-install create ignition-configs --dir $ASSETS_DIR

```

## Example output

```
$ tree
.
├── wrk
│   ├── auth
│   │   ├── kubeadmin-password
│   │   └── kubeconfig
│   ├── bootstrap.ign
│   ├── master.ign
│   ├── metadata.json
│   └── worker.ign
```

### 19.5.20. Creating templates and virtual machines

After confirming the variables in the **inventory.yml**, you run the first Ansible provisioning playbook, **create-templates-and-vms.yml**.

This playbook uses the connection parameters for the RHV Manager from **\$HOME/.ovirt/ovirt-config.yaml** and reads **metadata.json** in the assets directory.

If a local Red Hat Enterprise Linux CoreOS (RHCOS) image is not already present, the playbook downloads one from the URL you specified for **image\_url** in **inventory.yml**. It extracts the image and uploads it to RHV to create templates.

The playbook creates a template based on the **control\_plane** and **compute** profiles in the **inventory.yml** file. If these profiles have different names, it creates two templates.

When the playbook finishes, the virtual machines it creates are stopped. You can get information from them to help configure other infrastructure elements. For example, you can get the virtual machines' MAC addresses to configure DHCP to assign permanent IP addresses to the virtual machines.

#### Procedure

1. In **inventory.yml**, under the **control\_plane** and **compute** variables, change both instances of **type: high\_performance** to **type: server**.
2. Optional: If you plan to perform multiple installations to the same cluster, create different templates for each OpenShift Container Platform installation. In the **inventory.yml** file, prepend the value of **template** with **infraID**. For example:

```
control_plane:
  cluster: "{{ ovirt_cluster }}"
  memory: 16GiB
  sockets: 4
  cores: 1
  template: "{{ metadata.infraID }}-rhcos_tpl"
  operating_system: "rhcos_x64"
  ...
```

3. Create the templates and virtual machines:

```
$ ansible-playbook -i inventory.yml create-templates-and-vms.yml
```

### 19.5.21. Creating the bootstrap machine

You create a bootstrap machine by running the **bootstrap.yml** playbook. This playbook starts the bootstrap virtual machine, and passes it the **bootstrap.ign** Ignition file from the assets directory. The bootstrap node configures itself so it can serve Ignition files to the control plane nodes.

To monitor the bootstrap process, you use the console in the RHV Administration Portal or connect to the virtual machine by using SSH.

#### Procedure

1. Create the bootstrap machine:

```
$ ansible-playbook -i inventory.yml bootstrap.yml
```

2. Connect to the bootstrap machine using a console in the Administration Portal or SSH. Replace **<bootstrap\_ip>** with the bootstrap node IP address. To use SSH, enter:

```
$ ssh core@<bootstrap.ip>
```

3. Collect **bootkube.service** journald unit logs for the release image service from the bootstrap node:

```
[core@ocp4-1k6b4-bootstrap ~]$ journalctl -b -f -u release-image.service -u bootkube.service
```



#### NOTE

The **bootkube.service** log on the bootstrap node outputs etcd **connection refused** errors, indicating that the bootstrap server is unable to connect to etcd on control plane nodes. After etcd has started on each control plane node and the nodes have joined the cluster, the errors should stop.

### 19.5.22. Creating the control plane nodes

You create the control plane nodes by running the **masters.yml** playbook. This playbook passes the **master.ign** Ignition file to each of the virtual machines. The Ignition file contains a directive for the control plane node to get the Ignition from a URL such as <https://api-int.ocp4.example.org:22623/config/master>. The port number in this URL is managed by the load balancer, and is accessible only inside the cluster.

#### Procedure

1. Create the control plane nodes:

```
$ ansible-playbook -i inventory.yml masters.yml
```

2. While the playbook creates your control plane, monitor the bootstrapping process:

```
$ openshift-install wait-for bootstrap-complete --dir $ASSETS_DIR
```

#### Example output

```
INFO API v1.23.0 up
INFO Waiting up to 40m0s for bootstrapping to complete...
```

3. When all the pods on the control plane nodes and etcd are up and running, the installation program displays the following output.

### Example output

```
INFO It is now safe to remove the bootstrap resources
```

## 19.5.23. Verifying cluster status

You can verify your OpenShift Container Platform cluster's status during or after installation.

### Procedure

1. In the cluster environment, export the administrator's kubeconfig file:

```
$ export KUBECONFIG=$ASSETS_DIR/auth/kubeconfig
```

The **kubeconfig** file contains information about the cluster that is used by the CLI to connect a client to the correct cluster and API server.

2. View the control plane and compute machines created after a deployment:

```
$ oc get nodes
```

3. View your cluster's version:

```
$ oc get clusterversion
```

4. View your Operators' status:

```
$ oc get clusteroperator
```

5. View all running pods in the cluster:

```
$ oc get pods -A
```

## 19.5.24. Removing the bootstrap machine

After the **wait-for** command shows that the bootstrap process is complete, you must remove the bootstrap virtual machine to free up compute, memory, and storage resources. Also, remove settings for the bootstrap machine from the load balancer directives.

### Procedure

1. To remove the bootstrap machine from the cluster, enter:

```
$ ansible-playbook -i inventory.yml retire-bootstrap.yml
```



2. Remove settings for the bootstrap machine from the load balancer directives.

### 19.5.25. Creating the worker nodes and completing the installation

Creating worker nodes is similar to creating control plane nodes. However, worker nodes workers do not automatically join the cluster. To add them to the cluster, you review and approve the workers' pending CSRs (Certificate Signing Requests).

After approving the first requests, you continue approving CSR until all of the worker nodes are approved. When you complete this process, the worker nodes become **Ready** and can have pods scheduled to run on them.

Finally, monitor the command line to see when the installation process completes.

#### Procedure

1. Create the worker nodes:

```
$ ansible-playbook -i inventory.yml workers.yml
```

2. To list all of the CSRs, enter:

```
$ oc get csr -A
```

Eventually, this command displays one CSR per node. For example:

#### Example output

```
NAME          AGE  SIGNERNAME                                     REQUESTOR
CONDITION
csr-2lnxd     63m  kubernetes.io/kubelet-serving                system:node:ocp4-lk6b4-
master0.ocp4.example.org                    Approved,Issued
csr-hff4q     64m  kubernetes.io/kube-apiserver-client-kubelet  system:serviceaccount:openshift-machine-config-operator:node-bootstrapper
Approved,Issued
csr-hsn96     60m  kubernetes.io/kubelet-serving                system:node:ocp4-lk6b4-
master2.ocp4.example.org                    Approved,Issued
csr-m724n     6m2s kubernetes.io/kube-apiserver-client-kubelet  system:serviceaccount:openshift-machine-config-operator:node-bootstrapper Pending
csr-p4dz2     60m  kubernetes.io/kube-apiserver-client-kubelet  system:serviceaccount:openshift-machine-config-operator:node-bootstrapper
Approved,Issued
csr-t9vfj     60m  kubernetes.io/kubelet-serving                system:node:ocp4-lk6b4-
master1.ocp4.example.org                    Approved,Issued
csr-tggtr     61m  kubernetes.io/kube-apiserver-client-kubelet  system:serviceaccount:openshift-machine-config-operator:node-bootstrapper
Approved,Issued
csr-wcbrf     7m6s kubernetes.io/kube-apiserver-client-kubelet  system:serviceaccount:openshift-machine-config-operator:node-bootstrapper Pending
```

3. To filter the list and see only pending CSRs, enter:

```
$ watch "oc get csr -A | grep pending -i"
```

This command refreshes the output every two seconds and displays only pending CSRs. For example:

### Example output

```
Every 2.0s: oc get csr -A | grep pending -i

csr-m724n 10m kubernetes.io/kube-apiserver-client-kubelet
system:serviceaccount:openshift-machine-config-operator:node-bootstrapper Pending
csr-wcbrf 11m kubernetes.io/kube-apiserver-client-kubelet
system:serviceaccount:openshift-machine-config-operator:node-bootstrapper Pending
```

- Inspect each pending request. For example:

### Example output

```
$ oc describe csr csr-m724n
```

### Example output

```
Name:          csr-m724n
Labels:        <none>
Annotations:   <none>
CreationTimestamp: Sun, 19 Jul 2020 15:59:37 +0200
Requesting User: system:serviceaccount:openshift-machine-config-operator:node-
bootstrapper
Signer:        kubernetes.io/kube-apiserver-client-kubelet
Status:        Pending
Subject:
  Common Name:  system:node:ocp4-lk6b4-worker1.ocp4.example.org
  Serial Number:
  Organization: system:nodes
Events: <none>
```

- If the CSR information is correct, approve the request:

```
$ oc adm certificate approve csr-m724n
```

- Wait for the installation process to finish:

```
$ openshift-install wait-for install-complete --dir $ASSETS_DIR --log-level debug
```

When the installation completes, the command line displays the URL of the OpenShift Container Platform web console and the administrator user name and password.

## 19.5.26. Telemetry access for OpenShift Container Platform

In OpenShift Container Platform 4.10, the Telemetry service, which runs by default to provide metrics about cluster health and the success of updates, requires internet access. If your cluster is connected to the internet, Telemetry runs automatically, and your cluster is registered to [OpenShift Cluster Manager](#).

After you confirm that your [OpenShift Cluster Manager](#) inventory is correct, either maintained automatically by Telemetry or manually by using OpenShift Cluster Manager, [use subscription watch](#) to track your OpenShift Container Platform subscriptions at the account or multi-cluster level.

### Additional resources

- See [About remote health monitoring](#) for more information about the Telemetry service

## 19.5.27. Disabling the default OperatorHub sources

Operator catalogs that source content provided by Red Hat and community projects are configured for OperatorHub by default during an OpenShift Container Platform installation. In a restricted network environment, you must disable the default catalogs as a cluster administrator.

### Procedure

- Disable the sources for the default catalogs by adding **disableAllDefaultSources: true** to the **OperatorHub** object:

```
$ oc patch OperatorHub cluster --type json \
  -p '[{"op": "add", "path": "/spec/disableAllDefaultSources", "value": true}]'
```

### TIP

Alternatively, you can use the web console to manage catalog sources. From the **Administration** → **Cluster Settings** → **Configuration** → **OperatorHub** page, click the **Sources** tab, where you can create, delete, disable, and enable individual sources.

## 19.6. UNINSTALLING A CLUSTER ON RHV

You can remove an OpenShift Container Platform cluster from Red Hat Virtualization (RHV).

### 19.6.1. Removing a cluster that uses installer-provisioned infrastructure

You can remove a cluster that uses installer-provisioned infrastructure from your cloud.



#### NOTE

After uninstallation, check your cloud provider for any resources not removed properly, especially with User Provisioned Infrastructure (UPI) clusters. There might be resources that the installer did not create or that the installer is unable to access.

### Prerequisites

- Have a copy of the installation program that you used to deploy the cluster.
- Have the files that the installation program generated when you created your cluster.

### Procedure

1. From the directory that contains the installation program on the computer that you used to install the cluster, run the following command:

```
$. /openshift-install destroy cluster \  
--dir <installation_directory> --log-level info 1 2
```

- 1** For **<installation\_directory>**, specify the path to the directory that you stored the installation files in.
- 2** To view different details, specify **warn**, **debug**, or **error** instead of **info**.



#### NOTE

You must specify the directory that contains the cluster definition files for your cluster. The installation program requires the **metadata.json** file in this directory to delete the cluster.

- Optional: Delete the **<installation\_directory>** directory and the OpenShift Container Platform installation program.

## 19.6.2. Removing a cluster that uses user-provisioned infrastructure

When you are finished using the cluster, you can remove a cluster that uses user-provisioned infrastructure from your cloud.

### Prerequisites

- Have the original playbook files, assets directory and files, and **\$ASSETS\_DIR** environment variable that you used to you install the cluster. Typically, you can achieve this by using the same computer you used when you installed the cluster.

### Procedure

- To remove the cluster, enter:

```
$. ansible-playbook -i inventory.yml \  
retire-bootstrap.yml \  
retire-masters.yml \  
retire-workers.yml
```

- Remove any configurations you added to DNS, load balancers, and any other infrastructure for this cluster.

## CHAPTER 20. INSTALLING ON VSPHERE

### 20.1. PREPARING TO INSTALL ON VSPHERE

#### 20.1.1. Prerequisites

- You reviewed details about the [OpenShift Container Platform installation and update](#) processes.
- You read the documentation on [selecting a cluster installation method and preparing it for users](#).
- If you use a firewall and plan to use Telemetry, you [configured the firewall to allow the sites](#) required by your cluster.
- You reviewed your VMware platform licenses. Red Hat does not place any restrictions on your VMware licenses, but some VMware infrastructure components require licensing.

#### 20.1.2. Choosing a method to install OpenShift Container Platform on vSphere

You can install OpenShift Container Platform on vSphere by using installer-provisioned or user-provisioned infrastructure. The default installation type uses installer-provisioned infrastructure, where the installation program provisions the underlying infrastructure for the cluster. You can also install OpenShift Container Platform on infrastructure that you provide. If you do not use infrastructure that the installation program provisions, you must manage and maintain the cluster resources yourself.

See the [Installation process](#) for more information about installer-provisioned and user-provisioned installation processes.



#### IMPORTANT

The steps for performing a user-provisioned infrastructure installation are provided as an example only. Installing a cluster with infrastructure you provide requires knowledge of the vSphere platform and the installation process of OpenShift Container Platform. Use the user-provisioned infrastructure installation instructions as a guide; you are free to create the required resources through other methods.

##### 20.1.2.1. Installer-provisioned infrastructure installation of OpenShift Container Platform on vSphere

Installer-provisioned infrastructure allows the installation program to pre-configure and automate the provisioning of resources required by OpenShift Container Platform.

- [Installing a cluster on vSphere](#) You can install OpenShift Container Platform on vSphere by using installer-provisioned infrastructure installation with no customization.
- [Installing a cluster on vSphere with customizations](#) You can install OpenShift Container Platform on vSphere by using installer-provisioned infrastructure installation with the default customization options.
- [Installing a cluster on vSphere with network customizations](#) You can install OpenShift Container Platform on installer-provisioned vSphere infrastructure, with network customizations. You can customize your OpenShift Container Platform network configuration

during installation, so that your cluster can coexist with your existing IP address allocations and adhere to your network requirements.

- **Installing a cluster on vSphere in a restricted network** You can install a cluster on VMware vSphere infrastructure in a restricted network by creating an internal mirror of the installation release content. You can use this method to deploy OpenShift Container Platform on an internal network that is not visible to the internet.

### 20.1.2.2. User-provisioned infrastructure installation of OpenShift Container Platform on vSphere

User-provisioned infrastructure requires the user to provision all resources required by OpenShift Container Platform.

- **Installing a cluster on vSphere with user-provisioned infrastructure** You can install OpenShift Container Platform on VMware vSphere infrastructure that you provision.
- **Installing a cluster on vSphere with network customizations with user-provisioned infrastructure:** You can install OpenShift Container Platform on VMware vSphere infrastructure that you provision with customized network configuration options.
- **Installing a cluster on vSphere in a restricted network with user-provisioned infrastructure** OpenShift Container Platform can be installed on VMware vSphere infrastructure that you provision in a restricted network.

### 20.1.3. VMware vSphere infrastructure requirements

You must install the OpenShift Container Platform cluster on a VMware vSphere version 7 instance that meets the requirements for the components that you use.

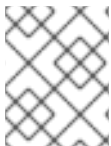

#### NOTE

OpenShift Container Platform version 4.10 does not support VMware vSphere version 8.0.

You can host the VMware vSphere infrastructure on-premise or on a [VMware Cloud Verified provider](#) that meets the requirements outlined in the following table:

**Table 20.1. Version requirements for vSphere virtual environments**

Virtual environment product	Required version
VM hardware version	15 or later
vSphere ESXi hosts	7
vCenter host	7

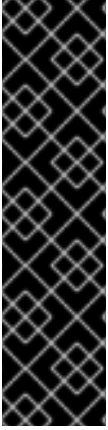

## IMPORTANT

Installing a cluster on VMware vSphere version 7.0 Update 1 is now deprecated. These versions are still fully supported, but version 4.10 of OpenShift Container Platform requires vSphere virtual hardware version 15 or later. Hardware version 15 is now the default for vSphere virtual machines in OpenShift Container Platform. To update the hardware version for your vSphere nodes, see the "Updating hardware on nodes running in vSphere" article.

If your vSphere nodes are below hardware version 15 or your VMware vSphere version is earlier than 6.7U3, upgrading from OpenShift Container Platform 4.10 to OpenShift Container Platform 4.11 is not available.

**Table 20.2. Minimum supported vSphere version for VMware components**

Component	Minimum supported versions	Description
Hypervisor	vSphere 7 with HW version 15	This version is the minimum version that Red Hat Enterprise Linux CoreOS (RHCOS) supports. For more information about supported hardware on the latest version of Red Hat Enterprise Linux (RHEL) that is compatible with RHCOS, see <a href="#">Hardware</a> on the Red Hat Customer Portal.
Storage with in-tree drivers	vSphere 7	This plugin creates vSphere storage by using the in-tree storage drivers for vSphere included in OpenShift Container Platform.
Optional: Networking (NSX-T)	vSphere 7	vSphere 7 is required for OpenShift Container Platform. For more information about the compatibility of NSX and OpenShift Container Platform, see the Release Notes section of VMware's <a href="#">NSX container plugin documentation</a> .

If you use a vSphere version 6.5 instance, upgrade to 7.0 before you install OpenShift Container Platform.



## IMPORTANT

You must ensure that the time on your ESXi hosts is synchronized before you install OpenShift Container Platform. See [Edit Time Configuration for a Host](#) in the VMware documentation.

### 20.1.4. VMware vSphere CSI Driver Operator requirements

To install the vSphere CSI Driver Operator, the following requirements must be met:

- VMware vSphere version 6.7U3 or later
- Virtual machines of hardware version 15 or later
- No third-party vSphere CSI driver already installed in the cluster



### IMPORTANT

If a third-party vSphere CSI driver is present in the cluster, OpenShift Container Platform does not overwrite it. If you continue with the third-party vSphere CSI driver when upgrading to the next major version of OpenShift Container Platform, the **oc** CLI prompts you with the following message:

```
VSphereCSIDriverOperatorCRUpgradeable: VMwareVSphereControllerUpgradeable:
found existing unsupported csi.vsphere.vmware.com driver
```

The previous message informs you that Red Hat does not support the third-party vSphere CSI driver during an OpenShift Container Platform upgrade operation. You can choose to ignore this message and continue with the upgrade operation.

#### Additional resources

- To remove a third-party vSphere CSI driver, see [Removing a third-party vSphere CSI Driver](#) .

### 20.1.5. Uninstalling an installer-provisioned infrastructure installation of OpenShift Container Platform on vSphere

- [Uninstalling a cluster on vSphere that uses installer-provisioned infrastructure](#) You can remove a cluster that you deployed on VMware vSphere infrastructure that used installer-provisioned infrastructure.

## 20.2. INSTALLING A CLUSTER ON VSPHERE

In OpenShift Container Platform version 4.10, you can install a cluster on your VMware vSphere instance by using installer-provisioned infrastructure.



### NOTE

OpenShift Container Platform supports deploying a cluster to a single VMware vCenter only. Deploying a cluster with machines/machine sets on multiple vCenters is not supported.

### 20.2.1. Prerequisites

- You reviewed details about the [OpenShift Container Platform installation and update](#) processes.
- You read the documentation on [selecting a cluster installation method and preparing it for users](#).
- You provisioned [persistent storage](#) for your cluster. To deploy a private image registry, your storage must provide **ReadWriteMany** access modes.



- The OpenShift Container Platform installer requires access to port 443 on the vCenter and ESXi hosts. You verified that port 443 is accessible.
- If you use a firewall, you confirmed with the administrator that port 443 is accessible. Control plane nodes must be able to reach vCenter and ESXi hosts on port 443 for the installation to succeed.
- If you use a firewall, you [configured it to allow the sites](#) that your cluster requires access to.

**NOTE**

Be sure to also review this site list if you are configuring a proxy.

### 20.2.2. Internet access for OpenShift Container Platform

In OpenShift Container Platform 4.10, you require access to the internet to install your cluster.

You must have internet access to:

- Access [OpenShift Cluster Manager](#) to download the installation program and perform subscription management. If the cluster has internet access and you do not disable Telemetry, that service automatically entitles your cluster.
- Access [Quay.io](#) to obtain the packages that are required to install your cluster.
- Obtain the packages that are required to perform cluster updates.

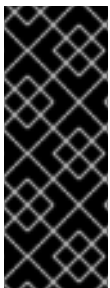
**IMPORTANT**

If your cluster cannot have direct internet access, you can perform a restricted network installation on some types of infrastructure that you provision. During that process, you download the required content and use it to populate a mirror registry with the installation packages. With some installation types, the environment that you install your cluster in will not require internet access. Before you update the cluster, you update the content of the mirror registry.

### 20.2.3. VMware vSphere infrastructure requirements

You must install the OpenShift Container Platform cluster on a VMware vSphere version 7 instance that meets the requirements for the components that you use.

**NOTE**

OpenShift Container Platform version 4.10 does not support VMware vSphere version 8.0.

You can host the VMware vSphere infrastructure on-premise or on a [VMware Cloud Verified provider](#) that meets the requirements outlined in the following table:

**Table 20.3. Version requirements for vSphere virtual environments**

Virtual environment product	Required version
VM hardware version	15 or later
vSphere ESXi hosts	7
vCenter host	7

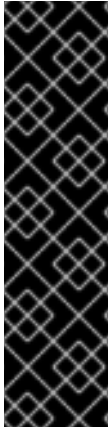

## IMPORTANT

Installing a cluster on VMware vSphere version 7.0 Update 1 is now deprecated. These versions are still fully supported, but version 4.10 of OpenShift Container Platform requires vSphere virtual hardware version 15 or later. Hardware version 15 is now the default for vSphere virtual machines in OpenShift Container Platform. To update the hardware version for your vSphere nodes, see the "Updating hardware on nodes running in vSphere" article.

If your vSphere nodes are below hardware version 15 or your VMware vSphere version is earlier than 6.7U3, upgrading from OpenShift Container Platform 4.10 to OpenShift Container Platform 4.11 is not available.

**Table 20.4. Minimum supported vSphere version for VMware components**

Component	Minimum supported versions	Description
Hypervisor	vSphere 7 with HW version 15	This version is the minimum version that Red Hat Enterprise Linux CoreOS (RHCOS) supports. For more information about supported hardware on the latest version of Red Hat Enterprise Linux (RHEL) that is compatible with RHCOS, see <a href="#">Hardware</a> on the Red Hat Customer Portal.
Storage with in-tree drivers	vSphere 7	This plugin creates vSphere storage by using the in-tree storage drivers for vSphere included in OpenShift Container Platform.
Optional: Networking (NSX-T)	vSphere 7	vSphere 7 is required for OpenShift Container Platform. For more information about the compatibility of NSX and OpenShift Container Platform, see the Release Notes section of VMware's <a href="#">NSX container plugin documentation</a> .

If you use a vSphere version 6.5 instance, upgrade to 7.0 before you install OpenShift Container Platform.

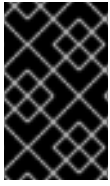

### IMPORTANT

You must ensure that the time on your ESXi hosts is synchronized before you install OpenShift Container Platform. See [Edit Time Configuration for a Host](#) in the VMware documentation.

## 20.2.4. Network connectivity requirements

You must configure the network connectivity between machines to allow OpenShift Container Platform cluster components to communicate.

Review the following details about the required network ports.

**Table 20.5. Ports used for all-machine to all-machine communications**

Protocol	Port	Description
ICMP	N/A	Network reachability tests
TCP	<b>1936</b>	Metrics
	<b>9000-9999</b>	Host level services, including the node exporter on ports <b>9100-9101</b> and the Cluster Version Operator on port <b>9099</b> .
	<b>10250-10259</b>	The default ports that Kubernetes reserves
	<b>10256</b>	openshift-sdn
UDP	<b>4789</b>	virtual extensible LAN (VXLAN)
	<b>6081</b>	Geneve
	<b>9000-9999</b>	Host level services, including the node exporter on ports <b>9100-9101</b> .
	<b>500</b>	IPsec IKE packets
	<b>4500</b>	IPsec NAT-T packets
TCP/UDP	<b>30000-32767</b>	Kubernetes node port
ESP	N/A	IPsec Encapsulating Security Payload (ESP)

**Table 20.6. Ports used for all-machine to control plane communications**

Protocol	Port	Description
TCP	<b>6443</b>	Kubernetes API

Table 20.7. Ports used for control plane machine to control plane machine communications

Protocol	Port	Description
TCP	<b>2379-2380</b>	etcd server and peer ports

### 20.2.5. VMware vSphere CSI Driver Operator requirements

To install the vSphere CSI Driver Operator, the following requirements must be met:

- VMware vSphere version 6.7U3 or later
- Virtual machines of hardware version 15 or later
- No third-party vSphere CSI driver already installed in the cluster



#### IMPORTANT

If a third-party vSphere CSI driver is present in the cluster, OpenShift Container Platform does not overwrite it. If you continue with the third-party vSphere CSI driver when upgrading to the next major version of OpenShift Container Platform, the **oc** CLI prompts you with the following message:

```
VSphereCSIDriverOperatorCRUpgradeable: VMwareVSphereControllerUpgradeable:
found existing unsupported csi.vsphere.vmware.com driver
```

The previous message informs you that Red Hat does not support the third-party vSphere CSI driver during an OpenShift Container Platform upgrade operation. You can choose to ignore this message and continue with the upgrade operation.

#### Additional resources

- To remove a third-party vSphere CSI driver, see [Removing a third-party vSphere CSI Driver](#) .
- To update the hardware version for your vSphere nodes, see [Updating hardware on nodes running in vSphere](#).

### 20.2.6. vCenter requirements

Before you install an OpenShift Container Platform cluster on your vCenter that uses infrastructure that the installer provisions, you must prepare your environment.

#### Required vCenter account privileges

To install an OpenShift Container Platform cluster in a vCenter, the installation program requires access to an account with privileges to read and create the required resources. Using an account that has global administrative privileges is the simplest way to access all of the necessary permissions.

If you cannot use an account with global administrative privileges, you must create roles to grant the privileges necessary for OpenShift Container Platform cluster installation. While most of the privileges are always required, some are required only if you plan for the installation program to provision a folder to contain the OpenShift Container Platform cluster on your vCenter instance, which is the default behavior. You must create or amend vSphere roles for the specified objects to grant the required privileges.

An additional role is required if the installation program is to create a vSphere virtual machine folder.

### Example 20.1. Roles and privileges required for installation in vSphere API

vSphere object for role	When required	Required privileges in vSphere API
vSphere vCenter	Always	<b>Cns.Searchable</b> <b>InventoryService.Tagging.AttachTag</b> <b>InventoryService.Tagging.CreateCategory</b> <b>InventoryService.Tagging.CreateTag</b> <b>InventoryService.Tagging.DeleteCategory</b> <b>InventoryService.Tagging.DeleteTag</b> <b>InventoryService.Tagging.EditCategory</b> <b>InventoryService.Tagging.EditTag</b> <b>Sessions.ValidateSession</b> <b>StorageProfile.Update</b> <b>StorageProfile.View</b>
vSphere vCenter Cluster	If VMs will be created in the cluster root	<b>Host.Config.StorageResource.AssignVMToPool</b> <b>VApp.AssignResourcePool</b> <b>VApp.Import</b> <b>VirtualMachine.Config.AddNewDisk</b>
vSphere vCenter Resource Pool	If an existing resource pool is provided	<b>Host.Config.StorageResource.AssignVMToPool</b> <b>VApp.AssignResourcePool</b> <b>VApp.Import</b> <b>VirtualMachine.Config.AddNewDisk</b>
vSphere Datastore	Always	<b>Datastore.AllocateSpace</b> <b>Datastore.Browse</b> <b>Datastore.FileManagement</b> <b>InventoryService.Tagging.ObjectAttachable</b>

vSphere object for role	When required	Required privileges in vSphere API
vSphere Port Group	Always	<b>Network.Assign</b>
Virtual Machine Folder	Always	<b>InventoryService.Tagging.ObjectAttachable</b> <b>Resource.AssignVMToPool</b> <b>VApp.Import</b> <b>VirtualMachine.Config.AddExistingDisk</b> <b>VirtualMachine.Config.AddNewDisk</b> <b>VirtualMachine.Config.AddRemoveDevice</b> <b>VirtualMachine.Config.AdvancedConfig</b> <b>VirtualMachine.Config.Annotation</b> <b>VirtualMachine.Config.CPUCount</b> <b>VirtualMachine.Config.DiskExtend</b> <b>VirtualMachine.Config.DiskLease</b> <b>VirtualMachine.Config.EditDevice</b> <b>VirtualMachine.Config.Memory</b> <b>VirtualMachine.Config.RemoveDisk</b> <b>VirtualMachine.Config.Rename</b> <b>VirtualMachine.Config.ResetGuestInfo</b> <b>VirtualMachine.Config.Resource</b> <b>VirtualMachine.Config.Settings</b> <b>VirtualMachine.Config.UpgradeVirtualHardware</b> <b>VirtualMachine.Interact.GuestControl</b> <b>VirtualMachine.Interact.PowerOff</b> <b>VirtualMachine.Interact.PowerOn</b> <b>VirtualMachine.Interact.Reset</b> <b>VirtualMachine.Inventory.Create</b> <b>VirtualMachine.Inventory.CreateFromExisting</b> <b>VirtualMachine.Inventory.Delete</b>

vSphere object for role	When required	VirtualMachine.Provisioning API Required privileges in vSphere VirtualMachine.Provisioning.MarkAsTemplate VirtualMachine.Provisioning.DeployTemplate
vSphere vCenter Datacenter	If the installation program creates the virtual machine folder	<b>InventoryService.Tagging.ObjectAttachable</b> <b>Resource.AssignVMToPool</b> <b>VApp.Import</b> <b>VirtualMachine.Config.AddExistingDisk</b> <b>VirtualMachine.Config.AddNewDisk</b> <b>VirtualMachine.Config.AddRemoveDevice</b> <b>VirtualMachine.Config.AdvancedConfig</b> <b>VirtualMachine.Config.Annotation</b> <b>VirtualMachine.Config.CPUCount</b> <b>VirtualMachine.Config.DiskExtend</b> <b>VirtualMachine.Config.DiskLease</b> <b>VirtualMachine.Config.EditDevice</b> <b>VirtualMachine.Config.Memory</b> <b>VirtualMachine.Config.RemoveDisk</b> <b>VirtualMachine.Config.Rename</b> <b>VirtualMachine.Config.ResetGuestInfo</b> <b>VirtualMachine.Config.Resource</b> <b>VirtualMachine.Config.Settings</b> <b>VirtualMachine.Config.UpgradeVirtualHardware</b> <b>VirtualMachine.Interact.GuestControl</b> <b>VirtualMachine.Interact.PowerOff</b> <b>VirtualMachine.Interact.PowerOn</b> <b>VirtualMachine.Interact.Reset</b> <b>VirtualMachine.Inventory.Create</b> <b>VirtualMachine.Inventory.Cr</b>

vSphere object for role	When required	Required privileges in vSphere API
		<b>VirtualMachine.Inventory.CreateFromExisting</b> <b>VirtualMachine.Inventory.Delete</b> <b>VirtualMachine.Provisioning.Clone</b> <b>VirtualMachine.Provisioning.DeployTemplate</b> <b>VirtualMachine.Provisioning.MarkAsTemplate</b> <b>Folder.Create</b> <b>Folder.Delete</b>

Example 20.2. Roles and privileges required for installation in vCenter graphical user interface (GUI)

vSphere object for role	When required	Required privileges in vCenter GUI
vSphere vCenter	Always	<b>Cns.Searchable</b> <b>"vSphere Tagging"."Assign or Unassign vSphere Tag"</b> <b>"vSphere Tagging"."Create vSphere Tag Category"</b> <b>"vSphere Tagging"."Create vSphere Tag"</b> <b>vSphere Tagging"."Delete vSphere Tag Category"</b> <b>"vSphere Tagging"."Delete vSphere Tag"</b> <b>"vSphere Tagging"."Edit vSphere Tag Category"</b> <b>"vSphere Tagging"."Edit vSphere Tag"</b> <b>Sessions."Validate session"</b> <b>"Profile-driven storage"."Profile-driven storage update"</b> <b>"Profile-driven storage"."Profile-driven storage view"</b>



vSphere object for role	When required	Required privileges in vCenter GUI
vSphere vCenter Cluster	If VMs will be created in the cluster root	<b>Host.Configuration."Storage partition configuration"</b> <b>Resource."Assign virtual machine to resource pool"</b> <b>VApp."Assign resource pool"</b> <b>VApp.Import</b> <b>"Virtual machine"."Change Configuration"."Add new disk"</b>
vSphere vCenter Resource Pool	If an existing resource pool is provided	<b>Host.Configuration."Storage partition configuration"</b> <b>Resource."Assign virtual machine to resource pool"</b> <b>VApp."Assign resource pool"</b> <b>VApp.Import</b> <b>"Virtual machine"."Change Configuration"."Add new disk"</b>
vSphere Datastore	Always	<b>Datastore."Allocate space"</b> <b>Datastore."Browse datastore"</b> <b>Datastore."Low level file operations"</b> <b>"vSphere Tagging"."Assign or Unassign vSphere Tag on Object"</b>
vSphere Port Group	Always	<b>Network."Assign network"</b>
Virtual Machine Folder	Always	<b>"vSphere Tagging"."Assign or Unassign vSphere Tag on Object"</b> <b>Resource."Assign virtual machine to resource pool"</b> <b>VApp.Import</b> <b>"Virtual machine"."Change Configuration"."Add existing disk"</b> <b>"Virtual machine"."Change Configuration"."Add new disk"</b> <b>"Virtual machine"."Change Configuration"."Add or remove device"</b> <b>"Virtual machine"."Change Configuration"."Advanced configuration"</b>

vSphere object for role	When required	"Virtual machine"."Change Configuration".Set annotation" Required privileges in vCenter GUI
		"Virtual machine"."Change Configuration"."Change CPU count" "Virtual machine"."Change Configuration"."Extend virtual disk" "Virtual machine"."Change Configuration"."Acquire disk lease" "Virtual machine"."Change Configuration"."Modify device settings" "Virtual machine"."Change Configuration"."Change Memory" "Virtual machine"."Change Configuration"."Remove disk" "Virtual machine"."Change Configuration".Rename "Virtual machine"."Change Configuration"."Reset guest information" "Virtual machine"."Change Configuration"."Change resource" "Virtual machine"."Change Configuration"."Change Settings" "Virtual machine"."Change Configuration"."Upgrade virtual machine compatibility" "Virtual machine".Interaction."Guest operating system management by VIX API" "Virtual machine".Interaction."Power off" "Virtual machine".Interaction."Power on" "Virtual machine".Interaction.Reset "Virtual machine"."Edit Inventory"."Create new" "Virtual machine"."Edit Inventory"."Create from existing" "Virtual machine"."Edit Inventory"."Remove" "Virtual

vSphere object for role	When required	Required privileges in vCenter GUI
		<b>machine".Provisioning."Close virtual machine"</b> <b>machine".Provisioning."Mark as template"</b> <b>"Virtual machine".Provisioning."Deploy template"</b>
vSphere vCenter Datacenter	If the installation program creates the virtual machine folder	<b>"vSphere Tagging". "Assign or Unassign vSphere Tag on Object"</b> <b>Resource."Assign virtual machine to resource pool"</b> <b>VApp.Import</b> <b>"Virtual machine". "Change Configuration". "Add existing disk"</b> <b>"Virtual machine". "Change Configuration". "Add new disk"</b> <b>"Virtual machine". "Change Configuration". "Add or remove device"</b> <b>"Virtual machine". "Change Configuration". "Advanced configuration"</b> <b>"Virtual machine". "Change Configuration". "Set annotation"</b> <b>"Virtual machine". "Change Configuration". "Change CPU count"</b> <b>"Virtual machine". "Change Configuration". "Extend virtual disk"</b> <b>"Virtual machine". "Change Configuration". "Acquire disk lease"</b> <b>"Virtual machine". "Change Configuration". "Modify device settings"</b> <b>"Virtual machine". "Change Configuration". "Change Memory"</b> <b>"Virtual machine". "Change Configuration". "Remove disk"</b> <b>"Virtual machine". "Change Configuration". Rename</b> <b>"Virtual machine". "Change Configuration". "Reset guest information"</b> <b>"Virtual machine". "Change Configuration". "Change resource"</b>

vSphere object for role	When required	"Virtual machine"."Change Configuration"."Change Settings"
		"Virtual machine"."Change Configuration"."Upgrade virtual machine compatibility" "Virtual machine".Interaction."Guest operating system management by VIX API" "Virtual machine".Interaction."Power off" "Virtual machine".Interaction."Power on" "Virtual machine".Interaction.Reset "Virtual machine"."Edit Inventory"."Create new" "Virtual machine"."Edit Inventory"."Create from existing" "Virtual machine"."Edit Inventory"."Remove" "Virtual machine".Provisioning."Clone virtual machine" "Virtual machine".Provisioning."Deploy template" "Virtual machine".Provisioning."Mark as template" Folder."Create folder" Folder."Delete folder"

Additionally, the user requires some **ReadOnly** permissions, and some of the roles require permission to propagate the permissions to child objects. These settings vary depending on whether or not you install the cluster into an existing folder.

**Example 20.3. Required permissions and propagation settings**

vSphere object	When required	Propagate to children	Permissions required
vSphere vCenter	Always	False	Listed required privileges
vSphere vCenter Datacenter	Existing folder	False	<b>ReadOnly</b> permission

vSphere object	When required	Propagate to children	Permissions required
	Installation program creates the folder	True	Listed required privileges
vSphere vCenter Cluster	Existing resource pool	False	<b>ReadOnly</b> permission
	VMs in cluster root	True	Listed required privileges
vSphere vCenter Datastore	Always	False	Listed required privileges
vSphere Switch	Always	False	<b>ReadOnly</b> permission
vSphere Port Group	Always	False	Listed required privileges
vSphere vCenter Virtual Machine Folder	Existing folder	True	Listed required privileges
vSphere vCenter Resource Pool	Existing resource pool	True	Listed required privileges

For more information about creating an account with only the required privileges, see [vSphere Permissions and User Management Tasks](#) in the vSphere documentation.

### Using OpenShift Container Platform with vMotion

If you intend on using vMotion in your vSphere environment, consider the following before installing a OpenShift Container Platform cluster.

- OpenShift Container Platform generally supports compute-only vMotion. Using Storage vMotion can cause issues and is not supported.  
To help ensure the uptime of your compute and control plane nodes, it is recommended that you follow the VMware best practices for vMotion. It is also recommended to use VMware anti-affinity rules to improve the availability of OpenShift Container Platform during maintenance or hardware issues.

For more information about vMotion and anti-affinity rules, see the VMware vSphere documentation for [vMotion networking requirements](#) and [VM anti-affinity rules](#).

- If you are using vSphere volumes in your pods, migrating a VM across datastores either manually or through Storage vMotion causes, invalid references within OpenShift Container Platform persistent volume (PV) objects. These references prevent affected pods from starting up and can result in data loss.
- Similarly, OpenShift Container Platform does not support selective migration of VMDKs across datastores, using datastore clusters for VM provisioning or for dynamic or static provisioning of PVs, or using a datastore that is part of a datastore cluster for dynamic or static provisioning of PVs.

### Cluster resources

When you deploy an OpenShift Container Platform cluster that uses installer-provisioned infrastructure, the installation program must be able to create several resources in your vCenter instance.

A standard OpenShift Container Platform installation creates the following vCenter resources:

- 1 Folder
- 1 Tag category
- 1 Tag
- Virtual machines:
  - 1 template
  - 1 temporary bootstrap node
  - 3 control plane nodes
  - 3 compute machines

Although these resources use 856 GB of storage, the bootstrap node is destroyed during the cluster installation process. A minimum of 800 GB of storage is required to use a standard cluster.

If you deploy more compute machines, the OpenShift Container Platform cluster will use more storage.

### Cluster limits

Available resources vary between clusters. The number of possible clusters within a vCenter is limited primarily by available storage space and any limitations on the number of required resources. Be sure to consider both limitations to the vCenter resources that the cluster creates and the resources that you require to deploy a cluster, such as IP addresses and networks.

### Networking requirements

You must use the Dynamic Host Configuration Protocol (DHCP) for the network and ensure that the DHCP server is configured to provide persistent IP addresses to the cluster machines. In the DHCP lease, you must configure the DHCP to use the default gateway. All nodes must be in the same VLAN. You cannot scale the cluster using a second VLAN as a Day 2 operation. Additionally, you must create the following networking resources before you install the OpenShift Container Platform cluster:



#### NOTE

It is recommended that each OpenShift Container Platform node in the cluster must have access to a Network Time Protocol (NTP) server that is discoverable via DHCP. Installation is possible without an NTP server. However, asynchronous server clocks will cause errors, which NTP server prevents.

### Required IP Addresses

An installer-provisioned vSphere installation requires two static IP addresses:

- The **API** address is used to access the cluster API.
- The **Ingress** address is used for cluster ingress traffic.

You must provide these IP addresses to the installation program when you install the OpenShift Container Platform cluster.

## DNS records

You must create DNS records for two static IP addresses in the appropriate DNS server for the vCenter instance that hosts your OpenShift Container Platform cluster. In each record, **<cluster\_name>** is the cluster name and **<base\_domain>** is the cluster base domain that you specify when you install the cluster. A complete DNS record takes the form: **<component>.<cluster\_name>.<base\_domain>..**

**Table 20.8. Required DNS records**

Component	Record	Description
API VIP	<b>api.&lt;cluster_name&gt;.&lt;base_domain&gt;.</b>	This DNS A/AAAA or CNAME record must point to the load balancer for the control plane machines. This record must be resolvable by both clients external to the cluster and from all the nodes within the cluster.
Ingress VIP	<b>*.apps.&lt;cluster_name&gt;.&lt;base_domain&gt;.</b>	A wildcard DNS A/AAAA or CNAME record that points to the load balancer that targets the machines that run the Ingress router pods, which are the worker nodes by default. This record must be resolvable by both clients external to the cluster and from all the nodes within the cluster.

### 20.2.7. Generating a key pair for cluster node SSH access

During an OpenShift Container Platform installation, you can provide an SSH public key to the installation program. The key is passed to the Red Hat Enterprise Linux CoreOS (RHCOS) nodes through their Ignition config files and is used to authenticate SSH access to the nodes. The key is added to the **~/.ssh/authorized\_keys** list for the **core** user on each node, which enables password-less authentication.

After the key is passed to the nodes, you can use the key pair to SSH in to the RHCOS nodes as the user **core**. To access the nodes through SSH, the private key identity must be managed by SSH for your local user.

If you want to SSH in to your cluster nodes to perform installation debugging or disaster recovery, you must provide the SSH public key during the installation process. The **./openshift-install gather** command also requires the SSH public key to be in place on the cluster nodes.



#### IMPORTANT

Do not skip this procedure in production environments, where disaster recovery and debugging is required.

**NOTE**

You must use a local key, not one that you configured with platform-specific approaches such as [AWS key pairs](#).

**Procedure**

1. If you do not have an existing SSH key pair on your local machine to use for authentication onto your cluster nodes, create one. For example, on a computer that uses a Linux operating system, run the following command:

```
$ ssh-keygen -t ed25519 -N "" -f <path>/<file_name> 1
```

- 1 Specify the path and file name, such as `~/.ssh/id_ed25519`, of the new SSH key. If you have an existing key pair, ensure your public key is in the your `~/.ssh` directory.

**NOTE**

If you plan to install an OpenShift Container Platform cluster that uses FIPS validated or Modules In Process cryptographic libraries on the **x86\_64** architecture, do not create a key that uses the **ed25519** algorithm. Instead, create a key that uses the **rsa** or **ecdsa** algorithm.

2. View the public SSH key:

```
$ cat <path>/<file_name>.pub
```

For example, run the following to view the `~/.ssh/id_ed25519.pub` public key:

```
$ cat ~/.ssh/id_ed25519.pub
```

3. Add the SSH private key identity to the SSH agent for your local user, if it has not already been added. SSH agent management of the key is required for password-less SSH authentication onto your cluster nodes, or if you want to use the `./openshift-install gather` command.

**NOTE**

On some distributions, default SSH private key identities such as `~/.ssh/id_rsa` and `~/.ssh/id_dsa` are managed automatically.

- a. If the **ssh-agent** process is not already running for your local user, start it as a background task:

```
$ eval "$(ssh-agent -s)"
```

**Example output**

```
Agent pid 31874
```

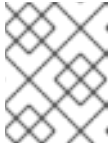

**NOTE**

If your cluster is in FIPS mode, only use FIPS-compliant algorithms to generate the SSH key. The key must be either RSA or ECDSA.

4. Add your SSH private key to the **ssh-agent**:

```
$ ssh-add <path>/<file_name> 1
```

- 1** Specify the path and file name for your SSH private key, such as `~/.ssh/id_ed25519`

**Example output**

```
Identity added: /home/<you>/<path>/<file_name> (<computer_name>)
```

**Next steps**

- When you install OpenShift Container Platform, provide the SSH public key to the installation program.

**20.2.8. Obtaining the installation program**

Before you install OpenShift Container Platform, download the installation file on a local computer.

**Prerequisites**

- You have a computer that runs Linux or macOS, with 500 MB of local disk space

**Procedure**

1. Access the [Infrastructure Provider](#) page on the OpenShift Cluster Manager site. If you have a Red Hat account, log in with your credentials. If you do not, create an account.
2. Select your infrastructure provider.
3. Navigate to the page for your installation type, download the installation program that corresponds with your host operating system and architecture, and place the file in the directory where you will store the installation configuration files.

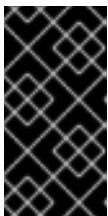
**IMPORTANT**

The installation program creates several files on the computer that you use to install your cluster. You must keep the installation program and the files that the installation program creates after you finish installing the cluster. Both files are required to delete the cluster.

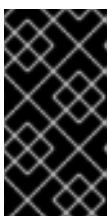
**IMPORTANT**

Deleting the files created by the installation program does not remove your cluster, even if the cluster failed during installation. To remove your cluster, complete the OpenShift Container Platform uninstallation procedures for your specific cloud provider.

4. Extract the installation program. For example, on a computer that uses a Linux operating system, run the following command:

```
$ tar -xvf openshift-install-linux.tar.gz
```

5. Download your installation [pull secret from the Red Hat OpenShift Cluster Manager](#) . This pull secret allows you to authenticate with the services that are provided by the included authorities, including Quay.io, which serves the container images for OpenShift Container Platform components.

### 20.2.9. Adding vCenter root CA certificates to your system trust

Because the installation program requires access to your vCenter's API, you must add your vCenter's trusted root CA certificates to your system trust before you install an OpenShift Container Platform cluster.

#### Procedure

1. From the vCenter home page, download the vCenter's root CA certificates. Click **Download trusted root CA certificates** in the vSphere Web Services SDK section. The **<vCenter>/certs/download.zip** file downloads.
2. Extract the compressed file that contains the vCenter root CA certificates. The contents of the compressed file resemble the following file structure:

```
certs
├── lin
│   ├── 108f4d17.0
│   ├── 108f4d17.r1
│   ├── 7e757f6a.0
│   ├── 8e4f8471.0
│   └── 8e4f8471.r0
├── mac
│   ├── 108f4d17.0
│   ├── 108f4d17.r1
│   ├── 7e757f6a.0
│   ├── 8e4f8471.0
│   └── 8e4f8471.r0
└── win
    ├── 108f4d17.0.crt
    ├── 108f4d17.r1.crl
    ├── 7e757f6a.0.crt
    ├── 8e4f8471.0.crt
    └── 8e4f8471.r0.crl
```

3 directories, 15 files

3. Add the files for your operating system to the system trust. For example, on a Fedora operating system, run the following command:

```
# cp certs/lin/* /etc/pki/ca-trust/source/anchors
```

4. Update your system trust. For example, on a Fedora operating system, run the following command:

-

```
# update-ca-trust extract
```

## 20.2.10. Deploying the cluster

You can install OpenShift Container Platform on a compatible cloud platform.

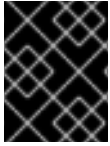

### IMPORTANT

You can run the **create cluster** command of the installation program only once, during initial installation.

### Prerequisites

- Obtain the OpenShift Container Platform installation program and the pull secret for your cluster.

### Procedure

1. Change to the directory that contains the installation program and initialize the cluster deployment:

```
$ ./openshift-install create cluster --dir <installation_directory> \ 1  
--log-level=info 2
```

- 1** For **<installation\_directory>**, specify the directory name to store the files that the installation program creates.
- 2** To view different installation details, specify **warn**, **debug**, or **error** instead of **info**.

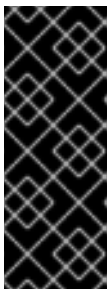

### IMPORTANT

Specify an empty directory. Some installation assets, like bootstrap X.509 certificates have short expiration intervals, so you must not reuse an installation directory. If you want to reuse individual files from another cluster installation, you can copy them into your directory. However, the file names for the installation assets might change between releases. Use caution when copying installation files from an earlier OpenShift Container Platform version.

Provide values at the prompts:

- a. Optional: Select an SSH key to use to access your cluster machines.



### NOTE

For production OpenShift Container Platform clusters on which you want to perform installation debugging or disaster recovery, specify an SSH key that your **ssh-agent** process uses.

- b. Select **vsphere** as the platform to target.
- c. Specify the name of your vCenter instance.

- d. Specify the user name and password for the vCenter account that has the required permissions to create the cluster.  
The installation program connects to your vCenter instance.
- e. Select the datacenter in your vCenter instance to connect to.
- f. Select the default vCenter datastore to use.

**NOTE**

Datastore and cluster names cannot exceed 60 characters; therefore, ensure the combined string length does not exceed the 60 character limit.

- g. Select the vCenter cluster to install the OpenShift Container Platform cluster in. The installation program uses the root resource pool of the vSphere cluster as the default resource pool.
- h. Select the network in the vCenter instance that contains the virtual IP addresses and DNS records that you configured.
- i. Enter the virtual IP address that you configured for control plane API access.
- j. Enter the virtual IP address that you configured for cluster ingress.
- k. Enter the base domain. This base domain must be the same one that you used in the DNS records that you configured.
- l. Enter a descriptive name for your cluster. The cluster name must be the same one that you used in the DNS records that you configured.

**NOTE**

Datastore and cluster names cannot exceed 60 characters; therefore, ensure the combined string length does not exceed the 60 character limit.

- m. Paste the [pull secret from the Red Hat OpenShift Cluster Manager](#) .

+ When the cluster deployment completes, directions for accessing your cluster, including a link to its web console and credentials for the **kubeadmin** user, display in your terminal.

+ .Example output

```
...
INFO Install complete!
INFO To access the cluster as the system:admin user when using 'oc', run 'export
KUBECONFIG=/home/myuser/install_dir/auth/kubeconfig'
INFO Access the OpenShift web-console here: https://console-openshift-
console.apps.mycluster.example.com
INFO Login to the console with user: "kubeadmin", and password: "4vYBz-Ee6gm-ymBZj-Wt5AL"
INFO Time elapsed: 36m22s
```

+

**NOTE**

The cluster access and credential information also outputs to `<installation_directory>/openshift_install.log` when an installation succeeds.

+

**IMPORTANT**

- The Ignition config files that the installation program generates contain certificates that expire after 24 hours, which are then renewed at that time. If the cluster is shut down before renewing the certificates and the cluster is later restarted after the 24 hours have elapsed, the cluster automatically recovers the expired certificates. The exception is that you must manually approve the pending **node-bootstrapper** certificate signing requests (CSRs) to recover kubelet certificates. See the documentation for *Recovering from expired control plane certificates* for more information.
- It is recommended that you use Ignition config files within 12 hours after they are generated because the 24-hour certificate rotates from 16 to 22 hours after the cluster is installed. By using the Ignition config files within 12 hours, you can avoid installation failure if the certificate update runs during installation.

+

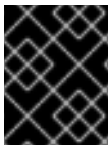
**IMPORTANT**

You must not delete the installation program or the files that the installation program creates. Both are required to delete the cluster.

### 20.2.11. Installing the OpenShift CLI by downloading the binary

You can install the OpenShift CLI (**oc**) to interact with OpenShift Container Platform from a command-line interface. You can install **oc** on Linux, Windows, or macOS.

**IMPORTANT**

If you installed an earlier version of **oc**, you cannot use it to complete all of the commands in OpenShift Container Platform 4.10. Download and install the new version of **oc**.

#### Installing the OpenShift CLI on Linux

You can install the OpenShift CLI (**oc**) binary on Linux by using the following procedure.

#### Procedure

1. Navigate to the [OpenShift Container Platform downloads page](#) on the Red Hat Customer Portal.
2. Select the appropriate version in the **Version** drop-down menu.
3. Click **Download Now** next to the **OpenShift v4.10 Linux Client** entry and save the file.
4. Unpack the archive:
  -

```
$ tar xvf <file>
```

5. Place the **oc** binary in a directory that is on your **PATH**.  
To check your **PATH**, execute the following command:

```
$ echo $PATH
```

After you install the OpenShift CLI, it is available using the **oc** command:

```
$ oc <command>
```

### Installing the OpenShift CLI on Windows

You can install the OpenShift CLI (**oc**) binary on Windows by using the following procedure.

#### Procedure

1. Navigate to the [OpenShift Container Platform downloads page](#) on the Red Hat Customer Portal.
2. Select the appropriate version in the **Version** drop-down menu.
3. Click **Download Now** next to the **OpenShift v4.10 Windows Client** entry and save the file.
4. Unzip the archive with a ZIP program.
5. Move the **oc** binary to a directory that is on your **PATH**.  
To check your **PATH**, open the command prompt and execute the following command:

```
C:\> path
```

After you install the OpenShift CLI, it is available using the **oc** command:

```
C:\> oc <command>
```

### Installing the OpenShift CLI on macOS

You can install the OpenShift CLI (**oc**) binary on macOS by using the following procedure.

#### Procedure

1. Navigate to the [OpenShift Container Platform downloads page](#) on the Red Hat Customer Portal.
2. Select the appropriate version in the **Version** drop-down menu.
3. Click **Download Now** next to the **OpenShift v4.10 MacOSX Client** entry and save the file.
4. Unpack and unzip the archive.
5. Move the **oc** binary to a directory on your **PATH**.  
To check your **PATH**, open a terminal and execute the following command:

```
$ echo $PATH
```

After you install the OpenShift CLI, it is available using the **oc** command:

```
$ oc <command>
```

## 20.2.12. Logging in to the cluster by using the CLI

You can log in to your cluster as a default system user by exporting the cluster **kubeconfig** file. The **kubeconfig** file contains information about the cluster that is used by the CLI to connect a client to the correct cluster and API server. The file is specific to a cluster and is created during OpenShift Container Platform installation.

### Prerequisites

- You deployed an OpenShift Container Platform cluster.
- You installed the **oc** CLI.

### Procedure

1. Export the **kubeadmin** credentials:

```
$ export KUBECONFIG=<installation_directory>/auth/kubeconfig 1
```

- 1** For **<installation\_directory>**, specify the path to the directory that you stored the installation files in.

2. Verify you can run **oc** commands successfully using the exported configuration:

```
$ oc whoami
```

### Example output

```
system:admin
```

## 20.2.13. Creating registry storage

After you install the cluster, you must create storage for the registry Operator.

### 20.2.13.1. Image registry removed during installation

On platforms that do not provide shareable object storage, the OpenShift Image Registry Operator bootstraps itself as **Removed**. This allows **openshift-installer** to complete installations on these platform types.

After installation, you must edit the Image Registry Operator configuration to switch the **managementState** from **Removed** to **Managed**.

### 20.2.13.2. Image registry storage configuration

The Image Registry Operator is not initially available for platforms that do not provide default storage. After installation, you must configure your registry to use storage so that the Registry Operator is made available.

Instructions are shown for configuring a persistent volume, which is required for production clusters. Where applicable, instructions are shown for configuring an empty directory as the storage location, which is available for only non-production clusters.

Additional instructions are provided for allowing the image registry to use block storage types by using the **Recreate** rollout strategy during upgrades.

### 20.2.13.2.1. Configuring registry storage for VMware vSphere

As a cluster administrator, following installation you must configure your registry to use storage.

#### Prerequisites

- Cluster administrator permissions.
- A cluster on VMware vSphere.
- Persistent storage provisioned for your cluster, such as Red Hat OpenShift Data Foundation.

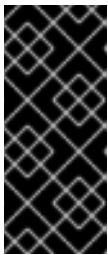

#### IMPORTANT

OpenShift Container Platform supports **ReadWriteOnce** access for image registry storage when you have only one replica. **ReadWriteOnce** access also requires that the registry uses the **Recreate** rollout strategy. To deploy an image registry that supports high availability with two or more replicas, **ReadWriteMany** access is required.

- Must have "100Gi" capacity.

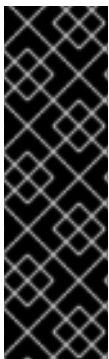

#### IMPORTANT

Testing shows issues with using the NFS server on RHEL as storage backend for core services. This includes the OpenShift Container Registry and Quay, Prometheus for monitoring storage, and Elasticsearch for logging storage. Therefore, using RHEL NFS to back PVs used by core services is not recommended.

Other NFS implementations on the marketplace might not have these issues. Contact the individual NFS implementation vendor for more information on any testing that was possibly completed against these OpenShift Container Platform core components.

#### Procedure

1. To configure your registry to use storage, change the **spec.storage.pvc** in the **configs.imageregistry/cluster** resource.



#### NOTE

When using shared storage, review your security settings to prevent outside access.



- Verify that you do not have a registry pod:

```
$ oc get pod -n openshift-image-registry -l docker-registry=default
```

### Example output

```
No resources found in openshift-image-registry namespace
```



### NOTE

If you do have a registry pod in your output, you do not need to continue with this procedure.

- Check the registry configuration:

```
$ oc edit configs.imageregistry.operator.openshift.io
```

### Example output

```
storage:
  pvc:
    claim: 1
```

- Leave the **claim** field blank to allow the automatic creation of an **image-registry-storage** persistent volume claim (PVC). The PVC is generated based on the default storage class. However, be aware that the default storage class might provide ReadWriteOnce (RWO) volumes, such as a RADOS Block Device (RBD), which can cause issues when replicating to more than one replica.

- Check the **clusteroperator** status:

```
$ oc get clusteroperator image-registry
```

### Example output

NAME	VERSION	AVAILABLE	PROGRESSING	DEGRADED
image-registry	4.7	True	False	False

#### 20.2.13.2.2. Configuring block registry storage for VMware vSphere

To allow the image registry to use block storage types such as vSphere Virtual Machine Disk (VMDK) during upgrades as a cluster administrator, you can use the **Recreate** rollout strategy.



### IMPORTANT

Block storage volumes are supported but not recommended for use with image registry on production clusters. An installation where the registry is configured on block storage is not highly available because the registry cannot have more than one replica.

## Procedure

- To set the image registry storage as a block storage type, patch the registry so that it uses the **Recreate** rollout strategy and runs with only **1** replica:

```
$ oc patch config.imageregistry.operator.openshift.io/cluster --type=merge -p '{"spec": {"rolloutStrategy": "Recreate", "replicas": 1}}'
```

- Provision the PV for the block storage device, and create a PVC for that volume. The requested block volume uses the ReadWriteOnce (RWO) access mode.
  - Create a **pvc.yaml** file with the following contents to define a VMware vSphere **PersistentVolumeClaim** object:

```
kind: PersistentVolumeClaim
apiVersion: v1
metadata:
  name: image-registry-storage 1
  namespace: openshift-image-registry 2
spec:
  accessModes:
    - ReadWriteOnce 3
  resources:
    requests:
      storage: 100Gi 4
```

- A unique name that represents the **PersistentVolumeClaim** object.
- The namespace for the **PersistentVolumeClaim** object, which is **openshift-image-registry**.
- The access mode of the persistent volume claim. With **ReadWriteOnce**, the volume can be mounted with read and write permissions by a single node.
- The size of the persistent volume claim.

- Create the **PersistentVolumeClaim** object from the file:

```
$ oc create -f pvc.yaml -n openshift-image-registry
```

- Edit the registry configuration so that it references the correct PVC:

```
$ oc edit config.imageregistry.operator.openshift.io -o yaml
```

## Example output

```
storage:
  pvc:
    claim: 1
```

- Creating a custom PVC allows you to leave the **claim** field blank for the default automatic creation of an **image-registry-storage** PVC.

For instructions about configuring registry storage so that it references the correct PVC, see [Configuring the registry for vSphere](#).

### 20.2.14. Backing up VMware vSphere volumes

OpenShift Container Platform provisions new volumes as independent persistent disks to freely attach and detach the volume on any node in the cluster. As a consequence, it is not possible to back up volumes that use snapshots, or to restore volumes from snapshots. See [Snapshot Limitations](#) for more information.

#### Procedure

To create a backup of persistent volumes:

1. Stop the application that is using the persistent volume.
2. Clone the persistent volume.
3. Restart the application.
4. Create a backup of the cloned volume.
5. Delete the cloned volume.

### 20.2.15. Telemetry access for OpenShift Container Platform

In OpenShift Container Platform 4.10, the Telemetry service, which runs by default to provide metrics about cluster health and the success of updates, requires internet access. If your cluster is connected to the internet, Telemetry runs automatically, and your cluster is registered to [OpenShift Cluster Manager](#).

After you confirm that your [OpenShift Cluster Manager](#) inventory is correct, either maintained automatically by Telemetry or manually by using OpenShift Cluster Manager, [use subscription watch](#) to track your OpenShift Container Platform subscriptions at the account or multi-cluster level.

#### Additional resources

- See [About remote health monitoring](#) for more information about the Telemetry service

### 20.2.16. Next steps

- [Customize your cluster](#).
- If necessary, you can [opt out of remote health reporting](#).
- [Set up your registry and configure registry storage](#).
- Optional: [View the events from the vSphere Problem Detector Operator](#) to determine if the cluster has permission or storage configuration issues.

## 20.3. INSTALLING A CLUSTER ON VSPHERE WITH CUSTOMIZATIONS

In OpenShift Container Platform version 4.10, you can install a cluster on your VMware vSphere instance by using installer-provisioned infrastructure. To customize the installation, you modify parameters in the **install-config.yaml** file before you install the cluster.

**NOTE**

OpenShift Container Platform supports deploying a cluster to a single VMware vCenter only. Deploying a cluster with machines/machine sets on multiple vCenters is not supported.

### 20.3.1. Prerequisites

- You reviewed details about the [OpenShift Container Platform installation and update](#) processes.
- You read the documentation on [selecting a cluster installation method and preparing it for users](#).
- You provisioned [persistent storage](#) for your cluster. To deploy a private image registry, your storage must provide **ReadWriteMany** access modes.
- The OpenShift Container Platform installer requires access to port 443 on the vCenter and ESXi hosts. You verified that port 443 is accessible.
- If you use a firewall, you confirmed with the administrator that port 443 is accessible. Control plane nodes must be able to reach vCenter and ESXi hosts on port 443 for the installation to succeed.
- If you use a firewall, you [configured it to allow the sites](#) that your cluster requires access to.

**NOTE**

Be sure to also review this site list if you are configuring a proxy.

### 20.3.2. Internet access for OpenShift Container Platform

In OpenShift Container Platform 4.10, you require access to the internet to install your cluster.

You must have internet access to:

- Access [OpenShift Cluster Manager](#) to download the installation program and perform subscription management. If the cluster has internet access and you do not disable Telemetry, that service automatically entitles your cluster.
- Access [Quay.io](#) to obtain the packages that are required to install your cluster.
- Obtain the packages that are required to perform cluster updates.

**IMPORTANT**

If your cluster cannot have direct internet access, you can perform a restricted network installation on some types of infrastructure that you provision. During that process, you download the required content and use it to populate a mirror registry with the installation packages. With some installation types, the environment that you install your cluster in will not require internet access. Before you update the cluster, you update the content of the mirror registry.

### 20.3.3. VMware vSphere infrastructure requirements

You must install the OpenShift Container Platform cluster on a VMware vSphere version 7 instance that meets the requirements for the components that you use.



### NOTE

OpenShift Container Platform version 4.10 does not support VMware vSphere version 8.0.

You can host the VMware vSphere infrastructure on-premise or on a [VMware Cloud Verified provider](#) that meets the requirements outlined in the following table:

**Table 20.9. Version requirements for vSphere virtual environments**

Virtual environment product	Required version
VM hardware version	15 or later
vSphere ESXi hosts	7
vCenter host	7



### IMPORTANT

Installing a cluster on VMware vSphere version 7.0 Update 1 is now deprecated. These versions are still fully supported, but version 4.10 of OpenShift Container Platform requires vSphere virtual hardware version 15 or later. Hardware version 15 is now the default for vSphere virtual machines in OpenShift Container Platform. To update the hardware version for your vSphere nodes, see the "Updating hardware on nodes running in vSphere" article.

If your vSphere nodes are below hardware version 15 or your VMware vSphere version is earlier than 6.7U3, upgrading from OpenShift Container Platform 4.10 to OpenShift Container Platform 4.11 is not available.

**Table 20.10. Minimum supported vSphere version for VMware components**

Component	Minimum supported versions	Description
Hypervisor	vSphere 7 with HW version 15	This version is the minimum version that Red Hat Enterprise Linux CoreOS (RHCOS) supports. For more information about supported hardware on the latest version of Red Hat Enterprise Linux (RHEL) that is compatible with RHCOS, see <a href="#">Hardware</a> on the Red Hat Customer Portal.

Component	Minimum supported versions	Description
Storage with in-tree drivers	vSphere 7	This plugin creates vSphere storage by using the in-tree storage drivers for vSphere included in OpenShift Container Platform.
Optional: Networking (NSX-T)	vSphere 7	vSphere 7 is required for OpenShift Container Platform. For more information about the compatibility of NSX and OpenShift Container Platform, see the Release Notes section of VMware's <a href="#">NSX container plugin documentation</a> .

If you use a vSphere version 6.5 instance, upgrade to 7.0 before you install OpenShift Container Platform.

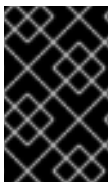

### IMPORTANT

You must ensure that the time on your ESXi hosts is synchronized before you install OpenShift Container Platform. See [Edit Time Configuration for a Host](#) in the VMware documentation.

## 20.3.4. Network connectivity requirements

You must configure the network connectivity between machines to allow OpenShift Container Platform cluster components to communicate.

Review the following details about the required network ports.

**Table 20.11. Ports used for all-machine to all-machine communications**

Protocol	Port	Description
ICMP	N/A	Network reachability tests
TCP	<b>1936</b>	Metrics
	<b>9000-9999</b>	Host level services, including the node exporter on ports <b>9100-9101</b> and the Cluster Version Operator on port <b>9099</b> .
	<b>10250-10259</b>	The default ports that Kubernetes reserves
	<b>10256</b>	openshift-sdn
UDP	<b>4789</b>	virtual extensible LAN (VXLAN)

Protocol	Port	Description
	<b>6081</b>	Geneve
	<b>9000-9999</b>	Host level services, including the node exporter on ports <b>9100-9101</b> .
	<b>500</b>	IPsec IKE packets
	<b>4500</b>	IPsec NAT-T packets
TCP/UDP	<b>30000-32767</b>	Kubernetes node port
ESP	N/A	IPsec Encapsulating Security Payload (ESP)

Table 20.12. Ports used for all-machine to control plane communications

Protocol	Port	Description
TCP	<b>6443</b>	Kubernetes API

Table 20.13. Ports used for control plane machine to control plane machine communications

Protocol	Port	Description
TCP	<b>2379-2380</b>	etcd server and peer ports

### 20.3.5. VMware vSphere CSI Driver Operator requirements

To install the vSphere CSI Driver Operator, the following requirements must be met:

- VMware vSphere version 6.7U3 or later
- Virtual machines of hardware version 15 or later
- No third-party vSphere CSI driver already installed in the cluster

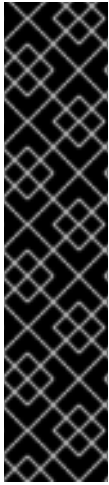

## IMPORTANT

If a third-party vSphere CSI driver is present in the cluster, OpenShift Container Platform does not overwrite it. If you continue with the third-party vSphere CSI driver when upgrading to the next major version of OpenShift Container Platform, the **oc** CLI prompts you with the following message:

```
VSphereCSIDriverOperatorCRUpgradeable: VMwareVSphereControllerUpgradeable:
found existing unsupported csi.vsphere.vmware.com driver
```

The previous message informs you that Red Hat does not support the third-party vSphere CSI driver during an OpenShift Container Platform upgrade operation. You can choose to ignore this message and continue with the upgrade operation.

### Additional resources

- To remove a third-party vSphere CSI driver, see [Removing a third-party vSphere CSI Driver](#).
- To update the hardware version for your vSphere nodes, see [Updating hardware on nodes running in vSphere](#).

## 20.3.6. vCenter requirements

Before you install an OpenShift Container Platform cluster on your vCenter that uses infrastructure that the installer provisions, you must prepare your environment.

### Required vCenter account privileges

To install an OpenShift Container Platform cluster in a vCenter, the installation program requires access to an account with privileges to read and create the required resources. Using an account that has global administrative privileges is the simplest way to access all of the necessary permissions.

If you cannot use an account with global administrative privileges, you must create roles to grant the privileges necessary for OpenShift Container Platform cluster installation. While most of the privileges are always required, some are required only if you plan for the installation program to provision a folder to contain the OpenShift Container Platform cluster on your vCenter instance, which is the default behavior. You must create or amend vSphere roles for the specified objects to grant the required privileges.

An additional role is required if the installation program is to create a vSphere virtual machine folder.

### Example 20.4. Roles and privileges required for installation in vSphere API

vSphere object for role	When required	Required privileges in vSphere API
-------------------------	---------------	------------------------------------



vSphere object for role	When required	Required privileges in vSphere API
vSphere vCenter	Always	<b>Cns.Searchable</b> <b>InventoryService.Tagging.AttachTag</b> <b>InventoryService.Tagging.CreateCategory</b> <b>InventoryService.Tagging.CreateTag</b> <b>InventoryService.Tagging.DeleteCategory</b> <b>InventoryService.Tagging.DeleteTag</b> <b>InventoryService.Tagging.EditCategory</b> <b>InventoryService.Tagging.EditTag</b> <b>Sessions.ValidateSession</b> <b>StorageProfile.Update</b> <b>StorageProfile.View</b>
vSphere vCenter Cluster	If VMs will be created in the cluster root	<b>Host.Config.StorageResource.AssignVMToPool</b> <b>VApp.AssignResourcePool</b> <b>VApp.Import</b> <b>VirtualMachine.Config.AddNewDisk</b>
vSphere vCenter Resource Pool	If an existing resource pool is provided	<b>Host.Config.StorageResource.AssignVMToPool</b> <b>VApp.AssignResourcePool</b> <b>VApp.Import</b> <b>VirtualMachine.Config.AddNewDisk</b>
vSphere Datastore	Always	<b>Datastore.AllocateSpace</b> <b>Datastore.Browse</b> <b>Datastore.FileManagement</b> <b>InventoryService.Tagging.ObjectAttachable</b>
vSphere Port Group	Always	<b>Network.Assign</b>
Virtual Machine Folder	Always	<b>InventoryService.Tagging.ObjectAttachable</b> <b>Resource.AssignVMToPool</b> <b>VApp.Import</b> <b>VirtualMachine.Config.AddExistingDisk</b> <b>VirtualMachine.Config.AddNewDisk</b> <b>VirtualMachine.Config.Add</b>

vSphere object for role	When required	RemoveDevice Required privileges in vSphere API
		VirtualMachine.Config.AdvancedConfig VirtualMachine.Config.Annotation VirtualMachine.Config.CPUCount VirtualMachine.Config.DiskExtend VirtualMachine.Config.DiskLease VirtualMachine.Config.EditDevice VirtualMachine.Config.Memory VirtualMachine.Config.RemoveDisk VirtualMachine.Config.Rename VirtualMachine.Config.ResetGuestInfo VirtualMachine.Config.Resource VirtualMachine.Config.Settings VirtualMachine.Config.UpgradeVirtualHardware VirtualMachine.Interact.GuestControl VirtualMachine.Interact.PowerOff VirtualMachine.Interact.PowerOn VirtualMachine.Interact.Reset VirtualMachine.Inventory.Create VirtualMachine.Inventory.CreateFromExisting VirtualMachine.Inventory.Delete VirtualMachine.Provisioning.Clone VirtualMachine.Provisioning.MarkAsTemplate VirtualMachine.Provisioning.DeployTemplate
vSphere vCenter Datacenter	If the installation program creates the virtual machine folder	InventoryService.Tagging.ObjectAttachable Resource.AssignVMToPool VApp.Import VirtualMachine.Config.AddExistingDisk VirtualMachine.Config.AddNewDisk

vSphere object for role	When required	Required privileges in vSphere API
		<b>VirtualMachine.Config.AddRemoveDevice</b> <b>VirtualMachine.Config.AdvancedConfig</b> <b>VirtualMachine.Config.Annotation</b> <b>VirtualMachine.Config.CPUCount</b> <b>VirtualMachine.Config.DiskExtend</b> <b>VirtualMachine.Config.DiskLease</b> <b>VirtualMachine.Config.EditDevice</b> <b>VirtualMachine.Config.Memory</b> <b>VirtualMachine.Config.RemoveDisk</b> <b>VirtualMachine.Config.Rename</b> <b>VirtualMachine.Config.ResetGuestInfo</b> <b>VirtualMachine.Config.Resource</b> <b>VirtualMachine.Config.Settings</b> <b>VirtualMachine.Config.UpgradeVirtualHardware</b> <b>VirtualMachine.Interact.GuestControl</b> <b>VirtualMachine.Interact.PowerOff</b> <b>VirtualMachine.Interact.PowerOn</b> <b>VirtualMachine.Interact.Reset</b> <b>VirtualMachine.Inventory.Create</b> <b>VirtualMachine.Inventory.CreateFromExisting</b> <b>VirtualMachine.Inventory.Delete</b> <b>VirtualMachine.Provisioning.Clone</b> <b>VirtualMachine.Provisioning.DeployTemplate</b> <b>VirtualMachine.Provisioning.MarkAsTemplate</b> <b>Folder.Create</b> <b>Folder.Delete</b>

Example 20.5. Roles and privileges required for installation in vCenter graphical user interface (GUI)

vSphere object for role	When required	Required privileges in vCenter GUI
vSphere vCenter	Always	<b>Cns.Searchable</b> <b>"vSphere Tagging"."Assign or Unassign vSphere Tag"</b> <b>"vSphere Tagging"."Create vSphere Tag Category"</b> <b>"vSphere Tagging"."Create vSphere Tag"</b> <b>vSphere Tagging"."Delete vSphere Tag Category"</b> <b>"vSphere Tagging"."Delete vSphere Tag"</b> <b>"vSphere Tagging"."Edit vSphere Tag Category"</b> <b>"vSphere Tagging"."Edit vSphere Tag"</b> <b>Sessions."Validate session"</b> <b>"Profile-driven storage"."Profile-driven storage update"</b> <b>"Profile-driven storage"."Profile-driven storage view"</b>
vSphere vCenter Cluster	If VMs will be created in the cluster root	<b>Host.Configuration."Storage partition configuration"</b> <b>Resource."Assign virtual machine to resource pool"</b> <b>VApp."Assign resource pool"</b> <b>VApp.Import</b> <b>"Virtual machine"."Change Configuration"."Add new disk"</b>
vSphere vCenter Resource Pool	If an existing resource pool is provided	<b>Host.Configuration."Storage partition configuration"</b> <b>Resource."Assign virtual machine to resource pool"</b> <b>VApp."Assign resource pool"</b> <b>VApp.Import</b> <b>"Virtual machine"."Change Configuration"."Add new disk"</b>

vSphere object for role	When required	Required privileges in vCenter GUI
vSphere Datastore	Always	<b>Datastore."Allocate space"</b> <b>Datastore."Browse datastore"</b> <b>Datastore."Low level file operations"</b> <b>"vSphere Tagging"."Assign or Unassign vSphere Tag on Object"</b>
vSphere Port Group	Always	<b>Network."Assign network"</b>
Virtual Machine Folder	Always	<b>"vSphere Tagging"."Assign or Unassign vSphere Tag on Object"</b> <b>Resource."Assign virtual machine to resource pool"</b> <b>VApp.Import</b> <b>"Virtual machine"."Change Configuration"."Add existing disk"</b> <b>"Virtual machine"."Change Configuration"."Add new disk"</b> <b>"Virtual machine"."Change Configuration"."Add or remove device"</b> <b>"Virtual machine"."Change Configuration"."Advanced configuration"</b> <b>"Virtual machine"."Change Configuration"."Set annotation"</b> <b>"Virtual machine"."Change Configuration"."Change CPU count"</b> <b>"Virtual machine"."Change Configuration"."Extend virtual disk"</b> <b>"Virtual machine"."Change Configuration"."Acquire disk lease"</b> <b>"Virtual machine"."Change Configuration"."Modify device settings"</b> <b>"Virtual machine"."Change Configuration"."Change Memory"</b> <b>"Virtual machine"."Change Configuration"."Remove disk"</b> <b>"Virtual machine"."Change</b>

vSphere object for role	When required	Configuration".Rename Virtual machine".Change GUI Configuration".Reset guest information"
		"Virtual machine".Change Configuration".Change resource" "Virtual machine".Change Configuration".Change Settings" "Virtual machine".Change Configuration".Upgrade virtual machine compatibility" "Virtual machine".Interaction."Gues t operating system management by VIX API" "Virtual machine".Interaction."Powe r off" "Virtual machine".Interaction."Powe r on" "Virtual machine".Interaction.Reset "Virtual machine".Edit Inventory".Create new" "Virtual machine".Edit Inventory".Create from existing" "Virtual machine".Edit Inventory".Remove" "Virtual machine".Provisioning."Clo ne virtual machine" "Virtual machine".Provisioning."Mar k as template" "Virtual machine".Provisioning."De ploy template"
vSphere vCenter Datacenter	If the installation program creates the virtual machine folder	"vSphere Tagging".Assign or Unassign vSphere Tag on Object" Resource.Assign virtual machine to resource pool" VApp.Import "Virtual machine".Change Configuration".Add existing disk" "Virtual machine".Change Configuration".Add new disk"

vSphere object for role	When required	Required privileges in vCenter GUI
		<p>"Virtual machine"."Change Configuration"."Add or remove device"</p> <p>"Virtual machine"."Change Configuration"."Advanced configuration"</p> <p>"Virtual machine"."Change Configuration"."Set annotation"</p> <p>"Virtual machine"."Change Configuration"."Change CPU count"</p> <p>"Virtual machine"."Change Configuration"."Extend virtual disk"</p> <p>"Virtual machine"."Change Configuration"."Acquire disk lease"</p> <p>"Virtual machine"."Change Configuration"."Modify device settings"</p> <p>"Virtual machine"."Change Configuration"."Change Memory"</p> <p>"Virtual machine"."Change Configuration"."Remove disk"</p> <p>"Virtual machine"."Change Configuration".Rename</p> <p>"Virtual machine"."Change Configuration"."Reset guest information"</p> <p>"Virtual machine"."Change Configuration"."Change resource"</p> <p>"Virtual machine"."Change Configuration"."Change Settings"</p> <p>"Virtual machine"."Change Configuration"."Upgrade virtual machine compatibility"</p> <p>"Virtual machine".Interaction."Guest operating system management by VIX API"</p> <p>"Virtual machine".Interaction."Power off"</p> <p>"Virtual machine".Interaction."Power on"</p> <p>"Virtual machine".Interaction.Reset</p> <p>"Virtual machine"."Edit Inventory"."Create new"</p>

vSphere object for role	When required	"Virtual machine". "Edit Inventory". "Create from Existing"
		"Virtual machine". "Edit Inventory". "Remove" "Virtual machine". Provisioning. "Clone virtual machine" "Virtual machine". Provisioning. "Deploy template" "Virtual machine". Provisioning. "Mark as template" Folder. "Create folder" Folder. "Delete folder"

Additionally, the user requires some **ReadOnly** permissions, and some of the roles require permission to propagate the permissions to child objects. These settings vary depending on whether or not you install the cluster into an existing folder.

#### Example 20.6. Required permissions and propagation settings

vSphere object	When required	Propagate to children	Permissions required
vSphere vCenter	Always	False	Listed required privileges
vSphere vCenter Datacenter	Existing folder	False	<b>ReadOnly</b> permission
	Installation program creates the folder	True	Listed required privileges
vSphere vCenter Cluster	Existing resource pool	False	<b>ReadOnly</b> permission
	VMs in cluster root	True	Listed required privileges
vSphere vCenter Datastore	Always	False	Listed required privileges
vSphere Switch	Always	False	<b>ReadOnly</b> permission
vSphere Port Group	Always	False	Listed required privileges
vSphere vCenter Virtual Machine Folder	Existing folder	True	Listed required privileges



vSphere object	When required	Propagate to children	Permissions required
vSphere vCenter Resource Pool	Existing resource pool	True	Listed required privileges

For more information about creating an account with only the required privileges, see [vSphere Permissions and User Management Tasks](#) in the vSphere documentation.

### Using OpenShift Container Platform with vMotion

If you intend on using vMotion in your vSphere environment, consider the following before installing a OpenShift Container Platform cluster.

- OpenShift Container Platform generally supports compute-only vMotion. Using Storage vMotion can cause issues and is not supported.  
To help ensure the uptime of your compute and control plane nodes, it is recommended that you follow the VMware best practices for vMotion. It is also recommended to use VMware anti-affinity rules to improve the availability of OpenShift Container Platform during maintenance or hardware issues.

For more information about vMotion and anti-affinity rules, see the VMware vSphere documentation for [vMotion networking requirements](#) and [VM anti-affinity rules](#).

- If you are using vSphere volumes in your pods, migrating a VM across datastores either manually or through Storage vMotion causes, invalid references within OpenShift Container Platform persistent volume (PV) objects. These references prevent affected pods from starting up and can result in data loss.
- Similarly, OpenShift Container Platform does not support selective migration of VMDKs across datastores, using datastore clusters for VM provisioning or for dynamic or static provisioning of PVs, or using a datastore that is part of a datastore cluster for dynamic or static provisioning of PVs.

### Cluster resources

When you deploy an OpenShift Container Platform cluster that uses installer-provisioned infrastructure, the installation program must be able to create several resources in your vCenter instance.

A standard OpenShift Container Platform installation creates the following vCenter resources:

- 1 Folder
- 1 Tag category
- 1 Tag
- Virtual machines:
  - 1 template
  - 1 temporary bootstrap node
  - 3 control plane nodes
  - 3 compute machines

Although these resources use 856 GB of storage, the bootstrap node is destroyed during the cluster installation process. A minimum of 800 GB of storage is required to use a standard cluster.

If you deploy more compute machines, the OpenShift Container Platform cluster will use more storage.

### Cluster limits

Available resources vary between clusters. The number of possible clusters within a vCenter is limited primarily by available storage space and any limitations on the number of required resources. Be sure to consider both limitations to the vCenter resources that the cluster creates and the resources that you require to deploy a cluster, such as IP addresses and networks.

### Networking requirements

You must use the Dynamic Host Configuration Protocol (DHCP) for the network and ensure that the DHCP server is configured to provide persistent IP addresses to the cluster machines. In the DHCP lease, you must configure the DHCP to use the default gateway. All nodes must be in the same VLAN. You cannot scale the cluster using a second VLAN as a Day 2 operation. Additionally, you must create the following networking resources before you install the OpenShift Container Platform cluster:



#### NOTE

It is recommended that each OpenShift Container Platform node in the cluster must have access to a Network Time Protocol (NTP) server that is discoverable via DHCP. Installation is possible without an NTP server. However, asynchronous server clocks will cause errors, which NTP server prevents.

### Required IP Addresses

An installer-provisioned vSphere installation requires two static IP addresses:

- The **API** address is used to access the cluster API.
- The **Ingress** address is used for cluster ingress traffic.

You must provide these IP addresses to the installation program when you install the OpenShift Container Platform cluster.

### DNS records

You must create DNS records for two static IP addresses in the appropriate DNS server for the vCenter instance that hosts your OpenShift Container Platform cluster. In each record, **<cluster\_name>** is the cluster name and **<base\_domain>** is the cluster base domain that you specify when you install the cluster. A complete DNS record takes the form: **<component>.<cluster\_name>.<base\_domain>..**

Table 20.14. Required DNS records

Component	Record	Description
API VIP	<b>api.&lt;cluster_name&gt;.&lt;base_domain&gt;..</b>	This DNS A/AAAA or CNAME record must point to the load balancer for the control plane machines. This record must be resolvable by both clients external to the cluster and from all the nodes within the cluster.

Component	Record	Description
Ingress VIP	*.apps.<cluster_name>.<base_domain>.	A wildcard DNS A/AAAA or CNAME record that points to the load balancer that targets the machines that run the Ingress router pods, which are the worker nodes by default. This record must be resolvable by both clients external to the cluster and from all the nodes within the cluster.

### 20.3.7. Generating a key pair for cluster node SSH access

During an OpenShift Container Platform installation, you can provide an SSH public key to the installation program. The key is passed to the Red Hat Enterprise Linux CoreOS (RHCOS) nodes through their Ignition config files and is used to authenticate SSH access to the nodes. The key is added to the `~/.ssh/authorized_keys` list for the **core** user on each node, which enables password-less authentication.

After the key is passed to the nodes, you can use the key pair to SSH in to the RHCOS nodes as the user **core**. To access the nodes through SSH, the private key identity must be managed by SSH for your local user.

If you want to SSH in to your cluster nodes to perform installation debugging or disaster recovery, you must provide the SSH public key during the installation process. The `./openshift-install gather` command also requires the SSH public key to be in place on the cluster nodes.

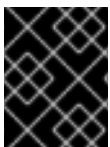

#### IMPORTANT

Do not skip this procedure in production environments, where disaster recovery and debugging is required.



#### NOTE

You must use a local key, not one that you configured with platform-specific approaches such as [AWS key pairs](#).

#### Procedure

1. If you do not have an existing SSH key pair on your local machine to use for authentication onto your cluster nodes, create one. For example, on a computer that uses a Linux operating system, run the following command:

```
$ ssh-keygen -t ed25519 -N "" -f <path>/<file_name> 1
```

- 1 Specify the path and file name, such as `~/.ssh/id_ed25519`, of the new SSH key. If you have an existing key pair, ensure your public key is in the your `~/.ssh` directory.

**NOTE**

If you plan to install an OpenShift Container Platform cluster that uses FIPS validated or Modules In Process cryptographic libraries on the **x86\_64** architecture, do not create a key that uses the **ed25519** algorithm. Instead, create a key that uses the **rsa** or **ecdsa** algorithm.

2. View the public SSH key:

```
$ cat <path>/<file_name>.pub
```

For example, run the following to view the `~/.ssh/id_ed25519.pub` public key:

```
$ cat ~/.ssh/id_ed25519.pub
```

3. Add the SSH private key identity to the SSH agent for your local user, if it has not already been added. SSH agent management of the key is required for password-less SSH authentication onto your cluster nodes, or if you want to use the `./openshift-install gather` command.

**NOTE**

On some distributions, default SSH private key identities such as `~/.ssh/id_rsa` and `~/.ssh/id_dsa` are managed automatically.

- a. If the **ssh-agent** process is not already running for your local user, start it as a background task:

```
$ eval "$(ssh-agent -s)"
```

**Example output**

```
Agent pid 31874
```

**NOTE**

If your cluster is in FIPS mode, only use FIPS-compliant algorithms to generate the SSH key. The key must be either RSA or ECDSA.

4. Add your SSH private key to the **ssh-agent**:

```
$ ssh-add <path>/<file_name> 1
```

- 1** Specify the path and file name for your SSH private key, such as `~/.ssh/id_ed25519`

**Example output**

```
Identity added: /home/<you>/<path>/<file_name> (<computer_name>)
```

**Next steps**

- When you install OpenShift Container Platform, provide the SSH public key to the installation program.

### 20.3.8. Obtaining the installation program

Before you install OpenShift Container Platform, download the installation file on a local computer.

#### Prerequisites

- You have a computer that runs Linux or macOS, with 500 MB of local disk space

#### Procedure

1. Access the [Infrastructure Provider](#) page on the OpenShift Cluster Manager site. If you have a Red Hat account, log in with your credentials. If you do not, create an account.
2. Select your infrastructure provider.
3. Navigate to the page for your installation type, download the installation program that corresponds with your host operating system and architecture, and place the file in the directory where you will store the installation configuration files.



#### IMPORTANT

The installation program creates several files on the computer that you use to install your cluster. You must keep the installation program and the files that the installation program creates after you finish installing the cluster. Both files are required to delete the cluster.

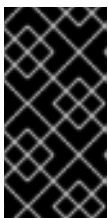

#### IMPORTANT

Deleting the files created by the installation program does not remove your cluster, even if the cluster failed during installation. To remove your cluster, complete the OpenShift Container Platform uninstallation procedures for your specific cloud provider.

4. Extract the installation program. For example, on a computer that uses a Linux operating system, run the following command:

```
$ tar -xvf openshift-install-linux.tar.gz
```

5. Download your installation [pull secret from the Red Hat OpenShift Cluster Manager](#) . This pull secret allows you to authenticate with the services that are provided by the included authorities, including Quay.io, which serves the container images for OpenShift Container Platform components.

### 20.3.9. Adding vCenter root CA certificates to your system trust

Because the installation program requires access to your vCenter's API, you must add your vCenter's trusted root CA certificates to your system trust before you install an OpenShift Container Platform cluster.

#### Procedure

1. From the vCenter home page, download the vCenter's root CA certificates. Click **Download trusted root CA certificates** in the vSphere Web Services SDK section. The **<vCenter>/certs/download.zip** file downloads.
2. Extract the compressed file that contains the vCenter root CA certificates. The contents of the compressed file resemble the following file structure:

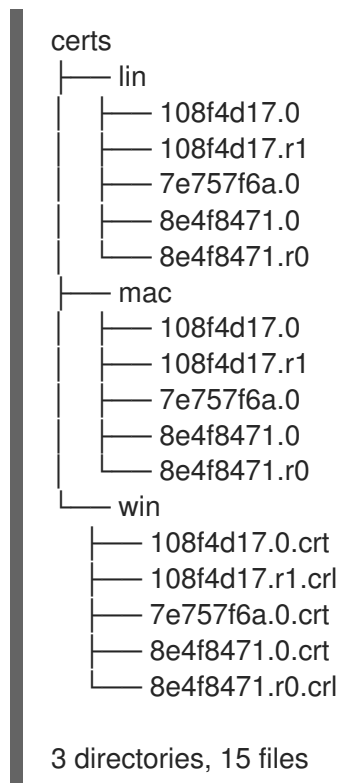

3. Add the files for your operating system to the system trust. For example, on a Fedora operating system, run the following command:

```
# cp certs/lin/* /etc/pki/ca-trust/source/anchors
```

4. Update your system trust. For example, on a Fedora operating system, run the following command:

```
# update-ca-trust extract
```

### 20.3.10. Creating the installation configuration file

You can customize the OpenShift Container Platform cluster you install on VMware vSphere.

#### Prerequisites

- Obtain the OpenShift Container Platform installation program and the pull secret for your cluster.
- Obtain service principal permissions at the subscription level.

#### Procedure

1. Create the **install-config.yaml** file.
  - a. Change to the directory that contains the installation program and run the following

command:

```
$. /openshift-install create install-config --dir <installation_directory> 1
```

- 1** For **<installation\_directory>**, specify the directory name to store the files that the installation program creates.



### IMPORTANT

Specify an empty directory. Some installation assets, like bootstrap X.509 certificates have short expiration intervals, so you must not reuse an installation directory. If you want to reuse individual files from another cluster installation, you can copy them into your directory. However, the file names for the installation assets might change between releases. Use caution when copying installation files from an earlier OpenShift Container Platform version.

- b. At the prompts, provide the configuration details for your cloud:
- i. Optional: Select an SSH key to use to access your cluster machines.



### NOTE

For production OpenShift Container Platform clusters on which you want to perform installation debugging or disaster recovery, specify an SSH key that your **ssh-agent** process uses.

- ii. Select **vsphere** as the platform to target.
- iii. Specify the name of your vCenter instance.
- iv. Specify the user name and password for the vCenter account that has the required permissions to create the cluster.  
The installation program connects to your vCenter instance.
- v. Select the datacenter in your vCenter instance to connect to.
- vi. Select the default vCenter datastore to use.
- vii. Select the vCenter cluster to install the OpenShift Container Platform cluster in. The installation program uses the root resource pool of the vSphere cluster as the default resource pool.
- viii. Select the network in the vCenter instance that contains the virtual IP addresses and DNS records that you configured.
- ix. Enter the virtual IP address that you configured for control plane API access.
- x. Enter the virtual IP address that you configured for cluster ingress.
- xi. Enter the base domain. This base domain must be the same one that you used in the DNS records that you configured.

- xii. Enter a descriptive name for your cluster. The cluster name you enter must match the cluster name you specified when configuring the DNS records.
  - xiii. Paste the [pull secret from the Red Hat OpenShift Cluster Manager](#) .
2. Modify the **install-config.yaml** file. You can find more information about the available parameters in the "Installation configuration parameters" section.
  3. Back up the **install-config.yaml** file so that you can use it to install multiple clusters.

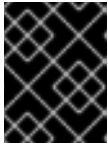

### IMPORTANT

The **install-config.yaml** file is consumed during the installation process. If you want to reuse the file, you must back it up now.

#### 20.3.10.1. Installation configuration parameters

Before you deploy an OpenShift Container Platform cluster, you provide parameter values to describe your account on the cloud platform that hosts your cluster and optionally customize your cluster's platform. When you create the **install-config.yaml** installation configuration file, you provide values for the required parameters through the command line. If you customize your cluster, you can modify the **install-config.yaml** file to provide more details about the platform.



### NOTE

After installation, you cannot modify these parameters in the **install-config.yaml** file.

##### 20.3.10.1.1. Required configuration parameters

Required installation configuration parameters are described in the following table:

Table 20.15. Required parameters

Parameter	Description	Values
<b>apiVersion</b>	The API version for the <b>install-config.yaml</b> content. The current version is <b>v1</b> . The installer may also support older API versions.	String
<b>baseDomain</b>	The base domain of your cloud provider. The base domain is used to create routes to your OpenShift Container Platform cluster components. The full DNS name for your cluster is a combination of the <b>baseDomain</b> and <b>metadata.name</b> parameter values that uses the <b>&lt;metadata.name&gt;</b> . <b>&lt;baseDomain&gt;</b> format.	A fully-qualified domain or subdomain name, such as <b>example.com</b> .



Parameter	Description	Values
<b>metadata</b>	Kubernetes resource <b>ObjectMeta</b> , from which only the <b>name</b> parameter is consumed.	Object
<b>metadata.name</b>	The name of the cluster. DNS records for the cluster are all subdomains of <b>{{.metadata.name}}</b> . <b>{{.baseDomain}}</b> .	String of lowercase letters and hyphens (-), such as <b>dev</b> .
<b>platform</b>	The configuration for the specific platform upon which to perform the installation: <b>alibabacloud</b> , <b>aws</b> , <b>baremetal</b> , <b>azure</b> , <b>gcp</b> , <b>ibmcloud</b> , <b>openstack</b> , <b>ovirt</b> , <b>vsphere</b> , or <b>{}</b> . For additional information about <b>platform.&lt;platform&gt;</b> parameters, consult the table for your specific platform that follows.	Object
<b>pullSecret</b>	Get a <a href="#">pull secret from the Red Hat OpenShift Cluster Manager</a> to authenticate downloading container images for OpenShift Container Platform components from services such as Quay.io.	<pre>{   "auths":{     "cloud.openshift.com":{       "auth":"b3Blb=",       "email":"you@example.com"     },     "quay.io":{       "auth":"b3Blb=",       "email":"you@example.com"     }   } }</pre>

### 20.3.10.1.2. Network configuration parameters

You can customize your installation configuration based on the requirements of your existing network infrastructure. For example, you can expand the IP address block for the cluster network or provide different IP address blocks than the defaults.

Only IPv4 addresses are supported.

Table 20.16. Network parameters

Parameter	Description	Values
<b>networking</b>	The configuration for the cluster network.	Object  <b>NOTE</b> You cannot modify parameters specified by the <b>networking</b> object after installation.
<b>networking.networkType</b>	The cluster network provider Container Network Interface (CNI) plugin to install.	Either <b>OpenShiftSDN</b> or <b>OVNKubernetes</b> . <b>OpenShiftSDN</b> is a CNI provider for all-Linux networks. <b>OVNKubernetes</b> is a CNI provider for Linux networks and hybrid networks that contain both Linux and Windows servers. The default value is <b>OpenShiftSDN</b> .
<b>networking.clusterNetwork</b>	The IP address blocks for pods.  The default value is <b>10.128.0.0/14</b> with a host prefix of <b>/23</b> .  If you specify multiple IP address blocks, the blocks must not overlap.	An array of objects. For example:  <pre>networking:   clusterNetwork:     - cidr: 10.128.0.0/14       hostPrefix: 23</pre>
<b>networking.clusterNetwork.cidr</b>	Required if you use <b>networking.clusterNetwork</b> . An IP address block.  An IPv4 network.	An IP address block in Classless Inter-Domain Routing (CIDR) notation. The prefix length for an IPv4 block is between <b>0</b> and <b>32</b> .
<b>networking.clusterNetwork.hostPrefix</b>	The subnet prefix length to assign to each individual node. For example, if <b>hostPrefix</b> is set to <b>23</b> then each node is assigned a <b>/23</b> subnet out of the given <b>cidr</b> . A <b>hostPrefix</b> value of <b>23</b> provides 510 ( $2^{(32 - 23)} - 2$ ) pod IP addresses.	A subnet prefix.  The default value is <b>23</b> .
<b>networking.serviceNetwork</b>	The IP address block for services. The default value is <b>172.30.0.0/16</b> .  The OpenShift SDN and OVN-Kubernetes network providers support only a single IP address block for the service network.	An array with an IP address block in CIDR format. For example:  <pre>networking:   serviceNetwork:     - 172.30.0.0/16</pre>

Parameter	Description	Values
<b>networking.machineNetwork</b>	The IP address blocks for machines.  If you specify multiple IP address blocks, the blocks must not overlap.	An array of objects. For example:  <pre>networking:   machineNetwork:   - cidr: 10.0.0.0/16</pre>
<b>networking.machineNetwork.cidr</b>	Required if you use <b>networking.machineNetwork</b> . An IP address block. The default value is <b>10.0.0.0/16</b> for all platforms other than libvirt. For libvirt, the default value is <b>192.168.126.0/24</b> .	An IP network block in CIDR notation.  For example, <b>10.0.0.0/16</b> .   <p><b>NOTE</b></p> <p>Set the <b>networking.machineNetwork</b> to match the CIDR that the preferred NIC resides in.</p>

### 20.3.10.1.3. Optional configuration parameters



Optional installation configuration parameters are described in the following table:

Table 20.17. Optional parameters



Parameter	Description	Values
<b>additionalTrustBundle</b>	A PEM-encoded X.509 certificate bundle that is added to the nodes' trusted certificate store. This trust bundle may also be used when a proxy has been configured.	String
<b>cgroupsV2</b>	Enables <a href="#">Linux control groups version 2</a> (cgroups v2) on specific nodes in your cluster. The OpenShift Container Platform process for enabling cgroups v2 disables all cgroup version 1 controllers and hierarchies. The OpenShift Container Platform cgroups version 2 feature is in Developer Preview and is not supported by Red Hat at this time.	<b>true</b>
<b>compute</b>	The configuration for the machines that comprise the compute nodes.	Array of <b>MachinePool</b> objects.

Parameter	Description	Values
<b>compute.architecture</b>	Determines the instruction set architecture of the machines in the pool. Currently, clusters with varied architectures are not supported. All pools must specify the same architecture. Valid values are <b>amd64</b> (the default).	String
<b>compute.hyperthreading</b>	Whether to enable or disable simultaneous multithreading, or <b>hyperthreading</b> , on compute machines. By default, simultaneous multithreading is enabled to increase the performance of your machines' cores.   <b>IMPORTANT</b> If you disable simultaneous multithreading, ensure that your capacity planning accounts for the dramatically decreased machine performance.	<b>Enabled</b> or <b>Disabled</b>
<b>compute.name</b>	Required if you use <b>compute</b> . The name of the machine pool.	<b>worker</b>
<b>compute.platform</b>	Required if you use <b>compute</b> . Use this parameter to specify the cloud provider to host the worker machines. This parameter value must match the <b>controlPlane.platform</b> parameter value.	<b>alibabacloud, aws, azure, gcp, ibmcloud, openstack, ovirt, vsphere</b> , or <b>{}</b>
<b>compute.replicas</b>	The number of compute machines, which are also known as worker machines, to provision.	A positive integer greater than or equal to <b>2</b> . The default value is <b>3</b> .
<b>controlPlane</b>	The configuration for the machines that comprise the control plane.	Array of <b>MachinePool</b> objects.

Parameter	Description	Values
<b>controlPlane.architecture</b>	Determines the instruction set architecture of the machines in the pool. Currently, clusters with varied architectures are not supported. All pools must specify the same architecture. Valid values are <b>amd64</b> (the default).	String
<b>controlPlane.hyperthreading</b>	Whether to enable or disable simultaneous multithreading, or <b>hyperthreading</b> , on control plane machines. By default, simultaneous multithreading is enabled to increase the performance of your machines' cores.   <b>IMPORTANT</b>  If you disable simultaneous multithreading, ensure that your capacity planning accounts for the dramatically decreased machine performance.	<b>Enabled</b> or <b>Disabled</b>
<b>controlPlane.name</b>	Required if you use <b>controlPlane</b> . The name of the machine pool.	<b>master</b>
<b>controlPlane.platform</b>	Required if you use <b>controlPlane</b> . Use this parameter to specify the cloud provider that hosts the control plane machines. This parameter value must match the <b>compute.platform</b> parameter value.	<b>alibabacloud, aws, azure, gcp, ibmcloud, openstack, ovirt, vsphere, or {}</b>
<b>controlPlane.replicas</b>	The number of control plane machines to provision.	The only supported value is <b>3</b> , which is the default value.

Parameter	Description	Values
<b>credentialsMode</b>	<p>The Cloud Credential Operator (CCO) mode. If no mode is specified, the CCO dynamically tries to determine the capabilities of the provided credentials, with a preference for mint mode on the platforms where multiple modes are supported.</p> <div data-bbox="485 510 593 864" style="border: 1px solid #ccc; padding: 5px; margin-bottom: 10px;">  </div> <p><b>NOTE</b></p> <p>Not all CCO modes are supported for all cloud providers. For more information on CCO modes, see the <i>Cloud Credential Operator</i> entry in the <i>Cluster Operators reference content</i>.</p> <div data-bbox="485 909 593 1263" style="border: 1px solid #ccc; padding: 5px;">  </div> <p><b>NOTE</b></p> <p>If your AWS account has service control policies (SCP) enabled, you must configure the <b>credentialsMode</b> parameter to <b>Mint</b>, <b>Passthrough</b> or <b>Manual</b>.</p>	<b>Mint, Passthrough, Manual</b> or an empty string ("").

Parameter	Description	Values
<b>fips</b>	<p>Enable or disable FIPS mode. The default is <b>false</b> (disabled). If FIPS mode is enabled, the Red Hat Enterprise Linux CoreOS (RHCOS) machines that OpenShift Container Platform runs on bypass the default Kubernetes cryptography suite and use the cryptography modules that are provided with RHCOS instead.</p> <div style="display: flex; align-items: flex-start;"> <div style="width: 20px; height: 100px; background: repeating-linear-gradient(45deg, transparent, transparent 2px, black 2px, black 4px); margin-right: 10px;"></div> <div> <p><b>IMPORTANT</b></p> <p>To enable FIPS mode for your cluster, you must run the installation program from a Red Hat Enterprise Linux (RHEL) computer configured to operate in FIPS mode. For more information about configuring FIPS mode on RHEL, see <a href="#">Installing the system in FIPS mode</a>. The use of FIPS validated or Modules In Process cryptographic libraries is only supported on OpenShift Container Platform deployments on the <b>x86_64</b> architecture.</p> </div> </div> <div style="display: flex; align-items: flex-start; margin-top: 10px;"> <div style="width: 20px; height: 50px; background: repeating-linear-gradient(45deg, transparent, transparent 2px, black 2px, black 4px); margin-right: 10px;"></div> <div> <p><b>NOTE</b></p> <p>If you are using Azure File storage, you cannot enable FIPS mode.</p> </div> </div>	<b>false</b> or <b>true</b>
<b>imageContentSources</b>	Sources and repositories for the release-image content.	Array of objects. Includes a <b>source</b> and, optionally, <b>mirrors</b> , as described in the following rows of this table.
<b>imageContentSources.source</b>	Required if you use <b>imageContentSources</b> . Specify the repository that users refer to, for example, in image pull specifications.	String
<b>imageContentSources.mirrors</b>	Specify one or more repositories that may also contain the same images.	Array of strings

Parameter	Description	Values
<b>publish</b>	How to publish or expose the user-facing endpoints of your cluster, such as the Kubernetes API, OpenShift routes.	<p><b>Internal</b> or <b>External</b>. The default value is <b>External</b>.</p> <p>Setting this field to <b>Internal</b> is not supported on non-cloud platforms and IBM Cloud VPC.</p> <div style="display: flex; align-items: flex-start;">  <p><b>IMPORTANT</b></p> <p>If the value of the field is set to <b>Internal</b>, the cluster will become non-functional. For more information, refer to <a href="#">BZ#1953035</a>.</p> </div>
<b>sshKey</b>	<p>The SSH key or keys to authenticate access your cluster machines.</p> <div style="display: flex; align-items: flex-start;">  <p><b>NOTE</b></p> <p>For production OpenShift Container Platform clusters on which you want to perform installation debugging or disaster recovery, specify an SSH key that your <b>ssh-agent</b> process uses.</p> </div>	<p>One or more keys. For example:</p> <pre>sshKey:   &lt;key1&gt;   &lt;key2&gt;   &lt;key3&gt;</pre>

#### 20.3.10.1.4. Additional VMware vSphere configuration parameters

Additional VMware vSphere configuration parameters are described in the following table:

Table 20.18. Additional VMware vSphere cluster parameters

Parameter	Description	Values
<b>platform.vsphere.vCenter</b>	The fully-qualified hostname or IP address of the vCenter server.	String
<b>platform.vsphere.username</b>	The user name to use to connect to the vCenter instance with. This user must have at least the roles and privileges that are required for <a href="#">static or dynamic persistent volume provisioning</a> in vSphere.	String



Parameter	Description	Values
<b>platform.vsphere.password</b>	The password for the vCenter user name.	String
<b>platform.vsphere.datacenter</b>	The name of the datacenter to use in the vCenter instance.	String
<b>platform.vsphere.defaultDatastore</b>	The name of the default datastore to use for provisioning volumes.	String
<b>platform.vsphere.folder</b>	Optional. The absolute path of an existing folder where the installation program creates the virtual machines. If you do not provide this value, the installation program creates a folder that is named with the infrastructure ID in the datacenter virtual machine folder.	String, for example, <b>/&lt;datacenter_name&gt;/vm/&lt;folder_name&gt;/&lt;subfolder_name&gt;</b> .
<b>platform.vsphere.resourcePool</b>	Optional. The absolute path of an existing resource pool where the installer creates the virtual machines. If you do not specify a value, resources are installed in the root of the cluster <b>/&lt;datacenter_name&gt;/host/&lt;cluster_name&gt;/Resources</b> .	String, for example, <b>/&lt;datacenter_name&gt;/host/&lt;cluster_name&gt;/Resources/&lt;resource_pool_name&gt;/&lt;optional_nested_resource_pool_name&gt;</b> .
<b>platform.vsphere.network</b>	The network in the vCenter instance that contains the virtual IP addresses and DNS records that you configured.	String
<b>platform.vsphere.cluster</b>	The vCenter cluster to install the OpenShift Container Platform cluster in.	String
<b>platform.vsphere.apiVIP</b>	The virtual IP (VIP) address that you configured for control plane API access.	An IP address, for example <b>128.0.0.1</b> .
<b>platform.vsphere.ingressVIP</b>	The virtual IP (VIP) address that you configured for cluster ingress.	An IP address, for example <b>128.0.0.1</b> .
<b>platform.vsphere.diskType</b>	Optional. The disk provisioning method. This value defaults to the vSphere default storage policy if not set.	Valid values are <b>thin</b> , <b>thick</b> , or <b>eagerZeroedThick</b> .

#### 20.3.10.1.5. Optional VMware vSphere machine pool configuration parameters

Optional VMware vSphere machine pool configuration parameters are described in the following table:

**Table 20.19. Optional VMware vSphere machine pool parameters**

Parameter	Description	Values
<b>platform.vsphere.clusterOSImage</b>	The location from which the installer downloads the RHCOS image. You must set this parameter to perform an installation in a restricted network.	An HTTP or HTTPS URL, optionally with a SHA-256 checksum. For example, <b>https://mirror.openshift.com/images/rhcos-&lt;version&gt;-vmware.&lt;architecture&gt;.ova.</b>
<b>platform.vsphere.osDisk.diskSizeGB</b>	The size of the disk in gigabytes.	Integer
<b>platform.vsphere.cpus</b>	The total number of virtual processor cores to assign a virtual machine. The value of <b>platform.vsphere.cpus</b> must be a multiple of <b>platform.vsphere.coresPerSocket</b> value.	Integer
<b>platform.vsphere.coresPerSocket</b>	The number of cores per socket in a virtual machine. The number of virtual sockets on the virtual machine is <b>platform.vsphere.cpus/platform.vsphere.coresPerSocket</b> . The default value for control plane nodes and worker nodes is <b>4</b> and <b>2</b> , respectively.	Integer
<b>platform.vsphere.memoryMB</b>	The size of a virtual machine's memory in megabytes.	Integer

### 20.3.10.2. Sample install-config.yaml file for an installer-provisioned VMware vSphere cluster

You can customize the install-config.yaml file to specify more details about your OpenShift Container Platform cluster's platform or modify the values of the required parameters.

```

apiVersion: v1
baseDomain: example.com 1
compute: 2
- hyperthreading: Enabled 3
  name: worker
  replicas: 3
platform:
  vsphere: 4
    cpus: 2
    coresPerSocket: 2
    memoryMB: 8192

```

```

    osDisk:
      diskSizeGB: 120
controlPlane: 5
  hyperthreading: Enabled 6
  name: master
  replicas: 3
  platform:
    vsphere: 7
      cpus: 4
      coresPerSocket: 2
      memoryMB: 16384
      osDisk:
        diskSizeGB: 120
metadata:
  name: cluster 8
platform:
  vsphere:
    vcenter: your.vcenter.server
    username: username
    password: password
    datacenter: datacenter
    defaultDatastore: datastore
    folder: folder
    resourcePool: resource_pool 9
    diskType: thin 10
    network: VM_Network
    cluster: vsphere_cluster_name 11
    apiVIP: api_vip
    ingressVIP: ingress_vip
fips: false
pullSecret: '{"auths": ...}'
sshKey: 'ssh-ed25519 AAAA...'

```

- 1 The base domain of the cluster. All DNS records must be sub-domains of this base and include the cluster name.
- 2 5 The **controlPlane** section is a single mapping, but the **compute** section is a sequence of mappings. To meet the requirements of the different data structures, the first line of the **compute** section must begin with a hyphen, -, and the first line of the **controlPlane** section must not. Only one control plane pool is used.
- 3 6 Whether to enable or disable simultaneous multithreading, or **hyperthreading**. By default, simultaneous multithreading is enabled to increase the performance of your machines' cores. You can disable it by setting the parameter value to **Disabled**. If you disable simultaneous multithreading in some cluster machines, you must disable it in all cluster machines.



### IMPORTANT

If you disable simultaneous multithreading, ensure that your capacity planning accounts for the dramatically decreased machine performance. Your machines must use at least 8 CPUs and 32 GB of RAM if you disable simultaneous multithreading.

- 4 7 Optional: Provide additional configuration for the machine pool parameters for the compute and control plane machines.

- 8 The cluster name that you specified in your DNS records.
- 9 Optional: Provide an existing resource pool for machine creation. If you do not specify a value, the installation program uses the root resource pool of the vSphere cluster.
- 10 The vSphere disk provisioning method.
- 11 The vSphere cluster to install the OpenShift Container Platform cluster in.

### 20.3.10.3. Configuring the cluster-wide proxy during installation

Production environments can deny direct access to the internet and instead have an HTTP or HTTPS proxy available. You can configure a new OpenShift Container Platform cluster to use a proxy by configuring the proxy settings in the **install-config.yaml** file.

#### Prerequisites

- You have an existing **install-config.yaml** file.
- You reviewed the sites that your cluster requires access to and determined whether any of them need to bypass the proxy. By default, all cluster egress traffic is proxied, including calls to hosting cloud provider APIs. You added sites to the **Proxy** object's **spec.noProxy** field to bypass the proxy if necessary.



#### NOTE

The **Proxy** object **status.noProxy** field is populated with the values of the **networking.machineNetwork[].cidr**, **networking.clusterNetwork[].cidr**, and **networking.serviceNetwork[]** fields from your installation configuration.

For installations on Amazon Web Services (AWS), Google Cloud Platform (GCP), Microsoft Azure, and Red Hat OpenStack Platform (RHOSP), the **Proxy** object **status.noProxy** field is also populated with the instance metadata endpoint (**169.254.169.254**).

#### Procedure

1. Edit your **install-config.yaml** file and add the proxy settings. For example:

```
apiVersion: v1
baseDomain: my.domain.com
proxy:
  httpProxy: http://<username>:<pswd>@<ip>:<port> 1
  httpsProxy: https://<username>:<pswd>@<ip>:<port> 2
  noProxy: example.com 3
  additionalTrustBundle: | 4
    -----BEGIN CERTIFICATE-----
    <MY_TRUSTED_CA_CERT>
    -----END CERTIFICATE-----
  ...
```

- 1 A proxy URL to use for creating HTTP connections outside the cluster. The URL scheme must be **http**.

- 2 A proxy URL to use for creating HTTPS connections outside the cluster.
- 3 A comma-separated list of destination domain names, IP addresses, or other network CIDRs to exclude from proxying. Preface a domain with `.` to match subdomains only. For example, `.y.com` matches `x.y.com`, but not `y.com`. Use `*` to bypass the proxy for all destinations. You must include vCenter's IP address and the IP range that you use for its machines.
- 4 If provided, the installation program generates a config map that is named **user-ca-bundle** in the **openshift-config** namespace that contains one or more additional CA certificates that are required for proxying HTTPS connections. The Cluster Network Operator then creates a **trusted-ca-bundle** config map that merges these contents with the Red Hat Enterprise Linux CoreOS (RHCOS) trust bundle, and this config map is referenced in the **trustedCA** field of the **Proxy** object. The **additionalTrustBundle** field is required unless the proxy's identity certificate is signed by an authority from the RHCOS trust bundle.

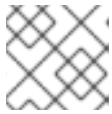
**NOTE**

The installation program does not support the proxy **readinessEndpoints** field.

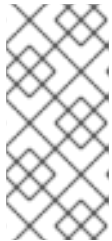
**NOTE**

If the installer times out, restart and then complete the deployment by using the **wait-for** command of the installer. For example:

```
$ ./openshift-install wait-for install-complete --log-level debug
```

2. Save the file and reference it when installing OpenShift Container Platform.

The installation program creates a cluster-wide proxy that is named **cluster** that uses the proxy settings in the provided **install-config.yaml** file. If no proxy settings are provided, a **cluster Proxy** object is still created, but it will have a nil **spec**.

**NOTE**

Only the **Proxy** object named **cluster** is supported, and no additional proxies can be created.

### 20.3.11. Deploying the cluster

You can install OpenShift Container Platform on a compatible cloud platform.

**IMPORTANT**

You can run the **create cluster** command of the installation program only once, during initial installation.

#### Prerequisites

- Obtain the OpenShift Container Platform installation program and the pull secret for your cluster.

## Procedure

1. Change to the directory that contains the installation program and initialize the cluster deployment:

```
$ ./openshift-install create cluster --dir <installation_directory> \ 1
--log-level=info 2
```

- 1** For **<installation\_directory>**, specify the location of your customized **./install-config.yaml** file.
- 2** To view different installation details, specify **warn**, **debug**, or **error** instead of **info**.

When the cluster deployment completes, directions for accessing your cluster, including a link to its web console and credentials for the **kubeadmin** user, display in your terminal.

```
...
INFO Install complete!
INFO To access the cluster as the system:admin user when using 'oc', run 'export
KUBECONFIG=/home/myuser/install_dir/auth/kubeconfig'
INFO Access the OpenShift web-console here: https://console-openshift-
console.apps.mycluster.example.com
INFO Login to the console with user: "kubeadmin", and password: "4vYBz-Ee6gm-ymBZj-Wt5AL"
INFO Time elapsed: 36m22s
```

+



### NOTE

The cluster access and credential information also outputs to **<installation\_directory>/openshift\_install.log** when an installation succeeds.

+

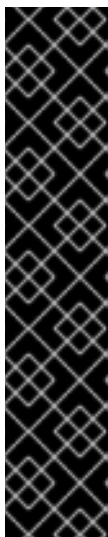

### IMPORTANT

- The Ignition config files that the installation program generates contain certificates that expire after 24 hours, which are then renewed at that time. If the cluster is shut down before renewing the certificates and the cluster is later restarted after the 24 hours have elapsed, the cluster automatically recovers the expired certificates. The exception is that you must manually approve the pending **node-bootstrapper** certificate signing requests (CSRs) to recover kubelet certificates. See the documentation for *Recovering from expired control plane certificates* for more information.
- It is recommended that you use Ignition config files within 12 hours after they are generated because the 24-hour certificate rotates from 16 to 22 hours after the cluster is installed. By using the Ignition config files within 12 hours, you can avoid installation failure if the certificate update runs during installation.

+

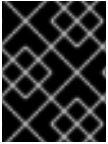
**IMPORTANT**

You must not delete the installation program or the files that the installation program creates. Both are required to delete the cluster.

**20.3.12. Installing the OpenShift CLI by downloading the binary**

You can install the OpenShift CLI (**oc**) to interact with OpenShift Container Platform from a command-line interface. You can install **oc** on Linux, Windows, or macOS.

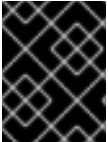
**IMPORTANT**

If you installed an earlier version of **oc**, you cannot use it to complete all of the commands in OpenShift Container Platform 4.10. Download and install the new version of **oc**.

**Installing the OpenShift CLI on Linux**

You can install the OpenShift CLI (**oc**) binary on Linux by using the following procedure.

**Procedure**

1. Navigate to the [OpenShift Container Platform downloads page](#) on the Red Hat Customer Portal.
2. Select the appropriate version in the **Version** drop-down menu.
3. Click **Download Now** next to the **OpenShift v4.10 Linux Client** entry and save the file.
4. Unpack the archive:

```
$ tar xvf <file>
```

5. Place the **oc** binary in a directory that is on your **PATH**.  
To check your **PATH**, execute the following command:

```
$ echo $PATH
```

After you install the OpenShift CLI, it is available using the **oc** command:

```
$ oc <command>
```

**Installing the OpenShift CLI on Windows**

You can install the OpenShift CLI (**oc**) binary on Windows by using the following procedure.

**Procedure**

1. Navigate to the [OpenShift Container Platform downloads page](#) on the Red Hat Customer Portal.
2. Select the appropriate version in the **Version** drop-down menu.
3. Click **Download Now** next to the **OpenShift v4.10 Windows Client** entry and save the file.
4. Unzip the archive with a ZIP program.

5. Move the **oc** binary to a directory that is on your **PATH**.  
To check your **PATH**, open the command prompt and execute the following command:

```
C:\> path
```

After you install the OpenShift CLI, it is available using the **oc** command:

```
C:\> oc <command>
```

### Installing the OpenShift CLI on macOS

You can install the OpenShift CLI (**oc**) binary on macOS by using the following procedure.

#### Procedure

1. Navigate to the [OpenShift Container Platform downloads page](#) on the Red Hat Customer Portal.
2. Select the appropriate version in the **Version** drop-down menu.
3. Click **Download Now** next to the **OpenShift v4.10 MacOSX Client** entry and save the file.
4. Unpack and unzip the archive.
5. Move the **oc** binary to a directory on your PATH.  
To check your **PATH**, open a terminal and execute the following command:

```
$ echo $PATH
```

After you install the OpenShift CLI, it is available using the **oc** command:

```
$ oc <command>
```

### 20.3.13. Logging in to the cluster by using the CLI

You can log in to your cluster as a default system user by exporting the cluster **kubeconfig** file. The **kubeconfig** file contains information about the cluster that is used by the CLI to connect a client to the correct cluster and API server. The file is specific to a cluster and is created during OpenShift Container Platform installation.

#### Prerequisites

- You deployed an OpenShift Container Platform cluster.
- You installed the **oc** CLI.

#### Procedure

1. Export the **kubeadmin** credentials:

```
$ export KUBECONFIG=<installation_directory>/auth/kubeconfig 1
```

- 1** For **<installation\_directory>**, specify the path to the directory that you stored the installation files in.



2. Verify you can run **oc** commands successfully using the exported configuration:

```
$ oc whoami
```

#### Example output

```
system:admin
```

## 20.3.14. Creating registry storage

After you install the cluster, you must create storage for the registry Operator.

### 20.3.14.1. Image registry removed during installation

On platforms that do not provide shareable object storage, the OpenShift Image Registry Operator bootstraps itself as **Removed**. This allows **openshift-installer** to complete installations on these platform types.

After installation, you must edit the Image Registry Operator configuration to switch the **managementState** from **Removed** to **Managed**.

### 20.3.14.2. Image registry storage configuration

The Image Registry Operator is not initially available for platforms that do not provide default storage. After installation, you must configure your registry to use storage so that the Registry Operator is made available.

Instructions are shown for configuring a persistent volume, which is required for production clusters. Where applicable, instructions are shown for configuring an empty directory as the storage location, which is available for only non-production clusters.

Additional instructions are provided for allowing the image registry to use block storage types by using the **Recreate** rollout strategy during upgrades.

#### 20.3.14.2.1. Configuring registry storage for VMware vSphere

As a cluster administrator, following installation you must configure your registry to use storage.

#### Prerequisites

- Cluster administrator permissions.
- A cluster on VMware vSphere.
- Persistent storage provisioned for your cluster, such as Red Hat OpenShift Data Foundation.



#### IMPORTANT

OpenShift Container Platform supports **ReadWriteOnce** access for image registry storage when you have only one replica. **ReadWriteOnce** access also requires that the registry uses the **Recreate** rollout strategy. To deploy an image registry that supports high availability with two or more replicas, **ReadWriteMany** access is required.

- Must have "100Gi" capacity.

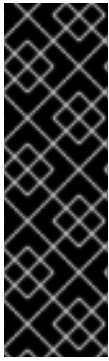

## IMPORTANT

Testing shows issues with using the NFS server on RHEL as storage backend for core services. This includes the OpenShift Container Registry and Quay, Prometheus for monitoring storage, and Elasticsearch for logging storage. Therefore, using RHEL NFS to back PVs used by core services is not recommended.

Other NFS implementations on the marketplace might not have these issues. Contact the individual NFS implementation vendor for more information on any testing that was possibly completed against these OpenShift Container Platform core components.

## Procedure

1. To configure your registry to use storage, change the **spec.storage.pvc** in the **configs.imageregistry/cluster** resource.



## NOTE

When using shared storage, review your security settings to prevent outside access.

2. Verify that you do not have a registry pod:

```
$ oc get pod -n openshift-image-registry -l docker-registry=default
```

## Example output

```
No resources found in openshift-image-registry namespace
```

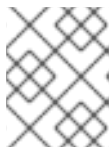

## NOTE

If you do have a registry pod in your output, you do not need to continue with this procedure.

3. Check the registry configuration:

```
$ oc edit configs.imageregistry.operator.openshift.io
```

## Example output

```
storage:
  pvc:
    claim: 1
```

- 1** Leave the **claim** field blank to allow the automatic creation of an **image-registry-storage** persistent volume claim (PVC). The PVC is generated based on the default storage class. However, be aware that the default storage class might provide ReadWriteOnce (RWO) volumes, such as a RADOS Block Device (RBD), which can cause issues when replicating to more than one replica.

4. Check the **clusteroperator** status:

```
$ oc get clusteroperator image-registry
```

### Example output

NAME	VERSION	AVAILABLE	PROGRESSING	DEGRADED
image-registry	4.7	True	False	6h50m

#### 20.3.14.2.2. Configuring block registry storage for VMware vSphere

To allow the image registry to use block storage types such as vSphere Virtual Machine Disk (VMDK) during upgrades as a cluster administrator, you can use the **Recreate** rollout strategy.

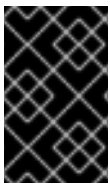

### IMPORTANT

Block storage volumes are supported but not recommended for use with image registry on production clusters. An installation where the registry is configured on block storage is not highly available because the registry cannot have more than one replica.

### Procedure

1. To set the image registry storage as a block storage type, patch the registry so that it uses the **Recreate** rollout strategy and runs with only **1** replica:

```
$ oc patch config.imageregistry.operator.openshift.io/cluster --type=merge -p '{"spec": {"rolloutStrategy": "Recreate", "replicas": 1}}'
```

2. Provision the PV for the block storage device, and create a PVC for that volume. The requested block volume uses the ReadWriteOnce (RWO) access mode.
  - a. Create a **pvc.yaml** file with the following contents to define a VMware vSphere **PersistentVolumeClaim** object:

```
kind: PersistentVolumeClaim
apiVersion: v1
metadata:
  name: image-registry-storage 1
  namespace: openshift-image-registry 2
spec:
  accessModes:
  - ReadWriteOnce 3
  resources:
    requests:
      storage: 100Gi 4
```

- 1 A unique name that represents the **PersistentVolumeClaim** object.
- 2 The namespace for the **PersistentVolumeClaim** object, which is **openshift-image-registry**.
- 3 The access mode of the persistent volume claim. With **ReadWriteOnce**, the volume

4 The size of the persistent volume claim.

b. Create the **PersistentVolumeClaim** object from the file:

```
$ oc create -f pvc.yaml -n openshift-image-registry
```

3. Edit the registry configuration so that it references the correct PVC:

```
$ oc edit config.imageregistry.operator.openshift.io -o yaml
```

### Example output

```
storage:
  pvc:
    claim: 1
```

1 Creating a custom PVC allows you to leave the **claim** field blank for the default automatic creation of an **image-registry-storage** PVC.

For instructions about configuring registry storage so that it references the correct PVC, see [Configuring the registry for vSphere](#).

## 20.3.15. Backing up VMware vSphere volumes

OpenShift Container Platform provisions new volumes as independent persistent disks to freely attach and detach the volume on any node in the cluster. As a consequence, it is not possible to back up volumes that use snapshots, or to restore volumes from snapshots. See [Snapshot Limitations](#) for more information.

### Procedure

To create a backup of persistent volumes:

1. Stop the application that is using the persistent volume.
2. Clone the persistent volume.
3. Restart the application.
4. Create a backup of the cloned volume.
5. Delete the cloned volume.

## 20.3.16. Telemetry access for OpenShift Container Platform

In OpenShift Container Platform 4.10, the Telemetry service, which runs by default to provide metrics about cluster health and the success of updates, requires internet access. If your cluster is connected to the internet, Telemetry runs automatically, and your cluster is registered to [OpenShift Cluster Manager](#).

After you confirm that your [OpenShift Cluster Manager](#) inventory is correct, either maintained automatically by Telemetry or manually by using OpenShift Cluster Manager, [use subscription watch](#) to track your OpenShift Container Platform subscriptions at the account or multi-cluster level.

## Additional resources

- See [About remote health monitoring](#) for more information about the Telemetry service

### 20.3.17. Next steps

- [Customize your cluster.](#)
- If necessary, you can [opt out of remote health reporting](#) .
- [Set up your registry and configure registry storage](#) .
- Optional: [View the events from the vSphere Problem Detector Operator](#) to determine if the cluster has permission or storage configuration issues.

## 20.4. INSTALLING A CLUSTER ON VSPHERE WITH NETWORK CUSTOMIZATIONS

In OpenShift Container Platform version 4.10, you can install a cluster on your VMware vSphere instance by using installer-provisioned infrastructure with customized network configuration options. By customizing your network configuration, your cluster can coexist with existing IP address allocations in your environment and integrate with existing MTU and VXLAN configurations. To customize the installation, you modify parameters in the **install-config.yaml** file before you install the cluster.

You must set most of the network configuration parameters during installation, and you can modify only **kubeProxy** configuration parameters in a running cluster.



### NOTE

OpenShift Container Platform supports deploying a cluster to a single VMware vCenter only. Deploying a cluster with machines/machine sets on multiple vCenters is not supported.

### 20.4.1. Prerequisites

- You reviewed details about the [OpenShift Container Platform installation and update](#) processes.
- You read the documentation on [selecting a cluster installation method and preparing it for users](#).
- You provisioned [persistent storage](#) for your cluster. To deploy a private image registry, your storage must provide **ReadWriteMany** access modes.
- The OpenShift Container Platform installer requires access to port 443 on the vCenter and ESXi hosts. You verified that port 443 is accessible.
- If you use a firewall, confirm with the administrator that port 443 is accessible. Control plane nodes must be able to reach vCenter and ESXi hosts on port 443 for the installation to succeed.
- If you use a firewall, you [configured it to allow the sites](#) that your cluster requires access to.



### NOTE

Be sure to also review this site list if you are configuring a proxy.

## 20.4.2. Internet access for OpenShift Container Platform

In OpenShift Container Platform 4.10, you require access to the internet to install your cluster.

You must have internet access to:

- Access [OpenShift Cluster Manager](#) to download the installation program and perform subscription management. If the cluster has internet access and you do not disable Telemetry, that service automatically entitles your cluster.
- Access [Quay.io](#) to obtain the packages that are required to install your cluster.
- Obtain the packages that are required to perform cluster updates.



### IMPORTANT

If your cluster cannot have direct internet access, you can perform a restricted network installation on some types of infrastructure that you provision. During that process, you download the required content and use it to populate a mirror registry with the installation packages. With some installation types, the environment that you install your cluster in will not require internet access. Before you update the cluster, you update the content of the mirror registry.

## 20.4.3. VMware vSphere infrastructure requirements

You must install the OpenShift Container Platform cluster on a VMware vSphere version 7 instance that meets the requirements for the components that you use.



### NOTE

OpenShift Container Platform version 4.10 does not support VMware vSphere version 8.0.

You can host the VMware vSphere infrastructure on-premise or on a [VMware Cloud Verified provider](#) that meets the requirements outlined in the following table:

**Table 20.20. Version requirements for vSphere virtual environments**

Virtual environment product	Required version
VM hardware version	15 or later
vSphere ESXi hosts	7
vCenter host	7



## IMPORTANT

Installing a cluster on VMware vSphere version 7.0 Update 1 is now deprecated. These versions are still fully supported, but version 4.10 of OpenShift Container Platform requires vSphere virtual hardware version 15 or later. Hardware version 15 is now the default for vSphere virtual machines in OpenShift Container Platform. To update the hardware version for your vSphere nodes, see the "Updating hardware on nodes running in vSphere" article.

If your vSphere nodes are below hardware version 15 or your VMware vSphere version is earlier than 6.7U3, upgrading from OpenShift Container Platform 4.10 to OpenShift Container Platform 4.11 is not available.

**Table 20.21. Minimum supported vSphere version for VMware components**

Component	Minimum supported versions	Description
Hypervisor	vSphere 7 with HW version 15	This version is the minimum version that Red Hat Enterprise Linux CoreOS (RHCOS) supports. For more information about supported hardware on the latest version of Red Hat Enterprise Linux (RHEL) that is compatible with RHCOS, see <a href="#">Hardware</a> on the Red Hat Customer Portal.
Storage with in-tree drivers	vSphere 7	This plugin creates vSphere storage by using the in-tree storage drivers for vSphere included in OpenShift Container Platform.
Optional: Networking (NSX-T)	vSphere 7	vSphere 7 is required for OpenShift Container Platform. For more information about the compatibility of NSX and OpenShift Container Platform, see the Release Notes section of VMware's <a href="#">NSX container plugin documentation</a> .

If you use a vSphere version 6.5 instance, upgrade to 7.0 before you install OpenShift Container Platform.

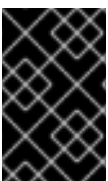

## IMPORTANT

You must ensure that the time on your ESXi hosts is synchronized before you install OpenShift Container Platform. See [Edit Time Configuration for a Host](#) in the VMware documentation.

### 20.4.4. Network connectivity requirements

You must configure the network connectivity between machines to allow OpenShift Container Platform cluster components to communicate.

Review the following details about the required network ports.

**Table 20.22. Ports used for all-machine to all-machine communications**

Protocol	Port	Description
ICMP	N/A	Network reachability tests
TCP	<b>1936</b>	Metrics
	<b>9000-9999</b>	Host level services, including the node exporter on ports <b>9100-9101</b> and the Cluster Version Operator on port <b>9099</b> .
	<b>10250-10259</b>	The default ports that Kubernetes reserves
	<b>10256</b>	openshift-sdn
UDP	<b>4789</b>	virtual extensible LAN (VXLAN)
	<b>6081</b>	Geneve
	<b>9000-9999</b>	Host level services, including the node exporter on ports <b>9100-9101</b> .
	<b>500</b>	IPsec IKE packets
	<b>4500</b>	IPsec NAT-T packets
TCP/UDP	<b>30000-32767</b>	Kubernetes node port
ESP	N/A	IPsec Encapsulating Security Payload (ESP)

**Table 20.23. Ports used for all-machine to control plane communications**

Protocol	Port	Description
TCP	<b>6443</b>	Kubernetes API

**Table 20.24. Ports used for control plane machine to control plane machine communications**

Protocol	Port	Description
TCP	<b>2379-2380</b>	etcd server and peer ports



### 20.4.5. VMware vSphere CSI Driver Operator requirements

To install the vSphere CSI Driver Operator, the following requirements must be met:

- VMware vSphere version 6.7U3 or later
- Virtual machines of hardware version 15 or later
- No third-party vSphere CSI driver already installed in the cluster

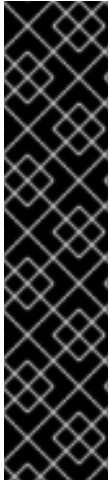

#### IMPORTANT

If a third-party vSphere CSI driver is present in the cluster, OpenShift Container Platform does not overwrite it. If you continue with the third-party vSphere CSI driver when upgrading to the next major version of OpenShift Container Platform, the **oc** CLI prompts you with the following message:

```
VSphereCSIDriverOperatorCRUpgradeable: VMwareVSphereControllerUpgradeable:
found existing unsupported csi.vsphere.vmware.com driver
```

The previous message informs you that Red Hat does not support the third-party vSphere CSI driver during an OpenShift Container Platform upgrade operation. You can choose to ignore this message and continue with the upgrade operation.

#### Additional resources

- To remove a third-party vSphere CSI driver, see [Removing a third-party vSphere CSI Driver](#).
- To update the hardware version for your vSphere nodes, see [Updating hardware on nodes running in vSphere](#).

### 20.4.6. vCenter requirements

Before you install an OpenShift Container Platform cluster on your vCenter that uses infrastructure that the installer provisions, you must prepare your environment.

#### Required vCenter account privileges

To install an OpenShift Container Platform cluster in a vCenter, the installation program requires access to an account with privileges to read and create the required resources. Using an account that has global administrative privileges is the simplest way to access all of the necessary permissions.

If you cannot use an account with global administrative privileges, you must create roles to grant the privileges necessary for OpenShift Container Platform cluster installation. While most of the privileges are always required, some are required only if you plan for the installation program to provision a folder to contain the OpenShift Container Platform cluster on your vCenter instance, which is the default behavior. You must create or amend vSphere roles for the specified objects to grant the required privileges.

An additional role is required if the installation program is to create a vSphere virtual machine folder.

#### Example 20.7. Roles and privileges required for installation in vSphere API

vSphere object for role	When required	Required privileges in vSphere API
vSphere vCenter	Always	<b>Cns.Searchable</b> <b>InventoryService.Tagging.AttachTag</b> <b>InventoryService.Tagging.CreateCategory</b> <b>InventoryService.Tagging.CreateTag</b> <b>InventoryService.Tagging.DeleteCategory</b> <b>InventoryService.Tagging.DeleteTag</b> <b>InventoryService.Tagging.EditCategory</b> <b>InventoryService.Tagging.EditTag</b> <b>Sessions.ValidateSession</b> <b>StorageProfile.Update</b> <b>StorageProfile.View</b>
vSphere vCenter Cluster	If VMs will be created in the cluster root	<b>Host.Config.StorageResource.AssignVMToPool</b> <b>VApp.AssignResourcePool</b> <b>VApp.Import</b> <b>VirtualMachine.Config.AddNewDisk</b>
vSphere vCenter Resource Pool	If an existing resource pool is provided	<b>Host.Config.StorageResource.AssignVMToPool</b> <b>VApp.AssignResourcePool</b> <b>VApp.Import</b> <b>VirtualMachine.Config.AddNewDisk</b>
vSphere Datastore	Always	<b>Datastore.AllocateSpace</b> <b>Datastore.Browse</b> <b>Datastore.FileManagement</b> <b>InventoryService.Tagging.ObjectAttachable</b>
vSphere Port Group	Always	<b>Network.Assign</b>
Virtual Machine Folder	Always	<b>InventoryService.Tagging.ObjectAttachable</b> <b>Resource.AssignVMToPool</b> <b>VApp.Import</b> <b>VirtualMachine.Config.AddExistingDisk</b> <b>VirtualMachine.Config.AddNewDisk</b> <b>VirtualMachine.Config.Add</b>

vSphere object for role	When required	RemoveDevice Required privileges in vSphere API
		VirtualMachine.Config.AdvancedConfig VirtualMachine.Config.Annotation VirtualMachine.Config.CPUCount VirtualMachine.Config.DiskExtend VirtualMachine.Config.DiskLease VirtualMachine.Config.EditDevice VirtualMachine.Config.Memory VirtualMachine.Config.RemoveDisk VirtualMachine.Config.Rename VirtualMachine.Config.ResetGuestInfo VirtualMachine.Config.Resource VirtualMachine.Config.Settings VirtualMachine.Config.UpgradeVirtualHardware VirtualMachine.Interact.GuestControl VirtualMachine.Interact.PowerOff VirtualMachine.Interact.PowerOn VirtualMachine.Interact.Reset VirtualMachine.Inventory.Create VirtualMachine.Inventory.CreateFromExisting VirtualMachine.Inventory.Delete VirtualMachine.Provisioning.Clone VirtualMachine.Provisioning.MarkAsTemplate VirtualMachine.Provisioning.DeployTemplate
vSphere vCenter Datacenter	If the installation program creates the virtual machine folder	InventoryService.Tagging.ObjectAttachable Resource.AssignVMToPool VApp.Import VirtualMachine.Config.AddExistingDisk VirtualMachine.Config.AddNewDisk

vSphere object for role	When required	Required privileges in vSphere API
		<b>VirtualMachine.Config.AddRemoveDevice</b> <b>VirtualMachine.Config.AdvancedConfig</b> <b>VirtualMachine.Config.Annotation</b> <b>VirtualMachine.Config.CPUCount</b> <b>VirtualMachine.Config.DiskExtend</b> <b>VirtualMachine.Config.DiskLease</b> <b>VirtualMachine.Config.EditDevice</b> <b>VirtualMachine.Config.Memory</b> <b>VirtualMachine.Config.RemoveDisk</b> <b>VirtualMachine.Config.Rename</b> <b>VirtualMachine.Config.ResetGuestInfo</b> <b>VirtualMachine.Config.Resource</b> <b>VirtualMachine.Config.Settings</b> <b>VirtualMachine.Config.UpgradeVirtualHardware</b> <b>VirtualMachine.Interact.GuestControl</b> <b>VirtualMachine.Interact.PowerOff</b> <b>VirtualMachine.Interact.PowerOn</b> <b>VirtualMachine.Interact.Reset</b> <b>VirtualMachine.Inventory.Create</b> <b>VirtualMachine.Inventory.CreateFromExisting</b> <b>VirtualMachine.Inventory.Delete</b> <b>VirtualMachine.Provisioning.Clone</b> <b>VirtualMachine.Provisioning.DeployTemplate</b> <b>VirtualMachine.Provisioning.MarkAsTemplate</b> <b>Folder.Create</b> <b>Folder.Delete</b>

Example 20.8. Roles and privileges required for installation in vCenter graphical user interface (GUI)

vSphere object for role	When required	Required privileges in vCenter GUI
vSphere vCenter	Always	<b>Cns.Searchable</b> <b>"vSphere Tagging"."Assign or Unassign vSphere Tag"</b> <b>"vSphere Tagging"."Create vSphere Tag Category"</b> <b>"vSphere Tagging"."Create vSphere Tag"</b> <b>vSphere Tagging"."Delete vSphere Tag Category"</b> <b>"vSphere Tagging"."Delete vSphere Tag"</b> <b>"vSphere Tagging"."Edit vSphere Tag Category"</b> <b>"vSphere Tagging"."Edit vSphere Tag"</b> <b>Sessions."Validate session"</b> <b>"Profile-driven storage"."Profile-driven storage update"</b> <b>"Profile-driven storage"."Profile-driven storage view"</b>
vSphere vCenter Cluster	If VMs will be created in the cluster root	<b>Host.Configuration."Storage partition configuration"</b> <b>Resource."Assign virtual machine to resource pool"</b> <b>VApp."Assign resource pool"</b> <b>VApp.Import</b> <b>"Virtual machine"."Change Configuration"."Add new disk"</b>
vSphere vCenter Resource Pool	If an existing resource pool is provided	<b>Host.Configuration."Storage partition configuration"</b> <b>Resource."Assign virtual machine to resource pool"</b> <b>VApp."Assign resource pool"</b> <b>VApp.Import</b> <b>"Virtual machine"."Change Configuration"."Add new disk"</b>

vSphere object for role	When required	Required privileges in vCenter GUI
vSphere Datastore	Always	<b>Datastore."Allocate space"</b> <b>Datastore."Browse datastore"</b> <b>Datastore."Low level file operations"</b> <b>"vSphere Tagging"."Assign or Unassign vSphere Tag on Object"</b>
vSphere Port Group	Always	<b>Network."Assign network"</b>
Virtual Machine Folder	Always	<b>"vSphere Tagging"."Assign or Unassign vSphere Tag on Object"</b> <b>Resource."Assign virtual machine to resource pool"</b> <b>VApp.Import</b> <b>"Virtual machine"."Change Configuration"."Add existing disk"</b> <b>"Virtual machine"."Change Configuration"."Add new disk"</b> <b>"Virtual machine"."Change Configuration"."Add or remove device"</b> <b>"Virtual machine"."Change Configuration"."Advanced configuration"</b> <b>"Virtual machine"."Change Configuration"."Set annotation"</b> <b>"Virtual machine"."Change Configuration"."Change CPU count"</b> <b>"Virtual machine"."Change Configuration"."Extend virtual disk"</b> <b>"Virtual machine"."Change Configuration"."Acquire disk lease"</b> <b>"Virtual machine"."Change Configuration"."Modify device settings"</b> <b>"Virtual machine"."Change Configuration"."Change Memory"</b> <b>"Virtual machine"."Change Configuration"."Remove disk"</b>

vSphere object for role	When required	"Virtual machine". "Change Configuration". "Rename Virtual machine". "Change Configuration". "Reset guest information" "Virtual machine". "Change Configuration". "Change resource" "Virtual machine". "Change Configuration". "Change Settings" "Virtual machine". "Change Configuration". "Upgrade virtual machine compatibility" "Virtual machine". Interaction. "Guest operating system management by VIX API" "Virtual machine". Interaction. "Power off" "Virtual machine". Interaction. "Power on" "Virtual machine". Interaction. "Reset" "Virtual machine". "Edit Inventory". "Create new" "Virtual machine". "Edit Inventory". "Create from existing" "Virtual machine". "Edit Inventory". "Remove" "Virtual machine". Provisioning. "Clone virtual machine" "Virtual machine". Provisioning. "Mark as template" "Virtual machine". Provisioning. "Deploy template"
vSphere vCenter Datacenter	If the installation program creates the virtual machine folder	"vSphere Tagging". "Assign or Unassign vSphere Tag on Object" Resource. "Assign virtual machine to resource pool" VApp.Import "Virtual machine". "Change Configuration". "Add existing disk" "Virtual machine". "Change Configuration". "Add new disk"

vSphere object for role	When required	Required privileges in vCenter GUI
		<p>"Virtual machine"."Change Configuration".Add or remove device"</p> <p>"Virtual machine"."Change Configuration"."Advanced configuration"</p> <p>"Virtual machine"."Change Configuration"."Set annotation"</p> <p>"Virtual machine"."Change Configuration"."Change CPU count"</p> <p>"Virtual machine"."Change Configuration"."Extend virtual disk"</p> <p>"Virtual machine"."Change Configuration"."Acquire disk lease"</p> <p>"Virtual machine"."Change Configuration"."Modify device settings"</p> <p>"Virtual machine"."Change Configuration"."Change Memory"</p> <p>"Virtual machine"."Change Configuration"."Remove disk"</p> <p>"Virtual machine"."Change Configuration".Rename</p> <p>"Virtual machine"."Change Configuration"."Reset guest information"</p> <p>"Virtual machine"."Change Configuration"."Change resource"</p> <p>"Virtual machine"."Change Configuration"."Change Settings"</p> <p>"Virtual machine"."Change Configuration"."Upgrade virtual machine compatibility"</p> <p>"Virtual machine".Interaction."Guest operating system management by VIX API"</p> <p>"Virtual machine".Interaction."Power off"</p> <p>"Virtual machine".Interaction."Power on"</p> <p>"Virtual machine".Interaction.Reset</p> <p>"Virtual machine"."Edit Inventory"."Create new"</p>



vSphere object for role	When required	"Virtual machine". "Edit Inventory". "Create from Existing" "Virtual machine". "Edit Inventory". "Remove" "Virtual machine". Provisioning. "Clone virtual machine" "Virtual machine". Provisioning. "Deploy template" "Virtual machine". Provisioning. "Mark as template" Folder. "Create folder" Folder. "Delete folder"

Additionally, the user requires some **ReadOnly** permissions, and some of the roles require permission to propagate the permissions to child objects. These settings vary depending on whether or not you install the cluster into an existing folder.

#### Example 20.9. Required permissions and propagation settings

vSphere object	When required	Propagate to children	Permissions required
vSphere vCenter	Always	False	Listed required privileges
vSphere vCenter Datacenter	Existing folder	False	<b>ReadOnly</b> permission
	Installation program creates the folder	True	Listed required privileges
vSphere vCenter Cluster	Existing resource pool	False	<b>ReadOnly</b> permission
	VMs in cluster root	True	Listed required privileges
vSphere vCenter Datastore	Always	False	Listed required privileges
vSphere Switch	Always	False	<b>ReadOnly</b> permission
vSphere Port Group	Always	False	Listed required privileges
vSphere vCenter Virtual Machine Folder	Existing folder	True	Listed required privileges

vSphere object	When required	Propagate to children	Permissions required
vSphere vCenter Resource Pool	Existing resource pool	True	Listed required privileges

For more information about creating an account with only the required privileges, see [vSphere Permissions and User Management Tasks](#) in the vSphere documentation.

### Using OpenShift Container Platform with vMotion

If you intend on using vMotion in your vSphere environment, consider the following before installing a OpenShift Container Platform cluster.

- OpenShift Container Platform generally supports compute-only vMotion. Using Storage vMotion can cause issues and is not supported.  
To help ensure the uptime of your compute and control plane nodes, it is recommended that you follow the VMware best practices for vMotion. It is also recommended to use VMware anti-affinity rules to improve the availability of OpenShift Container Platform during maintenance or hardware issues.

For more information about vMotion and anti-affinity rules, see the VMware vSphere documentation for [vMotion networking requirements](#) and [VM anti-affinity rules](#).

- If you are using vSphere volumes in your pods, migrating a VM across datastores either manually or through Storage vMotion causes, invalid references within OpenShift Container Platform persistent volume (PV) objects. These references prevent affected pods from starting up and can result in data loss.
- Similarly, OpenShift Container Platform does not support selective migration of VMDKs across datastores, using datastore clusters for VM provisioning or for dynamic or static provisioning of PVs, or using a datastore that is part of a datastore cluster for dynamic or static provisioning of PVs.

### Cluster resources

When you deploy an OpenShift Container Platform cluster that uses installer-provisioned infrastructure, the installation program must be able to create several resources in your vCenter instance.

A standard OpenShift Container Platform installation creates the following vCenter resources:

- 1 Folder
- 1 Tag category
- 1 Tag
- Virtual machines:
  - 1 template
  - 1 temporary bootstrap node
  - 3 control plane nodes
  - 3 compute machines

Although these resources use 856 GB of storage, the bootstrap node is destroyed during the cluster installation process. A minimum of 800 GB of storage is required to use a standard cluster.

If you deploy more compute machines, the OpenShift Container Platform cluster will use more storage.

### Cluster limits

Available resources vary between clusters. The number of possible clusters within a vCenter is limited primarily by available storage space and any limitations on the number of required resources. Be sure to consider both limitations to the vCenter resources that the cluster creates and the resources that you require to deploy a cluster, such as IP addresses and networks.

### Networking requirements

You must use the Dynamic Host Configuration Protocol (DHCP) for the network and ensure that the DHCP server is configured to provide persistent IP addresses to the cluster machines. In the DHCP lease, you must configure the DHCP to use the default gateway. All nodes must be in the same VLAN. You cannot scale the cluster using a second VLAN as a Day 2 operation. Additionally, you must create the following networking resources before you install the OpenShift Container Platform cluster:



#### NOTE

It is recommended that each OpenShift Container Platform node in the cluster must have access to a Network Time Protocol (NTP) server that is discoverable via DHCP. Installation is possible without an NTP server. However, asynchronous server clocks will cause errors, which NTP server prevents.

### Required IP Addresses

An installer-provisioned vSphere installation requires two static IP addresses:

- The **API** address is used to access the cluster API.
- The **Ingress** address is used for cluster ingress traffic.

You must provide these IP addresses to the installation program when you install the OpenShift Container Platform cluster.

### DNS records

You must create DNS records for two static IP addresses in the appropriate DNS server for the vCenter instance that hosts your OpenShift Container Platform cluster. In each record, **<cluster\_name>** is the cluster name and **<base\_domain>** is the cluster base domain that you specify when you install the cluster. A complete DNS record takes the form: **<component>.<cluster\_name>.<base\_domain>.**

Table 20.25. Required DNS records

Component	Record	Description
API VIP	<b>api.&lt;cluster_name&gt;.&lt;base_domain&gt;.</b>	This DNS A/AAAA or CNAME record must point to the load balancer for the control plane machines. This record must be resolvable by both clients external to the cluster and from all the nodes within the cluster.

Component	Record	Description
Ingress VIP	*.apps.<cluster_name>.<base_domain>.	A wildcard DNS A/AAAA or CNAME record that points to the load balancer that targets the machines that run the Ingress router pods, which are the worker nodes by default. This record must be resolvable by both clients external to the cluster and from all the nodes within the cluster.

### 20.4.7. Generating a key pair for cluster node SSH access

During an OpenShift Container Platform installation, you can provide an SSH public key to the installation program. The key is passed to the Red Hat Enterprise Linux CoreOS (RHCOS) nodes through their Ignition config files and is used to authenticate SSH access to the nodes. The key is added to the `~/.ssh/authorized_keys` list for the **core** user on each node, which enables password-less authentication.

After the key is passed to the nodes, you can use the key pair to SSH in to the RHCOS nodes as the user **core**. To access the nodes through SSH, the private key identity must be managed by SSH for your local user.

If you want to SSH in to your cluster nodes to perform installation debugging or disaster recovery, you must provide the SSH public key during the installation process. The `./openshift-install gather` command also requires the SSH public key to be in place on the cluster nodes.



#### IMPORTANT

Do not skip this procedure in production environments, where disaster recovery and debugging is required.



#### NOTE

You must use a local key, not one that you configured with platform-specific approaches such as [AWS key pairs](#).

#### Procedure

1. If you do not have an existing SSH key pair on your local machine to use for authentication onto your cluster nodes, create one. For example, on a computer that uses a Linux operating system, run the following command:

```
$ ssh-keygen -t ed25519 -N "" -f <path>/<file_name> 1
```

- 1 Specify the path and file name, such as `~/.ssh/id_ed25519`, of the new SSH key. If you have an existing key pair, ensure your public key is in the your `~/.ssh` directory.

**NOTE**

If you plan to install an OpenShift Container Platform cluster that uses FIPS validated or Modules In Process cryptographic libraries on the **x86\_64** architecture, do not create a key that uses the **ed25519** algorithm. Instead, create a key that uses the **rsa** or **ecdsa** algorithm.

- View the public SSH key:

```
$ cat <path>/<file_name>.pub
```

For example, run the following to view the `~/.ssh/id_ed25519.pub` public key:

```
$ cat ~/.ssh/id_ed25519.pub
```

- Add the SSH private key identity to the SSH agent for your local user, if it has not already been added. SSH agent management of the key is required for password-less SSH authentication onto your cluster nodes, or if you want to use the `./openshift-install gather` command.

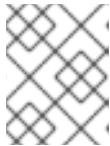
**NOTE**

On some distributions, default SSH private key identities such as `~/.ssh/id_rsa` and `~/.ssh/id_dsa` are managed automatically.

- If the **ssh-agent** process is not already running for your local user, start it as a background task:

```
$ eval "$(ssh-agent -s)"
```

**Example output**

```
Agent pid 31874
```

**NOTE**

If your cluster is in FIPS mode, only use FIPS-compliant algorithms to generate the SSH key. The key must be either RSA or ECDSA.

- Add your SSH private key to the **ssh-agent**:

```
$ ssh-add <path>/<file_name> 1
```

- 1** Specify the path and file name for your SSH private key, such as `~/.ssh/id_ed25519`

**Example output**

```
Identity added: /home/<you>/<path>/<file_name> (<computer_name>)
```

**Next steps**

- When you install OpenShift Container Platform, provide the SSH public key to the installation program.

## 20.4.8. Obtaining the installation program

Before you install OpenShift Container Platform, download the installation file on a local computer.

### Prerequisites

- You have a computer that runs Linux or macOS, with 500 MB of local disk space

### Procedure

1. Access the [Infrastructure Provider](#) page on the OpenShift Cluster Manager site. If you have a Red Hat account, log in with your credentials. If you do not, create an account.
2. Select your infrastructure provider.
3. Navigate to the page for your installation type, download the installation program that corresponds with your host operating system and architecture, and place the file in the directory where you will store the installation configuration files.

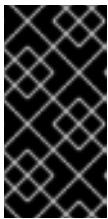

#### IMPORTANT

The installation program creates several files on the computer that you use to install your cluster. You must keep the installation program and the files that the installation program creates after you finish installing the cluster. Both files are required to delete the cluster.

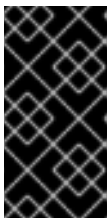

#### IMPORTANT

Deleting the files created by the installation program does not remove your cluster, even if the cluster failed during installation. To remove your cluster, complete the OpenShift Container Platform uninstallation procedures for your specific cloud provider.

4. Extract the installation program. For example, on a computer that uses a Linux operating system, run the following command:

```
$ tar -xvf openshift-install-linux.tar.gz
```

5. Download your installation [pull secret from the Red Hat OpenShift Cluster Manager](#) . This pull secret allows you to authenticate with the services that are provided by the included authorities, including Quay.io, which serves the container images for OpenShift Container Platform components.

## 20.4.9. Adding vCenter root CA certificates to your system trust

Because the installation program requires access to your vCenter's API, you must add your vCenter's trusted root CA certificates to your system trust before you install an OpenShift Container Platform cluster.

### Procedure

1. From the vCenter home page, download the vCenter's root CA certificates. Click **Download trusted root CA certificates** in the vSphere Web Services SDK section. The **<vCenter>/certs/download.zip** file downloads.
2. Extract the compressed file that contains the vCenter root CA certificates. The contents of the compressed file resemble the following file structure:

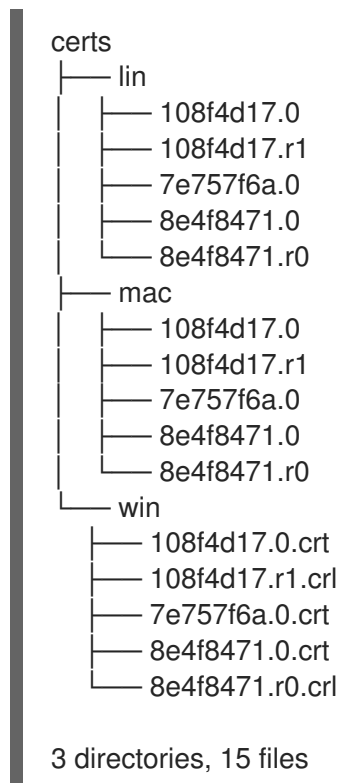

3. Add the files for your operating system to the system trust. For example, on a Fedora operating system, run the following command:

```
# cp certs/lin/* /etc/pki/ca-trust/source/anchors
```

4. Update your system trust. For example, on a Fedora operating system, run the following command:

```
# update-ca-trust extract
```

### 20.4.10. Creating the installation configuration file

You can customize the OpenShift Container Platform cluster you install on VMware vSphere.

#### Prerequisites

- Obtain the OpenShift Container Platform installation program and the pull secret for your cluster.
- Obtain service principal permissions at the subscription level.

#### Procedure

1. Create the **install-config.yaml** file.
  - a. Change to the directory that contains the installation program and run the following

command:

```
$. /openshift-install create install-config --dir <installation_directory> 1
```

- 1** For **<installation\_directory>**, specify the directory name to store the files that the installation program creates.



### IMPORTANT

Specify an empty directory. Some installation assets, like bootstrap X.509 certificates have short expiration intervals, so you must not reuse an installation directory. If you want to reuse individual files from another cluster installation, you can copy them into your directory. However, the file names for the installation assets might change between releases. Use caution when copying installation files from an earlier OpenShift Container Platform version.

- b. At the prompts, provide the configuration details for your cloud:
- i. Optional: Select an SSH key to use to access your cluster machines.



### NOTE

For production OpenShift Container Platform clusters on which you want to perform installation debugging or disaster recovery, specify an SSH key that your **ssh-agent** process uses.

- ii. Select **vsphere** as the platform to target.
- iii. Specify the name of your vCenter instance.
- iv. Specify the user name and password for the vCenter account that has the required permissions to create the cluster.  
The installation program connects to your vCenter instance.
- v. Select the datacenter in your vCenter instance to connect to.
- vi. Select the default vCenter datastore to use.
- vii. Select the vCenter cluster to install the OpenShift Container Platform cluster in. The installation program uses the root resource pool of the vSphere cluster as the default resource pool.
- viii. Select the network in the vCenter instance that contains the virtual IP addresses and DNS records that you configured.
- ix. Enter the virtual IP address that you configured for control plane API access.
- x. Enter the virtual IP address that you configured for cluster ingress.
- xi. Enter the base domain. This base domain must be the same one that you used in the DNS records that you configured.



- xii. Enter a descriptive name for your cluster. The cluster name you enter must match the cluster name you specified when configuring the DNS records.
  - xiii. Paste the [pull secret from the Red Hat OpenShift Cluster Manager](#) .
2. Modify the **install-config.yaml** file. You can find more information about the available parameters in the "Installation configuration parameters" section.
  3. Back up the **install-config.yaml** file so that you can use it to install multiple clusters.

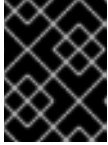

### IMPORTANT

The **install-config.yaml** file is consumed during the installation process. If you want to reuse the file, you must back it up now.

#### 20.4.10.1. Installation configuration parameters

Before you deploy an OpenShift Container Platform cluster, you provide parameter values to describe your account on the cloud platform that hosts your cluster and optionally customize your cluster's platform. When you create the **install-config.yaml** installation configuration file, you provide values for the required parameters through the command line. If you customize your cluster, you can modify the **install-config.yaml** file to provide more details about the platform.



### NOTE

After installation, you cannot modify these parameters in the **install-config.yaml** file.

##### 20.4.10.1.1. Required configuration parameters

Required installation configuration parameters are described in the following table:

Table 20.26. Required parameters

Parameter	Description	Values
<b>apiVersion</b>	The API version for the <b>install-config.yaml</b> content. The current version is <b>v1</b> . The installer may also support older API versions.	String
<b>baseDomain</b>	The base domain of your cloud provider. The base domain is used to create routes to your OpenShift Container Platform cluster components. The full DNS name for your cluster is a combination of the <b>baseDomain</b> and <b>metadata.name</b> parameter values that uses the <b>&lt;metadata.name&gt;</b> . <b>&lt;baseDomain&gt;</b> format.	A fully-qualified domain or subdomain name, such as <b>example.com</b> .

Parameter	Description	Values
<b>metadata</b>	Kubernetes resource <b>ObjectMeta</b> , from which only the <b>name</b> parameter is consumed.	Object
<b>metadata.name</b>	The name of the cluster. DNS records for the cluster are all subdomains of <b>{{.metadata.name}}</b> . <b>{{.baseDomain}}</b> .	String of lowercase letters and hyphens (-), such as <b>dev</b> .
<b>platform</b>	The configuration for the specific platform upon which to perform the installation: <b>alibabacloud</b> , <b>aws</b> , <b>baremetal</b> , <b>azure</b> , <b>gcp</b> , <b>ibmcloud</b> , <b>openstack</b> , <b>ovirt</b> , <b>vsphere</b> , or <b>{}</b> . For additional information about <b>platform.&lt;platform&gt;</b> parameters, consult the table for your specific platform that follows.	Object
<b>pullSecret</b>	Get a <a href="#">pull secret from the Red Hat OpenShift Cluster Manager</a> to authenticate downloading container images for OpenShift Container Platform components from services such as Quay.io.	<pre>{   "auths":{     "cloud.openshift.com":{       "auth":"b3Blb=",       "email":"you@example.com"     },     "quay.io":{       "auth":"b3Blb=",       "email":"you@example.com"     }   } }</pre>

#### 20.4.10.1.2. Network configuration parameters

You can customize your installation configuration based on the requirements of your existing network infrastructure. For example, you can expand the IP address block for the cluster network or provide different IP address blocks than the defaults.

Only IPv4 addresses are supported.

Table 20.27. Network parameters

Parameter	Description	Values
<b>networking</b>	The configuration for the cluster network.	Object  <b>NOTE</b> You cannot modify parameters specified by the <b>networking</b> object after installation.
<b>networking.networkType</b>	The cluster network provider Container Network Interface (CNI) plugin to install.	Either <b>OpenShiftSDN</b> or <b>OVNKubernetes</b> . <b>OpenShiftSDN</b> is a CNI provider for all-Linux networks. <b>OVNKubernetes</b> is a CNI provider for Linux networks and hybrid networks that contain both Linux and Windows servers. The default value is <b>OpenShiftSDN</b> .
<b>networking.clusterNetwork</b>	The IP address blocks for pods.  The default value is <b>10.128.0.0/14</b> with a host prefix of <b>/23</b> .  If you specify multiple IP address blocks, the blocks must not overlap.	An array of objects. For example:  <pre>networking:   clusterNetwork:     - cidr: 10.128.0.0/14       hostPrefix: 23</pre>
<b>networking.clusterNetwork.cidr</b>	Required if you use <b>networking.clusterNetwork</b> . An IP address block.  An IPv4 network.	An IP address block in Classless Inter-Domain Routing (CIDR) notation. The prefix length for an IPv4 block is between <b>0</b> and <b>32</b> .
<b>networking.clusterNetwork.hostPrefix</b>	The subnet prefix length to assign to each individual node. For example, if <b>hostPrefix</b> is set to <b>23</b> then each node is assigned a <b>/23</b> subnet out of the given <b>cidr</b> . A <b>hostPrefix</b> value of <b>23</b> provides 510 ( $2^{(32 - 23)} - 2$ ) pod IP addresses.	A subnet prefix.  The default value is <b>23</b> .
<b>networking.serviceNetwork</b>	The IP address block for services. The default value is <b>172.30.0.0/16</b> .  The OpenShift SDN and OVN-Kubernetes network providers support only a single IP address block for the service network.	An array with an IP address block in CIDR format. For example:  <pre>networking:   serviceNetwork:     - 172.30.0.0/16</pre>

Parameter	Description	Values
<b>networking.machineNetwork</b>	The IP address blocks for machines.  If you specify multiple IP address blocks, the blocks must not overlap.	An array of objects. For example:  <pre>networking:   machineNetwork:   - cidr: 10.0.0.0/16</pre>
<b>networking.machineNetwork.cidr</b>	Required if you use <b>networking.machineNetwork</b> . An IP address block. The default value is <b>10.0.0.0/16</b> for all platforms other than libvirt. For libvirt, the default value is <b>192.168.126.0/24</b> .	An IP network block in CIDR notation.  For example, <b>10.0.0.0/16</b> .   <p><b>NOTE</b></p> <p>Set the <b>networking.machineNetwork</b> to match the CIDR that the preferred NIC resides in.</p>

### 20.4.10.1.3. Optional configuration parameters



Optional installation configuration parameters are described in the following table:

Table 20.28. Optional parameters

Parameter	Description	Values
<b>additionalTrustBundle</b>	A PEM-encoded X.509 certificate bundle that is added to the nodes' trusted certificate store. This trust bundle may also be used when a proxy has been configured.	String
<b>cgroupsV2</b>	Enables <a href="#">Linux control groups version 2</a> (cgroups v2) on specific nodes in your cluster. The OpenShift Container Platform process for enabling cgroups v2 disables all cgroup version 1 controllers and hierarchies. The OpenShift Container Platform cgroups version 2 feature is in Developer Preview and is not supported by Red Hat at this time.	<b>true</b>
<b>compute</b>	The configuration for the machines that comprise the compute nodes.	Array of <b>MachinePool</b> objects.



Parameter	Description	Values
<b>compute.architecture</b>	Determines the instruction set architecture of the machines in the pool. Currently, clusters with varied architectures are not supported. All pools must specify the same architecture. Valid values are <b>amd64</b> (the default).	String
<b>compute.hyperthreading</b>	Whether to enable or disable simultaneous multithreading, or <b>hyperthreading</b> , on compute machines. By default, simultaneous multithreading is enabled to increase the performance of your machines' cores.   <b>IMPORTANT</b> If you disable simultaneous multithreading, ensure that your capacity planning accounts for the dramatically decreased machine performance.	<b>Enabled</b> or <b>Disabled</b>
<b>compute.name</b>	Required if you use <b>compute</b> . The name of the machine pool.	<b>worker</b>
<b>compute.platform</b>	Required if you use <b>compute</b> . Use this parameter to specify the cloud provider to host the worker machines. This parameter value must match the <b>controlPlane.platform</b> parameter value.	<b>alibabacloud, aws, azure, gcp, ibmcloud, openstack, ovirt, vsphere</b> , or <b>{}</b>
<b>compute.replicas</b>	The number of compute machines, which are also known as worker machines, to provision.	A positive integer greater than or equal to <b>2</b> . The default value is <b>3</b> .
<b>controlPlane</b>	The configuration for the machines that comprise the control plane.	Array of <b>MachinePool</b> objects.

Parameter	Description	Values
<b>controlPlane.architecture</b>	Determines the instruction set architecture of the machines in the pool. Currently, clusters with varied architectures are not supported. All pools must specify the same architecture. Valid values are <b>amd64</b> (the default).	String
<b>controlPlane.hyperthreading</b>	<p>Whether to enable or disable simultaneous multithreading, or <b>hyperthreading</b>, on control plane machines. By default, simultaneous multithreading is enabled to increase the performance of your machines' cores.</p> <div style="display: flex; align-items: center;">  <div style="margin-left: 10px;"> <p><b>IMPORTANT</b></p> <p>If you disable simultaneous multithreading, ensure that your capacity planning accounts for the dramatically decreased machine performance.</p> </div> </div>	<b>Enabled</b> or <b>Disabled</b>
<b>controlPlane.name</b>	Required if you use <b>controlPlane</b> . The name of the machine pool.	<b>master</b>
<b>controlPlane.platform</b>	Required if you use <b>controlPlane</b> . Use this parameter to specify the cloud provider that hosts the control plane machines. This parameter value must match the <b>compute.platform</b> parameter value.	<b>alibabacloud, aws, azure, gcp, ibmcloud, openstack, ovirt, vsphere, or {}</b>
<b>controlPlane.replicas</b>	The number of control plane machines to provision.	The only supported value is <b>3</b> , which is the default value.

Parameter	Description	Values
<b>credentialsMode</b>	<p>The Cloud Credential Operator (CCO) mode. If no mode is specified, the CCO dynamically tries to determine the capabilities of the provided credentials, with a preference for mint mode on the platforms where multiple modes are supported.</p> <div data-bbox="485 517 595 864" style="border: 1px solid black; padding: 5px; margin-bottom: 10px;">  </div> <p><b>NOTE</b></p> <p>Not all CCO modes are supported for all cloud providers. For more information on CCO modes, see the <i>Cloud Credential Operator</i> entry in the <i>Cluster Operators reference content</i>.</p> <div data-bbox="485 913 595 1261" style="border: 1px solid black; padding: 5px;">  </div> <p><b>NOTE</b></p> <p>If your AWS account has service control policies (SCP) enabled, you must configure the <b>credentialsMode</b> parameter to <b>Mint</b>, <b>Passthrough</b> or <b>Manual</b>.</p>	<b>Mint</b> , <b>Passthrough</b> , <b>Manual</b> or an empty string ("").

Parameter	Description	Values
<b>fips</b>	<p>Enable or disable FIPS mode. The default is <b>false</b> (disabled). If FIPS mode is enabled, the Red Hat Enterprise Linux CoreOS (RHCOS) machines that OpenShift Container Platform runs on bypass the default Kubernetes cryptography suite and use the cryptography modules that are provided with RHCOS instead.</p> <div style="display: flex; align-items: flex-start;"> <div style="width: 20px; height: 100px; background: repeating-linear-gradient(45deg, transparent, transparent 2px, black 2px, black 4px); margin-right: 10px;"></div> <div> <p><b>IMPORTANT</b></p> <p>To enable FIPS mode for your cluster, you must run the installation program from a Red Hat Enterprise Linux (RHEL) computer configured to operate in FIPS mode. For more information about configuring FIPS mode on RHEL, see <a href="#">Installing the system in FIPS mode</a>. The use of FIPS validated or Modules In Process cryptographic libraries is only supported on OpenShift Container Platform deployments on the <b>x86_64</b> architecture.</p> </div> </div> <div style="display: flex; align-items: flex-start; margin-top: 10px;"> <div style="width: 20px; height: 50px; background: repeating-linear-gradient(45deg, transparent, transparent 2px, black 2px, black 4px); margin-right: 10px;"></div> <div> <p><b>NOTE</b></p> <p>If you are using Azure File storage, you cannot enable FIPS mode.</p> </div> </div>	<b>false</b> or <b>true</b>
<b>imageContentSources</b>	Sources and repositories for the release-image content.	Array of objects. Includes a <b>source</b> and, optionally, <b>mirrors</b> , as described in the following rows of this table.
<b>imageContentSources.source</b>	Required if you use <b>imageContentSources</b> . Specify the repository that users refer to, for example, in image pull specifications.	String
<b>imageContentSources.mirrors</b>	Specify one or more repositories that may also contain the same images.	Array of strings



Parameter	Description	Values
<b>publish</b>	How to publish or expose the user-facing endpoints of your cluster, such as the Kubernetes API, OpenShift routes.	<p><b>Internal</b> or <b>External</b>. The default value is <b>External</b>.</p> <p>Setting this field to <b>Internal</b> is not supported on non-cloud platforms and IBM Cloud VPC.</p> <div style="display: flex; align-items: flex-start;">  <div> <p><b>IMPORTANT</b></p> <p>If the value of the field is set to <b>Internal</b>, the cluster will become non-functional. For more information, refer to <a href="#">BZ#1953035</a>.</p> </div> </div>
<b>sshKey</b>	<p>The SSH key or keys to authenticate access your cluster machines.</p> <div style="display: flex; align-items: flex-start;">  <div> <p><b>NOTE</b></p> <p>For production OpenShift Container Platform clusters on which you want to perform installation debugging or disaster recovery, specify an SSH key that your <b>ssh-agent</b> process uses.</p> </div> </div>	<p>One or more keys. For example:</p> <pre>sshKey:   &lt;key1&gt;   &lt;key2&gt;   &lt;key3&gt;</pre>

#### 20.4.10.1.4. Additional VMware vSphere configuration parameters

Additional VMware vSphere configuration parameters are described in the following table:

Table 20.29. Additional VMware vSphere cluster parameters

Parameter	Description	Values
<b>platform.vsphere.vCenter</b>	The fully-qualified hostname or IP address of the vCenter server.	String
<b>platform.vsphere.username</b>	The user name to use to connect to the vCenter instance with. This user must have at least the roles and privileges that are required for <a href="#">static or dynamic persistent volume provisioning</a> in vSphere.	String

Parameter	Description	Values
<b>platform.vsphere.password</b>	The password for the vCenter user name.	String
<b>platform.vsphere.datacenter</b>	The name of the datacenter to use in the vCenter instance.	String
<b>platform.vsphere.defaultDatastore</b>	The name of the default datastore to use for provisioning volumes.	String
<b>platform.vsphere.folder</b>	Optional. The absolute path of an existing folder where the installation program creates the virtual machines. If you do not provide this value, the installation program creates a folder that is named with the infrastructure ID in the datacenter virtual machine folder.	String, for example, <b>/&lt;datacenter_name&gt;/vm/&lt;folder_name&gt;/&lt;subfolder_name&gt;</b> .
<b>platform.vsphere.resourcePool</b>	Optional. The absolute path of an existing resource pool where the installer creates the virtual machines. If you do not specify a value, resources are installed in the root of the cluster <b>/&lt;datacenter_name&gt;/host/&lt;cluster_name&gt;/Resources</b> .	String, for example, <b>/&lt;datacenter_name&gt;/host/&lt;cluster_name&gt;/Resources/&lt;resource_pool_name&gt;/&lt;optional_nested_resource_pool_name&gt;</b> .
<b>platform.vsphere.network</b>	The network in the vCenter instance that contains the virtual IP addresses and DNS records that you configured.	String
<b>platform.vsphere.cluster</b>	The vCenter cluster to install the OpenShift Container Platform cluster in.	String
<b>platform.vsphere.apiVIP</b>	The virtual IP (VIP) address that you configured for control plane API access.	An IP address, for example <b>128.0.0.1</b> .
<b>platform.vsphere.ingressVIP</b>	The virtual IP (VIP) address that you configured for cluster ingress.	An IP address, for example <b>128.0.0.1</b> .
<b>platform.vsphere.diskType</b>	Optional. The disk provisioning method. This value defaults to the vSphere default storage policy if not set.	Valid values are <b>thin</b> , <b>thick</b> , or <b>eagerZeroedThick</b> .

#### 20.4.10.1.5. Optional VMware vSphere machine pool configuration parameters

Optional VMware vSphere machine pool configuration parameters are described in the following table:

**Table 20.30. Optional VMware vSphere machine pool parameters**

Parameter	Description	Values
<b>platform.vsphere.clusterOSImage</b>	The location from which the installer downloads the RHCOS image. You must set this parameter to perform an installation in a restricted network.	An HTTP or HTTPS URL, optionally with a SHA-256 checksum. For example, <b>https://mirror.openshift.com/images/rhcos-&lt;version&gt;-vmware.&lt;architecture&gt;.ova.</b>
<b>platform.vsphere.osDisk.diskSizeGB</b>	The size of the disk in gigabytes.	Integer
<b>platform.vsphere.cpus</b>	The total number of virtual processor cores to assign a virtual machine. The value of <b>platform.vsphere.cpus</b> must be a multiple of <b>platform.vsphere.coresPerSocket</b> value.	Integer
<b>platform.vsphere.coresPerSocket</b>	The number of cores per socket in a virtual machine. The number of virtual sockets on the virtual machine is <b>platform.vsphere.cpus/platform.vsphere.coresPerSocket</b> . The default value for control plane nodes and worker nodes is <b>4</b> and <b>2</b> , respectively.	Integer
<b>platform.vsphere.memoryMB</b>	The size of a virtual machine's memory in megabytes.	Integer

#### 20.4.10.2. Sample install-config.yaml file for an installer-provisioned VMware vSphere cluster

You can customize the install-config.yaml file to specify more details about your OpenShift Container Platform cluster's platform or modify the values of the required parameters.

```

apiVersion: v1
baseDomain: example.com 1
compute: 2
- hypervthreading: Enabled 3
  name: worker
  replicas: 3
  platform:
    vsphere: 4
      cpus: 2
      coresPerSocket: 2
      memoryMB: 8192

```

```

    osDisk:
      diskSizeGB: 120
  controlPlane: 5
  hyperthreading: Enabled 6
  name: master
  replicas: 3
  platform:
    vsphere: 7
      cpus: 4
      coresPerSocket: 2
      memoryMB: 16384
      osDisk:
        diskSizeGB: 120
  metadata:
    name: cluster 8
  networking:
    clusterNetwork:
      - cidr: 10.128.0.0/14
      hostPrefix: 23
    machineNetwork:
      - cidr: 10.0.0.0/16
    networkType: OpenShiftSDN
    serviceNetwork:
      - 172.30.0.0/16
  platform:
    vsphere:
      vcenter: your.vcenter.server
      username: username
      password: password
      datacenter: datacenter
      defaultDatastore: datastore
      folder: folder
      resourcePool: resource_pool 9
      diskType: thin 10
      network: VM_Network
      cluster: vsphere_cluster_name 11
      apiVIP: api_vip
      ingressVIP: ingress_vip
  fips: false
  pullSecret: '{"auths": ...}'
  sshKey: 'ssh-ed25519 AAAA...'

```

- 1 The base domain of the cluster. All DNS records must be sub-domains of this base and include the cluster name.
- 2 5 The **controlPlane** section is a single mapping, but the **compute** section is a sequence of mappings. To meet the requirements of the different data structures, the first line of the **compute** section must begin with a hyphen, -, and the first line of the **controlPlane** section must not. Only one control plane pool is used.
- 3 6 Whether to enable or disable simultaneous multithreading, or **hyperthreading**. By default, simultaneous multithreading is enabled to increase the performance of your machines' cores. You can disable it by setting the parameter value to **Disabled**. If you disable simultaneous multithreading in some cluster machines, you must disable it in all cluster machines.



## IMPORTANT

If you disable simultaneous multithreading, ensure that your capacity planning accounts for the dramatically decreased machine performance. Your machines must use at least 8 CPUs and 32 GB of RAM if you disable simultaneous multithreading.

- 4 7 Optional: Provide additional configuration for the machine pool parameters for the compute and control plane machines.
- 8 The cluster name that you specified in your DNS records.
- 9 Optional: Provide an existing resource pool for machine creation. If you do not specify a value, the installation program uses the root resource pool of the vSphere cluster.
- 10 The vSphere disk provisioning method.
- 11 The vSphere cluster to install the OpenShift Container Platform cluster in.

### 20.4.10.3. Configuring the cluster-wide proxy during installation

Production environments can deny direct access to the internet and instead have an HTTP or HTTPS proxy available. You can configure a new OpenShift Container Platform cluster to use a proxy by configuring the proxy settings in the **install-config.yaml** file.

#### Prerequisites

- You have an existing **install-config.yaml** file.
- You reviewed the sites that your cluster requires access to and determined whether any of them need to bypass the proxy. By default, all cluster egress traffic is proxied, including calls to hosting cloud provider APIs. You added sites to the **Proxy** object's **spec.noProxy** field to bypass the proxy if necessary.



## NOTE

The **Proxy** object **status.noProxy** field is populated with the values of the **networking.machineNetwork[].cidr**, **networking.clusterNetwork[].cidr**, and **networking.serviceNetwork[]** fields from your installation configuration.

For installations on Amazon Web Services (AWS), Google Cloud Platform (GCP), Microsoft Azure, and Red Hat OpenStack Platform (RHOSP), the **Proxy** object **status.noProxy** field is also populated with the instance metadata endpoint (**169.254.169.254**).

#### Procedure

1. Edit your **install-config.yaml** file and add the proxy settings. For example:

```
apiVersion: v1
baseDomain: my.domain.com
proxy:
  httpProxy: http://<username>:<pswd>@<ip>:<port> 1
  httpsProxy: https://<username>:<pswd>@<ip>:<port> 2
  noProxy: example.com 3
```

```

additionalTrustBundle: | 4
-----BEGIN CERTIFICATE-----
<MY_TRUSTED_CA_CERT>
-----END CERTIFICATE-----
...

```

- 1 A proxy URL to use for creating HTTP connections outside the cluster. The URL scheme must be **http**.
- 2 A proxy URL to use for creating HTTPS connections outside the cluster.
- 3 A comma-separated list of destination domain names, IP addresses, or other network CIDRs to exclude from proxying. Preface a domain with **.** to match subdomains only. For example, **.y.com** matches **x.y.com**, but not **y.com**. Use **\*** to bypass the proxy for all destinations. You must include vCenter's IP address and the IP range that you use for its machines.
- 4 If provided, the installation program generates a config map that is named **user-ca-bundle** in the **openshift-config** namespace that contains one or more additional CA certificates that are required for proxying HTTPS connections. The Cluster Network Operator then creates a **trusted-ca-bundle** config map that merges these contents with the Red Hat Enterprise Linux CoreOS (RHCOS) trust bundle, and this config map is referenced in the **trustedCA** field of the **Proxy** object. The **additionalTrustBundle** field is required unless the proxy's identity certificate is signed by an authority from the RHCOS trust bundle.

**NOTE**

The installation program does not support the proxy **readinessEndpoints** field.

**NOTE**

If the installer times out, restart and then complete the deployment by using the **wait-for** command of the installer. For example:

```
$ ./openshift-install wait-for install-complete --log-level debug
```

2. Save the file and reference it when installing OpenShift Container Platform.

The installation program creates a cluster-wide proxy that is named **cluster** that uses the proxy settings in the provided **install-config.yaml** file. If no proxy settings are provided, a **cluster Proxy** object is still created, but it will have a nil **spec**.

**NOTE**

Only the **Proxy** object named **cluster** is supported, and no additional proxies can be created.

### 20.4.11. Network configuration phases

There are two phases prior to OpenShift Container Platform installation where you can customize the network configuration.

#### Phase 1

You can customize the following network-related fields in the **install-config.yaml** file before you create the manifest files:

- **networking.networkType**
- **networking.clusterNetwork**
- **networking.serviceNetwork**
- **networking.machineNetwork**

For more information on these fields, refer to *Installation configuration parameters*.



#### NOTE

Set the **networking.machineNetwork** to match the CIDR that the preferred NIC resides in.



#### IMPORTANT

The CIDR range **172.17.0.0/16** is reserved by libVirt. You cannot use this range or any range that overlaps with this range for any networks in your cluster.

### Phase 2

After creating the manifest files by running **openshift-install create manifests**, you can define a customized Cluster Network Operator manifest with only the fields you want to modify. You can use the manifest to specify advanced network configuration.

You cannot override the values specified in phase 1 in the **install-config.yaml** file during phase 2. However, you can further customize the cluster network provider during phase 2.

### 20.4.12. Specifying advanced network configuration

You can use advanced network configuration for your cluster network provider to integrate your cluster into your existing network environment. You can specify advanced network configuration only before you install the cluster.



#### IMPORTANT

Customizing your network configuration by modifying the OpenShift Container Platform manifest files created by the installation program is not supported. Applying a manifest file that you create, as in the following procedure, is supported.

#### Prerequisites

- You have created the **install-config.yaml** file and completed any modifications to it.

#### Procedure

1. Change to the directory that contains the installation program and create the manifests:

```
$ ./openshift-install create manifests --dir <installation_directory> 1
```

- 1 **<installation\_directory>** specifies the name of the directory that contains the **install-config.yaml** file for your cluster.
2. Create a stub manifest file for the advanced network configuration that is named **cluster-network-03-config.yml** in the **<installation\_directory>/manifests/** directory:

```
apiVersion: operator.openshift.io/v1
kind: Network
metadata:
  name: cluster
spec:
```

3. Specify the advanced network configuration for your cluster in the **cluster-network-03-config.yml** file, such as in the following examples:

#### Specify a different VXLAN port for the OpenShift SDN network provider

```
apiVersion: operator.openshift.io/v1
kind: Network
metadata:
  name: cluster
spec:
  defaultNetwork:
    openshiftSDNConfig:
      vxlanPort: 4800
```

#### Enable IPsec for the OVN-Kubernetes network provider

```
apiVersion: operator.openshift.io/v1
kind: Network
metadata:
  name: cluster
spec:
  defaultNetwork:
    ovnKubernetesConfig:
      ipsecConfig: {}
```

4. Optional: Back up the **manifests/cluster-network-03-config.yml** file. The installation program consumes the **manifests/** directory when you create the Ignition config files.

### 20.4.13. Cluster Network Operator configuration

The configuration for the cluster network is specified as part of the Cluster Network Operator (CNO) configuration and stored in a custom resource (CR) object that is named **cluster**. The CR specifies the fields for the **Network** API in the **operator.openshift.io** API group.

The CNO configuration inherits the following fields during cluster installation from the **Network** API in the **Network.config.openshift.io** API group and these fields cannot be changed:

#### **clusterNetwork**

IP address pools from which pod IP addresses are allocated.

#### **serviceNetwork**



IP address pool for services.

### **defaultNetwork.type**

Cluster network provider, such as OpenShift SDN or OVN-Kubernetes.

You can specify the cluster network provider configuration for your cluster by setting the fields for the **defaultNetwork** object in the CNO object named **cluster**.

#### 20.4.13.1. Cluster Network Operator configuration object

The fields for the Cluster Network Operator (CNO) are described in the following table:

**Table 20.31. Cluster Network Operator configuration object**

Field	Type	Description
<b>metadata.name</b>	<b>string</b>	The name of the CNO object. This name is always <b>cluster</b> .
<b>spec.clusterNetwork</b>	<b>array</b>	<p>A list specifying the blocks of IP addresses from which pod IP addresses are allocated and the subnet prefix length assigned to each individual node in the cluster. For example:</p> <pre>spec:   clusterNetwork:   - cidr: 10.128.0.0/19     hostPrefix: 23   - cidr: 10.128.32.0/19     hostPrefix: 23</pre> <p>You can customize this field only in the <b>install-config.yaml</b> file before you create the manifests. The value is read-only in the manifest file.</p>
<b>spec.serviceNetwork</b>	<b>array</b>	<p>A block of IP addresses for services. The OpenShift SDN and OVN-Kubernetes Container Network Interface (CNI) network providers support only a single IP address block for the service network. For example:</p> <pre>spec:   serviceNetwork:   - 172.30.0.0/14</pre> <p>You can customize this field only in the <b>install-config.yaml</b> file before you create the manifests. The value is read-only in the manifest file.</p>
<b>spec.defaultNetwork</b>	<b>object</b>	Configures the Container Network Interface (CNI) cluster network provider for the cluster network.
<b>spec.kubeProxyConfig</b>	<b>object</b>	The fields for this object specify the kube-proxy configuration. If you are using the OVN-Kubernetes cluster network provider, the kube-proxy configuration has no effect.

**defaultNetwork object configuration**

The values for the **defaultNetwork** object are defined in the following table:

**Table 20.32. defaultNetwork object**

Field	Type	Description
<b>type</b>	<b>string</b>	<p>Either <b>OpenShiftSDN</b> or <b>OVNKubernetes</b>. The cluster network provider is selected during installation. This value cannot be changed after cluster installation.</p> <div style="display: flex; align-items: flex-start;"> <div style="flex: 1;">  </div> <div style="flex: 2;"> <p><b>NOTE</b></p> <p>OpenShift Container Platform uses the OpenShift SDN Container Network Interface (CNI) cluster network provider by default.</p> </div> </div>
<b>openshiftSDNConfig</b>	<b>object</b>	This object is only valid for the OpenShift SDN cluster network provider.
<b>ovnKubernetesConfig</b>	<b>object</b>	This object is only valid for the OVN-Kubernetes cluster network provider.

**Configuration for the OpenShift SDN CNI cluster network provider**

The following table describes the configuration fields for the OpenShift SDN Container Network Interface (CNI) cluster network provider.

**Table 20.33. openshiftSDNConfig object**

Field	Type	Description
<b>mode</b>	<b>string</b>	<p>Configures the network isolation mode for OpenShift SDN. The default value is <b>NetworkPolicy</b>.</p> <p>The values <b>Multitenant</b> and <b>Subnet</b> are available for backwards compatibility with OpenShift Container Platform 3.x but are not recommended. This value cannot be changed after cluster installation.</p>

Field	Type	Description
<b>mtu</b>	<b>integer</b>	<p>The maximum transmission unit (MTU) for the VXLAN overlay network. This is detected automatically based on the MTU of the primary network interface. You do not normally need to override the detected MTU.</p> <p>If the auto-detected value is not what you expect it to be, confirm that the MTU on the primary network interface on your nodes is correct. You cannot use this option to change the MTU value of the primary network interface on the nodes.</p> <p>If your cluster requires different MTU values for different nodes, you must set this value to <b>50</b> less than the lowest MTU value in your cluster. For example, if some nodes in your cluster have an MTU of <b>9001</b>, and some have an MTU of <b>1500</b>, you must set this value to <b>1450</b>.</p> <p>This value cannot be changed after cluster installation.</p>
<b>vxlanPort</b>	<b>integer</b>	<p>The port to use for all VXLAN packets. The default value is <b>4789</b>. This value cannot be changed after cluster installation.</p> <p>If you are running in a virtualized environment with existing nodes that are part of another VXLAN network, then you might be required to change this. For example, when running an OpenShift SDN overlay on top of VMware NSX-T, you must select an alternate port for the VXLAN, because both SDNs use the same default VXLAN port number.</p> <p>On Amazon Web Services (AWS), you can select an alternate port for the VXLAN between port <b>9000</b> and port <b>9999</b>.</p>

### Example OpenShift SDN configuration

```
defaultNetwork:
  type: OpenShiftSDN
openshiftSDNConfig:
  mode: NetworkPolicy
  mtu: 1450
  vxlanPort: 4789
```

### Configuration for the OVN-Kubernetes CNI cluster network provider

The following table describes the configuration fields for the OVN-Kubernetes CNI cluster network provider.

Table 20.34. `ovnKubernetesConfig` object

Field	Type	Description
-------	------	-------------

Field	Type	Description
<b>mtu</b>	<b>integer</b>	<p>The maximum transmission unit (MTU) for the Geneve (Generic Network Virtualization Encapsulation) overlay network. This is detected automatically based on the MTU of the primary network interface. You do not normally need to override the detected MTU.</p> <p>If the auto-detected value is not what you expect it to be, confirm that the MTU on the primary network interface on your nodes is correct. You cannot use this option to change the MTU value of the primary network interface on the nodes.</p> <p>If your cluster requires different MTU values for different nodes, you must set this value to <b>100</b> less than the lowest MTU value in your cluster. For example, if some nodes in your cluster have an MTU of <b>9001</b>, and some have an MTU of <b>1500</b>, you must set this value to <b>1400</b>.</p>
<b>genevePort</b>	<b>integer</b>	The port to use for all Geneve packets. The default value is <b>6081</b> . This value cannot be changed after cluster installation.
<b>ipsecConfig</b>	<b>object</b>	Specify an empty object to enable IPsec encryption. This value cannot be changed after cluster installation.
<b>policyAuditConfig</b>	<b>object</b>	Specify a configuration object for customizing network policy audit logging. If unset, the defaults audit log settings are used.
<b>gatewayConfig</b>	<b>object</b>	<p>Optional: Specify a configuration object for customizing how egress traffic is sent to the node gateway.</p> <div style="display: flex; align-items: flex-start;"> <div style="flex: 1;">  </div> <div style="flex: 2;"> <p><b>NOTE</b></p> <p>While migrating egress traffic, you can expect some disruption to workloads and service traffic until the Cluster Network Operator (CNO) successfully rolls out the changes.</p> </div> </div>

Table 20.35. **policyAuditConfig** object

Field	Type	Description
<b>rateLimit</b>	integer	The maximum number of messages to generate every second per node. The default value is <b>20</b> messages per second.
<b>maxFileSize</b>	integer	The maximum size for the audit log in bytes. The default value is <b>50000000</b> or 50 MB.

Field	Type	Description
<b>destination</b>	string	<p>One of the following additional audit log targets:</p> <p><b>libc</b> The libc <b>syslog()</b> function of the journald process on the host.</p> <p><b>udp:&lt;host&gt;:&lt;port&gt;</b> A syslog server. Replace <b>&lt;host&gt;:&lt;port&gt;</b> with the host and port of the syslog server.</p> <p><b>unix:&lt;file&gt;</b> A Unix Domain Socket file specified by <b>&lt;file&gt;</b>.</p> <p><b>null</b> Do not send the audit logs to any additional target.</p>
<b>syslogFacility</b>	string	The syslog facility, such as <b>kern</b> , as defined by RFC5424. The default value is <b>local0</b> .

Table 20.36. gatewayConfig object

Field	Type	Description
<b>routingViaHost</b>	<b>boolean</b>	<p>Set this field to <b>true</b> to send egress traffic from pods to the host networking stack. For highly-specialized installations and applications that rely on manually configured routes in the kernel routing table, you might want to route egress traffic to the host networking stack. By default, egress traffic is processed in OVN to exit the cluster and is not affected by specialized routes in the kernel routing table. The default value is <b>false</b>.</p> <p>This field has an interaction with the Open vSwitch hardware offloading feature. If you set this field to <b>true</b>, you do not receive the performance benefits of the offloading because egress traffic is processed by the host networking stack.</p>

### Example OVN-Kubernetes configuration with IPsec enabled

```

defaultNetwork:
  type: OVNKubernetes
  ovnKubernetesConfig:
    mtu: 1400
    genevePort: 6081
    ipsecConfig: {}

```

### kubeProxyConfig object configuration

The values for the **kubeProxyConfig** object are defined in the following table:

Table 20.37. kubeProxyConfig object

Field	Type	Description
<b>iptablesSyncPeriod</b>	<b>string</b>	<p>The refresh period for <b>iptables</b> rules. The default value is <b>30s</b>. Valid suffixes include <b>s</b>, <b>m</b>, and <b>h</b> and are described in the <a href="#">Go time package</a> documentation.</p> <div style="display: flex; align-items: flex-start;">  <div> <p><b>NOTE</b></p> <p>Because of performance improvements introduced in OpenShift Container Platform 4.3 and greater, adjusting the <b>iptablesSyncPeriod</b> parameter is no longer necessary.</p> </div> </div>
<b>proxyArguments.iptables-min-sync-period</b>	<b>array</b>	<p>The minimum duration before refreshing <b>iptables</b> rules. This field ensures that the refresh does not happen too frequently. Valid suffixes include <b>s</b>, <b>m</b>, and <b>h</b> and are described in the <a href="#">Go time package</a>. The default value is:</p> <pre>kubeProxyConfig:   proxyArguments:     iptables-min-sync-period:       - 0s</pre>

## 20.4.14. Deploying the cluster

You can install OpenShift Container Platform on a compatible cloud platform.



### IMPORTANT

You can run the **create cluster** command of the installation program only once, during initial installation.

### Prerequisites

- Obtain the OpenShift Container Platform installation program and the pull secret for your cluster.

### Procedure

1. Change to the directory that contains the installation program and initialize the cluster deployment:

```
$ ./openshift-install create cluster --dir <installation_directory> \ 1
--log-level=info 2
```

- 1** For **<installation\_directory>**, specify the location of your customized **./install-config.yaml** file.

- 2 To view different installation details, specify **warn**, **debug**, or **error** instead of **info**.

When the cluster deployment completes, directions for accessing your cluster, including a link to its web console and credentials for the **kubeadmin** user, display in your terminal.

```
...
INFO Install complete!
INFO To access the cluster as the system:admin user when using 'oc', run 'export
KUBECONFIG=/home/myuser/install_dir/auth/kubeconfig'
INFO Access the OpenShift web-console here: https://console-openshift-
console.apps.mycluster.example.com
INFO Login to the console with user: "kubeadmin", and password: "4vYBz-Ee6gm-ymBZj-Wt5AL"
INFO Time elapsed: 36m22s
```

+



## NOTE

The cluster access and credential information also outputs to **<installation\_directory>/openshift\_install.log** when an installation succeeds.

+

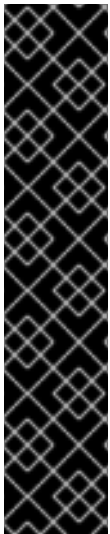

## IMPORTANT

- The Ignition config files that the installation program generates contain certificates that expire after 24 hours, which are then renewed at that time. If the cluster is shut down before renewing the certificates and the cluster is later restarted after the 24 hours have elapsed, the cluster automatically recovers the expired certificates. The exception is that you must manually approve the pending **node-bootstrapper** certificate signing requests (CSRs) to recover kubelet certificates. See the documentation for *Recovering from expired control plane certificates* for more information.
- It is recommended that you use Ignition config files within 12 hours after they are generated because the 24-hour certificate rotates from 16 to 22 hours after the cluster is installed. By using the Ignition config files within 12 hours, you can avoid installation failure if the certificate update runs during installation.

+

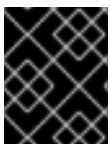

## IMPORTANT

You must not delete the installation program or the files that the installation program creates. Both are required to delete the cluster.

### 20.4.15. Installing the OpenShift CLI by downloading the binary

You can install the OpenShift CLI (**oc**) to interact with OpenShift Container Platform from a command-line interface. You can install **oc** on Linux, Windows, or macOS.

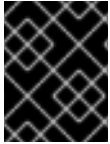

## IMPORTANT

If you installed an earlier version of **oc**, you cannot use it to complete all of the commands in OpenShift Container Platform 4.10. Download and install the new version of **oc**.

### Installing the OpenShift CLI on Linux

You can install the OpenShift CLI (**oc**) binary on Linux by using the following procedure.

#### Procedure

1. Navigate to the [OpenShift Container Platform downloads page](#) on the Red Hat Customer Portal.
2. Select the appropriate version in the **Version** drop-down menu.
3. Click **Download Now** next to the **OpenShift v4.10 Linux Client** entry and save the file.
4. Unpack the archive:

```
$ tar xvf <file>
```

5. Place the **oc** binary in a directory that is on your **PATH**.  
To check your **PATH**, execute the following command:

```
$ echo $PATH
```

After you install the OpenShift CLI, it is available using the **oc** command:

```
$ oc <command>
```

### Installing the OpenShift CLI on Windows

You can install the OpenShift CLI (**oc**) binary on Windows by using the following procedure.

#### Procedure

1. Navigate to the [OpenShift Container Platform downloads page](#) on the Red Hat Customer Portal.
2. Select the appropriate version in the **Version** drop-down menu.
3. Click **Download Now** next to the **OpenShift v4.10 Windows Client** entry and save the file.
4. Unzip the archive with a ZIP program.
5. Move the **oc** binary to a directory that is on your **PATH**.  
To check your **PATH**, open the command prompt and execute the following command:

```
C:\> path
```

After you install the OpenShift CLI, it is available using the **oc** command:

```
C:\> oc <command>
```



## Installing the OpenShift CLI on macOS

You can install the OpenShift CLI (**oc**) binary on macOS by using the following procedure.

### Procedure

1. Navigate to the [OpenShift Container Platform downloads page](#) on the Red Hat Customer Portal.
2. Select the appropriate version in the **Version** drop-down menu.
3. Click **Download Now** next to the **OpenShift v4.10 MacOSX Client** entry and save the file.
4. Unpack and unzip the archive.
5. Move the **oc** binary to a directory on your **PATH**.  
To check your **PATH**, open a terminal and execute the following command:

```
$ echo $PATH
```

After you install the OpenShift CLI, it is available using the **oc** command:

```
$ oc <command>
```

### 20.4.16. Logging in to the cluster by using the CLI

You can log in to your cluster as a default system user by exporting the cluster **kubeconfig** file. The **kubeconfig** file contains information about the cluster that is used by the CLI to connect a client to the correct cluster and API server. The file is specific to a cluster and is created during OpenShift Container Platform installation.

#### Prerequisites

- You deployed an OpenShift Container Platform cluster.
- You installed the **oc** CLI.

#### Procedure

1. Export the **kubeadmin** credentials:

```
$ export KUBECONFIG=<installation_directory>/auth/kubeconfig 1
```

- 1** For **<installation\_directory>**, specify the path to the directory that you stored the installation files in.

2. Verify you can run **oc** commands successfully using the exported configuration:

```
$ oc whoami
```

#### Example output

```
system:admin
```

## 20.4.17. Creating registry storage

After you install the cluster, you must create storage for the registry Operator.

### 20.4.17.1. Image registry removed during installation

On platforms that do not provide shareable object storage, the OpenShift Image Registry Operator bootstraps itself as **Removed**. This allows **openshift-installer** to complete installations on these platform types.

After installation, you must edit the Image Registry Operator configuration to switch the **managementState** from **Removed** to **Managed**.

### 20.4.17.2. Image registry storage configuration

The Image Registry Operator is not initially available for platforms that do not provide default storage. After installation, you must configure your registry to use storage so that the Registry Operator is made available.

Instructions are shown for configuring a persistent volume, which is required for production clusters. Where applicable, instructions are shown for configuring an empty directory as the storage location, which is available for only non-production clusters.

Additional instructions are provided for allowing the image registry to use block storage types by using the **Recreate** rollout strategy during upgrades.

#### 20.4.17.2.1. Configuring registry storage for VMware vSphere

As a cluster administrator, following installation you must configure your registry to use storage.

#### Prerequisites

- Cluster administrator permissions.
- A cluster on VMware vSphere.
- Persistent storage provisioned for your cluster, such as Red Hat OpenShift Data Foundation.



#### IMPORTANT

OpenShift Container Platform supports **ReadWriteOnce** access for image registry storage when you have only one replica. **ReadWriteOnce** access also requires that the registry uses the **Recreate** rollout strategy. To deploy an image registry that supports high availability with two or more replicas, **ReadWriteMany** access is required.

- Must have "100Gi" capacity.



## IMPORTANT

Testing shows issues with using the NFS server on RHEL as storage backend for core services. This includes the OpenShift Container Registry and Quay, Prometheus for monitoring storage, and Elasticsearch for logging storage. Therefore, using RHEL NFS to back PVs used by core services is not recommended.

Other NFS implementations on the marketplace might not have these issues. Contact the individual NFS implementation vendor for more information on any testing that was possibly completed against these OpenShift Container Platform core components.

## Procedure

1. To configure your registry to use storage, change the **spec.storage.pvc** in the **configs.imageregistry/cluster** resource.



## NOTE

When using shared storage, review your security settings to prevent outside access.

2. Verify that you do not have a registry pod:

```
$ oc get pod -n openshift-image-registry -l docker-registry=default
```

## Example output

```
No resources found in openshift-image-registry namespace
```



## NOTE

If you do have a registry pod in your output, you do not need to continue with this procedure.

3. Check the registry configuration:

```
$ oc edit configs.imageregistry.operator.openshift.io
```

## Example output

```
storage:
  pvc:
    claim: 1
```

- 1 Leave the **claim** field blank to allow the automatic creation of an **image-registry-storage** persistent volume claim (PVC). The PVC is generated based on the default storage class. However, be aware that the default storage class might provide ReadWriteOnce (RWO) volumes, such as a RADOS Block Device (RBD), which can cause issues when replicating to more than one replica.

4. Check the **clusteroperator** status:

-

```
$ oc get clusteroperator image-registry
```

### Example output

NAME	VERSION	AVAILABLE	PROGRESSING	DEGRADED
image-registry	4.7	True	False	6h50m

#### 20.4.17.2.2. Configuring block registry storage for VMware vSphere

To allow the image registry to use block storage types such as vSphere Virtual Machine Disk (VMDK) during upgrades as a cluster administrator, you can use the **Recreate** rollout strategy.

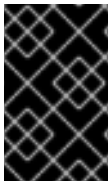

### IMPORTANT

Block storage volumes are supported but not recommended for use with image registry on production clusters. An installation where the registry is configured on block storage is not highly available because the registry cannot have more than one replica.

### Procedure

- To set the image registry storage as a block storage type, patch the registry so that it uses the **Recreate** rollout strategy and runs with only **1** replica:

```
$ oc patch config.imageregistry.operator.openshift.io/cluster --type=merge -p '{"spec": {"rolloutStrategy": "Recreate", "replicas": 1}}'
```

- Provision the PV for the block storage device, and create a PVC for that volume. The requested block volume uses the ReadWriteOnce (RWO) access mode.
  - Create a **pvc.yaml** file with the following contents to define a VMware vSphere **PersistentVolumeClaim** object:

```
kind: PersistentVolumeClaim
apiVersion: v1
metadata:
  name: image-registry-storage 1
  namespace: openshift-image-registry 2
spec:
  accessModes:
  - ReadWriteOnce 3
  resources:
    requests:
      storage: 100Gi 4
```

- A unique name that represents the **PersistentVolumeClaim** object.
- The namespace for the **PersistentVolumeClaim** object, which is **openshift-image-registry**.
- The access mode of the persistent volume claim. With **ReadWriteOnce**, the volume can be mounted with read and write permissions by a single node.

4 The size of the persistent volume claim.

b. Create the **PersistentVolumeClaim** object from the file:

```
$ oc create -f pvc.yaml -n openshift-image-registry
```

3. Edit the registry configuration so that it references the correct PVC:

```
$ oc edit config.imageregistry.operator.openshift.io -o yaml
```

### Example output

```
storage:
  pvc:
    claim: 1
```

1 Creating a custom PVC allows you to leave the **claim** field blank for the default automatic creation of an **image-registry-storage** PVC.

For instructions about configuring registry storage so that it references the correct PVC, see [Configuring the registry for vSphere](#).

## 20.4.18. Backing up VMware vSphere volumes

OpenShift Container Platform provisions new volumes as independent persistent disks to freely attach and detach the volume on any node in the cluster. As a consequence, it is not possible to back up volumes that use snapshots, or to restore volumes from snapshots. See [Snapshot Limitations](#) for more information.

### Procedure

To create a backup of persistent volumes:

1. Stop the application that is using the persistent volume.
2. Clone the persistent volume.
3. Restart the application.
4. Create a backup of the cloned volume.
5. Delete the cloned volume.

## 20.4.19. Telemetry access for OpenShift Container Platform

In OpenShift Container Platform 4.10, the Telemetry service, which runs by default to provide metrics about cluster health and the success of updates, requires internet access. If your cluster is connected to the internet, Telemetry runs automatically, and your cluster is registered to [OpenShift Cluster Manager](#).

After you confirm that your [OpenShift Cluster Manager](#) inventory is correct, either maintained automatically by Telemetry or manually by using OpenShift Cluster Manager, [use subscription watch](#) to track your OpenShift Container Platform subscriptions at the account or multi-cluster level.

## Additional resources

- See [About remote health monitoring](#) for more information about the Telemetry service

## 20.4.20. Next steps

- [Customize your cluster.](#)
- If necessary, you can [opt out of remote health reporting](#) .
- [Set up your registry and configure registry storage](#) .
- Optional: [View the events from the vSphere Problem Detector Operator](#) to determine if the cluster has permission or storage configuration issues.

## 20.5. INSTALLING A CLUSTER ON VSPHERE WITH USER-PROVISIONED INFRASTRUCTURE

In OpenShift Container Platform version 4.10, you can install a cluster on VMware vSphere infrastructure that you provision.

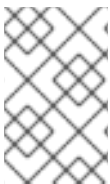

### NOTE

OpenShift Container Platform supports deploying a cluster to a single VMware vCenter only. Deploying a cluster with machines/machine sets on multiple vCenters is not supported.



### IMPORTANT

The steps for performing a user-provisioned infrastructure installation are provided as an example only. Installing a cluster with infrastructure you provide requires knowledge of the vSphere platform and the installation process of OpenShift Container Platform. Use the user-provisioned infrastructure installation instructions as a guide; you are free to create the required resources through other methods.

### 20.5.1. Prerequisites

- You reviewed details about the [OpenShift Container Platform installation and update](#) processes.
- You read the documentation on [selecting a cluster installation method and preparing it for users](#).
- You provisioned [persistent storage](#) for your cluster. To deploy a private image registry, your storage must provide **ReadWriteMany** access modes.
- Completing the installation requires that you upload the Red Hat Enterprise Linux CoreOS (RHCOS) OVA on vSphere hosts. The machine from which you complete this process requires access to port 443 on the vCenter and ESXi hosts. You verified that port 443 is accessible.
- If you use a firewall, you confirmed with the administrator that port 443 is accessible. Control plane nodes must be able to reach vCenter and ESXi hosts on port 443 for the installation to succeed.
- If you use a firewall, you [configured it to allow the sites](#) that your cluster requires access to.

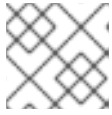
**NOTE**

Be sure to also review this site list if you are configuring a proxy.

**20.5.2. Internet access for OpenShift Container Platform**

In OpenShift Container Platform 4.10, you require access to the internet to install your cluster.

You must have internet access to:

- Access [OpenShift Cluster Manager](#) to download the installation program and perform subscription management. If the cluster has internet access and you do not disable Telemetry, that service automatically entitles your cluster.
- Access [Quay.io](#) to obtain the packages that are required to install your cluster.
- Obtain the packages that are required to perform cluster updates.

**IMPORTANT**

If your cluster cannot have direct internet access, you can perform a restricted network installation on some types of infrastructure that you provision. During that process, you download the required content and use it to populate a mirror registry with the installation packages. With some installation types, the environment that you install your cluster in will not require internet access. Before you update the cluster, you update the content of the mirror registry.

**20.5.3. VMware vSphere infrastructure requirements**

You must install the OpenShift Container Platform cluster on a VMware vSphere version 7 instance that meets the requirements for the components that you use.

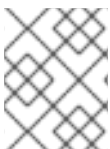
**NOTE**

OpenShift Container Platform version 4.10 does not support VMware vSphere version 8.0.

You can host the VMware vSphere infrastructure on-premise or on a [VMware Cloud Verified provider](#) that meets the requirements outlined in the following table:

**Table 20.38. Version requirements for vSphere virtual environments**

Virtual environment product	Required version
VM hardware version	15 or later
vSphere ESXi hosts	7
vCenter host	7

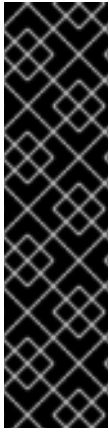

## IMPORTANT

Installing a cluster on VMware vSphere version 7.0 Update 1 is now deprecated. These versions are still fully supported, but version 4.10 of OpenShift Container Platform requires vSphere virtual hardware version 15 or later. Hardware version 15 is now the default for vSphere virtual machines in OpenShift Container Platform. To update the hardware version for your vSphere nodes, see the "Updating hardware on nodes running in vSphere" article.

If your vSphere nodes are below hardware version 15 or your VMware vSphere version is earlier than 6.7U3, upgrading from OpenShift Container Platform 4.10 to OpenShift Container Platform 4.11 is not available.

**Table 20.39. Minimum supported vSphere version for VMware components**

Component	Minimum supported versions	Description
Hypervisor	vSphere 7 with HW version 15	This version is the minimum version that Red Hat Enterprise Linux CoreOS (RHCOS) supports. For more information about supported hardware on the latest version of Red Hat Enterprise Linux (RHEL) that is compatible with RHCOS, see <a href="#">Hardware</a> on the Red Hat Customer Portal.
Storage with in-tree drivers	vSphere 7	This plugin creates vSphere storage by using the in-tree storage drivers for vSphere included in OpenShift Container Platform.
Optional: Networking (NSX-T)	vSphere 7	vSphere 7 is required for OpenShift Container Platform. For more information about the compatibility of NSX and OpenShift Container Platform, see the Release Notes section of VMware's <a href="#">NSX container plugin documentation</a> .

If you use a vSphere version 6.5 instance, upgrade to 7.0 before you install OpenShift Container Platform.

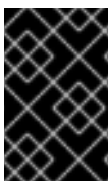

## IMPORTANT

You must ensure that the time on your ESXi hosts is synchronized before you install OpenShift Container Platform. See [Edit Time Configuration for a Host](#) in the VMware documentation.

### 20.5.4. VMware vSphere CSI Driver Operator requirements



To install the vSphere CSI Driver Operator, the following requirements must be met:

- VMware vSphere version 6.7U3 or later
- Virtual machines of hardware version 15 or later
- No third-party vSphere CSI driver already installed in the cluster

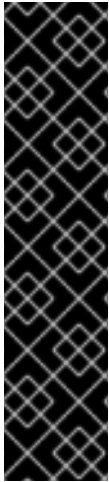

### IMPORTANT

If a third-party vSphere CSI driver is present in the cluster, OpenShift Container Platform does not overwrite it. If you continue with the third-party vSphere CSI driver when upgrading to the next major version of OpenShift Container Platform, the **oc** CLI prompts you with the following message:

```
VSphereCSIDriverOperatorCRUpgradeable: VMwareVSphereControllerUpgradeable:
found existing unsupported csi.vsphere.vmware.com driver
```

The previous message informs you that Red Hat does not support the third-party vSphere CSI driver during an OpenShift Container Platform upgrade operation. You can choose to ignore this message and continue with the upgrade operation.

### Additional resources

- To remove a third-party vSphere CSI driver, see [Removing a third-party vSphere CSI Driver](#) .
- To update the hardware version for your vSphere nodes, see [Updating hardware on nodes running in vSphere](#).

## 20.5.5. Requirements for a cluster with user-provisioned infrastructure

For a cluster that contains user-provisioned infrastructure, you must deploy all of the required machines.

This section describes the requirements for deploying OpenShift Container Platform on user-provisioned infrastructure.

### 20.5.5.1. Required machines for cluster installation

The smallest OpenShift Container Platform clusters require the following hosts:

**Table 20.40. Minimum required hosts**

Hosts	Description
One temporary bootstrap machine	The cluster requires the bootstrap machine to deploy the OpenShift Container Platform cluster on the three control plane machines. You can remove the bootstrap machine after you install the cluster.
Three control plane machines	The control plane machines run the Kubernetes and OpenShift Container Platform services that form the control plane.

Hosts	Description
At least two compute machines, which are also known as worker machines.	The workloads requested by OpenShift Container Platform users run on the compute machines.



### IMPORTANT

To maintain high availability of your cluster, use separate physical hosts for these cluster machines.

The bootstrap and control plane machines must use Red Hat Enterprise Linux CoreOS (RHCOS) as the operating system. However, the compute machines can choose between Red Hat Enterprise Linux CoreOS (RHCOS), Red Hat Enterprise Linux (RHEL) 8.4, or RHEL 8.5.

Note that RHCOS is based on Red Hat Enterprise Linux (RHEL) 8 and inherits all of its hardware certifications and requirements. See [Red Hat Enterprise Linux technology capabilities and limits](#).

#### 20.5.5.2. Minimum resource requirements for cluster installation

Each cluster machine must meet the following minimum requirements:

**Table 20.41. Minimum resource requirements**

Machine	Operating System	vCPU [1]	Virtual RAM	Storage	IOPS [2]
Bootstrap	RHCOS	4	16 GB	100 GB	300
Control plane	RHCOS	4	16 GB	100 GB	300
Compute	RHCOS, RHEL 8.4, or RHEL 8.5 [3]	2	8 GB	100 GB	300

1. One vCPU is equivalent to one physical core when simultaneous multithreading (SMT), or hyperthreading, is not enabled. When enabled, use the following formula to calculate the corresponding ratio: (threads per core × cores) × sockets = vCPUs.
2. OpenShift Container Platform and Kubernetes are sensitive to disk performance, and faster storage is recommended, particularly for etcd on the control plane nodes which require a 10 ms p99 fsync duration. Note that on many cloud platforms, storage size and IOPS scale together, so you might need to over-allocate storage volume to obtain sufficient performance.
3. As with all user-provisioned installations, if you choose to use RHEL compute machines in your cluster, you take responsibility for all operating system life cycle management and maintenance, including performing system updates, applying patches, and completing all other required tasks. Use of RHEL 7 compute machines is deprecated and has been removed in OpenShift Container Platform 4.10 and later.

If an instance type for your platform meets the minimum requirements for cluster machines, it is supported to use in OpenShift Container Platform.

### 20.5.5.3. Certificate signing requests management

Because your cluster has limited access to automatic machine management when you use infrastructure that you provision, you must provide a mechanism for approving cluster certificate signing requests (CSRs) after installation. The **kube-controller-manager** only approves the kubelet client CSRs. The **machine-approver** cannot guarantee the validity of a serving certificate that is requested by using kubelet credentials because it cannot confirm that the correct machine issued the request. You must determine and implement a method of verifying the validity of the kubelet serving certificate requests and approving them.

### 20.5.5.4. Networking requirements for user-provisioned infrastructure

All the Red Hat Enterprise Linux CoreOS (RHCOS) machines require networking to be configured in **initramfs** during boot to fetch their Ignition config files.

During the initial boot, the machines require an IP address configuration that is set either through a DHCP server or statically by providing the required boot options. After a network connection is established, the machines download their Ignition config files from an HTTP or HTTPS server. The Ignition config files are then used to set the exact state of each machine. The Machine Config Operator completes more changes to the machines, such as the application of new certificates or keys, after installation.

It is recommended to use a DHCP server for long-term management of the cluster machines. Ensure that the DHCP server is configured to provide persistent IP addresses, DNS server information, and hostnames to the cluster machines.



#### NOTE

If a DHCP service is not available for your user-provisioned infrastructure, you can instead provide the IP networking configuration and the address of the DNS server to the nodes at RHCOS install time. These can be passed as boot arguments if you are installing from an ISO image. See the *Installing RHCOS and starting the OpenShift Container Platform bootstrap process* section for more information about static IP provisioning and advanced networking options.

The Kubernetes API server must be able to resolve the node names of the cluster machines. If the API servers and worker nodes are in different zones, you can configure a default DNS search zone to allow the API server to resolve the node names. Another supported approach is to always refer to hosts by their fully-qualified domain names in both the node objects and all DNS requests.

#### 20.5.5.4.1. Setting the cluster node hostnames through DHCP

On Red Hat Enterprise Linux CoreOS (RHCOS) machines, the hostname is set through NetworkManager. By default, the machines obtain their hostname through DHCP. If the hostname is not provided by DHCP, set statically through kernel arguments, or another method, it is obtained through a reverse DNS lookup. Reverse DNS lookup occurs after the network has been initialized on a node and can take time to resolve. Other system services can start prior to this and detect the hostname as **localhost** or similar. You can avoid this by using DHCP to provide the hostname for each cluster node.

Additionally, setting the hostnames through DHCP can bypass any manual DNS record name configuration errors in environments that have a DNS split-horizon implementation.

#### 20.5.5.4.2. Network connectivity requirements

You must configure the network connectivity between machines to allow OpenShift Container Platform cluster components to communicate. Each machine must be able to resolve the hostnames of all other machines in the cluster.

This section provides details about the ports that are required.

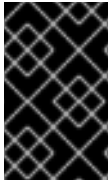

### IMPORTANT

In connected OpenShift Container Platform environments, all nodes are required to have internet access to pull images for platform containers and provide telemetry data to Red Hat.

**Table 20.42. Ports used for all-machine to all-machine communications**

Protocol	Port	Description
ICMP	N/A	Network reachability tests
TCP	<b>1936</b>	Metrics
	<b>9000-9999</b>	Host level services, including the node exporter on ports <b>9100-9101</b> and the Cluster Version Operator on port <b>9099</b> .
	<b>10250-10259</b>	The default ports that Kubernetes reserves
	<b>10256</b>	openshift-sdn
UDP	<b>4789</b>	VXLAN
	<b>6081</b>	Geneve
	<b>9000-9999</b>	Host level services, including the node exporter on ports <b>9100-9101</b> .
	<b>500</b>	IPsec IKE packets
	<b>4500</b>	IPsec NAT-T packets
TCP/UDP	<b>30000-32767</b>	Kubernetes node port
ESP	N/A	IPsec Encapsulating Security Payload (ESP)

**Table 20.43. Ports used for all-machine to control plane communications**

Protocol	Port	Description
TCP	<b>6443</b>	Kubernetes API

**Table 20.44. Ports used for control plane machine to control plane machine communications**

Protocol	Port	Description
TCP	<b>2379-2380</b>	etcd server and peer ports

### Ethernet adaptor hardware address requirements

When provisioning VMs for the cluster, the ethernet interfaces configured for each VM must use a MAC address from the VMware Organizationally Unique Identifier (OUI) allocation ranges:

- **00:05:69:00:00:00** to **00:05:69:FF:FF:FF**
- **00:0c:29:00:00:00** to **00:0c:29:FF:FF:FF**
- **00:1c:14:00:00:00** to **00:1c:14:FF:FF:FF**
- **00:50:56:00:00:00** to **00:50:56:3F:FF:FF**

If a MAC address outside the VMware OUI is used, the cluster installation will not succeed.

### NTP configuration for user-provisioned infrastructure

OpenShift Container Platform clusters are configured to use a public Network Time Protocol (NTP) server by default. If you want to use a local enterprise NTP server, or if your cluster is being deployed in a disconnected network, you can configure the cluster to use a specific time server. For more information, see the documentation for *Configuring chrony time service*.

If a DHCP server provides NTP server information, the chrony time service on the Red Hat Enterprise Linux CoreOS (RHCOS) machines read the information and can sync the clock with the NTP servers.

### Additional resources

- [Configuring chrony time service](#)

### 20.5.5.5. User-provisioned DNS requirements

In OpenShift Container Platform deployments, DNS name resolution is required for the following components:

- The Kubernetes API
- The OpenShift Container Platform application wildcard
- The bootstrap, control plane, and compute machines

Reverse DNS resolution is also required for the Kubernetes API, the bootstrap machine, the control plane machines, and the compute machines.

DNS A/AAAA or CNAME records are used for name resolution and PTR records are used for reverse name resolution. The reverse records are important because Red Hat Enterprise Linux CoreOS (RHCOS) uses the reverse records to set the hostnames for all the nodes, unless the hostnames are provided by DHCP. Additionally, the reverse records are used to generate the certificate signing requests (CSR) that OpenShift Container Platform needs to operate.

**NOTE**

It is recommended to use a DHCP server to provide the hostnames to each cluster node. See the *DHCP recommendations for user-provisioned infrastructure* section for more information.

The following DNS records are required for a user-provisioned OpenShift Container Platform cluster and they must be in place before installation. In each record, **<cluster\_name>** is the cluster name and **<base\_domain>** is the base domain that you specify in the **install-config.yaml** file. A complete DNS record takes the form: **<component>.<cluster\_name>.<base\_domain>.**

**Table 20.45. Required DNS records**

Component	Record	Description
Kubernetes API	<b>api.&lt;cluster_name&gt;.&lt;base_domain&gt;.</b>	A DNS A/AAAA or CNAME record, and a DNS PTR record, to identify the API load balancer. These records must be resolvable by both clients external to the cluster and from all the nodes within the cluster.
	<b>api-int.&lt;cluster_name&gt;.&lt;base_domain&gt;.</b>	A DNS A/AAAA or CNAME record, and a DNS PTR record, to internally identify the API load balancer. These records must be resolvable from all the nodes within the cluster.
		 <p><b>IMPORTANT</b></p> <p>The API server must be able to resolve the worker nodes by the hostnames that are recorded in Kubernetes. If the API server cannot resolve the node names, then proxied API calls can fail, and you cannot retrieve logs from pods.</p>
Routes	<b>*.apps.&lt;cluster_name&gt;.&lt;base_domain&gt;.</b>	A wildcard DNS A/AAAA or CNAME record that refers to the application ingress load balancer. The application ingress load balancer targets the machines that run the Ingress Controller pods. The Ingress Controller pods run on the compute machines by default. These records must be resolvable by both clients external to the cluster and from all the nodes within the cluster.
		For example, <b>console-openshift-console.apps.&lt;cluster_name&gt;.&lt;base_domain&gt;</b> is used as a wildcard route to the OpenShift Container Platform console.
Bootstrap machine	<b>bootstrap.&lt;cluster_name&gt;.&lt;base_domain&gt;.</b>	A DNS A/AAAA or CNAME record, and a DNS PTR record, to identify the bootstrap machine. These records must be resolvable by the nodes within the cluster.

Component	Record	Description
Control plane machines	<b>&lt;master&gt;&lt;n&gt;. &lt;cluster_name&gt;. &lt;base_domain&gt;.</b>	DNS A/AAAA or CNAME records and DNS PTR records to identify each machine for the control plane nodes. These records must be resolvable by the nodes within the cluster.
Compute machines	<b>&lt;worker&gt;&lt;n&gt;. &lt;cluster_name&gt;. &lt;base_domain&gt;.</b>	DNS A/AAAA or CNAME records and DNS PTR records to identify each machine for the worker nodes. These records must be resolvable by the nodes within the cluster.



## NOTE

In OpenShift Container Platform 4.4 and later, you do not need to specify etcd host and SRV records in your DNS configuration.

## TIP

You can use the **dig** command to verify name and reverse name resolution. See the section on *Validating DNS resolution for user-provisioned infrastructure* for detailed validation steps.

### 20.5.5.5.1. Example DNS configuration for user-provisioned clusters

This section provides A and PTR record configuration samples that meet the DNS requirements for deploying OpenShift Container Platform on user-provisioned infrastructure. The samples are not meant to provide advice for choosing one DNS solution over another.

In the examples, the cluster name is **ocp4** and the base domain is **example.com**.

#### Example DNS A record configuration for a user-provisioned cluster

The following example is a BIND zone file that shows sample A records for name resolution in a user-provisioned cluster.

#### Example 20.10. Sample DNS zone database

```
$TTL 1W
@ IN SOA ns1.example.com. root (
    2019070700 ; serial
    3H ; refresh (3 hours)
    30M ; retry (30 minutes)
    2W ; expiry (2 weeks)
    1W ) ; minimum (1 week)
IN NS ns1.example.com.
IN MX 10 smtp.example.com.
;
;
ns1.example.com. IN A 192.168.1.5
smtp.example.com. IN A 192.168.1.5
;
helper.example.com. IN A 192.168.1.5
```

```

helper.ocp4.example.com. IN A 192.168.1.5
;
api.ocp4.example.com. IN A 192.168.1.5 1
api-int.ocp4.example.com. IN A 192.168.1.5 2
;
*.apps.ocp4.example.com. IN A 192.168.1.5 3
;
bootstrap.ocp4.example.com. IN A 192.168.1.96 4
;
master0.ocp4.example.com. IN A 192.168.1.97 5
master1.ocp4.example.com. IN A 192.168.1.98 6
master2.ocp4.example.com. IN A 192.168.1.99 7
;
worker0.ocp4.example.com. IN A 192.168.1.11 8
worker1.ocp4.example.com. IN A 192.168.1.7 9
;
;EOF

```

- 1 Provides name resolution for the Kubernetes API. The record refers to the IP address of the API load balancer.
- 2 Provides name resolution for the Kubernetes API. The record refers to the IP address of the API load balancer and is used for internal cluster communications.
- 3 Provides name resolution for the wildcard routes. The record refers to the IP address of the application ingress load balancer. The application ingress load balancer targets the machines that run the Ingress Controller pods. The Ingress Controller pods run on the compute machines by default.

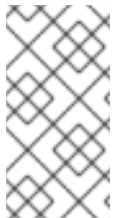

#### NOTE

In the example, the same load balancer is used for the Kubernetes API and application ingress traffic. In production scenarios, you can deploy the API and application ingress load balancers separately so that you can scale the load balancer infrastructure for each in isolation.

- 4 Provides name resolution for the bootstrap machine.
- 5 6 7 Provides name resolution for the control plane machines.
- 8 9 Provides name resolution for the compute machines.

### Example DNS PTR record configuration for a user-provisioned cluster

The following example BIND zone file shows sample PTR records for reverse name resolution in a user-provisioned cluster.

#### Example 20.11. Sample DNS zone database for reverse records

```

$TTL 1W
@ IN SOA ns1.example.com. root (
2019070700 ; serial

```



```

3H ; refresh (3 hours)
30M ; retry (30 minutes)
2W ; expiry (2 weeks)
1W ) ; minimum (1 week)
IN NS ns1.example.com.
;
5.1.168.192.in-addr.arpa. IN PTR api.ocp4.example.com. 1
5.1.168.192.in-addr.arpa. IN PTR api-int.ocp4.example.com. 2
;
96.1.168.192.in-addr.arpa. IN PTR bootstrap.ocp4.example.com. 3
;
97.1.168.192.in-addr.arpa. IN PTR master0.ocp4.example.com. 4
98.1.168.192.in-addr.arpa. IN PTR master1.ocp4.example.com. 5
99.1.168.192.in-addr.arpa. IN PTR master2.ocp4.example.com. 6
;
11.1.168.192.in-addr.arpa. IN PTR worker0.ocp4.example.com. 7
7.1.168.192.in-addr.arpa. IN PTR worker1.ocp4.example.com. 8
;
;EOF

```

- 1 Provides reverse DNS resolution for the Kubernetes API. The PTR record refers to the record name of the API load balancer.
- 2 Provides reverse DNS resolution for the Kubernetes API. The PTR record refers to the record name of the API load balancer and is used for internal cluster communications.
- 3 Provides reverse DNS resolution for the bootstrap machine.
- 4 5 6 Provides reverse DNS resolution for the control plane machines.
- 7 8 Provides reverse DNS resolution for the compute machines.



#### NOTE

A PTR record is not required for the OpenShift Container Platform application wildcard.

### 20.5.5.6. Load balancing requirements for user-provisioned infrastructure

Before you install OpenShift Container Platform, you must provision the API and application ingress load balancing infrastructure. In production scenarios, you can deploy the API and application ingress load balancers separately so that you can scale the load balancer infrastructure for each in isolation.



#### NOTE

If you want to deploy the API and application Ingress load balancers with a Red Hat Enterprise Linux (RHEL) instance, you must purchase the RHEL subscription separately.

The load balancing infrastructure must meet the following requirements:

1. **API load balancer.** Provides a common endpoint for users, both human and machine, to interact with and configure the platform. Configure the following conditions:

- Layer 4 load balancing only. This can be referred to as Raw TCP, SSL Passthrough, or SSL Bridge mode. If you use SSL Bridge mode, you must enable Server Name Indication (SNI) for the API routes.
- A stateless load balancing algorithm. The options vary based on the load balancer implementation.



### IMPORTANT

Do not configure session persistence for an API load balancer. Configuring session persistence for a Kubernetes API server might cause performance issues from excess application traffic for your OpenShift Container Platform cluster and the Kubernetes API that runs inside the cluster.

Configure the following ports on both the front and back of the load balancers:

**Table 20.46. API load balancer**

Port	Back-end machines (pool members)	Internal	External	Description
<b>6443</b>	Bootstrap and control plane. You remove the bootstrap machine from the load balancer after the bootstrap machine initializes the cluster control plane. You must configure the <b>/readyz</b> endpoint for the API server health check probe.	X	X	Kubernetes API server
<b>22623</b>	Bootstrap and control plane. You remove the bootstrap machine from the load balancer after the bootstrap machine initializes the cluster control plane.	X		Machine config server



### NOTE

The load balancer must be configured to take a maximum of 30 seconds from the time the API server turns off the **/readyz** endpoint to the removal of the API server instance from the pool. Within the time frame after **/readyz** returns an error or becomes healthy, the endpoint must have been removed or added. Probing every 5 or 10 seconds, with two successful requests to become healthy and three to become unhealthy, are well-tested values.

2. **Application Ingress load balancer.** Provides an ingress point for application traffic flowing in from outside the cluster. A working configuration for the Ingress router is required for an OpenShift Container Platform cluster.

Configure the following conditions:

- Layer 4 load balancing only. This can be referred to as Raw TCP, SSL Passthrough, or SSL Bridge mode. If you use SSL Bridge mode, you must enable Server Name Indication (SNI) for the ingress routes.

- A connection-based or session-based persistence is recommended, based on the options available and types of applications that will be hosted on the platform.

## TIP

If the true IP address of the client can be seen by the application Ingress load balancer, enabling source IP-based session persistence can improve performance for applications that use end-to-end TLS encryption.

Configure the following ports on both the front and back of the load balancers:

**Table 20.47. Application Ingress load balancer**

Port	Back-end machines (pool members)	Internal	External	Description
<b>443</b>	The machines that run the Ingress Controller pods, compute, or worker, by default.	X	X	HTTPS traffic
<b>80</b>	The machines that run the Ingress Controller pods, compute, or worker, by default.	X	X	HTTP traffic



## NOTE

If you are deploying a three-node cluster with zero compute nodes, the Ingress Controller pods run on the control plane nodes. In three-node cluster deployments, you must configure your application Ingress load balancer to route HTTP and HTTPS traffic to the control plane nodes.

### 20.5.5.6.1. Example load balancer configuration for user-provisioned clusters

This section provides an example API and application ingress load balancer configuration that meets the load balancing requirements for user-provisioned clusters. The sample is an `/etc/haproxy/haproxy.cfg` configuration for an HAProxy load balancer. The example is not meant to provide advice for choosing one load balancing solution over another.

In the example, the same load balancer is used for the Kubernetes API and application ingress traffic. In production scenarios, you can deploy the API and application ingress load balancers separately so that you can scale the load balancer infrastructure for each in isolation.



## NOTE

If you are using HAProxy as a load balancer and SELinux is set to **enforcing**, you must ensure that the HAProxy service can bind to the configured TCP port by running **setsebool -P haproxy\_connect\_any=1**.

### Example 20.12. Sample API and application Ingress load balancer configuration

```
global
log      127.0.0.1 local2
pidfile /var/run/haproxy.pid
```

```

maxconn 4000
daemon
defaults
mode http
log global
option dontlognull
option http-server-close
option redispatch
retries 3
timeout http-request 10s
timeout queue 1m
timeout connect 10s
timeout client 1m
timeout server 1m
timeout http-keep-alive 10s
timeout check 10s
maxconn 3000
listen api-server-6443 1
bind *:6443
mode tcp
server bootstrap bootstrap.ocp4.example.com:6443 check inter 1s backup 2
server master0 master0.ocp4.example.com:6443 check inter 1s
server master1 master1.ocp4.example.com:6443 check inter 1s
server master2 master2.ocp4.example.com:6443 check inter 1s
listen machine-config-server-22623 3
bind *:22623
mode tcp
server bootstrap bootstrap.ocp4.example.com:22623 check inter 1s backup 4
server master0 master0.ocp4.example.com:22623 check inter 1s
server master1 master1.ocp4.example.com:22623 check inter 1s
server master2 master2.ocp4.example.com:22623 check inter 1s
listen ingress-router-443 5
bind *:443
mode tcp
balance source
server worker0 worker0.ocp4.example.com:443 check inter 1s
server worker1 worker1.ocp4.example.com:443 check inter 1s
listen ingress-router-80 6
bind *:80
mode tcp
balance source
server worker0 worker0.ocp4.example.com:80 check inter 1s
server worker1 worker1.ocp4.example.com:80 check inter 1s

```

- 1** Port **6443** handles the Kubernetes API traffic and points to the control plane machines.
- 2** **4** The bootstrap entries must be in place before the OpenShift Container Platform cluster installation and they must be removed after the bootstrap process is complete.
- 3** Port **22623** handles the machine config server traffic and points to the control plane machines.
- 5** Port **443** handles the HTTPS traffic and points to the machines that run the Ingress Controller pods. The Ingress Controller pods run on the compute machines by default.
- 6** Port **80** handles the HTTP traffic and points to the machines that run the Ingress Controller pods. The Ingress Controller pods run on the compute machines by default.

**NOTE**

If you are deploying a three-node cluster with zero compute nodes, the Ingress Controller pods run on the control plane nodes. In three-node cluster deployments, you must configure your application Ingress load balancer to route HTTP and HTTPS traffic to the control plane nodes.

**TIP**

If you are using HAProxy as a load balancer, you can check that the **haproxy** process is listening on ports **6443**, **22623**, **443**, and **80** by running **netstat -nltp** on the HAProxy node.

### 20.5.6. Preparing the user-provisioned infrastructure

Before you install OpenShift Container Platform on user-provisioned infrastructure, you must prepare the underlying infrastructure.

This section provides details about the high-level steps required to set up your cluster infrastructure in preparation for an OpenShift Container Platform installation. This includes configuring IP networking and network connectivity for your cluster nodes, enabling the required ports through your firewall, and setting up the required DNS and load balancing infrastructure.

After preparation, your cluster infrastructure must meet the requirements outlined in the *Requirements for a cluster with user-provisioned infrastructure* section.

**Prerequisites**

- You have reviewed the [OpenShift Container Platform 4.x Tested Integrations](#) page.
- You have reviewed the infrastructure requirements detailed in the *Requirements for a cluster with user-provisioned infrastructure* section.

**Procedure**

1. If you are using DHCP to provide the IP networking configuration to your cluster nodes, configure your DHCP service.
  - a. Add persistent IP addresses for the nodes to your DHCP server configuration. In your configuration, match the MAC address of the relevant network interface to the intended IP address for each node.
  - b. When you use DHCP to configure IP addressing for the cluster machines, the machines also obtain the DNS server information through DHCP. Define the persistent DNS server address that is used by the cluster nodes through your DHCP server configuration.

**NOTE**

If you are not using a DHCP service, you must provide the IP networking configuration and the address of the DNS server to the nodes at RHCOS install time. These can be passed as boot arguments if you are installing from an ISO image. See the *Installing RHCOS and starting the OpenShift Container Platform bootstrap process* section for more information about static IP provisioning and advanced networking options.

- c. Define the hostnames of your cluster nodes in your DHCP server configuration. See the *Setting the cluster node hostnames through DHCP* section for details about hostname considerations.

**NOTE**

If you are not using a DHCP service, the cluster nodes obtain their hostname through a reverse DNS lookup.

2. Ensure that your network infrastructure provides the required network connectivity between the cluster components. See the *Networking requirements for user-provisioned infrastructure* section for details about the requirements.
3. Configure your firewall to enable the ports required for the OpenShift Container Platform cluster components to communicate. See *Networking requirements for user-provisioned infrastructure* section for details about the ports that are required.

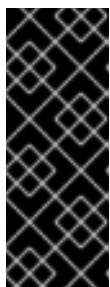
**IMPORTANT**

By default, port **1936** is accessible for an OpenShift Container Platform cluster, because each control plane node needs access to this port.

Avoid using the Ingress load balancer to expose this port, because doing so might result in the exposure of sensitive information, such as statistics and metrics, related to Ingress Controllers.

4. Setup the required DNS infrastructure for your cluster.
  - a. Configure DNS name resolution for the Kubernetes API, the application wildcard, the bootstrap machine, the control plane machines, and the compute machines.
  - b. Configure reverse DNS resolution for the Kubernetes API, the bootstrap machine, the control plane machines, and the compute machines.  
See the *User-provisioned DNS requirements* section for more information about the OpenShift Container Platform DNS requirements.
5. Validate your DNS configuration.
  - a. From your installation node, run DNS lookups against the record names of the Kubernetes API, the wildcard routes, and the cluster nodes. Validate that the IP addresses in the responses correspond to the correct components.
  - b. From your installation node, run reverse DNS lookups against the IP addresses of the load balancer and the cluster nodes. Validate that the record names in the responses correspond to the correct components.

See the *Validating DNS resolution for user-provisioned infrastructure* section for detailed DNS validation steps.

6. Provision the required API and application ingress load balancing infrastructure. See the *Load balancing requirements for user-provisioned infrastructure* section for more information about the requirements.



#### NOTE

Some load balancing solutions require the DNS name resolution for the cluster nodes to be in place before the load balancing is initialized.

### 20.5.7. Validating DNS resolution for user-provisioned infrastructure

You can validate your DNS configuration before installing OpenShift Container Platform on user-provisioned infrastructure.

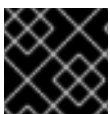

#### IMPORTANT

The validation steps detailed in this section must succeed before you install your cluster.

#### Prerequisites

- You have configured the required DNS records for your user-provisioned infrastructure.

#### Procedure

1. From your installation node, run DNS lookups against the record names of the Kubernetes API, the wildcard routes, and the cluster nodes. Validate that the IP addresses contained in the responses correspond to the correct components.
  - a. Perform a lookup against the Kubernetes API record name. Check that the result points to the IP address of the API load balancer:

```
$ dig +noall +answer @<nameserver_ip> api.<cluster_name>.<base_domain> 1
```

- 1 Replace **<nameserver\_ip>** with the IP address of the nameserver, **<cluster\_name>** with your cluster name, and **<base\_domain>** with your base domain name.

#### Example output

```
api.ocp4.example.com. 0 IN A 192.168.1.5
```

- b. Perform a lookup against the Kubernetes internal API record name. Check that the result points to the IP address of the API load balancer:

```
$ dig +noall +answer @<nameserver_ip> api-int.<cluster_name>.<base_domain>
```

#### Example output

```
api-int.ocp4.example.com. 0 IN A 192.168.1.5
```

- c. Test an example `*.apps.<cluster_name>.<base_domain>` DNS wildcard lookup. All of the application wildcard lookups must resolve to the IP address of the application ingress load balancer:

```
$ dig +noall +answer @<nameserver_ip> random.apps.<cluster_name>.<base_domain>
```

#### Example output

```
random.apps.ocp4.example.com. 0 IN A 192.168.1.5
```



#### NOTE

In the example outputs, the same load balancer is used for the Kubernetes API and application ingress traffic. In production scenarios, you can deploy the API and application ingress load balancers separately so that you can scale the load balancer infrastructure for each in isolation.

You can replace **random** with another wildcard value. For example, you can query the route to the OpenShift Container Platform console:

```
$ dig +noall +answer @<nameserver_ip> console-openshift-console.apps.<cluster_name>.<base_domain>
```

#### Example output

```
console-openshift-console.apps.ocp4.example.com. 0 IN A 192.168.1.5
```

- d. Run a lookup against the bootstrap DNS record name. Check that the result points to the IP address of the bootstrap node:

```
$ dig +noall +answer @<nameserver_ip> bootstrap.<cluster_name>.<base_domain>
```

#### Example output

```
bootstrap.ocp4.example.com. 0 IN A 192.168.1.96
```

- e. Use this method to perform lookups against the DNS record names for the control plane and compute nodes. Check that the results correspond to the IP addresses of each node.
2. From your installation node, run reverse DNS lookups against the IP addresses of the load balancer and the cluster nodes. Validate that the record names contained in the responses correspond to the correct components.
    - a. Perform a reverse lookup against the IP address of the API load balancer. Check that the response includes the record names for the Kubernetes API and the Kubernetes internal API:

```
$ dig +noall +answer @<nameserver_ip> -x 192.168.1.5
```

#### Example output



```
5.1.168.192.in-addr.arpa. 0 IN PTR api-int.ocp4.example.com. 1
```

```
5.1.168.192.in-addr.arpa. 0 IN PTR api.ocp4.example.com. 2
```

- 1 Provides the record name for the Kubernetes internal API.
- 2 Provides the record name for the Kubernetes API.



#### NOTE

A PTR record is not required for the OpenShift Container Platform application wildcard. No validation step is needed for reverse DNS resolution against the IP address of the application ingress load balancer.

- b. Perform a reverse lookup against the IP address of the bootstrap node. Check that the result points to the DNS record name of the bootstrap node:

```
$ dig +noall +answer @<nameserver_ip> -x 192.168.1.96
```

#### Example output

```
96.1.168.192.in-addr.arpa. 0 IN PTR bootstrap.ocp4.example.com.
```

- c. Use this method to perform reverse lookups against the IP addresses for the control plane and compute nodes. Check that the results correspond to the DNS record names of each node.

### 20.5.8. Generating a key pair for cluster node SSH access

During an OpenShift Container Platform installation, you can provide an SSH public key to the installation program. The key is passed to the Red Hat Enterprise Linux CoreOS (RHCOS) nodes through their Ignition config files and is used to authenticate SSH access to the nodes. The key is added to the `~/.ssh/authorized_keys` list for the **core** user on each node, which enables password-less authentication.

After the key is passed to the nodes, you can use the key pair to SSH in to the RHCOS nodes as the user **core**. To access the nodes through SSH, the private key identity must be managed by SSH for your local user.

If you want to SSH in to your cluster nodes to perform installation debugging or disaster recovery, you must provide the SSH public key during the installation process. The `./openshift-install gather` command also requires the SSH public key to be in place on the cluster nodes.



#### IMPORTANT

Do not skip this procedure in production environments, where disaster recovery and debugging is required.



#### NOTE

You must use a local key, not one that you configured with platform-specific approaches such as [AWS key pairs](#).

## Procedure

1. If you do not have an existing SSH key pair on your local machine to use for authentication onto your cluster nodes, create one. For example, on a computer that uses a Linux operating system, run the following command:

```
$ ssh-keygen -t ed25519 -N "" -f <path>/<file_name> 1
```

- 1 Specify the path and file name, such as `~/.ssh/id_ed25519`, of the new SSH key. If you have an existing key pair, ensure your public key is in the your `~/.ssh` directory.



### NOTE

If you plan to install an OpenShift Container Platform cluster that uses FIPS validated or Modules In Process cryptographic libraries on the **x86\_64** architecture, do not create a key that uses the **ed25519** algorithm. Instead, create a key that uses the **rsa** or **ecdsa** algorithm.

2. View the public SSH key:

```
$ cat <path>/<file_name>.pub
```

For example, run the following to view the `~/.ssh/id_ed25519.pub` public key:

```
$ cat ~/.ssh/id_ed25519.pub
```

3. Add the SSH private key identity to the SSH agent for your local user, if it has not already been added. SSH agent management of the key is required for password-less SSH authentication onto your cluster nodes, or if you want to use the `./openshift-install gather` command.



### NOTE

On some distributions, default SSH private key identities such as `~/.ssh/id_rsa` and `~/.ssh/id_dsa` are managed automatically.

- a. If the **ssh-agent** process is not already running for your local user, start it as a background task:

```
$ eval "$(ssh-agent -s)"
```

### Example output

```
Agent pid 31874
```



### NOTE

If your cluster is in FIPS mode, only use FIPS-compliant algorithms to generate the SSH key. The key must be either RSA or ECDSA.

4. Add your SSH private key to the **ssh-agent**:

■

```
$ ssh-add <path>/<file_name> 1
```

- 1 Specify the path and file name for your SSH private key, such as `~/.ssh/id_ed25519`

### Example output

```
Identity added: /home/<you>/<path>/<file_name> (<computer_name>)
```

### Next steps

- When you install OpenShift Container Platform, provide the SSH public key to the installation program. If you install a cluster on infrastructure that you provision, you must provide the key to the installation program.

## 20.5.9. Obtaining the installation program

Before you install OpenShift Container Platform, download the installation file on a local computer.

### Prerequisites

- You have a computer that runs Linux or macOS, with 500 MB of local disk space

### Procedure

1. Access the [Infrastructure Provider](#) page on the OpenShift Cluster Manager site. If you have a Red Hat account, log in with your credentials. If you do not, create an account.
2. Select your infrastructure provider.
3. Navigate to the page for your installation type, download the installation program that corresponds with your host operating system and architecture, and place the file in the directory where you will store the installation configuration files.

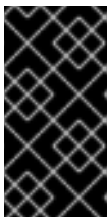

#### IMPORTANT

The installation program creates several files on the computer that you use to install your cluster. You must keep the installation program and the files that the installation program creates after you finish installing the cluster. Both files are required to delete the cluster.

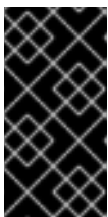

#### IMPORTANT

Deleting the files created by the installation program does not remove your cluster, even if the cluster failed during installation. To remove your cluster, complete the OpenShift Container Platform uninstallation procedures for your specific cloud provider.

4. Extract the installation program. For example, on a computer that uses a Linux operating system, run the following command:

```
$ tar -xvf openshift-install-linux.tar.gz
```

5. Download your installation [pull secret from the Red Hat OpenShift Cluster Manager](#) . This pull secret allows you to authenticate with the services that are provided by the included authorities, including Quay.io, which serves the container images for OpenShift Container Platform components.

## 20.5.10. Manually creating the installation configuration file

For user-provisioned installations of OpenShift Container Platform, you manually generate your installation configuration file.

### Prerequisites

- You have an SSH public key on your local machine to provide to the installation program. The key will be used for SSH authentication onto your cluster nodes for debugging and disaster recovery.
- You have obtained the OpenShift Container Platform installation program and the pull secret for your cluster.

### Procedure

1. Create an installation directory to store your required installation assets in:

```
$ mkdir <installation_directory>
```



#### IMPORTANT

You must create a directory. Some installation assets, like bootstrap X.509 certificates have short expiration intervals, so you must not reuse an installation directory. If you want to reuse individual files from another cluster installation, you can copy them into your directory. However, the file names for the installation assets might change between releases. Use caution when copying installation files from an earlier OpenShift Container Platform version.

2. Customize the sample **install-config.yaml** file template that is provided and save it in the **<installation\_directory>**.



#### NOTE

You must name this configuration file **install-config.yaml**.



#### NOTE

For some platform types, you can alternatively run **./openshift-install create install-config --dir <installation\_directory>** to generate an **install-config.yaml** file. You can provide details about your cluster configuration at the prompts.

3. Back up the **install-config.yaml** file so that you can use it to install multiple clusters.



#### IMPORTANT

The **install-config.yaml** file is consumed during the next step of the installation process. You must back it up now.

### 20.5.10.1. Sample `install-config.yaml` file for VMware vSphere

You can customize the `install-config.yaml` file to specify more details about your OpenShift Container Platform cluster's platform or modify the values of the required parameters.

```

apiVersion: v1
baseDomain: example.com 1
compute: 2
- hyperthreading: Enabled 3
  name: worker
  replicas: 0 4
controlPlane: 5
  hyperthreading: Enabled 6
  name: master
  replicas: 3 7
metadata:
  name: test 8
platform:
  vsphere:
    vcenter: your.vcenter.server 9
    username: username 10
    password: password 11
    datacenter: datacenter 12
    defaultDatastore: datastore 13
    folder: "/<datacenter_name>/vm/<folder_name>/<subfolder_name>" 14
    resourcePool: "/<datacenter_name>/host/<cluster_name>/Resources/<resource_pool_name>" 15
    diskType: thin 16
  fips: false 17
  pullSecret: '{"auths": ...}' 18
  sshKey: 'ssh-ed25519 AAAA...' 19

```

- 1 The base domain of the cluster. All DNS records must be sub-domains of this base and include the cluster name.
- 2 5 The **controlPlane** section is a single mapping, but the compute section is a sequence of mappings. To meet the requirements of the different data structures, the first line of the **compute** section must begin with a hyphen, -, and the first line of the **controlPlane** section must not. Although both sections currently define a single machine pool, it is possible that future versions of OpenShift Container Platform will support defining multiple compute pools during installation. Only one control plane pool is used.
- 3 6 Whether to enable or disable simultaneous multithreading, or **hyperthreading**. By default, simultaneous multithreading is enabled to increase the performance of your machines' cores. You can disable it by setting the parameter value to **Disabled**. If you disable simultaneous multithreading in some cluster machines, you must disable it in all cluster machines.

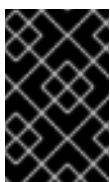

#### IMPORTANT

If you disable simultaneous multithreading, ensure that your capacity planning accounts for the dramatically decreased machine performance. Your machines must use at least 8 CPUs and 32 GB of RAM if you disable simultaneous multithreading.

- 4 You must set the value of the **replicas** parameter to **0**. This parameter controls the number of workers that the cluster creates and manages for you, which are functions that the cluster does not
- 7 The number of control plane machines that you add to the cluster. Because the cluster uses this values as the number of etcd endpoints in the cluster, the value must match the number of control plane machines that you deploy.
- 8 The cluster name that you specified in your DNS records.
- 9 The fully-qualified hostname or IP address of the vCenter server.
- 10 The name of the user for accessing the server. This user must have at least the roles and privileges that are required for [static or dynamic persistent volume provisioning](#) in vSphere.
- 11 The password associated with the vSphere user.
- 12 The vSphere datacenter.
- 13 The default vSphere datastore to use.
- 14 Optional parameter: For installer-provisioned infrastructure, the absolute path of an existing folder where the installation program creates the virtual machines, for example, `/<datacenter_name>/vm/<folder_name>/<subfolder_name>`. If you do not provide this value, the installation program creates a top-level folder in the datacenter virtual machine folder that is named with the infrastructure ID. If you are providing the infrastructure for the cluster and you do not want to use the default **StorageClass** object, named **thin**, you can omit the **folder** parameter from the **install-config.yaml** file.
- 15 Optional parameter: For installer-provisioned infrastructure, the absolute path of an existing resource pool where the installation program creates the virtual machines, for example, `/<datacenter_name>/host/<cluster_name>/Resources/<resource_pool_name>/<optional_nested_resource_pool_name>`. If you do not specify a value, resources are installed in the root of the cluster `/example_datacenter/host/example_cluster/Resources`.
- 16 The vSphere disk provisioning method.
- 17 Whether to enable or disable FIPS mode. By default, FIPS mode is not enabled. If FIPS mode is enabled, the Red Hat Enterprise Linux CoreOS (RHCOS) machines that OpenShift Container Platform runs on bypass the default Kubernetes cryptography suite and use the cryptography modules that are provided with RHCOS instead.



### IMPORTANT

To enable FIPS mode for your cluster, you must run the installation program from a Red Hat Enterprise Linux (RHEL) computer configured to operate in FIPS mode. For more information about configuring FIPS mode on RHEL, see [Installing the system in FIPS mode](#). The use of FIPS validated or Modules In Progress cryptographic libraries is only supported on OpenShift Container Platform deployments on the **x86\_64** architecture.

- 18 The pull secret that you obtained from [OpenShift Cluster Manager](#). This pull secret allows you to authenticate with the services that are provided by the included authorities, including Quay.io, which serves the container images for OpenShift Container Platform components.
- 19 The public portion of the default SSH key for the **core** user in Red Hat Enterprise Linux CoreOS (RHCOS).

### 20.5.10.2. Configuring the cluster-wide proxy during installation

Production environments can deny direct access to the internet and instead have an HTTP or HTTPS proxy available. You can configure a new OpenShift Container Platform cluster to use a proxy by configuring the proxy settings in the **install-config.yaml** file.

#### Prerequisites

- You have an existing **install-config.yaml** file.
- You reviewed the sites that your cluster requires access to and determined whether any of them need to bypass the proxy. By default, all cluster egress traffic is proxied, including calls to hosting cloud provider APIs. You added sites to the **Proxy** object's **spec.noProxy** field to bypass the proxy if necessary.



#### NOTE

The **Proxy** object **status.noProxy** field is populated with the values of the **networking.machineNetwork[].cidr**, **networking.clusterNetwork[].cidr**, and **networking.serviceNetwork[]** fields from your installation configuration.

For installations on Amazon Web Services (AWS), Google Cloud Platform (GCP), Microsoft Azure, and Red Hat OpenStack Platform (RHOSP), the **Proxy** object **status.noProxy** field is also populated with the instance metadata endpoint (**169.254.169.254**).

#### Procedure

1. Edit your **install-config.yaml** file and add the proxy settings. For example:

```
apiVersion: v1
baseDomain: my.domain.com
proxy:
  httpProxy: http://<username>:<pswd>@<ip>:<port> 1
  httpsProxy: https://<username>:<pswd>@<ip>:<port> 2
  noProxy: example.com 3
  additionalTrustBundle: | 4
    -----BEGIN CERTIFICATE-----
    <MY_TRUSTED_CA_CERT>
    -----END CERTIFICATE-----
...

```

- 1 A proxy URL to use for creating HTTP connections outside the cluster. The URL scheme must be **http**.
- 2 A proxy URL to use for creating HTTPS connections outside the cluster.
- 3 A comma-separated list of destination domain names, IP addresses, or other network CIDRs to exclude from proxying. Preface a domain with **.** to match subdomains only. For example, **.y.com** matches **x.y.com**, but not **y.com**. Use **\*** to bypass the proxy for all destinations. You must include vCenter's IP address and the IP range that you use for its machines.
- 4 If provided, the installation program generates a config map that is named **user-ca-bundle** in the **openshift-config** namespace that contains one or more additional CA certificates that are required for proxying HTTPS connections. The Cluster Network Operator then

that are required for proxying HTTPS connections. The Cluster Network Operator then creates a **trusted-ca-bundle** config map that merges these contents with the Red Hat Enterprise Linux CoreOS (RHCOS) trust bundle, and this config map is referenced in the **trustedCA** field of the **Proxy** object. The **additionalTrustBundle** field is required unless the proxy's identity certificate is signed by an authority from the RHCOS trust bundle.

**NOTE**

The installation program does not support the proxy **readinessEndpoints** field.

**NOTE**

If the installer times out, restart and then complete the deployment by using the **wait-for** command of the installer. For example:

```
$ ./openshift-install wait-for install-complete --log-level debug
```

2. Save the file and reference it when installing OpenShift Container Platform.

The installation program creates a cluster-wide proxy that is named **cluster** that uses the proxy settings in the provided **install-config.yaml** file. If no proxy settings are provided, a **cluster Proxy** object is still created, but it will have a nil **spec**.

**NOTE**

Only the **Proxy** object named **cluster** is supported, and no additional proxies can be created.

### 20.5.11. Creating the Kubernetes manifest and Ignition config files

Because you must modify some cluster definition files and manually start the cluster machines, you must generate the Kubernetes manifest and Ignition config files that the cluster needs to configure the machines.

The installation configuration file transforms into the Kubernetes manifests. The manifests wrap into the Ignition configuration files, which are later used to configure the cluster machines.

**IMPORTANT**

- The Ignition config files that the OpenShift Container Platform installation program generates contain certificates that expire after 24 hours, which are then renewed at that time. If the cluster is shut down before renewing the certificates and the cluster is later restarted after the 24 hours have elapsed, the cluster automatically recovers the expired certificates. The exception is that you must manually approve the pending **node-bootstrapper** certificate signing requests (CSRs) to recover kubelet certificates. See the documentation for *Recovering from expired control plane certificates* for more information.
- It is recommended that you use Ignition config files within 12 hours after they are generated because the 24-hour certificate rotates from 16 to 22 hours after the cluster is installed. By using the Ignition config files within 12 hours, you can avoid installation failure if the certificate update runs during installation.



## Prerequisites

- You obtained the OpenShift Container Platform installation program.
- You created the **install-config.yaml** installation configuration file.

## Procedure

1. Change to the directory that contains the OpenShift Container Platform installation program and generate the Kubernetes manifests for the cluster:

```
$ ./openshift-install create manifests --dir <installation_directory> 1
```

- 1 For **<installation\_directory>**, specify the installation directory that contains the **install-config.yaml** file you created.

2. Remove the Kubernetes manifest files that define the control plane machines and compute machine sets:

```
$ rm -f openshift/99_openshift-cluster-api_master-machines-*.yaml openshift/99_openshift-cluster-api_worker-machineset-*.yaml
```

Because you create and manage these resources yourself, you do not have to initialize them.

- You can preserve the machine set files to create compute machines by using the machine API, but you must update references to them to match your environment.
3. Check that the **mastersSchedulable** parameter in the **<installation\_directory>/manifests/cluster-scheduler-02-config.yml** Kubernetes manifest file is set to **false**. This setting prevents pods from being scheduled on the control plane machines:
    - a. Open the **<installation\_directory>/manifests/cluster-scheduler-02-config.yml** file.
    - b. Locate the **mastersSchedulable** parameter and ensure that it is set to **false**.
    - c. Save and exit the file.
  4. To create the Ignition configuration files, run the following command from the directory that contains the installation program:

```
$ ./openshift-install create ignition-configs --dir <installation_directory> 1
```

- 1 For **<installation\_directory>**, specify the same installation directory.

Ignition config files are created for the bootstrap, control plane, and compute nodes in the installation directory. The **kubeadmin-password** and **kubeconfig** files are created in the **./<installation\_directory>/auth** directory:

```
.
├── auth
│   ├── kubeadmin-password
│   └── kubeconfig
└── bootstrap.ign
```

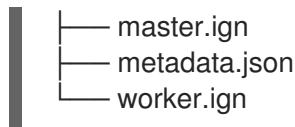

## 20.5.12. Extracting the infrastructure name

The Ignition config files contain a unique cluster identifier that you can use to uniquely identify your cluster in VMware vSphere. If you plan to use the cluster identifier as the name of your virtual machine folder, you must extract it.

### Prerequisites

- You obtained the OpenShift Container Platform installation program and the pull secret for your cluster.
- You generated the Ignition config files for your cluster.
- You installed the **jq** package.

### Procedure

- To extract and view the infrastructure name from the Ignition config file metadata, run the following command:

```
$ jq -r .infraID <installation_directory>/metadata.json 1
```

- 1 For **<installation\_directory>**, specify the path to the directory that you stored the installation files in.

### Example output

```
openshift-vw9j6 1
```

- 1 The output of this command is your cluster name and a random string.

## 20.5.13. Installing RHCOS and starting the OpenShift Container Platform bootstrap process

To install OpenShift Container Platform on user-provisioned infrastructure on VMware vSphere, you must install Red Hat Enterprise Linux CoreOS (RHCOS) on vSphere hosts. When you install RHCOS, you must provide the Ignition config file that was generated by the OpenShift Container Platform installation program for the type of machine you are installing. If you have configured suitable networking, DNS, and load balancing infrastructure, the OpenShift Container Platform bootstrap process begins automatically after the RHCOS machines have rebooted.

### Prerequisites

- You have obtained the Ignition config files for your cluster.
- You have access to an HTTP server that you can access from your computer and that the machines that you create can access.

- You have created a [vSphere cluster](#).

## Procedure

1. Upload the bootstrap Ignition config file, which is named **<installation\_directory>/bootstrap.ign**, that the installation program created to your HTTP server. Note the URL of this file.
2. Save the following secondary Ignition config file for your bootstrap node to your computer as **<installation\_directory>/merge-bootstrap.ign**:

```
{
  "ignition": {
    "config": {
      "merge": [
        {
          "source": "<bootstrap_ignition_config_url>", 1
          "verification": {}
        }
      ]
    },
    "timeouts": {},
    "version": "3.2.0"
  },
  "networkd": {},
  "passwd": {},
  "storage": {},
  "systemd": {}
}
```

- 1** Specify the URL of the bootstrap Ignition config file that you hosted.

When you create the virtual machine (VM) for the bootstrap machine, you use this Ignition config file.

3. Locate the following Ignition config files that the installation program created:
  - **<installation\_directory>/master.ign**
  - **<installation\_directory>/worker.ign**
  - **<installation\_directory>/merge-bootstrap.ign**
4. Convert the Ignition config files to Base64 encoding. Later in this procedure, you must add these files to the extra configuration parameter **guestinfo.ignition.config.data** in your VM. For example, if you use a Linux operating system, you can use the **base64** command to encode the files.

```
$ base64 -w0 <installation_directory>/master.ign > <installation_directory>/master.64
```

```
$ base64 -w0 <installation_directory>/worker.ign > <installation_directory>/worker.64
```

```
$ base64 -w0 <installation_directory>/merge-bootstrap.ign > <installation_directory>/merge-bootstrap.64
```

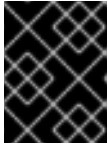
**IMPORTANT**

If you plan to add more compute machines to your cluster after you finish installation, do not delete these files.

5. Obtain the RHCOS OVA image. Images are available from the [RHCOS image mirror](#) page.

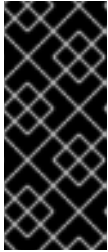
**IMPORTANT**

The RHCOS images might not change with every release of OpenShift Container Platform. You must download an image with the highest version that is less than or equal to the OpenShift Container Platform version that you install. Use the image version that matches your OpenShift Container Platform version if it is available.

The filename contains the OpenShift Container Platform version number in the format **rhcos-vmware.<architecture>.ova**.

6. In the vSphere Client, create a folder in your datacenter to store your VMs.
  - a. Click the **VMs and Templates** view.
  - b. Right-click the name of your datacenter.
  - c. Click **New Folder → New VM and Template Folder**.
  - d. In the window that is displayed, enter the folder name. If you did not specify an existing folder in the **install-config.yaml** file, then create a folder with the same name as the infrastructure ID. You use this folder name so vCenter dynamically provisions storage in the appropriate location for its Workspace configuration.
7. In the vSphere Client, create a template for the OVA image and then clone the template as needed.

**NOTE**

In the following steps, you create a template and then clone the template for all of your cluster machines. You then provide the location for the Ignition config file for that cloned machine type when you provision the VMs.

- a. From the **Hosts and Clusters** tab, right-click your cluster name and select **Deploy OVF Template**.
- b. On the **Select an OVF** tab, specify the name of the RHCOS OVA file that you downloaded.
- c. On the **Select a name and folder** tab, set a **Virtual machine name** for your template, such as **Template-RHCOS**. Click the name of your vSphere cluster and select the folder you created in the previous step.
- d. On the **Select a compute resource** tab, click the name of your vSphere cluster.
- e. On the **Select storage** tab, configure the storage options for your VM.
  - Select **Thin Provision** or **Thick Provision**, based on your storage preferences.

- Select the datastore that you specified in your **install-config.yaml** file.
- f. On the **Select network** tab, specify the network that you configured for the cluster, if available.
  - g. When creating the OVF template, do not specify values on the **Customize template** tab or configure the template any further.



### IMPORTANT

Do not start the original VM template. The VM template must remain off and must be cloned for new RHCOS machines. Starting the VM template configures the VM template as a VM on the platform, which prevents it from being used as a template that machine sets can apply configurations to.

8. Optional: Update the configured virtual hardware version in the VM template, if necessary. Follow [Upgrading a virtual machine to the latest hardware version](#) in the VMware documentation for more information.

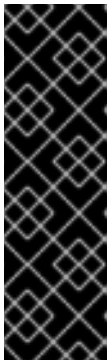

### IMPORTANT

It is recommended that you update the hardware version of the VM template to version 15 before creating VMs from it, if necessary. Using hardware version 13 for your cluster nodes running on vSphere is now deprecated. If your imported template defaults to hardware version 13, you must ensure that your ESXi host is on 6.7U3 or later before upgrading the VM template to hardware version 15. If your vSphere version is less than 6.7U3, you can skip this upgrade step; however, a future version of OpenShift Container Platform is scheduled to remove support for hardware version 13 and vSphere versions less than 6.7U3.

9. After the template deploys, deploy a VM for a machine in the cluster.
  - a. Right-click the template name and click **Clone → Clone to Virtual Machine**
  - b. On the **Select a name and folder** tab, specify a name for the VM. You might include the machine type in the name, such as **control-plane-0** or **compute-1**.



### NOTE

Ensure that all virtual machine names across a vSphere installation are unique.

- c. On the **Select a name and folder** tab, select the name of the folder that you created for the cluster.
- d. On the **Select a compute resource** tab, select the name of a host in your datacenter.
- e. On the **Select clone options**, select **Customize this virtual machine's hardware**
- f. Optional: On the **Customize hardware** tab, click **VM Options → Advanced**.



## IMPORTANT

The following configuration suggestions are for example purposes only. As a cluster administrator, you must configure resources according to the resource demands placed on your cluster. To best manage cluster resources, consider creating a resource pool from the cluster's root resource pool.

- Override default DHCP networking in vSphere. To enable static IP networking:
  - Set your static IP configuration:

```
$ export IPCFG="ip=<ip>::<gateway>:<netmask>:<hostname>:<iface>:none
nameserver=svr1 [nameserver=svr2 [nameserver=svr3 [...]]]"
```

### Example command

```
$ export IPCFG="ip=192.168.100.101::192.168.100.254:255.255.255.0::none
nameserver=8.8.8.8"
```

- Click **Edit Configuration**, and on the **Configuration Parameters** window, search the list of available parameters for steal clock accounting (**stealclock.enable**). Set the parameter to the value of **TRUE**. Enabling steal clock accounting can help with troubleshooting cluster issues.
  - Click **Add Configuration Params**. Define the following parameter names and values:
    - **disk.EnableUUID**: Specify **TRUE**.
    - **stealclock.enable**: If this parameter was not defined, add it and specify **TRUE**.
    - Create a child resource pool from the cluster's root resource pool. Perform resource allocation in this child resource pool.
- g. In the **Virtual Hardware** panel of the **Customize hardware** tab, modify the specified values as required. Ensure that the amount of RAM, CPU, and disk storage meets the minimum requirements for the machine type.
- h. Complete the configuration and power on the VM.
- i. Check the console output to verify that Ignition ran.

### Example command

```
Ignition: ran on 2022/03/14 14:48:33 UTC (this boot)
Ignition: user-provided config was applied
```

10. Create the rest of the machines for your cluster by following the preceding steps for each machine.



## IMPORTANT

You must create the bootstrap and control plane machines at this time. Because some pods are deployed on compute machines by default, also create at least two compute machines before you install the cluster.

## 20.5.14. Adding more compute machines to a cluster in vSphere

You can add more compute machines to a user-provisioned OpenShift Container Platform cluster on VMware vSphere.

### Prerequisites

- Obtain the base64-encoded Ignition file for your compute machines.
- You have access to the vSphere template that you created for your cluster.

### Procedure

1. After the template deploys, deploy a VM for a machine in the cluster.
  - a. Right-click the template's name and click **Clone** → **Clone to Virtual Machine**
  - b. On the **Select a name and folder** tab, specify a name for the VM. You might include the machine type in the name, such as **compute-1**.



### NOTE

Ensure that all virtual machine names across a vSphere installation are unique.

- c. On the **Select a name and folder** tab, select the name of the folder that you created for the cluster.
  - d. On the **Select a compute resource** tab, select the name of a host in your datacenter.
  - e. On the **Select clone options**, select **Customize this virtual machine's hardware**
  - f. On the **Customize hardware** tab, click **VM Options** → **Advanced**.
    - Click **Edit Configuration**, and on the **Configuration Parameters** window, click **Add Configuration Params**. Define the following parameter names and values:
      - **guestinfo.ignition.config.data**: Paste the contents of the base64-encoded compute Ignition config file for this machine type.
      - **guestinfo.ignition.config.data.encoding**: Specify **base64**.
      - **disk.EnableUUID**: Specify **TRUE**.
  - g. In the **Virtual Hardware** panel of the **Customize hardware** tab, modify the specified values as required. Ensure that the amount of RAM, CPU, and disk storage meets the minimum requirements for the machine type. Also, make sure to select the correct network under **Add network adapter** if there are multiple networks available.
  - h. Complete the configuration and power on the VM.
2. Continue to create more compute machines for your cluster.

## 20.5.15. Disk partitioning

In most cases, data partitions are originally created by installing RHCOS, rather than by installing another operating system. In such cases, the OpenShift Container Platform installer should be allowed to configure your disk partitions.

However, there are two cases where you might want to intervene to override the default partitioning when installing an OpenShift Container Platform node:

- **Create separate partitions:** For greenfield installations on an empty disk, you might want to add separate storage to a partition. This is officially supported for making **/var** or a subdirectory of **/var**, such as **/var/lib/etcd**, a separate partition, but not both.

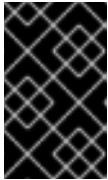

#### IMPORTANT

For disk sizes larger than 100GB, and especially disk sizes larger than 1TB, create a separate **/var** partition. See "Creating a separate **/var** partition" and this [Red Hat Knowledgebase article](#) for more information.

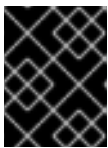

#### IMPORTANT

Kubernetes supports only two file system partitions. If you add more than one partition to the original configuration, Kubernetes cannot monitor all of them.

- **Retain existing partitions:** For a brownfield installation where you are reinstalling OpenShift Container Platform on an existing node and want to retain data partitions installed from your previous operating system, there are both boot arguments and options to **coreos-installer** that allow you to retain existing data partitions.

### Creating a separate **/var** partition

In general, disk partitioning for OpenShift Container Platform should be left to the installer. However, there are cases where you might want to create separate partitions in a part of the filesystem that you expect to grow.

OpenShift Container Platform supports the addition of a single partition to attach storage to either the **/var** partition or a subdirectory of **/var**. For example:

- **/var/lib/containers:** Holds container-related content that can grow as more images and containers are added to a system.
- **/var/lib/etcd:** Holds data that you might want to keep separate for purposes such as performance optimization of etcd storage.
- **/var:** Holds data that you might want to keep separate for purposes such as auditing.



#### IMPORTANT

For disk sizes larger than 100GB, and especially larger than 1TB, create a separate **/var** partition.

Storing the contents of a **/var** directory separately makes it easier to grow storage for those areas as needed and reinstall OpenShift Container Platform at a later date and keep that data intact. With this method, you will not have to pull all your containers again, nor will you have to copy massive log files when you update systems.

Because **/var** must be in place before a fresh installation of Red Hat Enterprise Linux CoreOS (RHCOS), the following procedure sets up the separate **/var** partition by creating a machine config manifest that is



inserted during the **openshift-install** preparation phases of an OpenShift Container Platform installation.

## Procedure

1. Create a directory to hold the OpenShift Container Platform installation files:

```
$ mkdir $HOME/clusterconfig
```

2. Run **openshift-install** to create a set of files in the **manifest** and **openshift** subdirectories. Answer the system questions as you are prompted:

```
$ openshift-install create manifests --dir $HOME/clusterconfig
? SSH Public Key ...
$ ls $HOME/clusterconfig/openshift/
99_kubeadmin-password-secret.yaml
99_openshift-cluster-api_master-machines-0.yaml
99_openshift-cluster-api_master-machines-1.yaml
99_openshift-cluster-api_master-machines-2.yaml
...
```

3. Create a Butane config that configures the additional partition. For example, name the file **\$HOME/clusterconfig/98-var-partition.bu**, change the disk device name to the name of the storage device on the **worker** systems, and set the storage size as appropriate. This example places the **/var** directory on a separate partition:

```
variant: openshift
version: 4.10.0
metadata:
  labels:
    machineconfiguration.openshift.io/role: worker
  name: 98-var-partition
storage:
  disks:
    - device: /dev/<device_name> 1
      partitions:
        - label: var
          start_mib: <partition_start_offset> 2
          size_mib: <partition_size> 3
      filesystems:
        - device: /dev/disk/by-partlabel/var
          path: /var
          format: xfs
          mount_options: [defaults, prjquota] 4
          with_mount_unit: true
```

- 1 The storage device name of the disk that you want to partition.
- 2 When adding a data partition to the boot disk, a minimum value of 25000 mebibytes is recommended. The root file system is automatically resized to fill all available space up to the specified offset. If no value is specified, or if the specified value is smaller than the recommended minimum, the resulting root file system will be too small, and future reinstalls of RHCOS might overwrite the beginning of the data partition.

- 3 The size of the data partition in mebibytes.
- 4 The **prjquota** mount option must be enabled for filesystems used for container storage.



#### NOTE

When creating a separate **/var** partition, you cannot use different instance types for worker nodes, if the different instance types do not have the same device name.

4. Create a manifest from the Butane config and save it to the **clusterconfig/openshift** directory. For example, run the following command:

```
$ butane $HOME/clusterconfig/98-var-partition.bu -o $HOME/clusterconfig/openshift/98-var-partition.yaml
```

5. Run **openshift-install** again to create Ignition configs from a set of files in the **manifest** and **openshift** subdirectories:

```
$ openshift-install create ignition-configs --dir $HOME/clusterconfig
$ ls $HOME/clusterconfig/
auth bootstrap.ign master.ign metadata.json worker.ign
```

Now you can use the Ignition config files as input to the vSphere installation procedures to install Red Hat Enterprise Linux CoreOS (RHCOS) systems.

### 20.5.16. Updating the bootloader using **bootupd**

To update the bootloader by using **bootupd**, you must either install **bootupd** on RHCOS machines manually or provide a machine config with the enabled **systemd** unit. Unlike **grubby** or other bootloader tools, **bootupd** does not manage kernel space configuration such as passing kernel arguments.

After you have installed **bootupd**, you can manage it remotely from the OpenShift Container Platform cluster.



#### NOTE

It is recommended that you use **bootupd** only on bare metal or virtualized hypervisor installations, such as for protection against the BootHole vulnerability.

#### Manual install method

You can manually install **bootupd** by using the **bootctl** command-line tool.

1. Inspect the system status:

```
# bootupctl status
```

**Example output for x86\_64**

```
Component EFI
```

```
Installed: grub2-efi-x64-1:2.04-31.fc33.x86_64,shim-x64-15-8.x86_64
```

```
Update: At latest version
```

### Example output for aarch64

```
Component EFI
```

```
Installed: grub2-efi-aa64-1:2.02-99.el8_4.1.aarch64,shim-aa64-15.4-2.el8_1.aarch64
```

```
Update: At latest version
```

- RHCOS images created without **bootupd** installed on them require an explicit adoption phase. If the system status is **Adoptable**, perform the adoption:

```
# bootupctl adopt-and-update
```

### Example output

```
Updated: grub2-efi-x64-1:2.04-31.fc33.x86_64,shim-x64-15-8.x86_64
```

- If an update is available, apply the update so that the changes take effect on the next reboot:

```
# bootupctl update
```

### Example output

```
Updated: grub2-efi-x64-1:2.04-31.fc33.x86_64,shim-x64-15-8.x86_64
```

## Machine config method

Another way to enable **bootupd** is by providing a machine config.

- Provide a machine config file with the enabled **systemd** unit, as shown in the following example:

### Example output

```
variant: rhcos
version: 1.1.0
systemd:
  units:
    - name: custom-bootupd-auto.service
      enabled: true
      contents: |
        [Unit]
        Description=Bootupd automatic update

        [Service]
        ExecStart=/usr/bin/bootupctl update
        RemainAfterExit=yes

        [Install]
        WantedBy=multi-user.target
```

## 20.5.17. Installing the OpenShift CLI by downloading the binary

You can install the OpenShift CLI (**oc**) to interact with OpenShift Container Platform from a command-line interface. You can install **oc** on Linux, Windows, or macOS.



### IMPORTANT

If you installed an earlier version of **oc**, you cannot use it to complete all of the commands in OpenShift Container Platform 4.10. Download and install the new version of **oc**.

### Installing the OpenShift CLI on Linux

You can install the OpenShift CLI (**oc**) binary on Linux by using the following procedure.

#### Procedure

1. Navigate to the [OpenShift Container Platform downloads page](#) on the Red Hat Customer Portal.
2. Select the appropriate version in the **Version** drop-down menu.
3. Click **Download Now** next to the **OpenShift v4.10 Linux Client** entry and save the file.
4. Unpack the archive:

```
$ tar xvf <file>
```

5. Place the **oc** binary in a directory that is on your **PATH**.  
To check your **PATH**, execute the following command:

```
$ echo $PATH
```

After you install the OpenShift CLI, it is available using the **oc** command:

```
$ oc <command>
```

### Installing the OpenShift CLI on Windows

You can install the OpenShift CLI (**oc**) binary on Windows by using the following procedure.

#### Procedure

1. Navigate to the [OpenShift Container Platform downloads page](#) on the Red Hat Customer Portal.
2. Select the appropriate version in the **Version** drop-down menu.
3. Click **Download Now** next to the **OpenShift v4.10 Windows Client** entry and save the file.
4. Unzip the archive with a ZIP program.
5. Move the **oc** binary to a directory that is on your **PATH**.  
To check your **PATH**, open the command prompt and execute the following command:

```
C:\> path
```

After you install the OpenShift CLI, it is available using the **oc** command:

```
C:\> oc <command>
```

### Installing the OpenShift CLI on macOS

You can install the OpenShift CLI (**oc**) binary on macOS by using the following procedure.

#### Procedure

1. Navigate to the [OpenShift Container Platform downloads page](#) on the Red Hat Customer Portal.
2. Select the appropriate version in the **Version** drop-down menu.
3. Click **Download Now** next to the **OpenShift v4.10 MacOSX Client** entry and save the file.
4. Unpack and unzip the archive.
5. Move the **oc** binary to a directory on your PATH.

To check your **PATH**, open a terminal and execute the following command:

```
$ echo $PATH
```

After you install the OpenShift CLI, it is available using the **oc** command:

```
$ oc <command>
```

### 20.5.18. Waiting for the bootstrap process to complete

The OpenShift Container Platform bootstrap process begins after the cluster nodes first boot into the persistent RHCOS environment that has been installed to disk. The configuration information provided through the Ignition config files is used to initialize the bootstrap process and install OpenShift Container Platform on the machines. You must wait for the bootstrap process to complete.

#### Prerequisites

- You have created the Ignition config files for your cluster.
- You have configured suitable network, DNS and load balancing infrastructure.
- You have obtained the installation program and generated the Ignition config files for your cluster.
- You installed RHCOS on your cluster machines and provided the Ignition config files that the OpenShift Container Platform installation program generated.
- Your machines have direct internet access or have an HTTP or HTTPS proxy available.

#### Procedure

1. Monitor the bootstrap process:

```
$ ./openshift-install --dir <installation_directory> wait-for bootstrap-complete \ 1
--log-level=info 2
```

- 
- 1 For **<installation\_directory>**, specify the path to the directory that you stored the installation files in.
- 2 To view different installation details, specify **warn**, **debug**, or **error** instead of **info**.

### Example output

```
INFO Waiting up to 30m0s for the Kubernetes API at https://api.test.example.com:6443...
INFO API v1.23.0 up
INFO Waiting up to 30m0s for bootstrapping to complete...
INFO It is now safe to remove the bootstrap resources
```

The command succeeds when the Kubernetes API server signals that it has been bootstrapped on the control plane machines.

2. After bootstrap process is complete, remove the bootstrap machine from the load balancer.



### IMPORTANT

You must remove the bootstrap machine from the load balancer at this point. You can also remove or reformat the bootstrap machine itself.

## 20.5.19. Logging in to the cluster by using the CLI

You can log in to your cluster as a default system user by exporting the cluster **kubeconfig** file. The **kubeconfig** file contains information about the cluster that is used by the CLI to connect a client to the correct cluster and API server. The file is specific to a cluster and is created during OpenShift Container Platform installation.

### Prerequisites

- You deployed an OpenShift Container Platform cluster.
- You installed the **oc** CLI.

### Procedure

1. Export the **kubeadmin** credentials:

```
$ export KUBECONFIG=<installation_directory>/auth/kubeconfig 1
```

- 1 For **<installation\_directory>**, specify the path to the directory that you stored the installation files in.

2. Verify you can run **oc** commands successfully using the exported configuration:

```
$ oc whoami
```

### Example output

```
system:admin
```

■

## 20.5.20. Approving the certificate signing requests for your machines

When you add machines to a cluster, two pending certificate signing requests (CSRs) are generated for each machine that you added. You must confirm that these CSRs are approved or, if necessary, approve them yourself. The client requests must be approved first, followed by the server requests.

### Prerequisites

- You added machines to your cluster.

### Procedure

1. Confirm that the cluster recognizes the machines:

```
$ oc get nodes
```

#### Example output

```
NAME      STATUS    ROLES    AGE   VERSION
master-0  Ready    master   63m   v1.23.0
master-1  Ready    master   63m   v1.23.0
master-2  Ready    master   64m   v1.23.0
```

The output lists all of the machines that you created.

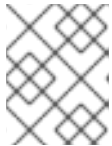

#### NOTE

The preceding output might not include the compute nodes, also known as worker nodes, until some CSRs are approved.

2. Review the pending CSRs and ensure that you see the client requests with the **Pending** or **Approved** status for each machine that you added to the cluster:

```
$ oc get csr
```

#### Example output

```
NAME      AGE   REQUESTOR                                     CONDITION
csr-8b2br  15m   system:serviceaccount:openshift-machine-config-operator:node-
bootstrapper  Pending
csr-8vnps  15m   system:serviceaccount:openshift-machine-config-operator:node-
bootstrapper  Pending
...
```

In this example, two machines are joining the cluster. You might see more approved CSRs in the list.

3. If the CSRs were not approved, after all of the pending CSRs for the machines you added are in **Pending** status, approve the CSRs for your cluster machines:

**NOTE**

Because the CSRs rotate automatically, approve your CSRs within an hour of adding the machines to the cluster. If you do not approve them within an hour, the certificates will rotate, and more than two certificates will be present for each node. You must approve all of these certificates. After the client CSR is approved, the Kubelet creates a secondary CSR for the serving certificate, which requires manual approval. Then, subsequent serving certificate renewal requests are automatically approved by the **machine-approver** if the Kubelet requests a new certificate with identical parameters.

**NOTE**

For clusters running on platforms that are not machine API enabled, such as bare metal and other user-provisioned infrastructure, you must implement a method of automatically approving the kubelet serving certificate requests (CSRs). If a request is not approved, then the **oc exec**, **oc rsh**, and **oc logs** commands cannot succeed, because a serving certificate is required when the API server connects to the kubelet. Any operation that contacts the Kubelet endpoint requires this certificate approval to be in place. The method must watch for new CSRs, confirm that the CSR was submitted by the **node-bootstrap** service account in the **system:node** or **system:admin** groups, and confirm the identity of the node.

- To approve them individually, run the following command for each valid CSR:

```
$ oc adm certificate approve <csr_name> 1
```

- 1** **<csr\_name>** is the name of a CSR from the list of current CSRs.

- To approve all pending CSRs, run the following command:

```
$ oc get csr -o go-template='{{range .items}}{{if not .status}}{{.metadata.name}}{"\n"}{{end}}{{end}}' | xargs --no-run-if-empty oc adm certificate approve
```

**NOTE**

Some Operators might not become available until some CSRs are approved.

- Now that your client requests are approved, you must review the server requests for each machine that you added to the cluster:

```
$ oc get csr
```

**Example output**

```
NAME          AGE   REQUESTOR                                     CONDITION
csr-bfd72     5m26s system:node:ip-10-0-50-126.us-east-2.compute.internal
Pending
csr-c57lv     5m26s system:node:ip-10-0-95-157.us-east-2.compute.internal
Pending
...
```



5. If the remaining CSRs are not approved, and are in the **Pending** status, approve the CSRs for your cluster machines:

- To approve them individually, run the following command for each valid CSR:

```
$ oc adm certificate approve <csr_name> 1
```

**1** **<csr\_name>** is the name of a CSR from the list of current CSRs.

- To approve all pending CSRs, run the following command:

```
$ oc get csr -o go-template='{{range .items}}{{if not .status}}{{.metadata.name}}{\n"}\n{{end}}' | xargs oc adm certificate approve
```

6. After all client and server CSRs have been approved, the machines have the **Ready** status. Verify this by running the following command:

```
$ oc get nodes
```

### Example output

```
NAME      STATUS  ROLES  AGE  VERSION
master-0  Ready   master 73m  v1.23.0
master-1  Ready   master 73m  v1.23.0
master-2  Ready   master 74m  v1.23.0
worker-0  Ready   worker 11m  v1.23.0
worker-1  Ready   worker 11m  v1.23.0
```

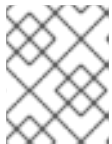

### NOTE

It can take a few minutes after approval of the server CSRs for the machines to transition to the **Ready** status.

### Additional information

- For more information on CSRs, see [Certificate Signing Requests](#).

## 20.5.21. Initial Operator configuration

After the control plane initializes, you must immediately configure some Operators so that they all become available.

### Prerequisites

- Your control plane has initialized.

### Procedure

1. Watch the cluster components come online:

```
$ watch -n5 oc get clusteroperators
```

**Example output**

NAME	VERSION	AVAILABLE	PROGRESSING	DEGRADED	SINCE
authentication	4.10.0	True	False	False	19m
baremetal	4.10.0	True	False	False	37m
cloud-credential	4.10.0	True	False	False	40m
cluster-autoscaler	4.10.0	True	False	False	37m
config-operator	4.10.0	True	False	False	38m
console	4.10.0	True	False	False	26m
csi-snapshot-controller	4.10.0	True	False	False	37m
dns	4.10.0	True	False	False	37m
etcd	4.10.0	True	False	False	36m
image-registry	4.10.0	True	False	False	31m
ingress	4.10.0	True	False	False	30m
insights	4.10.0	True	False	False	31m
kube-apiserver	4.10.0	True	False	False	26m
kube-controller-manager	4.10.0	True	False	False	36m
kube-scheduler	4.10.0	True	False	False	36m
kube-storage-version-migrator	4.10.0	True	False	False	37m
machine-api	4.10.0	True	False	False	29m
machine-approver	4.10.0	True	False	False	37m
machine-config	4.10.0	True	False	False	36m
marketplace	4.10.0	True	False	False	37m
monitoring	4.10.0	True	False	False	29m
network	4.10.0	True	False	False	38m
node-tuning	4.10.0	True	False	False	37m
openshift-apiserver	4.10.0	True	False	False	32m
openshift-controller-manager	4.10.0	True	False	False	30m
openshift-samples	4.10.0	True	False	False	32m
operator-lifecycle-manager	4.10.0	True	False	False	37m
operator-lifecycle-manager-catalog	4.10.0	True	False	False	37m
operator-lifecycle-manager-packageserver	4.10.0	True	False	False	32m
service-ca	4.10.0	True	False	False	38m
storage	4.10.0	True	False	False	37m

2. Configure the Operators that are not available.

**20.5.21.1. Image registry removed during installation**

On platforms that do not provide shareable object storage, the OpenShift Image Registry Operator bootstraps itself as **Removed**. This allows **openshift-installer** to complete installations on these platform types.

After installation, you must edit the Image Registry Operator configuration to switch the **managementState** from **Removed** to **Managed**.

**20.5.21.2. Image registry storage configuration**

The Image Registry Operator is not initially available for platforms that do not provide default storage. After installation, you must configure your registry to use storage so that the Registry Operator is made available.

Instructions are shown for configuring a persistent volume, which is required for production clusters. Where applicable, instructions are shown for configuring an empty directory as the storage location, which is available for only non-production clusters.

Additional instructions are provided for allowing the image registry to use block storage types by using the **Recreate** rollout strategy during upgrades.

### 20.5.21.2.1. Configuring registry storage for VMware vSphere

As a cluster administrator, following installation you must configure your registry to use storage.

#### Prerequisites

- Cluster administrator permissions.
- A cluster on VMware vSphere.
- Persistent storage provisioned for your cluster, such as Red Hat OpenShift Data Foundation.

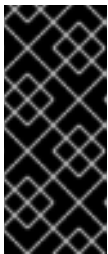

#### IMPORTANT

OpenShift Container Platform supports **ReadWriteOnce** access for image registry storage when you have only one replica. **ReadWriteOnce** access also requires that the registry uses the **Recreate** rollout strategy. To deploy an image registry that supports high availability with two or more replicas, **ReadWriteMany** access is required.

- Must have "100Gi" capacity.

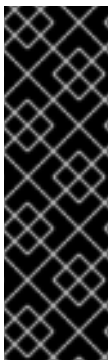

#### IMPORTANT

Testing shows issues with using the NFS server on RHEL as storage backend for core services. This includes the OpenShift Container Registry and Quay, Prometheus for monitoring storage, and Elasticsearch for logging storage. Therefore, using RHEL NFS to back PVs used by core services is not recommended.

Other NFS implementations on the marketplace might not have these issues. Contact the individual NFS implementation vendor for more information on any testing that was possibly completed against these OpenShift Container Platform core components.

#### Procedure

1. To configure your registry to use storage, change the **spec.storage.pvc** in the **configs.imageregistry/cluster** resource.



#### NOTE

When using shared storage, review your security settings to prevent outside access.

2. Verify that you do not have a registry pod:

```
$ oc get pod -n openshift-image-registry -l docker-registry=default
```

### Example output

```
No resources found in openshift-image-registry namespace
```



#### NOTE

If you do have a registry pod in your output, you do not need to continue with this procedure.

3. Check the registry configuration:

```
$ oc edit configs.imageregistry.operator.openshift.io
```

### Example output

```
storage:
  pvc:
    claim: 1
```

- 1 Leave the **claim** field blank to allow the automatic creation of an **image-registry-storage** persistent volume claim (PVC). The PVC is generated based on the default storage class. However, be aware that the default storage class might provide ReadWriteOnce (RWO) volumes, such as a RADOS Block Device (RBD), which can cause issues when replicating to more than one replica.

4. Check the **clusteroperator** status:

```
$ oc get clusteroperator image-registry
```

### Example output

NAME	VERSION	AVAILABLE	PROGRESSING	DEGRADED
image-registry	4.7	True	False	False 6h50m

#### 20.5.21.2.2. Configuring storage for the image registry in non-production clusters

You must configure storage for the Image Registry Operator. For non-production clusters, you can set the image registry to an empty directory. If you do so, all images are lost if you restart the registry.

#### Procedure

- To set the image registry storage to an empty directory:

```
$ oc patch configs.imageregistry.operator.openshift.io cluster --type merge --patch '{"spec": {"storage":{"emptyDir":{}}}'
```

**WARNING**

Configure this option for only non-production clusters.

If you run this command before the Image Registry Operator initializes its components, the **oc patch** command fails with the following error:

```
Error from server (NotFound): configs.imageregistry.operator.openshift.io "cluster" not found
```

Wait a few minutes and run the command again.

### 20.5.21.2.3. Configuring block registry storage for VMware vSphere

To allow the image registry to use block storage types such as vSphere Virtual Machine Disk (VMDK) during upgrades as a cluster administrator, you can use the **Recreate** rollout strategy.

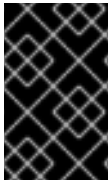
**IMPORTANT**

Block storage volumes are supported but not recommended for use with image registry on production clusters. An installation where the registry is configured on block storage is not highly available because the registry cannot have more than one replica.

**Procedure**

1. To set the image registry storage as a block storage type, patch the registry so that it uses the **Recreate** rollout strategy and runs with only **1** replica:

```
$ oc patch config.imageregistry.operator.openshift.io/cluster --type=merge -p '{"spec": {"rolloutStrategy": "Recreate", "replicas": 1}}'
```

2. Provision the PV for the block storage device, and create a PVC for that volume. The requested block volume uses the ReadWriteOnce (RWO) access mode.

- a. Create a **pvc.yaml** file with the following contents to define a VMware vSphere **PersistentVolumeClaim** object:

```
kind: PersistentVolumeClaim
apiVersion: v1
metadata:
  name: image-registry-storage 1
  namespace: openshift-image-registry 2
spec:
  accessModes:
  - ReadWriteOnce 3
  resources:
    requests:
      storage: 100Gi 4
```

- 1** A unique name that represents the **PersistentVolumeClaim** object.

- 2 The namespace for the **PersistentVolumeClaim** object, which is **openshift-image-registry**.
- 3 The access mode of the persistent volume claim. With **ReadWriteOnce**, the volume can be mounted with read and write permissions by a single node.
- 4 The size of the persistent volume claim.

b. Create the **PersistentVolumeClaim** object from the file:

```
$ oc create -f pvc.yaml -n openshift-image-registry
```

3. Edit the registry configuration so that it references the correct PVC:

```
$ oc edit config.imageregistry.operator.openshift.io -o yaml
```

### Example output

```
storage:
  pvc:
    claim: 1
```

- 1 Creating a custom PVC allows you to leave the **claim** field blank for the default automatic creation of an **image-registry-storage** PVC.

For instructions about configuring registry storage so that it references the correct PVC, see [Configuring the registry for vSphere](#).

## 20.5.22. Completing installation on user-provisioned infrastructure

After you complete the Operator configuration, you can finish installing the cluster on infrastructure that you provide.

### Prerequisites

- Your control plane has initialized.
- You have completed the initial Operator configuration.

### Procedure

1. Confirm that all the cluster components are online with the following command:

```
$ watch -n5 oc get clusteroperators
```

### Example output

NAME	VERSION	AVAILABLE	PROGRESSING	DEGRADED
authentication	4.10.0	True	False	False 19m
baremetal	4.10.0	True	False	False 37m

cloud-credential	4.10.0	True	False	False	40m
cluster-autoscaler	4.10.0	True	False	False	37m
config-operator	4.10.0	True	False	False	38m
console	4.10.0	True	False	False	26m
csi-snapshot-controller	4.10.0	True	False	False	37m
dns	4.10.0	True	False	False	37m
etcd	4.10.0	True	False	False	36m
image-registry	4.10.0	True	False	False	31m
ingress	4.10.0	True	False	False	30m
insights	4.10.0	True	False	False	31m
kube-apiserver	4.10.0	True	False	False	26m
kube-controller-manager	4.10.0	True	False	False	36m
kube-scheduler	4.10.0	True	False	False	36m
kube-storage-version-migrator	4.10.0	True	False	False	37m
machine-api	4.10.0	True	False	False	29m
machine-approver	4.10.0	True	False	False	37m
machine-config	4.10.0	True	False	False	36m
marketplace	4.10.0	True	False	False	37m
monitoring	4.10.0	True	False	False	29m
network	4.10.0	True	False	False	38m
node-tuning	4.10.0	True	False	False	37m
openshift-apiserver	4.10.0	True	False	False	32m
openshift-controller-manager	4.10.0	True	False	False	30m
openshift-samples	4.10.0	True	False	False	32m
operator-lifecycle-manager	4.10.0	True	False	False	37m
operator-lifecycle-manager-catalog	4.10.0	True	False	False	37m
operator-lifecycle-manager-packageserver	4.10.0	True	False	False	32m
service-ca	4.10.0	True	False	False	38m
storage	4.10.0	True	False	False	37m

Alternatively, the following command notifies you when all of the clusters are available. It also retrieves and displays credentials:

```
$ ./openshift-install --dir <installation_directory> wait-for install-complete 1
```

- 1** For **<installation\_directory>**, specify the path to the directory that you stored the installation files in.

### Example output

```
INFO Waiting up to 30m0s for the cluster to initialize...
```

The command succeeds when the Cluster Version Operator finishes deploying the OpenShift Container Platform cluster from Kubernetes API server.



## IMPORTANT

- The Ignition config files that the installation program generates contain certificates that expire after 24 hours, which are then renewed at that time. If the cluster is shut down before renewing the certificates and the cluster is later restarted after the 24 hours have elapsed, the cluster automatically recovers the expired certificates. The exception is that you must manually approve the pending **node-bootstrapper** certificate signing requests (CSRs) to recover kubelet certificates. See the documentation for *Recovering from expired control plane certificates* for more information.
- It is recommended that you use Ignition config files within 12 hours after they are generated because the 24-hour certificate rotates from 16 to 22 hours after the cluster is installed. By using the Ignition config files within 12 hours, you can avoid installation failure if the certificate update runs during installation.

2. Confirm that the Kubernetes API server is communicating with the pods.

a. To view a list of all pods, use the following command:

```
$ oc get pods --all-namespaces
```

### Example output

```

NAMESPACE           NAME                                     READY  STATUS
RESTARTS  AGE
openshift-apiserver-operator  openshift-apiserver-operator-85cb746d55-zqhs8  1/1
Running  1      9m
openshift-apiserver          apiserver-67b9g                                1/1  Running  0
3m
openshift-apiserver          apiserver-ljcmx                                1/1  Running  0
1m
openshift-apiserver          apiserver-z25h4                                1/1  Running  0
2m
openshift-authentication-operator  authentication-operator-69d5d8bf84-vh2n8      1/1
Running  0      5m
...

```

b. View the logs for a pod that is listed in the output of the previous command by using the following command:

```
$ oc logs <pod_name> -n <namespace> 1
```

- 1** Specify the pod name and namespace, as shown in the output of the previous command.

If the pod logs display, the Kubernetes API server can communicate with the cluster machines.

3. For an installation with Fibre Channel Protocol (FCP), additional steps are required to enable multipathing. Do not enable multipathing during installation. See "Enabling multipathing with kernel arguments on RHCOS" in the *Post-installation machine configuration tasks* documentation for more information.



You can add extra compute machines after the cluster installation is completed by following [Adding compute machines to vSphere](#).

### 20.5.23. Configuring vSphere DRS anti-affinity rules for control plane nodes

vSphere Distributed Resource Scheduler (DRS) anti-affinity rules can be configured to support higher availability of OpenShift Container Platform control plane nodes. Anti-affinity rules ensure that the vSphere Virtual Machines for the OpenShift Container Platform control plane nodes are not scheduled to the same vSphere Host.

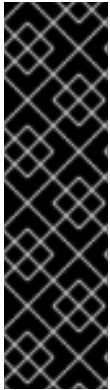

#### IMPORTANT

- The following information applies to compute DRS only and does not apply to storage DRS.
- The **govc** command is an open-source command available from VMware; it is not available from Red Hat. The **govc** command is not supported by the Red Hat support.
- Instructions for downloading and installing **govc** are found on the VMware documentation website.

Create an anti-affinity rule by running the following command:

#### Example command

```
$ govc cluster.rule.create \
  -name openshift4-control-plane-group \
  -dc MyDatacenter -cluster MyCluster \
  -enable \
  -anti-affinity master-0 master-1 master-2
```

After creating the rule, your control plane nodes are automatically migrated by vSphere so they are not running on the same hosts. This might take some time while vSphere reconciles the new rule. Successful command completion is shown in the following procedure.



#### NOTE

The migration occurs automatically and might cause brief OpenShift API outage or latency until the migration finishes.

The vSphere DRS anti-affinity rules need to be updated manually in the event of a control plane VM name change or migration to a new vSphere Cluster.

#### Procedure

1. Remove any existing DRS anti-affinity rule by running the following command:

```
$ govc cluster.rule.remove \
  -name openshift4-control-plane-group \
  -dc MyDatacenter -cluster MyCluster
```

#### Example Output

```
[13-10-22 09:33:24] Reconfigure /MyDatacenter/host/MyCluster...OK
```

2. Create the rule again with updated names by running the following command:

```
$ govc cluster.rule.create \  
-name openshift4-control-plane-group \  
-dc MyDatacenter -cluster MyOtherCluster \  
-enable \  
-anti-affinity master-0 master-1 master-2
```

### 20.5.24. Backing up VMware vSphere volumes

OpenShift Container Platform provisions new volumes as independent persistent disks to freely attach and detach the volume on any node in the cluster. As a consequence, it is not possible to back up volumes that use snapshots, or to restore volumes from snapshots. See [Snapshot Limitations](#) for more information.

#### Procedure

To create a backup of persistent volumes:

1. Stop the application that is using the persistent volume.
2. Clone the persistent volume.
3. Restart the application.
4. Create a backup of the cloned volume.
5. Delete the cloned volume.

### 20.5.25. Telemetry access for OpenShift Container Platform

In OpenShift Container Platform 4.10, the Telemetry service, which runs by default to provide metrics about cluster health and the success of updates, requires internet access. If your cluster is connected to the internet, Telemetry runs automatically, and your cluster is registered to [OpenShift Cluster Manager](#).

After you confirm that your [OpenShift Cluster Manager](#) inventory is correct, either maintained automatically by Telemetry or manually by using OpenShift Cluster Manager, [use subscription watch](#) to track your OpenShift Container Platform subscriptions at the account or multi-cluster level.

#### Additional resources

- See [About remote health monitoring](#) for more information about the Telemetry service

### 20.5.26. Next steps

- [Customize your cluster](#).
- If necessary, you can [opt out of remote health reporting](#).
- [Set up your registry and configure registry storage](#).
- Optional: [View the events from the vSphere Problem Detector Operator](#) to determine if the cluster has permission or storage configuration issues.

## 20.6. INSTALLING A CLUSTER ON VSPHERE WITH NETWORK CUSTOMIZATIONS

In OpenShift Container Platform version 4.10, you can install a cluster on VMware vSphere infrastructure that you provision with customized network configuration options. By customizing your network configuration, your cluster can coexist with existing IP address allocations in your environment and integrate with existing MTU and VXLAN configurations.

You must set most of the network configuration parameters during installation, and you can modify only **kubeProxy** configuration parameters in a running cluster.



### NOTE

OpenShift Container Platform supports deploying a cluster to a single VMware vCenter only. Deploying a cluster with machines/machine sets on multiple vCenters is not supported.



### IMPORTANT

The steps for performing a user-provisioned infrastructure installation are provided as an example only. Installing a cluster with infrastructure you provide requires knowledge of the vSphere platform and the installation process of OpenShift Container Platform. Use the user-provisioned infrastructure installation instructions as a guide; you are free to create the required resources through other methods.

### 20.6.1. Prerequisites

- You reviewed details about the [OpenShift Container Platform installation and update](#) processes.
- You read the documentation on [selecting a cluster installation method and preparing it for users](#).
- Completing the installation requires that you upload the Red Hat Enterprise Linux CoreOS (RHCOS) OVA on vSphere hosts. The machine from which you complete this process requires access to port 443 on the vCenter and ESXi hosts. Verify that port 443 is accessible.
- If you use a firewall, you confirmed with the administrator that port 443 is accessible. Control plane nodes must be able to reach vCenter and ESXi hosts on port 443 for the installation to succeed.
- If you use a firewall, you [configured it to allow the sites](#) that your cluster requires access to.

### 20.6.2. Internet access for OpenShift Container Platform

In OpenShift Container Platform 4.10, you require access to the internet to install your cluster.

You must have internet access to:

- Access [OpenShift Cluster Manager](#) to download the installation program and perform subscription management. If the cluster has internet access and you do not disable Telemetry, that service automatically entitles your cluster.
- Access [Quay.io](#) to obtain the packages that are required to install your cluster.

- Obtain the packages that are required to perform cluster updates.



### IMPORTANT

If your cluster cannot have direct internet access, you can perform a restricted network installation on some types of infrastructure that you provision. During that process, you download the required content and use it to populate a mirror registry with the installation packages. With some installation types, the environment that you install your cluster in will not require internet access. Before you update the cluster, you update the content of the mirror registry.

## 20.6.3. VMware vSphere infrastructure requirements

You must install the OpenShift Container Platform cluster on a VMware vSphere version 7 instance that meets the requirements for the components that you use.



### NOTE

OpenShift Container Platform version 4.10 does not support VMware vSphere version 8.0.

You can host the VMware vSphere infrastructure on-premise or on a [VMware Cloud Verified provider](#) that meets the requirements outlined in the following table:

**Table 20.48. Version requirements for vSphere virtual environments**

Virtual environment product	Required version
VM hardware version	15 or later
vSphere ESXi hosts	7
vCenter host	7

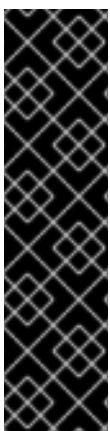

### IMPORTANT

Installing a cluster on VMware vSphere version 7.0 Update 1 is now deprecated. These versions are still fully supported, but version 4.10 of OpenShift Container Platform requires vSphere virtual hardware version 15 or later. Hardware version 15 is now the default for vSphere virtual machines in OpenShift Container Platform. To update the hardware version for your vSphere nodes, see the "Updating hardware on nodes running in vSphere" article.

If your vSphere nodes are below hardware version 15 or your VMware vSphere version is earlier than 6.7U3, upgrading from OpenShift Container Platform 4.10 to OpenShift Container Platform 4.11 is not available.

**Table 20.49. Minimum supported vSphere version for VMware components**

Component	Minimum supported versions	Description
Hypervisor	vSphere 7 with HW version 15	This version is the minimum version that Red Hat Enterprise Linux CoreOS (RHCOS) supports. For more information about supported hardware on the latest version of Red Hat Enterprise Linux (RHEL) that is compatible with RHCOS, see <a href="#">Hardware</a> on the Red Hat Customer Portal.
Storage with in-tree drivers	vSphere 7	This plugin creates vSphere storage by using the in-tree storage drivers for vSphere included in OpenShift Container Platform.
Optional: Networking (NSX-T)	vSphere 7	vSphere 7 is required for OpenShift Container Platform. For more information about the compatibility of NSX and OpenShift Container Platform, see the Release Notes section of VMware's <a href="#">NSX container plugin documentation</a> .

If you use a vSphere version 6.5 instance, upgrade to 7.0 before you install OpenShift Container Platform.



### IMPORTANT

You must ensure that the time on your ESXi hosts is synchronized before you install OpenShift Container Platform. See [Edit Time Configuration for a Host](#) in the VMware documentation.

## 20.6.4. VMware vSphere CSI Driver Operator requirements

To install the vSphere CSI Driver Operator, the following requirements must be met:

- VMware vSphere version 6.7U3 or later
- Virtual machines of hardware version 15 or later
- No third-party vSphere CSI driver already installed in the cluster



## IMPORTANT

If a third-party vSphere CSI driver is present in the cluster, OpenShift Container Platform does not overwrite it. If you continue with the third-party vSphere CSI driver when upgrading to the next major version of OpenShift Container Platform, the **oc** CLI prompts you with the following message:

```
VSphereCSIDriverOperatorCRUpgradeable: VMwareVSphereControllerUpgradeable:
found existing unsupported csi.vsphere.vmware.com driver
```

The previous message informs you that Red Hat does not support the third-party vSphere CSI driver during an OpenShift Container Platform upgrade operation. You can choose to ignore this message and continue with the upgrade operation.

### Additional resources

- To remove a third-party vSphere CSI driver, see [Removing a third-party vSphere CSI Driver](#).
- To update the hardware version for your vSphere nodes, see [Updating hardware on nodes running in vSphere](#).

## 20.6.5. Requirements for a cluster with user-provisioned infrastructure

For a cluster that contains user-provisioned infrastructure, you must deploy all of the required machines.

This section describes the requirements for deploying OpenShift Container Platform on user-provisioned infrastructure.

### 20.6.5.1. Required machines for cluster installation

The smallest OpenShift Container Platform clusters require the following hosts:

**Table 20.50. Minimum required hosts**

Hosts	Description
One temporary bootstrap machine	The cluster requires the bootstrap machine to deploy the OpenShift Container Platform cluster on the three control plane machines. You can remove the bootstrap machine after you install the cluster.
Three control plane machines	The control plane machines run the Kubernetes and OpenShift Container Platform services that form the control plane.
At least two compute machines, which are also known as worker machines.	The workloads requested by OpenShift Container Platform users run on the compute machines.



## IMPORTANT

To maintain high availability of your cluster, use separate physical hosts for these cluster machines.

The bootstrap and control plane machines must use Red Hat Enterprise Linux CoreOS (RHCOS) as the operating system. However, the compute machines can choose between Red Hat Enterprise Linux CoreOS (RHCOS), Red Hat Enterprise Linux (RHEL) 8.4, or RHEL 8.5.

Note that RHCOS is based on Red Hat Enterprise Linux (RHEL) 8 and inherits all of its hardware certifications and requirements. See [Red Hat Enterprise Linux technology capabilities and limits](#).

### 20.6.5.2. Minimum resource requirements for cluster installation

Each cluster machine must meet the following minimum requirements:

**Table 20.51. Minimum resource requirements**

Machine	Operating System	vCPU [1]	Virtual RAM	Storage	IOPS [2]
Bootstrap	RHCOS	4	16 GB	100 GB	300
Control plane	RHCOS	4	16 GB	100 GB	300
Compute	RHCOS, RHEL 8.4, or RHEL 8.5 <sup>[3]</sup>	2	8 GB	100 GB	300

1. One vCPU is equivalent to one physical core when simultaneous multithreading (SMT), or hyperthreading, is not enabled. When enabled, use the following formula to calculate the corresponding ratio: (threads per core × cores) × sockets = vCPUs.
2. OpenShift Container Platform and Kubernetes are sensitive to disk performance, and faster storage is recommended, particularly for etcd on the control plane nodes which require a 10 ms p99 fsync duration. Note that on many cloud platforms, storage size and IOPS scale together, so you might need to over-allocate storage volume to obtain sufficient performance.
3. As with all user-provisioned installations, if you choose to use RHEL compute machines in your cluster, you take responsibility for all operating system life cycle management and maintenance, including performing system updates, applying patches, and completing all other required tasks. Use of RHEL 7 compute machines is deprecated and has been removed in OpenShift Container Platform 4.10 and later.

If an instance type for your platform meets the minimum requirements for cluster machines, it is supported to use in OpenShift Container Platform.

### 20.6.5.3. Certificate signing requests management

Because your cluster has limited access to automatic machine management when you use infrastructure that you provision, you must provide a mechanism for approving cluster certificate signing requests (CSRs) after installation. The **kube-controller-manager** only approves the kubelet client CSRs. The **machine-approver** cannot guarantee the validity of a serving certificate that is requested by using kubelet credentials because it cannot confirm that the correct machine issued the request. You must determine and implement a method of verifying the validity of the kubelet serving certificate requests and approving them.

### 20.6.5.4. Networking requirements for user-provisioned infrastructure

All the Red Hat Enterprise Linux CoreOS (RHCOS) machines require networking to be configured in **initramfs** during boot to fetch their Ignition config files.

During the initial boot, the machines require an IP address configuration that is set either through a DHCP server or statically by providing the required boot options. After a network connection is established, the machines download their Ignition config files from an HTTP or HTTPS server. The Ignition config files are then used to set the exact state of each machine. The Machine Config Operator completes more changes to the machines, such as the application of new certificates or keys, after installation.

It is recommended to use a DHCP server for long-term management of the cluster machines. Ensure that the DHCP server is configured to provide persistent IP addresses, DNS server information, and hostnames to the cluster machines.



#### NOTE

If a DHCP service is not available for your user-provisioned infrastructure, you can instead provide the IP networking configuration and the address of the DNS server to the nodes at RHCOS install time. These can be passed as boot arguments if you are installing from an ISO image. See the *Installing RHCOS and starting the OpenShift Container Platform bootstrap process* section for more information about static IP provisioning and advanced networking options.

The Kubernetes API server must be able to resolve the node names of the cluster machines. If the API servers and worker nodes are in different zones, you can configure a default DNS search zone to allow the API server to resolve the node names. Another supported approach is to always refer to hosts by their fully-qualified domain names in both the node objects and all DNS requests.

#### 20.6.5.4.1. Setting the cluster node hostnames through DHCP

On Red Hat Enterprise Linux CoreOS (RHCOS) machines, the hostname is set through NetworkManager. By default, the machines obtain their hostname through DHCP. If the hostname is not provided by DHCP, set statically through kernel arguments, or another method, it is obtained through a reverse DNS lookup. Reverse DNS lookup occurs after the network has been initialized on a node and can take time to resolve. Other system services can start prior to this and detect the hostname as **localhost** or similar. You can avoid this by using DHCP to provide the hostname for each cluster node.

Additionally, setting the hostnames through DHCP can bypass any manual DNS record name configuration errors in environments that have a DNS split-horizon implementation.

#### 20.6.5.4.2. Network connectivity requirements

You must configure the network connectivity between machines to allow OpenShift Container Platform cluster components to communicate. Each machine must be able to resolve the hostnames of all other machines in the cluster.

This section provides details about the ports that are required.



#### IMPORTANT

In connected OpenShift Container Platform environments, all nodes are required to have internet access to pull images for platform containers and provide telemetry data to Red Hat.



Table 20.52. Ports used for all-machine to all-machine communications

Protocol	Port	Description
ICMP	N/A	Network reachability tests
TCP	<b>1936</b>	Metrics
	<b>9000-9999</b>	Host level services, including the node exporter on ports <b>9100-9101</b> and the Cluster Version Operator on port <b>9099</b> .
	<b>10250-10259</b>	The default ports that Kubernetes reserves
	<b>10256</b>	openshift-sdn
UDP	<b>4789</b>	VXLAN
	<b>6081</b>	Geneve
	<b>9000-9999</b>	Host level services, including the node exporter on ports <b>9100-9101</b> .
	<b>500</b>	IPsec IKE packets
	<b>4500</b>	IPsec NAT-T packets
TCP/UDP	<b>30000-32767</b>	Kubernetes node port
ESP	N/A	IPsec Encapsulating Security Payload (ESP)

Table 20.53. Ports used for all-machine to control plane communications

Protocol	Port	Description
TCP	<b>6443</b>	Kubernetes API

Table 20.54. Ports used for control plane machine to control plane machine communications

Protocol	Port	Description
TCP	<b>2379-2380</b>	etcd server and peer ports

### Ethernet adaptor hardware address requirements

When provisioning VMs for the cluster, the ethernet interfaces configured for each VM must use a MAC address from the VMware Organizationally Unique Identifier (OUI) allocation ranges:

- **00:05:69:00:00:00 to 00:05:69:FF:FF:FF**

- **00:0c:29:00:00:00** to **00:0c:29:FF:FF:FF**
- **00:1c:14:00:00:00** to **00:1c:14:FF:FF:FF**
- **00:50:56:00:00:00** to **00:50:56:3F:FF:FF**

If a MAC address outside the VMware OUI is used, the cluster installation will not succeed.

### NTP configuration for user-provisioned infrastructure

OpenShift Container Platform clusters are configured to use a public Network Time Protocol (NTP) server by default. If you want to use a local enterprise NTP server, or if your cluster is being deployed in a disconnected network, you can configure the cluster to use a specific time server. For more information, see the documentation for *Configuring chrony time service*.

If a DHCP server provides NTP server information, the chrony time service on the Red Hat Enterprise Linux CoreOS (RHCOS) machines read the information and can sync the clock with the NTP servers.

### Additional resources

- [Configuring chrony time service](#)

## 20.6.5.5. User-provisioned DNS requirements

In OpenShift Container Platform deployments, DNS name resolution is required for the following components:

- The Kubernetes API
- The OpenShift Container Platform application wildcard
- The bootstrap, control plane, and compute machines

Reverse DNS resolution is also required for the Kubernetes API, the bootstrap machine, the control plane machines, and the compute machines.

DNS A/AAAA or CNAME records are used for name resolution and PTR records are used for reverse name resolution. The reverse records are important because Red Hat Enterprise Linux CoreOS (RHCOS) uses the reverse records to set the hostnames for all the nodes, unless the hostnames are provided by DHCP. Additionally, the reverse records are used to generate the certificate signing requests (CSR) that OpenShift Container Platform needs to operate.



### NOTE

It is recommended to use a DHCP server to provide the hostnames to each cluster node. See the *DHCP recommendations for user-provisioned infrastructure* section for more information.

The following DNS records are required for a user-provisioned OpenShift Container Platform cluster and they must be in place before installation. In each record, **<cluster\_name>** is the cluster name and **<base\_domain>** is the base domain that you specify in the **install-config.yaml** file. A complete DNS record takes the form: **<component>.<cluster\_name>.<base\_domain>..**

### Table 20.55. Required DNS records

Component	Record	Description
Kubernetes API	<b>api.&lt;cluster_name&gt;.&lt;base_domain&gt;</b>	A DNS A/AAAA or CNAME record, and a DNS PTR record, to identify the API load balancer. These records must be resolvable by both clients external to the cluster and from all the nodes within the cluster.
	<b>api-int.&lt;cluster_name&gt;.&lt;base_domain&gt;</b>	<p>A DNS A/AAAA or CNAME record, and a DNS PTR record, to internally identify the API load balancer. These records must be resolvable from all the nodes within the cluster.</p> <div style="display: flex; align-items: flex-start;">  <div> <p><b>IMPORTANT</b></p> <p>The API server must be able to resolve the worker nodes by the hostnames that are recorded in Kubernetes. If the API server cannot resolve the node names, then proxied API calls can fail, and you cannot retrieve logs from pods.</p> </div> </div>
Routes	<b>*.apps.&lt;cluster_name&gt;.&lt;base_domain&gt;</b>	<p>A wildcard DNS A/AAAA or CNAME record that refers to the application ingress load balancer. The application ingress load balancer targets the machines that run the Ingress Controller pods. The Ingress Controller pods run on the compute machines by default. These records must be resolvable by both clients external to the cluster and from all the nodes within the cluster.</p> <p>For example, <b>console-openshift-console.apps.&lt;cluster_name&gt;.&lt;base_domain&gt;</b> is used as a wildcard route to the OpenShift Container Platform console.</p>
Bootstrap machine	<b>bootstrap.&lt;cluster_name&gt;.&lt;base_domain&gt;</b>	A DNS A/AAAA or CNAME record, and a DNS PTR record, to identify the bootstrap machine. These records must be resolvable by the nodes within the cluster.
Control plane machines	<b>&lt;master&gt;&lt;n&gt;.&lt;cluster_name&gt;.&lt;base_domain&gt;</b>	DNS A/AAAA or CNAME records and DNS PTR records to identify each machine for the control plane nodes. These records must be resolvable by the nodes within the cluster.
Compute machines	<b>&lt;worker&gt;&lt;n&gt;.&lt;cluster_name&gt;.&lt;base_domain&gt;</b>	DNS A/AAAA or CNAME records and DNS PTR records to identify each machine for the worker nodes. These records must be resolvable by the nodes within the cluster.

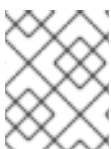
**NOTE**

In OpenShift Container Platform 4.4 and later, you do not need to specify etcd host and SRV records in your DNS configuration.

**TIP**

You can use the **dig** command to verify name and reverse name resolution. See the section on *Validating DNS resolution for user-provisioned infrastructure* for detailed validation steps.

**20.6.5.5.1. Example DNS configuration for user-provisioned clusters**

This section provides A and PTR record configuration samples that meet the DNS requirements for deploying OpenShift Container Platform on user-provisioned infrastructure. The samples are not meant to provide advice for choosing one DNS solution over another.

In the examples, the cluster name is **ocp4** and the base domain is **example.com**.

**Example DNS A record configuration for a user-provisioned cluster**

The following example is a BIND zone file that shows sample A records for name resolution in a user-provisioned cluster.

**Example 20.13. Sample DNS zone database**

```
$TTL 1W
@ IN SOA ns1.example.com. root (
  2019070700 ; serial
  3H ; refresh (3 hours)
  30M ; retry (30 minutes)
  2W ; expiry (2 weeks)
  1W ) ; minimum (1 week)
IN NS ns1.example.com.
IN MX 10 smtp.example.com.
;
;
ns1.example.com. IN A 192.168.1.5
smtp.example.com. IN A 192.168.1.5
;
helper.example.com. IN A 192.168.1.5
helper.ocp4.example.com. IN A 192.168.1.5
;
api.ocp4.example.com. IN A 192.168.1.5 ①
api-int.ocp4.example.com. IN A 192.168.1.5 ②
;
*.apps.ocp4.example.com. IN A 192.168.1.5 ③
;
bootstrap.ocp4.example.com. IN A 192.168.1.96 ④
;
master0.ocp4.example.com. IN A 192.168.1.97 ⑤
master1.ocp4.example.com. IN A 192.168.1.98 ⑥
master2.ocp4.example.com. IN A 192.168.1.99 ⑦
;
worker0.ocp4.example.com. IN A 192.168.1.11 ⑧
worker1.ocp4.example.com. IN A 192.168.1.7 ⑨
;
;EOF
```

- ① Provides name resolution for the Kubernetes API. The record refers to the IP address of the API load balancer.

- 2 Provides name resolution for the Kubernetes API. The record refers to the IP address of the API load balancer and is used for internal cluster communications.
- 3 Provides name resolution for the wildcard routes. The record refers to the IP address of the application ingress load balancer. The application ingress load balancer targets the machines that run the Ingress Controller pods. The Ingress Controller pods run on the compute machines by default.



#### NOTE

In the example, the same load balancer is used for the Kubernetes API and application ingress traffic. In production scenarios, you can deploy the API and application ingress load balancers separately so that you can scale the load balancer infrastructure for each in isolation.

- 4 Provides name resolution for the bootstrap machine.
- 5 6 7 Provides name resolution for the control plane machines.
- 8 9 Provides name resolution for the compute machines.

### Example DNS PTR record configuration for a user-provisioned cluster

The following example BIND zone file shows sample PTR records for reverse name resolution in a user-provisioned cluster.

#### Example 20.14. Sample DNS zone database for reverse records

```
$TTL 1W
@ IN SOA ns1.example.com. root (
    2019070700 ; serial
    3H ; refresh (3 hours)
    30M ; retry (30 minutes)
    2W ; expiry (2 weeks)
    1W ) ; minimum (1 week)
IN NS ns1.example.com.
;
5.1.168.192.in-addr.arpa. IN PTR api.ocp4.example.com. 1
5.1.168.192.in-addr.arpa. IN PTR api-int.ocp4.example.com. 2
;
96.1.168.192.in-addr.arpa. IN PTR bootstrap.ocp4.example.com. 3
;
97.1.168.192.in-addr.arpa. IN PTR master0.ocp4.example.com. 4
98.1.168.192.in-addr.arpa. IN PTR master1.ocp4.example.com. 5
99.1.168.192.in-addr.arpa. IN PTR master2.ocp4.example.com. 6
;
11.1.168.192.in-addr.arpa. IN PTR worker0.ocp4.example.com. 7
7.1.168.192.in-addr.arpa. IN PTR worker1.ocp4.example.com. 8
;
;EOF
```

- 1 Provides reverse DNS resolution for the Kubernetes API. The PTR record refers to the record name of the API load balancer.
- 2 Provides reverse DNS resolution for the Kubernetes API. The PTR record refers to the record name of the API load balancer and is used for internal cluster communications.
- 3 Provides reverse DNS resolution for the bootstrap machine.
- 4 5 6 Provides reverse DNS resolution for the control plane machines.
- 7 8 Provides reverse DNS resolution for the compute machines.

**NOTE**

A PTR record is not required for the OpenShift Container Platform application wildcard.

### 20.6.5.6. Load balancing requirements for user-provisioned infrastructure

Before you install OpenShift Container Platform, you must provision the API and application ingress load balancing infrastructure. In production scenarios, you can deploy the API and application ingress load balancers separately so that you can scale the load balancer infrastructure for each in isolation.

**NOTE**

If you want to deploy the API and application Ingress load balancers with a Red Hat Enterprise Linux (RHEL) instance, you must purchase the RHEL subscription separately.

The load balancing infrastructure must meet the following requirements:

1. **API load balancer.** Provides a common endpoint for users, both human and machine, to interact with and configure the platform. Configure the following conditions:
  - Layer 4 load balancing only. This can be referred to as Raw TCP, SSL Passthrough, or SSL Bridge mode. If you use SSL Bridge mode, you must enable Server Name Indication (SNI) for the API routes.
  - A stateless load balancing algorithm. The options vary based on the load balancer implementation.

**IMPORTANT**

Do not configure session persistence for an API load balancer. Configuring session persistence for a Kubernetes API server might cause performance issues from excess application traffic for your OpenShift Container Platform cluster and the Kubernetes API that runs inside the cluster.

Configure the following ports on both the front and back of the load balancers:

**Table 20.56. API load balancer**

Port	Back-end machines (pool members)	Internal	External	Description
6443	Bootstrap and control plane. You remove the bootstrap machine from the load balancer after the bootstrap machine initializes the cluster control plane. You must configure the <b>/readyz</b> endpoint for the API server health check probe.	X	X	Kubernetes API server
22623	Bootstrap and control plane. You remove the bootstrap machine from the load balancer after the bootstrap machine initializes the cluster control plane.	X		Machine config server



### NOTE

The load balancer must be configured to take a maximum of 30 seconds from the time the API server turns off the **/readyz** endpoint to the removal of the API server instance from the pool. Within the time frame after **/readyz** returns an error or becomes healthy, the endpoint must have been removed or added. Probing every 5 or 10 seconds, with two successful requests to become healthy and three to become unhealthy, are well-tested values.

2. **Application Ingress load balancer.** Provides an ingress point for application traffic flowing in from outside the cluster. A working configuration for the Ingress router is required for an OpenShift Container Platform cluster.

Configure the following conditions:

- Layer 4 load balancing only. This can be referred to as Raw TCP, SSL Passthrough, or SSL Bridge mode. If you use SSL Bridge mode, you must enable Server Name Indication (SNI) for the ingress routes.
- A connection-based or session-based persistence is recommended, based on the options available and types of applications that will be hosted on the platform.

### TIP

If the true IP address of the client can be seen by the application Ingress load balancer, enabling source IP-based session persistence can improve performance for applications that use end-to-end TLS encryption.

Configure the following ports on both the front and back of the load balancers:

**Table 20.57. Application Ingress load balancer**

Port	Back-end machines (pool members)	Internal	External	Description
------	----------------------------------	----------	----------	-------------

Port	Back-end machines (pool members)	Internal	External	Description
<b>443</b>	The machines that run the Ingress Controller pods, compute, or worker, by default.	X	X	HTTPS traffic
<b>80</b>	The machines that run the Ingress Controller pods, compute, or worker, by default.	X	X	HTTP traffic

**NOTE**

If you are deploying a three-node cluster with zero compute nodes, the Ingress Controller pods run on the control plane nodes. In three-node cluster deployments, you must configure your application Ingress load balancer to route HTTP and HTTPS traffic to the control plane nodes.

#### 20.6.5.6.1. Example load balancer configuration for user-provisioned clusters

This section provides an example API and application ingress load balancer configuration that meets the load balancing requirements for user-provisioned clusters. The sample is an `/etc/haproxy/haproxy.cfg` configuration for an HAProxy load balancer. The example is not meant to provide advice for choosing one load balancing solution over another.

In the example, the same load balancer is used for the Kubernetes API and application ingress traffic. In production scenarios, you can deploy the API and application ingress load balancers separately so that you can scale the load balancer infrastructure for each in isolation.

**NOTE**

If you are using HAProxy as a load balancer and SELinux is set to **enforcing**, you must ensure that the HAProxy service can bind to the configured TCP port by running **setsebool -P haproxy\_connect\_any=1**.

#### Example 20.15. Sample API and application Ingress load balancer configuration

```
global
  log      127.0.0.1 local2
  pidfile  /var/run/haproxy.pid
  maxconn  4000
  daemon
defaults
  mode          http
  log           global
  option        dontlognull
  option http-server-close
  option        redispatch
  retries       3
  timeout http-request  10s
  timeout queue      1m
  timeout connect    10s
  timeout client     1m
```



```

timeout server      1m
timeout http-keep-alive 10s
timeout check      10s
maxconn            3000
listen api-server-6443 1
bind *:6443
mode tcp
server bootstrap bootstrap.ocp4.example.com:6443 check inter 1s backup 2
server master0 master0.ocp4.example.com:6443 check inter 1s
server master1 master1.ocp4.example.com:6443 check inter 1s
server master2 master2.ocp4.example.com:6443 check inter 1s
listen machine-config-server-22623 3
bind *:22623
mode tcp
server bootstrap bootstrap.ocp4.example.com:22623 check inter 1s backup 4
server master0 master0.ocp4.example.com:22623 check inter 1s
server master1 master1.ocp4.example.com:22623 check inter 1s
server master2 master2.ocp4.example.com:22623 check inter 1s
listen ingress-router-443 5
bind *:443
mode tcp
balance source
server worker0 worker0.ocp4.example.com:443 check inter 1s
server worker1 worker1.ocp4.example.com:443 check inter 1s
listen ingress-router-80 6
bind *:80
mode tcp
balance source
server worker0 worker0.ocp4.example.com:80 check inter 1s
server worker1 worker1.ocp4.example.com:80 check inter 1s

```

- 1** Port **6443** handles the Kubernetes API traffic and points to the control plane machines.
- 2** **4** The bootstrap entries must be in place before the OpenShift Container Platform cluster installation and they must be removed after the bootstrap process is complete.
- 3** Port **22623** handles the machine config server traffic and points to the control plane machines.
- 5** Port **443** handles the HTTPS traffic and points to the machines that run the Ingress Controller pods. The Ingress Controller pods run on the compute machines by default.
- 6** Port **80** handles the HTTP traffic and points to the machines that run the Ingress Controller pods. The Ingress Controller pods run on the compute machines by default.



#### NOTE

If you are deploying a three-node cluster with zero compute nodes, the Ingress Controller pods run on the control plane nodes. In three-node cluster deployments, you must configure your application Ingress load balancer to route HTTP and HTTPS traffic to the control plane nodes.

**TIP**

If you are using HAProxy as a load balancer, you can check that the **haproxy** process is listening on ports **6443**, **22623**, **443**, and **80** by running **netstat -nltp** on the HAProxy node.

**20.6.6. Preparing the user-provisioned infrastructure**

Before you install OpenShift Container Platform on user-provisioned infrastructure, you must prepare the underlying infrastructure.

This section provides details about the high-level steps required to set up your cluster infrastructure in preparation for an OpenShift Container Platform installation. This includes configuring IP networking and network connectivity for your cluster nodes, enabling the required ports through your firewall, and setting up the required DNS and load balancing infrastructure.

After preparation, your cluster infrastructure must meet the requirements outlined in the *Requirements for a cluster with user-provisioned infrastructure* section.

**Prerequisites**

- You have reviewed the [OpenShift Container Platform 4.x Tested Integrations](#) page.
- You have reviewed the infrastructure requirements detailed in the *Requirements for a cluster with user-provisioned infrastructure* section.

**Procedure**

1. If you are using DHCP to provide the IP networking configuration to your cluster nodes, configure your DHCP service.
  - a. Add persistent IP addresses for the nodes to your DHCP server configuration. In your configuration, match the MAC address of the relevant network interface to the intended IP address for each node.
  - b. When you use DHCP to configure IP addressing for the cluster machines, the machines also obtain the DNS server information through DHCP. Define the persistent DNS server address that is used by the cluster nodes through your DHCP server configuration.

**NOTE**

If you are not using a DHCP service, you must provide the IP networking configuration and the address of the DNS server to the nodes at RHCOS install time. These can be passed as boot arguments if you are installing from an ISO image. See the *Installing RHCOS and starting the OpenShift Container Platform bootstrap process* section for more information about static IP provisioning and advanced networking options.

- c. Define the hostnames of your cluster nodes in your DHCP server configuration. See the *Setting the cluster node hostnames through DHCP* section for details about hostname considerations.

**NOTE**

If you are not using a DHCP service, the cluster nodes obtain their hostname through a reverse DNS lookup.

2. Ensure that your network infrastructure provides the required network connectivity between the cluster components. See the *Networking requirements for user-provisioned infrastructure* section for details about the requirements.
3. Configure your firewall to enable the ports required for the OpenShift Container Platform cluster components to communicate. See *Networking requirements for user-provisioned infrastructure* section for details about the ports that are required.

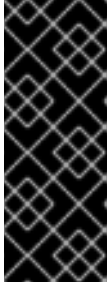

### IMPORTANT

By default, port **1936** is accessible for an OpenShift Container Platform cluster, because each control plane node needs access to this port.

Avoid using the Ingress load balancer to expose this port, because doing so might result in the exposure of sensitive information, such as statistics and metrics, related to Ingress Controllers.

4. Setup the required DNS infrastructure for your cluster.
  - a. Configure DNS name resolution for the Kubernetes API, the application wildcard, the bootstrap machine, the control plane machines, and the compute machines.
  - b. Configure reverse DNS resolution for the Kubernetes API, the bootstrap machine, the control plane machines, and the compute machines.  
See the *User-provisioned DNS requirements* section for more information about the OpenShift Container Platform DNS requirements.
5. Validate your DNS configuration.
  - a. From your installation node, run DNS lookups against the record names of the Kubernetes API, the wildcard routes, and the cluster nodes. Validate that the IP addresses in the responses correspond to the correct components.
  - b. From your installation node, run reverse DNS lookups against the IP addresses of the load balancer and the cluster nodes. Validate that the record names in the responses correspond to the correct components.  
See the *Validating DNS resolution for user-provisioned infrastructure* section for detailed DNS validation steps.
6. Provision the required API and application ingress load balancing infrastructure. See the *Load balancing requirements for user-provisioned infrastructure* section for more information about the requirements.



### NOTE

Some load balancing solutions require the DNS name resolution for the cluster nodes to be in place before the load balancing is initialized.

#### 20.6.7. Validating DNS resolution for user-provisioned infrastructure

You can validate your DNS configuration before installing OpenShift Container Platform on user-provisioned infrastructure.



## IMPORTANT

The validation steps detailed in this section must succeed before you install your cluster.

### Prerequisites

- You have configured the required DNS records for your user-provisioned infrastructure.

### Procedure

- From your installation node, run DNS lookups against the record names of the Kubernetes API, the wildcard routes, and the cluster nodes. Validate that the IP addresses contained in the responses correspond to the correct components.
  - Perform a lookup against the Kubernetes API record name. Check that the result points to the IP address of the API load balancer:

```
$ dig +noall +answer @<nameserver_ip> api.<cluster_name>.<base_domain> 1
```

- Replace **<nameserver\_ip>** with the IP address of the nameserver, **<cluster\_name>** with your cluster name, and **<base\_domain>** with your base domain name.

#### Example output

```
api.ocp4.example.com. 0 IN A 192.168.1.5
```

- Perform a lookup against the Kubernetes internal API record name. Check that the result points to the IP address of the API load balancer:

```
$ dig +noall +answer @<nameserver_ip> api-int.<cluster_name>.<base_domain>
```

#### Example output

```
api-int.ocp4.example.com. 0 IN A 192.168.1.5
```

- Test an example **\*.apps.<cluster\_name>.<base\_domain>** DNS wildcard lookup. All of the application wildcard lookups must resolve to the IP address of the application ingress load balancer:

```
$ dig +noall +answer @<nameserver_ip> random.apps.<cluster_name>.<base_domain>
```

#### Example output

```
random.apps.ocp4.example.com. 0 IN A 192.168.1.5
```



## NOTE

In the example outputs, the same load balancer is used for the Kubernetes API and application ingress traffic. In production scenarios, you can deploy the API and application ingress load balancers separately so that you can scale the load balancer infrastructure for each in isolation.

You can replace **random** with another wildcard value. For example, you can query the route to the OpenShift Container Platform console:

```
$ dig +noall +answer @<nameserver_ip> console-openshift-console.apps.
<cluster_name>.<base_domain>
```

### Example output

```
console-openshift-console.apps.ocp4.example.com. 0 IN A 192.168.1.5
```

- d. Run a lookup against the bootstrap DNS record name. Check that the result points to the IP address of the bootstrap node:

```
$ dig +noall +answer @<nameserver_ip> bootstrap.<cluster_name>.<base_domain>
```

### Example output

```
bootstrap.ocp4.example.com. 0 IN A 192.168.1.96
```

- e. Use this method to perform lookups against the DNS record names for the control plane and compute nodes. Check that the results correspond to the IP addresses of each node.
2. From your installation node, run reverse DNS lookups against the IP addresses of the load balancer and the cluster nodes. Validate that the record names contained in the responses correspond to the correct components.
    - a. Perform a reverse lookup against the IP address of the API load balancer. Check that the response includes the record names for the Kubernetes API and the Kubernetes internal API:

```
$ dig +noall +answer @<nameserver_ip> -x 192.168.1.5
```

### Example output

```
5.1.168.192.in-addr.arpa. 0 IN PTR api-int.ocp4.example.com. 1
5.1.168.192.in-addr.arpa. 0 IN PTR api.ocp4.example.com. 2
```

**1** Provides the record name for the Kubernetes internal API.

**2** Provides the record name for the Kubernetes API.



### NOTE

A PTR record is not required for the OpenShift Container Platform application wildcard. No validation step is needed for reverse DNS resolution against the IP address of the application ingress load balancer.

- b. Perform a reverse lookup against the IP address of the bootstrap node. Check that the result points to the DNS record name of the bootstrap node:

```
$ dig +noall +answer @<nameserver_ip> -x 192.168.1.96
```

## Example output

```
96.1.168.192.in-addr.arpa. 0 IN PTR bootstrap.ocp4.example.com.
```

- c. Use this method to perform reverse lookups against the IP addresses for the control plane and compute nodes. Check that the results correspond to the DNS record names of each node.

### 20.6.8. Generating a key pair for cluster node SSH access

During an OpenShift Container Platform installation, you can provide an SSH public key to the installation program. The key is passed to the Red Hat Enterprise Linux CoreOS (RHCOS) nodes through their Ignition config files and is used to authenticate SSH access to the nodes. The key is added to the `~/.ssh/authorized_keys` list for the **core** user on each node, which enables password-less authentication.

After the key is passed to the nodes, you can use the key pair to SSH in to the RHCOS nodes as the user **core**. To access the nodes through SSH, the private key identity must be managed by SSH for your local user.

If you want to SSH in to your cluster nodes to perform installation debugging or disaster recovery, you must provide the SSH public key during the installation process. The `./openshift-install gather` command also requires the SSH public key to be in place on the cluster nodes.



#### IMPORTANT

Do not skip this procedure in production environments, where disaster recovery and debugging is required.



#### NOTE

You must use a local key, not one that you configured with platform-specific approaches such as [AWS key pairs](#).

#### Procedure

1. If you do not have an existing SSH key pair on your local machine to use for authentication onto your cluster nodes, create one. For example, on a computer that uses a Linux operating system, run the following command:

```
$ ssh-keygen -t ed25519 -N "" -f <path>/<file_name> 1
```

- 1 Specify the path and file name, such as `~/.ssh/id_ed25519`, of the new SSH key. If you have an existing key pair, ensure your public key is in the your `~/.ssh` directory.



#### NOTE

If you plan to install an OpenShift Container Platform cluster that uses FIPS validated or Modules In Process cryptographic libraries on the **x86\_64** architecture, do not create a key that uses the **ed25519** algorithm. Instead, create a key that uses the **rsa** or **ecdsa** algorithm.

- View the public SSH key:

```
$ cat <path>/<file_name>.pub
```

For example, run the following to view the `~/.ssh/id_ed25519.pub` public key:

```
$ cat ~/.ssh/id_ed25519.pub
```

- Add the SSH private key identity to the SSH agent for your local user, if it has not already been added. SSH agent management of the key is required for password-less SSH authentication onto your cluster nodes, or if you want to use the `./openshift-install gather` command.



#### NOTE

On some distributions, default SSH private key identities such as `~/.ssh/id_rsa` and `~/.ssh/id_dsa` are managed automatically.

- If the `ssh-agent` process is not already running for your local user, start it as a background task:

```
$ eval "$(ssh-agent -s)"
```

#### Example output

```
Agent pid 31874
```



#### NOTE

If your cluster is in FIPS mode, only use FIPS-compliant algorithms to generate the SSH key. The key must be either RSA or ECDSA.

- Add your SSH private key to the `ssh-agent`:

```
$ ssh-add <path>/<file_name> 1
```

- 1** Specify the path and file name for your SSH private key, such as `~/.ssh/id_ed25519`

#### Example output

```
Identity added: /home/<you>/<path>/<file_name> (<computer_name>)
```

#### Next steps

- When you install OpenShift Container Platform, provide the SSH public key to the installation program.

### 20.6.9. Obtaining the installation program

Before you install OpenShift Container Platform, download the installation file on a local computer.

## Prerequisites

- You have a computer that runs Linux or macOS, with 500 MB of local disk space

## Procedure

1. Access the [Infrastructure Provider](#) page on the OpenShift Cluster Manager site. If you have a Red Hat account, log in with your credentials. If you do not, create an account.
2. Select your infrastructure provider.
3. Navigate to the page for your installation type, download the installation program that corresponds with your host operating system and architecture, and place the file in the directory where you will store the installation configuration files.



### IMPORTANT

The installation program creates several files on the computer that you use to install your cluster. You must keep the installation program and the files that the installation program creates after you finish installing the cluster. Both files are required to delete the cluster.



### IMPORTANT

Deleting the files created by the installation program does not remove your cluster, even if the cluster failed during installation. To remove your cluster, complete the OpenShift Container Platform uninstallation procedures for your specific cloud provider.

4. Extract the installation program. For example, on a computer that uses a Linux operating system, run the following command:

```
$ tar -xvf openshift-install-linux.tar.gz
```

5. Download your installation [pull secret from the Red Hat OpenShift Cluster Manager](#) . This pull secret allows you to authenticate with the services that are provided by the included authorities, including Quay.io, which serves the container images for OpenShift Container Platform components.

## 20.6.10. Manually creating the installation configuration file

For user-provisioned installations of OpenShift Container Platform, you manually generate your installation configuration file.

## Prerequisites

- You have an SSH public key on your local machine to provide to the installation program. The key will be used for SSH authentication onto your cluster nodes for debugging and disaster recovery.
- You have obtained the OpenShift Container Platform installation program and the pull secret for your cluster.

## Procedure



1. Create an installation directory to store your required installation assets in:

```
$ mkdir <installation_directory>
```



### IMPORTANT

You must create a directory. Some installation assets, like bootstrap X.509 certificates have short expiration intervals, so you must not reuse an installation directory. If you want to reuse individual files from another cluster installation, you can copy them into your directory. However, the file names for the installation assets might change between releases. Use caution when copying installation files from an earlier OpenShift Container Platform version.

2. Customize the sample **install-config.yaml** file template that is provided and save it in the **<installation\_directory>**.



### NOTE

You must name this configuration file **install-config.yaml**.



### NOTE

For some platform types, you can alternatively run **./openshift-install create install-config --dir <installation\_directory>** to generate an **install-config.yaml** file. You can provide details about your cluster configuration at the prompts.

3. Back up the **install-config.yaml** file so that you can use it to install multiple clusters.

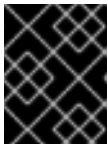

### IMPORTANT

The **install-config.yaml** file is consumed during the next step of the installation process. You must back it up now.

#### 20.6.10.1. Sample **install-config.yaml** file for VMware vSphere

You can customize the **install-config.yaml** file to specify more details about your OpenShift Container Platform cluster's platform or modify the values of the required parameters.

```
apiVersion: v1
baseDomain: example.com 1
compute: 2
- hyperthreading: Enabled 3
  name: worker
  replicas: 0 4
controlPlane: 5
  hyperthreading: Enabled 6
  name: master
  replicas: 3 7
metadata:
  name: test 8
platform:
  vsphere:
```

```

vcenter: your.vcenter.server 9
username: username 10
password: password 11
datacenter: datacenter 12
defaultDatastore: datastore 13
folder: "/<datacenter_name>/vm/<folder_name>/<subfolder_name>" 14
resourcePool: "/<datacenter_name>/host/<cluster_name>/Resources/<resource_pool_name>" 15
diskType: thin 16
fips: false 17
pullSecret: '{"auths": ...}' 18
sshKey: 'ssh-ed25519 AAAA...' 19

```

- 1** The base domain of the cluster. All DNS records must be sub-domains of this base and include the cluster name.
- 2** **5** The **controlPlane** section is a single mapping, but the compute section is a sequence of mappings. To meet the requirements of the different data structures, the first line of the **compute** section must begin with a hyphen, -, and the first line of the **controlPlane** section must not. Although both sections currently define a single machine pool, it is possible that future versions of OpenShift Container Platform will support defining multiple compute pools during installation. Only one control plane pool is used.
- 3** **6** Whether to enable or disable simultaneous multithreading, or **hyperthreading**. By default, simultaneous multithreading is enabled to increase the performance of your machines' cores. You can disable it by setting the parameter value to **Disabled**. If you disable simultaneous multithreading in some cluster machines, you must disable it in all cluster machines.



### IMPORTANT

If you disable simultaneous multithreading, ensure that your capacity planning accounts for the dramatically decreased machine performance. Your machines must use at least 8 CPUs and 32 GB of RAM if you disable simultaneous multithreading.

- 4** You must set the value of the **replicas** parameter to **0**. This parameter controls the number of workers that the cluster creates and manages for you, which are functions that the cluster does not perform when you use user-provisioned infrastructure. You must manually deploy worker machines for the cluster to use before you finish installing OpenShift Container Platform.
- 7** The number of control plane machines that you add to the cluster. Because the cluster uses this values as the number of etcd endpoints in the cluster, the value must match the number of control plane machines that you deploy.
- 8** The cluster name that you specified in your DNS records.
- 9** The fully-qualified hostname or IP address of the vCenter server.
- 10** The name of the user for accessing the server. This user must have at least the roles and privileges that are required for [static or dynamic persistent volume provisioning](#) in vSphere.
- 11** The password associated with the vSphere user.
- 12** The vSphere datacenter.
- 13** The default vSphere datastore to use.

- 14 Optional parameter: For installer-provisioned infrastructure, the absolute path of an existing folder where the installation program creates the virtual machines, for example,
- 15 Optional parameter: For installer-provisioned infrastructure, the absolute path of an existing resource pool where the installation program creates the virtual machines, for example, `/<datacenter_name>/host/<cluster_name>/Resources/<resource_pool_name>/<optional_nested_resource_pool_name>`. If you do not specify a value, resources are installed in the root of the cluster `/example_datacenter/host/example_cluster/Resources`.
- 16 The vSphere disk provisioning method.
- 17 Whether to enable or disable FIPS mode. By default, FIPS mode is not enabled. If FIPS mode is enabled, the Red Hat Enterprise Linux CoreOS (RHCOS) machines that OpenShift Container Platform runs on bypass the default Kubernetes cryptography suite and use the cryptography modules that are provided with RHCOS instead.



### IMPORTANT

To enable FIPS mode for your cluster, you must run the installation program from a Red Hat Enterprise Linux (RHEL) computer configured to operate in FIPS mode. For more information about configuring FIPS mode on RHEL, see [Installing the system in FIPS mode](#). The use of FIPS validated or Modules In Process cryptographic libraries is only supported on OpenShift Container Platform deployments on the **x86\_64** architecture.

- 18 The pull secret that you obtained from [OpenShift Cluster Manager](#). This pull secret allows you to authenticate with the services that are provided by the included authorities, including Quay.io, which serves the container images for OpenShift Container Platform components.
- 19 The public portion of the default SSH key for the **core** user in Red Hat Enterprise Linux CoreOS (RHCOS).

#### 20.6.10.2. Configuring the cluster-wide proxy during installation

Production environments can deny direct access to the internet and instead have an HTTP or HTTPS proxy available. You can configure a new OpenShift Container Platform cluster to use a proxy by configuring the proxy settings in the **install-config.yaml** file.

#### Prerequisites

- You have an existing **install-config.yaml** file.
- You reviewed the sites that your cluster requires access to and determined whether any of them need to bypass the proxy. By default, all cluster egress traffic is proxied, including calls to hosting cloud provider APIs. You added sites to the **Proxy** object's **spec.noProxy** field to bypass the proxy if necessary.



## NOTE

The **Proxy** object **status.noProxy** field is populated with the values of the **networking.machineNetwork[].cidr**, **networking.clusterNetwork[].cidr**, and **networking.serviceNetwork[]** fields from your installation configuration.

For installations on Amazon Web Services (AWS), Google Cloud Platform (GCP), Microsoft Azure, and Red Hat OpenStack Platform (RHOSP), the **Proxy** object **status.noProxy** field is also populated with the instance metadata endpoint (**169.254.169.254**).

## Procedure

1. Edit your **install-config.yaml** file and add the proxy settings. For example:

```
apiVersion: v1
baseDomain: my.domain.com
proxy:
  httpProxy: http://<username>:<pswd>@<ip>:<port> 1
  httpsProxy: https://<username>:<pswd>@<ip>:<port> 2
  noProxy: example.com 3
  additionalTrustBundle: | 4
    -----BEGIN CERTIFICATE-----
    <MY_TRUSTED_CA_CERT>
    -----END CERTIFICATE-----
  ...
```

- 1 A proxy URL to use for creating HTTP connections outside the cluster. The URL scheme must be **http**.
- 2 A proxy URL to use for creating HTTPS connections outside the cluster.
- 3 A comma-separated list of destination domain names, IP addresses, or other network CIDRs to exclude from proxying. Preface a domain with **.** to match subdomains only. For example, **.y.com** matches **x.y.com**, but not **y.com**. Use **\*** to bypass the proxy for all destinations. You must include vCenter's IP address and the IP range that you use for its machines.
- 4 If provided, the installation program generates a config map that is named **user-ca-bundle** in the **openshift-config** namespace that contains one or more additional CA certificates that are required for proxying HTTPS connections. The Cluster Network Operator then creates a **trusted-ca-bundle** config map that merges these contents with the Red Hat Enterprise Linux CoreOS (RHCOS) trust bundle, and this config map is referenced in the **trustedCA** field of the **Proxy** object. The **additionalTrustBundle** field is required unless the proxy's identity certificate is signed by an authority from the RHCOS trust bundle.

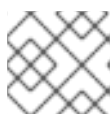

## NOTE

The installation program does not support the proxy **readinessEndpoints** field.

**NOTE**

If the installer times out, restart and then complete the deployment by using the **wait-for** command of the installer. For example:

```
$ ./openshift-install wait-for install-complete --log-level debug
```

2. Save the file and reference it when installing OpenShift Container Platform.

The installation program creates a cluster-wide proxy that is named **cluster** that uses the proxy settings in the provided **install-config.yaml** file. If no proxy settings are provided, a **cluster Proxy** object is still created, but it will have a nil **spec**.

**NOTE**

Only the **Proxy** object named **cluster** is supported, and no additional proxies can be created.

### 20.6.11. Network configuration phases

There are two phases prior to OpenShift Container Platform installation where you can customize the network configuration.

#### Phase 1

You can customize the following network-related fields in the **install-config.yaml** file before you create the manifest files:

- **networking.networkType**
- **networking.clusterNetwork**
- **networking.serviceNetwork**
- **networking.machineNetwork**

For more information on these fields, refer to *Installation configuration parameters*.

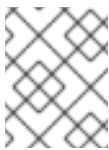
**NOTE**

Set the **networking.machineNetwork** to match the CIDR that the preferred NIC resides in.

**IMPORTANT**

The CIDR range **172.17.0.0/16** is reserved by libVirt. You cannot use this range or any range that overlaps with this range for any networks in your cluster.

#### Phase 2

After creating the manifest files by running **openshift-install create manifests**, you can define a customized Cluster Network Operator manifest with only the fields you want to modify. You can use the manifest to specify advanced network configuration.

You cannot override the values specified in phase 1 in the **install-config.yaml** file during phase 2. However, you can further customize the cluster network provider during phase 2.

## 20.6.12. Specifying advanced network configuration

You can use advanced network configuration for your cluster network provider to integrate your cluster into your existing network environment. You can specify advanced network configuration only before you install the cluster.



### IMPORTANT

Customizing your network configuration by modifying the OpenShift Container Platform manifest files created by the installation program is not supported. Applying a manifest file that you create, as in the following procedure, is supported.

### Prerequisites

- You have created the **install-config.yaml** file and completed any modifications to it.

### Procedure

- Change to the directory that contains the installation program and create the manifests:

```
$ ./openshift-install create manifests --dir <installation_directory> 1
```

- 1** **<installation\_directory>** specifies the name of the directory that contains the **install-config.yaml** file for your cluster.

- Create a stub manifest file for the advanced network configuration that is named **cluster-network-03-config.yml** in the **<installation\_directory>/manifests/** directory:

```
apiVersion: operator.openshift.io/v1
kind: Network
metadata:
  name: cluster
spec:
```

- Specify the advanced network configuration for your cluster in the **cluster-network-03-config.yml** file, such as in the following examples:

#### Specify a different VXLAN port for the OpenShift SDN network provider

```
apiVersion: operator.openshift.io/v1
kind: Network
metadata:
  name: cluster
spec:
  defaultNetwork:
    openshiftSDNConfig:
      vxlanPort: 4800
```

#### Enable IPsec for the OVN-Kubernetes network provider

■

```

apiVersion: operator.openshift.io/v1
kind: Network
metadata:
  name: cluster
spec:
  defaultNetwork:
    ovnKubernetesConfig:
      ipsecConfig: {}

```

- Optional: Back up the **manifests/cluster-network-03-config.yml** file. The installation program consumes the **manifests/** directory when you create the Ignition config files.
- Remove the Kubernetes manifest files that define the control plane machines and compute machineSets:

```

$ rm -f openshift/99_openshift-cluster-api_master-machines-*.yaml openshift/99_openshift-cluster-api_worker-machineset-*.yaml

```

Because you create and manage these resources yourself, you do not have to initialize them.

- You can preserve the MachineSet files to create compute machines by using the machine API, but you must update references to them to match your environment.

### 20.6.13. Cluster Network Operator configuration

The configuration for the cluster network is specified as part of the Cluster Network Operator (CNO) configuration and stored in a custom resource (CR) object that is named **cluster**. The CR specifies the fields for the **Network** API in the **operator.openshift.io** API group.

The CNO configuration inherits the following fields during cluster installation from the **Network** API in the **Network.config.openshift.io** API group and these fields cannot be changed:

#### **clusterNetwork**

IP address pools from which pod IP addresses are allocated.

#### **serviceNetwork**

IP address pool for services.

#### **defaultNetwork.type**

Cluster network provider, such as OpenShift SDN or OVN-Kubernetes.

You can specify the cluster network provider configuration for your cluster by setting the fields for the **defaultNetwork** object in the CNO object named **cluster**.

#### 20.6.13.1. Cluster Network Operator configuration object

The fields for the Cluster Network Operator (CNO) are described in the following table:

**Table 20.58. Cluster Network Operator configuration object**

Field	Type	Description
<b>metadata.name</b>	<b>string</b>	The name of the CNO object. This name is always <b>cluster</b> .

Field	Type	Description
<b>spec.clusterNetwork</b>	<b>array</b>	<p>A list specifying the blocks of IP addresses from which pod IP addresses are allocated and the subnet prefix length assigned to each individual node in the cluster. For example:</p> <pre>spec:   clusterNetwork:   - cidr: 10.128.0.0/19     hostPrefix: 23   - cidr: 10.128.32.0/19     hostPrefix: 23</pre> <p>You can customize this field only in the <b>install-config.yaml</b> file before you create the manifests. The value is read-only in the manifest file.</p>
<b>spec.serviceNetwork</b>	<b>array</b>	<p>A block of IP addresses for services. The OpenShift SDN and OVN-Kubernetes Container Network Interface (CNI) network providers support only a single IP address block for the service network. For example:</p> <pre>spec:   serviceNetwork:   - 172.30.0.0/14</pre> <p>You can customize this field only in the <b>install-config.yaml</b> file before you create the manifests. The value is read-only in the manifest file.</p>
<b>spec.defaultNetwork</b>	<b>object</b>	Configures the Container Network Interface (CNI) cluster network provider for the cluster network.
<b>spec.kubeProxy</b> <b>Config</b>	<b>object</b>	The fields for this object specify the kube-proxy configuration. If you are using the OVN-Kubernetes cluster network provider, the kube-proxy configuration has no effect.

### defaultNetwork object configuration

The values for the **defaultNetwork** object are defined in the following table:

Table 20.59. **defaultNetwork** object

Field	Type	Description
-------	------	-------------



Field	Type	Description
<b>type</b>	<b>string</b>	<p>Either <b>OpenShiftSDN</b> or <b>OVNKubernetes</b>. The cluster network provider is selected during installation. This value cannot be changed after cluster installation.</p> <div style="display: flex; align-items: flex-start;"> <div style="flex: 1;">  </div> <div style="flex: 2;"> <p><b>NOTE</b></p> <p>OpenShift Container Platform uses the OpenShift SDN Container Network Interface (CNI) cluster network provider by default.</p> </div> </div>
<b>openshiftSDNConfig</b>	<b>object</b>	This object is only valid for the OpenShift SDN cluster network provider.
<b>ovnKubernetesConfig</b>	<b>object</b>	This object is only valid for the OVN-Kubernetes cluster network provider.

#### Configuration for the OpenShift SDN CNI cluster network provider

The following table describes the configuration fields for the OpenShift SDN Container Network Interface (CNI) cluster network provider.

Table 20.60. **openshiftSDNConfig** object

Field	Type	Description
<b>mode</b>	<b>string</b>	<p>Configures the network isolation mode for OpenShift SDN. The default value is <b>NetworkPolicy</b>.</p> <p>The values <b>Multitenant</b> and <b>Subnet</b> are available for backwards compatibility with OpenShift Container Platform 3.x but are not recommended. This value cannot be changed after cluster installation.</p>

Field	Type	Description
<b>mtu</b>	<b>integer</b>	<p>The maximum transmission unit (MTU) for the VXLAN overlay network. This is detected automatically based on the MTU of the primary network interface. You do not normally need to override the detected MTU.</p> <p>If the auto-detected value is not what you expect it to be, confirm that the MTU on the primary network interface on your nodes is correct. You cannot use this option to change the MTU value of the primary network interface on the nodes.</p> <p>If your cluster requires different MTU values for different nodes, you must set this value to <b>50</b> less than the lowest MTU value in your cluster. For example, if some nodes in your cluster have an MTU of <b>9001</b>, and some have an MTU of <b>1500</b>, you must set this value to <b>1450</b>.</p> <p>This value cannot be changed after cluster installation.</p>
<b>vxlanPort</b>	<b>integer</b>	<p>The port to use for all VXLAN packets. The default value is <b>4789</b>. This value cannot be changed after cluster installation.</p> <p>If you are running in a virtualized environment with existing nodes that are part of another VXLAN network, then you might be required to change this. For example, when running an OpenShift SDN overlay on top of VMware NSX-T, you must select an alternate port for the VXLAN, because both SDNs use the same default VXLAN port number.</p> <p>On Amazon Web Services (AWS), you can select an alternate port for the VXLAN between port <b>9000</b> and port <b>9999</b>.</p>

### Example OpenShift SDN configuration

```
defaultNetwork:
  type: OpenShiftSDN
  openshiftSDNConfig:
    mode: NetworkPolicy
    mtu: 1450
    vxlanPort: 4789
```

### Configuration for the OVN-Kubernetes CNI cluster network provider

The following table describes the configuration fields for the OVN-Kubernetes CNI cluster network provider.

Table 20.61. `ovnKubernetesConfig` object

Field	Type	Description
-------	------	-------------

Field	Type	Description
<b>mtu</b>	<b>integer</b>	<p>The maximum transmission unit (MTU) for the Geneve (Generic Network Virtualization Encapsulation) overlay network. This is detected automatically based on the MTU of the primary network interface. You do not normally need to override the detected MTU.</p> <p>If the auto-detected value is not what you expect it to be, confirm that the MTU on the primary network interface on your nodes is correct. You cannot use this option to change the MTU value of the primary network interface on the nodes.</p> <p>If your cluster requires different MTU values for different nodes, you must set this value to <b>100</b> less than the lowest MTU value in your cluster. For example, if some nodes in your cluster have an MTU of <b>9001</b>, and some have an MTU of <b>1500</b>, you must set this value to <b>1400</b>.</p>
<b>genevePort</b>	<b>integer</b>	The port to use for all Geneve packets. The default value is <b>6081</b> . This value cannot be changed after cluster installation.
<b>ipsecConfig</b>	<b>object</b>	Specify an empty object to enable IPsec encryption. This value cannot be changed after cluster installation.
<b>policyAuditConfig</b>	<b>object</b>	Specify a configuration object for customizing network policy audit logging. If unset, the defaults audit log settings are used.
<b>gatewayConfig</b>	<b>object</b>	<p>Optional: Specify a configuration object for customizing how egress traffic is sent to the node gateway.</p> <div style="display: flex; align-items: flex-start;">  <div> <p><b>NOTE</b></p> <p>While migrating egress traffic, you can expect some disruption to workloads and service traffic until the Cluster Network Operator (CNO) successfully rolls out the changes.</p> </div> </div>

Table 20.62. **policyAuditConfig** object

Field	Type	Description
<b>rateLimit</b>	integer	The maximum number of messages to generate every second per node. The default value is <b>20</b> messages per second.
<b>maxFileSize</b>	integer	The maximum size for the audit log in bytes. The default value is <b>50000000</b> or 50 MB.

Field	Type	Description
<b>destination</b>	string	<p>One of the following additional audit log targets:</p> <p><b>libc</b> The libc <b>syslog()</b> function of the journald process on the host.</p> <p><b>udp:&lt;host&gt;:&lt;port&gt;</b> A syslog server. Replace <b>&lt;host&gt;:&lt;port&gt;</b> with the host and port of the syslog server.</p> <p><b>unix:&lt;file&gt;</b> A Unix Domain Socket file specified by <b>&lt;file&gt;</b>.</p> <p><b>null</b> Do not send the audit logs to any additional target.</p>
<b>syslogFacility</b>	string	The syslog facility, such as <b>kern</b> , as defined by RFC5424. The default value is <b>local0</b> .

Table 20.63. gatewayConfig object

Field	Type	Description
<b>routingViaHost</b>	<b>boolean</b>	<p>Set this field to <b>true</b> to send egress traffic from pods to the host networking stack. For highly-specialized installations and applications that rely on manually configured routes in the kernel routing table, you might want to route egress traffic to the host networking stack. By default, egress traffic is processed in OVN to exit the cluster and is not affected by specialized routes in the kernel routing table. The default value is <b>false</b>.</p> <p>This field has an interaction with the Open vSwitch hardware offloading feature. If you set this field to <b>true</b>, you do not receive the performance benefits of the offloading because egress traffic is processed by the host networking stack.</p>

### Example OVN-Kubernetes configuration with IPsec enabled

```

defaultNetwork:
  type: OVNKubernetes
  ovnKubernetesConfig:
    mtu: 1400
    genevePort: 6081
    ipsecConfig: {}

```

### kubeProxyConfig object configuration

The values for the **kubeProxyConfig** object are defined in the following table:

Table 20.64. kubeProxyConfig object

Field	Type	Description
<b>iptablesSyncPeriod</b>	<b>string</b>	<p>The refresh period for <b>iptables</b> rules. The default value is <b>30s</b>. Valid suffixes include <b>s</b>, <b>m</b>, and <b>h</b> and are described in the <a href="#">Go time package</a> documentation.</p> <div style="display: flex; align-items: flex-start;">  <div> <p><b>NOTE</b></p> <p>Because of performance improvements introduced in OpenShift Container Platform 4.3 and greater, adjusting the <b>iptablesSyncPeriod</b> parameter is no longer necessary.</p> </div> </div>
<b>proxyArguments.iptables-min-sync-period</b>	<b>array</b>	<p>The minimum duration before refreshing <b>iptables</b> rules. This field ensures that the refresh does not happen too frequently. Valid suffixes include <b>s</b>, <b>m</b>, and <b>h</b> and are described in the <a href="#">Go time package</a>. The default value is:</p> <pre>kubeProxyConfig:   proxyArguments:     iptables-min-sync-period:       - 0s</pre>

### 20.6.14. Creating the Ignition config files

Because you must manually start the cluster machines, you must generate the Ignition config files that the cluster needs to make its machines.

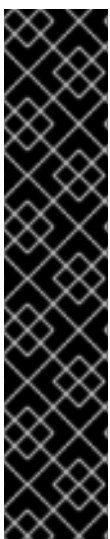

#### IMPORTANT

- The Ignition config files that the installation program generates contain certificates that expire after 24 hours, which are then renewed at that time. If the cluster is shut down before renewing the certificates and the cluster is later restarted after the 24 hours have elapsed, the cluster automatically recovers the expired certificates. The exception is that you must manually approve the pending **node-bootstrapper** certificate signing requests (CSRs) to recover kubelet certificates. See the documentation for *Recovering from expired control plane certificates* for more information.
- It is recommended that you use Ignition config files within 12 hours after they are generated because the 24-hour certificate rotates from 16 to 22 hours after the cluster is installed. By using the Ignition config files within 12 hours, you can avoid installation failure if the certificate update runs during installation.

#### Prerequisites

- Obtain the OpenShift Container Platform installation program and the pull secret for your cluster.

## Procedure

- Obtain the Ignition config files:

```
$ ./openshift-install create ignition-configs --dir <installation_directory> 1
```

- 1 For **<installation\_directory>**, specify the directory name to store the files that the installation program creates.

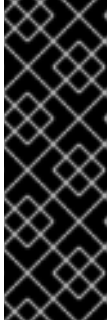

### IMPORTANT

If you created an **install-config.yaml** file, specify the directory that contains it. Otherwise, specify an empty directory. Some installation assets, like bootstrap X.509 certificates have short expiration intervals, so you must not reuse an installation directory. If you want to reuse individual files from another cluster installation, you can copy them into your directory. However, the file names for the installation assets might change between releases. Use caution when copying installation files from an earlier OpenShift Container Platform version.

The following files are generated in the directory:

```
.
├── auth
│   ├── kubeadmin-password
│   └── kubeconfig
├── bootstrap.ign
├── master.ign
├── metadata.json
└── worker.ign
```

## 20.6.15. Extracting the infrastructure name

The Ignition config files contain a unique cluster identifier that you can use to uniquely identify your cluster in VMware vSphere. If you plan to use the cluster identifier as the name of your virtual machine folder, you must extract it.

### Prerequisites

- You obtained the OpenShift Container Platform installation program and the pull secret for your cluster.
- You generated the Ignition config files for your cluster.
- You installed the **jq** package.

## Procedure

- To extract and view the infrastructure name from the Ignition config file metadata, run the following command:

```
$ jq -r .infraID <installation_directory>/metadata.json 1
```

- 1 For **<installation\_directory>**, specify the path to the directory that you stored the installation files in.

### Example output

```
openshift-vw9j6 1
```

- 1 The output of this command is your cluster name and a random string.

## 20.6.16. Installing RHCOS and starting the OpenShift Container Platform bootstrap process

To install OpenShift Container Platform on user-provisioned infrastructure on VMware vSphere, you must install Red Hat Enterprise Linux CoreOS (RHCOS) on vSphere hosts. When you install RHCOS, you must provide the Ignition config file that was generated by the OpenShift Container Platform installation program for the type of machine you are installing. If you have configured suitable networking, DNS, and load balancing infrastructure, the OpenShift Container Platform bootstrap process begins automatically after the RHCOS machines have rebooted.

### Prerequisites

- You have obtained the Ignition config files for your cluster.
- You have access to an HTTP server that you can access from your computer and that the machines that you create can access.
- You have created a [vSphere cluster](#).

### Procedure

1. Upload the bootstrap Ignition config file, which is named **<installation\_directory>/bootstrap.ign**, that the installation program created to your HTTP server. Note the URL of this file.
2. Save the following secondary Ignition config file for your bootstrap node to your computer as **<installation\_directory>/merge-bootstrap.ign**:

```
{
  "ignition": {
    "config": {
      "merge": [
        {
          "source": "<bootstrap_ignition_config_url>", 1
          "verification": {}
        }
      ]
    },
    "timeouts": {},
    "version": "3.2.0"
  },
  "networkd": {},
  "passwd": {},
```

```
"storage": {},
"systemd": {}
}
```

- 1 Specify the URL of the bootstrap Ignition config file that you hosted.

When you create the virtual machine (VM) for the bootstrap machine, you use this Ignition config file.

3. Locate the following Ignition config files that the installation program created:
  - **<installation\_directory>/master.ign**
  - **<installation\_directory>/worker.ign**
  - **<installation\_directory>/merge-bootstrap.ign**
4. Convert the Ignition config files to Base64 encoding. Later in this procedure, you must add these files to the extra configuration parameter **guestinfo.ignition.config.data** in your VM. For example, if you use a Linux operating system, you can use the **base64** command to encode the files.

```
$ base64 -w0 <installation_directory>/master.ign > <installation_directory>/master.64
```

```
$ base64 -w0 <installation_directory>/worker.ign > <installation_directory>/worker.64
```

```
$ base64 -w0 <installation_directory>/merge-bootstrap.ign > <installation_directory>/merge-bootstrap.64
```



### IMPORTANT

If you plan to add more compute machines to your cluster after you finish installation, do not delete these files.

5. Obtain the RHCOS OVA image. Images are available from the [RHCOS image mirror](#) page.



### IMPORTANT

The RHCOS images might not change with every release of OpenShift Container Platform. You must download an image with the highest version that is less than or equal to the OpenShift Container Platform version that you install. Use the image version that matches your OpenShift Container Platform version if it is available.

The filename contains the OpenShift Container Platform version number in the format **rhcos-vmware.<architecture>.ova**.

6. In the vSphere Client, create a folder in your datacenter to store your VMs.
  - a. Click the **VMs and Templates** view.
  - b. Right-click the name of your datacenter.



- c. Click **New Folder → New VM and Template Folder**.
  - d. In the window that is displayed, enter the folder name. If you did not specify an existing folder in the **install-config.yaml** file, then create a folder with the same name as the infrastructure ID. You use this folder name so vCenter dynamically provisions storage in the appropriate location for its Workspace configuration.
7. In the vSphere Client, create a template for the OVA image and then clone the template as needed.

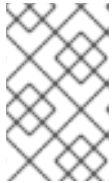

#### NOTE

In the following steps, you create a template and then clone the template for all of your cluster machines. You then provide the location for the Ignition config file for that cloned machine type when you provision the VMs.

- a. From the **Hosts and Clusters** tab, right-click your cluster name and select **Deploy OVF Template**.
- b. On the **Select an OVF** tab, specify the name of the RHCOS OVA file that you downloaded.
- c. On the **Select a name and folder** tab, set a **Virtual machine name** for your template, such as **Template-RHCOS**. Click the name of your vSphere cluster and select the folder you created in the previous step.
- d. On the **Select a compute resource** tab, click the name of your vSphere cluster.
- e. On the **Select storage** tab, configure the storage options for your VM.
  - Select **Thin Provision** or **Thick Provision**, based on your storage preferences.
  - Select the datastore that you specified in your **install-config.yaml** file.
- f. On the **Select network** tab, specify the network that you configured for the cluster, if available.
- g. When creating the OVF template, do not specify values on the **Customize template** tab or configure the template any further.



#### IMPORTANT

Do not start the original VM template. The VM template must remain off and must be cloned for new RHCOS machines. Starting the VM template configures the VM template as a VM on the platform, which prevents it from being used as a template that machine sets can apply configurations to.

8. Optional: Update the configured virtual hardware version in the VM template, if necessary. Follow [Upgrading a virtual machine to the latest hardware version](#) in the VMware documentation for more information.



## IMPORTANT

It is recommended that you update the hardware version of the VM template to version 15 before creating VMs from it, if necessary. Using hardware version 13 for your cluster nodes running on vSphere is now deprecated. If your imported template defaults to hardware version 13, you must ensure that your ESXi host is on 6.7U3 or later before upgrading the VM template to hardware version 15. If your vSphere version is less than 6.7U3, you can skip this upgrade step; however, a future version of OpenShift Container Platform is scheduled to remove support for hardware version 13 and vSphere versions less than 6.7U3.

9. After the template deploys, deploy a VM for a machine in the cluster.
  - a. Right-click the template name and click **Clone → Clone to Virtual Machine**
  - b. On the **Select a name and folder** tab, specify a name for the VM. You might include the machine type in the name, such as **control-plane-0** or **compute-1**.



## NOTE

Ensure that all virtual machine names across a vSphere installation are unique.

- c. On the **Select a name and folder** tab, select the name of the folder that you created for the cluster.
- d. On the **Select a compute resource** tab, select the name of a host in your datacenter.
- e. On the **Select clone options**, select **Customize this virtual machine's hardware**
- f. Optional: On the **Customize hardware** tab, click **VM Options → Advanced**.



## IMPORTANT

The following configuration suggestions are for example purposes only. As a cluster administrator, you must configure resources according to the resource demands placed on your cluster. To best manage cluster resources, consider creating a resource pool from the cluster's root resource pool.

- Override default DHCP networking in vSphere. To enable static IP networking:
  - Set your static IP configuration:

```
$ export IPCFG="ip=<ip>:<gateway>:<netmask>:<hostname>:<iface>:none
nameserver=svr1 [nameserver=svr2 [nameserver=svr3 [...]]]"
```

### Example command

```
$ export IPCFG="ip=192.168.100.101::192.168.100.254:255.255.255.0:::none
nameserver=8.8.8.8"
```

- Click **Edit Configuration**, and on the **Configuration Parameters** window, search the list of available parameters for steal clock accounting (**stealclock.enable**). Set the parameter to the value of **TRUE**. Enabling steal clock accounting can help with

troubleshooting cluster issues.

- Click **Add Configuration Params**. Define the following parameter names and values:
  - **disk.EnableUUID**: Specify **TRUE**.
  - **stealclock.enable**: If this parameter was not defined, add it and specify **TRUE**.
  - Create a child resource pool from the cluster's root resource pool. Perform resource allocation in this child resource pool.
- g. In the **Virtual Hardware** panel of the **Customize hardware** tab, modify the specified values as required. Ensure that the amount of RAM, CPU, and disk storage meets the minimum requirements for the machine type.
- h. Complete the configuration and power on the VM.
- i. Check the console output to verify that Ignition ran.

### Example command

```
Ignition: ran on 2022/03/14 14:48:33 UTC (this boot)
Ignition: user-provided config was applied
```

10. Create the rest of the machines for your cluster by following the preceding steps for each machine.

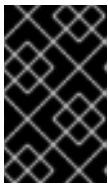

### IMPORTANT

You must create the bootstrap and control plane machines at this time. Because some pods are deployed on compute machines by default, also create at least two compute machines before you install the cluster.

## 20.6.17. Adding more compute machines to a cluster in vSphere

You can add more compute machines to a user-provisioned OpenShift Container Platform cluster on VMware vSphere.

### Prerequisites

- Obtain the base64-encoded Ignition file for your compute machines.
- You have access to the vSphere template that you created for your cluster.

### Procedure

1. After the template deploys, deploy a VM for a machine in the cluster.
  - a. Right-click the template's name and click **Clone** → **Clone to Virtual Machine**
  - b. On the **Select a name and folder** tab, specify a name for the VM. You might include the machine type in the name, such as **compute-1**.

**NOTE**

Ensure that all virtual machine names across a vSphere installation are unique.

- c. On the **Select a name and folder** tab, select the name of the folder that you created for the cluster.
  - d. On the **Select a compute resource** tab, select the name of a host in your datacenter.
  - e. On the **Select clone options**, select **Customize this virtual machine's hardware**
  - f. On the **Customize hardware** tab, click **VM Options → Advanced**.
    - Click **Edit Configuration**, and on the **Configuration Parameters** window, click **Add Configuration Params**. Define the following parameter names and values:
      - **guestinfo.ignition.config.data**: Paste the contents of the base64-encoded compute Ignition config file for this machine type.
      - **guestinfo.ignition.config.data.encoding**: Specify **base64**.
      - **disk.EnableUUID**: Specify **TRUE**.
  - g. In the **Virtual Hardware** panel of the **Customize hardware** tab, modify the specified values as required. Ensure that the amount of RAM, CPU, and disk storage meets the minimum requirements for the machine type. Also, make sure to select the correct network under **Add network adapter** if there are multiple networks available.
  - h. Complete the configuration and power on the VM.
2. Continue to create more compute machines for your cluster.

### 20.6.18. Disk partitioning

In most cases, data partitions are originally created by installing RHCOS, rather than by installing another operating system. In such cases, the OpenShift Container Platform installer should be allowed to configure your disk partitions.

However, there are two cases where you might want to intervene to override the default partitioning when installing an OpenShift Container Platform node:

- **Create separate partitions:** For greenfield installations on an empty disk, you might want to add separate storage to a partition. This is officially supported for making **/var** or a subdirectory of **/var**, such as **/var/lib/etcd**, a separate partition, but not both.

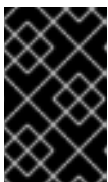
**IMPORTANT**

For disk sizes larger than 100GB, and especially disk sizes larger than 1TB, create a separate **/var** partition. See "Creating a separate **/var** partition" and this [Red Hat Knowledgebase article](#) for more information.

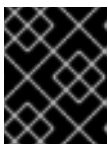
**IMPORTANT**

Kubernetes supports only two file system partitions. If you add more than one partition to the original configuration, Kubernetes cannot monitor all of them.

- **Retain existing partitions:** For a brownfield installation where you are reinstalling OpenShift Container Platform on an existing node and want to retain data partitions installed from your previous operating system, there are both boot arguments and options to **coreos-installer** that allow you to retain existing data partitions.

### Creating a separate `/var` partition

In general, disk partitioning for OpenShift Container Platform should be left to the installer. However, there are cases where you might want to create separate partitions in a part of the filesystem that you expect to grow.

OpenShift Container Platform supports the addition of a single partition to attach storage to either the `/var` partition or a subdirectory of `/var`. For example:

- **`/var/lib/containers`:** Holds container-related content that can grow as more images and containers are added to a system.
- **`/var/lib/etcd`:** Holds data that you might want to keep separate for purposes such as performance optimization of etcd storage.
- **`/var`:** Holds data that you might want to keep separate for purposes such as auditing.

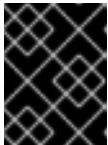

#### IMPORTANT

For disk sizes larger than 100GB, and especially larger than 1TB, create a separate `/var` partition.

Storing the contents of a `/var` directory separately makes it easier to grow storage for those areas as needed and reinstall OpenShift Container Platform at a later date and keep that data intact. With this method, you will not have to pull all your containers again, nor will you have to copy massive log files when you update systems.

Because `/var` must be in place before a fresh installation of Red Hat Enterprise Linux CoreOS (RHCOS), the following procedure sets up the separate `/var` partition by creating a machine config manifest that is inserted during the **openshift-install** preparation phases of an OpenShift Container Platform installation.

#### Procedure

1. Create a directory to hold the OpenShift Container Platform installation files:

```
$ mkdir $HOME/clusterconfig
```

2. Run **openshift-install** to create a set of files in the **manifest** and **openshift** subdirectories. Answer the system questions as you are prompted:

```
$ openshift-install create manifests --dir $HOME/clusterconfig
? SSH Public Key ...
$ ls $HOME/clusterconfig/openshift/
99_kubeadmin-password-secret.yaml
99_openshift-cluster-api_master-machines-0.yaml
99_openshift-cluster-api_master-machines-1.yaml
99_openshift-cluster-api_master-machines-2.yaml
...
```

3. Create a Butane config that configures the additional partition. For example, name the file **\$HOME/clusterconfig/98-var-partition.bu**, change the disk device name to the name of the storage device on the **worker** systems, and set the storage size as appropriate. This example places the **/var** directory on a separate partition:

```
variant: openshift
version: 4.10.0
metadata:
  labels:
    machineconfiguration.openshift.io/role: worker
  name: 98-var-partition
storage:
  disks:
    - device: /dev/<device_name> 1
      partitions:
        - label: var
          start_mib: <partition_start_offset> 2
          size_mib: <partition_size> 3
      filesystems:
        - device: /dev/disk/by-partlabel/var
          path: /var
          format: xfs
          mount_options: [defaults, prjquota] 4
          with_mount_unit: true
```

- 1 The storage device name of the disk that you want to partition.
- 2 When adding a data partition to the boot disk, a minimum value of 25000 mebibytes is recommended. The root file system is automatically resized to fill all available space up to the specified offset. If no value is specified, or if the specified value is smaller than the recommended minimum, the resulting root file system will be too small, and future reinstalls of RHCOS might overwrite the beginning of the data partition.
- 3 The size of the data partition in mebibytes.
- 4 The **prjquota** mount option must be enabled for filesystems used for container storage.

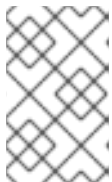

#### NOTE

When creating a separate **/var** partition, you cannot use different instance types for worker nodes, if the different instance types do not have the same device name.

4. Create a manifest from the Butane config and save it to the **clusterconfig/openshift** directory. For example, run the following command:

```
$ butane $HOME/clusterconfig/98-var-partition.bu -o $HOME/clusterconfig/openshift/98-var-partition.yaml
```

5. Run **openshift-install** again to create Ignition configs from a set of files in the **manifest** and **openshift** subdirectories:

```
$ openshift-install create ignition-configs --dir $HOME/clusterconfig
$ ls $HOME/clusterconfig/
auth bootstrap.ign master.ign metadata.json worker.ign
```

Now you can use the Ignition config files as input to the vSphere installation procedures to install Red Hat Enterprise Linux CoreOS (RHCOS) systems.

### 20.6.19. Updating the bootloader using `bootupd`

To update the bootloader by using `bootupd`, you must either install `bootupd` on RHCOS machines manually or provide a machine config with the enabled `systemd` unit. Unlike `grubby` or other bootloader tools, `bootupd` does not manage kernel space configuration such as passing kernel arguments.

After you have installed `bootupd`, you can manage it remotely from the OpenShift Container Platform cluster.



#### NOTE

It is recommended that you use `bootupd` only on bare metal or virtualized hypervisor installations, such as for protection against the BootHole vulnerability.

#### Manual install method

You can manually install `bootupd` by using the `bootctl` command-line tool.

1. Inspect the system status:

```
# bootupctl status
```

#### Example output for `x86_64`

```
Component EFI
Installed: grub2-efi-x64-1:2.04-31.fc33.x86_64,shim-x64-15-8.x86_64
Update: At latest version
```

#### Example output for `aarch64`

```
Component EFI
Installed: grub2-efi-aa64-1:2.02-99.el8_4.1.aarch64,shim-aa64-15.4-2.el8_1.aarch64
Update: At latest version
```

2. RHCOS images created without `bootupd` installed on them require an explicit adoption phase. If the system status is **Adoptable**, perform the adoption:

```
# bootupctl adopt-and-update
```

#### Example output

```
Updated: grub2-efi-x64-1:2.04-31.fc33.x86_64,shim-x64-15-8.x86_64
```

3. If an update is available, apply the update so that the changes take effect on the next reboot:

```
# bootupctl update
```

### Example output

```
Updated: grub2-efi-x64-1:2.04-31.fc33.x86_64,shim-x64-15-8.x86_64
```

## Machine config method

Another way to enable **bootupd** is by providing a machine config.

- Provide a machine config file with the enabled **systemd** unit, as shown in the following example:

### Example output

```
variant: rhcos
version: 1.1.0
systemd:
  units:
    - name: custom-bootupd-auto.service
      enabled: true
      contents: |
        [Unit]
        Description=Bootupd automatic update

        [Service]
        ExecStart=/usr/bin/bootupctl update
        RemainAfterExit=yes

        [Install]
        WantedBy=multi-user.target
```

## 20.6.20. Waiting for the bootstrap process to complete

The OpenShift Container Platform bootstrap process begins after the cluster nodes first boot into the persistent RHCOS environment that has been installed to disk. The configuration information provided through the Ignition config files is used to initialize the bootstrap process and install OpenShift Container Platform on the machines. You must wait for the bootstrap process to complete.

### Prerequisites

- You have created the Ignition config files for your cluster.
- You have configured suitable network, DNS and load balancing infrastructure.
- You have obtained the installation program and generated the Ignition config files for your cluster.
- You installed RHCOS on your cluster machines and provided the Ignition config files that the OpenShift Container Platform installation program generated.
- Your machines have direct internet access or have an HTTP or HTTPS proxy available.

### Procedure



1. Monitor the bootstrap process:

```
$ ./openshift-install --dir <installation_directory> wait-for bootstrap-complete \ 1
--log-level=info 2
```

1 For **<installation\_directory>**, specify the path to the directory that you stored the installation files in.

2 To view different installation details, specify **warn**, **debug**, or **error** instead of **info**.

### Example output

```
INFO Waiting up to 30m0s for the Kubernetes API at https://api.test.example.com:6443...
INFO API v1.23.0 up
INFO Waiting up to 30m0s for bootstrapping to complete...
INFO It is now safe to remove the bootstrap resources
```

The command succeeds when the Kubernetes API server signals that it has been bootstrapped on the control plane machines.

2. After bootstrap process is complete, remove the bootstrap machine from the load balancer.

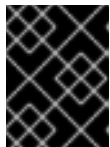

### IMPORTANT

You must remove the bootstrap machine from the load balancer at this point. You can also remove or reformat the bootstrap machine itself.

## 20.6.21. Logging in to the cluster by using the CLI

You can log in to your cluster as a default system user by exporting the cluster **kubeconfig** file. The **kubeconfig** file contains information about the cluster that is used by the CLI to connect a client to the correct cluster and API server. The file is specific to a cluster and is created during OpenShift Container Platform installation.

### Prerequisites

- You deployed an OpenShift Container Platform cluster.
- You installed the **oc** CLI.

### Procedure

1. Export the **kubeadmin** credentials:

```
$ export KUBECONFIG=<installation_directory>/auth/kubeconfig 1
```

1 For **<installation\_directory>**, specify the path to the directory that you stored the installation files in.

2. Verify you can run **oc** commands successfully using the exported configuration:

```
$ oc whoami
```

-

## Example output

```
system:admin
```

### 20.6.22. Approving the certificate signing requests for your machines

When you add machines to a cluster, two pending certificate signing requests (CSRs) are generated for each machine that you added. You must confirm that these CSRs are approved or, if necessary, approve them yourself. The client requests must be approved first, followed by the server requests.

#### Prerequisites

- You added machines to your cluster.

#### Procedure

- Confirm that the cluster recognizes the machines:

```
$ oc get nodes
```

#### Example output

```
NAME      STATUS   ROLES    AGE   VERSION
master-0  Ready    master   63m   v1.23.0
master-1  Ready    master   63m   v1.23.0
master-2  Ready    master   64m   v1.23.0
```

The output lists all of the machines that you created.



#### NOTE

The preceding output might not include the compute nodes, also known as worker nodes, until some CSRs are approved.

- Review the pending CSRs and ensure that you see the client requests with the **Pending** or **Approved** status for each machine that you added to the cluster:

```
$ oc get csr
```

#### Example output

```
NAME      AGE   REQUESTOR                                     CONDITION
csr-8b2br  15m   system:serviceaccount:openshift-machine-config-operator:node-
bootstrapper  Pending
csr-8vnps  15m   system:serviceaccount:openshift-machine-config-operator:node-
bootstrapper  Pending
...
```

In this example, two machines are joining the cluster. You might see more approved CSRs in the list.

- If the CSRs were not approved, after all of the pending CSRs for the machines you added are in **Pending** status, approve the CSRs for your cluster machines:



#### NOTE

Because the CSRs rotate automatically, approve your CSRs within an hour of adding the machines to the cluster. If you do not approve them within an hour, the certificates will rotate, and more than two certificates will be present for each node. You must approve all of these certificates. After the client CSR is approved, the Kubelet creates a secondary CSR for the serving certificate, which requires manual approval. Then, subsequent serving certificate renewal requests are automatically approved by the **machine-approver** if the Kubelet requests a new certificate with identical parameters.



#### NOTE

For clusters running on platforms that are not machine API enabled, such as bare metal and other user-provisioned infrastructure, you must implement a method of automatically approving the kubelet serving certificate requests (CSRs). If a request is not approved, then the **oc exec**, **oc rsh**, and **oc logs** commands cannot succeed, because a serving certificate is required when the API server connects to the kubelet. Any operation that contacts the Kubelet endpoint requires this certificate approval to be in place. The method must watch for new CSRs, confirm that the CSR was submitted by the **node-bootstrapper** service account in the **system:node** or **system:admin** groups, and confirm the identity of the node.

- To approve them individually, run the following command for each valid CSR:

```
$ oc adm certificate approve <csr_name> 1
```

- 1** **<csr\_name>** is the name of a CSR from the list of current CSRs.

- To approve all pending CSRs, run the following command:

```
$ oc get csr -o go-template='{{range .items}}{{if not .status}}{{.metadata.name}}{"\n"}{{end}}{{end}}' | xargs --no-run-if-empty oc adm certificate approve
```



#### NOTE

Some Operators might not become available until some CSRs are approved.

- Now that your client requests are approved, you must review the server requests for each machine that you added to the cluster:

```
$ oc get csr
```

#### Example output

```
NAME      AGE   REQUESTOR                                     CONDITION
csr-bfd72 5m26s system:node:ip-10-0-50-126.us-east-2.compute.internal
Pending
```

```
csr-c57lv 5m26s system:node:ip-10-0-95-157.us-east-2.compute.internal
Pending
...
```

- If the remaining CSRs are not approved, and are in the **Pending** status, approve the CSRs for your cluster machines:

- To approve them individually, run the following command for each valid CSR:

```
$ oc adm certificate approve <csr_name> 1
```

- 1** **<csr\_name>** is the name of a CSR from the list of current CSRs.

- To approve all pending CSRs, run the following command:

```
$ oc get csr -o go-template='{{range .items}}{{if not .status}}{{.metadata.name}}{"\n"}
{{end}}{{end}}' | xargs oc adm certificate approve
```

- After all client and server CSRs have been approved, the machines have the **Ready** status. Verify this by running the following command:

```
$ oc get nodes
```

### Example output

```
NAME      STATUS  ROLES  AGE  VERSION
master-0  Ready   master 73m  v1.23.0
master-1  Ready   master 73m  v1.23.0
master-2  Ready   master 74m  v1.23.0
worker-0  Ready   worker 11m  v1.23.0
worker-1  Ready   worker 11m  v1.23.0
```

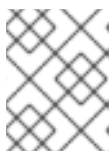

### NOTE

It can take a few minutes after approval of the server CSRs for the machines to transition to the **Ready** status.

### Additional information

- For more information on CSRs, see [Certificate Signing Requests](#).

### 20.6.22.1. Initial Operator configuration

After the control plane initializes, you must immediately configure some Operators so that they all become available.

### Prerequisites

- Your control plane has initialized.

### Procedure

1. Watch the cluster components come online:

```
$ watch -n5 oc get clusteroperators
```

### Example output

NAME	VERSION	AVAILABLE	PROGRESSING	DEGRADED	SINCE
authentication	4.10.0	True	False	False	19m
baremetal	4.10.0	True	False	False	37m
cloud-credential	4.10.0	True	False	False	40m
cluster-autoscaler	4.10.0	True	False	False	37m
config-operator	4.10.0	True	False	False	38m
console	4.10.0	True	False	False	26m
csi-snapshot-controller	4.10.0	True	False	False	37m
dns	4.10.0	True	False	False	37m
etcd	4.10.0	True	False	False	36m
image-registry	4.10.0	True	False	False	31m
ingress	4.10.0	True	False	False	30m
insights	4.10.0	True	False	False	31m
kube-apiserver	4.10.0	True	False	False	26m
kube-controller-manager	4.10.0	True	False	False	36m
kube-scheduler	4.10.0	True	False	False	36m
kube-storage-version-migrator	4.10.0	True	False	False	37m
machine-api	4.10.0	True	False	False	29m
machine-approver	4.10.0	True	False	False	37m
machine-config	4.10.0	True	False	False	36m
marketplace	4.10.0	True	False	False	37m
monitoring	4.10.0	True	False	False	29m
network	4.10.0	True	False	False	38m
node-tuning	4.10.0	True	False	False	37m
openshift-apiserver	4.10.0	True	False	False	32m
openshift-controller-manager	4.10.0	True	False	False	30m
openshift-samples	4.10.0	True	False	False	32m
operator-lifecycle-manager	4.10.0	True	False	False	37m
operator-lifecycle-manager-catalog	4.10.0	True	False	False	37m
operator-lifecycle-manager-packageserver	4.10.0	True	False	False	32m
service-ca	4.10.0	True	False	False	38m
storage	4.10.0	True	False	False	37m

2. Configure the Operators that are not available.

#### 20.6.22.2. Image registry removed during installation

On platforms that do not provide shareable object storage, the OpenShift Image Registry Operator bootstraps itself as **Removed**. This allows **openshift-installer** to complete installations on these platform types.

After installation, you must edit the Image Registry Operator configuration to switch the **managementState** from **Removed** to **Managed**.

#### 20.6.22.3. Image registry storage configuration

The Image Registry Operator is not initially available for platforms that do not provide default storage. After installation, you must configure your registry to use storage so that the Registry Operator is made available.

Instructions are shown for configuring a persistent volume, which is required for production clusters. Where applicable, instructions are shown for configuring an empty directory as the storage location, which is available for only non-production clusters.

Additional instructions are provided for allowing the image registry to use block storage types by using the **Recreate** rollout strategy during upgrades.

### 20.6.22.3.1. Configuring block registry storage for VMware vSphere

To allow the image registry to use block storage types such as vSphere Virtual Machine Disk (VMDK) during upgrades as a cluster administrator, you can use the **Recreate** rollout strategy.



#### IMPORTANT

Block storage volumes are supported but not recommended for use with image registry on production clusters. An installation where the registry is configured on block storage is not highly available because the registry cannot have more than one replica.

#### Procedure

1. To set the image registry storage as a block storage type, patch the registry so that it uses the **Recreate** rollout strategy and runs with only **1** replica:

```
$ oc patch config.imageregistry.operator.openshift.io/cluster --type=merge -p '{"spec": {"rolloutStrategy": "Recreate", "replicas": 1}}'
```

2. Provision the PV for the block storage device, and create a PVC for that volume. The requested block volume uses the ReadWriteOnce (RWO) access mode.
  - a. Create a **pvc.yaml** file with the following contents to define a VMware vSphere **PersistentVolumeClaim** object:

```
kind: PersistentVolumeClaim
apiVersion: v1
metadata:
  name: image-registry-storage 1
  namespace: openshift-image-registry 2
spec:
  accessModes:
  - ReadWriteOnce 3
  resources:
    requests:
      storage: 100Gi 4
```

- 1 A unique name that represents the **PersistentVolumeClaim** object.
- 2 The namespace for the **PersistentVolumeClaim** object, which is **openshift-image-registry**.
- 3 The access mode of the persistent volume claim. With **ReadWriteOnce**, the volume can be mounted with read and write permissions by a single node.

4 The size of the persistent volume claim.

b. Create the **PersistentVolumeClaim** object from the file:

```
$ oc create -f pvc.yaml -n openshift-image-registry
```

3. Edit the registry configuration so that it references the correct PVC:

```
$ oc edit config.imageregistry.operator.openshift.io -o yaml
```

### Example output

```
storage:
  pvc:
    claim: 1
```

1 Creating a custom PVC allows you to leave the **claim** field blank for the default automatic creation of an **image-registry-storage** PVC.

For instructions about configuring registry storage so that it references the correct PVC, see [Configuring the registry for vSphere](#).

## 20.6.23. Completing installation on user-provisioned infrastructure

After you complete the Operator configuration, you can finish installing the cluster on infrastructure that you provide.

### Prerequisites

- Your control plane has initialized.
- You have completed the initial Operator configuration.

### Procedure

1. Confirm that all the cluster components are online with the following command:

```
$ watch -n5 oc get clusteroperators
```

### Example output

NAME	VERSION	AVAILABLE	PROGRESSING	DEGRADED	SINCE
authentication	4.10.0	True	False	False	19m
baremetal	4.10.0	True	False	False	37m
cloud-credential	4.10.0	True	False	False	40m
cluster-autoscaler	4.10.0	True	False	False	37m
config-operator	4.10.0	True	False	False	38m
console	4.10.0	True	False	False	26m
csi-snapshot-controller	4.10.0	True	False	False	37m
dns	4.10.0	True	False	False	37m

etcd	4.10.0	True	False	False	36m
image-registry	4.10.0	True	False	False	31m
ingress	4.10.0	True	False	False	30m
insights	4.10.0	True	False	False	31m
kube-apiserver	4.10.0	True	False	False	26m
kube-controller-manager	4.10.0	True	False	False	36m
kube-scheduler	4.10.0	True	False	False	36m
kube-storage-version-migrator	4.10.0	True	False	False	37m
machine-api	4.10.0	True	False	False	29m
machine-approver	4.10.0	True	False	False	37m
machine-config	4.10.0	True	False	False	36m
marketplace	4.10.0	True	False	False	37m
monitoring	4.10.0	True	False	False	29m
network	4.10.0	True	False	False	38m
node-tuning	4.10.0	True	False	False	37m
openshift-apiserver	4.10.0	True	False	False	32m
openshift-controller-manager	4.10.0	True	False	False	30m
openshift-samples	4.10.0	True	False	False	32m
operator-lifecycle-manager	4.10.0	True	False	False	37m
operator-lifecycle-manager-catalog	4.10.0	True	False	False	37m
operator-lifecycle-manager-packageserver	4.10.0	True	False	False	32m
service-ca	4.10.0	True	False	False	38m
storage	4.10.0	True	False	False	37m

Alternatively, the following command notifies you when all of the clusters are available. It also retrieves and displays credentials:

```
$ ./openshift-install --dir <installation_directory> wait-for install-complete 1
```

- 1** For **<installation\_directory>**, specify the path to the directory that you stored the installation files in.

### Example output

```
INFO Waiting up to 30m0s for the cluster to initialize...
```

The command succeeds when the Cluster Version Operator finishes deploying the OpenShift Container Platform cluster from Kubernetes API server.





## IMPORTANT

- The Ignition config files that the installation program generates contain certificates that expire after 24 hours, which are then renewed at that time. If the cluster is shut down before renewing the certificates and the cluster is later restarted after the 24 hours have elapsed, the cluster automatically recovers the expired certificates. The exception is that you must manually approve the pending **node-bootstrapper** certificate signing requests (CSRs) to recover kubelet certificates. See the documentation for *Recovering from expired control plane certificates* for more information.
- It is recommended that you use Ignition config files within 12 hours after they are generated because the 24-hour certificate rotates from 16 to 22 hours after the cluster is installed. By using the Ignition config files within 12 hours, you can avoid installation failure if the certificate update runs during installation.

2. Confirm that the Kubernetes API server is communicating with the pods.

a. To view a list of all pods, use the following command:

```
$ oc get pods --all-namespaces
```

### Example output

```

NAMESPACE           NAME                                     READY  STATUS
RESTARTS  AGE
openshift-apiserver-operator  openshift-apiserver-operator-85cb746d55-zqhs8  1/1
Running   1    9m
openshift-apiserver          apiserver-67b9g                                1/1  Running  0
3m
openshift-apiserver          apiserver-ljcmx                                1/1  Running  0
1m
openshift-apiserver          apiserver-z25h4                                1/1  Running  0
2m
openshift-authentication-operator  authentication-operator-69d5d8bf84-vh2n8  1/1
Running   0    5m
...

```

b. View the logs for a pod that is listed in the output of the previous command by using the following command:

```
$ oc logs <pod_name> -n <namespace> ❶
```

- ❶ Specify the pod name and namespace, as shown in the output of the previous command.

If the pod logs display, the Kubernetes API server can communicate with the cluster machines.

3. For an installation with Fibre Channel Protocol (FCP), additional steps are required to enable multipathing. Do not enable multipathing during installation. See "Enabling multipathing with kernel arguments on RHCOS" in the *Post-installation machine configuration tasks* documentation for more information.

You can add extra compute machines after the cluster installation is completed by following [Adding compute machines to vSphere](#).

## 20.6.24. Configuring vSphere DRS anti-affinity rules for control plane nodes

vSphere Distributed Resource Scheduler (DRS) anti-affinity rules can be configured to support higher availability of OpenShift Container Platform control plane nodes. Anti-affinity rules ensure that the vSphere Virtual Machines for the OpenShift Container Platform control plane nodes are not scheduled to the same vSphere Host.

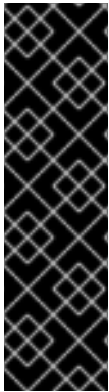

### IMPORTANT

- The following information applies to compute DRS only and does not apply to storage DRS.
- The **govc** command is an open-source command available from VMware; it is not available from Red Hat. The **govc** command is not supported by the Red Hat support.
- Instructions for downloading and installing **govc** are found on the VMware documentation website.

Create an anti-affinity rule by running the following command:

### Example command

```
$ govc cluster.rule.create \  
-name openshift4-control-plane-group \  
-dc MyDatacenter -cluster MyCluster \  
-enable \  
-anti-affinity master-0 master-1 master-2
```

After creating the rule, your control plane nodes are automatically migrated by vSphere so they are not running on the same hosts. This might take some time while vSphere reconciles the new rule. Successful command completion is shown in the following procedure.



### NOTE

The migration occurs automatically and might cause brief OpenShift API outage or latency until the migration finishes.

The vSphere DRS anti-affinity rules need to be updated manually in the event of a control plane VM name change or migration to a new vSphere Cluster.

### Procedure

1. Remove any existing DRS anti-affinity rule by running the following command:

```
$ govc cluster.rule.remove \  
-name openshift4-control-plane-group \  
-dc MyDatacenter -cluster MyCluster
```

### Example Output

```
[13-10-22 09:33:24] Reconfigure /MyDatacenter/host/MyCluster...OK
```

2. Create the rule again with updated names by running the following command:

```
$ govc cluster.rule.create \
  -name openshift4-control-plane-group \
  -dc MyDatacenter -cluster MyOtherCluster \
  -enable \
  -anti-affinity master-0 master-1 master-2
```

### 20.6.25. Backing up VMware vSphere volumes

OpenShift Container Platform provisions new volumes as independent persistent disks to freely attach and detach the volume on any node in the cluster. As a consequence, it is not possible to back up volumes that use snapshots, or to restore volumes from snapshots. See [Snapshot Limitations](#) for more information.

#### Procedure

To create a backup of persistent volumes:

1. Stop the application that is using the persistent volume.
2. Clone the persistent volume.
3. Restart the application.
4. Create a backup of the cloned volume.
5. Delete the cloned volume.

### 20.6.26. Telemetry access for OpenShift Container Platform

In OpenShift Container Platform 4.10, the Telemetry service, which runs by default to provide metrics about cluster health and the success of updates, requires internet access. If your cluster is connected to the internet, Telemetry runs automatically, and your cluster is registered to [OpenShift Cluster Manager](#).

After you confirm that your [OpenShift Cluster Manager](#) inventory is correct, either maintained automatically by Telemetry or manually by using OpenShift Cluster Manager, [use subscription watch](#) to track your OpenShift Container Platform subscriptions at the account or multi-cluster level.

#### Additional resources

- See [About remote health monitoring](#) for more information about the Telemetry service

### 20.6.27. Next steps

- [Customize your cluster](#).
- If necessary, you can [opt out of remote health reporting](#).
- [Set up your registry and configure registry storage](#).
- Optional: [View the events from the vSphere Problem Detector Operator](#) to determine if the cluster has permission or storage configuration issues.

## 20.7. INSTALLING A CLUSTER ON VSPHERE IN A RESTRICTED NETWORK

In OpenShift Container Platform 4.10, you can install a cluster on VMware vSphere infrastructure in a restricted network by creating an internal mirror of the installation release content.



### NOTE

OpenShift Container Platform supports deploying a cluster to a single VMware vCenter only. Deploying a cluster with machines/machine sets on multiple vCenters is not supported.

### 20.7.1. Prerequisites

- You reviewed details about the [OpenShift Container Platform installation and update](#) processes.
- You read the documentation on [selecting a cluster installation method and preparing it for users](#).
- You [created a registry on your mirror host](#) and obtained the **imageContentSources** data for your version of OpenShift Container Platform.

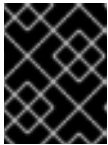

### IMPORTANT

Because the installation media is on the mirror host, you can use that computer to complete all installation steps.

- You provisioned [persistent storage](#) for your cluster. To deploy a private image registry, your storage must provide the ReadWriteMany access mode.
- The OpenShift Container Platform installer requires access to port 443 on the vCenter and ESXi hosts. You verified that port 443 is accessible.
- If you use a firewall, you confirmed with the administrator that port 443 is accessible. Control plane nodes must be able to reach vCenter and ESXi hosts on port 443 for the installation to succeed.
- If you use a firewall and plan to use the Telemetry service, you [configured the firewall to allow the sites](#) that your cluster requires access to.



### NOTE

If you are configuring a proxy, be sure to also review this site list.

### 20.7.2. About installations in restricted networks

In OpenShift Container Platform 4.10, you can perform an installation that does not require an active connection to the internet to obtain software components. Restricted network installations can be completed using installer-provisioned infrastructure or user-provisioned infrastructure, depending on the cloud platform to which you are installing the cluster.

If you choose to perform a restricted network installation on a cloud platform, you still require access to its cloud APIs. Some cloud functions, like Amazon Web Service's Route 53 DNS and IAM services, require

internet access. Depending on your network, you might require less internet access for an installation on bare metal hardware or on VMware vSphere.

To complete a restricted network installation, you must create a registry that mirrors the contents of the OpenShift image registry and contains the installation media. You can create this registry on a mirror host, which can access both the internet and your closed network, or by using other methods that meet your restrictions.

### 20.7.2.1. Additional limits

Clusters in restricted networks have the following additional limitations and restrictions:

- The **ClusterVersion** status includes an **Unable to retrieve available updates** error.
- By default, you cannot use the contents of the Developer Catalog because you cannot access the required image stream tags.

### 20.7.3. Internet access for OpenShift Container Platform

In OpenShift Container Platform 4.10, you require access to the internet to obtain the images that are necessary to install your cluster.

You must have internet access to:

- Access [OpenShift Cluster Manager](#) to download the installation program and perform subscription management. If the cluster has internet access and you do not disable Telemetry, that service automatically entitles your cluster.
- Access [Quay.io](#) to obtain the packages that are required to install your cluster.
- Obtain the packages that are required to perform cluster updates.

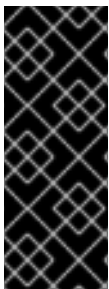

#### IMPORTANT

If your cluster cannot have direct internet access, you can perform a restricted network installation on some types of infrastructure that you provision. During that process, you download the required content and use it to populate a mirror registry with the installation packages. With some installation types, the environment that you install your cluster in will not require internet access. Before you update the cluster, you update the content of the mirror registry.

### 20.7.4. VMware vSphere infrastructure requirements

You must install the OpenShift Container Platform cluster on a VMware vSphere version 7 instance that meets the requirements for the components that you use.



#### NOTE

OpenShift Container Platform version 4.10 does not support VMware vSphere version 8.0.

You can host the VMware vSphere infrastructure on-premise or on a [VMware Cloud Verified provider](#) that meets the requirements outlined in the following table:

**Table 20.65. Version requirements for vSphere virtual environments**

Virtual environment product	Required version
VM hardware version	15 or later
vSphere ESXi hosts	7
vCenter host	7

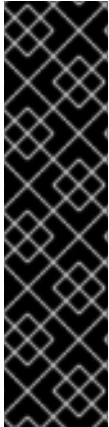

## IMPORTANT

Installing a cluster on VMware vSphere version 7.0 Update 1 is now deprecated. These versions are still fully supported, but version 4.10 of OpenShift Container Platform requires vSphere virtual hardware version 15 or later. Hardware version 15 is now the default for vSphere virtual machines in OpenShift Container Platform. To update the hardware version for your vSphere nodes, see the "Updating hardware on nodes running in vSphere" article.

If your vSphere nodes are below hardware version 15 or your VMware vSphere version is earlier than 6.7U3, upgrading from OpenShift Container Platform 4.10 to OpenShift Container Platform 4.11 is not available.

**Table 20.66. Minimum supported vSphere version for VMware components**

Component	Minimum supported versions	Description
Hypervisor	vSphere 7 with HW version 15	This version is the minimum version that Red Hat Enterprise Linux CoreOS (RHCOS) supports. For more information about supported hardware on the latest version of Red Hat Enterprise Linux (RHEL) that is compatible with RHCOS, see <a href="#">Hardware</a> on the Red Hat Customer Portal.
Storage with in-tree drivers	vSphere 7	This plugin creates vSphere storage by using the in-tree storage drivers for vSphere included in OpenShift Container Platform.
Optional: Networking (NSX-T)	vSphere 7	vSphere 7 is required for OpenShift Container Platform. For more information about the compatibility of NSX and OpenShift Container Platform, see the Release Notes section of VMware's <a href="#">NSX container plugin documentation</a> .

If you use a vSphere version 6.5 instance, upgrade to 7.0 before you install OpenShift Container Platform.



### IMPORTANT

You must ensure that the time on your ESXi hosts is synchronized before you install OpenShift Container Platform. See [Edit Time Configuration for a Host](#) in the VMware documentation.

## 20.7.5. Network connectivity requirements

You must configure the network connectivity between machines to allow OpenShift Container Platform cluster components to communicate.

Review the following details about the required network ports.

**Table 20.67. Ports used for all-machine to all-machine communications**

Protocol	Port	Description
ICMP	N/A	Network reachability tests
TCP	<b>1936</b>	Metrics
	<b>9000-9999</b>	Host level services, including the node exporter on ports <b>9100-9101</b> and the Cluster Version Operator on port <b>9099</b> .
	<b>10250-10259</b>	The default ports that Kubernetes reserves
	<b>10256</b>	openshift-sdn
UDP	<b>4789</b>	virtual extensible LAN (VXLAN)
	<b>6081</b>	Geneve
	<b>9000-9999</b>	Host level services, including the node exporter on ports <b>9100-9101</b> .
	<b>500</b>	IPsec IKE packets
	<b>4500</b>	IPsec NAT-T packets
TCP/UDP	<b>30000-32767</b>	Kubernetes node port
ESP	N/A	IPsec Encapsulating Security Payload (ESP)

**Table 20.68. Ports used for all-machine to control plane communications**

Protocol	Port	Description
TCP	<b>6443</b>	Kubernetes API

Table 20.69. Ports used for control plane machine to control plane machine communications

Protocol	Port	Description
TCP	<b>2379-2380</b>	etcd server and peer ports

### 20.7.6. VMware vSphere CSI Driver Operator requirements

To install the vSphere CSI Driver Operator, the following requirements must be met:

- VMware vSphere version 6.7U3 or later
- Virtual machines of hardware version 15 or later
- No third-party vSphere CSI driver already installed in the cluster



#### IMPORTANT

If a third-party vSphere CSI driver is present in the cluster, OpenShift Container Platform does not overwrite it. If you continue with the third-party vSphere CSI driver when upgrading to the next major version of OpenShift Container Platform, the **oc** CLI prompts you with the following message:

```
VSphereCSIDriverOperatorCRUpgradeable: VMwareVSphereControllerUpgradeable:
found existing unsupported csi.vsphere.vmware.com driver
```

The previous message informs you that Red Hat does not support the third-party vSphere CSI driver during an OpenShift Container Platform upgrade operation. You can choose to ignore this message and continue with the upgrade operation.

#### Additional resources

- To remove a third-party vSphere CSI driver, see [Removing a third-party vSphere CSI Driver](#) .
- To update the hardware version for your vSphere nodes, see [Updating hardware on nodes running in vSphere](#).

### 20.7.7. vCenter requirements

Before you install an OpenShift Container Platform cluster on your vCenter that uses infrastructure that the installer provisions, you must prepare your environment.

#### Required vCenter account privileges

To install an OpenShift Container Platform cluster in a vCenter, the installation program requires access to an account with privileges to read and create the required resources. Using an account that has global administrative privileges is the simplest way to access all of the necessary permissions.

If you cannot use an account with global administrative privileges, you must create roles to grant the



privileges necessary for OpenShift Container Platform cluster installation. While most of the privileges are always required, some are required only if you plan for the installation program to provision a folder to contain the OpenShift Container Platform cluster on your vCenter instance, which is the default behavior. You must create or amend vSphere roles for the specified objects to grant the required privileges.

An additional role is required if the installation program is to create a vSphere virtual machine folder.

### Example 20.16. Roles and privileges required for installation in vSphere API

vSphere object for role	When required	Required privileges in vSphere API
vSphere vCenter	Always	<b>Cns.Searchable</b> <b>InventoryService.Tagging.AttachTag</b> <b>InventoryService.Tagging.CreateCategory</b> <b>InventoryService.Tagging.CreateTag</b> <b>InventoryService.Tagging.DeleteCategory</b> <b>InventoryService.Tagging.DeleteTag</b> <b>InventoryService.Tagging.EditCategory</b> <b>InventoryService.Tagging.EditTag</b> <b>Sessions.ValidateSession</b> <b>StorageProfile.Update</b> <b>StorageProfile.View</b>
vSphere vCenter Cluster	If VMs will be created in the cluster root	<b>Host.Config.StorageResource.AssignVMToPool</b> <b>VApp.AssignResourcePool</b> <b>VApp.Import</b> <b>VirtualMachine.Config.AddNewDisk</b>
vSphere vCenter Resource Pool	If an existing resource pool is provided	<b>Host.Config.StorageResource.AssignVMToPool</b> <b>VApp.AssignResourcePool</b> <b>VApp.Import</b> <b>VirtualMachine.Config.AddNewDisk</b>
vSphere Datastore	Always	<b>Datastore.AllocateSpace</b> <b>Datastore.Browse</b> <b>Datastore.FileManagement</b> <b>InventoryService.Tagging.ObjectAttachable</b>

vSphere object for role	When required	Required privileges in vSphere API
vSphere Port Group	Always	<b>Network.Assign</b>
Virtual Machine Folder	Always	<b>InventoryService.Tagging.ObjectAttachable</b> <b>Resource.AssignVMToPool</b> <b>VApp.Import</b> <b>VirtualMachine.Config.AddExistingDisk</b> <b>VirtualMachine.Config.AddNewDisk</b> <b>VirtualMachine.Config.AddRemoveDevice</b> <b>VirtualMachine.Config.AdvancedConfig</b> <b>VirtualMachine.Config.Annotation</b> <b>VirtualMachine.Config.CPUCount</b> <b>VirtualMachine.Config.DiskExtend</b> <b>VirtualMachine.Config.DiskLease</b> <b>VirtualMachine.Config.EditDevice</b> <b>VirtualMachine.Config.Memory</b> <b>VirtualMachine.Config.RemoveDisk</b> <b>VirtualMachine.Config.Rename</b> <b>VirtualMachine.Config.ResetGuestInfo</b> <b>VirtualMachine.Config.Resource</b> <b>VirtualMachine.Config.Settings</b> <b>VirtualMachine.Config.UpgradeVirtualHardware</b> <b>VirtualMachine.Interact.GuestControl</b> <b>VirtualMachine.Interact.PowerOff</b> <b>VirtualMachine.Interact.PowerOn</b> <b>VirtualMachine.Interact.Reset</b> <b>VirtualMachine.Inventory.Create</b> <b>VirtualMachine.Inventory.CreateFromExisting</b> <b>VirtualMachine.Inventory.Delete</b>

vSphere object for role	When required	VirtualMachine.Provisioning API Required privileges in vSphere VirtualMachine.Provisioning
		<b>g.MarkAsTemplate</b> <b>VirtualMachine.Provisioning.DeployTemplate</b>
vSphere vCenter Datacenter	If the installation program creates the virtual machine folder	<b>InventoryService.Tagging.ObjectAttachable</b> <b>Resource.AssignVMToPool</b> <b>VApp.Import</b> <b>VirtualMachine.Config.AddExistingDisk</b> <b>VirtualMachine.Config.AddNewDisk</b> <b>VirtualMachine.Config.AddRemoveDevice</b> <b>VirtualMachine.Config.AdvancedConfig</b> <b>VirtualMachine.Config.Annotation</b> <b>VirtualMachine.Config.CPUCount</b> <b>VirtualMachine.Config.DiskExtend</b> <b>VirtualMachine.Config.DiskLease</b> <b>VirtualMachine.Config.EditDevice</b> <b>VirtualMachine.Config.Memory</b> <b>VirtualMachine.Config.RemoveDisk</b> <b>VirtualMachine.Config.Rename</b> <b>VirtualMachine.Config.ResetGuestInfo</b> <b>VirtualMachine.Config.Resource</b> <b>VirtualMachine.Config.Settings</b> <b>VirtualMachine.Config.UpgradeVirtualHardware</b> <b>VirtualMachine.Interact.GuestControl</b> <b>VirtualMachine.Interact.PowerOff</b> <b>VirtualMachine.Interact.PowerOn</b> <b>VirtualMachine.Interact.Reset</b> <b>VirtualMachine.Inventory.Create</b> <b>VirtualMachine.Inventory.CreateFromExisting</b>

vSphere object for role	When required	Required privileges in vSphere API
		<b>VirtualMachine.Inventory.Delete</b> <b>VirtualMachine.Provisioning.Clone</b> <b>VirtualMachine.Provisioning.DeployTemplate</b> <b>VirtualMachine.Provisioning.MarkAsTemplate</b> <b>Folder.Create</b> <b>Folder.Delete</b>

Example 20.17. Roles and privileges required for installation in vCenter graphical user interface (GUI)

vSphere object for role	When required	Required privileges in vCenter GUI
vSphere vCenter	Always	<b>Cns.Searchable</b> <b>"vSphere Tagging"."Assign or Unassign vSphere Tag"</b> <b>"vSphere Tagging"."Create vSphere Tag Category"</b> <b>"vSphere Tagging"."Create vSphere Tag"</b> <b>vSphere Tagging"."Delete vSphere Tag Category"</b> <b>"vSphere Tagging"."Delete vSphere Tag"</b> <b>"vSphere Tagging"."Edit vSphere Tag Category"</b> <b>"vSphere Tagging"."Edit vSphere Tag"</b> <b>Sessions."Validate session"</b> <b>"Profile-driven storage"."Profile-driven storage update"</b> <b>"Profile-driven storage"."Profile-driven storage view"</b>
vSphere vCenter Cluster	If VMs will be created in the cluster root	<b>Host.Configuration."Storage partition configuration"</b> <b>Resource."Assign virtual machine to resource pool"</b> <b>VApp."Assign resource pool"</b> <b>VApp.Import</b> <b>"Virtual machine"."Change Configuration"."Add new disk"</b>

vSphere object for role	When required	Required privileges in vCenter GUI
vSphere vCenter Resource Pool	If an existing resource pool is provided	<b>Host.Configuration."Storage partition configuration"</b> <b>Resource."Assign virtual machine to resource pool"</b> <b>VApp."Assign resource pool"</b> <b>VApp.Import</b> <b>"Virtual machine"."Change Configuration"."Add new disk"</b>
vSphere Datastore	Always	<b>Datastore."Allocate space"</b> <b>Datastore."Browse datastore"</b> <b>Datastore."Low level file operations"</b> <b>"vSphere Tagging"."Assign or Unassign vSphere Tag on Object"</b>
vSphere Port Group	Always	<b>Network."Assign network"</b>
Virtual Machine Folder	Always	<b>"vSphere Tagging"."Assign or Unassign vSphere Tag on Object"</b> <b>Resource."Assign virtual machine to resource pool"</b> <b>VApp.Import</b> <b>"Virtual machine"."Change Configuration"."Add existing disk"</b> <b>"Virtual machine"."Change Configuration"."Add new disk"</b> <b>"Virtual machine"."Change Configuration"."Add or remove device"</b> <b>"Virtual machine"."Change Configuration"."Advanced configuration"</b> <b>"Virtual machine"."Change Configuration"."Set annotation"</b> <b>"Virtual machine"."Change Configuration"."Change CPU count"</b> <b>"Virtual machine"."Change Configuration"."Extend virtual disk"</b> <b>"Virtual machine"."Change Configuration"."Acquire</b>

vSphere object for role	When required	Required privileges in vCenter GUI
		"disk lease" "Virtual machine".Change Configuration."Modify device settings" "Virtual machine".Change Configuration."Change Memory" "Virtual machine".Change Configuration."Remove disk" "Virtual machine".Change Configuration.Rename "Virtual machine".Change Configuration."Reset guest information" "Virtual machine".Change Configuration."Change resource" "Virtual machine".Change Configuration."Change Settings" "Virtual machine".Change Configuration."Upgrade virtual machine compatibility" "Virtual machine".Interaction."Guest operating system management by VIX API" "Virtual machine".Interaction."Power off" "Virtual machine".Interaction."Power on" "Virtual machine".Interaction.Reset "Virtual machine".Edit Inventory."Create new" "Virtual machine".Edit Inventory."Create from existing" "Virtual machine".Edit Inventory."Remove" "Virtual machine".Provisioning."Clone virtual machine" "Virtual machine".Provisioning."Mark as template" "Virtual machine".Provisioning."Deploy template"
vSphere vCenter Datacenter		"vSphere Tagging".Assign

vSphere object for role	If the installation program creates the virtual machine folder When required	or Unassign vSphere Tag on Object Resource."Assign virtual machine to resource pool" Required privileges in vCenter GUI
		VApp.Import "Virtual machine"."Change Configuration"."Add existing disk" "Virtual machine"."Change Configuration"."Add new disk" "Virtual machine"."Change Configuration"."Add or remove device" "Virtual machine"."Change Configuration"."Advanced configuration" "Virtual machine"."Change Configuration"."Set annotation" "Virtual machine"."Change Configuration"."Change CPU count" "Virtual machine"."Change Configuration"."Extend virtual disk" "Virtual machine"."Change Configuration"."Acquire disk lease" "Virtual machine"."Change Configuration"."Modify device settings" "Virtual machine"."Change Configuration"."Change Memory" "Virtual machine"."Change Configuration"."Remove disk" "Virtual machine"."Change Configuration".Rename "Virtual machine"."Change Configuration"."Reset guest information" "Virtual machine"."Change Configuration"."Change resource" "Virtual machine"."Change Configuration"."Change Settings" "Virtual machine"."Change Configuration"."Upgrade virtual machine compatibility" "Virtual machine".Interaction."Guest operating system

vSphere object for role	When required	management by VIX API" Required privileges in vCenter GUI "Virtual machine".Interaction."Power off" "Virtual machine".Interaction."Power on" "Virtual machine".Interaction.Reset "Virtual machine"."Edit Inventory"."Create new" "Virtual machine"."Edit Inventory"."Create from existing" "Virtual machine"."Edit Inventory"."Remove" "Virtual machine".Provisioning."Clone virtual machine" "Virtual machine".Provisioning."Deploy template" "Virtual machine".Provisioning."Mark as template" Folder."Create folder" Folder."Delete folder"

Additionally, the user requires some **ReadOnly** permissions, and some of the roles require permission to propagate the permissions to child objects. These settings vary depending on whether or not you install the cluster into an existing folder.

**Example 20.18. Required permissions and propagation settings**

vSphere object	When required	Propagate to children	Permissions required
vSphere vCenter	Always	False	Listed required privileges
vSphere vCenter Datacenter	Existing folder	False	<b>ReadOnly</b> permission
	Installation program creates the folder	True	Listed required privileges
vSphere vCenter Cluster	Existing resource pool	False	<b>ReadOnly</b> permission
	VMs in cluster root	True	Listed required privileges
vSphere vCenter Datastore	Always	False	Listed required privileges



vSphere object	When required	Propagate to children	Permissions required
vSphere Switch	Always	False	<b>ReadOnly</b> permission
vSphere Port Group	Always	False	Listed required privileges
vSphere vCenter Virtual Machine Folder	Existing folder	True	Listed required privileges
vSphere vCenter Resource Pool	Existing resource pool	True	Listed required privileges

For more information about creating an account with only the required privileges, see [vSphere Permissions and User Management Tasks](#) in the vSphere documentation.

### Using OpenShift Container Platform with vMotion

If you intend on using vMotion in your vSphere environment, consider the following before installing a OpenShift Container Platform cluster.

- OpenShift Container Platform generally supports compute-only vMotion. Using Storage vMotion can cause issues and is not supported.  
To help ensure the uptime of your compute and control plane nodes, it is recommended that you follow the VMware best practices for vMotion. It is also recommended to use VMware anti-affinity rules to improve the availability of OpenShift Container Platform during maintenance or hardware issues.

For more information about vMotion and anti-affinity rules, see the VMware vSphere documentation for [vMotion networking requirements](#) and [VM anti-affinity rules](#).

- If you are using vSphere volumes in your pods, migrating a VM across datastores either manually or through Storage vMotion causes, invalid references within OpenShift Container Platform persistent volume (PV) objects. These references prevent affected pods from starting up and can result in data loss.
- Similarly, OpenShift Container Platform does not support selective migration of VMDKs across datastores, using datastore clusters for VM provisioning or for dynamic or static provisioning of PVs, or using a datastore that is part of a datastore cluster for dynamic or static provisioning of PVs.

### Cluster resources

When you deploy an OpenShift Container Platform cluster that uses installer-provisioned infrastructure, the installation program must be able to create several resources in your vCenter instance.

A standard OpenShift Container Platform installation creates the following vCenter resources:

- 1 Folder
- 1 Tag category
- 1 Tag
- Virtual machines:

- 1 template
- 1 temporary bootstrap node
- 3 control plane nodes
- 3 compute machines

Although these resources use 856 GB of storage, the bootstrap node is destroyed during the cluster installation process. A minimum of 800 GB of storage is required to use a standard cluster.

If you deploy more compute machines, the OpenShift Container Platform cluster will use more storage.

### Cluster limits

Available resources vary between clusters. The number of possible clusters within a vCenter is limited primarily by available storage space and any limitations on the number of required resources. Be sure to consider both limitations to the vCenter resources that the cluster creates and the resources that you require to deploy a cluster, such as IP addresses and networks.

### Networking requirements

You must use the Dynamic Host Configuration Protocol (DHCP) for the network and ensure that the DHCP server is configured to provide persistent IP addresses to the cluster machines. In the DHCP lease, you must configure the DHCP to use the default gateway. All nodes must be in the same VLAN. You cannot scale the cluster using a second VLAN as a Day 2 operation. The VM in your restricted network must have access to vCenter so that it can provision and manage nodes, persistent volume claims (PVCs), and other resources. Additionally, you must create the following networking resources before you install the OpenShift Container Platform cluster:



#### NOTE

It is recommended that each OpenShift Container Platform node in the cluster must have access to a Network Time Protocol (NTP) server that is discoverable via DHCP. Installation is possible without an NTP server. However, asynchronous server clocks will cause errors, which NTP server prevents.

### Required IP Addresses

An installer-provisioned vSphere installation requires two static IP addresses:

- The **API** address is used to access the cluster API.
- The **Ingress** address is used for cluster ingress traffic.

You must provide these IP addresses to the installation program when you install the OpenShift Container Platform cluster.

### DNS records

You must create DNS records for two static IP addresses in the appropriate DNS server for the vCenter instance that hosts your OpenShift Container Platform cluster. In each record, **<cluster\_name>** is the cluster name and **<base\_domain>** is the cluster base domain that you specify when you install the cluster. A complete DNS record takes the form: **<component>.<cluster\_name>.<base\_domain>..**

#### Table 20.70. Required DNS records

Component	Record	Description
API VIP	<b>api.&lt;cluster_name&gt;.&lt;base_domain&gt;.</b>	This DNS A/AAAA or CNAME record must point to the load balancer for the control plane machines. This record must be resolvable by both clients external to the cluster and from all the nodes within the cluster.
Ingress VIP	<b>*.apps.&lt;cluster_name&gt;.&lt;base_domain&gt;.</b>	A wildcard DNS A/AAAA or CNAME record that points to the load balancer that targets the machines that run the Ingress router pods, which are the worker nodes by default. This record must be resolvable by both clients external to the cluster and from all the nodes within the cluster.

### 20.7.8. Generating a key pair for cluster node SSH access

During an OpenShift Container Platform installation, you can provide an SSH public key to the installation program. The key is passed to the Red Hat Enterprise Linux CoreOS (RHCOS) nodes through their Ignition config files and is used to authenticate SSH access to the nodes. The key is added to the `~/.ssh/authorized_keys` list for the **core** user on each node, which enables password-less authentication.

After the key is passed to the nodes, you can use the key pair to SSH in to the RHCOS nodes as the user **core**. To access the nodes through SSH, the private key identity must be managed by SSH for your local user.

If you want to SSH in to your cluster nodes to perform installation debugging or disaster recovery, you must provide the SSH public key during the installation process. The `./openshift-install gather` command also requires the SSH public key to be in place on the cluster nodes.



#### IMPORTANT

Do not skip this procedure in production environments, where disaster recovery and debugging is required.



#### NOTE

You must use a local key, not one that you configured with platform-specific approaches such as [AWS key pairs](#).

#### Procedure

1. If you do not have an existing SSH key pair on your local machine to use for authentication onto your cluster nodes, create one. For example, on a computer that uses a Linux operating system, run the following command:

```
$ ssh-keygen -t ed25519 -N "" -f <path>/<file_name> 1
```

- 1 Specify the path and file name, such as `~/.ssh/id_ed25519`, of the new SSH key. If you have an existing key pair, ensure your public key is in the your `~/.ssh` directory.



#### NOTE

If you plan to install an OpenShift Container Platform cluster that uses FIPS validated or Modules In Process cryptographic libraries on the **x86\_64** architecture, do not create a key that uses the **ed25519** algorithm. Instead, create a key that uses the **rsa** or **ecdsa** algorithm.

2. View the public SSH key:

```
$ cat <path>/<file_name>.pub
```

For example, run the following to view the `~/.ssh/id_ed25519.pub` public key:

```
$ cat ~/.ssh/id_ed25519.pub
```

3. Add the SSH private key identity to the SSH agent for your local user, if it has not already been added. SSH agent management of the key is required for password-less SSH authentication onto your cluster nodes, or if you want to use the `./openshift-install gather` command.



#### NOTE

On some distributions, default SSH private key identities such as `~/.ssh/id_rsa` and `~/.ssh/id_dsa` are managed automatically.

- a. If the **ssh-agent** process is not already running for your local user, start it as a background task:

```
$ eval "$(ssh-agent -s)"
```

#### Example output

```
Agent pid 31874
```



#### NOTE

If your cluster is in FIPS mode, only use FIPS-compliant algorithms to generate the SSH key. The key must be either RSA or ECDSA.

4. Add your SSH private key to the **ssh-agent**:

```
$ ssh-add <path>/<file_name> 1
```

- 1 Specify the path and file name for your SSH private key, such as `~/.ssh/id_ed25519`

## Example output

```
Identity added: /home/<you>/<path>/<file_name> (<computer_name>)
```

## Next steps

- When you install OpenShift Container Platform, provide the SSH public key to the installation program.

## 20.7.9. Adding vCenter root CA certificates to your system trust

Because the installation program requires access to your vCenter's API, you must add your vCenter's trusted root CA certificates to your system trust before you install an OpenShift Container Platform cluster.

### Procedure

1. From the vCenter home page, download the vCenter's root CA certificates. Click **Download trusted root CA certificates** in the vSphere Web Services SDK section. The **<vCenter>/certs/download.zip** file downloads.
2. Extract the compressed file that contains the vCenter root CA certificates. The contents of the compressed file resemble the following file structure:

```
certs
├── lin
│   ├── 108f4d17.0
│   ├── 108f4d17.r1
│   ├── 7e757f6a.0
│   ├── 8e4f8471.0
│   └── 8e4f8471.r0
├── mac
│   ├── 108f4d17.0
│   ├── 108f4d17.r1
│   ├── 7e757f6a.0
│   ├── 8e4f8471.0
│   └── 8e4f8471.r0
└── win
    ├── 108f4d17.0.crt
    ├── 108f4d17.r1.crl
    ├── 7e757f6a.0.crt
    ├── 8e4f8471.0.crt
    └── 8e4f8471.r0.crl
```

3 directories, 15 files

3. Add the files for your operating system to the system trust. For example, on a Fedora operating system, run the following command:

```
# cp certs/lin/* /etc/pki/ca-trust/source/anchors
```

4. Update your system trust. For example, on a Fedora operating system, run the following command:

```
# update-ca-trust extract
```

## 20.7.10. Creating the RHCOS image for restricted network installations

Download the Red Hat Enterprise Linux CoreOS (RHCOS) image to install OpenShift Container Platform on a restricted network VMware vSphere environment.

### Prerequisites

- Obtain the OpenShift Container Platform installation program. For a restricted network installation, the program is on your mirror registry host.

### Procedure

1. Log in to the Red Hat Customer Portal's [Product Downloads page](#).
2. Under **Version**, select the most recent release of OpenShift Container Platform 4.10 for RHEL 8.



### IMPORTANT

The RHCOS images might not change with every release of OpenShift Container Platform. You must download images with the highest version that is less than or equal to the OpenShift Container Platform version that you install. Use the image versions that match your OpenShift Container Platform version if they are available.

3. Download the **Red Hat Enterprise Linux CoreOS (RHCOS) - vSphere** image.
4. Upload the image you downloaded to a location that is accessible from the bastion server.

The image is now available for a restricted installation. Note the image name or location for use in OpenShift Container Platform deployment.

## 20.7.11. Creating the installation configuration file

You can customize the OpenShift Container Platform cluster you install on VMware vSphere.

### Prerequisites

- Obtain the OpenShift Container Platform installation program and the pull secret for your cluster. For a restricted network installation, these files are on your mirror host.
- Have the **imageContentSources** values that were generated during mirror registry creation.
- Obtain the contents of the certificate for your mirror registry.
- Retrieve a Red Hat Enterprise Linux CoreOS (RHCOS) image and upload it to an accessible location.
- Obtain service principal permissions at the subscription level.

### Procedure

1. Create the **install-config.yaml** file.
  - a. Change to the directory that contains the installation program and run the following command:

```
$ ./openshift-install create install-config --dir <installation_directory> 1
```

- 1** For **<installation\_directory>**, specify the directory name to store the files that the installation program creates.



### IMPORTANT

Specify an empty directory. Some installation assets, like bootstrap X.509 certificates have short expiration intervals, so you must not reuse an installation directory. If you want to reuse individual files from another cluster installation, you can copy them into your directory. However, the file names for the installation assets might change between releases. Use caution when copying installation files from an earlier OpenShift Container Platform version.

- b. At the prompts, provide the configuration details for your cloud:
    - i. Optional: Select an SSH key to use to access your cluster machines.



### NOTE

For production OpenShift Container Platform clusters on which you want to perform installation debugging or disaster recovery, specify an SSH key that your **ssh-agent** process uses.

- ii. Select **vsphere** as the platform to target.
      - iii. Specify the name of your vCenter instance.
      - iv. Specify the user name and password for the vCenter account that has the required permissions to create the cluster.  
The installation program connects to your vCenter instance.
      - v. Select the datacenter in your vCenter instance to connect to.
      - vi. Select the default vCenter datastore to use.
      - vii. Select the vCenter cluster to install the OpenShift Container Platform cluster in. The installation program uses the root resource pool of the vSphere cluster as the default resource pool.
      - viii. Select the network in the vCenter instance that contains the virtual IP addresses and DNS records that you configured.
      - ix. Enter the virtual IP address that you configured for control plane API access.
      - x. Enter the virtual IP address that you configured for cluster ingress.

- xi. Enter the base domain. This base domain must be the same one that you used in the DNS records that you configured.
  - xii. Enter a descriptive name for your cluster. The cluster name you enter must match the cluster name you specified when configuring the DNS records.
  - xiii. Paste the [pull secret from the Red Hat OpenShift Cluster Manager](#) .
2. In the **install-config.yaml** file, set the value of **platform.vsphere.clusterOSImage** to the image location or name. For example:

```
platform:
  vsphere:
    clusterOSImage: http://mirror.example.com/images/rhcos-43.81.201912131630.0-vmware.x86_64.ova?sha256=ffebbd68e8a1f2a245ca19522c16c86f67f9ac8e4e0c1f0a812b068b16f7265d
```

3. Edit the **install-config.yaml** file to give the additional information that is required for an installation in a restricted network.
- a. Update the **pullSecret** value to contain the authentication information for your registry:

```
pullSecret: '{"auths":{"<mirror_host_name>:5000":{"auth": "<credentials>","email": "you@example.com"}}}'
```

For **<mirror\_host\_name>**, specify the registry domain name that you specified in the certificate for your mirror registry, and for **<credentials>**, specify the base64-encoded user name and password for your mirror registry.

- b. Add the **additionalTrustBundle** parameter and value.

```
additionalTrustBundle: |
  -----BEGIN CERTIFICATE-----
  /-----END CERTIFICATE-----
```

The value must be the contents of the certificate file that you used for your mirror registry. The certificate file can be an existing, trusted certificate authority, or the self-signed certificate that you generated for the mirror registry.

- c. Add the image content resources, which resemble the following YAML excerpt:

```
imageContentSources:
- mirrors:
  - <mirror_host_name>:5000/<repo_name>/release
    source: quay.io/openshift-release-dev/ocp-release
- mirrors:
  - <mirror_host_name>:5000/<repo_name>/release
    source: registry.redhat.io/ocp/release
```

For these values, use the **imageContentSources** that you recorded during mirror registry creation.



4. Make any other modifications to the **install-config.yaml** file that you require. You can find more information about the available parameters in the **Installation configuration parameters** section.
5. Back up the **install-config.yaml** file so that you can use it to install multiple clusters.

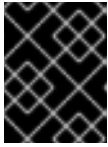

### IMPORTANT

The **install-config.yaml** file is consumed during the installation process. If you want to reuse the file, you must back it up now.

#### 20.7.11.1. Installation configuration parameters

Before you deploy an OpenShift Container Platform cluster, you provide parameter values to describe your account on the cloud platform that hosts your cluster and optionally customize your cluster's platform. When you create the **install-config.yaml** installation configuration file, you provide values for the required parameters through the command line. If you customize your cluster, you can modify the **install-config.yaml** file to provide more details about the platform.



### NOTE

After installation, you cannot modify these parameters in the **install-config.yaml** file.

#### 20.7.11.1.1. Required configuration parameters

Required installation configuration parameters are described in the following table:

**Table 20.71. Required parameters**

Parameter	Description	Values
<b>apiVersion</b>	The API version for the <b>install-config.yaml</b> content. The current version is <b>v1</b> . The installer may also support older API versions.	String
<b>baseDomain</b>	The base domain of your cloud provider. The base domain is used to create routes to your OpenShift Container Platform cluster components. The full DNS name for your cluster is a combination of the <b>baseDomain</b> and <b>metadata.name</b> parameter values that uses the <b>&lt;metadata.name&gt;.&lt;baseDomain&gt;</b> format.	A fully-qualified domain or subdomain name, such as <b>example.com</b> .

Parameter	Description	Values
<b>metadata</b>	Kubernetes resource <b>ObjectMeta</b> , from which only the <b>name</b> parameter is consumed.	Object
<b>metadata.name</b>	The name of the cluster. DNS records for the cluster are all subdomains of <b>{{.metadata.name}}</b> . <b>{{.baseDomain}}</b> .	String of lowercase letters and hyphens (-), such as <b>dev</b> .
<b>platform</b>	The configuration for the specific platform upon which to perform the installation: <b>alibabacloud, aws, baremetal, azure, gcp, ibmcloud, openstack, ovirt, vsphere</b> , or <b>{}</b> . For additional information about <b>platform.&lt;platform&gt;</b> parameters, consult the table for your specific platform that follows.	Object
<b>pullSecret</b>	Get a <a href="#">pull secret from the Red Hat OpenShift Cluster Manager</a> to authenticate downloading container images for OpenShift Container Platform components from services such as Quay.io.	<pre>{   "auths":{     "cloud.openshift.com":{       "auth":"b3Blb=",       "email":"you@example.com"     },     "quay.io":{       "auth":"b3Blb=",       "email":"you@example.com"     }   } }</pre>

### 20.7.11.1.2. Network configuration parameters

You can customize your installation configuration based on the requirements of your existing network infrastructure. For example, you can expand the IP address block for the cluster network or provide different IP address blocks than the defaults.

Only IPv4 addresses are supported.

Table 20.72. Network parameters

Parameter	Description	Values
<b>networking</b>	The configuration for the cluster network.	Object  <b>NOTE</b> You cannot modify parameters specified by the <b>networking</b> object after installation.
<b>networking.networkType</b>	The cluster network provider Container Network Interface (CNI) plugin to install.	Either <b>OpenShiftSDN</b> or <b>OVNKubernetes</b> . <b>OpenShiftSDN</b> is a CNI provider for all-Linux networks. <b>OVNKubernetes</b> is a CNI provider for Linux networks and hybrid networks that contain both Linux and Windows servers. The default value is <b>OpenShiftSDN</b> .
<b>networking.clusterNetwork</b>	The IP address blocks for pods.  The default value is <b>10.128.0.0/14</b> with a host prefix of <b>/23</b> .  If you specify multiple IP address blocks, the blocks must not overlap.	An array of objects. For example:  <pre>networking:   clusterNetwork:     - cidr: 10.128.0.0/14       hostPrefix: 23</pre>
<b>networking.clusterNetwork.cidr</b>	Required if you use <b>networking.clusterNetwork</b> . An IP address block.  An IPv4 network.	An IP address block in Classless Inter-Domain Routing (CIDR) notation. The prefix length for an IPv4 block is between <b>0</b> and <b>32</b> .
<b>networking.clusterNetwork.hostPrefix</b>	The subnet prefix length to assign to each individual node. For example, if <b>hostPrefix</b> is set to <b>23</b> then each node is assigned a <b>/23</b> subnet out of the given <b>cidr</b> . A <b>hostPrefix</b> value of <b>23</b> provides 510 ( $2^{(32 - 23)} - 2$ ) pod IP addresses.	A subnet prefix.  The default value is <b>23</b> .
<b>networking.serviceNetwork</b>	The IP address block for services. The default value is <b>172.30.0.0/16</b> .  The OpenShift SDN and OVN-Kubernetes network providers support only a single IP address block for the service network.	An array with an IP address block in CIDR format. For example:  <pre>networking:   serviceNetwork:     - 172.30.0.0/16</pre>

Parameter	Description	Values
<b>networking.machineNetwork</b>	The IP address blocks for machines.  If you specify multiple IP address blocks, the blocks must not overlap.	An array of objects. For example:  <pre>networking:   machineNetwork:   - cidr: 10.0.0.0/16</pre>
<b>networking.machineNetwork.cidr</b>	Required if you use <b>networking.machineNetwork</b> . An IP address block. The default value is <b>10.0.0.0/16</b> for all platforms other than libvirt. For libvirt, the default value is <b>192.168.126.0/24</b> .	An IP network block in CIDR notation.  For example, <b>10.0.0.0/16</b> .   <p><b>NOTE</b></p> <p>Set the <b>networking.machineNetwork</b> to match the CIDR that the preferred NIC resides in.</p>

### 20.7.11.1.3. Optional configuration parameters



Optional installation configuration parameters are described in the following table:

Table 20.73. Optional parameters

Parameter	Description	Values
<b>additionalTrustBundle</b>	A PEM-encoded X.509 certificate bundle that is added to the nodes' trusted certificate store. This trust bundle may also be used when a proxy has been configured.	String
<b>cgroupsV2</b>	Enables <a href="#">Linux control groups version 2</a> (cgroups v2) on specific nodes in your cluster. The OpenShift Container Platform process for enabling cgroups v2 disables all cgroup version 1 controllers and hierarchies. The OpenShift Container Platform cgroups version 2 feature is in Developer Preview and is not supported by Red Hat at this time.	<b>true</b>
<b>compute</b>	The configuration for the machines that comprise the compute nodes.	Array of <b>MachinePool</b> objects.



Parameter	Description	Values
<b>compute.architecture</b>	Determines the instruction set architecture of the machines in the pool. Currently, clusters with varied architectures are not supported. All pools must specify the same architecture. Valid values are <b>amd64</b> (the default).	String
<b>compute.hyperthreading</b>	Whether to enable or disable simultaneous multithreading, or <b>hyperthreading</b> , on compute machines. By default, simultaneous multithreading is enabled to increase the performance of your machines' cores.   <b>IMPORTANT</b>  If you disable simultaneous multithreading, ensure that your capacity planning accounts for the dramatically decreased machine performance.	<b>Enabled</b> or <b>Disabled</b>
<b>compute.name</b>	Required if you use <b>compute</b> . The name of the machine pool.	<b>worker</b>
<b>compute.platform</b>	Required if you use <b>compute</b> . Use this parameter to specify the cloud provider to host the worker machines. This parameter value must match the <b>controlPlane.platform</b> parameter value.	<b>alibabacloud, aws, azure, gcp, ibmcloud, openstack, ovirt, vsphere</b> , or <b>{}</b>
<b>compute.replicas</b>	The number of compute machines, which are also known as worker machines, to provision.	A positive integer greater than or equal to <b>2</b> . The default value is <b>3</b> .
<b>controlPlane</b>	The configuration for the machines that comprise the control plane.	Array of <b>MachinePool</b> objects.

Parameter	Description	Values
<b>controlPlane.architecture</b>	Determines the instruction set architecture of the machines in the pool. Currently, clusters with varied architectures are not supported. All pools must specify the same architecture. Valid values are <b>amd64</b> (the default).	String
<b>controlPlane.hyperthreading</b>	Whether to enable or disable simultaneous multithreading, or <b>hyperthreading</b> , on control plane machines. By default, simultaneous multithreading is enabled to increase the performance of your machines' cores.   <b>IMPORTANT</b>  If you disable simultaneous multithreading, ensure that your capacity planning accounts for the dramatically decreased machine performance.	<b>Enabled</b> or <b>Disabled</b>
<b>controlPlane.name</b>	Required if you use <b>controlPlane</b> . The name of the machine pool.	<b>master</b>
<b>controlPlane.platform</b>	Required if you use <b>controlPlane</b> . Use this parameter to specify the cloud provider that hosts the control plane machines. This parameter value must match the <b>compute.platform</b> parameter value.	<b>alibabacloud, aws, azure, gcp, ibmcloud, openstack, ovirt, vsphere, or {}</b>
<b>controlPlane.replicas</b>	The number of control plane machines to provision.	The only supported value is <b>3</b> , which is the default value.

Parameter	Description	Values
<b>credentialsMode</b>	<p>The Cloud Credential Operator (CCO) mode. If no mode is specified, the CCO dynamically tries to determine the capabilities of the provided credentials, with a preference for mint mode on the platforms where multiple modes are supported.</p> <div data-bbox="486 517 595 864" style="border: 1px solid black; padding: 5px; margin-bottom: 10px;">  </div> <p><b>NOTE</b></p> <p>Not all CCO modes are supported for all cloud providers. For more information on CCO modes, see the <i>Cloud Credential Operator</i> entry in the <i>Cluster Operators</i> reference content.</p> <div data-bbox="486 909 595 1256" style="border: 1px solid black; padding: 5px;">  </div> <p><b>NOTE</b></p> <p>If your AWS account has service control policies (SCP) enabled, you must configure the <b>credentialsMode</b> parameter to <b>Mint</b>, <b>Passthrough</b> or <b>Manual</b>.</p>	<b>Mint, Passthrough, Manual</b> or an empty string ("").

Parameter	Description	Values
<b>fips</b>	<p>Enable or disable FIPS mode. The default is <b>false</b> (disabled). If FIPS mode is enabled, the Red Hat Enterprise Linux CoreOS (RHCOS) machines that OpenShift Container Platform runs on bypass the default Kubernetes cryptography suite and use the cryptography modules that are provided with RHCOS instead.</p> <div style="display: flex; align-items: flex-start;"> <div style="width: 20px; height: 100px; background: repeating-linear-gradient(45deg, transparent, transparent 2px, black 2px, black 4px); margin-right: 10px;"></div> <div> <p><b>IMPORTANT</b></p> <p>To enable FIPS mode for your cluster, you must run the installation program from a Red Hat Enterprise Linux (RHEL) computer configured to operate in FIPS mode. For more information about configuring FIPS mode on RHEL, see <a href="#">Installing the system in FIPS mode</a>. The use of FIPS validated or Modules In Process cryptographic libraries is only supported on OpenShift Container Platform deployments on the <b>x86_64</b> architecture.</p> </div> </div> <div style="display: flex; align-items: flex-start; margin-top: 10px;"> <div style="width: 20px; height: 50px; background: repeating-linear-gradient(45deg, transparent, transparent 2px, black 2px, black 4px); margin-right: 10px;"></div> <div> <p><b>NOTE</b></p> <p>If you are using Azure File storage, you cannot enable FIPS mode.</p> </div> </div>	<b>false</b> or <b>true</b>
<b>imageContentSources</b>	Sources and repositories for the release-image content.	Array of objects. Includes a <b>source</b> and, optionally, <b>mirrors</b> , as described in the following rows of this table.
<b>imageContentSources.source</b>	Required if you use <b>imageContentSources</b> . Specify the repository that users refer to, for example, in image pull specifications.	String
<b>imageContentSources.mirrors</b>	Specify one or more repositories that may also contain the same images.	Array of strings



Parameter	Description	Values
<b>publish</b>	How to publish or expose the user-facing endpoints of your cluster, such as the Kubernetes API, OpenShift routes.	<p><b>Internal</b> or <b>External</b>. The default value is <b>External</b>.</p> <p>Setting this field to <b>Internal</b> is not supported on non-cloud platforms and IBM Cloud VPC.</p> <div style="display: flex; align-items: flex-start;">  <div> <p><b>IMPORTANT</b></p> <p>If the value of the field is set to <b>Internal</b>, the cluster will become non-functional. For more information, refer to <a href="#">BZ#1953035</a>.</p> </div> </div>
<b>sshKey</b>	<p>The SSH key or keys to authenticate access your cluster machines.</p> <div style="display: flex; align-items: flex-start;">  <div> <p><b>NOTE</b></p> <p>For production OpenShift Container Platform clusters on which you want to perform installation debugging or disaster recovery, specify an SSH key that your <b>ssh-agent</b> process uses.</p> </div> </div>	<p>One or more keys. For example:</p> <pre>sshKey:   &lt;key1&gt;   &lt;key2&gt;   &lt;key3&gt;</pre>

#### 20.7.11.1.4. Additional VMware vSphere configuration parameters

Additional VMware vSphere configuration parameters are described in the following table:

Table 20.74. Additional VMware vSphere cluster parameters

Parameter	Description	Values
<b>platform.vsphere.vcenter</b>	The fully-qualified hostname or IP address of the vCenter server.	String
<b>platform.vsphere.username</b>	The user name to use to connect to the vCenter instance with. This user must have at least the roles and privileges that are required for <a href="#">static or dynamic persistent volume provisioning</a> in vSphere.	String

Parameter	Description	Values
<b>platform.vsphere.password</b>	The password for the vCenter user name.	String
<b>platform.vsphere.datacenter</b>	The name of the datacenter to use in the vCenter instance.	String
<b>platform.vsphere.defaultDatastore</b>	The name of the default datastore to use for provisioning volumes.	String
<b>platform.vsphere.folder</b>	Optional. The absolute path of an existing folder where the installation program creates the virtual machines. If you do not provide this value, the installation program creates a folder that is named with the infrastructure ID in the datacenter virtual machine folder.	String, for example, <code>/&lt;datacenter_name&gt;/vm/&lt;folder_name&gt;/&lt;subfolder_name&gt;</code> .
<b>platform.vsphere.resourcePool</b>	Optional. The absolute path of an existing resource pool where the installer creates the virtual machines. If you do not specify a value, resources are installed in the root of the cluster <code>/&lt;datacenter_name&gt;/host/&lt;cluster_name&gt;/Resources</code> .	String, for example, <code>/&lt;datacenter_name&gt;/host/&lt;cluster_name&gt;/Resources/&lt;resource_pool_name&gt;/&lt;optional_nested_resource_pool_name&gt;</code> .
<b>platform.vsphere.network</b>	The network in the vCenter instance that contains the virtual IP addresses and DNS records that you configured.	String
<b>platform.vsphere.cluster</b>	The vCenter cluster to install the OpenShift Container Platform cluster in.	String
<b>platform.vsphere.apiVIP</b>	The virtual IP (VIP) address that you configured for control plane API access.	An IP address, for example <b>128.0.0.1</b> .
<b>platform.vsphere.ingressVIP</b>	The virtual IP (VIP) address that you configured for cluster ingress.	An IP address, for example <b>128.0.0.1</b> .
<b>platform.vsphere.diskType</b>	Optional. The disk provisioning method. This value defaults to the vSphere default storage policy if not set.	Valid values are <b>thin</b> , <b>thick</b> , or <b>eagerZeroedThick</b> .

#### 20.7.11.1.5. Optional VMware vSphere machine pool configuration parameters

Optional VMware vSphere machine pool configuration parameters are described in the following table:

**Table 20.75. Optional VMware vSphere machine pool parameters**

Parameter	Description	Values
<b>platform.vsphere.clusterOSImage</b>	The location from which the installer downloads the RHCOS image. You must set this parameter to perform an installation in a restricted network.	An HTTP or HTTPS URL, optionally with a SHA-256 checksum. For example, <b>https://mirror.openshift.com/images/rhcos-&lt;version&gt;-vmware.&lt;architecture&gt;.ova.</b>
<b>platform.vsphere.osDisk.diskSizeGB</b>	The size of the disk in gigabytes.	Integer
<b>platform.vsphere.cpus</b>	The total number of virtual processor cores to assign a virtual machine. The value of <b>platform.vsphere.cpus</b> must be a multiple of <b>platform.vsphere.coresPerSocket</b> value.	Integer
<b>platform.vsphere.coresPerSocket</b>	The number of cores per socket in a virtual machine. The number of virtual sockets on the virtual machine is <b>platform.vsphere.cpus/platform.vsphere.coresPerSocket</b> . The default value for control plane nodes and worker nodes is <b>4</b> and <b>2</b> , respectively.	Integer
<b>platform.vsphere.memoryMB</b>	The size of a virtual machine's memory in megabytes.	Integer

### 20.7.11.2. Sample install-config.yaml file for an installer-provisioned VMware vSphere cluster

You can customize the install-config.yaml file to specify more details about your OpenShift Container Platform cluster's platform or modify the values of the required parameters.

```

apiVersion: v1
baseDomain: example.com 1
compute: 2
- hyperthreading: Enabled 3
  name: worker
  replicas: 3
platform:
  vsphere: 4
    cpus: 2
    coresPerSocket: 2
    memoryMB: 8192

```



- 3 6 Whether to enable or disable simultaneous multithreading, or **hyperthreading**. By default, simultaneous multithreading is enabled to increase the performance of your machines' cores. You



### IMPORTANT

If you disable simultaneous multithreading, ensure that your capacity planning accounts for the dramatically decreased machine performance. Your machines must use at least 8 CPUs and 32 GB of RAM if you disable simultaneous multithreading.

- 4 7 Optional: Provide additional configuration for the machine pool parameters for the compute and control plane machines.
- 8 The cluster name that you specified in your DNS records.
- 9 Optional: Provide an existing resource pool for machine creation. If you do not specify a value, the installation program uses the root resource pool of the vSphere cluster.
- 10 The vSphere disk provisioning method.
- 11 The vSphere cluster to install the OpenShift Container Platform cluster in.
- 12 The location of the Red Hat Enterprise Linux CoreOS (RHCOS) image that is accessible from the bastion server.
- 13 For **<local\_registry>**, specify the registry domain name, and optionally the port, that your mirror registry uses to serve content. For example **registry.example.com** or **registry.example.com:5000**. For **<credentials>**, specify the base64-encoded user name and password for your mirror registry.
- 14 Provide the contents of the certificate file that you used for your mirror registry.
- 15 Provide the **imageContentSources** section from the output of the command to mirror the repository.

### 20.7.11.3. Configuring the cluster-wide proxy during installation

Production environments can deny direct access to the internet and instead have an HTTP or HTTPS proxy available. You can configure a new OpenShift Container Platform cluster to use a proxy by configuring the proxy settings in the **install-config.yaml** file.

#### Prerequisites

- You have an existing **install-config.yaml** file.
- You reviewed the sites that your cluster requires access to and determined whether any of them need to bypass the proxy. By default, all cluster egress traffic is proxied, including calls to hosting cloud provider APIs. You added sites to the **Proxy** object's **spec.noProxy** field to bypass the proxy if necessary.



## NOTE

The **Proxy** object **status.noProxy** field is populated with the values of the **networking.machineNetwork[].cidr**, **networking.clusterNetwork[].cidr**, and **networking.serviceNetwork[]** fields from your installation configuration.

For installations on Amazon Web Services (AWS), Google Cloud Platform (GCP), Microsoft Azure, and Red Hat OpenStack Platform (RHOSP), the **Proxy** object **status.noProxy** field is also populated with the instance metadata endpoint (**169.254.169.254**).

## Procedure

1. Edit your **install-config.yaml** file and add the proxy settings. For example:

```
apiVersion: v1
baseDomain: my.domain.com
proxy:
  httpProxy: http://<username>:<pswd>@<ip>:<port> 1
  httpsProxy: https://<username>:<pswd>@<ip>:<port> 2
  noProxy: example.com 3
  additionalTrustBundle: | 4
    -----BEGIN CERTIFICATE-----
    <MY_TRUSTED_CA_CERT>
    -----END CERTIFICATE-----
  ...
```

- 1 A proxy URL to use for creating HTTP connections outside the cluster. The URL scheme must be **http**.
- 2 A proxy URL to use for creating HTTPS connections outside the cluster.
- 3 A comma-separated list of destination domain names, IP addresses, or other network CIDRs to exclude from proxying. Preface a domain with **.** to match subdomains only. For example, **.y.com** matches **x.y.com**, but not **y.com**. Use **\*** to bypass the proxy for all destinations. You must include vCenter's IP address and the IP range that you use for its machines.
- 4 If provided, the installation program generates a config map that is named **user-ca-bundle** in the **openshift-config** namespace that contains one or more additional CA certificates that are required for proxying HTTPS connections. The Cluster Network Operator then creates a **trusted-ca-bundle** config map that merges these contents with the Red Hat Enterprise Linux CoreOS (RHCOS) trust bundle, and this config map is referenced in the **trustedCA** field of the **Proxy** object. The **additionalTrustBundle** field is required unless the proxy's identity certificate is signed by an authority from the RHCOS trust bundle.



## NOTE

The installation program does not support the proxy **readinessEndpoints** field.

**NOTE**

If the installer times out, restart and then complete the deployment by using the **wait-for** command of the installer. For example:

```
$ ./openshift-install wait-for install-complete --log-level debug
```

2. Save the file and reference it when installing OpenShift Container Platform.

The installation program creates a cluster-wide proxy that is named **cluster** that uses the proxy settings in the provided **install-config.yaml** file. If no proxy settings are provided, a **cluster Proxy** object is still created, but it will have a nil **spec**.

**NOTE**

Only the **Proxy** object named **cluster** is supported, and no additional proxies can be created.

## 20.7.12. Deploying the cluster

You can install OpenShift Container Platform on a compatible cloud platform.

**IMPORTANT**

You can run the **create cluster** command of the installation program only once, during initial installation.

### Prerequisites

- Obtain the OpenShift Container Platform installation program and the pull secret for your cluster.

### Procedure

1. Change to the directory that contains the installation program and initialize the cluster deployment:

```
$ ./openshift-install create cluster --dir <installation_directory> \ 1
--log-level=info 2
```

- 1 For **<installation\_directory>**, specify the location of your customized **./install-config.yaml** file.
- 2 To view different installation details, specify **warn**, **debug**, or **error** instead of **info**.

When the cluster deployment completes, directions for accessing your cluster, including a link to its web console and credentials for the **kubeadmin** user, display in your terminal.

```
...
INFO Install complete!
INFO To access the cluster as the system:admin user when using 'oc', run 'export
KUBECONFIG=/home/myuser/install_dir/auth/kubeconfig'
```

INFO Access the OpenShift web-console here: <https://console-openshift-console.apps.mycluster.example.com>

INFO Login to the console with user: "kubeadmin", and password: "4vYBz-Ee6gm-ymBZj-Wt5AL"

INFO Time elapsed: 36m22s

+



## NOTE

The cluster access and credential information also outputs to **<installation\_directory>/openshift\_install.log** when an installation succeeds.

+

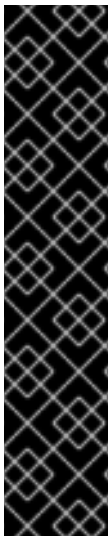

## IMPORTANT

- The Ignition config files that the installation program generates contain certificates that expire after 24 hours, which are then renewed at that time. If the cluster is shut down before renewing the certificates and the cluster is later restarted after the 24 hours have elapsed, the cluster automatically recovers the expired certificates. The exception is that you must manually approve the pending **node-bootstrapper** certificate signing requests (CSRs) to recover kubelet certificates. See the documentation for *Recovering from expired control plane certificates* for more information.
- It is recommended that you use Ignition config files within 12 hours after they are generated because the 24-hour certificate rotates from 16 to 22 hours after the cluster is installed. By using the Ignition config files within 12 hours, you can avoid installation failure if the certificate update runs during installation.

+

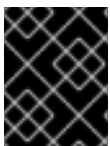

## IMPORTANT

You must not delete the installation program or the files that the installation program creates. Both are required to delete the cluster.

### 20.7.13. Installing the OpenShift CLI by downloading the binary

You can install the OpenShift CLI (**oc**) to interact with OpenShift Container Platform from a command-line interface. You can install **oc** on Linux, Windows, or macOS.



## IMPORTANT

If you installed an earlier version of **oc**, you cannot use it to complete all of the commands in OpenShift Container Platform 4.10. Download and install the new version of **oc**.

#### Installing the OpenShift CLI on Linux

You can install the OpenShift CLI (**oc**) binary on Linux by using the following procedure.

#### Procedure



1. Navigate to the [OpenShift Container Platform downloads page](#) on the Red Hat Customer Portal.
2. Select the appropriate version in the **Version** drop-down menu.
3. Click **Download Now** next to the **OpenShift v4.10 Linux Client** entry and save the file.
4. Unpack the archive:

```
$ tar xvf <file>
```

5. Place the **oc** binary in a directory that is on your **PATH**.  
To check your **PATH**, execute the following command:

```
$ echo $PATH
```

After you install the OpenShift CLI, it is available using the **oc** command:

```
$ oc <command>
```

### Installing the OpenShift CLI on Windows

You can install the OpenShift CLI (**oc**) binary on Windows by using the following procedure.

#### Procedure

1. Navigate to the [OpenShift Container Platform downloads page](#) on the Red Hat Customer Portal.
2. Select the appropriate version in the **Version** drop-down menu.
3. Click **Download Now** next to the **OpenShift v4.10 Windows Client** entry and save the file.
4. Unzip the archive with a ZIP program.
5. Move the **oc** binary to a directory that is on your **PATH**.  
To check your **PATH**, open the command prompt and execute the following command:

```
C:\> path
```

After you install the OpenShift CLI, it is available using the **oc** command:

```
C:\> oc <command>
```

### Installing the OpenShift CLI on macOS

You can install the OpenShift CLI (**oc**) binary on macOS by using the following procedure.

#### Procedure

1. Navigate to the [OpenShift Container Platform downloads page](#) on the Red Hat Customer Portal.
2. Select the appropriate version in the **Version** drop-down menu.
3. Click **Download Now** next to the **OpenShift v4.10 MacOSX Client** entry and save the file.

4. Unpack and unzip the archive.
5. Move the **oc** binary to a directory on your PATH.  
To check your **PATH**, open a terminal and execute the following command:

```
$ echo $PATH
```

After you install the OpenShift CLI, it is available using the **oc** command:

```
$ oc <command>
```

### 20.7.14. Logging in to the cluster by using the CLI

You can log in to your cluster as a default system user by exporting the cluster **kubeconfig** file. The **kubeconfig** file contains information about the cluster that is used by the CLI to connect a client to the correct cluster and API server. The file is specific to a cluster and is created during OpenShift Container Platform installation.

#### Prerequisites

- You deployed an OpenShift Container Platform cluster.
- You installed the **oc** CLI.

#### Procedure

1. Export the **kubeadmin** credentials:

```
$ export KUBECONFIG=<installation_directory>/auth/kubeconfig 1
```

- 1** For **<installation\_directory>**, specify the path to the directory that you stored the installation files in.

2. Verify you can run **oc** commands successfully using the exported configuration:

```
$ oc whoami
```

#### Example output

```
system:admin
```

### 20.7.15. Disabling the default OperatorHub sources

Operator catalogs that source content provided by Red Hat and community projects are configured for OperatorHub by default during an OpenShift Container Platform installation. In a restricted network environment, you must disable the default catalogs as a cluster administrator.

#### Procedure

- Disable the sources for the default catalogs by adding **disableAllDefaultSources: true** to the **OperatorHub** object:

```
$ oc patch OperatorHub cluster --type json \
  -p '[{"op": "add", "path": "/spec/disableAllDefaultSources", "value": true}]'
```

## TIP

Alternatively, you can use the web console to manage catalog sources. From the **Administration** → **Cluster Settings** → **Configuration** → **OperatorHub** page, click the **Sources** tab, where you can create, delete, disable, and enable individual sources.

## 20.7.16. Creating registry storage

After you install the cluster, you must create storage for the Registry Operator.

### 20.7.16.1. Image registry removed during installation

On platforms that do not provide shareable object storage, the OpenShift Image Registry Operator bootstraps itself as **Removed**. This allows **openshift-installer** to complete installations on these platform types.

After installation, you must edit the Image Registry Operator configuration to switch the **managementState** from **Removed** to **Managed**.

### 20.7.16.2. Image registry storage configuration

The Image Registry Operator is not initially available for platforms that do not provide default storage. After installation, you must configure your registry to use storage so that the Registry Operator is made available.

Instructions are shown for configuring a persistent volume, which is required for production clusters. Where applicable, instructions are shown for configuring an empty directory as the storage location, which is available for only non-production clusters.

Additional instructions are provided for allowing the image registry to use block storage types by using the **Recreate** rollout strategy during upgrades.

#### 20.7.16.2.1. Configuring registry storage for VMware vSphere

As a cluster administrator, following installation you must configure your registry to use storage.

### Prerequisites

- Cluster administrator permissions.
- A cluster on VMware vSphere.
- Persistent storage provisioned for your cluster, such as Red Hat OpenShift Data Foundation.

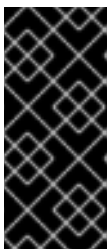

### IMPORTANT

OpenShift Container Platform supports **ReadWriteOnce** access for image registry storage when you have only one replica. **ReadWriteOnce** access also requires that the registry uses the **Recreate** rollout strategy. To deploy an image registry that supports high availability with two or more replicas, **ReadWriteMany** access is required.

- Must have "100Gi" capacity.



## IMPORTANT

Testing shows issues with using the NFS server on RHEL as storage backend for core services. This includes the OpenShift Container Registry and Quay, Prometheus for monitoring storage, and Elasticsearch for logging storage. Therefore, using RHEL NFS to back PVs used by core services is not recommended.

Other NFS implementations on the marketplace might not have these issues. Contact the individual NFS implementation vendor for more information on any testing that was possibly completed against these OpenShift Container Platform core components.

## Procedure

1. To configure your registry to use storage, change the **spec.storage.pvc** in the **configs.imageregistry/cluster** resource.



## NOTE

When using shared storage, review your security settings to prevent outside access.

2. Verify that you do not have a registry pod:

```
$ oc get pod -n openshift-image-registry -l docker-registry=default
```

## Example output

```
No resources found in openshift-image-registry namespace
```



## NOTE

If you do have a registry pod in your output, you do not need to continue with this procedure.

3. Check the registry configuration:

```
$ oc edit configs.imageregistry.operator.openshift.io
```

## Example output

```
storage:
  pvc:
    claim: 1
```

- 1** Leave the **claim** field blank to allow the automatic creation of an **image-registry-storage** persistent volume claim (PVC). The PVC is generated based on the default storage class. However, be aware that the default storage class might provide ReadWriteOnce (RWO) volumes, such as a RADOS Block Device (RBD), which can cause issues when replicating to more than one replica.

4. Check the **clusteroperator** status:

```
$ oc get clusteroperator image-registry
```

#### Example output

NAME	VERSION	AVAILABLE	PROGRESSING	DEGRADED
image-registry	4.7	True	False	6h50m

### 20.7.17. Telemetry access for OpenShift Container Platform

In OpenShift Container Platform 4.10, the Telemetry service, which runs by default to provide metrics about cluster health and the success of updates, requires internet access. If your cluster is connected to the internet, Telemetry runs automatically, and your cluster is registered to [OpenShift Cluster Manager](#).

After you confirm that your [OpenShift Cluster Manager](#) inventory is correct, either maintained automatically by Telemetry or manually by using OpenShift Cluster Manager, [use subscription watch](#) to track your OpenShift Container Platform subscriptions at the account or multi-cluster level.

#### Additional resources

- See [About remote health monitoring](#) for more information about the Telemetry service

### 20.7.18. Next steps

- [Customize your cluster](#).
- If necessary, you can [opt out of remote health reporting](#).
- If necessary, see [Registering your disconnected cluster](#)
- [Set up your registry and configure registry storage](#).

## 20.8. INSTALLING A CLUSTER ON VSPHERE IN A RESTRICTED NETWORK WITH USER-PROVISIONED INFRASTRUCTURE

In OpenShift Container Platform version 4.10, you can install a cluster on VMware vSphere infrastructure that you provision in a restricted network.



#### NOTE

OpenShift Container Platform supports deploying a cluster to a single VMware vCenter only. Deploying a cluster with machines/machine sets on multiple vCenters is not supported.

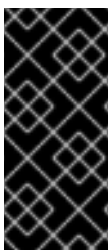

#### IMPORTANT

The steps for performing a user-provisioned infrastructure installation are provided as an example only. Installing a cluster with infrastructure you provide requires knowledge of the vSphere platform and the installation process of OpenShift Container Platform. Use the user-provisioned infrastructure installation instructions as a guide; you are free to create the required resources through other methods.

## 20.8.1. Prerequisites

- You reviewed details about the [OpenShift Container Platform installation and update](#) processes.
- You read the documentation on [selecting a cluster installation method and preparing it for users](#).
- You [created a registry on your mirror host](#) and obtained the **imageContentSources** data for your version of OpenShift Container Platform.

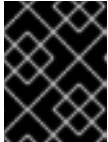

### IMPORTANT

Because the installation media is on the mirror host, you can use that computer to complete all installation steps.

- You provisioned [persistent storage](#) for your cluster. To deploy a private image registry, your storage must provide **ReadWriteMany** access modes.
- Completing the installation requires that you upload the Red Hat Enterprise Linux CoreOS (RHCOS) OVA on vSphere hosts. The machine from which you complete this process requires access to port 443 on the vCenter and ESXi hosts. You verified that port 443 is accessible.
- If you use a firewall, you confirmed with the administrator that port 443 is accessible. Control plane nodes must be able to reach vCenter and ESXi hosts on port 443 for the installation to succeed.
- If you use a firewall and plan to use the Telemetry service, you [configured the firewall to allow the sites](#) that your cluster requires access to.



### NOTE

Be sure to also review this site list if you are configuring a proxy.

## 20.8.2. About installations in restricted networks

In OpenShift Container Platform 4.10, you can perform an installation that does not require an active connection to the internet to obtain software components. Restricted network installations can be completed using installer-provisioned infrastructure or user-provisioned infrastructure, depending on the cloud platform to which you are installing the cluster.

If you choose to perform a restricted network installation on a cloud platform, you still require access to its cloud APIs. Some cloud functions, like Amazon Web Service's Route 53 DNS and IAM services, require internet access. Depending on your network, you might require less internet access for an installation on bare metal hardware or on VMware vSphere.

To complete a restricted network installation, you must create a registry that mirrors the contents of the OpenShift image registry and contains the installation media. You can create this registry on a mirror host, which can access both the internet and your closed network, or by using other methods that meet your restrictions.



## IMPORTANT

Because of the complexity of the configuration for user-provisioned installations, consider completing a standard user-provisioned infrastructure installation before you attempt a restricted network installation using user-provisioned infrastructure. Completing this test installation might make it easier to isolate and troubleshoot any issues that might arise during your installation in a restricted network.

### 20.8.2.1. Additional limits

Clusters in restricted networks have the following additional limitations and restrictions:

- The **ClusterVersion** status includes an **Unable to retrieve available updates** error.
- By default, you cannot use the contents of the Developer Catalog because you cannot access the required image stream tags.

### 20.8.3. Internet access for OpenShift Container Platform

In OpenShift Container Platform 4.10, you require access to the internet to obtain the images that are necessary to install your cluster.

You must have internet access to:

- Access [OpenShift Cluster Manager](#) to download the installation program and perform subscription management. If the cluster has internet access and you do not disable Telemetry, that service automatically entitles your cluster.
- Access [Quay.io](#) to obtain the packages that are required to install your cluster.
- Obtain the packages that are required to perform cluster updates.



## IMPORTANT

If your cluster cannot have direct internet access, you can perform a restricted network installation on some types of infrastructure that you provision. During that process, you download the required content and use it to populate a mirror registry with the installation packages. With some installation types, the environment that you install your cluster in will not require internet access. Before you update the cluster, you update the content of the mirror registry.

### 20.8.4. VMware vSphere infrastructure requirements

You must install the OpenShift Container Platform cluster on a VMware vSphere version 7 instance that meets the requirements for the components that you use.



## NOTE

OpenShift Container Platform version 4.10 does not support VMware vSphere version 8.0.

You can host the VMware vSphere infrastructure on-premise or on a [VMware Cloud Verified provider](#) that meets the requirements outlined in the following table:

**Table 20.76. Version requirements for vSphere virtual environments**

Virtual environment product	Required version
VM hardware version	15 or later
vSphere ESXi hosts	7
vCenter host	7



## IMPORTANT

Installing a cluster on VMware vSphere version 7.0 Update 1 is now deprecated. These versions are still fully supported, but version 4.10 of OpenShift Container Platform requires vSphere virtual hardware version 15 or later. Hardware version 15 is now the default for vSphere virtual machines in OpenShift Container Platform. To update the hardware version for your vSphere nodes, see the "Updating hardware on nodes running in vSphere" article.

If your vSphere nodes are below hardware version 15 or your VMware vSphere version is earlier than 6.7U3, upgrading from OpenShift Container Platform 4.10 to OpenShift Container Platform 4.11 is not available.

**Table 20.77. Minimum supported vSphere version for VMware components**

Component	Minimum supported versions	Description
Hypervisor	vSphere 7 with HW version 15	This version is the minimum version that Red Hat Enterprise Linux CoreOS (RHCOS) supports. For more information about supported hardware on the latest version of Red Hat Enterprise Linux (RHEL) that is compatible with RHCOS, see <a href="#">Hardware</a> on the Red Hat Customer Portal.
Storage with in-tree drivers	vSphere 7	This plugin creates vSphere storage by using the in-tree storage drivers for vSphere included in OpenShift Container Platform.
Optional: Networking (NSX-T)	vSphere 7	vSphere 7 is required for OpenShift Container Platform. For more information about the compatibility of NSX and OpenShift Container Platform, see the Release Notes section of VMware's <a href="#">NSX container plugin documentation</a> .



If you use a vSphere version 6.5 instance, upgrade to 7.0 before you install OpenShift Container Platform.



### IMPORTANT

You must ensure that the time on your ESXi hosts is synchronized before you install OpenShift Container Platform. See [Edit Time Configuration for a Host](#) in the VMware documentation.

## 20.8.5. VMware vSphere CSI Driver Operator requirements

To install the vSphere CSI Driver Operator, the following requirements must be met:

- VMware vSphere version 6.7U3 or later
- Virtual machines of hardware version 15 or later
- No third-party vSphere CSI driver already installed in the cluster

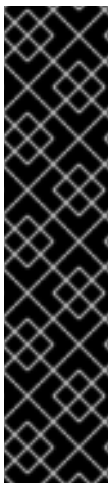

### IMPORTANT

If a third-party vSphere CSI driver is present in the cluster, OpenShift Container Platform does not overwrite it. If you continue with the third-party vSphere CSI driver when upgrading to the next major version of OpenShift Container Platform, the **oc** CLI prompts you with the following message:

```
VSphereCSIDriverOperatorCRUpgradeable: VMwareVSphereControllerUpgradeable:
found existing unsupported csi.vsphere.vmware.com driver
```

The previous message informs you that Red Hat does not support the third-party vSphere CSI driver during an OpenShift Container Platform upgrade operation. You can choose to ignore this message and continue with the upgrade operation.

### Additional resources

- To remove a third-party vSphere CSI driver, see [Removing a third-party vSphere CSI Driver](#) .
- To update the hardware version for your vSphere nodes, see [Updating hardware on nodes running in vSphere](#).

## 20.8.6. Requirements for a cluster with user-provisioned infrastructure

For a cluster that contains user-provisioned infrastructure, you must deploy all of the required machines.

This section describes the requirements for deploying OpenShift Container Platform on user-provisioned infrastructure.

### 20.8.6.1. Required machines for cluster installation

The smallest OpenShift Container Platform clusters require the following hosts:

**Table 20.78. Minimum required hosts**

Hosts	Description
One temporary bootstrap machine	The cluster requires the bootstrap machine to deploy the OpenShift Container Platform cluster on the three control plane machines. You can remove the bootstrap machine after you install the cluster.
Three control plane machines	The control plane machines run the Kubernetes and OpenShift Container Platform services that form the control plane.
At least two compute machines, which are also known as worker machines.	The workloads requested by OpenShift Container Platform users run on the compute machines.

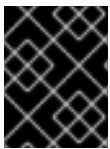

### IMPORTANT

To maintain high availability of your cluster, use separate physical hosts for these cluster machines.

The bootstrap and control plane machines must use Red Hat Enterprise Linux CoreOS (RHCOS) as the operating system. However, the compute machines can choose between Red Hat Enterprise Linux CoreOS (RHCOS), Red Hat Enterprise Linux (RHEL) 8.4, or RHEL 8.5.

Note that RHCOS is based on Red Hat Enterprise Linux (RHEL) 8 and inherits all of its hardware certifications and requirements. See [Red Hat Enterprise Linux technology capabilities and limits](#).

#### 20.8.6.2. Minimum resource requirements for cluster installation

Each cluster machine must meet the following minimum requirements:

**Table 20.79. Minimum resource requirements**

Machine	Operating System	vCPU [1]	Virtual RAM	Storage	IOPS [2]
Bootstrap	RHCOS	4	16 GB	100 GB	300
Control plane	RHCOS	4	16 GB	100 GB	300
Compute	RHCOS, RHEL 8.4, or RHEL 8.5 <sup>[3]</sup>	2	8 GB	100 GB	300

1. One vCPU is equivalent to one physical core when simultaneous multithreading (SMT), or hyperthreading, is not enabled. When enabled, use the following formula to calculate the corresponding ratio: (threads per core × cores) × sockets = vCPUs.
2. OpenShift Container Platform and Kubernetes are sensitive to disk performance, and faster storage is recommended, particularly for etcd on the control plane nodes which require a 10 ms p99 fsync duration. Note that on many cloud platforms, storage size and IOPS scale together, so

you might need to over-allocate storage volume to obtain sufficient performance.

3. As with all user-provisioned installations, if you choose to use RHEL compute machines in your cluster, you take responsibility for all operating system life cycle management and maintenance, including performing system updates, applying patches, and completing all other required tasks. Use of RHEL 7 compute machines is deprecated and has been removed in OpenShift Container Platform 4.10 and later.

If an instance type for your platform meets the minimum requirements for cluster machines, it is supported to use in OpenShift Container Platform.

### 20.8.6.3. Certificate signing requests management

Because your cluster has limited access to automatic machine management when you use infrastructure that you provision, you must provide a mechanism for approving cluster certificate signing requests (CSRs) after installation. The **kube-controller-manager** only approves the kubelet client CSRs. The **machine-approver** cannot guarantee the validity of a serving certificate that is requested by using kubelet credentials because it cannot confirm that the correct machine issued the request. You must determine and implement a method of verifying the validity of the kubelet serving certificate requests and approving them.

### 20.8.6.4. Networking requirements for user-provisioned infrastructure

All the Red Hat Enterprise Linux CoreOS (RHCOS) machines require networking to be configured in **iniramfs** during boot to fetch their Ignition config files.

During the initial boot, the machines require an IP address configuration that is set either through a DHCP server or statically by providing the required boot options. After a network connection is established, the machines download their Ignition config files from an HTTP or HTTPS server. The Ignition config files are then used to set the exact state of each machine. The Machine Config Operator completes more changes to the machines, such as the application of new certificates or keys, after installation.

It is recommended to use a DHCP server for long-term management of the cluster machines. Ensure that the DHCP server is configured to provide persistent IP addresses, DNS server information, and hostnames to the cluster machines.

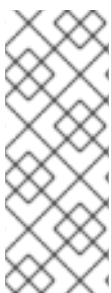

#### NOTE

If a DHCP service is not available for your user-provisioned infrastructure, you can instead provide the IP networking configuration and the address of the DNS server to the nodes at RHCOS install time. These can be passed as boot arguments if you are installing from an ISO image. See the *Installing RHCOS and starting the OpenShift Container Platform bootstrap process* section for more information about static IP provisioning and advanced networking options.

The Kubernetes API server must be able to resolve the node names of the cluster machines. If the API servers and worker nodes are in different zones, you can configure a default DNS search zone to allow the API server to resolve the node names. Another supported approach is to always refer to hosts by their fully-qualified domain names in both the node objects and all DNS requests.

#### 20.8.6.4.1. Setting the cluster node hostnames through DHCP

On Red Hat Enterprise Linux CoreOS (RHCOS) machines, the hostname is set through NetworkManager. By default, the machines obtain their hostname through DHCP. If the hostname is not

provided by DHCP, set statically through kernel arguments, or another method, it is obtained through a reverse DNS lookup. Reverse DNS lookup occurs after the network has been initialized on a node and can take time to resolve. Other system services can start prior to this and detect the hostname as **localhost** or similar. You can avoid this by using DHCP to provide the hostname for each cluster node.

Additionally, setting the hostnames through DHCP can bypass any manual DNS record name configuration errors in environments that have a DNS split-horizon implementation.

#### 20.8.6.4.2. Network connectivity requirements

You must configure the network connectivity between machines to allow OpenShift Container Platform cluster components to communicate. Each machine must be able to resolve the hostnames of all other machines in the cluster.

This section provides details about the ports that are required.



#### IMPORTANT

In connected OpenShift Container Platform environments, all nodes are required to have internet access to pull images for platform containers and provide telemetry data to Red Hat.

Table 20.80. Ports used for all-machine to all-machine communications

Protocol	Port	Description
ICMP	N/A	Network reachability tests
TCP	<b>1936</b>	Metrics
	<b>9000-9999</b>	Host level services, including the node exporter on ports <b>9100-9101</b> and the Cluster Version Operator on port <b>9099</b> .
	<b>10250-10259</b>	The default ports that Kubernetes reserves
	<b>10256</b>	openshift-sdn
UDP	<b>4789</b>	VXLAN
	<b>6081</b>	Geneve
	<b>9000-9999</b>	Host level services, including the node exporter on ports <b>9100-9101</b> .
	<b>500</b>	IPsec IKE packets
	<b>4500</b>	IPsec NAT-T packets
TCP/UDP	<b>30000-32767</b>	Kubernetes node port

Protocol	Port	Description
ESP	N/A	IPsec Encapsulating Security Payload (ESP)

Table 20.81. Ports used for all-machine to control plane communications

Protocol	Port	Description
TCP	<b>6443</b>	Kubernetes API

Table 20.82. Ports used for control plane machine to control plane machine communications

Protocol	Port	Description
TCP	<b>2379-2380</b>	etcd server and peer ports

### Ethernet adaptor hardware address requirements

When provisioning VMs for the cluster, the ethernet interfaces configured for each VM must use a MAC address from the VMware Organizationally Unique Identifier (OUI) allocation ranges:

- **00:05:69:00:00:00 to 00:05:69:FF:FF:FF**
- **00:0c:29:00:00:00 to 00:0c:29:FF:FF:FF**
- **00:1c:14:00:00:00 to 00:1c:14:FF:FF:FF**
- **00:50:56:00:00:00 to 00:50:56:3F:FF:FF**

If a MAC address outside the VMware OUI is used, the cluster installation will not succeed.

### NTP configuration for user-provisioned infrastructure

OpenShift Container Platform clusters are configured to use a public Network Time Protocol (NTP) server by default. If you want to use a local enterprise NTP server, or if your cluster is being deployed in a disconnected network, you can configure the cluster to use a specific time server. For more information, see the documentation for *Configuring chrony time service*.

If a DHCP server provides NTP server information, the chrony time service on the Red Hat Enterprise Linux CoreOS (RHCOS) machines read the information and can sync the clock with the NTP servers.

### Additional resources

- [Configuring chrony time service](#)

### 20.8.6.5. User-provisioned DNS requirements

In OpenShift Container Platform deployments, DNS name resolution is required for the following components:

- The Kubernetes API
- The OpenShift Container Platform application wildcard

- The bootstrap, control plane, and compute machines

Reverse DNS resolution is also required for the Kubernetes API, the bootstrap machine, the control plane machines, and the compute machines.

DNS A/AAAA or CNAME records are used for name resolution and PTR records are used for reverse name resolution. The reverse records are important because Red Hat Enterprise Linux CoreOS (RHCOS) uses the reverse records to set the hostnames for all the nodes, unless the hostnames are provided by DHCP. Additionally, the reverse records are used to generate the certificate signing requests (CSR) that OpenShift Container Platform needs to operate.



**NOTE**

It is recommended to use a DHCP server to provide the hostnames to each cluster node. See the *DHCP recommendations for user-provisioned infrastructure* section for more information.

The following DNS records are required for a user-provisioned OpenShift Container Platform cluster and they must be in place before installation. In each record, **<cluster\_name>** is the cluster name and **<base\_domain>** is the base domain that you specify in the **install-config.yaml** file. A complete DNS record takes the form: **<component>.<cluster\_name>.<base\_domain>..**

**Table 20.83. Required DNS records**

Component	Record	Description
Kubernetes API	<b>api.&lt;cluster_name&gt;.&lt;base_domain&gt;..</b>	A DNS A/AAAA or CNAME record, and a DNS PTR record, to identify the API load balancer. These records must be resolvable by both clients external to the cluster and from all the nodes within the cluster.
	<b>api-int.&lt;cluster_name&gt;.&lt;base_domain&gt;..</b>	<p>A DNS A/AAAA or CNAME record, and a DNS PTR record, to internally identify the API load balancer. These records must be resolvable from all the nodes within the cluster.</p> <div style="display: flex; align-items: flex-start;"> <div style="flex: 1;">  </div> <div style="flex: 2;"> <p><b>IMPORTANT</b></p> <p>The API server must be able to resolve the worker nodes by the hostnames that are recorded in Kubernetes. If the API server cannot resolve the node names, then proxied API calls can fail, and you cannot retrieve logs from pods.</p> </div> </div>

Component	Record	Description
Routes	<b>*.apps.&lt;cluster_name&gt;.&lt;base_domain&gt;.</b>	A wildcard DNS A/AAAA or CNAME record that refers to the application ingress load balancer. The application ingress load balancer targets the machines that run the Ingress Controller pods. The Ingress Controller pods run on the compute machines by default. These records must be resolvable by both clients external to the cluster and from all the nodes within the cluster.  For example, <b>console-openshift-console.apps.&lt;cluster_name&gt;.&lt;base_domain&gt;</b> is used as a wildcard route to the OpenShift Container Platform console.
Bootstrap machine	<b>bootstrap.&lt;cluster_name&gt;.&lt;base_domain&gt;.</b>	A DNS A/AAAA or CNAME record, and a DNS PTR record, to identify the bootstrap machine. These records must be resolvable by the nodes within the cluster.
Control plane machines	<b>&lt;master&gt;&lt;n&gt;.&lt;cluster_name&gt;.&lt;base_domain&gt;.</b>	DNS A/AAAA or CNAME records and DNS PTR records to identify each machine for the control plane nodes. These records must be resolvable by the nodes within the cluster.
Compute machines	<b>&lt;worker&gt;&lt;n&gt;.&lt;cluster_name&gt;.&lt;base_domain&gt;.</b>	DNS A/AAAA or CNAME records and DNS PTR records to identify each machine for the worker nodes. These records must be resolvable by the nodes within the cluster.



## NOTE

In OpenShift Container Platform 4.4 and later, you do not need to specify etcd host and SRV records in your DNS configuration.

## TIP

You can use the **dig** command to verify name and reverse name resolution. See the section on *Validating DNS resolution for user-provisioned infrastructure* for detailed validation steps.

### 20.8.6.5.1. Example DNS configuration for user-provisioned clusters

This section provides A and PTR record configuration samples that meet the DNS requirements for deploying OpenShift Container Platform on user-provisioned infrastructure. The samples are not meant to provide advice for choosing one DNS solution over another.

In the examples, the cluster name is **ocp4** and the base domain is **example.com**.

#### Example DNS A record configuration for a user-provisioned cluster

The following example is a BIND zone file that shows sample A records for name resolution in a user-provisioned cluster.

-

## Example 20.19. Sample DNS zone database

```

$TTL 1W
@ IN SOA ns1.example.com. root (
  2019070700 ; serial
  3H ; refresh (3 hours)
  30M ; retry (30 minutes)
  2W ; expiry (2 weeks)
  1W) ; minimum (1 week)
IN NS ns1.example.com.
IN MX 10 smtp.example.com.
;
;
ns1.example.com. IN A 192.168.1.5
smtp.example.com. IN A 192.168.1.5
;
helper.example.com. IN A 192.168.1.5
helper.ocp4.example.com. IN A 192.168.1.5
;
api.ocp4.example.com. IN A 192.168.1.5 1
api-int.ocp4.example.com. IN A 192.168.1.5 2
;
*.apps.ocp4.example.com. IN A 192.168.1.5 3
;
bootstrap.ocp4.example.com. IN A 192.168.1.96 4
;
master0.ocp4.example.com. IN A 192.168.1.97 5
master1.ocp4.example.com. IN A 192.168.1.98 6
master2.ocp4.example.com. IN A 192.168.1.99 7
;
worker0.ocp4.example.com. IN A 192.168.1.11 8
worker1.ocp4.example.com. IN A 192.168.1.7 9
;
;EOF

```

- 1 Provides name resolution for the Kubernetes API. The record refers to the IP address of the API load balancer.
- 2 Provides name resolution for the Kubernetes API. The record refers to the IP address of the API load balancer and is used for internal cluster communications.
- 3 Provides name resolution for the wildcard routes. The record refers to the IP address of the application ingress load balancer. The application ingress load balancer targets the machines that run the Ingress Controller pods. The Ingress Controller pods run on the compute machines by default.

**NOTE**

In the example, the same load balancer is used for the Kubernetes API and application ingress traffic. In production scenarios, you can deploy the API and application ingress load balancers separately so that you can scale the load balancer infrastructure for each in isolation.



- 4 Provides name resolution for the bootstrap machine.
- 5 6 7 Provides name resolution for the control plane machines.
- 8 9 Provides name resolution for the compute machines.

### Example DNS PTR record configuration for a user-provisioned cluster

The following example BIND zone file shows sample PTR records for reverse name resolution in a user-provisioned cluster.

#### Example 20.20. Sample DNS zone database for reverse records

```
$TTL 1W
@ IN SOA ns1.example.com. root (
    2019070700 ; serial
    3H ; refresh (3 hours)
    30M ; retry (30 minutes)
    2W ; expiry (2 weeks)
    1W ) ; minimum (1 week)
IN NS ns1.example.com.
;
5.1.168.192.in-addr.arpa. IN PTR api.ocp4.example.com. 1
5.1.168.192.in-addr.arpa. IN PTR api-int.ocp4.example.com. 2
;
96.1.168.192.in-addr.arpa. IN PTR bootstrap.ocp4.example.com. 3
;
97.1.168.192.in-addr.arpa. IN PTR master0.ocp4.example.com. 4
98.1.168.192.in-addr.arpa. IN PTR master1.ocp4.example.com. 5
99.1.168.192.in-addr.arpa. IN PTR master2.ocp4.example.com. 6
;
11.1.168.192.in-addr.arpa. IN PTR worker0.ocp4.example.com. 7
7.1.168.192.in-addr.arpa. IN PTR worker1.ocp4.example.com. 8
;
;EOF
```

- 1 Provides reverse DNS resolution for the Kubernetes API. The PTR record refers to the record name of the API load balancer.
- 2 Provides reverse DNS resolution for the Kubernetes API. The PTR record refers to the record name of the API load balancer and is used for internal cluster communications.
- 3 Provides reverse DNS resolution for the bootstrap machine.
- 4 5 6 Provides reverse DNS resolution for the control plane machines.
- 7 8 Provides reverse DNS resolution for the compute machines.

**NOTE**

A PTR record is not required for the OpenShift Container Platform application wildcard.

**20.8.6.6. Load balancing requirements for user-provisioned infrastructure**

Before you install OpenShift Container Platform, you must provision the API and application ingress load balancing infrastructure. In production scenarios, you can deploy the API and application ingress load balancers separately so that you can scale the load balancer infrastructure for each in isolation.

**NOTE**

If you want to deploy the API and application Ingress load balancers with a Red Hat Enterprise Linux (RHEL) instance, you must purchase the RHEL subscription separately.

The load balancing infrastructure must meet the following requirements:

1. **API load balancer.** Provides a common endpoint for users, both human and machine, to interact with and configure the platform. Configure the following conditions:
  - Layer 4 load balancing only. This can be referred to as Raw TCP, SSL Passthrough, or SSL Bridge mode. If you use SSL Bridge mode, you must enable Server Name Indication (SNI) for the API routes.
  - A stateless load balancing algorithm. The options vary based on the load balancer implementation.

**IMPORTANT**

Do not configure session persistence for an API load balancer. Configuring session persistence for a Kubernetes API server might cause performance issues from excess application traffic for your OpenShift Container Platform cluster and the Kubernetes API that runs inside the cluster.

Configure the following ports on both the front and back of the load balancers:

**Table 20.84. API load balancer**

Port	Back-end machines (pool members)	Internal	External	Description
<b>6443</b>	Bootstrap and control plane. You remove the bootstrap machine from the load balancer after the bootstrap machine initializes the cluster control plane. You must configure the <b>/readyz</b> endpoint for the API server health check probe.	X	X	Kubernetes API server
<b>22623</b>	Bootstrap and control plane. You remove the bootstrap machine from the load balancer after the bootstrap machine initializes the cluster control plane.	X		Machine config server

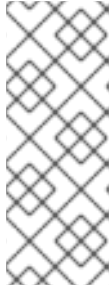
**NOTE**

The load balancer must be configured to take a maximum of 30 seconds from the time the API server turns off the **/readyz** endpoint to the removal of the API server instance from the pool. Within the time frame after **/readyz** returns an error or becomes healthy, the endpoint must have been removed or added. Probing every 5 or 10 seconds, with two successful requests to become healthy and three to become unhealthy, are well-tested values.

2. **Application Ingress load balancer.** Provides an ingress point for application traffic flowing in from outside the cluster. A working configuration for the Ingress router is required for an OpenShift Container Platform cluster.

Configure the following conditions:

- Layer 4 load balancing only. This can be referred to as Raw TCP, SSL Passthrough, or SSL Bridge mode. If you use SSL Bridge mode, you must enable Server Name Indication (SNI) for the ingress routes.
- A connection-based or session-based persistence is recommended, based on the options available and types of applications that will be hosted on the platform.

**TIP**

If the true IP address of the client can be seen by the application Ingress load balancer, enabling source IP-based session persistence can improve performance for applications that use end-to-end TLS encryption.

Configure the following ports on both the front and back of the load balancers:

**Table 20.85. Application Ingress load balancer**

Port	Back-end machines (pool members)	Internal	External	Description
<b>443</b>	The machines that run the Ingress Controller pods, compute, or worker, by default.	X	X	HTTPS traffic
<b>80</b>	The machines that run the Ingress Controller pods, compute, or worker, by default.	X	X	HTTP traffic

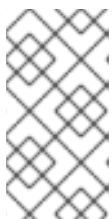
**NOTE**

If you are deploying a three-node cluster with zero compute nodes, the Ingress Controller pods run on the control plane nodes. In three-node cluster deployments, you must configure your application Ingress load balancer to route HTTP and HTTPS traffic to the control plane nodes.

#### 20.8.6.6.1. Example load balancer configuration for user-provisioned clusters

This section provides an example API and application ingress load balancer configuration that meets the load balancing requirements for user-provisioned clusters. The sample is an **/etc/haproxy/haproxy.cfg** configuration for an HAProxy load balancer. The example is not meant to provide advice for choosing

one load balancing solution over another.

In the example, the same load balancer is used for the Kubernetes API and application ingress traffic. In production scenarios, you can deploy the API and application ingress load balancers separately so that you can scale the load balancer infrastructure for each in isolation.



## NOTE

If you are using HAProxy as a load balancer and SELinux is set to **enforcing**, you must ensure that the HAProxy service can bind to the configured TCP port by running **setsebool -P haproxy\_connect\_any=1**.

### Example 20.21. Sample API and application Ingress load balancer configuration

```

global
  log      127.0.0.1 local2
  pidfile  /var/run/haproxy.pid
  maxconn  4000
  daemon
defaults
  mode            http
  log             global
  option          dontlognull
  option http-server-close
  option          redispatch
  retries         3
  timeout http-request 10s
  timeout queue    1m
  timeout connect  10s
  timeout client   1m
  timeout server   1m
  timeout http-keep-alive 10s
  timeout check    10s
  maxconn         3000
listen api-server-6443 1
  bind *:6443
  mode tcp
  server bootstrap bootstrap.ocp4.example.com:6443 check inter 1s backup 2
  server master0 master0.ocp4.example.com:6443 check inter 1s
  server master1 master1.ocp4.example.com:6443 check inter 1s
  server master2 master2.ocp4.example.com:6443 check inter 1s
listen machine-config-server-22623 3
  bind *:22623
  mode tcp
  server bootstrap bootstrap.ocp4.example.com:22623 check inter 1s backup 4
  server master0 master0.ocp4.example.com:22623 check inter 1s
  server master1 master1.ocp4.example.com:22623 check inter 1s
  server master2 master2.ocp4.example.com:22623 check inter 1s
listen ingress-router-443 5
  bind *:443
  mode tcp
  balance source
  server worker0 worker0.ocp4.example.com:443 check inter 1s
  server worker1 worker1.ocp4.example.com:443 check inter 1s

```

```
listen ingress-router-80 6
bind *:80
mode tcp
balance source
server worker0 worker0.ocp4.example.com:80 check inter 1s
server worker1 worker1.ocp4.example.com:80 check inter 1s
```

- 1** Port **6443** handles the Kubernetes API traffic and points to the control plane machines.
- 2** **4** The bootstrap entries must be in place before the OpenShift Container Platform cluster installation and they must be removed after the bootstrap process is complete.
- 3** Port **22623** handles the machine config server traffic and points to the control plane machines.
- 5** Port **443** handles the HTTPS traffic and points to the machines that run the Ingress Controller pods. The Ingress Controller pods run on the compute machines by default.
- 6** Port **80** handles the HTTP traffic and points to the machines that run the Ingress Controller pods. The Ingress Controller pods run on the compute machines by default.

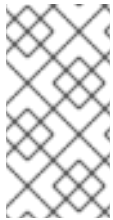

#### NOTE

If you are deploying a three-node cluster with zero compute nodes, the Ingress Controller pods run on the control plane nodes. In three-node cluster deployments, you must configure your application Ingress load balancer to route HTTP and HTTPS traffic to the control plane nodes.

#### TIP

If you are using HAProxy as a load balancer, you can check that the **haproxy** process is listening on ports **6443**, **22623**, **443**, and **80** by running **netstat -nltupe** on the HAProxy node.

### 20.8.7. Preparing the user-provisioned infrastructure

Before you install OpenShift Container Platform on user-provisioned infrastructure, you must prepare the underlying infrastructure.

This section provides details about the high-level steps required to set up your cluster infrastructure in preparation for an OpenShift Container Platform installation. This includes configuring IP networking and network connectivity for your cluster nodes, enabling the required ports through your firewall, and setting up the required DNS and load balancing infrastructure.

After preparation, your cluster infrastructure must meet the requirements outlined in the *Requirements for a cluster with user-provisioned infrastructure* section.

#### Prerequisites

- You have reviewed the [OpenShift Container Platform 4.x Tested Integrations](#) page.
- You have reviewed the infrastructure requirements detailed in the *Requirements for a cluster with user-provisioned infrastructure* section.

## Procedure

1. If you are using DHCP to provide the IP networking configuration to your cluster nodes, configure your DHCP service.
  - a. Add persistent IP addresses for the nodes to your DHCP server configuration. In your configuration, match the MAC address of the relevant network interface to the intended IP address for each node.
  - b. When you use DHCP to configure IP addressing for the cluster machines, the machines also obtain the DNS server information through DHCP. Define the persistent DNS server address that is used by the cluster nodes through your DHCP server configuration.



### NOTE

If you are not using a DHCP service, you must provide the IP networking configuration and the address of the DNS server to the nodes at RHCOS install time. These can be passed as boot arguments if you are installing from an ISO image. See the *Installing RHCOS and starting the OpenShift Container Platform bootstrap process* section for more information about static IP provisioning and advanced networking options.

- c. Define the hostnames of your cluster nodes in your DHCP server configuration. See the *Setting the cluster node hostnames through DHCP* section for details about hostname considerations.



### NOTE

If you are not using a DHCP service, the cluster nodes obtain their hostname through a reverse DNS lookup.

2. Ensure that your network infrastructure provides the required network connectivity between the cluster components. See the *Networking requirements for user-provisioned infrastructure* section for details about the requirements.
3. Configure your firewall to enable the ports required for the OpenShift Container Platform cluster components to communicate. See *Networking requirements for user-provisioned infrastructure* section for details about the ports that are required.



### IMPORTANT

By default, port **1936** is accessible for an OpenShift Container Platform cluster, because each control plane node needs access to this port.

Avoid using the Ingress load balancer to expose this port, because doing so might result in the exposure of sensitive information, such as statistics and metrics, related to Ingress Controllers.

4. Setup the required DNS infrastructure for your cluster.
  - a. Configure DNS name resolution for the Kubernetes API, the application wildcard, the bootstrap machine, the control plane machines, and the compute machines.
  - b. Configure reverse DNS resolution for the Kubernetes API, the bootstrap machine, the control plane machines, and the compute machines.

See the *User-provisioned DNS requirements* section for more information about the OpenShift Container Platform DNS requirements.

5. Validate your DNS configuration.
  - a. From your installation node, run DNS lookups against the record names of the Kubernetes API, the wildcard routes, and the cluster nodes. Validate that the IP addresses in the responses correspond to the correct components.
  - b. From your installation node, run reverse DNS lookups against the IP addresses of the load balancer and the cluster nodes. Validate that the record names in the responses correspond to the correct components.  
See the *Validating DNS resolution for user-provisioned infrastructure* section for detailed DNS validation steps.
6. Provision the required API and application ingress load balancing infrastructure. See the *Load balancing requirements for user-provisioned infrastructure* section for more information about the requirements.

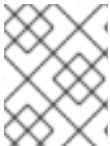

#### NOTE

Some load balancing solutions require the DNS name resolution for the cluster nodes to be in place before the load balancing is initialized.

### 20.8.8. Validating DNS resolution for user-provisioned infrastructure

You can validate your DNS configuration before installing OpenShift Container Platform on user-provisioned infrastructure.

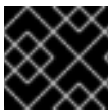

#### IMPORTANT

The validation steps detailed in this section must succeed before you install your cluster.

#### Prerequisites

- You have configured the required DNS records for your user-provisioned infrastructure.

#### Procedure

1. From your installation node, run DNS lookups against the record names of the Kubernetes API, the wildcard routes, and the cluster nodes. Validate that the IP addresses contained in the responses correspond to the correct components.
  - a. Perform a lookup against the Kubernetes API record name. Check that the result points to the IP address of the API load balancer:

```
$ dig +noall +answer @<nameserver_ip> api.<cluster_name>.<base_domain> 1
```

- 1 Replace **<nameserver\_ip>** with the IP address of the nameserver, **<cluster\_name>** with your cluster name, and **<base\_domain>** with your base domain name.

#### Example output

```
api.ocp4.example.com. 0 IN A 192.168.1.5
```

- 
- b. Perform a lookup against the Kubernetes internal API record name. Check that the result points to the IP address of the API load balancer:

```
$ dig +noall +answer @<nameserver_ip> api-int.<cluster_name>.<base_domain>
```

#### Example output

```
api-int.ocp4.example.com. 0 IN A 192.168.1.5
```

- c. Test an example **\*.apps.<cluster\_name>.<base\_domain>** DNS wildcard lookup. All of the application wildcard lookups must resolve to the IP address of the application ingress load balancer:

```
$ dig +noall +answer @<nameserver_ip> random.apps.<cluster_name>.<base_domain>
```

#### Example output

```
random.apps.ocp4.example.com. 0 IN A 192.168.1.5
```



#### NOTE

In the example outputs, the same load balancer is used for the Kubernetes API and application ingress traffic. In production scenarios, you can deploy the API and application ingress load balancers separately so that you can scale the load balancer infrastructure for each in isolation.

You can replace **random** with another wildcard value. For example, you can query the route to the OpenShift Container Platform console:

```
$ dig +noall +answer @<nameserver_ip> console-openshift-console.apps.<cluster_name>.<base_domain>
```

#### Example output

```
console-openshift-console.apps.ocp4.example.com. 0 IN A 192.168.1.5
```

- d. Run a lookup against the bootstrap DNS record name. Check that the result points to the IP address of the bootstrap node:

```
$ dig +noall +answer @<nameserver_ip> bootstrap.<cluster_name>.<base_domain>
```

#### Example output

```
bootstrap.ocp4.example.com. 0 IN A 192.168.1.96
```

- e. Use this method to perform lookups against the DNS record names for the control plane and compute nodes. Check that the results correspond to the IP addresses of each node.



2. From your installation node, run reverse DNS lookups against the IP addresses of the load balancer and the cluster nodes. Validate that the record names contained in the responses correspond to the correct components.
  - a. Perform a reverse lookup against the IP address of the API load balancer. Check that the response includes the record names for the Kubernetes API and the Kubernetes internal API:

```
$ dig +noall +answer @<nameserver_ip> -x 192.168.1.5
```

#### Example output

```
5.1.168.192.in-addr.arpa. 0 IN PTR api-int.ocp4.example.com. 1
5.1.168.192.in-addr.arpa. 0 IN PTR api.ocp4.example.com. 2
```

- 1** Provides the record name for the Kubernetes internal API.
- 2** Provides the record name for the Kubernetes API.



#### NOTE

A PTR record is not required for the OpenShift Container Platform application wildcard. No validation step is needed for reverse DNS resolution against the IP address of the application ingress load balancer.

- b. Perform a reverse lookup against the IP address of the bootstrap node. Check that the result points to the DNS record name of the bootstrap node:

```
$ dig +noall +answer @<nameserver_ip> -x 192.168.1.96
```

#### Example output

```
96.1.168.192.in-addr.arpa. 0 IN PTR bootstrap.ocp4.example.com.
```

- c. Use this method to perform reverse lookups against the IP addresses for the control plane and compute nodes. Check that the results correspond to the DNS record names of each node.

### 20.8.9. Generating a key pair for cluster node SSH access

During an OpenShift Container Platform installation, you can provide an SSH public key to the installation program. The key is passed to the Red Hat Enterprise Linux CoreOS (RHCOS) nodes through their Ignition config files and is used to authenticate SSH access to the nodes. The key is added to the `~/.ssh/authorized_keys` list for the **core** user on each node, which enables password-less authentication.

After the key is passed to the nodes, you can use the key pair to SSH in to the RHCOS nodes as the user **core**. To access the nodes through SSH, the private key identity must be managed by SSH for your local user.

If you want to SSH in to your cluster nodes to perform installation debugging or disaster recovery, you must provide the SSH public key during the installation process. The `./openshift-install gather` command also requires the SSH public key to be in place on the cluster nodes.



### IMPORTANT

Do not skip this procedure in production environments, where disaster recovery and debugging is required.



### NOTE

You must use a local key, not one that you configured with platform-specific approaches such as [AWS key pairs](#).

## Procedure

1. If you do not have an existing SSH key pair on your local machine to use for authentication onto your cluster nodes, create one. For example, on a computer that uses a Linux operating system, run the following command:

```
$ ssh-keygen -t ed25519 -N "" -f <path>/<file_name> 1
```

- 1 Specify the path and file name, such as `~/.ssh/id_ed25519`, of the new SSH key. If you have an existing key pair, ensure your public key is in the your `~/.ssh` directory.



### NOTE

If you plan to install an OpenShift Container Platform cluster that uses FIPS validated or Modules In Process cryptographic libraries on the `x86_64` architecture, do not create a key that uses the `ed25519` algorithm. Instead, create a key that uses the `rsa` or `ecdsa` algorithm.

2. View the public SSH key:

```
$ cat <path>/<file_name>.pub
```

For example, run the following to view the `~/.ssh/id_ed25519.pub` public key:

```
$ cat ~/.ssh/id_ed25519.pub
```

3. Add the SSH private key identity to the SSH agent for your local user, if it has not already been added. SSH agent management of the key is required for password-less SSH authentication onto your cluster nodes, or if you want to use the `./openshift-install gather` command.



### NOTE

On some distributions, default SSH private key identities such as `~/.ssh/id_rsa` and `~/.ssh/id_dsa` are managed automatically.

- a. If the `ssh-agent` process is not already running for your local user, start it as a background task:

■

```
$ eval "$(ssh-agent -s)"
```

### Example output

```
Agent pid 31874
```



### NOTE

If your cluster is in FIPS mode, only use FIPS-compliant algorithms to generate the SSH key. The key must be either RSA or ECDSA.

4. Add your SSH private key to the **ssh-agent**:

```
$ ssh-add <path>/<file_name> 1
```

- 1 Specify the path and file name for your SSH private key, such as `~/.ssh/id_ed25519`

### Example output

```
Identity added: /home/<you>/<path>/<file_name> (<computer_name>)
```

### Next steps

- When you install OpenShift Container Platform, provide the SSH public key to the installation program. If you install a cluster on infrastructure that you provision, you must provide the key to the installation program.

## 20.8.10. Manually creating the installation configuration file

For user-provisioned installations of OpenShift Container Platform, you manually generate your installation configuration file.

### Prerequisites

- You have an SSH public key on your local machine to provide to the installation program. The key will be used for SSH authentication onto your cluster nodes for debugging and disaster recovery.
- You have obtained the OpenShift Container Platform installation program and the pull secret for your cluster.
- Obtain the **imageContentSources** section from the output of the command to mirror the repository.
- Obtain the contents of the certificate for your mirror registry.

### Procedure

1. Create an installation directory to store your required installation assets in:

```
$ mkdir <installation_directory>
```

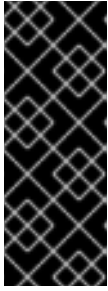
**IMPORTANT**

You must create a directory. Some installation assets, like bootstrap X.509 certificates have short expiration intervals, so you must not reuse an installation directory. If you want to reuse individual files from another cluster installation, you can copy them into your directory. However, the file names for the installation assets might change between releases. Use caution when copying installation files from an earlier OpenShift Container Platform version.

2. Customize the sample **install-config.yaml** file template that is provided and save it in the **<installation\_directory>**.

**NOTE**

You must name this configuration file **install-config.yaml**.

- Unless you use a registry that RHCOS trusts by default, such as **docker.io**, you must provide the contents of the certificate for your mirror repository in the **additionalTrustBundle** section. In most cases, you must provide the certificate for your mirror.
- You must include the **imageContentSources** section from the output of the command to mirror the repository.

**NOTE**

For some platform types, you can alternatively run **./openshift-install create install-config --dir <installation\_directory>** to generate an **install-config.yaml** file. You can provide details about your cluster configuration at the prompts.

3. Back up the **install-config.yaml** file so that you can use it to install multiple clusters.

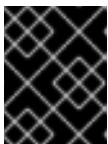
**IMPORTANT**

The **install-config.yaml** file is consumed during the next step of the installation process. You must back it up now.

### 20.8.10.1. Sample **install-config.yaml** file for VMware vSphere

You can customize the **install-config.yaml** file to specify more details about your OpenShift Container Platform cluster's platform or modify the values of the required parameters.

```

apiVersion: v1
baseDomain: example.com 1
compute: 2
- hyperthreading: Enabled 3
  name: worker
  replicas: 0 4
controlPlane: 5
  hyperthreading: Enabled 6
  name: master
  replicas: 3 7

```



- 7 The number of control plane machines that you add to the cluster. Because the cluster uses this values as the number of etcd endpoints in the cluster, the value must match the number of control
- 8 The cluster name that you specified in your DNS records.
- 9 The fully-qualified hostname or IP address of the vCenter server.
- 10 The name of the user for accessing the server. This user must have at least the roles and privileges that are required for [static or dynamic persistent volume provisioning](#) in vSphere.
- 11 The password associated with the vSphere user.
- 12 The vSphere datacenter.
- 13 The default vSphere datastore to use.
- 14 Optional parameter: For installer-provisioned infrastructure, the absolute path of an existing folder where the installation program creates the virtual machines, for example, `/<datacenter_name>/vm/<folder_name>/<subfolder_name>`. If you do not provide this value, the installation program creates a top-level folder in the datacenter virtual machine folder that is named with the infrastructure ID. If you are providing the infrastructure for the cluster and you do not want to use the default **StorageClass** object, named **thin**, you can omit the **folder** parameter from the **install-config.yaml** file.
- 15 Optional parameter: For installer-provisioned infrastructure, the absolute path of an existing resource pool where the installation program creates the virtual machines, for example, `/<datacenter_name>/host/<cluster_name>/Resources/<resource_pool_name>/<optional_nested_resource_pool_name>`. If you do not specify a value, resources are installed in the root of the cluster `/example_datacenter/host/example_cluster/Resources`.
- 16 The vSphere disk provisioning method.
- 17 Whether to enable or disable FIPS mode. By default, FIPS mode is not enabled. If FIPS mode is enabled, the Red Hat Enterprise Linux CoreOS (RHCOS) machines that OpenShift Container Platform runs on bypass the default Kubernetes cryptography suite and use the cryptography modules that are provided with RHCOS instead.



### IMPORTANT

To enable FIPS mode for your cluster, you must run the installation program from a Red Hat Enterprise Linux (RHEL) computer configured to operate in FIPS mode. For more information about configuring FIPS mode on RHEL, see [Installing the system in FIPS mode](#). The use of FIPS validated or Modules In Process cryptographic libraries is only supported on OpenShift Container Platform deployments on the **x86\_64** architecture.

- 18 For **<local\_registry>**, specify the registry domain name, and optionally the port, that your mirror registry uses to serve content. For example **registry.example.com** or **registry.example.com:5000**. For **<credentials>**, specify the base64-encoded user name and password for your mirror registry.
- 19 The public portion of the default SSH key for the **core** user in Red Hat Enterprise Linux CoreOS (RHCOS).

**NOTE**

For production OpenShift Container Platform clusters on which you want to perform installation debugging or disaster recovery, specify an SSH key that your **ssh-agent** process uses.

- 20 Provide the contents of the certificate file that you used for your mirror registry.
- 21 Provide the **imageContentSources** section from the output of the command to mirror the repository.

### 20.8.10.2. Configuring the cluster-wide proxy during installation

Production environments can deny direct access to the internet and instead have an HTTP or HTTPS proxy available. You can configure a new OpenShift Container Platform cluster to use a proxy by configuring the proxy settings in the **install-config.yaml** file.

#### Prerequisites

- You have an existing **install-config.yaml** file.
- You reviewed the sites that your cluster requires access to and determined whether any of them need to bypass the proxy. By default, all cluster egress traffic is proxied, including calls to hosting cloud provider APIs. You added sites to the **Proxy** object's **spec.noProxy** field to bypass the proxy if necessary.

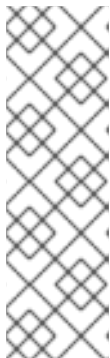
**NOTE**

The **Proxy** object **status.noProxy** field is populated with the values of the **networking.machineNetwork[].cidr**, **networking.clusterNetwork[].cidr**, and **networking.serviceNetwork[]** fields from your installation configuration.

For installations on Amazon Web Services (AWS), Google Cloud Platform (GCP), Microsoft Azure, and Red Hat OpenStack Platform (RHOSP), the **Proxy** object **status.noProxy** field is also populated with the instance metadata endpoint (**169.254.169.254**).

#### Procedure

1. Edit your **install-config.yaml** file and add the proxy settings. For example:

```

apiVersion: v1
baseDomain: my.domain.com
proxy:
  httpProxy: http://<username>:<pswd>@<ip>:<port> 1
  httpsProxy: https://<username>:<pswd>@<ip>:<port> 2
  noProxy: example.com 3
  additionalTrustBundle: | 4
    -----BEGIN CERTIFICATE-----
    <MY_TRUSTED_CA_CERT>
    -----END CERTIFICATE-----
  ...

```

- 1 A proxy URL to use for creating HTTP connections outside the cluster. The URL scheme must be **http**.
- 2 A proxy URL to use for creating HTTPS connections outside the cluster.
- 3 A comma-separated list of destination domain names, IP addresses, or other network CIDRs to exclude from proxying. Preface a domain with **.** to match subdomains only. For example, **.y.com** matches **x.y.com**, but not **y.com**. Use **\*** to bypass the proxy for all destinations. You must include vCenter's IP address and the IP range that you use for its machines.
- 4 If provided, the installation program generates a config map that is named **user-ca-bundle** in the **openshift-config** namespace that contains one or more additional CA certificates that are required for proxying HTTPS connections. The Cluster Network Operator then creates a **trusted-ca-bundle** config map that merges these contents with the Red Hat Enterprise Linux CoreOS (RHCOS) trust bundle, and this config map is referenced in the **trustedCA** field of the **Proxy** object. The **additionalTrustBundle** field is required unless the proxy's identity certificate is signed by an authority from the RHCOS trust bundle.

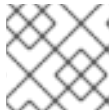
**NOTE**

The installation program does not support the proxy **readinessEndpoints** field.

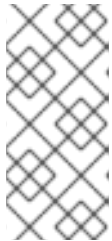
**NOTE**

If the installer times out, restart and then complete the deployment by using the **wait-for** command of the installer. For example:

```
$. /openshift-install wait-for install-complete --log-level debug
```

2. Save the file and reference it when installing OpenShift Container Platform.

The installation program creates a cluster-wide proxy that is named **cluster** that uses the proxy settings in the provided **install-config.yaml** file. If no proxy settings are provided, a **cluster Proxy** object is still created, but it will have a nil **spec**.

**NOTE**

Only the **Proxy** object named **cluster** is supported, and no additional proxies can be created.

### 20.8.11. Creating the Kubernetes manifest and Ignition config files

Because you must modify some cluster definition files and manually start the cluster machines, you must generate the Kubernetes manifest and Ignition config files that the cluster needs to configure the machines.

The installation configuration file transforms into the Kubernetes manifests. The manifests wrap into the Ignition configuration files, which are later used to configure the cluster machines.





## IMPORTANT

- The Ignition config files that the OpenShift Container Platform installation program generates contain certificates that expire after 24 hours, which are then renewed at that time. If the cluster is shut down before renewing the certificates and the cluster is later restarted after the 24 hours have elapsed, the cluster automatically recovers the expired certificates. The exception is that you must manually approve the pending **node-bootstrapper** certificate signing requests (CSRs) to recover kubelet certificates. See the documentation for *Recovering from expired control plane certificates* for more information.
- It is recommended that you use Ignition config files within 12 hours after they are generated because the 24-hour certificate rotates from 16 to 22 hours after the cluster is installed. By using the Ignition config files within 12 hours, you can avoid installation failure if the certificate update runs during installation.

## Prerequisites

- You obtained the OpenShift Container Platform installation program. For a restricted network installation, these files are on your mirror host.
- You created the **install-config.yaml** installation configuration file.

## Procedure

1. Change to the directory that contains the OpenShift Container Platform installation program and generate the Kubernetes manifests for the cluster:

```
$ ./openshift-install create manifests --dir <installation_directory> 1
```

- 1** For **<installation\_directory>**, specify the installation directory that contains the **install-config.yaml** file you created.

2. Remove the Kubernetes manifest files that define the control plane machines and compute machine sets:

```
$ rm -f openshift/99_openshift-cluster-api_master-machines-*.yaml openshift/99_openshift-cluster-api_worker-machineset-*.yaml
```

Because you create and manage these resources yourself, you do not have to initialize them.

- You can preserve the machine set files to create compute machines by using the machine API, but you must update references to them to match your environment.
3. Check that the **mastersSchedulable** parameter in the **<installation\_directory>/manifests/cluster-scheduler-02-config.yml** Kubernetes manifest file is set to **false**. This setting prevents pods from being scheduled on the control plane machines:
    - a. Open the **<installation\_directory>/manifests/cluster-scheduler-02-config.yml** file.
    - b. Locate the **mastersSchedulable** parameter and ensure that it is set to **false**.
    - c. Save and exit the file.

- To create the Ignition configuration files, run the following command from the directory that contains the installation program:

```
$ ./openshift-install create ignition-configs --dir <installation_directory> ❶
```

- For **<installation\_directory>**, specify the same installation directory.

Ignition config files are created for the bootstrap, control plane, and compute nodes in the installation directory. The **kubeadmin-password** and **kubeconfig** files are created in the **./<installation\_directory>/auth** directory:

```
.
├── auth
│   ├── kubeadmin-password
│   └── kubeconfig
├── bootstrap.ign
├── master.ign
├── metadata.json
└── worker.ign
```

## 20.8.12. Configuring chrony time service

You must set the time server and related settings used by the chrony time service (**chronyd**) by modifying the contents of the **chrony.conf** file and passing those contents to your nodes as a machine config.

### Procedure

- Create a Butane config including the contents of the **chrony.conf** file. For example, to configure chrony on worker nodes, create a **99-worker-chrony.bu** file.



### NOTE

See "Creating machine configs with Butane" for information about Butane.

```
variant: openshift
version: 4.10.0
metadata:
  name: 99-worker-chrony ❶
  labels:
    machineconfiguration.openshift.io/role: worker ❷
storage:
  files:
  - path: /etc/chrony.conf
    mode: 0644 ❸
    overwrite: true
    contents:
      inline: |
        pool 0.rhel.pool.ntp.org iburst ❹
        driftfile /var/lib/chrony/drift
```

```
makestep 1.0 3
rtcsync
logdir /var/log/chrony
```

- 1 2 On control plane nodes, substitute **master** for **worker** in both of these locations.
  - 3 Specify an octal value mode for the **mode** field in the machine config file. After creating the file and applying the changes, the **mode** is converted to a decimal value. You can check the YAML file with the command **oc get mc <mc-name> -o yaml**.
  - 4 Specify any valid, reachable time source, such as the one provided by your DHCP server.
2. Use Butane to generate a **MachineConfig** object file, **99-worker-chrony.yaml**, containing the configuration to be delivered to the nodes:

```
$ butane 99-worker-chrony.bu -o 99-worker-chrony.yaml
```

3. Apply the configurations in one of two ways:
  - If the cluster is not running yet, after you generate manifest files, add the **MachineConfig** object file to the **<installation\_directory>/openshift** directory, and then continue to create the cluster.
  - If the cluster is already running, apply the file:

```
$ oc apply -f ./99-worker-chrony.yaml
```

### 20.8.13. Extracting the infrastructure name

The Ignition config files contain a unique cluster identifier that you can use to uniquely identify your cluster in VMware vSphere. If you plan to use the cluster identifier as the name of your virtual machine folder, you must extract it.

#### Prerequisites

- You obtained the OpenShift Container Platform installation program and the pull secret for your cluster.
- You generated the Ignition config files for your cluster.
- You installed the **jq** package.

#### Procedure

- To extract and view the infrastructure name from the Ignition config file metadata, run the following command:

```
$ jq -r .infraID <installation_directory>/metadata.json 1
```

- 1 For **<installation\_directory>**, specify the path to the directory that you stored the installation files in.

#### Example output

openshift-vw9j6 **1**

- 1** The output of this command is your cluster name and a random string.

## 20.8.14. Installing RHCOS and starting the OpenShift Container Platform bootstrap process

To install OpenShift Container Platform on user-provisioned infrastructure on VMware vSphere, you must install Red Hat Enterprise Linux CoreOS (RHCOS) on vSphere hosts. When you install RHCOS, you must provide the Ignition config file that was generated by the OpenShift Container Platform installation program for the type of machine you are installing. If you have configured suitable networking, DNS, and load balancing infrastructure, the OpenShift Container Platform bootstrap process begins automatically after the RHCOS machines have rebooted.

### Prerequisites

- You have obtained the Ignition config files for your cluster.
- You have access to an HTTP server that you can access from your computer and that the machines that you create can access.
- You have created a [vSphere cluster](#).

### Procedure

1. Upload the bootstrap Ignition config file, which is named **<installation\_directory>/bootstrap.ign**, that the installation program created to your HTTP server. Note the URL of this file.
2. Save the following secondary Ignition config file for your bootstrap node to your computer as **<installation\_directory>/merge-bootstrap.ign**:

```
{
  "ignition": {
    "config": {
      "merge": [
        {
          "source": "<bootstrap_ignition_config_url>", 1
          "verification": {}
        }
      ]
    },
    "timeouts": {},
    "version": "3.2.0"
  },
  "networkd": {},
  "passwd": {},
  "storage": {},
  "systemd": {}
}
```

- 1** Specify the URL of the bootstrap Ignition config file that you hosted.

When you create the virtual machine (VM) for the bootstrap machine, you use this Ignition config file.

3. Locate the following Ignition config files that the installation program created:
  - **<installation\_directory>/master.ign**
  - **<installation\_directory>/worker.ign**
  - **<installation\_directory>/merge-bootstrap.ign**
4. Convert the Ignition config files to Base64 encoding. Later in this procedure, you must add these files to the extra configuration parameter **guestinfo.ignition.config.data** in your VM. For example, if you use a Linux operating system, you can use the **base64** command to encode the files.

```
$ base64 -w0 <installation_directory>/master.ign > <installation_directory>/master.64
```

```
$ base64 -w0 <installation_directory>/worker.ign > <installation_directory>/worker.64
```

```
$ base64 -w0 <installation_directory>/merge-bootstrap.ign > <installation_directory>/merge-bootstrap.64
```

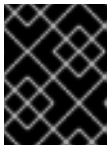

#### IMPORTANT

If you plan to add more compute machines to your cluster after you finish installation, do not delete these files.

5. Obtain the RHCOS OVA image. Images are available from the [RHCOS image mirror](#) page.

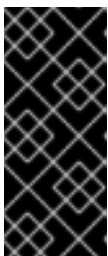

#### IMPORTANT

The RHCOS images might not change with every release of OpenShift Container Platform. You must download an image with the highest version that is less than or equal to the OpenShift Container Platform version that you install. Use the image version that matches your OpenShift Container Platform version if it is available.

The filename contains the OpenShift Container Platform version number in the format **rhcos-vmware.<architecture>.ova**.

6. In the vSphere Client, create a folder in your datacenter to store your VMs.
  - a. Click the **VMs and Templates** view.
  - b. Right-click the name of your datacenter.
  - c. Click **New Folder** → **New VM and Template Folder**.
  - d. In the window that is displayed, enter the folder name. If you did not specify an existing folder in the **install-config.yaml** file, then create a folder with the same name as the infrastructure ID. You use this folder name so vCenter dynamically provisions storage in the appropriate location for its Workspace configuration.

7. In the vSphere Client, create a template for the OVA image and then clone the template as needed.



#### NOTE

In the following steps, you create a template and then clone the template for all of your cluster machines. You then provide the location for the Ignition config file for that cloned machine type when you provision the VMs.

- a. From the **Hosts and Clusters** tab, right-click your cluster name and select **Deploy OVF Template**.
- b. On the **Select an OVF** tab, specify the name of the RHCOS OVA file that you downloaded.
- c. On the **Select a name and folder** tab, set a **Virtual machine name** for your template, such as **Template-RHCOS**. Click the name of your vSphere cluster and select the folder you created in the previous step.
- d. On the **Select a compute resource** tab, click the name of your vSphere cluster.
- e. On the **Select storage** tab, configure the storage options for your VM.
  - Select **Thin Provision** or **Thick Provision**, based on your storage preferences.
  - Select the datastore that you specified in your **install-config.yaml** file.
- f. On the **Select network** tab, specify the network that you configured for the cluster, if available.
- g. When creating the OVF template, do not specify values on the **Customize template** tab or configure the template any further.

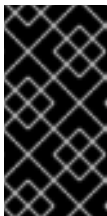

#### IMPORTANT

Do not start the original VM template. The VM template must remain off and must be cloned for new RHCOS machines. Starting the VM template configures the VM template as a VM on the platform, which prevents it from being used as a template that machine sets can apply configurations to.

8. Optional: Update the configured virtual hardware version in the VM template, if necessary. Follow [Upgrading a virtual machine to the latest hardware version](#) in the VMware documentation for more information.

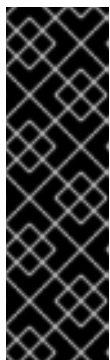

#### IMPORTANT

It is recommended that you update the hardware version of the VM template to version 15 before creating VMs from it, if necessary. Using hardware version 13 for your cluster nodes running on vSphere is now deprecated. If your imported template defaults to hardware version 13, you must ensure that your ESXi host is on 6.7U3 or later before upgrading the VM template to hardware version 15. If your vSphere version is less than 6.7U3, you can skip this upgrade step; however, a future version of OpenShift Container Platform is scheduled to remove support for hardware version 13 and vSphere versions less than 6.7U3.

9. After the template deploys, deploy a VM for a machine in the cluster.
  - a. Right-click the template name and click **Clone** → **Clone to Virtual Machine**
  - b. On the **Select a name and folder** tab, specify a name for the VM. You might include the machine type in the name, such as **control-plane-0** or **compute-1**.

**NOTE**

Ensure that all virtual machine names across a vSphere installation are unique.

- c. On the **Select a name and folder** tab, select the name of the folder that you created for the cluster.
- d. On the **Select a compute resource** tab, select the name of a host in your datacenter.
- e. On the **Select clone options**, select **Customize this virtual machine's hardware**
- f. Optional: On the **Customize hardware** tab, click **VM Options** → **Advanced**.

**IMPORTANT**

The following configuration suggestions are for example purposes only. As a cluster administrator, you must configure resources according to the resource demands placed on your cluster. To best manage cluster resources, consider creating a resource pool from the cluster's root resource pool.

- Override default DHCP networking in vSphere. To enable static IP networking:
  - Set your static IP configuration:

```
$ export IPCFG="ip=<ip>::<gateway>:<netmask>:<hostname>:<iface>:none
nameserver=svr1 [nameserver=svr2 [nameserver=svr3 [...]]]"
```

**Example command**

```
$ export IPCFG="ip=192.168.100.101::192.168.100.254:255.255.255.0::none
nameserver=8.8.8.8"
```

- Click **Edit Configuration**, and on the **Configuration Parameters** window, search the list of available parameters for steal clock accounting (**stealclock.enable**). Set the parameter to the value of **TRUE**. Enabling steal clock accounting can help with troubleshooting cluster issues.
- Click **Add Configuration Params**. Define the following parameter names and values:
  - **disk.EnableUUID**: Specify **TRUE**.
  - **stealclock.enable**: If this parameter was not defined, add it and specify **TRUE**.
  - Create a child resource pool from the cluster's root resource pool. Perform resource allocation in this child resource pool.

- a. In the **Virtual Hardware** panel of the **Customize hardware** tab, modify the specified values

- g. In the **Virtual hardware** panel of the **Customize hardware** tab, modify the specified values as required. Ensure that the amount of RAM, CPU, and disk storage meets the minimum requirements for the machine type.
- h. Complete the configuration and power on the VM.
- i. Check the console output to verify that Ignition ran.

### Example command

```
Ignition: ran on 2022/03/14 14:48:33 UTC (this boot)
Ignition: user-provided config was applied
```

10. Create the rest of the machines for your cluster by following the preceding steps for each machine.

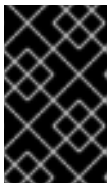

### IMPORTANT

You must create the bootstrap and control plane machines at this time. Because some pods are deployed on compute machines by default, also create at least two compute machines before you install the cluster.

## 20.8.15. Adding more compute machines to a cluster in vSphere

You can add more compute machines to a user-provisioned OpenShift Container Platform cluster on VMware vSphere.

### Prerequisites

- Obtain the base64-encoded Ignition file for your compute machines.
- You have access to the vSphere template that you created for your cluster.

### Procedure

1. After the template deploys, deploy a VM for a machine in the cluster.
  - a. Right-click the template's name and click **Clone** → **Clone to Virtual Machine**
  - b. On the **Select a name and folder** tab, specify a name for the VM. You might include the machine type in the name, such as **compute-1**.



### NOTE

Ensure that all virtual machine names across a vSphere installation are unique.

- c. On the **Select a name and folder** tab, select the name of the folder that you created for the cluster.
- d. On the **Select a compute resource** tab, select the name of a host in your datacenter.
- e. On the **Select clone options**, select **Customize this virtual machine's hardware**
- f. On the **Customize hardware** tab, click **VM Options** → **Advanced**.



- Click **Edit Configuration**, and on the **Configuration Parameters** window, click **Add Configuration Params**. Define the following parameter names and values:
    - **guestinfo.ignition.config.data**: Paste the contents of the base64-encoded compute Ignition config file for this machine type.
    - **guestinfo.ignition.config.data.encoding**: Specify **base64**.
    - **disk.EnableUUID**: Specify **TRUE**.
  - g. In the **Virtual Hardware** panel of the **Customize hardware** tab, modify the specified values as required. Ensure that the amount of RAM, CPU, and disk storage meets the minimum requirements for the machine type. Also, make sure to select the correct network under **Add network adapter** if there are multiple networks available.
  - h. Complete the configuration and power on the VM.
2. Continue to create more compute machines for your cluster.

### 20.8.16. Disk partitioning

In most cases, data partitions are originally created by installing RHCOS, rather than by installing another operating system. In such cases, the OpenShift Container Platform installer should be allowed to configure your disk partitions.

However, there are two cases where you might want to intervene to override the default partitioning when installing an OpenShift Container Platform node:

- **Create separate partitions**: For greenfield installations on an empty disk, you might want to add separate storage to a partition. This is officially supported for making **/var** or a subdirectory of **/var**, such as **/var/lib/etcd**, a separate partition, but not both.

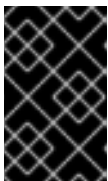

#### IMPORTANT

For disk sizes larger than 100GB, and especially disk sizes larger than 1TB, create a separate **/var** partition. See "Creating a separate **/var** partition" and this [Red Hat Knowledgebase article](#) for more information.

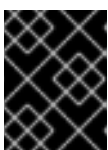

#### IMPORTANT

Kubernetes supports only two file system partitions. If you add more than one partition to the original configuration, Kubernetes cannot monitor all of them.

- **Retain existing partitions**: For a brownfield installation where you are reinstalling OpenShift Container Platform on an existing node and want to retain data partitions installed from your previous operating system, there are both boot arguments and options to **coreos-installer** that allow you to retain existing data partitions.

### Creating a separate **/var** partition

In general, disk partitioning for OpenShift Container Platform should be left to the installer. However, there are cases where you might want to create separate partitions in a part of the filesystem that you expect to grow.

OpenShift Container Platform supports the addition of a single partition to attach storage to either the **/var** partition or a subdirectory of **/var**. For example:

- **/var/lib/containers**: Holds container-related content that can grow as more images and containers are added to a system.
- **/var/lib/etcd**: Holds data that you might want to keep separate for purposes such as performance optimization of etcd storage.
- **/var**: Holds data that you might want to keep separate for purposes such as auditing.

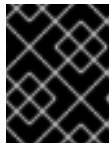

### IMPORTANT

For disk sizes larger than 100GB, and especially larger than 1TB, create a separate **/var** partition.

Storing the contents of a **/var** directory separately makes it easier to grow storage for those areas as needed and reinstall OpenShift Container Platform at a later date and keep that data intact. With this method, you will not have to pull all your containers again, nor will you have to copy massive log files when you update systems.

Because **/var** must be in place before a fresh installation of Red Hat Enterprise Linux CoreOS (RHCOS), the following procedure sets up the separate **/var** partition by creating a machine config manifest that is inserted during the **openshift-install** preparation phases of an OpenShift Container Platform installation.

### Procedure

1. Create a directory to hold the OpenShift Container Platform installation files:

```
$ mkdir $HOME/clusterconfig
```

2. Run **openshift-install** to create a set of files in the **manifest** and **openshift** subdirectories. Answer the system questions as you are prompted:

```
$ openshift-install create manifests --dir $HOME/clusterconfig
? SSH Public Key ...
$ ls $HOME/clusterconfig/openshift/
99_kubeadmin-password-secret.yaml
99_openshift-cluster-api_master-machines-0.yaml
99_openshift-cluster-api_master-machines-1.yaml
99_openshift-cluster-api_master-machines-2.yaml
...
```

3. Create a Butane config that configures the additional partition. For example, name the file **\$HOME/clusterconfig/98-var-partition.bu**, change the disk device name to the name of the storage device on the **worker** systems, and set the storage size as appropriate. This example places the **/var** directory on a separate partition:

```
variant: openshift
version: 4.10.0
metadata:
  labels:
    machineconfiguration.openshift.io/role: worker
  name: 98-var-partition
storage:
  disks:
```

```

- device: /dev/<device_name> ❶
  partitions:
  - label: var
    start_mib: <partition_start_offset> ❷
    size_mib: <partition_size> ❸
  filesystems:
  - device: /dev/disk/by-partlabel/var
    path: /var
    format: xfs
    mount_options: [defaults, prjquota] ❹
    with_mount_unit: true

```

- ❶ The storage device name of the disk that you want to partition.
- ❷ When adding a data partition to the boot disk, a minimum value of 25000 mebibytes is recommended. The root file system is automatically resized to fill all available space up to the specified offset. If no value is specified, or if the specified value is smaller than the recommended minimum, the resulting root file system will be too small, and future reinstalls of RHCOS might overwrite the beginning of the data partition.
- ❸ The size of the data partition in mebibytes.
- ❹ The **prjquota** mount option must be enabled for filesystems used for container storage.

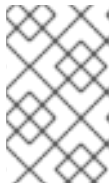

#### NOTE

When creating a separate **/var** partition, you cannot use different instance types for worker nodes, if the different instance types do not have the same device name.

4. Create a manifest from the Butane config and save it to the **clusterconfig/openshift** directory. For example, run the following command:

```
$ butane $HOME/clusterconfig/98-var-partition.bu -o $HOME/clusterconfig/openshift/98-var-partition.yaml
```

5. Run **openshift-install** again to create Ignition configs from a set of files in the **manifest** and **openshift** subdirectories:

```
$ openshift-install create ignition-configs --dir $HOME/clusterconfig
$ ls $HOME/clusterconfig/
auth bootstrap.ign master.ign metadata.json worker.ign
```

Now you can use the Ignition config files as input to the vSphere installation procedures to install Red Hat Enterprise Linux CoreOS (RHCOS) systems.

### 20.8.17. Updating the bootloader using **bootupd**

To update the bootloader by using **bootupd**, you must either install **bootupd** on RHCOS machines manually or provide a machine config with the enabled **systemd** unit. Unlike **grubby** or other bootloader tools, **bootupd** does not manage kernel space configuration such as passing kernel arguments.

After you have installed **bootupd**, you can manage it remotely from the OpenShift Container Platform cluster.

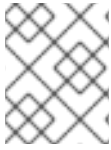

## NOTE

It is recommended that you use **bootupd** only on bare metal or virtualized hypervisor installations, such as for protection against the BootHole vulnerability.

## Manual install method

You can manually install **bootupd** by using the **bootctl** command-line tool.

1. Inspect the system status:

```
# bootupctl status
```

### Example output for x86\_64

```
Component EFI
Installed: grub2-efi-x64-1:2.04-31.fc33.x86_64,shim-x64-15-8.x86_64
Update: At latest version
```

### Example output for aarch64

```
Component EFI
Installed: grub2-efi-aa64-1:2.02-99.el8_4.1.aarch64,shim-aa64-15.4-2.el8_1.aarch64
Update: At latest version
```

2. RHCOS images created without **bootupd** installed on them require an explicit adoption phase. If the system status is **Adoptable**, perform the adoption:

```
# bootupctl adopt-and-update
```

### Example output

```
Updated: grub2-efi-x64-1:2.04-31.fc33.x86_64,shim-x64-15-8.x86_64
```

3. If an update is available, apply the update so that the changes take effect on the next reboot:

```
# bootupctl update
```

### Example output

```
Updated: grub2-efi-x64-1:2.04-31.fc33.x86_64,shim-x64-15-8.x86_64
```

## Machine config method

Another way to enable **bootupd** is by providing a machine config.

- Provide a machine config file with the enabled **systemd** unit, as shown in the following example:

### Example output

```

variant: rhcos
version: 1.1.0
systemd:
  units:
    - name: custom-bootupd-auto.service
      enabled: true
      contents: |
        [Unit]
        Description=Bootupd automatic update

        [Service]
        ExecStart=/usr/bin/bootupctl update
        RemainAfterExit=yes

        [Install]
        WantedBy=multi-user.target

```

### 20.8.18. Waiting for the bootstrap process to complete

The OpenShift Container Platform bootstrap process begins after the cluster nodes first boot into the persistent RHCOS environment that has been installed to disk. The configuration information provided through the Ignition config files is used to initialize the bootstrap process and install OpenShift Container Platform on the machines. You must wait for the bootstrap process to complete.

#### Prerequisites

- You have created the Ignition config files for your cluster.
- You have configured suitable network, DNS and load balancing infrastructure.
- You have obtained the installation program and generated the Ignition config files for your cluster.
- You installed RHCOS on your cluster machines and provided the Ignition config files that the OpenShift Container Platform installation program generated.

#### Procedure

1. Monitor the bootstrap process:

```

$ ./openshift-install --dir <installation_directory> wait-for bootstrap-complete \ 1
--log-level=info 2

```

1 For **<installation\_directory>**, specify the path to the directory that you stored the installation files in.

2 To view different installation details, specify **warn**, **debug**, or **error** instead of **info**.

#### Example output

```

INFO Waiting up to 30m0s for the Kubernetes API at https://api.test.example.com:6443...
INFO API v1.23.0 up
INFO Waiting up to 30m0s for bootstrapping to complete...

```

**INFO** It is now safe to remove the bootstrap resources

The command succeeds when the Kubernetes API server signals that it has been bootstrapped on the control plane machines.

2. After bootstrap process is complete, remove the bootstrap machine from the load balancer.

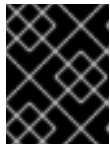

### IMPORTANT

You must remove the bootstrap machine from the load balancer at this point. You can also remove or reformat the bootstrap machine itself.

## 20.8.19. Logging in to the cluster by using the CLI

You can log in to your cluster as a default system user by exporting the cluster **kubeconfig** file. The **kubeconfig** file contains information about the cluster that is used by the CLI to connect a client to the correct cluster and API server. The file is specific to a cluster and is created during OpenShift Container Platform installation.

### Prerequisites

- You deployed an OpenShift Container Platform cluster.
- You installed the **oc** CLI.

### Procedure

1. Export the **kubeadmin** credentials:

```
$ export KUBECONFIG=<installation_directory>/auth/kubeconfig 1
```

- 1** For **<installation\_directory>**, specify the path to the directory that you stored the installation files in.

2. Verify you can run **oc** commands successfully using the exported configuration:

```
$ oc whoami
```

### Example output

```
system:admin
```

## 20.8.20. Approving the certificate signing requests for your machines

When you add machines to a cluster, two pending certificate signing requests (CSRs) are generated for each machine that you added. You must confirm that these CSRs are approved or, if necessary, approve them yourself. The client requests must be approved first, followed by the server requests.

### Prerequisites

- You added machines to your cluster.

## Procedure

1. Confirm that the cluster recognizes the machines:

```
$ oc get nodes
```

### Example output

```
NAME      STATUS    ROLES    AGE    VERSION
master-0  Ready    master   63m   v1.23.0
master-1  Ready    master   63m   v1.23.0
master-2  Ready    master   64m   v1.23.0
```

The output lists all of the machines that you created.



### NOTE

The preceding output might not include the compute nodes, also known as worker nodes, until some CSRs are approved.

2. Review the pending CSRs and ensure that you see the client requests with the **Pending** or **Approved** status for each machine that you added to the cluster:

```
$ oc get csr
```

### Example output

```
NAME      AGE    REQUESTOR                                     CONDITION
csr-8b2br  15m    system:serviceaccount:openshift-machine-config-operator:node-
bootstrapper  Pending
csr-8vnps  15m    system:serviceaccount:openshift-machine-config-operator:node-
bootstrapper  Pending
...
```

In this example, two machines are joining the cluster. You might see more approved CSRs in the list.

3. If the CSRs were not approved, after all of the pending CSRs for the machines you added are in **Pending** status, approve the CSRs for your cluster machines:

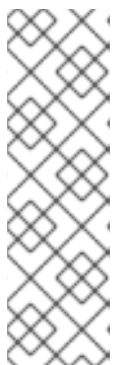

### NOTE

Because the CSRs rotate automatically, approve your CSRs within an hour of adding the machines to the cluster. If you do not approve them within an hour, the certificates will rotate, and more than two certificates will be present for each node. You must approve all of these certificates. After the client CSR is approved, the Kubelet creates a secondary CSR for the serving certificate, which requires manual approval. Then, subsequent serving certificate renewal requests are automatically approved by the **machine-approver** if the Kubelet requests a new certificate with identical parameters.

**NOTE**

For clusters running on platforms that are not machine API enabled, such as bare metal and other user-provisioned infrastructure, you must implement a method of automatically approving the kubelet serving certificate requests (CSRs). If a request is not approved, then the **oc exec**, **oc rsh**, and **oc logs** commands cannot succeed, because a serving certificate is required when the API server connects to the kubelet. Any operation that contacts the Kubelet endpoint requires this certificate approval to be in place. The method must watch for new CSRs, confirm that the CSR was submitted by the **node-bootstrap** service account in the **system:node** or **system:admin** groups, and confirm the identity of the node.

- To approve them individually, run the following command for each valid CSR:

```
$ oc adm certificate approve <csr_name> 1
```

- 1** **<csr\_name>** is the name of a CSR from the list of current CSRs.

- To approve all pending CSRs, run the following command:

```
$ oc get csr -o go-template='{{range .items}}{{if not .status}}{{.metadata.name}}{\n"}\n{{end}}' | xargs --no-run-if-empty oc adm certificate approve
```

**NOTE**

Some Operators might not become available until some CSRs are approved.

- Now that your client requests are approved, you must review the server requests for each machine that you added to the cluster:

```
$ oc get csr
```

**Example output**

```
NAME      AGE   REQUESTOR                                     CONDITION
csr-bfd72 5m26s system:node:ip-10-0-50-126.us-east-2.compute.internal
Pending
csr-c57lv 5m26s system:node:ip-10-0-95-157.us-east-2.compute.internal
Pending
...
```

- If the remaining CSRs are not approved, and are in the **Pending** status, approve the CSRs for your cluster machines:

- To approve them individually, run the following command for each valid CSR:

```
$ oc adm certificate approve <csr_name> 1
```

- 1** **<csr\_name>** is the name of a CSR from the list of current CSRs.



- To approve all pending CSRs, run the following command:

```
$ oc get csr -o go-template='{{range .items}}{{if not .status}}{{.metadata.name}}{\n"}\n{{end}}' | xargs oc adm certificate approve
```

6. After all client and server CSRs have been approved, the machines have the **Ready** status. Verify this by running the following command:

```
$ oc get nodes
```

### Example output

```
NAME      STATUS  ROLES  AGE  VERSION
master-0  Ready   master 73m  v1.23.0
master-1  Ready   master 73m  v1.23.0
master-2  Ready   master 74m  v1.23.0
worker-0  Ready   worker 11m  v1.23.0
worker-1  Ready   worker 11m  v1.23.0
```



### NOTE

It can take a few minutes after approval of the server CSRs for the machines to transition to the **Ready** status.

### Additional information

- For more information on CSRs, see [Certificate Signing Requests](#).

## 20.8.21. Initial Operator configuration

After the control plane initializes, you must immediately configure some Operators so that they all become available.

### Prerequisites

- Your control plane has initialized.

### Procedure

1. Watch the cluster components come online:

```
$ watch -n5 oc get clusteroperators
```

### Example output

NAME	VERSION	AVAILABLE	PROGRESSING	DEGRADED	SINCE
authentication	4.10.0	True	False	False	19m
baremetal	4.10.0	True	False	False	37m
cloud-credential	4.10.0	True	False	False	40m
cluster-autoscaler	4.10.0	True	False	False	37m
config-operator	4.10.0	True	False	False	38m

console	4.10.0	True	False	False	26m
csi-snapshot-controller	4.10.0	True	False	False	37m
dns	4.10.0	True	False	False	37m
etcd	4.10.0	True	False	False	36m
image-registry	4.10.0	True	False	False	31m
ingress	4.10.0	True	False	False	30m
insights	4.10.0	True	False	False	31m
kube-apiserver	4.10.0	True	False	False	26m
kube-controller-manager	4.10.0	True	False	False	36m
kube-scheduler	4.10.0	True	False	False	36m
kube-storage-version-migrator	4.10.0	True	False	False	37m
machine-api	4.10.0	True	False	False	29m
machine-approver	4.10.0	True	False	False	37m
machine-config	4.10.0	True	False	False	36m
marketplace	4.10.0	True	False	False	37m
monitoring	4.10.0	True	False	False	29m
network	4.10.0	True	False	False	38m
node-tuning	4.10.0	True	False	False	37m
openshift-apiserver	4.10.0	True	False	False	32m
openshift-controller-manager	4.10.0	True	False	False	30m
openshift-samples	4.10.0	True	False	False	32m
operator-lifecycle-manager	4.10.0	True	False	False	37m
operator-lifecycle-manager-catalog	4.10.0	True	False	False	37m
operator-lifecycle-manager-packageserver	4.10.0	True	False	False	32m
service-ca	4.10.0	True	False	False	38m
storage	4.10.0	True	False	False	37m

2. Configure the Operators that are not available.

### 20.8.21.1. Disabling the default OperatorHub sources

Operator catalogs that source content provided by Red Hat and community projects are configured for OperatorHub by default during an OpenShift Container Platform installation. In a restricted network environment, you must disable the default catalogs as a cluster administrator.

#### Procedure

- Disable the sources for the default catalogs by adding **disableAllDefaultSources: true** to the **OperatorHub** object:

```
$ oc patch OperatorHub cluster --type json \
  -p '[{"op": "add", "path": "/spec/disableAllDefaultSources", "value": true}]'
```

#### TIP

Alternatively, you can use the web console to manage catalog sources. From the **Administration** → **Cluster Settings** → **Configuration** → **OperatorHub** page, click the **Sources** tab, where you can create, delete, disable, and enable individual sources.

### 20.8.21.2. Image registry storage configuration

The Image Registry Operator is not initially available for platforms that do not provide default storage. After installation, you must configure your registry to use storage so that the Registry Operator is made available.

Instructions are shown for configuring a persistent volume, which is required for production clusters. Where applicable, instructions are shown for configuring an empty directory as the storage location, which is available for only non-production clusters.

Additional instructions are provided for allowing the image registry to use block storage types by using the **Recreate** rollout strategy during upgrades.

### 20.8.21.2.1. Configuring registry storage for VMware vSphere

As a cluster administrator, following installation you must configure your registry to use storage.

#### Prerequisites

- Cluster administrator permissions.
- A cluster on VMware vSphere.
- Persistent storage provisioned for your cluster, such as Red Hat OpenShift Data Foundation.

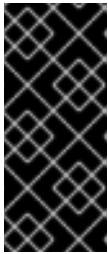

#### IMPORTANT

OpenShift Container Platform supports **ReadWriteOnce** access for image registry storage when you have only one replica. **ReadWriteOnce** access also requires that the registry uses the **Recreate** rollout strategy. To deploy an image registry that supports high availability with two or more replicas, **ReadWriteMany** access is required.

- Must have "100Gi" capacity.

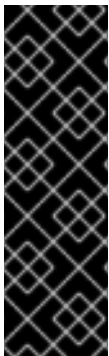

#### IMPORTANT

Testing shows issues with using the NFS server on RHEL as storage backend for core services. This includes the OpenShift Container Registry and Quay, Prometheus for monitoring storage, and Elasticsearch for logging storage. Therefore, using RHEL NFS to back PVs used by core services is not recommended.

Other NFS implementations on the marketplace might not have these issues. Contact the individual NFS implementation vendor for more information on any testing that was possibly completed against these OpenShift Container Platform core components.

#### Procedure

1. To configure your registry to use storage, change the **spec.storage.pvc** in the **configs.imageregistry/cluster** resource.



#### NOTE

When using shared storage, review your security settings to prevent outside access.

2. Verify that you do not have a registry pod:

```
$ oc get pod -n openshift-image-registry -l docker-registry=default
```

### Example output

```
No resources found in openshift-image-registry namespace
```



#### NOTE

If you do have a registry pod in your output, you do not need to continue with this procedure.

3. Check the registry configuration:

```
$ oc edit configs.imageregistry.operator.openshift.io
```

### Example output

```
storage:
  pvc:
    claim: 1
```

- 1 Leave the **claim** field blank to allow the automatic creation of an **image-registry-storage** persistent volume claim (PVC). The PVC is generated based on the default storage class. However, be aware that the default storage class might provide ReadWriteOnce (RWO) volumes, such as a RADOS Block Device (RBD), which can cause issues when replicating to more than one replica.

4. Check the **clusteroperator** status:

```
$ oc get clusteroperator image-registry
```

### Example output

NAME	VERSION	AVAILABLE	PROGRESSING	DEGRADED
image-registry	4.7	True	False	False 6h50m

#### 20.8.21.2.2. Configuring storage for the image registry in non-production clusters

You must configure storage for the Image Registry Operator. For non-production clusters, you can set the image registry to an empty directory. If you do so, all images are lost if you restart the registry.

#### Procedure

- To set the image registry storage to an empty directory:

```
$ oc patch configs.imageregistry.operator.openshift.io cluster --type merge --patch '{"spec": {"storage":{"emptyDir":{}}}'
```

**WARNING**

Configure this option for only non-production clusters.

If you run this command before the Image Registry Operator initializes its components, the **oc patch** command fails with the following error:

```
Error from server (NotFound): configs.imageregistry.operator.openshift.io "cluster" not found
```

Wait a few minutes and run the command again.

**20.8.21.2.3. Configuring block registry storage for VMware vSphere**

To allow the image registry to use block storage types such as vSphere Virtual Machine Disk (VMDK) during upgrades as a cluster administrator, you can use the **Recreate** rollout strategy.

**IMPORTANT**

Block storage volumes are supported but not recommended for use with image registry on production clusters. An installation where the registry is configured on block storage is not highly available because the registry cannot have more than one replica.

**Procedure**

1. To set the image registry storage as a block storage type, patch the registry so that it uses the **Recreate** rollout strategy and runs with only **1** replica:

```
$ oc patch config.imageregistry.operator.openshift.io/cluster --type=merge -p '{"spec": {"rolloutStrategy": "Recreate", "replicas": 1}}'
```

2. Provision the PV for the block storage device, and create a PVC for that volume. The requested block volume uses the ReadWriteOnce (RWO) access mode.

- a. Create a **pvc.yaml** file with the following contents to define a VMware vSphere **PersistentVolumeClaim** object:

```
kind: PersistentVolumeClaim
apiVersion: v1
metadata:
  name: image-registry-storage 1
  namespace: openshift-image-registry 2
spec:
  accessModes:
  - ReadWriteOnce 3
  resources:
    requests:
      storage: 100Gi 4
```

- 1** A unique name that represents the **PersistentVolumeClaim** object.

- 2 The namespace for the **PersistentVolumeClaim** object, which is **openshift-image-registry**.
- 3 The access mode of the persistent volume claim. With **ReadWriteOnce**, the volume can be mounted with read and write permissions by a single node.
- 4 The size of the persistent volume claim.

b. Create the **PersistentVolumeClaim** object from the file:

```
$ oc create -f pvc.yaml -n openshift-image-registry
```

3. Edit the registry configuration so that it references the correct PVC:

```
$ oc edit config.imageregistry.operator.openshift.io -o yaml
```

### Example output

```
storage:
  pvc:
    claim: 1
```

- 1 Creating a custom PVC allows you to leave the **claim** field blank for the default automatic creation of an **image-registry-storage** PVC.

For instructions about configuring registry storage so that it references the correct PVC, see [Configuring the registry for vSphere](#).

## 20.8.22. Completing installation on user-provisioned infrastructure

After you complete the Operator configuration, you can finish installing the cluster on infrastructure that you provide.

### Prerequisites

- Your control plane has initialized.
- You have completed the initial Operator configuration.

### Procedure

1. Confirm that all the cluster components are online with the following command:

```
$ watch -n5 oc get clusteroperators
```

### Example output

NAME	VERSION	AVAILABLE	PROGRESSING	DEGRADED
authentication	4.10.0	True	False	False 19m
baremetal	4.10.0	True	False	False 37m

cloud-credential	4.10.0	True	False	False	40m
cluster-autoscaler	4.10.0	True	False	False	37m
config-operator	4.10.0	True	False	False	38m
console	4.10.0	True	False	False	26m
csi-snapshot-controller	4.10.0	True	False	False	37m
dns	4.10.0	True	False	False	37m
etcd	4.10.0	True	False	False	36m
image-registry	4.10.0	True	False	False	31m
ingress	4.10.0	True	False	False	30m
insights	4.10.0	True	False	False	31m
kube-apiserver	4.10.0	True	False	False	26m
kube-controller-manager	4.10.0	True	False	False	36m
kube-scheduler	4.10.0	True	False	False	36m
kube-storage-version-migrator	4.10.0	True	False	False	37m
machine-api	4.10.0	True	False	False	29m
machine-approver	4.10.0	True	False	False	37m
machine-config	4.10.0	True	False	False	36m
marketplace	4.10.0	True	False	False	37m
monitoring	4.10.0	True	False	False	29m
network	4.10.0	True	False	False	38m
node-tuning	4.10.0	True	False	False	37m
openshift-apiserver	4.10.0	True	False	False	32m
openshift-controller-manager	4.10.0	True	False	False	30m
openshift-samples	4.10.0	True	False	False	32m
operator-lifecycle-manager	4.10.0	True	False	False	37m
operator-lifecycle-manager-catalog	4.10.0	True	False	False	37m
operator-lifecycle-manager-packageserver	4.10.0	True	False	False	32m
service-ca	4.10.0	True	False	False	38m
storage	4.10.0	True	False	False	37m

Alternatively, the following command notifies you when all of the clusters are available. It also retrieves and displays credentials:

```
$ ./openshift-install --dir <installation_directory> wait-for install-complete 1
```

- 1** For **<installation\_directory>**, specify the path to the directory that you stored the installation files in.

### Example output

```
INFO Waiting up to 30m0s for the cluster to initialize...
```

The command succeeds when the Cluster Version Operator finishes deploying the OpenShift Container Platform cluster from Kubernetes API server.



## IMPORTANT

- The Ignition config files that the installation program generates contain certificates that expire after 24 hours, which are then renewed at that time. If the cluster is shut down before renewing the certificates and the cluster is later restarted after the 24 hours have elapsed, the cluster automatically recovers the expired certificates. The exception is that you must manually approve the pending **node-bootstrapper** certificate signing requests (CSRs) to recover kubelet certificates. See the documentation for *Recovering from expired control plane certificates* for more information.
- It is recommended that you use Ignition config files within 12 hours after they are generated because the 24-hour certificate rotates from 16 to 22 hours after the cluster is installed. By using the Ignition config files within 12 hours, you can avoid installation failure if the certificate update runs during installation.

2. Confirm that the Kubernetes API server is communicating with the pods.

a. To view a list of all pods, use the following command:

```
$ oc get pods --all-namespaces
```

### Example output

```

NAMESPACE           NAME                                     READY  STATUS
RESTARTS  AGE
openshift-apiserver-operator  openshift-apiserver-operator-85cb746d55-zqhs8  1/1
Running   1    9m
openshift-apiserver          apiserver-67b9g                                1/1  Running  0
3m
openshift-apiserver          apiserver-ljcmx                                1/1  Running  0
1m
openshift-apiserver          apiserver-z25h4                                1/1  Running  0
2m
openshift-authentication-operator  authentication-operator-69d5d8bf84-vh2n8      1/1
Running   0    5m
...

```

b. View the logs for a pod that is listed in the output of the previous command by using the following command:

```
$ oc logs <pod_name> -n <namespace> 1
```

- 1** Specify the pod name and namespace, as shown in the output of the previous command.

If the pod logs display, the Kubernetes API server can communicate with the cluster machines.

3. For an installation with Fibre Channel Protocol (FCP), additional steps are required to enable multipathing. Do not enable multipathing during installation. See "Enabling multipathing with kernel arguments on RHCOS" in the *Post-installation machine configuration tasks* documentation for more information.



4. Register your cluster on the [Cluster registration](#) page.

You can add extra compute machines after the cluster installation is completed by following [Adding compute machines to vSphere](#).

### 20.8.23. Configuring vSphere DRS anti-affinity rules for control plane nodes

vSphere Distributed Resource Scheduler (DRS) anti-affinity rules can be configured to support higher availability of OpenShift Container Platform control plane nodes. Anti-affinity rules ensure that the vSphere Virtual Machines for the OpenShift Container Platform control plane nodes are not scheduled to the same vSphere Host.

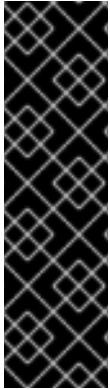

#### IMPORTANT

- The following information applies to compute DRS only and does not apply to storage DRS.
- The **govc** command is an open-source command available from VMware; it is not available from Red Hat. The **govc** command is not supported by the Red Hat support.
- Instructions for downloading and installing **govc** are found on the VMware documentation website.

Create an anti-affinity rule by running the following command:

#### Example command

```
$ govc cluster.rule.create \
  -name openshift4-control-plane-group \
  -dc MyDatacenter -cluster MyCluster \
  -enable \
  -anti-affinity master-0 master-1 master-2
```

After creating the rule, your control plane nodes are automatically migrated by vSphere so they are not running on the same hosts. This might take some time while vSphere reconciles the new rule. Successful command completion is shown in the following procedure.



#### NOTE

The migration occurs automatically and might cause brief OpenShift API outage or latency until the migration finishes.

The vSphere DRS anti-affinity rules need to be updated manually in the event of a control plane VM name change or migration to a new vSphere Cluster.

#### Procedure

1. Remove any existing DRS anti-affinity rule by running the following command:

```
$ govc cluster.rule.remove \
  -name openshift4-control-plane-group \
  -dc MyDatacenter -cluster MyCluster
```

## Example Output

```
[13-10-22 09:33:24] Reconfigure /MyDatacenter/host/MyCluster...OK
```

2. Create the rule again with updated names by running the following command:

```
$ govc cluster.rule.create \  
-name openshift4-control-plane-group \  
-dc MyDatacenter -cluster MyOtherCluster \  
-enable \  
-anti-affinity master-0 master-1 master-2
```

### 20.8.24. Backing up VMware vSphere volumes

OpenShift Container Platform provisions new volumes as independent persistent disks to freely attach and detach the volume on any node in the cluster. As a consequence, it is not possible to back up volumes that use snapshots, or to restore volumes from snapshots. See [Snapshot Limitations](#) for more information.

#### Procedure

To create a backup of persistent volumes:

1. Stop the application that is using the persistent volume.
2. Clone the persistent volume.
3. Restart the application.
4. Create a backup of the cloned volume.
5. Delete the cloned volume.

### 20.8.25. Telemetry access for OpenShift Container Platform

In OpenShift Container Platform 4.10, the Telemetry service, which runs by default to provide metrics about cluster health and the success of updates, requires internet access. If your cluster is connected to the internet, Telemetry runs automatically, and your cluster is registered to [OpenShift Cluster Manager](#).

After you confirm that your [OpenShift Cluster Manager](#) inventory is correct, either maintained automatically by Telemetry or manually by using OpenShift Cluster Manager, [use subscription watch](#) to track your OpenShift Container Platform subscriptions at the account or multi-cluster level.

#### Additional resources

- See [About remote health monitoring](#) for more information about the Telemetry service

### 20.8.26. Next steps

- [Customize your cluster](#).
- If the mirror registry that you used to install your cluster has a trusted CA, add it to the cluster by [configuring additional trust stores](#).
- If necessary, you can [opt out of remote health reporting](#).

- Optional: [View the events from the vSphere Problem Detector Operator](#) to determine if the cluster has permission or storage configuration issues.

## 20.9. UNINSTALLING A CLUSTER ON VSPHERE THAT USES INSTALLER-PROVISIONED INFRASTRUCTURE

You can remove a cluster that you deployed in your VMware vSphere instance by using installer-provisioned infrastructure.



### NOTE

When you run the **openshift-install destroy cluster** command to uninstall OpenShift Container Platform, vSphere volumes are not automatically deleted. The cluster administrator must manually find the vSphere volumes and delete them.

### 20.9.1. Removing a cluster that uses installer-provisioned infrastructure

You can remove a cluster that uses installer-provisioned infrastructure from your cloud.

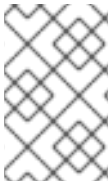

### NOTE

After uninstallation, check your cloud provider for any resources not removed properly, especially with User Provisioned Infrastructure (UPI) clusters. There might be resources that the installer did not create or that the installer is unable to access.

#### Prerequisites

- Have a copy of the installation program that you used to deploy the cluster.
- Have the files that the installation program generated when you created your cluster.

#### Procedure

1. From the directory that contains the installation program on the computer that you used to install the cluster, run the following command:

```

$ ./openshift-install destroy cluster \
--dir <installation_directory> --log-level info 1 2

```

- 1** For **<installation\_directory>**, specify the path to the directory that you stored the installation files in.
- 2** To view different details, specify **warn**, **debug**, or **error** instead of **info**.

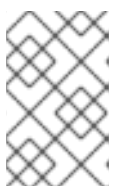

### NOTE

You must specify the directory that contains the cluster definition files for your cluster. The installation program requires the **metadata.json** file in this directory to delete the cluster.

1. Optional: Delete the **<installation\_directory>** directory and the OpenShift Container Platform installation program.

## 20.10. USING THE VSPHERE PROBLEM DETECTOR OPERATOR

### 20.10.1. About the vSphere Problem Detector Operator

The vSphere Problem Detector Operator checks clusters that are deployed on vSphere for common installation and misconfiguration issues that are related to storage.

The Operator runs in the **openshift-cluster-storage-operator** namespace and is started by the Cluster Storage Operator when the Cluster Storage Operator detects that the cluster is deployed on vSphere. The vSphere Problem Detector Operator communicates with the vSphere vCenter Server to determine the virtual machines in the cluster, the default datastore, and other information about the vSphere vCenter Server configuration. The Operator uses the credentials from the Cloud Credential Operator to connect to vSphere.

The Operator runs the checks according to the following schedule:

- The checks run every 8 hours.
- If any check fails, the Operator runs the checks again in intervals of 1 minute, 2 minutes, 4, 8, and so on. The Operator doubles the interval up to a maximum interval of 8 hours.
- When all checks pass, the schedule returns to an 8 hour interval.

The Operator increases the frequency of the checks after a failure so that the Operator can report success quickly after the failure condition is remedied. You can run the Operator manually for immediate troubleshooting information.

### 20.10.2. Running the vSphere Problem Detector Operator checks

You can override the schedule for running the vSphere Problem Detector Operator checks and run the checks immediately.

The vSphere Problem Detector Operator automatically runs the checks every 8 hours. However, when the Operator starts, it runs the checks immediately. The Operator is started by the Cluster Storage Operator when the Cluster Storage Operator starts and determines that the cluster is running on vSphere. To run the checks immediately, you can scale the vSphere Problem Detector Operator to **0** and back to **1** so that it restarts the vSphere Problem Detector Operator.

#### Prerequisites

- Access to the cluster as a user with the **cluster-admin** role.

#### Procedure

1. Scale the Operator to **0**:

```
$ oc scale deployment/vsphere-problem-detector-operator --replicas=0 \
-n openshift-cluster-storage-operator
```

If the deployment does not scale to zero immediately, you can run the following command to wait for the pods to exit:

```
$ oc wait pods -l name=vsphere-problem-detector-operator \
--for=delete --timeout=5m -n openshift-cluster-storage-operator
```

2. Scale the Operator back to **1**:

```
$ oc scale deployment/vsphere-problem-detector-operator --replicas=1 \
-n openshift-cluster-storage-operator
```

3. Delete the old leader lock to speed up the new leader election for the Cluster Storage Operator:

```
$ oc delete -n openshift-cluster-storage-operator \
cm vsphere-problem-detector-lock
```

### Verification

- View the events or logs that are generated by the vSphere Problem Detector Operator. Confirm that the events or logs have recent timestamps.

### 20.10.3. Viewing the events from the vSphere Problem Detector Operator

After the vSphere Problem Detector Operator runs and performs the configuration checks, it creates events that can be viewed from the command line or from the OpenShift Container Platform web console.

#### Procedure

- To view the events by using the command line, run the following command:

```
$ oc get event -n openshift-cluster-storage-operator \
--sort-by={.metadata.creationTimestamp}
```

#### Example output

```
16m Normal Started pod/vsphere-problem-detector-operator-xxxxx Started
container vsphere-problem-detector
16m Normal Created pod/vsphere-problem-detector-operator-xxxxx Created
container vsphere-problem-detector
16m Normal LeaderElection configmap/vsphere-problem-detector-lock vsphere-
problem-detector-operator-xxxxx became leader
```

- To view the events by using the OpenShift Container Platform web console, navigate to **Home** → **Events** and select **openshift-cluster-storage-operator** from the **Project** menu.

### 20.10.4. Viewing the logs from the vSphere Problem Detector Operator

After the vSphere Problem Detector Operator runs and performs the configuration checks, it creates log records that can be viewed from the command line or from the OpenShift Container Platform web console.

#### Procedure

- To view the logs by using the command line, run the following command:

```
$ oc logs deployment/vsphere-problem-detector-operator \
-n openshift-cluster-storage-operator
```

## Example output

```

I0108 08:32:28.445696    1 operator.go:209] ClusterInfo passed
I0108 08:32:28.451029    1 datastore.go:57] CheckStorageClasses checked 1 storage
classes, 0 problems found
I0108 08:32:28.451047    1 operator.go:209] CheckStorageClasses passed
I0108 08:32:28.452160    1 operator.go:209] CheckDefaultDatastore passed
I0108 08:32:28.480648    1 operator.go:271] CheckNodeDiskUUID:<host_name> passed
I0108 08:32:28.480685    1 operator.go:271] CheckNodeProviderID:<host_name> passed

```

- To view the Operator logs with the OpenShift Container Platform web console, perform the following steps:
  - a. Navigate to **Workloads** → **Pods**.
  - b. Select **openshift-cluster-storage-operator** from the **Projects** menu.
  - c. Click the link for the **vsphere-problem-detector-operator** pod.
  - d. Click the **Logs** tab on the **Pod details** page to view the logs.

### 20.10.5. Configuration checks run by the vSphere Problem Detector Operator

The following tables identify the configuration checks that the vSphere Problem Detector Operator runs. Some checks verify the configuration of the cluster. Other checks verify the configuration of each node in the cluster.

**Table 20.86. Cluster configuration checks**

Name	Description
<b>CheckDefaultDatastore</b>	<p>Verifies that the default datastore name in the vSphere configuration is short enough for use with dynamic provisioning.</p> <p>If this check fails, you can expect the following:</p> <ul style="list-style-type: none"> <li>• <b>systemd</b> logs errors to the journal such as <b>Failed to set up mount unit: Invalid argument</b>.</li> <li>• <b>systemd</b> does not unmount volumes if the virtual machine is shut down or rebooted without draining all the pods from the node.</li> </ul> <p>If this check fails, reconfigure vSphere with a shorter name for the default datastore.</p>
<b>CheckFolderPermissions</b>	<p>Verifies the permission to list volumes in the default datastore. This permission is required to create volumes. The Operator verifies the permission by listing the / and <b>/kubevols</b> directories. The root directory must exist. It is acceptable if the <b>/kubevols</b> directory does not exist when the check runs. The <b>/kubevols</b> directory is created when the datastore is used with dynamic provisioning if the directory does not already exist.</p> <p>If this check fails, review the required permissions for the vCenter account that was specified during the OpenShift Container Platform installation.</p>

Name	Description
<b>CheckStorageClasses</b>	Verifies the following: <ul style="list-style-type: none"> <li>• The fully qualified path to each persistent volume that is provisioned by this storage class is less than 255 characters.</li> <li>• If a storage class uses a storage policy, the storage class must use one policy only and that policy must be defined.</li> </ul>
<b>CheckTaskPermissions</b>	Verifies the permission to list recent tasks and datastores.
<b>ClusterInfo</b>	Collects the cluster version and UUID from vSphere vCenter.

Table 20.87. Node configuration checks

Name	Description
<b>CheckNodeDiskUUID</b>	Verifies that all the vSphere virtual machines are configured with <b>disk.enableUUID=TRUE</b> .  If this check fails, see the <a href="#">How to check 'disk.EnableUUID' parameter from VM in vSphere</a> Red Hat Knowledgebase solution.
<b>CheckNodeProviderID</b>	Verifies that all nodes are configured with the <b>ProviderID</b> from vSphere vCenter. This check fails when the output from the following command does not include a provider ID for each node.  <pre>\$ oc get nodes -o custom-columns=NAME:.metadata.name,PROVIDER_ID:.spec.providerID,UUID:.status.nodeInfo.systemUUID</pre> If this check fails, refer to the vSphere product documentation for information about setting the provider ID for each node in the cluster.
<b>CollectNodeESXiVersion</b>	Reports the version of the ESXi hosts that run nodes.
<b>CollectNodeHWVersion</b>	Reports the virtual machine hardware version for a node.

### 20.10.6. About the storage class configuration check

The names for persistent volumes that use vSphere storage are related to the datastore name and cluster ID.

When a persistent volume is created, **systemd** creates a mount unit for the persistent volume. The **systemd** process has a 255 character limit for the length of the fully qualified path to the VDMK file that is used for the persistent volume.

The fully qualified path is based on the naming conventions for **systemd** and vSphere. The naming conventions use the following pattern:

```
/var/lib/kubelet/plugins/kubernetes.io/vsphere-volume/mounts/[-<datastore>] 00000000-0000-0000-0000-0000000000000000/<cluster_id>-dynamic-pvc-00000000-0000-0000-0000-000000000000.vmdk
```

- The naming conventions require 205 characters of the 255 character limit.
- The datastore name and the cluster ID are determined from the deployment.
- The datastore name and cluster ID are substituted into the preceding pattern. Then the path is processed with the **systemd-escape** command to escape special characters. For example, a hyphen character uses four characters after it is escaped. The escaped value is **\x2d**.
- After processing with **systemd-escape** to ensure that **systemd** can access the fully qualified path to the VDMK file, the length of the path must be less than 255 characters.

### 20.10.7. Metrics for the vSphere Problem Detector Operator

The vSphere Problem Detector Operator exposes the following metrics for use by the OpenShift Container Platform monitoring stack.

Table 20.88. Metrics exposed by the vSphere Problem Detector Operator

Name	Description
<b>vsphere_cluster_check_total</b>	Cumulative number of cluster-level checks that the vSphere Problem Detector Operator performed. This count includes both successes and failures.
<b>vsphere_cluster_check_errors</b>	Number of failed cluster-level checks that the vSphere Problem Detector Operator performed. For example, a value of <b>1</b> indicates that one cluster-level check failed.
<b>vsphere_esxi_version_total</b>	Number of ESXi hosts with a specific version. Be aware that if a host runs more than one node, the host is counted only once.
<b>vsphere_node_check_total</b>	Cumulative number of node-level checks that the vSphere Problem Detector Operator performed. This count includes both successes and failures.
<b>vsphere_node_check_errors</b>	Number of failed node-level checks that the vSphere Problem Detector Operator performed. For example, a value of <b>1</b> indicates that one node-level check failed.
<b>vsphere_node_hw_version_total</b>	Number of vSphere nodes with a specific hardware version.
<b>vsphere_vcenter_info</b>	Information about the vSphere vCenter Server.

### 20.10.8. Additional resources

- [Monitoring overview](#)



## CHAPTER 21. INSTALLING ON VMC

### 21.1. PREPARING TO INSTALL ON VMC

#### 21.1.1. Prerequisites

- You reviewed details about the [OpenShift Container Platform installation and update](#) processes.
- You read the documentation on [selecting a cluster installation method and preparing it for users](#).
- If you use a firewall and plan to use Telemetry, you [configured the firewall to allow the sites](#) required by your cluster.

#### 21.1.2. Choosing a method to install OpenShift Container Platform on VMC

You can install OpenShift Container Platform on VMC by using installer-provisioned or user-provisioned infrastructure. The default installation type uses installer-provisioned infrastructure, where the installation program provisions the underlying infrastructure for the cluster. You can also install OpenShift Container Platform on infrastructure that you provide. If you do not use infrastructure that the installation program provisions, you must manage and maintain the cluster resources yourself.

See the [Installation process](#) for more information about installer-provisioned and user-provisioned installation processes.



#### IMPORTANT

The steps for performing a user-provisioned infrastructure installation are provided as an example only. Installing a cluster with infrastructure you provide requires knowledge of the VMC platform and the installation process of OpenShift Container Platform. Use the user-provisioned infrastructure installation instructions as a guide; you are free to create the required resources through other methods.

##### 21.1.2.1. Installer-provisioned infrastructure installation of OpenShift Container Platform on VMC

Installer-provisioned infrastructure allows the installation program to pre-configure and automate the provisioning of resources required by OpenShift Container Platform.

- **Installing a cluster on VMC** You can install OpenShift Container Platform on VMC by using installer-provisioned infrastructure installation with no customization.
- **Installing a cluster on VMC with customizations** You can install OpenShift Container Platform on VMC by using installer-provisioned infrastructure installation with the default customization options.
- **Installing a cluster on VMC with network customizations** You can install OpenShift Container Platform on installer-provisioned VMC infrastructure, with network customizations. You can customize your OpenShift Container Platform network configuration during installation, so that your cluster can coexist with your existing IP address allocations and adhere to your network requirements.
- **Installing a cluster on VMC in a restricted network** You can install a cluster on VMC

infrastructure in a restricted network by creating an internal mirror of the installation release content. You can use this method to deploy OpenShift Container Platform on an internal network that is not visible to the internet.

### 21.1.2.2. User-provisioned infrastructure installation of OpenShift Container Platform on VMC

User-provisioned infrastructure requires the user to provision all resources required by OpenShift Container Platform.

- [Installing a cluster on VMC with user-provisioned infrastructure](#) You can install OpenShift Container Platform on VMC infrastructure that you provision.
- [Installing a cluster on VMC with user-provisioned infrastructure and network customizations](#): You can install OpenShift Container Platform on VMC infrastructure that you provision with customized network configuration options.
- [Installing a cluster on VMC in a restricted network with user-provisioned infrastructure](#) OpenShift Container Platform can be installed on VMC infrastructure that you provision in a restricted network.

### 21.1.3. VMware vSphere infrastructure requirements

You must install the OpenShift Container Platform cluster on a VMware vSphere version 7 instance that meets the requirements for the components that you use.



#### NOTE

OpenShift Container Platform version 4.10 does not support VMware vSphere version 8.0.

You can host the VMware vSphere infrastructure on-premise or on a [VMware Cloud Verified provider](#) that meets the requirements outlined in the following table:

**Table 21.1. Version requirements for vSphere virtual environments**

Virtual environment product	Required version
VM hardware version	15 or later
vSphere ESXi hosts	7
vCenter host	7

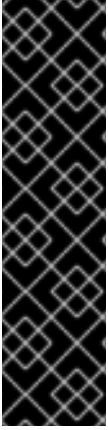

## IMPORTANT

Installing a cluster on VMware vSphere version 7.0 Update 1 is now deprecated. These versions are still fully supported, but version 4.10 of OpenShift Container Platform requires vSphere virtual hardware version 15 or later. Hardware version 15 is now the default for vSphere virtual machines in OpenShift Container Platform. To update the hardware version for your vSphere nodes, see the "Updating hardware on nodes running in vSphere" article.

If your vSphere nodes are below hardware version 15 or your VMware vSphere version is earlier than 6.7U3, upgrading from OpenShift Container Platform 4.10 to OpenShift Container Platform 4.11 is not available.

**Table 21.2. Minimum supported vSphere version for VMware components**

Component	Minimum supported versions	Description
Hypervisor	vSphere 7 with HW version 15	This version is the minimum version that Red Hat Enterprise Linux CoreOS (RHCOS) supports. For more information about supported hardware on the latest version of Red Hat Enterprise Linux (RHEL) that is compatible with RHCOS, see <a href="#">Hardware</a> on the Red Hat Customer Portal.
Storage with in-tree drivers	vSphere 7	This plugin creates vSphere storage by using the in-tree storage drivers for vSphere included in OpenShift Container Platform.

If you use a vSphere version 6.5 instance, upgrade to 7.0 before you install OpenShift Container Platform.



## IMPORTANT

You must ensure that the time on your ESXi hosts is synchronized before you install OpenShift Container Platform. See [Edit Time Configuration for a Host](#) in the VMware documentation.

### 21.1.4. VMware vSphere CSI Driver Operator requirements

To install the vSphere CSI Driver Operator, the following requirements must be met:

- VMware vSphere version 6.7U3 or later
- Virtual machines of hardware version 15 or later
- No third-party vSphere CSI driver already installed in the cluster



## IMPORTANT

If a third-party vSphere CSI driver is present in the cluster, OpenShift Container Platform does not overwrite it. If you continue with the third-party vSphere CSI driver when upgrading to the next major version of OpenShift Container Platform, the **oc** CLI prompts you with the following message:

```
VSphereCSIDriverOperatorCRUpgradeable: VMwareVSphereControllerUpgradeable:
found existing unsupported csi.vsphere.vmware.com driver
```

The previous message informs you that Red Hat does not support the third-party vSphere CSI driver during an OpenShift Container Platform upgrade operation. You can choose to ignore this message and continue with the upgrade operation.

### Additional resources

- To remove a third-party CSI driver, see [Removing a third-party vSphere CSI Driver](#).

## 21.1.5. Uninstalling an installer-provisioned infrastructure installation of OpenShift Container Platform on VMC

- [Uninstalling a cluster on VMC that uses installer-provisioned infrastructure](#) You can remove a cluster that you deployed on VMC infrastructure that used installer-provisioned infrastructure.

## 21.2. INSTALLING A CLUSTER ON VMC

In OpenShift Container Platform version 4.10, you can install a cluster on VMware vSphere by deploying it to [VMware Cloud \(VMC\) on AWS](#).

Once you have configured your VMC environment for OpenShift Container Platform deployment, you use the OpenShift Container Platform installation program from the bastion management host, co-located in the VMC environment. The installation program and control plane automates the process of deploying and managing the resources needed for the OpenShift Container Platform cluster.



## NOTE

OpenShift Container Platform supports deploying a cluster to a single VMware vCenter only. Deploying a cluster with machines/machine sets on multiple vCenters is not supported.

### 21.2.1. Setting up VMC for vSphere

You can install OpenShift Container Platform on VMware Cloud (VMC) on AWS hosted vSphere clusters to enable applications to be deployed and managed both on-premise and off-premise, across the hybrid cloud.

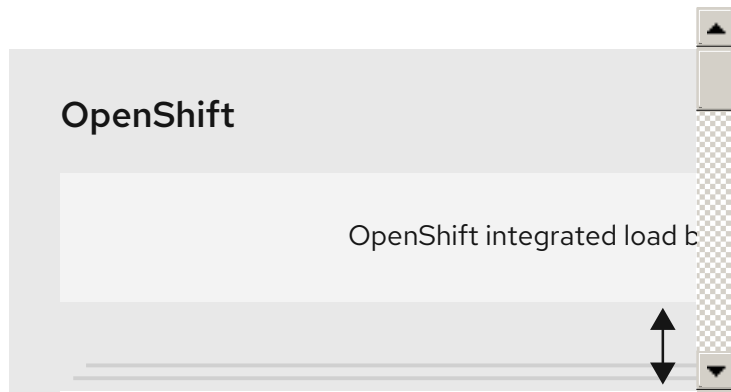

You must configure several options in your VMC environment prior to installing OpenShift Container Platform on VMware vSphere. Ensure your VMC environment has the following prerequisites:

- Create a non-exclusive, DHCP-enabled, NSX-T network segment and subnet. Other virtual machines (VMs) can be hosted on the subnet, but at least eight IP addresses must be available for the OpenShift Container Platform deployment.
- Allocate two IP addresses, outside the DHCP range, and configure them with reverse DNS records.
  - A DNS record for **api.<cluster\_name>.<base\_domain>** pointing to the allocated IP address.
  - A DNS record for **\*.apps.<cluster\_name>.<base\_domain>** pointing to the allocated IP address.
- Configure the following firewall rules:
  - An ANY:ANY firewall rule between the OpenShift Container Platform compute network and the internet. This is used by nodes and applications to download container images.
  - An ANY:ANY firewall rule between the installation host and the software-defined data center (SDDC) management network on port 443. This allows you to upload the Red Hat Enterprise Linux CoreOS (RHCOS) OVA during deployment.
  - An HTTPS firewall rule between the OpenShift Container Platform compute network and vCenter. This connection allows OpenShift Container Platform to communicate with vCenter for provisioning and managing nodes, persistent volume claims (PVCs), and other resources.
- You must have the following information to deploy OpenShift Container Platform:
  - The OpenShift Container Platform cluster name, such as **vmc-prod-1**.
  - The base DNS name, such as **companyname.com**.
  - If not using the default, the pod network CIDR and services network CIDR must be identified, which are set by default to **10.128.0.0/14** and **172.30.0.0/16**, respectively. These CIDRs are used for pod-to-pod and pod-to-service communication and are not accessible externally; however, they must not overlap with existing subnets in your organization.
  - The following vCenter information:
    - vCenter hostname, username, and password
    - Datacenter name, such as **SDDC-Datacenter**

- Cluster name, such as **Cluster-1**
- Network name
- Datastore name, such as **WorkloadDatastore**

**NOTE**

It is recommended to move your vSphere cluster to the VMC **Compute-ResourcePool** resource pool after your cluster installation is finished.

- A Linux-based host deployed to VMC as a bastion.
  - The bastion host can be Red Hat Enterprise Linux (RHEL) or any another Linux-based host; it must have internet connectivity and the ability to upload an OVA to the ESXi hosts.
  - Download and install the OpenShift CLI tools to the bastion host.
    - The **openshift-install** installation program
    - The OpenShift CLI (**oc**) tool

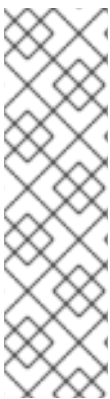
**NOTE**

You cannot use the VMware NSX Container Plugin for Kubernetes (NCP), and NSX is not used as the OpenShift SDN. The version of NSX currently available with VMC is incompatible with the version of NCP certified with OpenShift Container Platform.

However, the NSX DHCP service is used for virtual machine IP management with the full-stack automated OpenShift Container Platform deployment and with nodes provisioned, either manually or automatically, by the Machine API integration with vSphere. Additionally, NSX firewall rules are created to enable access with the OpenShift Container Platform cluster and between the bastion host and the VMC vSphere hosts.

**21.2.1.1. VMC Sizer tool**

VMware Cloud on AWS is built on top of AWS bare metal infrastructure; this is the same bare metal infrastructure which runs AWS native services. When a VMware cloud on AWS software-defined data center (SDDC) is deployed, you consume these physical server nodes and run the VMware ESXi hypervisor in a single tenant fashion. This means the physical infrastructure is not accessible to anyone else using VMC. It is important to consider how many physical hosts you will need to host your virtual infrastructure.

To determine this, VMware provides the [VMC on AWS Sizer](#). With this tool, you can define the resources you intend to host on VMC:

- Types of workloads
- Total number of virtual machines
- Specification information such as:
  - Storage requirements
  - vCPUs

- vRAM
- Overcommit ratios

With these details, the sizer tool can generate a report, based on VMware best practices, and recommend your cluster configuration and the number of hosts you will need.

### 21.2.2. vSphere prerequisites

- You reviewed details about the [OpenShift Container Platform installation and update](#) processes.
- You read the documentation on [selecting a cluster installation method and preparing it for users](#).
- You provisioned [block registry storage](#). For more information on persistent storage, see [Understanding persistent storage](#).
- If you use a firewall, you [configured it to allow the sites](#) that your cluster requires access to.

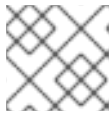

#### NOTE

Be sure to also review this site list if you are configuring a proxy.

### 21.2.3. Internet access for OpenShift Container Platform

In OpenShift Container Platform 4.10, you require access to the internet to install your cluster.

You must have internet access to:

- Access [OpenShift Cluster Manager](#) to download the installation program and perform subscription management. If the cluster has internet access and you do not disable Telemetry, that service automatically entitles your cluster.
- Access [Quay.io](#) to obtain the packages that are required to install your cluster.
- Obtain the packages that are required to perform cluster updates.

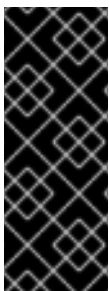

#### IMPORTANT

If your cluster cannot have direct internet access, you can perform a restricted network installation on some types of infrastructure that you provision. During that process, you download the required content and use it to populate a mirror registry with the installation packages. With some installation types, the environment that you install your cluster in will not require internet access. Before you update the cluster, you update the content of the mirror registry.

### 21.2.4. VMware vSphere infrastructure requirements

You must install the OpenShift Container Platform cluster on a VMware vSphere version 7 instance that meets the requirements for the components that you use.

**NOTE**

OpenShift Container Platform version 4.10 does not support VMware vSphere version 8.0.

You can host the VMware vSphere infrastructure on-premise or on a [VMware Cloud Verified provider](#) that meets the requirements outlined in the following table:

**Table 21.3. Version requirements for vSphere virtual environments**

Virtual environment product	Required version
VM hardware version	15 or later
vSphere ESXi hosts	7
vCenter host	7

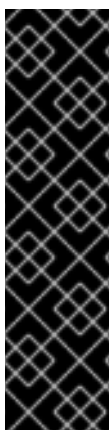
**IMPORTANT**

Installing a cluster on VMware vSphere version 7.0 Update 1 is now deprecated. These versions are still fully supported, but version 4.10 of OpenShift Container Platform requires vSphere virtual hardware version 15 or later. Hardware version 15 is now the default for vSphere virtual machines in OpenShift Container Platform. To update the hardware version for your vSphere nodes, see the "Updating hardware on nodes running in vSphere" article.

If your vSphere nodes are below hardware version 15 or your VMware vSphere version is earlier than 6.7U3, upgrading from OpenShift Container Platform 4.10 to OpenShift Container Platform 4.11 is not available.

**Table 21.4. Minimum supported vSphere version for VMware components**

Component	Minimum supported versions	Description
Hypervisor	vSphere 7 with HW version 15	This version is the minimum version that Red Hat Enterprise Linux CoreOS (RHCOS) supports. For more information about supported hardware on the latest version of Red Hat Enterprise Linux (RHEL) that is compatible with RHCOS, see <a href="#">Hardware</a> on the Red Hat Customer Portal.
Storage with in-tree drivers	vSphere 7	This plugin creates vSphere storage by using the in-tree storage drivers for vSphere included in OpenShift Container Platform.



If you use a vSphere version 6.5 instance, upgrade to 7.0 before you install OpenShift Container Platform.



### IMPORTANT

You must ensure that the time on your ESXi hosts is synchronized before you install OpenShift Container Platform. See [Edit Time Configuration for a Host](#) in the VMware documentation.

## 21.2.5. Network connectivity requirements

You must configure the network connectivity between machines to allow OpenShift Container Platform cluster components to communicate.

Review the following details about the required network ports.

**Table 21.5. Ports used for all-machine to all-machine communications**

Protocol	Port	Description
ICMP	N/A	Network reachability tests
TCP	<b>1936</b>	Metrics
	<b>9000-9999</b>	Host level services, including the node exporter on ports <b>9100-9101</b> and the Cluster Version Operator on port <b>9099</b> .
	<b>10250-10259</b>	The default ports that Kubernetes reserves
	<b>10256</b>	openshift-sdn
UDP	<b>4789</b>	virtual extensible LAN (VXLAN)
	<b>6081</b>	Geneve
	<b>9000-9999</b>	Host level services, including the node exporter on ports <b>9100-9101</b> .
	<b>500</b>	IPsec IKE packets
	<b>4500</b>	IPsec NAT-T packets
TCP/UDP	<b>30000-32767</b>	Kubernetes node port
ESP	N/A	IPsec Encapsulating Security Payload (ESP)

**Table 21.6. Ports used for all-machine to control plane communications**

Protocol	Port	Description
TCP	<b>6443</b>	Kubernetes API

Table 21.7. Ports used for control plane machine to control plane machine communications

Protocol	Port	Description
TCP	<b>2379-2380</b>	etcd server and peer ports

### 21.2.6. VMware vSphere CSI Driver Operator requirements

To install the vSphere CSI Driver Operator, the following requirements must be met:

- VMware vSphere version 6.7U3 or later
- Virtual machines of hardware version 15 or later
- No third-party vSphere CSI driver already installed in the cluster



#### IMPORTANT

If a third-party vSphere CSI driver is present in the cluster, OpenShift Container Platform does not overwrite it. If you continue with the third-party vSphere CSI driver when upgrading to the next major version of OpenShift Container Platform, the **oc** CLI prompts you with the following message:

```
VSphereCSIDriverOperatorCRUpgradeable: VMwareVSphereControllerUpgradeable:
found existing unsupported csi.vsphere.vmware.com driver
```

The previous message informs you that Red Hat does not support the third-party vSphere CSI driver during an OpenShift Container Platform upgrade operation. You can choose to ignore this message and continue with the upgrade operation.

#### Additional resources

- To remove a third-party CSI driver, see [Removing a third-party vSphere CSI Driver](#) .
- To update the hardware version for your vSphere nodes, see [Updating hardware on nodes running in vSphere](#).

### 21.2.7. vCenter requirements

Before you install an OpenShift Container Platform cluster on your vCenter that uses infrastructure that the installer provisions, you must prepare your environment.

#### Required vCenter account privileges

To install an OpenShift Container Platform cluster in a vCenter, the installation program requires access to an account with privileges to read and create the required resources. Using an account that has global administrative privileges is the simplest way to access all of the necessary permissions.

If you cannot use an account with global administrative privileges, you must create roles to grant the privileges necessary for OpenShift Container Platform cluster installation. While most of the privileges are always required, some are required only if you plan for the installation program to provision a folder to contain the OpenShift Container Platform cluster on your vCenter instance, which is the default behavior. You must create or amend vSphere roles for the specified objects to grant the required privileges.

An additional role is required if the installation program is to create a vSphere virtual machine folder.

### Example 21.1. Roles and privileges required for installation in vSphere API

vSphere object for role	When required	Required privileges in vSphere API
vSphere vCenter	Always	<b>Cns.Searchable</b> <b>InventoryService.Tagging.AttachTag</b> <b>InventoryService.Tagging.CreateCategory</b> <b>InventoryService.Tagging.CreateTag</b> <b>InventoryService.Tagging.DeleteCategory</b> <b>InventoryService.Tagging.DeleteTag</b> <b>InventoryService.Tagging.EditCategory</b> <b>InventoryService.Tagging.EditTag</b> <b>Sessions.ValidateSession</b> <b>StorageProfile.Update</b> <b>StorageProfile.View</b>
vSphere vCenter Cluster	If VMs will be created in the cluster root	<b>Host.Config.StorageResource.AssignVMToPool</b> <b>VApp.AssignResourcePool</b> <b>VApp.Import</b> <b>VirtualMachine.Config.AddNewDisk</b>
vSphere vCenter Resource Pool	If an existing resource pool is provided	<b>Host.Config.StorageResource.AssignVMToPool</b> <b>VApp.AssignResourcePool</b> <b>VApp.Import</b> <b>VirtualMachine.Config.AddNewDisk</b>
vSphere Datastore	Always	<b>Datastore.AllocateSpace</b> <b>Datastore.Browse</b> <b>Datastore.FileManagement</b> <b>InventoryService.Tagging.ObjectAttachable</b>

vSphere object for role	When required	Required privileges in vSphere API
vSphere Port Group	Always	<b>Network.Assign</b>
Virtual Machine Folder	Always	<b>InventoryService.Tagging.ObjectAttachable</b> <b>Resource.AssignVMToPool</b> <b>VApp.Import</b> <b>VirtualMachine.Config.AddExistingDisk</b> <b>VirtualMachine.Config.AddNewDisk</b> <b>VirtualMachine.Config.AddRemoveDevice</b> <b>VirtualMachine.Config.AdvancedConfig</b> <b>VirtualMachine.Config.Annotation</b> <b>VirtualMachine.Config.CPUCount</b> <b>VirtualMachine.Config.DiskExtend</b> <b>VirtualMachine.Config.DiskLease</b> <b>VirtualMachine.Config.EditDevice</b> <b>VirtualMachine.Config.Memory</b> <b>VirtualMachine.Config.RemoveDisk</b> <b>VirtualMachine.Config.Rename</b> <b>VirtualMachine.Config.ResetGuestInfo</b> <b>VirtualMachine.Config.Resource</b> <b>VirtualMachine.Config.Settings</b> <b>VirtualMachine.Config.UpgradeVirtualHardware</b> <b>VirtualMachine.Interact.GuestControl</b> <b>VirtualMachine.Interact.PowerOff</b> <b>VirtualMachine.Interact.PowerOn</b> <b>VirtualMachine.Interact.Reset</b> <b>VirtualMachine.Inventory.Create</b> <b>VirtualMachine.Inventory.CreateFromExisting</b> <b>VirtualMachine.Inventory.Delete</b>

vSphere object for role	When required	VirtualMachine.Provisioning API Required privileges in vSphere VirtualMachine.Provisioning
		<b>VirtualMachine.Provisioning.MarkAsTemplate</b> <b>VirtualMachine.Provisioning.DeployTemplate</b>
vSphere vCenter Datacenter	If the installation program creates the virtual machine folder	<b>InventoryService.Tagging.ObjectAttachable</b> <b>Resource.AssignVMToPool</b> <b>VApp.Import</b> <b>VirtualMachine.Config.AddExistingDisk</b> <b>VirtualMachine.Config.AddNewDisk</b> <b>VirtualMachine.Config.AddRemoveDevice</b> <b>VirtualMachine.Config.AdvancedConfig</b> <b>VirtualMachine.Config.Annotation</b> <b>VirtualMachine.Config.CPUCount</b> <b>VirtualMachine.Config.DiskExtend</b> <b>VirtualMachine.Config.DiskLease</b> <b>VirtualMachine.Config.EditDevice</b> <b>VirtualMachine.Config.Memory</b> <b>VirtualMachine.Config.RemoveDisk</b> <b>VirtualMachine.Config.Rename</b> <b>VirtualMachine.Config.ResetGuestInfo</b> <b>VirtualMachine.Config.Resource</b> <b>VirtualMachine.Config.Settings</b> <b>VirtualMachine.Config.UpgradeVirtualHardware</b> <b>VirtualMachine.Interact.GuestControl</b> <b>VirtualMachine.Interact.PowerOff</b> <b>VirtualMachine.Interact.PowerOn</b> <b>VirtualMachine.Interact.Reset</b> <b>VirtualMachine.Inventory.Create</b> <b>VirtualMachine.Inventory.Cr</b>

vSphere object for role	When required	Required privileges in vSphere API
		<b>createFromExisting</b> <b>VirtualMachine.Inventory.Delete</b> <b>VirtualMachine.Provisioning.Clone</b> <b>VirtualMachine.Provisioning.DeployTemplate</b> <b>VirtualMachine.Provisioning.MarkAsTemplate</b> <b>Folder.Create</b> <b>Folder.Delete</b>

Example 21.2. Roles and privileges required for installation in vCenter graphical user interface (GUI)

vSphere object for role	When required	Required privileges in vCenter GUI
vSphere vCenter	Always	<b>Cns.Searchable</b> <b>"vSphere Tagging"."Assign or Unassign vSphere Tag"</b> <b>"vSphere Tagging"."Create vSphere Tag Category"</b> <b>"vSphere Tagging"."Create vSphere Tag"</b> <b>vSphere Tagging"."Delete vSphere Tag Category"</b> <b>"vSphere Tagging"."Delete vSphere Tag"</b> <b>"vSphere Tagging"."Edit vSphere Tag Category"</b> <b>"vSphere Tagging"."Edit vSphere Tag"</b> <b>Sessions."Validate session"</b> <b>"Profile-driven storage"."Profile-driven storage update"</b> <b>"Profile-driven storage"."Profile-driven storage view"</b>

vSphere object for role	When required	Required privileges in vCenter GUI
vSphere vCenter Cluster	If VMs will be created in the cluster root	<b>Host.Configuration."Storage partition configuration"</b> <b>Resource."Assign virtual machine to resource pool"</b> <b>VApp."Assign resource pool"</b> <b>VApp.Import</b> <b>"Virtual machine"."Change Configuration"."Add new disk"</b>
vSphere vCenter Resource Pool	If an existing resource pool is provided	<b>Host.Configuration."Storage partition configuration"</b> <b>Resource."Assign virtual machine to resource pool"</b> <b>VApp."Assign resource pool"</b> <b>VApp.Import</b> <b>"Virtual machine"."Change Configuration"."Add new disk"</b>
vSphere Datastore	Always	<b>Datastore."Allocate space"</b> <b>Datastore."Browse datastore"</b> <b>Datastore."Low level file operations"</b> <b>"vSphere Tagging"."Assign or Unassign vSphere Tag on Object"</b>
vSphere Port Group	Always	<b>Network."Assign network"</b>
Virtual Machine Folder	Always	<b>"vSphere Tagging"."Assign or Unassign vSphere Tag on Object"</b> <b>Resource."Assign virtual machine to resource pool"</b> <b>VApp.Import</b> <b>"Virtual machine"."Change Configuration"."Add existing disk"</b> <b>"Virtual machine"."Change Configuration"."Add new disk"</b> <b>"Virtual machine"."Change Configuration"."Add or remove device"</b> <b>"Virtual machine"."Change Configuration"."Advanced configuration"</b>

vSphere object for role	When required	"Virtual machine"."Change Configuration".Set annotation Required privileges in vCenter GUI
		"Virtual machine"."Change Configuration"."Change CPU count" "Virtual machine"."Change Configuration"."Extend virtual disk" "Virtual machine"."Change Configuration"."Acquire disk lease" "Virtual machine"."Change Configuration"."Modify device settings" "Virtual machine"."Change Configuration"."Change Memory" "Virtual machine"."Change Configuration"."Remove disk" "Virtual machine"."Change Configuration".Rename "Virtual machine"."Change Configuration"."Reset guest information" "Virtual machine"."Change Configuration"."Change resource" "Virtual machine"."Change Configuration"."Change Settings" "Virtual machine"."Change Configuration"."Upgrade virtual machine compatibility" "Virtual machine".Interaction."Guest operating system management by VIX API" "Virtual machine".Interaction."Power off" "Virtual machine".Interaction."Power on" "Virtual machine".Interaction.Reset "Virtual machine"."Edit Inventory"."Create new" "Virtual machine"."Edit Inventory"."Create from existing" "Virtual machine"."Edit Inventory"."Remove" "Virtual



vSphere object for role	When required	Required privileges in vCenter GUI
		<b>machine".Provisioning."Clo</b> <b>Required privileges in vCenter</b> <b>GUI</b> <b>Virtual</b> <b>machine".Provisioning."Mar</b> <b>k as template"</b> <b>"Virtual</b> <b>machine".Provisioning."De</b> <b>ploy template"</b>
vSphere vCenter Datacenter	If the installation program creates the virtual machine folder	<b>"vSphere Tagging". "Assign</b> <b>or Unassign vSphere Tag</b> <b>on Object"</b> <b>Resource."Assign virtual</b> <b>machine to resource pool"</b> <b>VApp.Import</b> <b>"Virtual machine". "Change</b> <b>Configuration". "Add</b> <b>existing disk"</b> <b>"Virtual machine". "Change</b> <b>Configuration". "Add new</b> <b>disk"</b> <b>"Virtual machine". "Change</b> <b>Configuration". "Add or</b> <b>remove device"</b> <b>"Virtual machine". "Change</b> <b>Configuration". "Advanced</b> <b>configuration"</b> <b>"Virtual machine". "Change</b> <b>Configuration". "Set</b> <b>annotation"</b> <b>"Virtual machine". "Change</b> <b>Configuration". "Change</b> <b>CPU count"</b> <b>"Virtual machine". "Change</b> <b>Configuration". "Extend</b> <b>virtual disk"</b> <b>"Virtual machine". "Change</b> <b>Configuration". "Acquire</b> <b>disk lease"</b> <b>"Virtual machine". "Change</b> <b>Configuration". "Modify</b> <b>device settings"</b> <b>"Virtual machine". "Change</b> <b>Configuration". "Change</b> <b>Memory"</b> <b>"Virtual machine". "Change</b> <b>Configuration". "Remove</b> <b>disk"</b> <b>"Virtual machine". "Change</b> <b>Configuration". Rename</b> <b>"Virtual machine". "Change</b> <b>Configuration". "Reset guest</b> <b>information"</b> <b>"Virtual machine". "Change</b> <b>Configuration". "Change</b> <b>resource"</b>

vSphere object for role	When required	"Virtual machine"."Change Configuration"."Change Settings"
		"Virtual machine"."Change Configuration"."Upgrade virtual machine compatibility" "Virtual machine".Interaction."Guest operating system management by VIX API" "Virtual machine".Interaction."Power off" "Virtual machine".Interaction."Power on" "Virtual machine".Interaction.Reset "Virtual machine"."Edit Inventory"."Create new" "Virtual machine"."Edit Inventory"."Create from existing" "Virtual machine"."Edit Inventory"."Remove" "Virtual machine".Provisioning."Clone virtual machine" "Virtual machine".Provisioning."Deploy template" "Virtual machine".Provisioning."Mark as template" Folder."Create folder" Folder."Delete folder"

Additionally, the user requires some **ReadOnly** permissions, and some of the roles require permission to propagate the permissions to child objects. These settings vary depending on whether or not you install the cluster into an existing folder.

**Example 21.3. Required permissions and propagation settings**

vSphere object	When required	Propagate to children	Permissions required
vSphere vCenter	Always	False	Listed required privileges
vSphere vCenter Datacenter	Existing folder	False	<b>ReadOnly</b> permission

vSphere object	When required	Propagate to children	Permissions required
	Installation program creates the folder	True	Listed required privileges
vSphere vCenter Cluster	Existing resource pool	False	<b>ReadOnly</b> permission
	VMs in cluster root	True	Listed required privileges
vSphere vCenter Datastore	Always	False	Listed required privileges
vSphere Switch	Always	False	<b>ReadOnly</b> permission
vSphere Port Group	Always	False	Listed required privileges
vSphere vCenter Virtual Machine Folder	Existing folder	True	Listed required privileges
vSphere vCenter Resource Pool	Existing resource pool	True	Listed required privileges

For more information about creating an account with only the required privileges, see [vSphere Permissions and User Management Tasks](#) in the vSphere documentation.

### Using OpenShift Container Platform with vMotion

If you intend on using vMotion in your vSphere environment, consider the following before installing a OpenShift Container Platform cluster.

- OpenShift Container Platform generally supports compute-only vMotion. Using Storage vMotion can cause issues and is not supported.  
To help ensure the uptime of your compute and control plane nodes, it is recommended that you follow the VMware best practices for vMotion. It is also recommended to use VMware anti-affinity rules to improve the availability of OpenShift Container Platform during maintenance or hardware issues.

For more information about vMotion and anti-affinity rules, see the VMware vSphere documentation for [vMotion networking requirements](#) and [VM anti-affinity rules](#).

- If you are using vSphere volumes in your pods, migrating a VM across datastores either manually or through Storage vMotion causes, invalid references within OpenShift Container Platform persistent volume (PV) objects. These references prevent affected pods from starting up and can result in data loss.
- Similarly, OpenShift Container Platform does not support selective migration of VMDKs across datastores, using datastore clusters for VM provisioning or for dynamic or static provisioning of PVs, or using a datastore that is part of a datastore cluster for dynamic or static provisioning of PVs.

### Cluster resources

When you deploy an OpenShift Container Platform cluster that uses installer-provisioned infrastructure, the installation program must be able to create several resources in your vCenter instance.

A standard OpenShift Container Platform installation creates the following vCenter resources:

- 1 Folder
- 1 Tag category
- 1 Tag
- Virtual machines:
  - 1 template
  - 1 temporary bootstrap node
  - 3 control plane nodes
  - 3 compute machines

Although these resources use 856 GB of storage, the bootstrap node is destroyed during the cluster installation process. A minimum of 800 GB of storage is required to use a standard cluster.

If you deploy more compute machines, the OpenShift Container Platform cluster will use more storage.

### Cluster limits

Available resources vary between clusters. The number of possible clusters within a vCenter is limited primarily by available storage space and any limitations on the number of required resources. Be sure to consider both limitations to the vCenter resources that the cluster creates and the resources that you require to deploy a cluster, such as IP addresses and networks.

### Networking requirements

You must use the Dynamic Host Configuration Protocol (DHCP) for the network and ensure that the DHCP server is configured to provide persistent IP addresses to the cluster machines. In the DHCP lease, you must configure the DHCP to use the default gateway. All nodes must be in the same VLAN. You cannot scale the cluster using a second VLAN as a Day 2 operation. Additionally, you must create the following networking resources before you install the OpenShift Container Platform cluster:



#### NOTE

It is recommended that each OpenShift Container Platform node in the cluster must have access to a Network Time Protocol (NTP) server that is discoverable via DHCP. Installation is possible without an NTP server. However, asynchronous server clocks will cause errors, which NTP server prevents.

### Required IP Addresses

An installer-provisioned vSphere installation requires two static IP addresses:

- The **API** address is used to access the cluster API.
- The **Ingress** address is used for cluster ingress traffic.

You must provide these IP addresses to the installation program when you install the OpenShift Container Platform cluster.

## DNS records

You must create DNS records for two static IP addresses in the appropriate DNS server for the vCenter instance that hosts your OpenShift Container Platform cluster. In each record, **<cluster\_name>** is the cluster name and **<base\_domain>** is the cluster base domain that you specify when you install the cluster. A complete DNS record takes the form: **<component>.<cluster\_name>.<base\_domain>..**

**Table 21.8. Required DNS records**

Component	Record	Description
API VIP	<b>api.&lt;cluster_name&gt;.&lt;base_domain&gt;.</b>	This DNS A/AAAA or CNAME record must point to the load balancer for the control plane machines. This record must be resolvable by both clients external to the cluster and from all the nodes within the cluster.
Ingress VIP	<b>*.apps.&lt;cluster_name&gt;.&lt;base_domain&gt;.</b>	A wildcard DNS A/AAAA or CNAME record that points to the load balancer that targets the machines that run the Ingress router pods, which are the worker nodes by default. This record must be resolvable by both clients external to the cluster and from all the nodes within the cluster.

### 21.2.8. Generating a key pair for cluster node SSH access

During an OpenShift Container Platform installation, you can provide an SSH public key to the installation program. The key is passed to the Red Hat Enterprise Linux CoreOS (RHCOS) nodes through their Ignition config files and is used to authenticate SSH access to the nodes. The key is added to the **~/.ssh/authorized\_keys** list for the **core** user on each node, which enables password-less authentication.

After the key is passed to the nodes, you can use the key pair to SSH in to the RHCOS nodes as the user **core**. To access the nodes through SSH, the private key identity must be managed by SSH for your local user.

If you want to SSH in to your cluster nodes to perform installation debugging or disaster recovery, you must provide the SSH public key during the installation process. The **./openshift-install gather** command also requires the SSH public key to be in place on the cluster nodes.

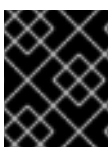

#### IMPORTANT

Do not skip this procedure in production environments, where disaster recovery and debugging is required.

**NOTE**

You must use a local key, not one that you configured with platform-specific approaches such as [AWS key pairs](#).

**Procedure**

1. If you do not have an existing SSH key pair on your local machine to use for authentication onto your cluster nodes, create one. For example, on a computer that uses a Linux operating system, run the following command:

```
$ ssh-keygen -t ed25519 -N "" -f <path>/<file_name> 1
```

- 1 Specify the path and file name, such as `~/.ssh/id_ed25519`, of the new SSH key. If you have an existing key pair, ensure your public key is in the your `~/.ssh` directory.

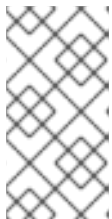
**NOTE**

If you plan to install an OpenShift Container Platform cluster that uses FIPS validated or Modules In Process cryptographic libraries on the **x86\_64** architecture, do not create a key that uses the **ed25519** algorithm. Instead, create a key that uses the **rsa** or **ecdsa** algorithm.

2. View the public SSH key:

```
$ cat <path>/<file_name>.pub
```

For example, run the following to view the `~/.ssh/id_ed25519.pub` public key:

```
$ cat ~/.ssh/id_ed25519.pub
```

3. Add the SSH private key identity to the SSH agent for your local user, if it has not already been added. SSH agent management of the key is required for password-less SSH authentication onto your cluster nodes, or if you want to use the `./openshift-install gather` command.

**NOTE**

On some distributions, default SSH private key identities such as `~/.ssh/id_rsa` and `~/.ssh/id_dsa` are managed automatically.

- a. If the **ssh-agent** process is not already running for your local user, start it as a background task:

```
$ eval "$(ssh-agent -s)"
```

**Example output**

```
Agent pid 31874
```

**NOTE**

If your cluster is in FIPS mode, only use FIPS-compliant algorithms to generate the SSH key. The key must be either RSA or ECDSA.

4. Add your SSH private key to the **ssh-agent**:

```
$ ssh-add <path>/<file_name> 1
```

- 1** Specify the path and file name for your SSH private key, such as `~/.ssh/id_ed25519`

**Example output**

```
Identity added: /home/<you>/<path>/<file_name> (<computer_name>)
```

**Next steps**

- When you install OpenShift Container Platform, provide the SSH public key to the installation program.

**21.2.9. Obtaining the installation program**

Before you install OpenShift Container Platform, download the installation file on a local computer.

**Prerequisites**

- You have a computer that runs Linux or macOS, with 500 MB of local disk space

**Procedure**

1. Access the [Infrastructure Provider](#) page on the OpenShift Cluster Manager site. If you have a Red Hat account, log in with your credentials. If you do not, create an account.
2. Select your infrastructure provider.
3. Navigate to the page for your installation type, download the installation program that corresponds with your host operating system and architecture, and place the file in the directory where you will store the installation configuration files.

**IMPORTANT**

The installation program creates several files on the computer that you use to install your cluster. You must keep the installation program and the files that the installation program creates after you finish installing the cluster. Both files are required to delete the cluster.

**IMPORTANT**

Deleting the files created by the installation program does not remove your cluster, even if the cluster failed during installation. To remove your cluster, complete the OpenShift Container Platform uninstallation procedures for your specific cloud provider.

4. Extract the installation program. For example, on a computer that uses a Linux operating system, run the following command:

```
$ tar -xvf openshift-install-linux.tar.gz
```

5. Download your installation [pull secret from the Red Hat OpenShift Cluster Manager](#) . This pull secret allows you to authenticate with the services that are provided by the included authorities, including Quay.io, which serves the container images for OpenShift Container Platform components.

## 21.2.10. Adding vCenter root CA certificates to your system trust

Because the installation program requires access to your vCenter's API, you must add your vCenter's trusted root CA certificates to your system trust before you install an OpenShift Container Platform cluster.

### Procedure

1. From the vCenter home page, download the vCenter's root CA certificates. Click **Download trusted root CA certificates** in the vSphere Web Services SDK section. The **<vCenter>/certs/download.zip** file downloads.
2. Extract the compressed file that contains the vCenter root CA certificates. The contents of the compressed file resemble the following file structure:

```
certs
├── lin
│   ├── 108f4d17.0
│   ├── 108f4d17.r1
│   ├── 7e757f6a.0
│   ├── 8e4f8471.0
│   └── 8e4f8471.r0
├── mac
│   ├── 108f4d17.0
│   ├── 108f4d17.r1
│   ├── 7e757f6a.0
│   ├── 8e4f8471.0
│   └── 8e4f8471.r0
└── win
    ├── 108f4d17.0.crt
    ├── 108f4d17.r1.crl
    ├── 7e757f6a.0.crt
    ├── 8e4f8471.0.crt
    └── 8e4f8471.r0.crl
```

3 directories, 15 files

3. Add the files for your operating system to the system trust. For example, on a Fedora operating system, run the following command:

```
# cp certs/lin/* /etc/pki/ca-trust/source/anchors
```

4. Update your system trust. For example, on a Fedora operating system, run the following command:

-



```
# update-ca-trust extract
```

## 21.2.11. Deploying the cluster

You can install OpenShift Container Platform on a compatible cloud platform.



### IMPORTANT

You can run the **create cluster** command of the installation program only once, during initial installation.

### Prerequisites

- Configure an account with the cloud platform that hosts your cluster.
- Obtain the OpenShift Container Platform installation program and the pull secret for your cluster.

### Procedure

1. Change to the directory that contains the installation program and initialize the cluster deployment:

```
$ ./openshift-install create cluster --dir <installation_directory> \ 1
--log-level=info 2
```

- 1 For **<installation\_directory>**, specify the directory name to store the files that the installation program creates.
- 2 To view different installation details, specify **warn**, **debug**, or **error** instead of **info**.



### IMPORTANT

Specify an empty directory. Some installation assets, like bootstrap X.509 certificates have short expiration intervals, so you must not reuse an installation directory. If you want to reuse individual files from another cluster installation, you can copy them into your directory. However, the file names for the installation assets might change between releases. Use caution when copying installation files from an earlier OpenShift Container Platform version.

Provide values at the prompts:

- a. Optional: Select an SSH key to use to access your cluster machines.

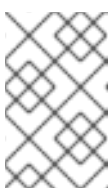

### NOTE

For production OpenShift Container Platform clusters on which you want to perform installation debugging or disaster recovery, specify an SSH key that your **ssh-agent** process uses.

- b. Select **vsphere** as the platform to target.

- c. Specify the name of your vCenter instance.
- d. Specify the user name and password for the vCenter account that has the required permissions to create the cluster.  
The installation program connects to your vCenter instance.
- e. Select the datacenter in your vCenter instance to connect to.
- f. Select the default vCenter datastore to use.

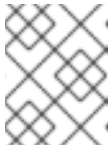
**NOTE**

Datastore and cluster names cannot exceed 60 characters; therefore, ensure the combined string length does not exceed the 60 character limit.

- g. Select the vCenter cluster to install the OpenShift Container Platform cluster in. The installation program uses the root resource pool of the vSphere cluster as the default resource pool.
- h. Select the network in the vCenter instance that contains the virtual IP addresses and DNS records that you configured.
  - i. Enter the virtual IP address that you configured for control plane API access.
  - j. Enter the virtual IP address that you configured for cluster ingress.
  - k. Enter the base domain. This base domain must be the same one that you used in the DNS records that you configured.
  - l. Enter a descriptive name for your cluster. The cluster name must be the same one that you used in the DNS records that you configured.

**NOTE**

Datastore and cluster names cannot exceed 60 characters; therefore, ensure the combined string length does not exceed the 60 character limit.

- m. Paste the [pull secret from the Red Hat OpenShift Cluster Manager](#) .

**IMPORTANT**

Use the **openshift-install** command from the bastion hosted in the VMC environment.

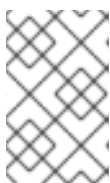
**NOTE**

If the cloud provider account that you configured on your host does not have sufficient permissions to deploy the cluster, the installation process stops, and the missing permissions are displayed.

When the cluster deployment completes, directions for accessing your cluster, including a link to its web console and credentials for the **kubeadmin** user, display in your terminal.

**Example output**

```

...
INFO Install complete!
INFO To access the cluster as the system:admin user when using 'oc', run 'export
KUBECONFIG=/home/myuser/install_dir/auth/kubeconfig'
INFO Access the OpenShift web-console here: https://console-openshift-
console.apps.mycluster.example.com
INFO Login to the console with user: "kubeadmin", and password: "4vYBz-Ee6gm-ymBZj-
Wt5AL"
INFO Time elapsed: 36m22s

```



## NOTE

The cluster access and credential information also outputs to **<installation\_directory>/openshift\_install.log** when an installation succeeds.

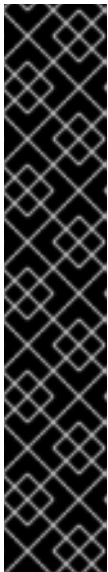

## IMPORTANT

- The Ignition config files that the installation program generates contain certificates that expire after 24 hours, which are then renewed at that time. If the cluster is shut down before renewing the certificates and the cluster is later restarted after the 24 hours have elapsed, the cluster automatically recovers the expired certificates. The exception is that you must manually approve the pending **node-bootstrapper** certificate signing requests (CSRs) to recover kubelet certificates. See the documentation for *Recovering from expired control plane certificates* for more information.
- It is recommended that you use Ignition config files within 12 hours after they are generated because the 24-hour certificate rotates from 16 to 22 hours after the cluster is installed. By using the Ignition config files within 12 hours, you can avoid installation failure if the certificate update runs during installation.



## IMPORTANT

You must not delete the installation program or the files that the installation program creates. Both are required to delete the cluster.

### 21.2.12. Installing the OpenShift CLI by downloading the binary

You can install the OpenShift CLI (**oc**) to interact with OpenShift Container Platform from a command-line interface. You can install **oc** on Linux, Windows, or macOS.

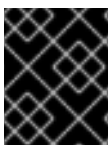

## IMPORTANT

If you installed an earlier version of **oc**, you cannot use it to complete all of the commands in OpenShift Container Platform 4.10. Download and install the new version of **oc**.

#### Installing the OpenShift CLI on Linux

You can install the OpenShift CLI (**oc**) binary on Linux by using the following procedure.

#### Procedure

1. Navigate to the [OpenShift Container Platform downloads page](#) on the Red Hat Customer Portal.
2. Select the appropriate version in the **Version** drop-down menu.
3. Click **Download Now** next to the **OpenShift v4.10 Linux Client** entry and save the file.
4. Unpack the archive:

```
$ tar xvf <file>
```

5. Place the **oc** binary in a directory that is on your **PATH**.  
To check your **PATH**, execute the following command:

```
$ echo $PATH
```

After you install the OpenShift CLI, it is available using the **oc** command:

```
$ oc <command>
```

### Installing the OpenShift CLI on Windows

You can install the OpenShift CLI (**oc**) binary on Windows by using the following procedure.

#### Procedure

1. Navigate to the [OpenShift Container Platform downloads page](#) on the Red Hat Customer Portal.
2. Select the appropriate version in the **Version** drop-down menu.
3. Click **Download Now** next to the **OpenShift v4.10 Windows Client** entry and save the file.
4. Unzip the archive with a ZIP program.
5. Move the **oc** binary to a directory that is on your **PATH**.  
To check your **PATH**, open the command prompt and execute the following command:

```
C:\> path
```

After you install the OpenShift CLI, it is available using the **oc** command:

```
C:\> oc <command>
```

### Installing the OpenShift CLI on macOS

You can install the OpenShift CLI (**oc**) binary on macOS by using the following procedure.

#### Procedure

1. Navigate to the [OpenShift Container Platform downloads page](#) on the Red Hat Customer Portal.
2. Select the appropriate version in the **Version** drop-down menu.
3. Click **Download Now** next to the **OpenShift v4.10 MacOSX Client** entry and save the file.

4. Unpack and unzip the archive.
5. Move the **oc** binary to a directory on your PATH.  
To check your **PATH**, open a terminal and execute the following command:

```
$ echo $PATH
```

After you install the OpenShift CLI, it is available using the **oc** command:

```
$ oc <command>
```

### 21.2.13. Logging in to the cluster by using the CLI

You can log in to your cluster as a default system user by exporting the cluster **kubeconfig** file. The **kubeconfig** file contains information about the cluster that is used by the CLI to connect a client to the correct cluster and API server. The file is specific to a cluster and is created during OpenShift Container Platform installation.

#### Prerequisites

- You deployed an OpenShift Container Platform cluster.
- You installed the **oc** CLI.

#### Procedure

1. Export the **kubeadmin** credentials:

```
$ export KUBECONFIG=<installation_directory>/auth/kubeconfig 1
```

- 1** For **<installation\_directory>**, specify the path to the directory that you stored the installation files in.

2. Verify you can run **oc** commands successfully using the exported configuration:

```
$ oc whoami
```

#### Example output

```
system:admin
```

### 21.2.14. Creating registry storage

After you install the cluster, you must create storage for the registry Operator.

#### 21.2.14.1. Image registry removed during installation

On platforms that do not provide shareable object storage, the OpenShift Image Registry Operator bootstraps itself as **Removed**. This allows **openshift-installer** to complete installations on these platform types.

After installation, you must edit the Image Registry Operator configuration to switch the **managementState** from **Removed** to **Managed**.

### 21.2.14.2. Image registry storage configuration

The Image Registry Operator is not initially available for platforms that do not provide default storage. After installation, you must configure your registry to use storage so that the Registry Operator is made available.

Instructions are shown for configuring a persistent volume, which is required for production clusters. Where applicable, instructions are shown for configuring an empty directory as the storage location, which is available for only non-production clusters.

Additional instructions are provided for allowing the image registry to use block storage types by using the **Recreate** rollout strategy during upgrades.

#### 21.2.14.2.1. Configuring registry storage for VMware vSphere

As a cluster administrator, following installation you must configure your registry to use storage.

#### Prerequisites

- Cluster administrator permissions.
- A cluster on VMware vSphere.
- Persistent storage provisioned for your cluster, such as Red Hat OpenShift Data Foundation.



#### IMPORTANT

OpenShift Container Platform supports **ReadWriteOnce** access for image registry storage when you have only one replica. **ReadWriteOnce** access also requires that the registry uses the **Recreate** rollout strategy. To deploy an image registry that supports high availability with two or more replicas, **ReadWriteMany** access is required.

- Must have "100Gi" capacity.



#### IMPORTANT

Testing shows issues with using the NFS server on RHEL as storage backend for core services. This includes the OpenShift Container Registry and Quay, Prometheus for monitoring storage, and Elasticsearch for logging storage. Therefore, using RHEL NFS to back PVs used by core services is not recommended.

Other NFS implementations on the marketplace might not have these issues. Contact the individual NFS implementation vendor for more information on any testing that was possibly completed against these OpenShift Container Platform core components.

#### Procedure

1. To configure your registry to use storage, change the **spec.storage.pvc** in the **configs.imageregistry/cluster** resource.

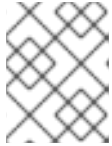
**NOTE**

When using shared storage, review your security settings to prevent outside access.

- Verify that you do not have a registry pod:

```
$ oc get pod -n openshift-image-registry -l docker-registry=default
```

**Example output**

```
No resources found in openshift-image-registry namespace
```

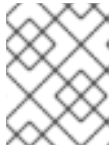
**NOTE**

If you do have a registry pod in your output, you do not need to continue with this procedure.

- Check the registry configuration:

```
$ oc edit configs.imageregistry.operator.openshift.io
```

**Example output**

```
storage:
  pvc:
    claim: 1
```

- Leave the **claim** field blank to allow the automatic creation of an **image-registry-storage** persistent volume claim (PVC). The PVC is generated based on the default storage class. However, be aware that the default storage class might provide ReadWriteOnce (RWO) volumes, such as a RADOS Block Device (RBD), which can cause issues when replicating to more than one replica.

- Check the **clusteroperator** status:

```
$ oc get clusteroperator image-registry
```

**Example output**

NAME	VERSION	AVAILABLE	PROGRESSING	DEGRADED
image-registry	4.7	True	False	6h50m

#### 21.2.14.2.2. Configuring block registry storage for VMware vSphere

To allow the image registry to use block storage types such as vSphere Virtual Machine Disk (VMDK) during upgrades as a cluster administrator, you can use the **Recreate** rollout strategy.



## IMPORTANT

Block storage volumes are supported but not recommended for use with image registry on production clusters. An installation where the registry is configured on block storage is not highly available because the registry cannot have more than one replica.

### Procedure

1. To set the image registry storage as a block storage type, patch the registry so that it uses the **Recreate** rollout strategy and runs with only **1** replica:

```
$ oc patch config.imageregistry.operator.openshift.io/cluster --type=merge -p '{"spec": {"rolloutStrategy": "Recreate", "replicas": 1}}'
```

2. Provision the PV for the block storage device, and create a PVC for that volume. The requested block volume uses the ReadWriteOnce (RWO) access mode.
  - a. Create a **pvc.yaml** file with the following contents to define a VMware vSphere **PersistentVolumeClaim** object:

```
kind: PersistentVolumeClaim
apiVersion: v1
metadata:
  name: image-registry-storage 1
  namespace: openshift-image-registry 2
spec:
  accessModes:
    - ReadWriteOnce 3
  resources:
    requests:
      storage: 100Gi 4
```

- 1 A unique name that represents the **PersistentVolumeClaim** object.
- 2 The namespace for the **PersistentVolumeClaim** object, which is **openshift-image-registry**.
- 3 The access mode of the persistent volume claim. With **ReadWriteOnce**, the volume can be mounted with read and write permissions by a single node.
- 4 The size of the persistent volume claim.

- b. Create the **PersistentVolumeClaim** object from the file:

```
$ oc create -f pvc.yaml -n openshift-image-registry
```

3. Edit the registry configuration so that it references the correct PVC:

```
$ oc edit config.imageregistry.operator.openshift.io -o yaml
```

### Example output



```
storage:
pvc:
  claim: 1
```

- 1 Creating a custom PVC allows you to leave the **claim** field blank for the default automatic creation of an **image-registry-storage** PVC.

For instructions about configuring registry storage so that it references the correct PVC, see [Configuring the registry for vSphere](#).

### 21.2.15. Backing up VMware vSphere volumes

OpenShift Container Platform provisions new volumes as independent persistent disks to freely attach and detach the volume on any node in the cluster. As a consequence, it is not possible to back up volumes that use snapshots, or to restore volumes from snapshots. See [Snapshot Limitations](#) for more information.

#### Procedure

To create a backup of persistent volumes:

1. Stop the application that is using the persistent volume.
2. Clone the persistent volume.
3. Restart the application.
4. Create a backup of the cloned volume.
5. Delete the cloned volume.

### 21.2.16. Telemetry access for OpenShift Container Platform

In OpenShift Container Platform 4.10, the Telemetry service, which runs by default to provide metrics about cluster health and the success of updates, requires internet access. If your cluster is connected to the internet, Telemetry runs automatically, and your cluster is registered to [OpenShift Cluster Manager](#).

After you confirm that your [OpenShift Cluster Manager](#) inventory is correct, either maintained automatically by Telemetry or manually by using OpenShift Cluster Manager, [use subscription watch](#) to track your OpenShift Container Platform subscriptions at the account or multi-cluster level.

#### Additional resources

- See [About remote health monitoring](#) for more information about the Telemetry service

### 21.2.17. Next steps

- [Customize your cluster](#).
- If necessary, you can [opt out of remote health reporting](#).
- [Set up your registry and configure registry storage](#).

- Optional: [View the events from the vSphere Problem Detector Operator](#) to determine if the cluster has permission or storage configuration issues.

## 21.3. INSTALLING A CLUSTER ON VMC WITH CUSTOMIZATIONS

In OpenShift Container Platform version 4.10, you can install a cluster on your VMware vSphere instance using installer-provisioned infrastructure by deploying it to [VMware Cloud \(VMC\) on AWS](#).

Once you configure your VMC environment for OpenShift Container Platform deployment, you use the OpenShift Container Platform installation program from the bastion management host, co-located in the VMC environment. The installation program and control plane automates the process of deploying and managing the resources needed for the OpenShift Container Platform cluster.

To customize the OpenShift Container Platform installation, you modify parameters in the **install-config.yaml** file before you install the cluster.



### NOTE

OpenShift Container Platform supports deploying a cluster to a single VMware vCenter only. Deploying a cluster with machines/machine sets on multiple vCenters is not supported.

### 21.3.1. Setting up VMC for vSphere

You can install OpenShift Container Platform on VMware Cloud (VMC) on AWS hosted vSphere clusters to enable applications to be deployed and managed both on-premise and off-premise, across the hybrid cloud.

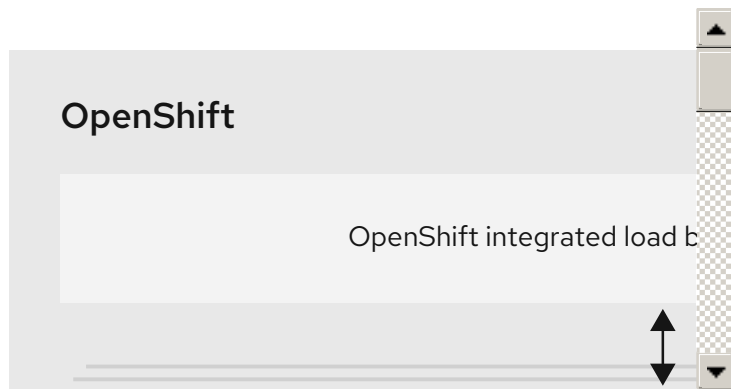

You must configure several options in your VMC environment prior to installing OpenShift Container Platform on VMware vSphere. Ensure your VMC environment has the following prerequisites:

- Create a non-exclusive, DHCP-enabled, NSX-T network segment and subnet. Other virtual machines (VMs) can be hosted on the subnet, but at least eight IP addresses must be available for the OpenShift Container Platform deployment.
- Allocate two IP addresses, outside the DHCP range, and configure them with reverse DNS records.
  - A DNS record for **api.<cluster\_name>.<base\_domain>** pointing to the allocated IP address.
  - A DNS record for **\*.apps.<cluster\_name>.<base\_domain>** pointing to the allocated IP address.

- Configure the following firewall rules:
  - An ANY:ANY firewall rule between the OpenShift Container Platform compute network and the internet. This is used by nodes and applications to download container images.
  - An ANY:ANY firewall rule between the installation host and the software-defined data center (SDDC) management network on port 443. This allows you to upload the Red Hat Enterprise Linux CoreOS (RHCOS) OVA during deployment.
  - An HTTPS firewall rule between the OpenShift Container Platform compute network and vCenter. This connection allows OpenShift Container Platform to communicate with vCenter for provisioning and managing nodes, persistent volume claims (PVCs), and other resources.
- You must have the following information to deploy OpenShift Container Platform:
  - The OpenShift Container Platform cluster name, such as **vmc-prod-1**.
  - The base DNS name, such as **companyname.com**.
  - If not using the default, the pod network CIDR and services network CIDR must be identified, which are set by default to **10.128.0.0/14** and **172.30.0.0/16**, respectively. These CIDRs are used for pod-to-pod and pod-to-service communication and are not accessible externally; however, they must not overlap with existing subnets in your organization.
  - The following vCenter information:
    - vCenter hostname, username, and password
    - Datacenter name, such as **SDDC-Datacenter**
    - Cluster name, such as **Cluster-1**
    - Network name
    - Datastore name, such as **WorkloadDatastore**



#### NOTE

It is recommended to move your vSphere cluster to the VMC **Compute-ResourcePool** resource pool after your cluster installation is finished.

- A Linux-based host deployed to VMC as a bastion.
  - The bastion host can be Red Hat Enterprise Linux (RHEL) or any another Linux-based host; it must have internet connectivity and the ability to upload an OVA to the ESXi hosts.
  - Download and install the OpenShift CLI tools to the bastion host.
    - The **openshift-install** installation program
    - The OpenShift CLI (**oc**) tool

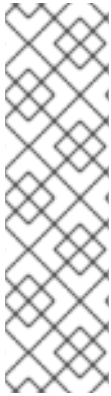
**NOTE**

You cannot use the VMware NSX Container Plugin for Kubernetes (NCP), and NSX is not used as the OpenShift SDN. The version of NSX currently available with VMC is incompatible with the version of NCP certified with OpenShift Container Platform.

However, the NSX DHCP service is used for virtual machine IP management with the full-stack automated OpenShift Container Platform deployment and with nodes provisioned, either manually or automatically, by the Machine API integration with vSphere. Additionally, NSX firewall rules are created to enable access with the OpenShift Container Platform cluster and between the bastion host and the VMC vSphere hosts.

### 21.3.1.1. VMC Sizer tool

VMware Cloud on AWS is built on top of AWS bare metal infrastructure; this is the same bare metal infrastructure which runs AWS native services. When a VMware cloud on AWS software-defined data center (SDDC) is deployed, you consume these physical server nodes and run the VMware ESXi hypervisor in a single tenant fashion. This means the physical infrastructure is not accessible to anyone else using VMC. It is important to consider how many physical hosts you will need to host your virtual infrastructure.

To determine this, VMware provides the [VMC on AWS Sizer](#). With this tool, you can define the resources you intend to host on VMC:

- Types of workloads
- Total number of virtual machines
- Specification information such as:
  - Storage requirements
  - vCPUs
  - vRAM
  - Overcommit ratios

With these details, the sizer tool can generate a report, based on VMware best practices, and recommend your cluster configuration and the number of hosts you will need.

### 21.3.2. vSphere prerequisites

- You reviewed details about the [OpenShift Container Platform installation and update](#) processes.
- You read the documentation on [selecting a cluster installation method and preparing it for users](#).
- You provisioned [block registry storage](#). For more information on persistent storage, see [Understanding persistent storage](#).
- If you use a firewall, you [configured it to allow the sites](#) that your cluster requires access to.

**NOTE**

Be sure to also review this site list if you are configuring a proxy.

**21.3.3. Internet access for OpenShift Container Platform**

In OpenShift Container Platform 4.10, you require access to the internet to install your cluster.

You must have internet access to:

- Access [OpenShift Cluster Manager](#) to download the installation program and perform subscription management. If the cluster has internet access and you do not disable Telemetry, that service automatically entitles your cluster.
- Access [Quay.io](#) to obtain the packages that are required to install your cluster.
- Obtain the packages that are required to perform cluster updates.

**IMPORTANT**

If your cluster cannot have direct internet access, you can perform a restricted network installation on some types of infrastructure that you provision. During that process, you download the required content and use it to populate a mirror registry with the installation packages. With some installation types, the environment that you install your cluster in will not require internet access. Before you update the cluster, you update the content of the mirror registry.

**21.3.4. VMware vSphere infrastructure requirements**

You must install the OpenShift Container Platform cluster on a VMware vSphere version 7 instance that meets the requirements for the components that you use.

**NOTE**

OpenShift Container Platform version 4.10 does not support VMware vSphere version 8.0.

You can host the VMware vSphere infrastructure on-premise or on a [VMware Cloud Verified provider](#) that meets the requirements outlined in the following table:

**Table 21.9. Version requirements for vSphere virtual environments**

Virtual environment product	Required version
VM hardware version	15 or later
vSphere ESXi hosts	7
vCenter host	7

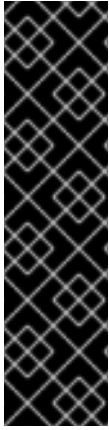

## IMPORTANT

Installing a cluster on VMware vSphere version 7.0 Update 1 is now deprecated. These versions are still fully supported, but version 4.10 of OpenShift Container Platform requires vSphere virtual hardware version 15 or later. Hardware version 15 is now the default for vSphere virtual machines in OpenShift Container Platform. To update the hardware version for your vSphere nodes, see the "Updating hardware on nodes running in vSphere" article.

If your vSphere nodes are below hardware version 15 or your VMware vSphere version is earlier than 6.7U3, upgrading from OpenShift Container Platform 4.10 to OpenShift Container Platform 4.11 is not available.

**Table 21.10. Minimum supported vSphere version for VMware components**

Component	Minimum supported versions	Description
Hypervisor	vSphere 7 with HW version 15	This version is the minimum version that Red Hat Enterprise Linux CoreOS (RHCOS) supports. For more information about supported hardware on the latest version of Red Hat Enterprise Linux (RHEL) that is compatible with RHCOS, see <a href="#">Hardware</a> on the Red Hat Customer Portal.
Storage with in-tree drivers	vSphere 7	This plugin creates vSphere storage by using the in-tree storage drivers for vSphere included in OpenShift Container Platform.

If you use a vSphere version 6.5 instance, upgrade to 7.0 before you install OpenShift Container Platform.



## IMPORTANT

You must ensure that the time on your ESXi hosts is synchronized before you install OpenShift Container Platform. See [Edit Time Configuration for a Host](#) in the VMware documentation.

### 21.3.5. Network connectivity requirements

You must configure the network connectivity between machines to allow OpenShift Container Platform cluster components to communicate.

Review the following details about the required network ports.

**Table 21.11. Ports used for all-machine to all-machine communications**

Protocol	Port	Description
ICMP	N/A	Network reachability tests
TCP	<b>1936</b>	Metrics
	<b>9000-9999</b>	Host level services, including the node exporter on ports <b>9100-9101</b> and the Cluster Version Operator on port <b>9099</b> .
	<b>10250-10259</b>	The default ports that Kubernetes reserves
	<b>10256</b>	openshift-sdn
UDP	<b>4789</b>	virtual extensible LAN (VXLAN)
	<b>6081</b>	Geneve
	<b>9000-9999</b>	Host level services, including the node exporter on ports <b>9100-9101</b> .
	<b>500</b>	IPsec IKE packets
	<b>4500</b>	IPsec NAT-T packets
TCP/UDP	<b>30000-32767</b>	Kubernetes node port
ESP	N/A	IPsec Encapsulating Security Payload (ESP)

Table 21.12. Ports used for all-machine to control plane communications

Protocol	Port	Description
TCP	<b>6443</b>	Kubernetes API

Table 21.13. Ports used for control plane machine to control plane machine communications

Protocol	Port	Description
TCP	<b>2379-2380</b>	etcd server and peer ports

### 21.3.6. VMware vSphere CSI Driver Operator requirements

To install the vSphere CSI Driver Operator, the following requirements must be met:

- VMware vSphere version 6.7U3 or later
- Virtual machines of hardware version 15 or later

- No third-party vSphere CSI driver already installed in the cluster

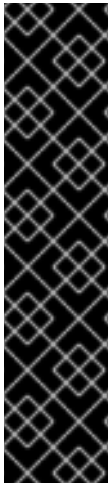

## IMPORTANT

If a third-party vSphere CSI driver is present in the cluster, OpenShift Container Platform does not overwrite it. If you continue with the third-party vSphere CSI driver when upgrading to the next major version of OpenShift Container Platform, the **oc** CLI prompts you with the following message:

```
VSphereCSIDriverOperatorCRUpgradeable: VMwareVSphereControllerUpgradeable:
found existing unsupported csi.vsphere.vmware.com driver
```

The previous message informs you that Red Hat does not support the third-party vSphere CSI driver during an OpenShift Container Platform upgrade operation. You can choose to ignore this message and continue with the upgrade operation.

### Additional resources

- To remove a third-party CSI driver, see [Removing a third-party vSphere CSI Driver](#) .
- To update the hardware version for your vSphere nodes, see [Updating hardware on nodes running in vSphere](#).

### 21.3.7. vCenter requirements

Before you install an OpenShift Container Platform cluster on your vCenter that uses infrastructure that the installer provisions, you must prepare your environment.

#### Required vCenter account privileges

To install an OpenShift Container Platform cluster in a vCenter, the installation program requires access to an account with privileges to read and create the required resources. Using an account that has global administrative privileges is the simplest way to access all of the necessary permissions.

If you cannot use an account with global administrative privileges, you must create roles to grant the privileges necessary for OpenShift Container Platform cluster installation. While most of the privileges are always required, some are required only if you plan for the installation program to provision a folder to contain the OpenShift Container Platform cluster on your vCenter instance, which is the default behavior. You must create or amend vSphere roles for the specified objects to grant the required privileges.

An additional role is required if the installation program is to create a vSphere virtual machine folder.

#### Example 21.4. Roles and privileges required for installation in vSphere API

vSphere object for role	When required	Required privileges in vSphere API
-------------------------	---------------	------------------------------------



vSphere object for role	When required	Required privileges in vSphere API
vSphere vCenter	Always	<b>Cns.Searchable</b> <b>InventoryService.Tagging.AttachTag</b> <b>InventoryService.Tagging.CreateCategory</b> <b>InventoryService.Tagging.CreateTag</b> <b>InventoryService.Tagging.DeleteCategory</b> <b>InventoryService.Tagging.DeleteTag</b> <b>InventoryService.Tagging.EditCategory</b> <b>InventoryService.Tagging.EditTag</b> <b>Sessions.ValidateSession</b> <b>StorageProfile.Update</b> <b>StorageProfile.View</b>
vSphere vCenter Cluster	If VMs will be created in the cluster root	<b>Host.Config.StorageResource.AssignVMToPool</b> <b>VApp.AssignResourcePool</b> <b>VApp.Import</b> <b>VirtualMachine.Config.AddNewDisk</b>
vSphere vCenter Resource Pool	If an existing resource pool is provided	<b>Host.Config.StorageResource.AssignVMToPool</b> <b>VApp.AssignResourcePool</b> <b>VApp.Import</b> <b>VirtualMachine.Config.AddNewDisk</b>
vSphere Datastore	Always	<b>Datastore.AllocateSpace</b> <b>Datastore.Browse</b> <b>Datastore.FileManagement</b> <b>InventoryService.Tagging.ObjectAttachable</b>
vSphere Port Group	Always	<b>Network.Assign</b>
Virtual Machine Folder	Always	<b>InventoryService.Tagging.ObjectAttachable</b> <b>Resource.AssignVMToPool</b> <b>VApp.Import</b> <b>VirtualMachine.Config.AddExistingDisk</b> <b>VirtualMachine.Config.AddNewDisk</b>

vSphere object for role	When required	Required privileges in vSphere API
		<b>VirtualMachine.Config.AddRemoveDevice</b> <b>VirtualMachine.Config.AdvancedConfig</b> <b>VirtualMachine.Config.Annotation</b> <b>VirtualMachine.Config.CPUCount</b> <b>VirtualMachine.Config.DiskExtend</b> <b>VirtualMachine.Config.DiskLease</b> <b>VirtualMachine.Config.EditDevice</b> <b>VirtualMachine.Config.Memory</b> <b>VirtualMachine.Config.RemoveDisk</b> <b>VirtualMachine.Config.Rename</b> <b>VirtualMachine.Config.ResetGuestInfo</b> <b>VirtualMachine.Config.Resource</b> <b>VirtualMachine.Config.Settings</b> <b>VirtualMachine.Config.UpgradeVirtualHardware</b> <b>VirtualMachine.Interact.GuestControl</b> <b>VirtualMachine.Interact.PowerOff</b> <b>VirtualMachine.Interact.PowerOn</b> <b>VirtualMachine.Interact.Reset</b> <b>VirtualMachine.Inventory.Create</b> <b>VirtualMachine.Inventory.CreateFromExisting</b> <b>VirtualMachine.Inventory.Delete</b> <b>VirtualMachine.Provisioning.Clone</b> <b>VirtualMachine.Provisioning.MarkAsTemplate</b> <b>VirtualMachine.Provisioning.DeployTemplate</b>
vSphere vCenter Datacenter	If the installation program creates the virtual machine folder	<b>InventoryService.Tagging.ObjectAttachable</b> <b>Resource.AssignVMToPool</b> <b>VApp.Import</b> <b>VirtualMachine.Config.AddExistingDisk</b> <b>VirtualMachine.Config.Add</b>

vSphere object for role	When required	NewDisk Required privileges in vSphere API
		VirtualMachine.Config.AddNewDevice VirtualMachine.Config.AdvancedConfig VirtualMachine.Config.Annotation VirtualMachine.Config.CPUCount VirtualMachine.Config.DiskExtend VirtualMachine.Config.DiskLease VirtualMachine.Config.EditDevice VirtualMachine.Config.Memory VirtualMachine.Config.RemoveDisk VirtualMachine.Config.Rename VirtualMachine.Config.ResetGuestInfo VirtualMachine.Config.Resource VirtualMachine.Config.Settings VirtualMachine.Config.UpgradeVirtualHardware VirtualMachine.Interact.GuestControl VirtualMachine.Interact.PowerOff VirtualMachine.Interact.PowerOn VirtualMachine.Interact.Reset VirtualMachine.Inventory.Create VirtualMachine.Inventory.CreateFromExisting VirtualMachine.Inventory.Delete VirtualMachine.Provisioning.Clone VirtualMachine.Provisioning.DeployTemplate VirtualMachine.Provisioning.MarkAsTemplate Folder.Create Folder.Delete

Example 21.5. Roles and privileges required for installation in vCenter graphical user interface (GUI)

vSphere object for role	When required	Required privileges in vCenter GUI
vSphere vCenter	Always	<b>Cns.Searchable</b> <b>"vSphere Tagging"."Assign or Unassign vSphere Tag"</b> <b>"vSphere Tagging"."Create vSphere Tag Category"</b> <b>"vSphere Tagging"."Create vSphere Tag"</b> <b>vSphere Tagging"."Delete vSphere Tag Category"</b> <b>"vSphere Tagging"."Delete vSphere Tag"</b> <b>"vSphere Tagging"."Edit vSphere Tag Category"</b> <b>"vSphere Tagging"."Edit vSphere Tag"</b> <b>Sessions."Validate session"</b> <b>"Profile-driven storage"."Profile-driven storage update"</b> <b>"Profile-driven storage"."Profile-driven storage view"</b>
vSphere vCenter Cluster	If VMs will be created in the cluster root	<b>Host.Configuration."Storage partition configuration"</b> <b>Resource."Assign virtual machine to resource pool"</b> <b>VApp."Assign resource pool"</b> <b>VApp.Import</b> <b>"Virtual machine"."Change Configuration"."Add new disk"</b>
vSphere vCenter Resource Pool	If an existing resource pool is provided	<b>Host.Configuration."Storage partition configuration"</b> <b>Resource."Assign virtual machine to resource pool"</b> <b>VApp."Assign resource pool"</b> <b>VApp.Import</b> <b>"Virtual machine"."Change Configuration"."Add new disk"</b>

vSphere object for role	When required	Required privileges in vCenter GUI
vSphere Datastore	Always	<b>Datastore."Allocate space"</b> <b>Datastore."Browse datastore"</b> <b>Datastore."Low level file operations"</b> <b>"vSphere Tagging"."Assign or Unassign vSphere Tag on Object"</b>
vSphere Port Group	Always	<b>Network."Assign network"</b>
Virtual Machine Folder	Always	<b>"vSphere Tagging"."Assign or Unassign vSphere Tag on Object"</b> <b>Resource."Assign virtual machine to resource pool"</b> <b>VApp.Import</b> <b>"Virtual machine"."Change Configuration"."Add existing disk"</b> <b>"Virtual machine"."Change Configuration"."Add new disk"</b> <b>"Virtual machine"."Change Configuration"."Add or remove device"</b> <b>"Virtual machine"."Change Configuration"."Advanced configuration"</b> <b>"Virtual machine"."Change Configuration"."Set annotation"</b> <b>"Virtual machine"."Change Configuration"."Change CPU count"</b> <b>"Virtual machine"."Change Configuration"."Extend virtual disk"</b> <b>"Virtual machine"."Change Configuration"."Acquire disk lease"</b> <b>"Virtual machine"."Change Configuration"."Modify device settings"</b> <b>"Virtual machine"."Change Configuration"."Change Memory"</b> <b>"Virtual machine"."Change Configuration"."Remove disk"</b> <b>"Virtual machine"."Change</b>

vSphere object for role	When required	Configuration".Rename Virtual machine".Change GUI Configuration".Reset guest information"
		"Virtual machine".Change Configuration".Change resource" "Virtual machine".Change Configuration".Change Settings" "Virtual machine".Change Configuration".Upgrade virtual machine compatibility" "Virtual machine".Interaction."Gues t operating system management by VIX API" "Virtual machine".Interaction."Powe r off" "Virtual machine".Interaction."Powe r on" "Virtual machine".Interaction.Reset "Virtual machine".Edit Inventory".Create new" "Virtual machine".Edit Inventory".Create from existing" "Virtual machine".Edit Inventory".Remove" "Virtual machine".Provisioning."Clo ne virtual machine" "Virtual machine".Provisioning."Mar k as template" "Virtual machine".Provisioning."De ploy template"
vSphere vCenter Datacenter	If the installation program creates the virtual machine folder	"vSphere Tagging".Assign or Unassign vSphere Tag on Object" Resource."Assign virtual machine to resource pool" VApp.Import "Virtual machine".Change Configuration".Add existing disk" "Virtual machine".Change Configuration".Add new disk" "Virtual machine".Change

vSphere object for role	When required	Configuration". "Add or Remove device Virtual machine". "Change Configuration". "Advanced configuration" "Virtual machine". "Change Configuration". "Set annotation" "Virtual machine". "Change Configuration". "Change CPU count" "Virtual machine". "Change Configuration". "Extend virtual disk" "Virtual machine". "Change Configuration". "Acquire disk lease" "Virtual machine". "Change Configuration". "Modify device settings" "Virtual machine". "Change Configuration". "Change Memory" "Virtual machine". "Change Configuration". "Remove disk" "Virtual machine". "Change Configuration". Rename "Virtual machine". "Change Configuration". "Reset guest information" "Virtual machine". "Change Configuration". "Change resource" "Virtual machine". "Change Configuration". "Change Settings" "Virtual machine". "Change Configuration". "Upgrade virtual machine compatibility" "Virtual machine". Interaction. "Guest operating system management by VIX API" "Virtual machine". Interaction. "Power off" "Virtual machine". Interaction. "Power on" "Virtual machine". Interaction. Reset "Virtual machine". "Edit Inventory". "Create new" "Virtual machine". "Edit

vSphere object for role	When required	Inventory". "Create from existing Virtual machine". "Edit Virtual machine". "Remove Virtual machine". "Provisioning. "Clone virtual machine" "Virtual machine". "Provisioning. "Deploy template" "Virtual machine". "Provisioning. "Mark as template" Folder. "Create folder" Folder. "Delete folder"

Additionally, the user requires some **ReadOnly** permissions, and some of the roles require permission to propagate the permissions to child objects. These settings vary depending on whether or not you install the cluster into an existing folder.

**Example 21.6. Required permissions and propagation settings**

vSphere object	When required	Propagate to children	Permissions required
vSphere vCenter	Always	False	Listed required privileges
vSphere vCenter Datacenter	Existing folder	False	<b>ReadOnly</b> permission
	Installation program creates the folder	True	Listed required privileges
vSphere vCenter Cluster	Existing resource pool	False	<b>ReadOnly</b> permission
	VMs in cluster root	True	Listed required privileges
vSphere vCenter Datastore	Always	False	Listed required privileges
vSphere Switch	Always	False	<b>ReadOnly</b> permission
vSphere Port Group	Always	False	Listed required privileges
vSphere vCenter Virtual Machine Folder	Existing folder	True	Listed required privileges



vSphere object	When required	Propagate to children	Permissions required
vSphere vCenter Resource Pool	Existing resource pool	True	Listed required privileges

For more information about creating an account with only the required privileges, see [vSphere Permissions and User Management Tasks](#) in the vSphere documentation.

### Using OpenShift Container Platform with vMotion

If you intend on using vMotion in your vSphere environment, consider the following before installing a OpenShift Container Platform cluster.

- OpenShift Container Platform generally supports compute-only vMotion. Using Storage vMotion can cause issues and is not supported. To help ensure the uptime of your compute and control plane nodes, it is recommended that you follow the VMware best practices for vMotion. It is also recommended to use VMware anti-affinity rules to improve the availability of OpenShift Container Platform during maintenance or hardware issues.

For more information about vMotion and anti-affinity rules, see the VMware vSphere documentation for [vMotion networking requirements](#) and [VM anti-affinity rules](#).

- If you are using vSphere volumes in your pods, migrating a VM across datastores either manually or through Storage vMotion causes, invalid references within OpenShift Container Platform persistent volume (PV) objects. These references prevent affected pods from starting up and can result in data loss.
- Similarly, OpenShift Container Platform does not support selective migration of VMDKs across datastores, using datastore clusters for VM provisioning or for dynamic or static provisioning of PVs, or using a datastore that is part of a datastore cluster for dynamic or static provisioning of PVs.

### Cluster resources

When you deploy an OpenShift Container Platform cluster that uses installer-provisioned infrastructure, the installation program must be able to create several resources in your vCenter instance.

A standard OpenShift Container Platform installation creates the following vCenter resources:

- 1 Folder
- 1 Tag category
- 1 Tag
- Virtual machines:
  - 1 template
  - 1 temporary bootstrap node
  - 3 control plane nodes
  - 3 compute machines

Although these resources use 856 GB of storage, the bootstrap node is destroyed during the cluster installation process. A minimum of 800 GB of storage is required to use a standard cluster.

If you deploy more compute machines, the OpenShift Container Platform cluster will use more storage.

### Cluster limits

Available resources vary between clusters. The number of possible clusters within a vCenter is limited primarily by available storage space and any limitations on the number of required resources. Be sure to consider both limitations to the vCenter resources that the cluster creates and the resources that you require to deploy a cluster, such as IP addresses and networks.

### Networking requirements

You must use the Dynamic Host Configuration Protocol (DHCP) for the network and ensure that the DHCP server is configured to provide persistent IP addresses to the cluster machines. In the DHCP lease, you must configure the DHCP to use the default gateway. All nodes must be in the same VLAN. You cannot scale the cluster using a second VLAN as a Day 2 operation. Additionally, you must create the following networking resources before you install the OpenShift Container Platform cluster:

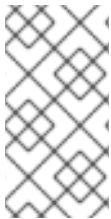

#### NOTE

It is recommended that each OpenShift Container Platform node in the cluster must have access to a Network Time Protocol (NTP) server that is discoverable via DHCP. Installation is possible without an NTP server. However, asynchronous server clocks will cause errors, which NTP server prevents.

### Required IP Addresses

An installer-provisioned vSphere installation requires two static IP addresses:

- The **API** address is used to access the cluster API.
- The **Ingress** address is used for cluster ingress traffic.

You must provide these IP addresses to the installation program when you install the OpenShift Container Platform cluster.

### DNS records

You must create DNS records for two static IP addresses in the appropriate DNS server for the vCenter instance that hosts your OpenShift Container Platform cluster. In each record, **<cluster\_name>** is the cluster name and **<base\_domain>** is the cluster base domain that you specify when you install the cluster. A complete DNS record takes the form: **<component>.<cluster\_name>.<base\_domain>.**

Table 21.14. Required DNS records

Component	Record	Description
API VIP	<b>api.&lt;cluster_name&gt;.&lt;base_domain&gt;.</b>	This DNS A/AAAA or CNAME record must point to the load balancer for the control plane machines. This record must be resolvable by both clients external to the cluster and from all the nodes within the cluster.

Component	Record	Description
Ingress VIP	*.apps.<cluster_name>.<base_domain>.	A wildcard DNS A/AAAA or CNAME record that points to the load balancer that targets the machines that run the Ingress router pods, which are the worker nodes by default. This record must be resolvable by both clients external to the cluster and from all the nodes within the cluster.

### 21.3.8. Generating a key pair for cluster node SSH access

During an OpenShift Container Platform installation, you can provide an SSH public key to the installation program. The key is passed to the Red Hat Enterprise Linux CoreOS (RHCOS) nodes through their Ignition config files and is used to authenticate SSH access to the nodes. The key is added to the `~/.ssh/authorized_keys` list for the **core** user on each node, which enables password-less authentication.

After the key is passed to the nodes, you can use the key pair to SSH in to the RHCOS nodes as the user **core**. To access the nodes through SSH, the private key identity must be managed by SSH for your local user.

If you want to SSH in to your cluster nodes to perform installation debugging or disaster recovery, you must provide the SSH public key during the installation process. The `./openshift-install gather` command also requires the SSH public key to be in place on the cluster nodes.



#### IMPORTANT

Do not skip this procedure in production environments, where disaster recovery and debugging is required.



#### NOTE

You must use a local key, not one that you configured with platform-specific approaches such as [AWS key pairs](#).

#### Procedure

1. If you do not have an existing SSH key pair on your local machine to use for authentication onto your cluster nodes, create one. For example, on a computer that uses a Linux operating system, run the following command:

```
$ ssh-keygen -t ed25519 -N "" -f <path>/<file_name> 1
```

- 1 Specify the path and file name, such as `~/.ssh/id_ed25519`, of the new SSH key. If you have an existing key pair, ensure your public key is in the your `~/.ssh` directory.

**NOTE**

If you plan to install an OpenShift Container Platform cluster that uses FIPS validated or Modules In Process cryptographic libraries on the **x86\_64** architecture, do not create a key that uses the **ed25519** algorithm. Instead, create a key that uses the **rsa** or **ecdsa** algorithm.

- View the public SSH key:

```
$ cat <path>/<file_name>.pub
```

For example, run the following to view the `~/.ssh/id_ed25519.pub` public key:

```
$ cat ~/.ssh/id_ed25519.pub
```

- Add the SSH private key identity to the SSH agent for your local user, if it has not already been added. SSH agent management of the key is required for password-less SSH authentication onto your cluster nodes, or if you want to use the `./openshift-install gather` command.

**NOTE**

On some distributions, default SSH private key identities such as `~/.ssh/id_rsa` and `~/.ssh/id_dsa` are managed automatically.

- If the **ssh-agent** process is not already running for your local user, start it as a background task:

```
$ eval "$(ssh-agent -s)"
```

**Example output**

```
Agent pid 31874
```

**NOTE**

If your cluster is in FIPS mode, only use FIPS-compliant algorithms to generate the SSH key. The key must be either RSA or ECDSA.

- Add your SSH private key to the **ssh-agent**:

```
$ ssh-add <path>/<file_name> 1
```

- 1** Specify the path and file name for your SSH private key, such as `~/.ssh/id_ed25519`

**Example output**

```
Identity added: /home/<you>/<path>/<file_name> (<computer_name>)
```

**Next steps**

- When you install OpenShift Container Platform, provide the SSH public key to the installation program.

### 21.3.9. Obtaining the installation program

Before you install OpenShift Container Platform, download the installation file on a local computer.

#### Prerequisites

- You have a computer that runs Linux or macOS, with 500 MB of local disk space

#### Procedure

1. Access the [Infrastructure Provider](#) page on the OpenShift Cluster Manager site. If you have a Red Hat account, log in with your credentials. If you do not, create an account.
2. Select your infrastructure provider.
3. Navigate to the page for your installation type, download the installation program that corresponds with your host operating system and architecture, and place the file in the directory where you will store the installation configuration files.

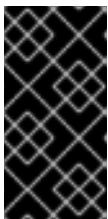

#### IMPORTANT

The installation program creates several files on the computer that you use to install your cluster. You must keep the installation program and the files that the installation program creates after you finish installing the cluster. Both files are required to delete the cluster.

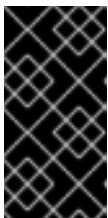

#### IMPORTANT

Deleting the files created by the installation program does not remove your cluster, even if the cluster failed during installation. To remove your cluster, complete the OpenShift Container Platform uninstallation procedures for your specific cloud provider.

4. Extract the installation program. For example, on a computer that uses a Linux operating system, run the following command:

```
$ tar -xvf openshift-install-linux.tar.gz
```

5. Download your installation [pull secret from the Red Hat OpenShift Cluster Manager](#). This pull secret allows you to authenticate with the services that are provided by the included authorities, including Quay.io, which serves the container images for OpenShift Container Platform components.

### 21.3.10. Adding vCenter root CA certificates to your system trust

Because the installation program requires access to your vCenter's API, you must add your vCenter's trusted root CA certificates to your system trust before you install an OpenShift Container Platform cluster.

#### Procedure

1. From the vCenter home page, download the vCenter's root CA certificates. Click **Download trusted root CA certificates** in the vSphere Web Services SDK section. The **<vCenter>/certs/download.zip** file downloads.
2. Extract the compressed file that contains the vCenter root CA certificates. The contents of the compressed file resemble the following file structure:

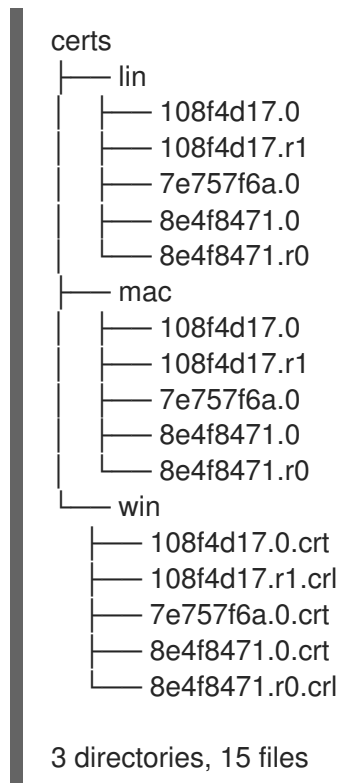

3. Add the files for your operating system to the system trust. For example, on a Fedora operating system, run the following command:

```
# cp certs/lin/* /etc/pki/ca-trust/source/anchors
```

4. Update your system trust. For example, on a Fedora operating system, run the following command:

```
# update-ca-trust extract
```

### 21.3.11. Creating the installation configuration file

You can customize the OpenShift Container Platform cluster you install on VMware vSphere.

#### Prerequisites

- Obtain the OpenShift Container Platform installation program and the pull secret for your cluster.
- Obtain service principal permissions at the subscription level.

#### Procedure

1. Create the **install-config.yaml** file.
  - a. Change to the directory that contains the installation program and run the following

command:

```
$. /openshift-install create install-config --dir <installation_directory> 1
```

- 1** For **<installation\_directory>**, specify the directory name to store the files that the installation program creates.



### IMPORTANT

Specify an empty directory. Some installation assets, like bootstrap X.509 certificates have short expiration intervals, so you must not reuse an installation directory. If you want to reuse individual files from another cluster installation, you can copy them into your directory. However, the file names for the installation assets might change between releases. Use caution when copying installation files from an earlier OpenShift Container Platform version.

- b. At the prompts, provide the configuration details for your cloud:
- i. Optional: Select an SSH key to use to access your cluster machines.



### NOTE

For production OpenShift Container Platform clusters on which you want to perform installation debugging or disaster recovery, specify an SSH key that your **ssh-agent** process uses.

- ii. Select **vsphere** as the platform to target.
- iii. Specify the name of your vCenter instance.
- iv. Specify the user name and password for the vCenter account that has the required permissions to create the cluster.  
The installation program connects to your vCenter instance.
- v. Select the datacenter in your vCenter instance to connect to.
- vi. Select the default vCenter datastore to use.
- vii. Select the vCenter cluster to install the OpenShift Container Platform cluster in. The installation program uses the root resource pool of the vSphere cluster as the default resource pool.
- viii. Select the network in the vCenter instance that contains the virtual IP addresses and DNS records that you configured.
- ix. Enter the virtual IP address that you configured for control plane API access.
- x. Enter the virtual IP address that you configured for cluster ingress.
- xi. Enter the base domain. This base domain must be the same one that you used in the DNS records that you configured.

- xii. Enter a descriptive name for your cluster. The cluster name you enter must match the cluster name you specified when configuring the DNS records.
  - xiii. Paste the [pull secret from the Red Hat OpenShift Cluster Manager](#) .
2. Modify the **install-config.yaml** file. You can find more information about the available parameters in the "Installation configuration parameters" section.
  3. Back up the **install-config.yaml** file so that you can use it to install multiple clusters.

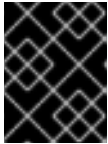

### IMPORTANT

The **install-config.yaml** file is consumed during the installation process. If you want to reuse the file, you must back it up now.

#### 21.3.11.1. Installation configuration parameters

Before you deploy an OpenShift Container Platform cluster, you provide parameter values to describe your account on the cloud platform that hosts your cluster and optionally customize your cluster's platform. When you create the **install-config.yaml** installation configuration file, you provide values for the required parameters through the command line. If you customize your cluster, you can modify the **install-config.yaml** file to provide more details about the platform.



### NOTE

After installation, you cannot modify these parameters in the **install-config.yaml** file.

##### 21.3.11.1.1. Required configuration parameters

Required installation configuration parameters are described in the following table:

Table 21.15. Required parameters

Parameter	Description	Values
<b>apiVersion</b>	The API version for the <b>install-config.yaml</b> content. The current version is <b>v1</b> . The installer may also support older API versions.	String
<b>baseDomain</b>	The base domain of your cloud provider. The base domain is used to create routes to your OpenShift Container Platform cluster components. The full DNS name for your cluster is a combination of the <b>baseDomain</b> and <b>metadata.name</b> parameter values that uses the <b>&lt;metadata.name&gt;</b> . <b>&lt;baseDomain&gt;</b> format.	A fully-qualified domain or subdomain name, such as <b>example.com</b> .



Parameter	Description	Values
<b>metadata</b>	Kubernetes resource <b>ObjectMeta</b> , from which only the <b>name</b> parameter is consumed.	Object
<b>metadata.name</b>	The name of the cluster. DNS records for the cluster are all subdomains of <b>{{.metadata.name}}</b> . <b>{{.baseDomain}}</b> .	String of lowercase letters and hyphens (-), such as <b>dev</b> .
<b>platform</b>	The configuration for the specific platform upon which to perform the installation: <b>alibabacloud</b> , <b>aws</b> , <b>baremetal</b> , <b>azure</b> , <b>gcp</b> , <b>ibmcloud</b> , <b>openstack</b> , <b>ovirt</b> , <b>vsphere</b> , or <b>{}</b> . For additional information about <b>platform.&lt;platform&gt;</b> parameters, consult the table for your specific platform that follows.	Object
<b>pullSecret</b>	Get a <a href="#">pull secret from the Red Hat OpenShift Cluster Manager</a> to authenticate downloading container images for OpenShift Container Platform components from services such as Quay.io.	<pre>{   "auths":{     "cloud.openshift.com":{       "auth":"b3Blb=",       "email":"you@example.com"     },     "quay.io":{       "auth":"b3Blb=",       "email":"you@example.com"     }   } }</pre>

### 21.3.11.1.2. Network configuration parameters

You can customize your installation configuration based on the requirements of your existing network infrastructure. For example, you can expand the IP address block for the cluster network or provide different IP address blocks than the defaults.

Only IPv4 addresses are supported.

Table 21.16. Network parameters

Parameter	Description	Values
<b>networking</b>	The configuration for the cluster network.	Object  <b>NOTE</b> You cannot modify parameters specified by the <b>networking</b> object after installation.
<b>networking.networkType</b>	The cluster network provider Container Network Interface (CNI) plugin to install.	Either <b>OpenShiftSDN</b> or <b>OVNKubernetes</b> . <b>OpenShiftSDN</b> is a CNI provider for all-Linux networks. <b>OVNKubernetes</b> is a CNI provider for Linux networks and hybrid networks that contain both Linux and Windows servers. The default value is <b>OpenShiftSDN</b> .
<b>networking.clusterNetwork</b>	The IP address blocks for pods.  The default value is <b>10.128.0.0/14</b> with a host prefix of <b>/23</b> .  If you specify multiple IP address blocks, the blocks must not overlap.	An array of objects. For example:  <pre>networking:   clusterNetwork:     - cidr: 10.128.0.0/14       hostPrefix: 23</pre>
<b>networking.clusterNetwork.cidr</b>	Required if you use <b>networking.clusterNetwork</b> . An IP address block.  An IPv4 network.	An IP address block in Classless Inter-Domain Routing (CIDR) notation. The prefix length for an IPv4 block is between <b>0</b> and <b>32</b> .
<b>networking.clusterNetwork.hostPrefix</b>	The subnet prefix length to assign to each individual node. For example, if <b>hostPrefix</b> is set to <b>23</b> then each node is assigned a <b>/23</b> subnet out of the given <b>cidr</b> . A <b>hostPrefix</b> value of <b>23</b> provides 510 ( $2^{(32 - 23)} - 2$ ) pod IP addresses.	A subnet prefix.  The default value is <b>23</b> .
<b>networking.serviceNetwork</b>	The IP address block for services. The default value is <b>172.30.0.0/16</b> .  The OpenShift SDN and OVN-Kubernetes network providers support only a single IP address block for the service network.	An array with an IP address block in CIDR format. For example:  <pre>networking:   serviceNetwork:     - 172.30.0.0/16</pre>

Parameter	Description	Values
<b>networking.machineNetwork</b>	The IP address blocks for machines.  If you specify multiple IP address blocks, the blocks must not overlap.	An array of objects. For example:  <pre>networking:   machineNetwork:   - cidr: 10.0.0.0/16</pre>
<b>networking.machineNetwork.cidr</b>	Required if you use <b>networking.machineNetwork</b> . An IP address block. The default value is <b>10.0.0.0/16</b> for all platforms other than libvirt. For libvirt, the default value is <b>192.168.126.0/24</b> .	An IP network block in CIDR notation.  For example, <b>10.0.0.0/16</b> .   <p><b>NOTE</b></p> <p>Set the <b>networking.machineNetwork</b> to match the CIDR that the preferred NIC resides in.</p>

### 21.3.11.1.3. Optional configuration parameters



Optional installation configuration parameters are described in the following table:

Table 21.17. Optional parameters



Parameter	Description	Values
<b>additionalTrustBundle</b>	A PEM-encoded X.509 certificate bundle that is added to the nodes' trusted certificate store. This trust bundle may also be used when a proxy has been configured.	String
<b>cgroupsV2</b>	Enables <a href="#">Linux control groups version 2</a> (cgroups v2) on specific nodes in your cluster. The OpenShift Container Platform process for enabling cgroups v2 disables all cgroup version 1 controllers and hierarchies. The OpenShift Container Platform cgroups version 2 feature is in Developer Preview and is not supported by Red Hat at this time.	<b>true</b>
<b>compute</b>	The configuration for the machines that comprise the compute nodes.	Array of <b>MachinePool</b> objects.

Parameter	Description	Values
<b>compute.architecture</b>	Determines the instruction set architecture of the machines in the pool. Currently, clusters with varied architectures are not supported. All pools must specify the same architecture. Valid values are <b>amd64</b> (the default).	String
<b>compute.hyperthreading</b>	Whether to enable or disable simultaneous multithreading, or <b>hyperthreading</b> , on compute machines. By default, simultaneous multithreading is enabled to increase the performance of your machines' cores.   <b>IMPORTANT</b> If you disable simultaneous multithreading, ensure that your capacity planning accounts for the dramatically decreased machine performance.	<b>Enabled</b> or <b>Disabled</b>
<b>compute.name</b>	Required if you use <b>compute</b> . The name of the machine pool.	<b>worker</b>
<b>compute.platform</b>	Required if you use <b>compute</b> . Use this parameter to specify the cloud provider to host the worker machines. This parameter value must match the <b>controlPlane.platform</b> parameter value.	<b>alibabacloud, aws, azure, gcp, ibmcloud, openstack, ovirt, vsphere</b> , or <b>{}</b>
<b>compute.replicas</b>	The number of compute machines, which are also known as worker machines, to provision.	A positive integer greater than or equal to <b>2</b> . The default value is <b>3</b> .
<b>controlPlane</b>	The configuration for the machines that comprise the control plane.	Array of <b>MachinePool</b> objects.

Parameter	Description	Values
<b>controlPlane.architecture</b>	Determines the instruction set architecture of the machines in the pool. Currently, clusters with varied architectures are not supported. All pools must specify the same architecture. Valid values are <b>amd64</b> (the default).	String
<b>controlPlane.hyperthreading</b>	Whether to enable or disable simultaneous multithreading, or <b>hyperthreading</b> , on control plane machines. By default, simultaneous multithreading is enabled to increase the performance of your machines' cores.   <b>IMPORTANT</b>  If you disable simultaneous multithreading, ensure that your capacity planning accounts for the dramatically decreased machine performance.	<b>Enabled</b> or <b>Disabled</b>
<b>controlPlane.name</b>	Required if you use <b>controlPlane</b> . The name of the machine pool.	<b>master</b>
<b>controlPlane.platform</b>	Required if you use <b>controlPlane</b> . Use this parameter to specify the cloud provider that hosts the control plane machines. This parameter value must match the <b>compute.platform</b> parameter value.	<b>alibabacloud, aws, azure, gcp, ibmcloud, openstack, ovirt, vsphere, or {}</b>
<b>controlPlane.replicas</b>	The number of control plane machines to provision.	The only supported value is <b>3</b> , which is the default value.

Parameter	Description	Values
<b>credentialsMode</b>	<p>The Cloud Credential Operator (CCO) mode. If no mode is specified, the CCO dynamically tries to determine the capabilities of the provided credentials, with a preference for mint mode on the platforms where multiple modes are supported.</p> <p> <b>NOTE</b></p> <p>Not all CCO modes are supported for all cloud providers. For more information on CCO modes, see the <i>Cloud Credential Operator</i> entry in the <i>Cluster Operators reference content</i>.</p> <p> <b>NOTE</b></p> <p>If your AWS account has service control policies (SCP) enabled, you must configure the <b>credentialsMode</b> parameter to <b>Mint</b>, <b>Passthrough</b> or <b>Manual</b>.</p>	<b>Mint, Passthrough, Manual</b> or an empty string ("").

Parameter	Description	Values
<b>fips</b>	<p>Enable or disable FIPS mode. The default is <b>false</b> (disabled). If FIPS mode is enabled, the Red Hat Enterprise Linux CoreOS (RHCOS) machines that OpenShift Container Platform runs on bypass the default Kubernetes cryptography suite and use the cryptography modules that are provided with RHCOS instead.</p> <div style="display: flex; align-items: flex-start;"> <div style="width: 20px; height: 100px; background: repeating-linear-gradient(45deg, transparent, transparent 2px, black 2px, black 4px); margin-right: 10px;"></div> <div> <p><b>IMPORTANT</b></p> <p>To enable FIPS mode for your cluster, you must run the installation program from a Red Hat Enterprise Linux (RHEL) computer configured to operate in FIPS mode. For more information about configuring FIPS mode on RHEL, see <a href="#">Installing the system in FIPS mode</a>. The use of FIPS validated or Modules In Process cryptographic libraries is only supported on OpenShift Container Platform deployments on the <b>x86_64</b> architecture.</p> </div> </div> <div style="display: flex; align-items: flex-start; margin-top: 10px;"> <div style="width: 20px; height: 40px; background: repeating-linear-gradient(45deg, transparent, transparent 2px, black 2px, black 4px); margin-right: 10px;"></div> <div> <p><b>NOTE</b></p> <p>If you are using Azure File storage, you cannot enable FIPS mode.</p> </div> </div>	<b>false</b> or <b>true</b>
<b>imageContentSources</b>	Sources and repositories for the release-image content.	Array of objects. Includes a <b>source</b> and, optionally, <b>mirrors</b> , as described in the following rows of this table.
<b>imageContentSources.source</b>	Required if you use <b>imageContentSources</b> . Specify the repository that users refer to, for example, in image pull specifications.	String
<b>imageContentSources.mirrors</b>	Specify one or more repositories that may also contain the same images.	Array of strings

Parameter	Description	Values
<b>publish</b>	How to publish or expose the user-facing endpoints of your cluster, such as the Kubernetes API, OpenShift routes.	<p><b>Internal</b> or <b>External</b>. The default value is <b>External</b>.</p> <p>Setting this field to <b>Internal</b> is not supported on non-cloud platforms and IBM Cloud VPC.</p> <div style="display: flex; align-items: flex-start;">  <div> <p><b>IMPORTANT</b></p> <p>If the value of the field is set to <b>Internal</b>, the cluster will become non-functional. For more information, refer to <a href="#">BZ#1953035</a>.</p> </div> </div>
<b>sshKey</b>	<p>The SSH key or keys to authenticate access your cluster machines.</p> <div style="display: flex; align-items: flex-start;">  <div> <p><b>NOTE</b></p> <p>For production OpenShift Container Platform clusters on which you want to perform installation debugging or disaster recovery, specify an SSH key that your <b>ssh-agent</b> process uses.</p> </div> </div>	<p>One or more keys. For example:</p> <pre>sshKey:   &lt;key1&gt;   &lt;key2&gt;   &lt;key3&gt;</pre>

#### 21.3.11.1.4. Additional VMware vSphere configuration parameters

Additional VMware vSphere configuration parameters are described in the following table:

Table 21.18. Additional VMware vSphere cluster parameters

Parameter	Description	Values
<b>platform.vsphere.vCenter</b>	The fully-qualified hostname or IP address of the vCenter server.	String
<b>platform.vsphere.username</b>	The user name to use to connect to the vCenter instance with. This user must have at least the roles and privileges that are required for <a href="#">static or dynamic persistent volume provisioning</a> in vSphere.	String



Parameter	Description	Values
<b>platform.vsphere.password</b>	The password for the vCenter user name.	String
<b>platform.vsphere.datacenter</b>	The name of the datacenter to use in the vCenter instance.	String
<b>platform.vsphere.defaultDatastore</b>	The name of the default datastore to use for provisioning volumes.	String
<b>platform.vsphere.folder</b>	Optional. The absolute path of an existing folder where the installation program creates the virtual machines. If you do not provide this value, the installation program creates a folder that is named with the infrastructure ID in the datacenter virtual machine folder.	String, for example, <b>/&lt;datacenter_name&gt;/vm/&lt;folder_name&gt;/&lt;subfolder_name&gt;</b> .
<b>platform.vsphere.resourcePool</b>	Optional. The absolute path of an existing resource pool where the installer creates the virtual machines. If you do not specify a value, resources are installed in the root of the cluster <b>/&lt;datacenter_name&gt;/host/&lt;cluster_name&gt;/Resources</b> .	String, for example, <b>/&lt;datacenter_name&gt;/host/&lt;cluster_name&gt;/Resources/&lt;resource_pool_name&gt;/&lt;optional_nested_resource_pool_name&gt;</b> .
<b>platform.vsphere.network</b>	The network in the vCenter instance that contains the virtual IP addresses and DNS records that you configured.	String
<b>platform.vsphere.cluster</b>	The vCenter cluster to install the OpenShift Container Platform cluster in.	String
<b>platform.vsphere.apiVIP</b>	The virtual IP (VIP) address that you configured for control plane API access.	An IP address, for example <b>128.0.0.1</b> .
<b>platform.vsphere.ingressVIP</b>	The virtual IP (VIP) address that you configured for cluster ingress.	An IP address, for example <b>128.0.0.1</b> .
<b>platform.vsphere.diskType</b>	Optional. The disk provisioning method. This value defaults to the vSphere default storage policy if not set.	Valid values are <b>thin</b> , <b>thick</b> , or <b>eagerZeroedThick</b> .

#### 21.3.11.1.5. Optional VMware vSphere machine pool configuration parameters

Optional VMware vSphere machine pool configuration parameters are described in the following table:

**Table 21.19. Optional VMware vSphere machine pool parameters**

Parameter	Description	Values
<b>platform.vsphere.clusterOSImage</b>	The location from which the installer downloads the RHCOS image. You must set this parameter to perform an installation in a restricted network.	An HTTP or HTTPS URL, optionally with a SHA-256 checksum. For example, <b>https://mirror.openshift.com/images/rhcos-&lt;version&gt;-vmware.&lt;architecture&gt;.ova.</b>
<b>platform.vsphere.osDisk.diskSizeGB</b>	The size of the disk in gigabytes.	Integer
<b>platform.vsphere.cpus</b>	The total number of virtual processor cores to assign a virtual machine. The value of <b>platform.vsphere.cpus</b> must be a multiple of <b>platform.vsphere.coresPerSocket</b> value.	Integer
<b>platform.vsphere.coresPerSocket</b>	The number of cores per socket in a virtual machine. The number of virtual sockets on the virtual machine is <b>platform.vsphere.cpus/platform.vsphere.coresPerSocket</b> . The default value for control plane nodes and worker nodes is <b>4</b> and <b>2</b> , respectively.	Integer
<b>platform.vsphere.memoryMB</b>	The size of a virtual machine's memory in megabytes.	Integer

### 21.3.11.2. Sample install-config.yaml file for an installer-provisioned VMware vSphere cluster

You can customize the install-config.yaml file to specify more details about your OpenShift Container Platform cluster's platform or modify the values of the required parameters.

```

apiVersion: v1
baseDomain: example.com ❶
compute: ❷
- hyperthreading: Enabled ❸
  name: worker
  replicas: 3
  platform:
    vsphere: ❹
      cpus: 2
      coresPerSocket: 2
      memoryMB: 8192

```

```

    osDisk:
      diskSizeGB: 120
controlPlane: 5
  hyperthreading: Enabled 6
  name: master
  replicas: 3
  platform:
    vsphere: 7
      cpus: 4
      coresPerSocket: 2
      memoryMB: 16384
      osDisk:
        diskSizeGB: 120
metadata:
  name: cluster 8
platform:
  vsphere:
    vcenter: your.vcenter.server
    username: username
    password: password
    datacenter: datacenter
    defaultDatastore: datastore
    folder: folder
    resourcePool: resource_pool 9
    diskType: thin 10
    network: VM_Network
    cluster: vsphere_cluster_name 11
    apiVIP: api_vip
    ingressVIP: ingress_vip
fips: false
pullSecret: '{"auths": ...}'
sshKey: 'ssh-ed25519 AAAA...'

```

- 1 The base domain of the cluster. All DNS records must be sub-domains of this base and include the cluster name.
- 2 5 The **controlPlane** section is a single mapping, but the **compute** section is a sequence of mappings. To meet the requirements of the different data structures, the first line of the **compute** section must begin with a hyphen, -, and the first line of the **controlPlane** section must not. Only one control plane pool is used.
- 3 6 Whether to enable or disable simultaneous multithreading, or **hyperthreading**. By default, simultaneous multithreading is enabled to increase the performance of your machines' cores. You can disable it by setting the parameter value to **Disabled**. If you disable simultaneous multithreading in some cluster machines, you must disable it in all cluster machines.



### IMPORTANT

If you disable simultaneous multithreading, ensure that your capacity planning accounts for the dramatically decreased machine performance. Your machines must use at least 8 CPUs and 32 GB of RAM if you disable simultaneous multithreading.

- 4 7 Optional: Provide additional configuration for the machine pool parameters for the compute and control plane machines.

- 8 The cluster name that you specified in your DNS records.
- 9 Optional: Provide an existing resource pool for machine creation. If you do not specify a value, the installation program uses the root resource pool of the vSphere cluster.
- 10 The vSphere disk provisioning method.
- 11 The vSphere cluster to install the OpenShift Container Platform cluster in.

### 21.3.11.3. Configuring the cluster-wide proxy during installation

Production environments can deny direct access to the internet and instead have an HTTP or HTTPS proxy available. You can configure a new OpenShift Container Platform cluster to use a proxy by configuring the proxy settings in the **install-config.yaml** file.

#### Prerequisites

- You have an existing **install-config.yaml** file.
- You reviewed the sites that your cluster requires access to and determined whether any of them need to bypass the proxy. By default, all cluster egress traffic is proxied, including calls to hosting cloud provider APIs. You added sites to the **Proxy** object's **spec.noProxy** field to bypass the proxy if necessary.

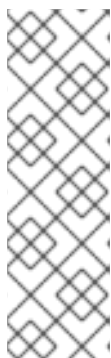

#### NOTE

The **Proxy** object **status.noProxy** field is populated with the values of the **networking.machineNetwork[].cidr**, **networking.clusterNetwork[].cidr**, and **networking.serviceNetwork[]** fields from your installation configuration.

For installations on Amazon Web Services (AWS), Google Cloud Platform (GCP), Microsoft Azure, and Red Hat OpenStack Platform (RHOSP), the **Proxy** object **status.noProxy** field is also populated with the instance metadata endpoint (**169.254.169.254**).

#### Procedure

1. Edit your **install-config.yaml** file and add the proxy settings. For example:

```
apiVersion: v1
baseDomain: my.domain.com
proxy:
  httpProxy: http://<username>:<pswd>@<ip>:<port> 1
  httpsProxy: https://<username>:<pswd>@<ip>:<port> 2
  noProxy: example.com 3
  additionalTrustBundle: | 4
    -----BEGIN CERTIFICATE-----
    <MY_TRUSTED_CA_CERT>
    -----END CERTIFICATE-----
  ...
```

- 1 A proxy URL to use for creating HTTP connections outside the cluster. The URL scheme must be **http**.

- 2 A proxy URL to use for creating HTTPS connections outside the cluster.
- 3 A comma-separated list of destination domain names, IP addresses, or other network CIDRs to exclude from proxying. Preface a domain with `.` to match subdomains only. For example, `.y.com` matches `x.y.com`, but not `y.com`. Use `*` to bypass the proxy for all destinations. You must include vCenter's IP address and the IP range that you use for its machines.
- 4 If provided, the installation program generates a config map that is named **user-ca-bundle** in the **openshift-config** namespace that contains one or more additional CA certificates that are required for proxying HTTPS connections. The Cluster Network Operator then creates a **trusted-ca-bundle** config map that merges these contents with the Red Hat Enterprise Linux CoreOS (RHCOS) trust bundle, and this config map is referenced in the **trustedCA** field of the **Proxy** object. The **additionalTrustBundle** field is required unless the proxy's identity certificate is signed by an authority from the RHCOS trust bundle.

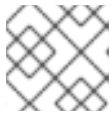
**NOTE**

The installation program does not support the proxy **readinessEndpoints** field.

**NOTE**

If the installer times out, restart and then complete the deployment by using the **wait-for** command of the installer. For example:

```
$ ./openshift-install wait-for install-complete --log-level debug
```

2. Save the file and reference it when installing OpenShift Container Platform.

The installation program creates a cluster-wide proxy that is named **cluster** that uses the proxy settings in the provided **install-config.yaml** file. If no proxy settings are provided, a **cluster Proxy** object is still created, but it will have a nil **spec**.

**NOTE**

Only the **Proxy** object named **cluster** is supported, and no additional proxies can be created.

### 21.3.12. Deploying the cluster

You can install OpenShift Container Platform on a compatible cloud platform.

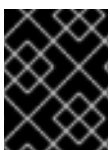
**IMPORTANT**

You can run the **create cluster** command of the installation program only once, during initial installation.

#### Prerequisites

- Configure an account with the cloud platform that hosts your cluster.

- Obtain the OpenShift Container Platform installation program and the pull secret for your cluster.

## Procedure

1. Change to the directory that contains the installation program and initialize the cluster deployment:

```
$ ./openshift-install create cluster --dir <installation_directory> \ 1
--log-level=info 2
```

- 1 For **<installation\_directory>**, specify the location of your customized **./install-config.yaml** file.
- 2 To view different installation details, specify **warn**, **debug**, or **error** instead of **info**.

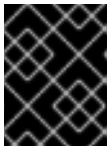

### IMPORTANT

Use the **openshift-install** command from the bastion hosted in the VMC environment.



### NOTE

If the cloud provider account that you configured on your host does not have sufficient permissions to deploy the cluster, the installation process stops, and the missing permissions are displayed.

When the cluster deployment completes, directions for accessing your cluster, including a link to its web console and credentials for the **kubeadmin** user, display in your terminal.

## Example output

```
...
INFO Install complete!
INFO To access the cluster as the system:admin user when using 'oc', run 'export
KUBECONFIG=/home/myuser/install_dir/auth/kubeconfig'
INFO Access the OpenShift web-console here: https://console-openshift-
console.apps.mycluster.example.com
INFO Login to the console with user: "kubeadmin", and password: "4vYBz-Ee6gm-ymBZj-
Wt5AL"
INFO Time elapsed: 36m22s
```



### NOTE

The cluster access and credential information also outputs to **<installation\_directory>/openshift\_install.log** when an installation succeeds.



### IMPORTANT

- The Ignition config files that the installation program generates contain certificates that expire after 24 hours, which are then renewed at that time. If the cluster is shut down before renewing the certificates and the cluster is later restarted after the 24 hours have elapsed, the cluster automatically recovers the expired certificates. The exception is that you must manually approve the pending **node-bootstrapper** certificate signing requests (CSRs) to recover kubelet certificates. See the documentation for *Recovering from expired control plane certificates* for more information.
- It is recommended that you use Ignition config files within 12 hours after they are generated because the 24-hour certificate rotates from 16 to 22 hours after the cluster is installed. By using the Ignition config files within 12 hours, you can avoid installation failure if the certificate update runs during installation.

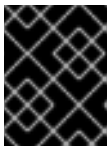

### IMPORTANT

You must not delete the installation program or the files that the installation program creates. Both are required to delete the cluster.

### 21.3.13. Installing the OpenShift CLI by downloading the binary

You can install the OpenShift CLI (**oc**) to interact with OpenShift Container Platform from a command-line interface. You can install **oc** on Linux, Windows, or macOS.

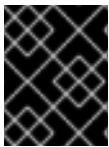

### IMPORTANT

If you installed an earlier version of **oc**, you cannot use it to complete all of the commands in OpenShift Container Platform 4.10. Download and install the new version of **oc**.

#### Installing the OpenShift CLI on Linux

You can install the OpenShift CLI (**oc**) binary on Linux by using the following procedure.

#### Procedure

1. Navigate to the [OpenShift Container Platform downloads page](#) on the Red Hat Customer Portal.
2. Select the appropriate version in the **Version** drop-down menu.
3. Click **Download Now** next to the **OpenShift v4.10 Linux Client** entry and save the file.
4. Unpack the archive:

```
$ tar xvf <file>
```

5. Place the **oc** binary in a directory that is on your **PATH**. To check your **PATH**, execute the following command:

```
$ echo $PATH
```

After you install the OpenShift CLI, it is available using the **oc** command:

```
$ oc <command>
```

### Installing the OpenShift CLI on Windows

You can install the OpenShift CLI (**oc**) binary on Windows by using the following procedure.

#### Procedure

1. Navigate to the [OpenShift Container Platform downloads page](#) on the Red Hat Customer Portal.
2. Select the appropriate version in the **Version** drop-down menu.
3. Click **Download Now** next to the **OpenShift v4.10 Windows Client** entry and save the file.
4. Unzip the archive with a ZIP program.
5. Move the **oc** binary to a directory that is on your **PATH**.  
To check your **PATH**, open the command prompt and execute the following command:

```
C:\> path
```

After you install the OpenShift CLI, it is available using the **oc** command:

```
C:\> oc <command>
```

### Installing the OpenShift CLI on macOS

You can install the OpenShift CLI (**oc**) binary on macOS by using the following procedure.

#### Procedure

1. Navigate to the [OpenShift Container Platform downloads page](#) on the Red Hat Customer Portal.
2. Select the appropriate version in the **Version** drop-down menu.
3. Click **Download Now** next to the **OpenShift v4.10 MacOSX Client** entry and save the file.
4. Unpack and unzip the archive.
5. Move the **oc** binary to a directory on your **PATH**.  
To check your **PATH**, open a terminal and execute the following command:

```
$ echo $PATH
```

After you install the OpenShift CLI, it is available using the **oc** command:

```
$ oc <command>
```

### 21.3.14. Logging in to the cluster by using the CLI

You can log in to your cluster as a default system user by exporting the cluster **kubeconfig** file. The **kubeconfig** file contains information about the cluster that is used by the CLI to connect a client to the correct cluster and API server. The file is specific to a cluster and is created during OpenShift Container



Platform installation.

### Prerequisites

- You deployed an OpenShift Container Platform cluster.
- You installed the **oc** CLI.

### Procedure

1. Export the **kubeadmin** credentials:

```
$ export KUBECONFIG=<installation_directory>/auth/kubeconfig 1
```

- 1** For **<installation\_directory>**, specify the path to the directory that you stored the installation files in.

2. Verify you can run **oc** commands successfully using the exported configuration:

```
$ oc whoami
```

#### Example output

```
system:admin
```

## 21.3.15. Creating registry storage

After you install the cluster, you must create storage for the Registry Operator.

### 21.3.15.1. Image registry removed during installation

On platforms that do not provide shareable object storage, the OpenShift Image Registry Operator bootstraps itself as **Removed**. This allows **openshift-installer** to complete installations on these platform types.

After installation, you must edit the Image Registry Operator configuration to switch the **managementState** from **Removed** to **Managed**.

### 21.3.15.2. Image registry storage configuration

The Image Registry Operator is not initially available for platforms that do not provide default storage. After installation, you must configure your registry to use storage so that the Registry Operator is made available.

Instructions are shown for configuring a persistent volume, which is required for production clusters. Where applicable, instructions are shown for configuring an empty directory as the storage location, which is available for only non-production clusters.

Additional instructions are provided for allowing the image registry to use block storage types by using the **Recreate** rollout strategy during upgrades.

#### 21.3.15.2.1. Configuring registry storage for VMware vSphere

As a cluster administrator, following installation you must configure your registry to use storage.

## Prerequisites

- Cluster administrator permissions.
- A cluster on VMware vSphere.
- Persistent storage provisioned for your cluster, such as Red Hat OpenShift Data Foundation.



### IMPORTANT

OpenShift Container Platform supports **ReadWriteOnce** access for image registry storage when you have only one replica. **ReadWriteOnce** access also requires that the registry uses the **Recreate** rollout strategy. To deploy an image registry that supports high availability with two or more replicas, **ReadWriteMany** access is required.

- Must have "100Gi" capacity.



### IMPORTANT

Testing shows issues with using the NFS server on RHEL as storage backend for core services. This includes the OpenShift Container Registry and Quay, Prometheus for monitoring storage, and Elasticsearch for logging storage. Therefore, using RHEL NFS to back PVs used by core services is not recommended.

Other NFS implementations on the marketplace might not have these issues. Contact the individual NFS implementation vendor for more information on any testing that was possibly completed against these OpenShift Container Platform core components.

## Procedure

1. To configure your registry to use storage, change the **spec.storage.pvc** in the **configs.imageregistry/cluster** resource.



### NOTE

When using shared storage, review your security settings to prevent outside access.

2. Verify that you do not have a registry pod:

```
$ oc get pod -n openshift-image-registry -l docker-registry=default
```

### Example output

```
No resources found in openshift-image-registry namespace
```

**NOTE**

If you do have a registry pod in your output, you do not need to continue with this procedure.

3. Check the registry configuration:

```
$ oc edit configs.imageregistry.operator.openshift.io
```

**Example output**

```
storage:
  pvc:
    claim: 1
```

- 1** Leave the **claim** field blank to allow the automatic creation of an **image-registry-storage** persistent volume claim (PVC). The PVC is generated based on the default storage class. However, be aware that the default storage class might provide ReadWriteOnce (RWO) volumes, such as a RADOS Block Device (RBD), which can cause issues when replicating to more than one replica.

4. Check the **clusteroperator** status:

```
$ oc get clusteroperator image-registry
```

**Example output**

NAME	VERSION	AVAILABLE	PROGRESSING	DEGRADED
image-registry	4.7	True	False	False

### 21.3.15.2.2. Configuring block registry storage for VMware vSphere

To allow the image registry to use block storage types such as vSphere Virtual Machine Disk (VMDK) during upgrades as a cluster administrator, you can use the **Recreate** rollout strategy.

**IMPORTANT**

Block storage volumes are supported but not recommended for use with image registry on production clusters. An installation where the registry is configured on block storage is not highly available because the registry cannot have more than one replica.

**Procedure**

1. To set the image registry storage as a block storage type, patch the registry so that it uses the **Recreate** rollout strategy and runs with only **1** replica:

```
$ oc patch config.imageregistry.operator.openshift.io/cluster --type=merge -p '{"spec": {"rolloutStrategy": "Recreate", "replicas": 1}}'
```

2. Provision the PV for the block storage device, and create a PVC for that volume. The requested block volume uses the ReadWriteOnce (RWO) access mode.
  - a. Create a **pvc.yaml** file with the following contents to define a VMware vSphere **PersistentVolumeClaim** object:

```
kind: PersistentVolumeClaim
apiVersion: v1
metadata:
  name: image-registry-storage ❶
  namespace: openshift-image-registry ❷
spec:
  accessModes:
  - ReadWriteOnce ❸
  resources:
    requests:
      storage: 100Gi ❹
```

- ❶ A unique name that represents the **PersistentVolumeClaim** object.
- ❷ The namespace for the **PersistentVolumeClaim** object, which is **openshift-image-registry**.
- ❸ The access mode of the persistent volume claim. With **ReadWriteOnce**, the volume can be mounted with read and write permissions by a single node.
- ❹ The size of the persistent volume claim.

- b. Create the **PersistentVolumeClaim** object from the file:

```
$ oc create -f pvc.yaml -n openshift-image-registry
```

3. Edit the registry configuration so that it references the correct PVC:

```
$ oc edit config.imageregistry.operator.openshift.io -o yaml
```

### Example output

```
storage:
  pvc:
    claim: ❶
```

- ❶ Creating a custom PVC allows you to leave the **claim** field blank for the default automatic creation of an **image-registry-storage** PVC.

For instructions about configuring registry storage so that it references the correct PVC, see [Configuring the registry for vSphere](#).

## 21.3.16. Backing up VMware vSphere volumes

OpenShift Container Platform provisions new volumes as independent persistent disks to freely attach and detach the volume on any node in the cluster. As a consequence, it is not possible to back up

volumes that use snapshots, or to restore volumes from snapshots. See [Snapshot Limitations](#) for more information.

## Procedure

To create a backup of persistent volumes:

1. Stop the application that is using the persistent volume.
2. Clone the persistent volume.
3. Restart the application.
4. Create a backup of the cloned volume.
5. Delete the cloned volume.

### 21.3.17. Telemetry access for OpenShift Container Platform

In OpenShift Container Platform 4.10, the Telemetry service, which runs by default to provide metrics about cluster health and the success of updates, requires internet access. If your cluster is connected to the internet, Telemetry runs automatically, and your cluster is registered to [OpenShift Cluster Manager](#).

After you confirm that your [OpenShift Cluster Manager](#) inventory is correct, either maintained automatically by Telemetry or manually by using OpenShift Cluster Manager, [use subscription watch](#) to track your OpenShift Container Platform subscriptions at the account or multi-cluster level.

#### Additional resources

- See [About remote health monitoring](#) for more information about the Telemetry service

### 21.3.18. Next steps

- [Customize your cluster](#).
- If necessary, you can [opt out of remote health reporting](#) .
- [Set up your registry and configure registry storage](#) .
- Optional: [View the events from the vSphere Problem Detector Operator](#) to determine if the cluster has permission or storage configuration issues.

## 21.4. INSTALLING A CLUSTER ON VMC WITH NETWORK CUSTOMIZATIONS

In OpenShift Container Platform version 4.10, you can install a cluster on your VMware vSphere instance using installer-provisioned infrastructure with customized network configuration options by deploying it to [VMware Cloud \(VMC\) on AWS](#).

Once you configure your VMC environment for OpenShift Container Platform deployment, you use the OpenShift Container Platform installation program from the bastion management host, co-located in the VMC environment. The installation program and control plane automates the process of deploying and managing the resources needed for the OpenShift Container Platform cluster.

By customizing your OpenShift Container Platform network configuration, your cluster can coexist with

existing IP address allocations in your environment and integrate with existing VXLAN configurations. To customize the installation, you modify parameters in the **install-config.yaml** file before you install the cluster. You must set most of the network configuration parameters during installation, and you can modify only **kubeProxy** configuration parameters in a running cluster.



## NOTE

OpenShift Container Platform supports deploying a cluster to a single VMware vCenter only. Deploying a cluster with machines/machine sets on multiple vCenters is not supported.

### 21.4.1. Setting up VMC for vSphere

You can install OpenShift Container Platform on VMware Cloud (VMC) on AWS hosted vSphere clusters to enable applications to be deployed and managed both on-premise and off-premise, across the hybrid cloud.

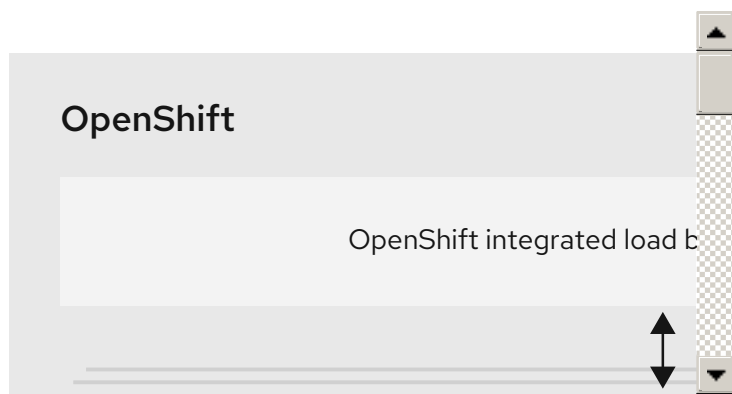

You must configure several options in your VMC environment prior to installing OpenShift Container Platform on VMware vSphere. Ensure your VMC environment has the following prerequisites:

- Create a non-exclusive, DHCP-enabled, NSX-T network segment and subnet. Other virtual machines (VMs) can be hosted on the subnet, but at least eight IP addresses must be available for the OpenShift Container Platform deployment.
- Allocate two IP addresses, outside the DHCP range, and configure them with reverse DNS records.
  - A DNS record for **api.<cluster\_name>.<base\_domain>** pointing to the allocated IP address.
  - A DNS record for **\*.apps.<cluster\_name>.<base\_domain>** pointing to the allocated IP address.
- Configure the following firewall rules:
  - An ANY:ANY firewall rule between the OpenShift Container Platform compute network and the internet. This is used by nodes and applications to download container images.
  - An ANY:ANY firewall rule between the installation host and the software-defined data center (SDDC) management network on port 443. This allows you to upload the Red Hat Enterprise Linux CoreOS (RHCOS) OVA during deployment.
  - An HTTPS firewall rule between the OpenShift Container Platform compute network and vCenter. This connection allows OpenShift Container Platform to communicate with

vCenter for provisioning and managing nodes, persistent volume claims (PVCs), and other resources.

- You must have the following information to deploy OpenShift Container Platform:
  - The OpenShift Container Platform cluster name, such as **vmc-prod-1**.
  - The base DNS name, such as **companyname.com**.
  - If not using the default, the pod network CIDR and services network CIDR must be identified, which are set by default to **10.128.0.0/14** and **172.30.0.0/16**, respectively. These CIDRs are used for pod-to-pod and pod-to-service communication and are not accessible externally; however, they must not overlap with existing subnets in your organization.
  - The following vCenter information:
    - vCenter hostname, username, and password
    - Datacenter name, such as **SDDC-Datacenter**
    - Cluster name, such as **Cluster-1**
    - Network name
    - Datastore name, such as **WorkloadDatastore**



#### NOTE

It is recommended to move your vSphere cluster to the VMC **Compute-ResourcePool** resource pool after your cluster installation is finished.

- A Linux-based host deployed to VMC as a bastion.
  - The bastion host can be Red Hat Enterprise Linux (RHEL) or any another Linux-based host; it must have internet connectivity and the ability to upload an OVA to the ESXi hosts.
  - Download and install the OpenShift CLI tools to the bastion host.
    - The **openshift-install** installation program
    - The OpenShift CLI (**oc**) tool



#### NOTE

You cannot use the VMware NSX Container Plugin for Kubernetes (NCP), and NSX is not used as the OpenShift SDN. The version of NSX currently available with VMC is incompatible with the version of NCP certified with OpenShift Container Platform.

However, the NSX DHCP service is used for virtual machine IP management with the full-stack automated OpenShift Container Platform deployment and with nodes provisioned, either manually or automatically, by the Machine API integration with vSphere. Additionally, NSX firewall rules are created to enable access with the OpenShift Container Platform cluster and between the bastion host and the VMC vSphere hosts.

### 21.4.1.1. VMC Sizer tool

VMware Cloud on AWS is built on top of AWS bare metal infrastructure; this is the same bare metal infrastructure which runs AWS native services. When a VMware cloud on AWS software-defined data center (SDDC) is deployed, you consume these physical server nodes and run the VMware ESXi hypervisor in a single tenant fashion. This means the physical infrastructure is not accessible to anyone else using VMC. It is important to consider how many physical hosts you will need to host your virtual infrastructure.

To determine this, VMware provides the [VMC on AWS Sizer](#). With this tool, you can define the resources you intend to host on VMC:

- Types of workloads
- Total number of virtual machines
- Specification information such as:
  - Storage requirements
  - vCPUs
  - vRAM
  - Overcommit ratios

With these details, the sizer tool can generate a report, based on VMware best practices, and recommend your cluster configuration and the number of hosts you will need.

### 21.4.2. vSphere prerequisites

- You reviewed details about the [OpenShift Container Platform installation and update](#) processes.
- You read the documentation on [selecting a cluster installation method and preparing it for users](#).
- You provisioned [block registry storage](#). For more information on persistent storage, see [Understanding persistent storage](#).
- If you use a firewall, you [configured it to allow the sites](#) that your cluster requires access to.



#### NOTE

Be sure to also review this site list if you are configuring a proxy.

### 21.4.3. Internet access for OpenShift Container Platform

In OpenShift Container Platform 4.10, you require access to the internet to install your cluster.

You must have internet access to:

- Access [OpenShift Cluster Manager](#) to download the installation program and perform subscription management. If the cluster has internet access and you do not disable Telemetry, that service automatically entitles your cluster.
- Access [Quay.io](#) to obtain the packages that are required to install your cluster.



- Obtain the packages that are required to perform cluster updates.



### IMPORTANT

If your cluster cannot have direct internet access, you can perform a restricted network installation on some types of infrastructure that you provision. During that process, you download the required content and use it to populate a mirror registry with the installation packages. With some installation types, the environment that you install your cluster in will not require internet access. Before you update the cluster, you update the content of the mirror registry.

## 21.4.4. VMware vSphere infrastructure requirements

You must install the OpenShift Container Platform cluster on a VMware vSphere version 7 instance that meets the requirements for the components that you use.



### NOTE

OpenShift Container Platform version 4.10 does not support VMware vSphere version 8.0.

You can host the VMware vSphere infrastructure on-premise or on a [VMware Cloud Verified provider](#) that meets the requirements outlined in the following table:

**Table 21.20. Version requirements for vSphere virtual environments**

Virtual environment product	Required version
VM hardware version	15 or later
vSphere ESXi hosts	7
vCenter host	7



### IMPORTANT

Installing a cluster on VMware vSphere version 7.0 Update 1 is now deprecated. These versions are still fully supported, but version 4.10 of OpenShift Container Platform requires vSphere virtual hardware version 15 or later. Hardware version 15 is now the default for vSphere virtual machines in OpenShift Container Platform. To update the hardware version for your vSphere nodes, see the "Updating hardware on nodes running in vSphere" article.

If your vSphere nodes are below hardware version 15 or your VMware vSphere version is earlier than 6.7U3, upgrading from OpenShift Container Platform 4.10 to OpenShift Container Platform 4.11 is not available.

**Table 21.21. Minimum supported vSphere version for VMware components**

Component	Minimum supported versions	Description
Hypervisor	vSphere 7 with HW version 15	This version is the minimum version that Red Hat Enterprise Linux CoreOS (RHCOS) supports. For more information about supported hardware on the latest version of Red Hat Enterprise Linux (RHEL) that is compatible with RHCOS, see <a href="#">Hardware</a> on the Red Hat Customer Portal.
Storage with in-tree drivers	vSphere 7	This plugin creates vSphere storage by using the in-tree storage drivers for vSphere included in OpenShift Container Platform.

If you use a vSphere version 6.5 instance, upgrade to 7.0 before you install OpenShift Container Platform.

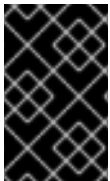

### IMPORTANT

You must ensure that the time on your ESXi hosts is synchronized before you install OpenShift Container Platform. See [Edit Time Configuration for a Host](#) in the VMware documentation.

## 21.4.5. Network connectivity requirements

You must configure the network connectivity between machines to allow OpenShift Container Platform cluster components to communicate.

Review the following details about the required network ports.

**Table 21.22. Ports used for all-machine to all-machine communications**

Protocol	Port	Description
ICMP	N/A	Network reachability tests
TCP	<b>1936</b>	Metrics
	<b>9000-9999</b>	Host level services, including the node exporter on ports <b>9100-9101</b> and the Cluster Version Operator on port <b>9099</b> .
	<b>10250-10259</b>	The default ports that Kubernetes reserves
	<b>10256</b>	openshift-sdn

Protocol	Port	Description
UDP	<b>4789</b>	virtual extensible LAN (VXLAN)
	<b>6081</b>	Geneve
	<b>9000-9999</b>	Host level services, including the node exporter on ports <b>9100-9101</b> .
	<b>500</b>	IPsec IKE packets
	<b>4500</b>	IPsec NAT-T packets
TCP/UDP	<b>30000-32767</b>	Kubernetes node port
ESP	N/A	IPsec Encapsulating Security Payload (ESP)

**Table 21.23. Ports used for all-machine to control plane communications**

Protocol	Port	Description
TCP	<b>6443</b>	Kubernetes API

**Table 21.24. Ports used for control plane machine to control plane machine communications**

Protocol	Port	Description
TCP	<b>2379-2380</b>	etcd server and peer ports

### 21.4.6. VMware vSphere CSI Driver Operator requirements

To install the vSphere CSI Driver Operator, the following requirements must be met:

- VMware vSphere version 6.7U3 or later
- Virtual machines of hardware version 15 or later
- No third-party vSphere CSI driver already installed in the cluster



## IMPORTANT

If a third-party vSphere CSI driver is present in the cluster, OpenShift Container Platform does not overwrite it. If you continue with the third-party vSphere CSI driver when upgrading to the next major version of OpenShift Container Platform, the **oc** CLI prompts you with the following message:

```
VSphereCSIDriverOperatorCRUpgradeable: VMwareVSphereControllerUpgradeable:
found existing unsupported csi.vsphere.vmware.com driver
```

The previous message informs you that Red Hat does not support the third-party vSphere CSI driver during an OpenShift Container Platform upgrade operation. You can choose to ignore this message and continue with the upgrade operation.

### Additional resources

- To remove a third-party CSI driver, see [Removing a third-party vSphere CSI Driver](#) .
- To update the hardware version for your vSphere nodes, see [Updating hardware on nodes running in vSphere](#).

## 21.4.7. vCenter requirements

Before you install an OpenShift Container Platform cluster on your vCenter that uses infrastructure that the installer provisions, you must prepare your environment.

### Required vCenter account privileges

To install an OpenShift Container Platform cluster in a vCenter, the installation program requires access to an account with privileges to read and create the required resources. Using an account that has global administrative privileges is the simplest way to access all of the necessary permissions.

If you cannot use an account with global administrative privileges, you must create roles to grant the privileges necessary for OpenShift Container Platform cluster installation. While most of the privileges are always required, some are required only if you plan for the installation program to provision a folder to contain the OpenShift Container Platform cluster on your vCenter instance, which is the default behavior. You must create or amend vSphere roles for the specified objects to grant the required privileges.

An additional role is required if the installation program is to create a vSphere virtual machine folder.

### Example 21.7. Roles and privileges required for installation in vSphere API

vSphere object for role	When required	Required privileges in vSphere API
-------------------------	---------------	------------------------------------

vSphere object for role	When required	Required privileges in vSphere API
vSphere vCenter	Always	<b>Cns.Searchable</b> <b>InventoryService.Tagging.AttachTag</b> <b>InventoryService.Tagging.CreateCategory</b> <b>InventoryService.Tagging.CreateTag</b> <b>InventoryService.Tagging.DeleteCategory</b> <b>InventoryService.Tagging.DeleteTag</b> <b>InventoryService.Tagging.EditCategory</b> <b>InventoryService.Tagging.EditTag</b> <b>Sessions.ValidateSession</b> <b>StorageProfile.Update</b> <b>StorageProfile.View</b>
vSphere vCenter Cluster	If VMs will be created in the cluster root	<b>Host.Config.StorageResource.AssignVMToPool</b> <b>VApp.AssignResourcePool</b> <b>VApp.Import</b> <b>VirtualMachine.Config.AddNewDisk</b>
vSphere vCenter Resource Pool	If an existing resource pool is provided	<b>Host.Config.StorageResource.AssignVMToPool</b> <b>VApp.AssignResourcePool</b> <b>VApp.Import</b> <b>VirtualMachine.Config.AddNewDisk</b>
vSphere Datastore	Always	<b>Datastore.AllocateSpace</b> <b>Datastore.Browse</b> <b>Datastore.FileManagement</b> <b>InventoryService.Tagging.ObjectAttachable</b>
vSphere Port Group	Always	<b>Network.Assign</b>
Virtual Machine Folder	Always	<b>InventoryService.Tagging.ObjectAttachable</b> <b>Resource.AssignVMToPool</b> <b>VApp.Import</b> <b>VirtualMachine.Config.AddExistingDisk</b> <b>VirtualMachine.Config.AddNewDisk</b> <b>VirtualMachine.Config.Add</b>

vSphere object for role	When required	RemoveDevice Required privileges in vSphere API VirtualMachine.Config.AdvancedConfig
		VirtualMachine.Config.Annotation VirtualMachine.Config.CPUCount VirtualMachine.Config.DiskExtend VirtualMachine.Config.DiskLease VirtualMachine.Config.EditDevice VirtualMachine.Config.Memory VirtualMachine.Config.RemoveDisk VirtualMachine.Config.Rename VirtualMachine.Config.ResetGuestInfo VirtualMachine.Config.Resource VirtualMachine.Config.Settings VirtualMachine.Config.UpgradeVirtualHardware VirtualMachine.Interact.GuestControl VirtualMachine.Interact.PowerOff VirtualMachine.Interact.PowerOn VirtualMachine.Interact.Reset VirtualMachine.Inventory.Create VirtualMachine.Inventory.CreateFromExisting VirtualMachine.Inventory.Delete VirtualMachine.Provisioning.Clone VirtualMachine.Provisioning.MarkAsTemplate VirtualMachine.Provisioning.DeployTemplate
vSphere vCenter Datacenter	If the installation program creates the virtual machine folder	InventoryService.Tagging.ObjectAttachable Resource.AssignVMToPool VApp.Import VirtualMachine.Config.AddExistingDisk VirtualMachine.Config.AddNewDisk

vSphere object for role	When required	Required privileges in vSphere API
		<b>VirtualMachine.Config.AddRemoveDevice</b> <b>VirtualMachine.Config.AdvancedConfig</b> <b>VirtualMachine.Config.Annotation</b> <b>VirtualMachine.Config.CPUCount</b> <b>VirtualMachine.Config.DiskExtend</b> <b>VirtualMachine.Config.DiskLease</b> <b>VirtualMachine.Config.EditDevice</b> <b>VirtualMachine.Config.Memory</b> <b>VirtualMachine.Config.RemoveDisk</b> <b>VirtualMachine.Config.Rename</b> <b>VirtualMachine.Config.ResetGuestInfo</b> <b>VirtualMachine.Config.Resource</b> <b>VirtualMachine.Config.Settings</b> <b>VirtualMachine.Config.UpgradeVirtualHardware</b> <b>VirtualMachine.Interact.GuestControl</b> <b>VirtualMachine.Interact.PowerOff</b> <b>VirtualMachine.Interact.PowerOn</b> <b>VirtualMachine.Interact.Reset</b> <b>VirtualMachine.Inventory.Create</b> <b>VirtualMachine.Inventory.CreateFromExisting</b> <b>VirtualMachine.Inventory.Delete</b> <b>VirtualMachine.Provisioning.Clone</b> <b>VirtualMachine.Provisioning.DeployTemplate</b> <b>VirtualMachine.Provisioning.MarkAsTemplate</b> <b>Folder.Create</b> <b>Folder.Delete</b>

Example 21.8. Roles and privileges required for installation in vCenter graphical user interface (GUI)

vSphere object for role	When required	Required privileges in vCenter GUI
vSphere vCenter	Always	<b>Cns.Searchable</b> <b>"vSphere Tagging"."Assign or Unassign vSphere Tag"</b> <b>"vSphere Tagging"."Create vSphere Tag Category"</b> <b>"vSphere Tagging"."Create vSphere Tag"</b> <b>vSphere Tagging"."Delete vSphere Tag Category"</b> <b>"vSphere Tagging"."Delete vSphere Tag"</b> <b>"vSphere Tagging"."Edit vSphere Tag Category"</b> <b>"vSphere Tagging"."Edit vSphere Tag"</b> <b>Sessions."Validate session"</b> <b>"Profile-driven storage"."Profile-driven storage update"</b> <b>"Profile-driven storage"."Profile-driven storage view"</b>
vSphere vCenter Cluster	If VMs will be created in the cluster root	<b>Host.Configuration."Storage partition configuration" Resource."Assign virtual machine to resource pool"</b> <b>VApp."Assign resource pool"</b> <b>VApp.Import</b> <b>"Virtual machine"."Change Configuration"."Add new disk"</b>
vSphere vCenter Resource Pool	If an existing resource pool is provided	<b>Host.Configuration."Storage partition configuration" Resource."Assign virtual machine to resource pool"</b> <b>VApp."Assign resource pool"</b> <b>VApp.Import</b> <b>"Virtual machine"."Change Configuration"."Add new disk"</b>



vSphere object for role	When required	Required privileges in vCenter GUI
vSphere Datastore	Always	<b>Datastore."Allocate space"</b> <b>Datastore."Browse datastore"</b> <b>Datastore."Low level file operations"</b> <b>"vSphere Tagging"."Assign or Unassign vSphere Tag on Object"</b>
vSphere Port Group	Always	<b>Network."Assign network"</b>
Virtual Machine Folder	Always	<b>"vSphere Tagging"."Assign or Unassign vSphere Tag on Object"</b> <b>Resource."Assign virtual machine to resource pool"</b> <b>VApp.Import</b> <b>"Virtual machine"."Change Configuration"."Add existing disk"</b> <b>"Virtual machine"."Change Configuration"."Add new disk"</b> <b>"Virtual machine"."Change Configuration"."Add or remove device"</b> <b>"Virtual machine"."Change Configuration"."Advanced configuration"</b> <b>"Virtual machine"."Change Configuration"."Set annotation"</b> <b>"Virtual machine"."Change Configuration"."Change CPU count"</b> <b>"Virtual machine"."Change Configuration"."Extend virtual disk"</b> <b>"Virtual machine"."Change Configuration"."Acquire disk lease"</b> <b>"Virtual machine"."Change Configuration"."Modify device settings"</b> <b>"Virtual machine"."Change Configuration"."Change Memory"</b> <b>"Virtual machine"."Change Configuration"."Remove disk"</b> <b>"Virtual machine"."Change</b>

vSphere object for role	When required	Configuration".Rename Virtual machine".Change GUI Configuration".Reset guest information"
		"Virtual machine".Change Configuration".Change resource" "Virtual machine".Change Configuration".Change Settings" "Virtual machine".Change Configuration".Upgrade virtual machine compatibility" "Virtual machine".Interaction."Gues t operating system management by VIX API" "Virtual machine".Interaction."Powe r off" "Virtual machine".Interaction."Powe r on" "Virtual machine".Interaction.Reset "Virtual machine".Edit Inventory".Create new" "Virtual machine".Edit Inventory".Create from existing" "Virtual machine".Edit Inventory".Remove" "Virtual machine".Provisioning."Clo ne virtual machine" "Virtual machine".Provisioning."Mar k as template" "Virtual machine".Provisioning."De ploy template"
vSphere vCenter Datacenter	If the installation program creates the virtual machine folder	"vSphere Tagging".Assign or Unassign vSphere Tag on Object" Resource."Assign virtual machine to resource pool" VApp.Import "Virtual machine".Change Configuration".Add existing disk" "Virtual machine".Change Configuration".Add new disk"

vSphere object for role	When required	"Virtual machine". "Change Configuration". "Add or remove device"
		"Virtual machine". "Change Configuration". "Advanced configuration" "Virtual machine". "Change Configuration". "Set annotation" "Virtual machine". "Change Configuration". "Change CPU count" "Virtual machine". "Change Configuration". "Extend virtual disk" "Virtual machine". "Change Configuration". "Acquire disk lease" "Virtual machine". "Change Configuration". "Modify device settings" "Virtual machine". "Change Configuration". "Change Memory" "Virtual machine". "Change Configuration". "Remove disk" "Virtual machine". "Change Configuration". "Rename" "Virtual machine". "Change Configuration". "Reset guest information" "Virtual machine". "Change Configuration". "Change resource" "Virtual machine". "Change Configuration". "Change Settings" "Virtual machine". "Change Configuration". "Upgrade virtual machine compatibility" "Virtual machine". Interaction. "Guest operating system management by VIX API" "Virtual machine". Interaction. "Power off" "Virtual machine". Interaction. "Power on" "Virtual machine". Interaction. "Reset" "Virtual machine". "Edit Inventory". "Create new"

vSphere object for role	When required	"Virtual machine". "Edit Inventory". "Create from Existing"
		"Virtual machine". "Edit Inventory". "Remove" "Virtual machine". Provisioning. "Clone virtual machine" "Virtual machine". Provisioning. "Deploy template" "Virtual machine". Provisioning. "Mark as template" Folder. "Create folder" Folder. "Delete folder"

Additionally, the user requires some **ReadOnly** permissions, and some of the roles require permission to propagate the permissions to child objects. These settings vary depending on whether or not you install the cluster into an existing folder.

#### Example 21.9. Required permissions and propagation settings

vSphere object	When required	Propagate to children	Permissions required
vSphere vCenter	Always	False	Listed required privileges
vSphere vCenter Datacenter	Existing folder	False	<b>ReadOnly</b> permission
	Installation program creates the folder	True	Listed required privileges
vSphere vCenter Cluster	Existing resource pool	False	<b>ReadOnly</b> permission
	VMs in cluster root	True	Listed required privileges
vSphere vCenter Datastore	Always	False	Listed required privileges
vSphere Switch	Always	False	<b>ReadOnly</b> permission
vSphere Port Group	Always	False	Listed required privileges
vSphere vCenter Virtual Machine Folder	Existing folder	True	Listed required privileges

vSphere object	When required	Propagate to children	Permissions required
vSphere vCenter Resource Pool	Existing resource pool	True	Listed required privileges

For more information about creating an account with only the required privileges, see [vSphere Permissions and User Management Tasks](#) in the vSphere documentation.

### Using OpenShift Container Platform with vMotion

If you intend on using vMotion in your vSphere environment, consider the following before installing a OpenShift Container Platform cluster.

- OpenShift Container Platform generally supports compute-only vMotion. Using Storage vMotion can cause issues and is not supported.  
To help ensure the uptime of your compute and control plane nodes, it is recommended that you follow the VMware best practices for vMotion. It is also recommended to use VMware anti-affinity rules to improve the availability of OpenShift Container Platform during maintenance or hardware issues.

For more information about vMotion and anti-affinity rules, see the VMware vSphere documentation for [vMotion networking requirements](#) and [VM anti-affinity rules](#).

- If you are using vSphere volumes in your pods, migrating a VM across datastores either manually or through Storage vMotion causes, invalid references within OpenShift Container Platform persistent volume (PV) objects. These references prevent affected pods from starting up and can result in data loss.
- Similarly, OpenShift Container Platform does not support selective migration of VMDKs across datastores, using datastore clusters for VM provisioning or for dynamic or static provisioning of PVs, or using a datastore that is part of a datastore cluster for dynamic or static provisioning of PVs.

### Cluster resources

When you deploy an OpenShift Container Platform cluster that uses installer-provisioned infrastructure, the installation program must be able to create several resources in your vCenter instance.

A standard OpenShift Container Platform installation creates the following vCenter resources:

- 1 Folder
- 1 Tag category
- 1 Tag
- Virtual machines:
  - 1 template
  - 1 temporary bootstrap node
  - 3 control plane nodes
  - 3 compute machines

Although these resources use 856 GB of storage, the bootstrap node is destroyed during the cluster installation process. A minimum of 800 GB of storage is required to use a standard cluster.

If you deploy more compute machines, the OpenShift Container Platform cluster will use more storage.

### Cluster limits

Available resources vary between clusters. The number of possible clusters within a vCenter is limited primarily by available storage space and any limitations on the number of required resources. Be sure to consider both limitations to the vCenter resources that the cluster creates and the resources that you require to deploy a cluster, such as IP addresses and networks.

### Networking requirements

You must use the Dynamic Host Configuration Protocol (DHCP) for the network and ensure that the DHCP server is configured to provide persistent IP addresses to the cluster machines. In the DHCP lease, you must configure the DHCP to use the default gateway. All nodes must be in the same VLAN. You cannot scale the cluster using a second VLAN as a Day 2 operation. Additionally, you must create the following networking resources before you install the OpenShift Container Platform cluster:



#### NOTE

It is recommended that each OpenShift Container Platform node in the cluster must have access to a Network Time Protocol (NTP) server that is discoverable via DHCP. Installation is possible without an NTP server. However, asynchronous server clocks will cause errors, which NTP server prevents.

### Required IP Addresses

An installer-provisioned vSphere installation requires two static IP addresses:

- The **API** address is used to access the cluster API.
- The **Ingress** address is used for cluster ingress traffic.

You must provide these IP addresses to the installation program when you install the OpenShift Container Platform cluster.

### DNS records

You must create DNS records for two static IP addresses in the appropriate DNS server for the vCenter instance that hosts your OpenShift Container Platform cluster. In each record, **<cluster\_name>** is the cluster name and **<base\_domain>** is the cluster base domain that you specify when you install the cluster. A complete DNS record takes the form: **<component>.<cluster\_name>.<base\_domain>.**

Table 21.25. Required DNS records

Component	Record	Description
API VIP	<b>api.&lt;cluster_name&gt;.&lt;base_domain&gt;.</b>	This DNS A/AAAA or CNAME record must point to the load balancer for the control plane machines. This record must be resolvable by both clients external to the cluster and from all the nodes within the cluster.

Component	Record	Description
Ingress VIP	*.apps.<cluster_name>.<base_domain>.	A wildcard DNS A/AAAA or CNAME record that points to the load balancer that targets the machines that run the Ingress router pods, which are the worker nodes by default. This record must be resolvable by both clients external to the cluster and from all the nodes within the cluster.

### 21.4.8. Generating a key pair for cluster node SSH access

During an OpenShift Container Platform installation, you can provide an SSH public key to the installation program. The key is passed to the Red Hat Enterprise Linux CoreOS (RHCOS) nodes through their Ignition config files and is used to authenticate SSH access to the nodes. The key is added to the `~/.ssh/authorized_keys` list for the **core** user on each node, which enables password-less authentication.

After the key is passed to the nodes, you can use the key pair to SSH in to the RHCOS nodes as the user **core**. To access the nodes through SSH, the private key identity must be managed by SSH for your local user.

If you want to SSH in to your cluster nodes to perform installation debugging or disaster recovery, you must provide the SSH public key during the installation process. The `./openshift-install gather` command also requires the SSH public key to be in place on the cluster nodes.



#### IMPORTANT

Do not skip this procedure in production environments, where disaster recovery and debugging is required.



#### NOTE

You must use a local key, not one that you configured with platform-specific approaches such as [AWS key pairs](#).

#### Procedure

1. If you do not have an existing SSH key pair on your local machine to use for authentication onto your cluster nodes, create one. For example, on a computer that uses a Linux operating system, run the following command:

```
$ ssh-keygen -t ed25519 -N "" -f <path>/<file_name> 1
```

- 1 Specify the path and file name, such as `~/.ssh/id_ed25519`, of the new SSH key. If you have an existing key pair, ensure your public key is in the your `~/.ssh` directory.

**NOTE**

If you plan to install an OpenShift Container Platform cluster that uses FIPS validated or Modules In Process cryptographic libraries on the **x86\_64** architecture, do not create a key that uses the **ed25519** algorithm. Instead, create a key that uses the **rsa** or **ecdsa** algorithm.

2. View the public SSH key:

```
$ cat <path>/<file_name>.pub
```

For example, run the following to view the `~/.ssh/id_ed25519.pub` public key:

```
$ cat ~/.ssh/id_ed25519.pub
```

3. Add the SSH private key identity to the SSH agent for your local user, if it has not already been added. SSH agent management of the key is required for password-less SSH authentication onto your cluster nodes, or if you want to use the `./openshift-install gather` command.

**NOTE**

On some distributions, default SSH private key identities such as `~/.ssh/id_rsa` and `~/.ssh/id_dsa` are managed automatically.

- a. If the **ssh-agent** process is not already running for your local user, start it as a background task:

```
$ eval "$(ssh-agent -s)"
```

**Example output**

```
Agent pid 31874
```

**NOTE**

If your cluster is in FIPS mode, only use FIPS-compliant algorithms to generate the SSH key. The key must be either RSA or ECDSA.

4. Add your SSH private key to the **ssh-agent**:

```
$ ssh-add <path>/<file_name> 1
```

- 1** Specify the path and file name for your SSH private key, such as `~/.ssh/id_ed25519`

**Example output**

```
Identity added: /home/<you>/<path>/<file_name> (<computer_name>)
```

**Next steps**



- When you install OpenShift Container Platform, provide the SSH public key to the installation program.

### 21.4.9. Obtaining the installation program

Before you install OpenShift Container Platform, download the installation file on a local computer.

#### Prerequisites

- You have a computer that runs Linux or macOS, with 500 MB of local disk space

#### Procedure

1. Access the [Infrastructure Provider](#) page on the OpenShift Cluster Manager site. If you have a Red Hat account, log in with your credentials. If you do not, create an account.
2. Select your infrastructure provider.
3. Navigate to the page for your installation type, download the installation program that corresponds with your host operating system and architecture, and place the file in the directory where you will store the installation configuration files.



#### IMPORTANT

The installation program creates several files on the computer that you use to install your cluster. You must keep the installation program and the files that the installation program creates after you finish installing the cluster. Both files are required to delete the cluster.



#### IMPORTANT

Deleting the files created by the installation program does not remove your cluster, even if the cluster failed during installation. To remove your cluster, complete the OpenShift Container Platform uninstallation procedures for your specific cloud provider.

4. Extract the installation program. For example, on a computer that uses a Linux operating system, run the following command:

```
$ tar -xvf openshift-install-linux.tar.gz
```

5. Download your installation [pull secret from the Red Hat OpenShift Cluster Manager](#). This pull secret allows you to authenticate with the services that are provided by the included authorities, including Quay.io, which serves the container images for OpenShift Container Platform components.

### 21.4.10. Adding vCenter root CA certificates to your system trust

Because the installation program requires access to your vCenter's API, you must add your vCenter's trusted root CA certificates to your system trust before you install an OpenShift Container Platform cluster.

#### Procedure

1. From the vCenter home page, download the vCenter's root CA certificates. Click **Download trusted root CA certificates** in the vSphere Web Services SDK section. The **<vCenter>/certs/download.zip** file downloads.
2. Extract the compressed file that contains the vCenter root CA certificates. The contents of the compressed file resemble the following file structure:

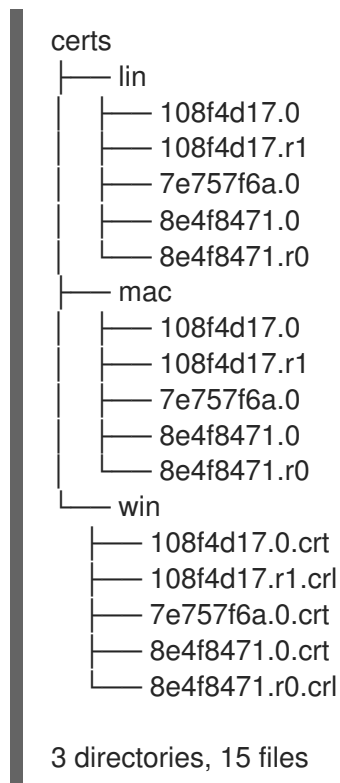

3. Add the files for your operating system to the system trust. For example, on a Fedora operating system, run the following command:

```
# cp certs/lin/* /etc/pki/ca-trust/source/anchors
```

4. Update your system trust. For example, on a Fedora operating system, run the following command:

```
# update-ca-trust extract
```

### 21.4.11. Creating the installation configuration file

You can customize the OpenShift Container Platform cluster you install on VMware vSphere.

#### Prerequisites

- Obtain the OpenShift Container Platform installation program and the pull secret for your cluster.
- Obtain service principal permissions at the subscription level.

#### Procedure

1. Create the **install-config.yaml** file.
  - a. Change to the directory that contains the installation program and run the following

command:

```
$. /openshift-install create install-config --dir <installation_directory> 1
```

- 1** For **<installation\_directory>**, specify the directory name to store the files that the installation program creates.



### IMPORTANT

Specify an empty directory. Some installation assets, like bootstrap X.509 certificates have short expiration intervals, so you must not reuse an installation directory. If you want to reuse individual files from another cluster installation, you can copy them into your directory. However, the file names for the installation assets might change between releases. Use caution when copying installation files from an earlier OpenShift Container Platform version.

- b. At the prompts, provide the configuration details for your cloud:
- i. Optional: Select an SSH key to use to access your cluster machines.



### NOTE

For production OpenShift Container Platform clusters on which you want to perform installation debugging or disaster recovery, specify an SSH key that your **ssh-agent** process uses.

- ii. Select **vsphere** as the platform to target.
- iii. Specify the name of your vCenter instance.
- iv. Specify the user name and password for the vCenter account that has the required permissions to create the cluster.  
The installation program connects to your vCenter instance.
- v. Select the datacenter in your vCenter instance to connect to.
- vi. Select the default vCenter datastore to use.
- vii. Select the vCenter cluster to install the OpenShift Container Platform cluster in. The installation program uses the root resource pool of the vSphere cluster as the default resource pool.
- viii. Select the network in the vCenter instance that contains the virtual IP addresses and DNS records that you configured.
- ix. Enter the virtual IP address that you configured for control plane API access.
- x. Enter the virtual IP address that you configured for cluster ingress.
- xi. Enter the base domain. This base domain must be the same one that you used in the DNS records that you configured.

- xii. Enter a descriptive name for your cluster. The cluster name you enter must match the cluster name you specified when configuring the DNS records.
  - xiii. Paste the [pull secret from the Red Hat OpenShift Cluster Manager](#) .
2. Modify the **install-config.yaml** file. You can find more information about the available parameters in the "Installation configuration parameters" section.
  3. Back up the **install-config.yaml** file so that you can use it to install multiple clusters.

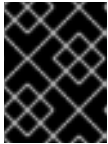

### IMPORTANT

The **install-config.yaml** file is consumed during the installation process. If you want to reuse the file, you must back it up now.

#### 21.4.11.1. Installation configuration parameters

Before you deploy an OpenShift Container Platform cluster, you provide parameter values to describe your account on the cloud platform that hosts your cluster and optionally customize your cluster's platform. When you create the **install-config.yaml** installation configuration file, you provide values for the required parameters through the command line. If you customize your cluster, you can modify the **install-config.yaml** file to provide more details about the platform.



### NOTE

After installation, you cannot modify these parameters in the **install-config.yaml** file.

##### 21.4.11.1.1. Required configuration parameters

Required installation configuration parameters are described in the following table:

Table 21.26. Required parameters

Parameter	Description	Values
<b>apiVersion</b>	The API version for the <b>install-config.yaml</b> content. The current version is <b>v1</b> . The installer may also support older API versions.	String
<b>baseDomain</b>	The base domain of your cloud provider. The base domain is used to create routes to your OpenShift Container Platform cluster components. The full DNS name for your cluster is a combination of the <b>baseDomain</b> and <b>metadata.name</b> parameter values that uses the <b>&lt;metadata.name&gt;</b> . <b>&lt;baseDomain&gt;</b> format.	A fully-qualified domain or subdomain name, such as <b>example.com</b> .

Parameter	Description	Values
<b>metadata</b>	Kubernetes resource <b>ObjectMeta</b> , from which only the <b>name</b> parameter is consumed.	Object
<b>metadata.name</b>	The name of the cluster. DNS records for the cluster are all subdomains of <b>{{.metadata.name}}</b> . <b>{{.baseDomain}}</b> .	String of lowercase letters and hyphens (-), such as <b>dev</b> .
<b>platform</b>	The configuration for the specific platform upon which to perform the installation: <b>alibabacloud</b> , <b>aws</b> , <b>baremetal</b> , <b>azure</b> , <b>gcp</b> , <b>ibmcloud</b> , <b>openstack</b> , <b>ovirt</b> , <b>vsphere</b> , or <b>{}</b> . For additional information about <b>platform.&lt;platform&gt;</b> parameters, consult the table for your specific platform that follows.	Object
<b>pullSecret</b>	Get a <a href="#">pull secret from the Red Hat OpenShift Cluster Manager</a> to authenticate downloading container images for OpenShift Container Platform components from services such as Quay.io.	<pre>{   "auths":{     "cloud.openshift.com":{       "auth":"b3Blb=",       "email":"you@example.com"     },     "quay.io":{       "auth":"b3Blb=",       "email":"you@example.com"     }   } }</pre>

#### 21.4.11.1.2. Network configuration parameters

You can customize your installation configuration based on the requirements of your existing network infrastructure. For example, you can expand the IP address block for the cluster network or provide different IP address blocks than the defaults.

Only IPv4 addresses are supported.

Table 21.27. Network parameters

Parameter	Description	Values
<b>networking</b>	The configuration for the cluster network.	Object  <b>NOTE</b> You cannot modify parameters specified by the <b>networking</b> object after installation.
<b>networking.networkType</b>	The cluster network provider Container Network Interface (CNI) plugin to install.	Either <b>OpenShiftSDN</b> or <b>OVNKubernetes</b> . <b>OpenShiftSDN</b> is a CNI provider for all-Linux networks. <b>OVNKubernetes</b> is a CNI provider for Linux networks and hybrid networks that contain both Linux and Windows servers. The default value is <b>OpenShiftSDN</b> .
<b>networking.clusterNetwork</b>	The IP address blocks for pods.  The default value is <b>10.128.0.0/14</b> with a host prefix of <b>/23</b> .  If you specify multiple IP address blocks, the blocks must not overlap.	An array of objects. For example:  <pre>networking:   clusterNetwork:   - cidr: 10.128.0.0/14     hostPrefix: 23</pre>
<b>networking.clusterNetwork.cidr</b>	Required if you use <b>networking.clusterNetwork</b> . An IP address block.  An IPv4 network.	An IP address block in Classless Inter-Domain Routing (CIDR) notation. The prefix length for an IPv4 block is between <b>0</b> and <b>32</b> .
<b>networking.clusterNetwork.hostPrefix</b>	The subnet prefix length to assign to each individual node. For example, if <b>hostPrefix</b> is set to <b>23</b> then each node is assigned a <b>/23</b> subnet out of the given <b>cidr</b> . A <b>hostPrefix</b> value of <b>23</b> provides 510 ( $2^{(32 - 23)} - 2$ ) pod IP addresses.	A subnet prefix.  The default value is <b>23</b> .
<b>networking.serviceNetwork</b>	The IP address block for services. The default value is <b>172.30.0.0/16</b> .  The OpenShift SDN and OVN-Kubernetes network providers support only a single IP address block for the service network.	An array with an IP address block in CIDR format. For example:  <pre>networking:   serviceNetwork:   - 172.30.0.0/16</pre>

Parameter	Description	Values
<b>networking.machineNetwork</b>	The IP address blocks for machines.  If you specify multiple IP address blocks, the blocks must not overlap.	An array of objects. For example:  <pre>networking:   machineNetwork:   - cidr: 10.0.0.0/16</pre>
<b>networking.machineNetwork.cidr</b>	Required if you use <b>networking.machineNetwork</b> . An IP address block. The default value is <b>10.0.0.0/16</b> for all platforms other than libvirt. For libvirt, the default value is <b>192.168.126.0/24</b> .	An IP network block in CIDR notation.  For example, <b>10.0.0.0/16</b> .   <p><b>NOTE</b></p> <p>Set the <b>networking.machineNetwork</b> to match the CIDR that the preferred NIC resides in.</p>

### 21.4.11.1.3. Optional configuration parameters

Optional installation configuration parameters are described in the following table:



Table 21.28. Optional parameters

Parameter	Description	Values
<b>additionalTrustBundle</b>	A PEM-encoded X.509 certificate bundle that is added to the nodes' trusted certificate store. This trust bundle may also be used when a proxy has been configured.	String
<b>cgroupsV2</b>	Enables <a href="#">Linux control groups version 2</a> (cgroups v2) on specific nodes in your cluster. The OpenShift Container Platform process for enabling cgroups v2 disables all cgroup version 1 controllers and hierarchies. The OpenShift Container Platform cgroups version 2 feature is in Developer Preview and is not supported by Red Hat at this time.	<b>true</b>
<b>compute</b>	The configuration for the machines that comprise the compute nodes.	Array of <b>MachinePool</b> objects.



Parameter	Description	Values
<b>compute.architecture</b>	Determines the instruction set architecture of the machines in the pool. Currently, clusters with varied architectures are not supported. All pools must specify the same architecture. Valid values are <b>amd64</b> (the default).	String
<b>compute.hyperthreading</b>	Whether to enable or disable simultaneous multithreading, or <b>hyperthreading</b> , on compute machines. By default, simultaneous multithreading is enabled to increase the performance of your machines' cores.   <b>IMPORTANT</b> If you disable simultaneous multithreading, ensure that your capacity planning accounts for the dramatically decreased machine performance.	<b>Enabled</b> or <b>Disabled</b>
<b>compute.name</b>	Required if you use <b>compute</b> . The name of the machine pool.	<b>worker</b>
<b>compute.platform</b>	Required if you use <b>compute</b> . Use this parameter to specify the cloud provider to host the worker machines. This parameter value must match the <b>controlPlane.platform</b> parameter value.	<b>alibabacloud, aws, azure, gcp, ibmcloud, openstack, ovirt, vsphere</b> , or <b>{}</b>
<b>compute.replicas</b>	The number of compute machines, which are also known as worker machines, to provision.	A positive integer greater than or equal to <b>2</b> . The default value is <b>3</b> .
<b>controlPlane</b>	The configuration for the machines that comprise the control plane.	Array of <b>MachinePool</b> objects.



Parameter	Description	Values
<b>controlPlane.architecture</b>	Determines the instruction set architecture of the machines in the pool. Currently, clusters with varied architectures are not supported. All pools must specify the same architecture. Valid values are <b>amd64</b> (the default).	String
<b>controlPlane.hypertreading</b>	Whether to enable or disable simultaneous multithreading, or <b>hyperthreading</b> , on control plane machines. By default, simultaneous multithreading is enabled to increase the performance of your machines' cores.   <b>IMPORTANT</b>  If you disable simultaneous multithreading, ensure that your capacity planning accounts for the dramatically decreased machine performance.	<b>Enabled</b> or <b>Disabled</b>
<b>controlPlane.name</b>	Required if you use <b>controlPlane</b> . The name of the machine pool.	<b>master</b>
<b>controlPlane.platform</b>	Required if you use <b>controlPlane</b> . Use this parameter to specify the cloud provider that hosts the control plane machines. This parameter value must match the <b>compute.platform</b> parameter value.	<b>alibabacloud, aws, azure, gcp, ibmcloud, openstack, ovirt, vsphere, or {}</b>
<b>controlPlane.replicas</b>	The number of control plane machines to provision.	The only supported value is <b>3</b> , which is the default value.

Parameter	Description	Values
<b>credentialsMode</b>	<p>The Cloud Credential Operator (CCO) mode. If no mode is specified, the CCO dynamically tries to determine the capabilities of the provided credentials, with a preference for mint mode on the platforms where multiple modes are supported.</p> <p> <b>NOTE</b></p> <p>Not all CCO modes are supported for all cloud providers. For more information on CCO modes, see the <i>Cloud Credential Operator</i> entry in the <i>Cluster Operators</i> reference content.</p> <p> <b>NOTE</b></p> <p>If your AWS account has service control policies (SCP) enabled, you must configure the <b>credentialsMode</b> parameter to <b>Mint</b>, <b>Passthrough</b> or <b>Manual</b>.</p>	<b>Mint, Passthrough, Manual</b> or an empty string ("").

Parameter	Description	Values
<b>fips</b>	<p>Enable or disable FIPS mode. The default is <b>false</b> (disabled). If FIPS mode is enabled, the Red Hat Enterprise Linux CoreOS (RHCOS) machines that OpenShift Container Platform runs on bypass the default Kubernetes cryptography suite and use the cryptography modules that are provided with RHCOS instead.</p> <div style="display: flex; align-items: flex-start;"> <div style="width: 20px; height: 100px; background: repeating-linear-gradient(45deg, transparent, transparent 2px, black 2px, black 4px); margin-right: 10px;"></div> <div> <p><b>IMPORTANT</b></p> <p>To enable FIPS mode for your cluster, you must run the installation program from a Red Hat Enterprise Linux (RHEL) computer configured to operate in FIPS mode. For more information about configuring FIPS mode on RHEL, see <a href="#">Installing the system in FIPS mode</a>. The use of FIPS validated or Modules In Process cryptographic libraries is only supported on OpenShift Container Platform deployments on the <b>x86_64</b> architecture.</p> </div> </div> <div style="display: flex; align-items: flex-start; margin-top: 10px;"> <div style="width: 20px; height: 50px; background: repeating-linear-gradient(45deg, transparent, transparent 2px, black 2px, black 4px); margin-right: 10px;"></div> <div> <p><b>NOTE</b></p> <p>If you are using Azure File storage, you cannot enable FIPS mode.</p> </div> </div>	<b>false</b> or <b>true</b>
<b>imageContentSources</b>	Sources and repositories for the release-image content.	Array of objects. Includes a <b>source</b> and, optionally, <b>mirrors</b> , as described in the following rows of this table.
<b>imageContentSources.source</b>	Required if you use <b>imageContentSources</b> . Specify the repository that users refer to, for example, in image pull specifications.	String
<b>imageContentSources.mirrors</b>	Specify one or more repositories that may also contain the same images.	Array of strings

Parameter	Description	Values
<b>publish</b>	How to publish or expose the user-facing endpoints of your cluster, such as the Kubernetes API, OpenShift routes.	<p><b>Internal</b> or <b>External</b>. The default value is <b>External</b>.</p> <p>Setting this field to <b>Internal</b> is not supported on non-cloud platforms and IBM Cloud VPC.</p> <div style="display: flex; align-items: flex-start;">  <div> <p><b>IMPORTANT</b></p> <p>If the value of the field is set to <b>Internal</b>, the cluster will become non-functional. For more information, refer to <a href="#">BZ#1953035</a>.</p> </div> </div>
<b>sshKey</b>	<p>The SSH key or keys to authenticate access your cluster machines.</p> <div style="display: flex; align-items: flex-start;">  <div> <p><b>NOTE</b></p> <p>For production OpenShift Container Platform clusters on which you want to perform installation debugging or disaster recovery, specify an SSH key that your <b>ssh-agent</b> process uses.</p> </div> </div>	<p>One or more keys. For example:</p> <pre>sshKey:   &lt;key1&gt;   &lt;key2&gt;   &lt;key3&gt;</pre>

#### 21.4.11.1.4. Additional VMware vSphere configuration parameters

Additional VMware vSphere configuration parameters are described in the following table:

Table 21.29. Additional VMware vSphere cluster parameters

Parameter	Description	Values
<b>platform.vsphere.vCenter</b>	The fully-qualified hostname or IP address of the vCenter server.	String
<b>platform.vsphere.username</b>	The user name to use to connect to the vCenter instance with. This user must have at least the roles and privileges that are required for <a href="#">static or dynamic persistent volume provisioning</a> in vSphere.	String

Parameter	Description	Values
<b>platform.vsphere.password</b>	The password for the vCenter user name.	String
<b>platform.vsphere.datacenter</b>	The name of the datacenter to use in the vCenter instance.	String
<b>platform.vsphere.defaultDatastore</b>	The name of the default datastore to use for provisioning volumes.	String
<b>platform.vsphere.folder</b>	Optional. The absolute path of an existing folder where the installation program creates the virtual machines. If you do not provide this value, the installation program creates a folder that is named with the infrastructure ID in the datacenter virtual machine folder.	String, for example, <b>/&lt;datacenter_name&gt;/vm/&lt;folder_name&gt;/&lt;subfolder_name&gt;</b> .
<b>platform.vsphere.resourcePool</b>	Optional. The absolute path of an existing resource pool where the installer creates the virtual machines. If you do not specify a value, resources are installed in the root of the cluster <b>/&lt;datacenter_name&gt;/host/&lt;cluster_name&gt;/Resources</b> .	String, for example, <b>/&lt;datacenter_name&gt;/host/&lt;cluster_name&gt;/Resources/&lt;resource_pool_name&gt;/&lt;optional_nested_resource_pool_name&gt;</b> .
<b>platform.vsphere.network</b>	The network in the vCenter instance that contains the virtual IP addresses and DNS records that you configured.	String
<b>platform.vsphere.cluster</b>	The vCenter cluster to install the OpenShift Container Platform cluster in.	String
<b>platform.vsphere.apiVIP</b>	The virtual IP (VIP) address that you configured for control plane API access.	An IP address, for example <b>128.0.0.1</b> .
<b>platform.vsphere.ingressVIP</b>	The virtual IP (VIP) address that you configured for cluster ingress.	An IP address, for example <b>128.0.0.1</b> .
<b>platform.vsphere.diskType</b>	Optional. The disk provisioning method. This value defaults to the vSphere default storage policy if not set.	Valid values are <b>thin</b> , <b>thick</b> , or <b>eagerZeroedThick</b> .

#### 21.4.11.1.5. Optional VMware vSphere machine pool configuration parameters

Optional VMware vSphere machine pool configuration parameters are described in the following table:

**Table 21.30. Optional VMware vSphere machine pool parameters**

Parameter	Description	Values
<b>platform.vsphere.clusterOSImage</b>	The location from which the installer downloads the RHCOS image. You must set this parameter to perform an installation in a restricted network.	An HTTP or HTTPS URL, optionally with a SHA-256 checksum. For example, <b>https://mirror.openshift.com/images/rhcos-&lt;version&gt;-vmware.&lt;architecture&gt;.ova.</b>
<b>platform.vsphere.osDisk.diskSizeGB</b>	The size of the disk in gigabytes.	Integer
<b>platform.vsphere.cpus</b>	The total number of virtual processor cores to assign a virtual machine. The value of <b>platform.vsphere.cpus</b> must be a multiple of <b>platform.vsphere.coresPerSocket</b> value.	Integer
<b>platform.vsphere.coresPerSocket</b>	The number of cores per socket in a virtual machine. The number of virtual sockets on the virtual machine is <b>platform.vsphere.cpus/platform.vsphere.coresPerSocket</b> . The default value for control plane nodes and worker nodes is <b>4</b> and <b>2</b> , respectively.	Integer
<b>platform.vsphere.memoryMB</b>	The size of a virtual machine's memory in megabytes.	Integer

### 21.4.11.2. Sample install-config.yaml file for an installer-provisioned VMware vSphere cluster

You can customize the install-config.yaml file to specify more details about your OpenShift Container Platform cluster's platform or modify the values of the required parameters.

```

apiVersion: v1
baseDomain: example.com 1
compute: 2
- hypervthreading: Enabled 3
  name: worker
  replicas: 3
  platform:
    vsphere: 4
      cpus: 2
      coresPerSocket: 2
      memoryMB: 8192

```

```

    osDisk:
      diskSizeGB: 120
controlPlane: 5
  hyperthreading: Enabled 6
  name: master
  replicas: 3
  platform:
    vsphere: 7
      cpus: 4
      coresPerSocket: 2
      memoryMB: 16384
      osDisk:
        diskSizeGB: 120
metadata:
  name: cluster 8
networking:
  clusterNetwork:
    - cidr: 10.128.0.0/14
    hostPrefix: 23
  machineNetwork:
    - cidr: 10.0.0.0/16
  networkType: OpenShiftSDN
  serviceNetwork:
    - 172.30.0.0/16
platform:
  vsphere:
    vcenter: your.vcenter.server
    username: username
    password: password
    datacenter: datacenter
    defaultDatastore: datastore
    folder: folder
    resourcePool: resource_pool 9
    diskType: thin 10
    network: VM_Network
    cluster: vsphere_cluster_name 11
    apiVIP: api_vip
    ingressVIP: ingress_vip
fips: false
pullSecret: '{"auths": ...}'
sshKey: 'ssh-ed25519 AAAA...'

```

- 1 The base domain of the cluster. All DNS records must be sub-domains of this base and include the cluster name.
- 2 5 The **controlPlane** section is a single mapping, but the **compute** section is a sequence of mappings. To meet the requirements of the different data structures, the first line of the **compute** section must begin with a hyphen, -, and the first line of the **controlPlane** section must not. Only one control plane pool is used.
- 3 6 Whether to enable or disable simultaneous multithreading, or **hyperthreading**. By default, simultaneous multithreading is enabled to increase the performance of your machines' cores. You can disable it by setting the parameter value to **Disabled**. If you disable simultaneous multithreading in some cluster machines, you must disable it in all cluster machines.

**IMPORTANT**

If you disable simultaneous multithreading, ensure that your capacity planning accounts for the dramatically decreased machine performance. Your machines must use at least 8 CPUs and 32 GB of RAM if you disable simultaneous multithreading.

- 4 7 Optional: Provide additional configuration for the machine pool parameters for the compute and control plane machines.
- 8 The cluster name that you specified in your DNS records.
- 9 Optional: Provide an existing resource pool for machine creation. If you do not specify a value, the installation program uses the root resource pool of the vSphere cluster.
- 10 The vSphere disk provisioning method.
- 11 The vSphere cluster to install the OpenShift Container Platform cluster in.

**21.4.11.3. Configuring the cluster-wide proxy during installation**

Production environments can deny direct access to the internet and instead have an HTTP or HTTPS proxy available. You can configure a new OpenShift Container Platform cluster to use a proxy by configuring the proxy settings in the **install-config.yaml** file.

**Prerequisites**

- You have an existing **install-config.yaml** file.
- You reviewed the sites that your cluster requires access to and determined whether any of them need to bypass the proxy. By default, all cluster egress traffic is proxied, including calls to hosting cloud provider APIs. You added sites to the **Proxy** object's **spec.noProxy** field to bypass the proxy if necessary.

**NOTE**

The **Proxy** object **status.noProxy** field is populated with the values of the **networking.machineNetwork[].cidr**, **networking.clusterNetwork[].cidr**, and **networking.serviceNetwork[]** fields from your installation configuration.

For installations on Amazon Web Services (AWS), Google Cloud Platform (GCP), Microsoft Azure, and Red Hat OpenStack Platform (RHOSP), the **Proxy** object **status.noProxy** field is also populated with the instance metadata endpoint (**169.254.169.254**).

**Procedure**

1. Edit your **install-config.yaml** file and add the proxy settings. For example:

```
apiVersion: v1
baseDomain: my.domain.com
proxy:
  httpProxy: http://<username>:<pswd>@<ip>:<port> 1
  httpsProxy: https://<username>:<pswd>@<ip>:<port> 2
  noProxy: example.com 3
```



```

additionalTrustBundle: | 4
-----BEGIN CERTIFICATE-----
<MY_TRUSTED_CA_CERT>
-----END CERTIFICATE-----
...

```

- 1 A proxy URL to use for creating HTTP connections outside the cluster. The URL scheme must be **http**.
- 2 A proxy URL to use for creating HTTPS connections outside the cluster.
- 3 A comma-separated list of destination domain names, IP addresses, or other network CIDRs to exclude from proxying. Preface a domain with **.** to match subdomains only. For example, **.y.com** matches **x.y.com**, but not **y.com**. Use **\*** to bypass the proxy for all destinations. You must include vCenter's IP address and the IP range that you use for its machines.
- 4 If provided, the installation program generates a config map that is named **user-ca-bundle** in the **openshift-config** namespace that contains one or more additional CA certificates that are required for proxying HTTPS connections. The Cluster Network Operator then creates a **trusted-ca-bundle** config map that merges these contents with the Red Hat Enterprise Linux CoreOS (RHCOS) trust bundle, and this config map is referenced in the **trustedCA** field of the **Proxy** object. The **additionalTrustBundle** field is required unless the proxy's identity certificate is signed by an authority from the RHCOS trust bundle.

**NOTE**

The installation program does not support the proxy **readinessEndpoints** field.

**NOTE**

If the installer times out, restart and then complete the deployment by using the **wait-for** command of the installer. For example:

```

$ ./openshift-install wait-for install-complete --log-level debug

```

2. Save the file and reference it when installing OpenShift Container Platform.

The installation program creates a cluster-wide proxy that is named **cluster** that uses the proxy settings in the provided **install-config.yaml** file. If no proxy settings are provided, a **cluster Proxy** object is still created, but it will have a nil **spec**.

**NOTE**

Only the **Proxy** object named **cluster** is supported, and no additional proxies can be created.

## 21.4.12. Network configuration phases

There are two phases prior to OpenShift Container Platform installation where you can customize the network configuration.

### Phase 1

You can customize the following network-related fields in the **install-config.yaml** file before you create the manifest files:

- **networking.networkType**
- **networking.clusterNetwork**
- **networking.serviceNetwork**
- **networking.machineNetwork**

For more information on these fields, refer to *Installation configuration parameters*.



#### NOTE

Set the **networking.machineNetwork** to match the CIDR that the preferred NIC resides in.



#### IMPORTANT

The CIDR range **172.17.0.0/16** is reserved by libVirt. You cannot use this range or any range that overlaps with this range for any networks in your cluster.

### Phase 2

After creating the manifest files by running **openshift-install create manifests**, you can define a customized Cluster Network Operator manifest with only the fields you want to modify. You can use the manifest to specify advanced network configuration.

You cannot override the values specified in phase 1 in the **install-config.yaml** file during phase 2. However, you can further customize the cluster network provider during phase 2.

### 21.4.13. Specifying advanced network configuration

You can use advanced network configuration for your cluster network provider to integrate your cluster into your existing network environment. You can specify advanced network configuration only before you install the cluster.



#### IMPORTANT

Customizing your network configuration by modifying the OpenShift Container Platform manifest files created by the installation program is not supported. Applying a manifest file that you create, as in the following procedure, is supported.

#### Prerequisites

- You have created the **install-config.yaml** file and completed any modifications to it.

#### Procedure

1. Change to the directory that contains the installation program and create the manifests:

```
$ ./openshift-install create manifests --dir <installation_directory> 1
```

- 1 **<installation\_directory>** specifies the name of the directory that contains the **install-config.yaml** file for your cluster.
2. Create a stub manifest file for the advanced network configuration that is named **cluster-network-03-config.yml** in the **<installation\_directory>/manifests/** directory:

```
apiVersion: operator.openshift.io/v1
kind: Network
metadata:
  name: cluster
spec:
```

3. Specify the advanced network configuration for your cluster in the **cluster-network-03-config.yml** file, such as in the following examples:

#### Specify a different VXLAN port for the OpenShift SDN network provider

```
apiVersion: operator.openshift.io/v1
kind: Network
metadata:
  name: cluster
spec:
  defaultNetwork:
    openshiftSDNConfig:
      vxlanPort: 4800
```

#### Enable IPsec for the OVN-Kubernetes network provider

```
apiVersion: operator.openshift.io/v1
kind: Network
metadata:
  name: cluster
spec:
  defaultNetwork:
    ovnKubernetesConfig:
      ipsecConfig: {}
```

4. Optional: Back up the **manifests/cluster-network-03-config.yml** file. The installation program consumes the **manifests/** directory when you create the Ignition config files.

### 21.4.14. Cluster Network Operator configuration

The configuration for the cluster network is specified as part of the Cluster Network Operator (CNO) configuration and stored in a custom resource (CR) object that is named **cluster**. The CR specifies the fields for the **Network** API in the **operator.openshift.io** API group.

The CNO configuration inherits the following fields during cluster installation from the **Network** API in the **Network.config.openshift.io** API group and these fields cannot be changed:

#### **clusterNetwork**

IP address pools from which pod IP addresses are allocated.

#### **serviceNetwork**

IP address pool for services.

### **defaultNetwork.type**

Cluster network provider, such as OpenShift SDN or OVN-Kubernetes.

You can specify the cluster network provider configuration for your cluster by setting the fields for the **defaultNetwork** object in the CNO object named **cluster**.

#### 21.4.14.1. Cluster Network Operator configuration object

The fields for the Cluster Network Operator (CNO) are described in the following table:

**Table 21.31. Cluster Network Operator configuration object**

Field	Type	Description
<b>metadata.name</b>	<b>string</b>	The name of the CNO object. This name is always <b>cluster</b> .
<b>spec.clusterNetwork</b>	<b>array</b>	<p>A list specifying the blocks of IP addresses from which pod IP addresses are allocated and the subnet prefix length assigned to each individual node in the cluster. For example:</p> <pre>spec:   clusterNetwork:   - cidr: 10.128.0.0/19     hostPrefix: 23   - cidr: 10.128.32.0/19     hostPrefix: 23</pre> <p>You can customize this field only in the <b>install-config.yaml</b> file before you create the manifests. The value is read-only in the manifest file.</p>
<b>spec.serviceNetwork</b>	<b>array</b>	<p>A block of IP addresses for services. The OpenShift SDN and OVN-Kubernetes Container Network Interface (CNI) network providers support only a single IP address block for the service network. For example:</p> <pre>spec:   serviceNetwork:   - 172.30.0.0/14</pre> <p>You can customize this field only in the <b>install-config.yaml</b> file before you create the manifests. The value is read-only in the manifest file.</p>
<b>spec.defaultNetwork</b>	<b>object</b>	Configures the Container Network Interface (CNI) cluster network provider for the cluster network.
<b>spec.kubeProxyConfig</b>	<b>object</b>	The fields for this object specify the kube-proxy configuration. If you are using the OVN-Kubernetes cluster network provider, the kube-proxy configuration has no effect.

**defaultNetwork object configuration**

The values for the **defaultNetwork** object are defined in the following table:

**Table 21.32. defaultNetwork object**

Field	Type	Description
<b>type</b>	<b>string</b>	<p>Either <b>OpenShiftSDN</b> or <b>OVNKubernetes</b>. The cluster network provider is selected during installation. This value cannot be changed after cluster installation.</p> <div style="display: flex; align-items: flex-start;"> <div style="flex: 1;">  </div> <div style="flex: 2;"> <p><b>NOTE</b></p> <p>OpenShift Container Platform uses the OpenShift SDN Container Network Interface (CNI) cluster network provider by default.</p> </div> </div>
<b>openshiftSDNConfig</b>	<b>object</b>	This object is only valid for the OpenShift SDN cluster network provider.
<b>ovnKubernetesConfig</b>	<b>object</b>	This object is only valid for the OVN-Kubernetes cluster network provider.

**Configuration for the OpenShift SDN CNI cluster network provider**

The following table describes the configuration fields for the OpenShift SDN Container Network Interface (CNI) cluster network provider.

**Table 21.33. openshiftSDNConfig object**

Field	Type	Description
<b>mode</b>	<b>string</b>	<p>Configures the network isolation mode for OpenShift SDN. The default value is <b>NetworkPolicy</b>.</p> <p>The values <b>Multitenant</b> and <b>Subnet</b> are available for backwards compatibility with OpenShift Container Platform 3.x but are not recommended. This value cannot be changed after cluster installation.</p>

Field	Type	Description
<b>mtu</b>	<b>integer</b>	<p>The maximum transmission unit (MTU) for the VXLAN overlay network. This is detected automatically based on the MTU of the primary network interface. You do not normally need to override the detected MTU.</p> <p>If the auto-detected value is not what you expect it to be, confirm that the MTU on the primary network interface on your nodes is correct. You cannot use this option to change the MTU value of the primary network interface on the nodes.</p> <p>If your cluster requires different MTU values for different nodes, you must set this value to <b>50</b> less than the lowest MTU value in your cluster. For example, if some nodes in your cluster have an MTU of <b>9001</b>, and some have an MTU of <b>1500</b>, you must set this value to <b>1450</b>.</p> <p>This value cannot be changed after cluster installation.</p>
<b>vxlanPort</b>	<b>integer</b>	<p>The port to use for all VXLAN packets. The default value is <b>4789</b>. This value cannot be changed after cluster installation.</p> <p>If you are running in a virtualized environment with existing nodes that are part of another VXLAN network, then you might be required to change this. For example, when running an OpenShift SDN overlay on top of VMware NSX-T, you must select an alternate port for the VXLAN, because both SDNs use the same default VXLAN port number.</p> <p>On Amazon Web Services (AWS), you can select an alternate port for the VXLAN between port <b>9000</b> and port <b>9999</b>.</p>

## Example OpenShift SDN configuration

```
defaultNetwork:
  type: OpenShiftSDN
  openshiftSDNConfig:
    mode: NetworkPolicy
    mtu: 1450
    vxlanPort: 4789
```

## Configuration for the OVN-Kubernetes CNI cluster network provider

The following table describes the configuration fields for the OVN-Kubernetes CNI cluster network provider.

Table 21.34. `ovnKubernetesConfig` object

Field	Type	Description
-------	------	-------------

Field	Type	Description
<b>mtu</b>	<b>integer</b>	<p>The maximum transmission unit (MTU) for the Geneve (Generic Network Virtualization Encapsulation) overlay network. This is detected automatically based on the MTU of the primary network interface. You do not normally need to override the detected MTU.</p> <p>If the auto-detected value is not what you expect it to be, confirm that the MTU on the primary network interface on your nodes is correct. You cannot use this option to change the MTU value of the primary network interface on the nodes.</p> <p>If your cluster requires different MTU values for different nodes, you must set this value to <b>100</b> less than the lowest MTU value in your cluster. For example, if some nodes in your cluster have an MTU of <b>9001</b>, and some have an MTU of <b>1500</b>, you must set this value to <b>1400</b>.</p>
<b>genevePort</b>	<b>integer</b>	The port to use for all Geneve packets. The default value is <b>6081</b> . This value cannot be changed after cluster installation.
<b>ipsecConfig</b>	<b>object</b>	Specify an empty object to enable IPsec encryption. This value cannot be changed after cluster installation.
<b>policyAuditConfig</b>	<b>object</b>	Specify a configuration object for customizing network policy audit logging. If unset, the defaults audit log settings are used.
<b>gatewayConfig</b>	<b>object</b>	<p>Optional: Specify a configuration object for customizing how egress traffic is sent to the node gateway.</p> <div style="display: flex; align-items: flex-start;">  <div> <p><b>NOTE</b></p> <p>While migrating egress traffic, you can expect some disruption to workloads and service traffic until the Cluster Network Operator (CNO) successfully rolls out the changes.</p> </div> </div>

Table 21.35. **policyAuditConfig** object

Field	Type	Description
<b>rateLimit</b>	integer	The maximum number of messages to generate every second per node. The default value is <b>20</b> messages per second.
<b>maxFileSize</b>	integer	The maximum size for the audit log in bytes. The default value is <b>50000000</b> or 50 MB.

Field	Type	Description
<b>destination</b>	string	<p>One of the following additional audit log targets:</p> <p><b>libc</b> The libc <b>syslog()</b> function of the journald process on the host.</p> <p><b>udp:&lt;host&gt;:&lt;port&gt;</b> A syslog server. Replace <b>&lt;host&gt;:&lt;port&gt;</b> with the host and port of the syslog server.</p> <p><b>unix:&lt;file&gt;</b> A Unix Domain Socket file specified by <b>&lt;file&gt;</b>.</p> <p><b>null</b> Do not send the audit logs to any additional target.</p>
<b>syslogFacility</b>	string	The syslog facility, such as <b>kern</b> , as defined by RFC5424. The default value is <b>local0</b> .

Table 21.36. gatewayConfig object

Field	Type	Description
<b>routingViaHost</b>	<b>boolean</b>	<p>Set this field to <b>true</b> to send egress traffic from pods to the host networking stack. For highly-specialized installations and applications that rely on manually configured routes in the kernel routing table, you might want to route egress traffic to the host networking stack. By default, egress traffic is processed in OVN to exit the cluster and is not affected by specialized routes in the kernel routing table. The default value is <b>false</b>.</p> <p>This field has an interaction with the Open vSwitch hardware offloading feature. If you set this field to <b>true</b>, you do not receive the performance benefits of the offloading because egress traffic is processed by the host networking stack.</p>

### Example OVN-Kubernetes configuration with IPsec enabled

```

defaultNetwork:
  type: OVNKubernetes
  ovnKubernetesConfig:
    mtu: 1400
    genevePort: 6081
    ipsecConfig: {}

```

### kubeProxyConfig object configuration

The values for the **kubeProxyConfig** object are defined in the following table:

Table 21.37. kubeProxyConfig object



Field	Type	Description
<b>iptablesSyncPeriod</b>	<b>string</b>	<p>The refresh period for <b>iptables</b> rules. The default value is <b>30s</b>. Valid suffixes include <b>s</b>, <b>m</b>, and <b>h</b> and are described in the <a href="#">Go time package</a> documentation.</p> <div style="display: flex; align-items: flex-start;"> <div style="flex: 1;">  </div> <div style="flex: 2;"> <p><b>NOTE</b></p> <p>Because of performance improvements introduced in OpenShift Container Platform 4.3 and greater, adjusting the <b>iptablesSyncPeriod</b> parameter is no longer necessary.</p> </div> </div>
<b>proxyArguments.iptables-min-sync-period</b>	<b>array</b>	<p>The minimum duration before refreshing <b>iptables</b> rules. This field ensures that the refresh does not happen too frequently. Valid suffixes include <b>s</b>, <b>m</b>, and <b>h</b> and are described in the <a href="#">Go time package</a>. The default value is:</p> <pre>kubeProxyConfig:   proxyArguments:     iptables-min-sync-period:       - 0s</pre>

## 21.4.15. Deploying the cluster

You can install OpenShift Container Platform on a compatible cloud platform.



### IMPORTANT

You can run the **create cluster** command of the installation program only once, during initial installation.

### Prerequisites

- Configure an account with the cloud platform that hosts your cluster.
- Obtain the OpenShift Container Platform installation program and the pull secret for your cluster.

### Procedure

1. Change to the directory that contains the installation program and initialize the cluster deployment:

```
$ ./openshift-install create cluster --dir <installation_directory> \ 1
--log-level=info 2
```

- 1 For `<installation_directory>`, specify the location of your customized `./install-config.yaml` file.
- 2 To view different installation details, specify **warn**, **debug**, or **error** instead of **info**.

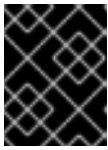

### IMPORTANT

Use the **openshift-install** command from the bastion hosted in the VMC environment.



### NOTE

If the cloud provider account that you configured on your host does not have sufficient permissions to deploy the cluster, the installation process stops, and the missing permissions are displayed.

When the cluster deployment completes, directions for accessing your cluster, including a link to its web console and credentials for the **kubeadmin** user, display in your terminal.

### Example output

```
...
INFO Install complete!
INFO To access the cluster as the system:admin user when using 'oc', run 'export
KUBECONFIG=/home/myuser/install_dir/auth/kubeconfig'
INFO Access the OpenShift web-console here: https://console-openshift-
console.apps.mycluster.example.com
INFO Login to the console with user: "kubeadmin", and password: "4vYBz-Ee6gm-ymBZj-
Wt5AL"
INFO Time elapsed: 36m22s
```



### NOTE

The cluster access and credential information also outputs to `<installation_directory>/openshift_install.log` when an installation succeeds.

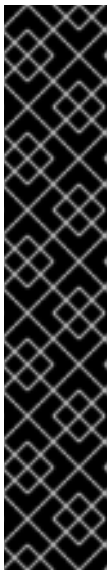

### IMPORTANT

- The Ignition config files that the installation program generates contain certificates that expire after 24 hours, which are then renewed at that time. If the cluster is shut down before renewing the certificates and the cluster is later restarted after the 24 hours have elapsed, the cluster automatically recovers the expired certificates. The exception is that you must manually approve the pending **node-bootstrapper** certificate signing requests (CSRs) to recover kubelet certificates. See the documentation for *Recovering from expired control plane certificates* for more information.
- It is recommended that you use Ignition config files within 12 hours after they are generated because the 24-hour certificate rotates from 16 to 22 hours after the cluster is installed. By using the Ignition config files within 12 hours, you can avoid installation failure if the certificate update runs during installation.

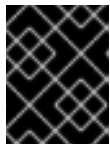
**IMPORTANT**

You must not delete the installation program or the files that the installation program creates. Both are required to delete the cluster.

**21.4.16. Installing the OpenShift CLI by downloading the binary**

You can install the OpenShift CLI (**oc**) to interact with OpenShift Container Platform from a command-line interface. You can install **oc** on Linux, Windows, or macOS.

**IMPORTANT**

If you installed an earlier version of **oc**, you cannot use it to complete all of the commands in OpenShift Container Platform 4.10. Download and install the new version of **oc**.

**Installing the OpenShift CLI on Linux**

You can install the OpenShift CLI (**oc**) binary on Linux by using the following procedure.

**Procedure**

1. Navigate to the [OpenShift Container Platform downloads page](#) on the Red Hat Customer Portal.
2. Select the appropriate version in the **Version** drop-down menu.
3. Click **Download Now** next to the **OpenShift v4.10 Linux Client** entry and save the file.
4. Unpack the archive:

```
$ tar xvf <file>
```

5. Place the **oc** binary in a directory that is on your **PATH**.  
To check your **PATH**, execute the following command:

```
$ echo $PATH
```

After you install the OpenShift CLI, it is available using the **oc** command:

```
$ oc <command>
```

**Installing the OpenShift CLI on Windows**

You can install the OpenShift CLI (**oc**) binary on Windows by using the following procedure.

**Procedure**

1. Navigate to the [OpenShift Container Platform downloads page](#) on the Red Hat Customer Portal.
2. Select the appropriate version in the **Version** drop-down menu.
3. Click **Download Now** next to the **OpenShift v4.10 Windows Client** entry and save the file.
4. Unzip the archive with a ZIP program.

5. Move the **oc** binary to a directory that is on your **PATH**.  
To check your **PATH**, open the command prompt and execute the following command:

```
C:\> path
```

After you install the OpenShift CLI, it is available using the **oc** command:

```
C:\> oc <command>
```

### Installing the OpenShift CLI on macOS

You can install the OpenShift CLI (**oc**) binary on macOS by using the following procedure.

#### Procedure

1. Navigate to the [OpenShift Container Platform downloads page](#) on the Red Hat Customer Portal.
2. Select the appropriate version in the **Version** drop-down menu.
3. Click **Download Now** next to the **OpenShift v4.10 MacOSX Client** entry and save the file.
4. Unpack and unzip the archive.
5. Move the **oc** binary to a directory on your PATH.  
To check your **PATH**, open a terminal and execute the following command:

```
$ echo $PATH
```

After you install the OpenShift CLI, it is available using the **oc** command:

```
$ oc <command>
```

### 21.4.17. Logging in to the cluster by using the CLI

You can log in to your cluster as a default system user by exporting the cluster **kubeconfig** file. The **kubeconfig** file contains information about the cluster that is used by the CLI to connect a client to the correct cluster and API server. The file is specific to a cluster and is created during OpenShift Container Platform installation.

#### Prerequisites

- You deployed an OpenShift Container Platform cluster.
- You installed the **oc** CLI.

#### Procedure

1. Export the **kubeadmin** credentials:

```
$ export KUBECONFIG=<installation_directory>/auth/kubeconfig 1
```

- 1** For **<installation\_directory>**, specify the path to the directory that you stored the installation files in.

2. Verify you can run **oc** commands successfully using the exported configuration:

```
$ oc whoami
```

#### Example output

```
system:admin
```

## 21.4.18. Creating registry storage

After you install the cluster, you must create storage for the registry Operator.

### 21.4.18.1. Image registry removed during installation

On platforms that do not provide shareable object storage, the OpenShift Image Registry Operator bootstraps itself as **Removed**. This allows **openshift-installer** to complete installations on these platform types.

After installation, you must edit the Image Registry Operator configuration to switch the **managementState** from **Removed** to **Managed**.

### 21.4.18.2. Image registry storage configuration

The Image Registry Operator is not initially available for platforms that do not provide default storage. After installation, you must configure your registry to use storage so that the Registry Operator is made available.

Instructions are shown for configuring a persistent volume, which is required for production clusters. Where applicable, instructions are shown for configuring an empty directory as the storage location, which is available for only non-production clusters.

Additional instructions are provided for allowing the image registry to use block storage types by using the **Recreate** rollout strategy during upgrades.

#### 21.4.18.2.1. Configuring registry storage for VMware vSphere

As a cluster administrator, following installation you must configure your registry to use storage.

#### Prerequisites

- Cluster administrator permissions.
- A cluster on VMware vSphere.
- Persistent storage provisioned for your cluster, such as Red Hat OpenShift Data Foundation.



#### IMPORTANT

OpenShift Container Platform supports **ReadWriteOnce** access for image registry storage when you have only one replica. **ReadWriteOnce** access also requires that the registry uses the **Recreate** rollout strategy. To deploy an image registry that supports high availability with two or more replicas, **ReadWriteMany** access is required.

- Must have "100Gi" capacity.

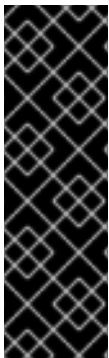

## IMPORTANT

Testing shows issues with using the NFS server on RHEL as storage backend for core services. This includes the OpenShift Container Registry and Quay, Prometheus for monitoring storage, and Elasticsearch for logging storage. Therefore, using RHEL NFS to back PVs used by core services is not recommended.

Other NFS implementations on the marketplace might not have these issues. Contact the individual NFS implementation vendor for more information on any testing that was possibly completed against these OpenShift Container Platform core components.

## Procedure

1. To configure your registry to use storage, change the **spec.storage.pvc** in the **configs.imageregistry/cluster** resource.



## NOTE

When using shared storage, review your security settings to prevent outside access.

2. Verify that you do not have a registry pod:

```
$ oc get pod -n openshift-image-registry -l docker-registry=default
```

## Example output

```
No resources found in openshift-image-registry namespace
```



## NOTE

If you do have a registry pod in your output, you do not need to continue with this procedure.

3. Check the registry configuration:

```
$ oc edit configs.imageregistry.operator.openshift.io
```

## Example output

```
storage:
  pvc:
    claim: 1
```

- 1 Leave the **claim** field blank to allow the automatic creation of an **image-registry-storage** persistent volume claim (PVC). The PVC is generated based on the default storage class. However, be aware that the default storage class might provide ReadWriteOnce (RWO) volumes, such as a RADOS Block Device (RBD), which can cause issues when replicating to more than one replica.

4. Check the **clusteroperator** status:

```
$ oc get clusteroperator image-registry
```

### Example output

NAME	VERSION	AVAILABLE	PROGRESSING	DEGRADED
image-registry	4.7	True	False	6h50m

#### 21.4.18.2.2. Configuring block registry storage for VMware vSphere

To allow the image registry to use block storage types such as vSphere Virtual Machine Disk (VMDK) during upgrades as a cluster administrator, you can use the **Recreate** rollout strategy.



### IMPORTANT

Block storage volumes are supported but not recommended for use with image registry on production clusters. An installation where the registry is configured on block storage is not highly available because the registry cannot have more than one replica.

### Procedure

1. To set the image registry storage as a block storage type, patch the registry so that it uses the **Recreate** rollout strategy and runs with only **1** replica:

```
$ oc patch config.imageregistry.operator.openshift.io/cluster --type=merge -p '{"spec": {"rolloutStrategy": "Recreate", "replicas": 1}}'
```

2. Provision the PV for the block storage device, and create a PVC for that volume. The requested block volume uses the ReadWriteOnce (RWO) access mode.
  - a. Create a **pvc.yaml** file with the following contents to define a VMware vSphere **PersistentVolumeClaim** object:

```
kind: PersistentVolumeClaim
apiVersion: v1
metadata:
  name: image-registry-storage 1
  namespace: openshift-image-registry 2
spec:
  accessModes:
  - ReadWriteOnce 3
  resources:
    requests:
      storage: 100Gi 4
```

- 1 A unique name that represents the **PersistentVolumeClaim** object.
- 2 The namespace for the **PersistentVolumeClaim** object, which is **openshift-image-registry**.
- 3 The access mode of the persistent volume claim. With **ReadWriteOnce**, the volume

4 The size of the persistent volume claim.

b. Create the **PersistentVolumeClaim** object from the file:

```
$ oc create -f pvc.yaml -n openshift-image-registry
```

3. Edit the registry configuration so that it references the correct PVC:

```
$ oc edit config.imageregistry.operator.openshift.io -o yaml
```

### Example output

```
storage:
  pvc:
    claim: 1
```

1 Creating a custom PVC allows you to leave the **claim** field blank for the default automatic creation of an **image-registry-storage** PVC.

For instructions about configuring registry storage so that it references the correct PVC, see [Configuring the registry for vSphere](#).

## 21.4.19. Backing up VMware vSphere volumes

OpenShift Container Platform provisions new volumes as independent persistent disks to freely attach and detach the volume on any node in the cluster. As a consequence, it is not possible to back up volumes that use snapshots, or to restore volumes from snapshots. See [Snapshot Limitations](#) for more information.

### Procedure

To create a backup of persistent volumes:

1. Stop the application that is using the persistent volume.
2. Clone the persistent volume.
3. Restart the application.
4. Create a backup of the cloned volume.
5. Delete the cloned volume.

## 21.4.20. Telemetry access for OpenShift Container Platform

In OpenShift Container Platform 4.10, the Telemetry service, which runs by default to provide metrics about cluster health and the success of updates, requires internet access. If your cluster is connected to the internet, Telemetry runs automatically, and your cluster is registered to [OpenShift Cluster Manager](#).

After you confirm that your [OpenShift Cluster Manager](#) inventory is correct, either maintained automatically by Telemetry or manually by using OpenShift Cluster Manager, [use subscription watch](#) to track your OpenShift Container Platform subscriptions at the account or multi-cluster level.



## Additional resources

- See [About remote health monitoring](#) for more information about the Telemetry service

### 21.4.21. Next steps

- [Customize your cluster.](#)
- If necessary, you can [opt out of remote health reporting](#) .
- [Set up your registry and configure registry storage](#) .
- Optional: [View the events from the vSphere Problem Detector Operator](#) to determine if the cluster has permission or storage configuration issues.

## 21.5. INSTALLING A CLUSTER ON VMC IN A RESTRICTED NETWORK

In OpenShift Container Platform version 4.10, you can install a cluster on VMware vSphere infrastructure in a restricted network by deploying it to [VMware Cloud \(VMC\) on AWS](#).

Once you configure your VMC environment for OpenShift Container Platform deployment, you use the OpenShift Container Platform installation program from the bastion management host, co-located in the VMC environment. The installation program and control plane automates the process of deploying and managing the resources needed for the OpenShift Container Platform cluster.



### NOTE

OpenShift Container Platform supports deploying a cluster to a single VMware vCenter only. Deploying a cluster with machines/machine sets on multiple vCenters is not supported.

### 21.5.1. Setting up VMC for vSphere

You can install OpenShift Container Platform on VMware Cloud (VMC) on AWS hosted vSphere clusters to enable applications to be deployed and managed both on-premise and off-premise, across the hybrid cloud.

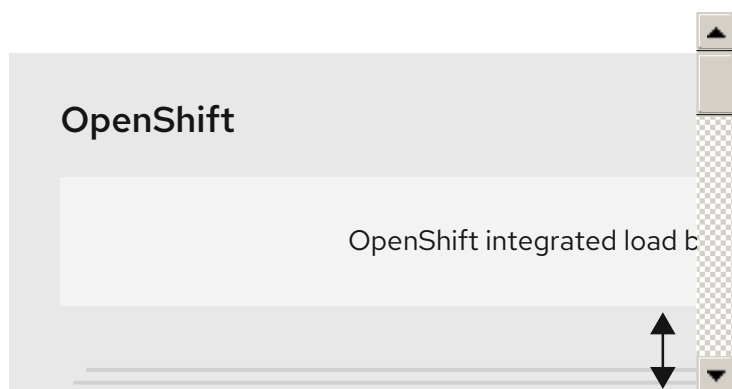

You must configure several options in your VMC environment prior to installing OpenShift Container Platform on VMware vSphere. Ensure your VMC environment has the following prerequisites:

- Create a non-exclusive, DHCP-enabled, NSX-T network segment and subnet. Other virtual machines (VMs) can be hosted on the subnet, but at least eight IP addresses must be available for the OpenShift Container Platform deployment.

- Allocate two IP addresses, outside the DHCP range, and configure them with reverse DNS records.
  - A DNS record for **api.<cluster\_name>.<base\_domain>** pointing to the allocated IP address.
  - A DNS record for **\*.apps.<cluster\_name>.<base\_domain>** pointing to the allocated IP address.
- Configure the following firewall rules:
  - An ANY:ANY firewall rule between the installation host and the software-defined data center (SDDC) management network on port 443. This allows you to upload the Red Hat Enterprise Linux CoreOS (RHCOS) OVA during deployment.
  - An HTTPS firewall rule between the OpenShift Container Platform compute network and vCenter. This connection allows OpenShift Container Platform to communicate with vCenter for provisioning and managing nodes, persistent volume claims (PVCs), and other resources.
- You must have the following information to deploy OpenShift Container Platform:
  - The OpenShift Container Platform cluster name, such as **vmc-prod-1**.
  - The base DNS name, such as **companyname.com**.
  - If not using the default, the pod network CIDR and services network CIDR must be identified, which are set by default to **10.128.0.0/14** and **172.30.0.0/16**, respectively. These CIDRs are used for pod-to-pod and pod-to-service communication and are not accessible externally; however, they must not overlap with existing subnets in your organization.
  - The following vCenter information:
    - vCenter hostname, username, and password
    - Datacenter name, such as **SDDC-Datacenter**
    - Cluster name, such as **Cluster-1**
    - Network name
    - Datastore name, such as **WorkloadDatastore**

**NOTE**

It is recommended to move your vSphere cluster to the VMC **Compute-ResourcePool** resource pool after your cluster installation is finished.

- A Linux-based host deployed to VMC as a bastion.
  - The bastion host can be Red Hat Enterprise Linux (RHEL) or any another Linux-based host; it must have internet connectivity and the ability to upload an OVA to the ESXi hosts.
  - Download and install the OpenShift CLI tools to the bastion host.
    - The **openshift-install** installation program
    - The OpenShift CLI (**oc**) tool

**NOTE**

You cannot use the VMware NSX Container Plugin for Kubernetes (NCP), and NSX is not used as the OpenShift SDN. The version of NSX currently available with VMC is incompatible with the version of NCP certified with OpenShift Container Platform.

However, the NSX DHCP service is used for virtual machine IP management with the full-stack automated OpenShift Container Platform deployment and with nodes provisioned, either manually or automatically, by the Machine API integration with vSphere. Additionally, NSX firewall rules are created to enable access with the OpenShift Container Platform cluster and between the bastion host and the VMC vSphere hosts.

**21.5.1.1. VMC Sizer tool**

VMware Cloud on AWS is built on top of AWS bare metal infrastructure; this is the same bare metal infrastructure which runs AWS native services. When a VMware cloud on AWS software-defined data center (SDDC) is deployed, you consume these physical server nodes and run the VMware ESXi hypervisor in a single tenant fashion. This means the physical infrastructure is not accessible to anyone else using VMC. It is important to consider how many physical hosts you will need to host your virtual infrastructure.

To determine this, VMware provides the [VMC on AWS Sizer](#). With this tool, you can define the resources you intend to host on VMC:

- Types of workloads
- Total number of virtual machines
- Specification information such as:
  - Storage requirements
  - vCPUs
  - vRAM
  - Overcommit ratios

With these details, the sizer tool can generate a report, based on VMware best practices, and recommend your cluster configuration and the number of hosts you will need.

**21.5.2. vSphere prerequisites**

- You reviewed details about the [OpenShift Container Platform installation and update](#) processes.
- You read the documentation on [selecting a cluster installation method and preparing it for users](#).
- You [created a registry on your mirror host](#) and obtained the **imageContentSources** data for your version of OpenShift Container Platform.

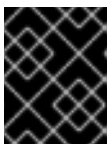
**IMPORTANT**

Because the installation media is on the mirror host, you can use that computer to complete all installation steps.

- You provisioned [block registry storage](#). For more information on persistent storage, see [Understanding persistent storage](#).
- If you use a firewall and plan to use the Telemetry service, you [configured the firewall to allow the sites](#) that your cluster requires access to.

**NOTE**

If you are configuring a proxy, be sure to also review this site list.

### 21.5.3. About installations in restricted networks

In OpenShift Container Platform 4.10, you can perform an installation that does not require an active connection to the internet to obtain software components. Restricted network installations can be completed using installer-provisioned infrastructure or user-provisioned infrastructure, depending on the cloud platform to which you are installing the cluster.

If you choose to perform a restricted network installation on a cloud platform, you still require access to its cloud APIs. Some cloud functions, like Amazon Web Service's Route 53 DNS and IAM services, require internet access. Depending on your network, you might require less internet access for an installation on bare metal hardware or on VMware vSphere.

To complete a restricted network installation, you must create a registry that mirrors the contents of the OpenShift image registry and contains the installation media. You can create this registry on a mirror host, which can access both the internet and your closed network, or by using other methods that meet your restrictions.

#### 21.5.3.1. Additional limits

Clusters in restricted networks have the following additional limitations and restrictions:

- The **ClusterVersion** status includes an **Unable to retrieve available updates** error.
- By default, you cannot use the contents of the Developer Catalog because you cannot access the required image stream tags.

### 21.5.4. Internet access for OpenShift Container Platform

In OpenShift Container Platform 4.10, you require access to the internet to obtain the images that are necessary to install your cluster.

You must have internet access to:

- Access [OpenShift Cluster Manager](#) to download the installation program and perform subscription management. If the cluster has internet access and you do not disable Telemetry, that service automatically entitles your cluster.
- Access [Quay.io](#) to obtain the packages that are required to install your cluster.
- Obtain the packages that are required to perform cluster updates.

**IMPORTANT**

If your cluster cannot have direct internet access, you can perform a restricted network installation on some types of infrastructure that you provision. During that process, you download the required content and use it to populate a mirror registry with the installation packages. With some installation types, the environment that you install your cluster in will not require internet access. Before you update the cluster, you update the content of the mirror registry.

**21.5.5. VMware vSphere infrastructure requirements**

You must install the OpenShift Container Platform cluster on a VMware vSphere version 7 instance that meets the requirements for the components that you use.

**NOTE**

OpenShift Container Platform version 4.10 does not support VMware vSphere version 8.0.

You can host the VMware vSphere infrastructure on-premise or on a [VMware Cloud Verified provider](#) that meets the requirements outlined in the following table:

**Table 21.38. Version requirements for vSphere virtual environments**

Virtual environment product	Required version
VM hardware version	15 or later
vSphere ESXi hosts	7
vCenter host	7

**IMPORTANT**

Installing a cluster on VMware vSphere version 7.0 Update 1 is now deprecated. These versions are still fully supported, but version 4.10 of OpenShift Container Platform requires vSphere virtual hardware version 15 or later. Hardware version 15 is now the default for vSphere virtual machines in OpenShift Container Platform. To update the hardware version for your vSphere nodes, see the "Updating hardware on nodes running in vSphere" article.

If your vSphere nodes are below hardware version 15 or your VMware vSphere version is earlier than 6.7U3, upgrading from OpenShift Container Platform 4.10 to OpenShift Container Platform 4.11 is not available.

**Table 21.39. Minimum supported vSphere version for VMware components**

Component	Minimum supported versions	Description
-----------	----------------------------	-------------

Component	Minimum supported versions	Description
Hypervisor	vSphere 7 with HW version 15	This version is the minimum version that Red Hat Enterprise Linux CoreOS (RHCOS) supports. For more information about supported hardware on the latest version of Red Hat Enterprise Linux (RHEL) that is compatible with RHCOS, see <a href="#">Hardware</a> on the Red Hat Customer Portal.
Storage with in-tree drivers	vSphere 7	This plugin creates vSphere storage by using the in-tree storage drivers for vSphere included in OpenShift Container Platform.

If you use a vSphere version 6.5 instance, upgrade to 7.0 before you install OpenShift Container Platform.

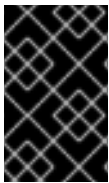

### IMPORTANT

You must ensure that the time on your ESXi hosts is synchronized before you install OpenShift Container Platform. See [Edit Time Configuration for a Host](#) in the VMware documentation.

## 21.5.6. Network connectivity requirements

You must configure the network connectivity between machines to allow OpenShift Container Platform cluster components to communicate.

Review the following details about the required network ports.

**Table 21.40. Ports used for all-machine to all-machine communications**

Protocol	Port	Description
ICMP	N/A	Network reachability tests
TCP	<b>1936</b>	Metrics
	<b>9000-9999</b>	Host level services, including the node exporter on ports <b>9100-9101</b> and the Cluster Version Operator on port <b>9099</b> .
	<b>10250-10259</b>	The default ports that Kubernetes reserves
	<b>10256</b>	openshift-sdn

Protocol	Port	Description
UDP	<b>4789</b>	virtual extensible LAN (VXLAN)
	<b>6081</b>	Geneve
	<b>9000-9999</b>	Host level services, including the node exporter on ports <b>9100-9101</b> .
	<b>500</b>	IPsec IKE packets
	<b>4500</b>	IPsec NAT-T packets
TCP/UDP	<b>30000-32767</b>	Kubernetes node port
ESP	N/A	IPsec Encapsulating Security Payload (ESP)

Table 21.41. Ports used for all-machine to control plane communications

Protocol	Port	Description
TCP	<b>6443</b>	Kubernetes API

Table 21.42. Ports used for control plane machine to control plane machine communications

Protocol	Port	Description
TCP	<b>2379-2380</b>	etcd server and peer ports

### 21.5.7. VMware vSphere CSI Driver Operator requirements

To install the vSphere CSI Driver Operator, the following requirements must be met:

- VMware vSphere version 6.7U3 or later
- Virtual machines of hardware version 15 or later
- No third-party vSphere CSI driver already installed in the cluster



## IMPORTANT

If a third-party vSphere CSI driver is present in the cluster, OpenShift Container Platform does not overwrite it. If you continue with the third-party vSphere CSI driver when upgrading to the next major version of OpenShift Container Platform, the **oc** CLI prompts you with the following message:

```
VSphereCSIDriverOperatorCRUpgradeable: VMwareVSphereControllerUpgradeable:
found existing unsupported csi.vsphere.vmware.com driver
```

The previous message informs you that Red Hat does not support the third-party vSphere CSI driver during an OpenShift Container Platform upgrade operation. You can choose to ignore this message and continue with the upgrade operation.

### Additional resources

- To remove a third-party CSI driver, see [Removing a third-party vSphere CSI Driver](#) .
- To update the hardware version for your vSphere nodes, see [Updating hardware on nodes running in vSphere](#).

## 21.5.8. vCenter requirements

Before you install an OpenShift Container Platform cluster on your vCenter that uses infrastructure that the installer provisions, you must prepare your environment.

### Required vCenter account privileges

To install an OpenShift Container Platform cluster in a vCenter, the installation program requires access to an account with privileges to read and create the required resources. Using an account that has global administrative privileges is the simplest way to access all of the necessary permissions.

If you cannot use an account with global administrative privileges, you must create roles to grant the privileges necessary for OpenShift Container Platform cluster installation. While most of the privileges are always required, some are required only if you plan for the installation program to provision a folder to contain the OpenShift Container Platform cluster on your vCenter instance, which is the default behavior. You must create or amend vSphere roles for the specified objects to grant the required privileges.

An additional role is required if the installation program is to create a vSphere virtual machine folder.

### Example 21.10. Roles and privileges required for installation in vSphere API

vSphere object for role	When required	Required privileges in vSphere API
-------------------------	---------------	------------------------------------



vSphere object for role	When required	Required privileges in vSphere API
vSphere vCenter	Always	<b>Cns.Searchable</b> <b>InventoryService.Tagging.AttachTag</b> <b>InventoryService.Tagging.CreateCategory</b> <b>InventoryService.Tagging.CreateTag</b> <b>InventoryService.Tagging.DeleteCategory</b> <b>InventoryService.Tagging.DeleteTag</b> <b>InventoryService.Tagging.EditCategory</b> <b>InventoryService.Tagging.EditTag</b> <b>Sessions.ValidateSession</b> <b>StorageProfile.Update</b> <b>StorageProfile.View</b>
vSphere vCenter Cluster	If VMs will be created in the cluster root	<b>Host.Config.StorageResource.AssignVMToPool</b> <b>VApp.AssignResourcePool</b> <b>VApp.Import</b> <b>VirtualMachine.Config.AddNewDisk</b>
vSphere vCenter Resource Pool	If an existing resource pool is provided	<b>Host.Config.StorageResource.AssignVMToPool</b> <b>VApp.AssignResourcePool</b> <b>VApp.Import</b> <b>VirtualMachine.Config.AddNewDisk</b>
vSphere Datastore	Always	<b>Datastore.AllocateSpace</b> <b>Datastore.Browse</b> <b>Datastore.FileManagement</b> <b>InventoryService.Tagging.ObjectAttachable</b>
vSphere Port Group	Always	<b>Network.Assign</b>
Virtual Machine Folder	Always	<b>InventoryService.Tagging.ObjectAttachable</b> <b>Resource.AssignVMToPool</b> <b>VApp.Import</b> <b>VirtualMachine.Config.AddExistingDisk</b> <b>VirtualMachine.Config.AddNewDisk</b> <b>VirtualMachine.Config.Add</b>

vSphere object for role	When required	RemoveDevice Required privileges in vSphere API VirtualMachine.Config.AdvancedConfig
		VirtualMachine.Config.Annotation VirtualMachine.Config.CPUCount VirtualMachine.Config.DiskExtend VirtualMachine.Config.DiskLease VirtualMachine.Config.EditDevice VirtualMachine.Config.Memory VirtualMachine.Config.RemoveDisk VirtualMachine.Config.Rename VirtualMachine.Config.ResetGuestInfo VirtualMachine.Config.Resource VirtualMachine.Config.Settings VirtualMachine.Config.UpgradeVirtualHardware VirtualMachine.Interact.GuestControl VirtualMachine.Interact.PowerOff VirtualMachine.Interact.PowerOn VirtualMachine.Interact.Reset VirtualMachine.Inventory.Create VirtualMachine.Inventory.CreateFromExisting VirtualMachine.Inventory.Delete VirtualMachine.Provisioning.Clone VirtualMachine.Provisioning.MarkAsTemplate VirtualMachine.Provisioning.DeployTemplate
vSphere vCenter Datacenter	If the installation program creates the virtual machine folder	InventoryService.Tagging.ObjectAttachable Resource.AssignVMToPool VApp.Import VirtualMachine.Config.AddExistingDisk VirtualMachine.Config.AddNewDisk

vSphere object for role	When required	Required privileges in vSphere API
		<b>VirtualMachine.Config.AddRemoveDevice</b> <b>VirtualMachine.Config.AdvancedConfig</b> <b>VirtualMachine.Config.Annotation</b> <b>VirtualMachine.Config.CPUCount</b> <b>VirtualMachine.Config.DiskExtend</b> <b>VirtualMachine.Config.DiskLease</b> <b>VirtualMachine.Config.EditDevice</b> <b>VirtualMachine.Config.Memory</b> <b>VirtualMachine.Config.RemoveDisk</b> <b>VirtualMachine.Config.Rename</b> <b>VirtualMachine.Config.ResetGuestInfo</b> <b>VirtualMachine.Config.Resource</b> <b>VirtualMachine.Config.Settings</b> <b>VirtualMachine.Config.UpgradeVirtualHardware</b> <b>VirtualMachine.Interact.GuestControl</b> <b>VirtualMachine.Interact.PowerOff</b> <b>VirtualMachine.Interact.PowerOn</b> <b>VirtualMachine.Interact.Reset</b> <b>VirtualMachine.Inventory.Create</b> <b>VirtualMachine.Inventory.CreateFromExisting</b> <b>VirtualMachine.Inventory.Delete</b> <b>VirtualMachine.Provisioning.Clone</b> <b>VirtualMachine.Provisioning.DeployTemplate</b> <b>VirtualMachine.Provisioning.MarkAsTemplate</b> <b>Folder.Create</b> <b>Folder.Delete</b>

Example 21.11. Roles and privileges required for installation in vCenter graphical user interface (GUI)

vSphere object for role	When required	Required privileges in vCenter GUI
vSphere vCenter	Always	<b>Cns.Searchable</b> <b>"vSphere Tagging"."Assign or Unassign vSphere Tag"</b> <b>"vSphere Tagging"."Create vSphere Tag Category"</b> <b>"vSphere Tagging"."Create vSphere Tag"</b> <b>vSphere Tagging"."Delete vSphere Tag Category"</b> <b>"vSphere Tagging"."Delete vSphere Tag"</b> <b>"vSphere Tagging"."Edit vSphere Tag Category"</b> <b>"vSphere Tagging"."Edit vSphere Tag"</b> <b>Sessions."Validate session"</b> <b>"Profile-driven storage"."Profile-driven storage update"</b> <b>"Profile-driven storage"."Profile-driven storage view"</b>
vSphere vCenter Cluster	If VMs will be created in the cluster root	<b>Host.Configuration."Storage partition configuration" Resource."Assign virtual machine to resource pool"</b> <b>VApp."Assign resource pool"</b> <b>VApp.Import</b> <b>"Virtual machine"."Change Configuration"."Add new disk"</b>
vSphere vCenter Resource Pool	If an existing resource pool is provided	<b>Host.Configuration."Storage partition configuration" Resource."Assign virtual machine to resource pool"</b> <b>VApp."Assign resource pool"</b> <b>VApp.Import</b> <b>"Virtual machine"."Change Configuration"."Add new disk"</b>

vSphere object for role	When required	Required privileges in vCenter GUI
vSphere Datastore	Always	<b>Datastore."Allocate space"</b> <b>Datastore."Browse datastore"</b> <b>Datastore."Low level file operations"</b> <b>"vSphere Tagging"."Assign or Unassign vSphere Tag on Object"</b>
vSphere Port Group	Always	<b>Network."Assign network"</b>
Virtual Machine Folder	Always	<b>"vSphere Tagging"."Assign or Unassign vSphere Tag on Object"</b> <b>Resource."Assign virtual machine to resource pool"</b> <b>VApp.Import</b> <b>"Virtual machine"."Change Configuration"."Add existing disk"</b> <b>"Virtual machine"."Change Configuration"."Add new disk"</b> <b>"Virtual machine"."Change Configuration"."Add or remove device"</b> <b>"Virtual machine"."Change Configuration"."Advanced configuration"</b> <b>"Virtual machine"."Change Configuration"."Set annotation"</b> <b>"Virtual machine"."Change Configuration"."Change CPU count"</b> <b>"Virtual machine"."Change Configuration"."Extend virtual disk"</b> <b>"Virtual machine"."Change Configuration"."Acquire disk lease"</b> <b>"Virtual machine"."Change Configuration"."Modify device settings"</b> <b>"Virtual machine"."Change Configuration"."Change Memory"</b> <b>"Virtual machine"."Change Configuration"."Remove disk"</b> <b>"Virtual machine"."Change</b>

vSphere object for role	When required	Configuration".Rename Virtual machine".Change GUI Configuration".Reset guest information"
		"Virtual machine".Change Configuration".Change resource" "Virtual machine".Change Configuration".Change Settings" "Virtual machine".Change Configuration".Upgrade virtual machine compatibility" "Virtual machine".Interaction."Gues t operating system management by VIX API" "Virtual machine".Interaction."Powe r off" "Virtual machine".Interaction."Powe r on" "Virtual machine".Interaction.Reset "Virtual machine".Edit Inventory".Create new" "Virtual machine".Edit Inventory".Create from existing" "Virtual machine".Edit Inventory".Remove" "Virtual machine".Provisioning."Clo ne virtual machine" "Virtual machine".Provisioning."Mar k as template" "Virtual machine".Provisioning."De ploy template"
vSphere vCenter Datacenter	If the installation program creates the virtual machine folder	"vSphere Tagging".Assign or Unassign vSphere Tag on Object" Resource."Assign virtual machine to resource pool" VApp.Import "Virtual machine".Change Configuration".Add existing disk" "Virtual machine".Change Configuration".Add new disk"

vSphere object for role	When required	Required privileges in vCenter GUI
		<p>"Virtual machine"."Change Configuration".Add or remove device"</p> <p>"Virtual machine"."Change Configuration"."Advanced configuration"</p> <p>"Virtual machine"."Change Configuration"."Set annotation"</p> <p>"Virtual machine"."Change Configuration"."Change CPU count"</p> <p>"Virtual machine"."Change Configuration"."Extend virtual disk"</p> <p>"Virtual machine"."Change Configuration"."Acquire disk lease"</p> <p>"Virtual machine"."Change Configuration"."Modify device settings"</p> <p>"Virtual machine"."Change Configuration"."Change Memory"</p> <p>"Virtual machine"."Change Configuration"."Remove disk"</p> <p>"Virtual machine"."Change Configuration".Rename</p> <p>"Virtual machine"."Change Configuration"."Reset guest information"</p> <p>"Virtual machine"."Change Configuration"."Change resource"</p> <p>"Virtual machine"."Change Configuration"."Change Settings"</p> <p>"Virtual machine"."Change Configuration"."Upgrade virtual machine compatibility"</p> <p>"Virtual machine".Interaction."Guest operating system management by VIX API"</p> <p>"Virtual machine".Interaction."Power off"</p> <p>"Virtual machine".Interaction."Power on"</p> <p>"Virtual machine".Interaction.Reset</p> <p>"Virtual machine"."Edit Inventory"."Create new"</p>

vSphere object for role	When required	"Virtual machine". "Edit Inventory". "Create from existing"
		"Virtual machine". "Edit Inventory". "Remove" "Virtual machine". Provisioning. "Clone virtual machine" "Virtual machine". Provisioning. "Deploy template" "Virtual machine". Provisioning. "Mark as template" Folder. "Create folder" Folder. "Delete folder"

Additionally, the user requires some **ReadOnly** permissions, and some of the roles require permission to propagate the permissions to child objects. These settings vary depending on whether or not you install the cluster into an existing folder.

#### Example 21.12. Required permissions and propagation settings

vSphere object	When required	Propagate to children	Permissions required
vSphere vCenter	Always	False	Listed required privileges
vSphere vCenter Datacenter	Existing folder	False	<b>ReadOnly</b> permission
	Installation program creates the folder	True	Listed required privileges
vSphere vCenter Cluster	Existing resource pool	False	<b>ReadOnly</b> permission
	VMs in cluster root	True	Listed required privileges
vSphere vCenter Datastore	Always	False	Listed required privileges
vSphere Switch	Always	False	<b>ReadOnly</b> permission
vSphere Port Group	Always	False	Listed required privileges
vSphere vCenter Virtual Machine Folder	Existing folder	True	Listed required privileges



vSphere object	When required	Propagate to children	Permissions required
vSphere vCenter Resource Pool	Existing resource pool	True	Listed required privileges

For more information about creating an account with only the required privileges, see [vSphere Permissions and User Management Tasks](#) in the vSphere documentation.

### Using OpenShift Container Platform with vMotion

If you intend on using vMotion in your vSphere environment, consider the following before installing a OpenShift Container Platform cluster.

- OpenShift Container Platform generally supports compute-only vMotion. Using Storage vMotion can cause issues and is not supported.  
To help ensure the uptime of your compute and control plane nodes, it is recommended that you follow the VMware best practices for vMotion. It is also recommended to use VMware anti-affinity rules to improve the availability of OpenShift Container Platform during maintenance or hardware issues.

For more information about vMotion and anti-affinity rules, see the VMware vSphere documentation for [vMotion networking requirements](#) and [VM anti-affinity rules](#).

- If you are using vSphere volumes in your pods, migrating a VM across datastores either manually or through Storage vMotion causes, invalid references within OpenShift Container Platform persistent volume (PV) objects. These references prevent affected pods from starting up and can result in data loss.
- Similarly, OpenShift Container Platform does not support selective migration of VMDKs across datastores, using datastore clusters for VM provisioning or for dynamic or static provisioning of PVs, or using a datastore that is part of a datastore cluster for dynamic or static provisioning of PVs.

### Cluster resources

When you deploy an OpenShift Container Platform cluster that uses installer-provisioned infrastructure, the installation program must be able to create several resources in your vCenter instance.

A standard OpenShift Container Platform installation creates the following vCenter resources:

- 1 Folder
- 1 Tag category
- 1 Tag
- Virtual machines:
  - 1 template
  - 1 temporary bootstrap node
  - 3 control plane nodes
  - 3 compute machines

Although these resources use 856 GB of storage, the bootstrap node is destroyed during the cluster installation process. A minimum of 800 GB of storage is required to use a standard cluster.

If you deploy more compute machines, the OpenShift Container Platform cluster will use more storage.

### Cluster limits

Available resources vary between clusters. The number of possible clusters within a vCenter is limited primarily by available storage space and any limitations on the number of required resources. Be sure to consider both limitations to the vCenter resources that the cluster creates and the resources that you require to deploy a cluster, such as IP addresses and networks.

### Networking requirements

You must use the Dynamic Host Configuration Protocol (DHCP) for the network and ensure that the DHCP server is configured to provide persistent IP addresses to the cluster machines. In the DHCP lease, you must configure the DHCP to use the default gateway. All nodes must be in the same VLAN. You cannot scale the cluster using a second VLAN as a Day 2 operation. The VM in your restricted network must have access to vCenter so that it can provision and manage nodes, persistent volume claims (PVCs), and other resources. Additionally, you must create the following networking resources before you install the OpenShift Container Platform cluster:

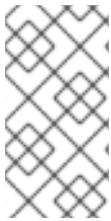

#### NOTE

It is recommended that each OpenShift Container Platform node in the cluster must have access to a Network Time Protocol (NTP) server that is discoverable via DHCP. Installation is possible without an NTP server. However, asynchronous server clocks will cause errors, which NTP server prevents.

### Required IP Addresses

An installer-provisioned vSphere installation requires two static IP addresses:

- The **API** address is used to access the cluster API.
- The **Ingress** address is used for cluster ingress traffic.

You must provide these IP addresses to the installation program when you install the OpenShift Container Platform cluster.

### DNS records

You must create DNS records for two static IP addresses in the appropriate DNS server for the vCenter instance that hosts your OpenShift Container Platform cluster. In each record, **<cluster\_name>** is the cluster name and **<base\_domain>** is the cluster base domain that you specify when you install the cluster. A complete DNS record takes the form: **<component>.<cluster\_name>.<base\_domain>..**

Table 21.43. Required DNS records

Component	Record	Description
API VIP	<b>api.&lt;cluster_name&gt;.&lt;base_domain&gt;..</b>	This DNS A/AAAA or CNAME record must point to the load balancer for the control plane machines. This record must be resolvable by both clients external to the cluster and from all the nodes within the cluster.

Component	Record	Description
Ingress VIP	*.apps.<cluster_name>.<base_domain>.	A wildcard DNS A/AAAA or CNAME record that points to the load balancer that targets the machines that run the Ingress router pods, which are the worker nodes by default. This record must be resolvable by both clients external to the cluster and from all the nodes within the cluster.

### 21.5.9. Generating a key pair for cluster node SSH access

During an OpenShift Container Platform installation, you can provide an SSH public key to the installation program. The key is passed to the Red Hat Enterprise Linux CoreOS (RHCOS) nodes through their Ignition config files and is used to authenticate SSH access to the nodes. The key is added to the `~/.ssh/authorized_keys` list for the **core** user on each node, which enables password-less authentication.

After the key is passed to the nodes, you can use the key pair to SSH in to the RHCOS nodes as the user **core**. To access the nodes through SSH, the private key identity must be managed by SSH for your local user.

If you want to SSH in to your cluster nodes to perform installation debugging or disaster recovery, you must provide the SSH public key during the installation process. The `./openshift-install gather` command also requires the SSH public key to be in place on the cluster nodes.



#### IMPORTANT

Do not skip this procedure in production environments, where disaster recovery and debugging is required.



#### NOTE

You must use a local key, not one that you configured with platform-specific approaches such as [AWS key pairs](#).

#### Procedure

1. If you do not have an existing SSH key pair on your local machine to use for authentication onto your cluster nodes, create one. For example, on a computer that uses a Linux operating system, run the following command:

```
$ ssh-keygen -t ed25519 -N "" -f <path>/<file_name> 1
```

- 1 Specify the path and file name, such as `~/.ssh/id_ed25519`, of the new SSH key. If you have an existing key pair, ensure your public key is in the your `~/.ssh` directory.

**NOTE**

If you plan to install an OpenShift Container Platform cluster that uses FIPS validated or Modules In Process cryptographic libraries on the **x86\_64** architecture, do not create a key that uses the **ed25519** algorithm. Instead, create a key that uses the **rsa** or **ecdsa** algorithm.

2. View the public SSH key:

```
$ cat <path>/<file_name>.pub
```

For example, run the following to view the `~/.ssh/id_ed25519.pub` public key:

```
$ cat ~/.ssh/id_ed25519.pub
```

3. Add the SSH private key identity to the SSH agent for your local user, if it has not already been added. SSH agent management of the key is required for password-less SSH authentication onto your cluster nodes, or if you want to use the `./openshift-install gather` command.

**NOTE**

On some distributions, default SSH private key identities such as `~/.ssh/id_rsa` and `~/.ssh/id_dsa` are managed automatically.

- a. If the **ssh-agent** process is not already running for your local user, start it as a background task:

```
$ eval "$(ssh-agent -s)"
```

**Example output**

```
Agent pid 31874
```

**NOTE**

If your cluster is in FIPS mode, only use FIPS-compliant algorithms to generate the SSH key. The key must be either RSA or ECDSA.

4. Add your SSH private key to the **ssh-agent**:

```
$ ssh-add <path>/<file_name> 1
```

- 1** Specify the path and file name for your SSH private key, such as `~/.ssh/id_ed25519`

**Example output**

```
Identity added: /home/<you>/<path>/<file_name> (<computer_name>)
```

**Next steps**

- When you install OpenShift Container Platform, provide the SSH public key to the installation program.

### 21.5.10. Adding vCenter root CA certificates to your system trust

Because the installation program requires access to your vCenter's API, you must add your vCenter's trusted root CA certificates to your system trust before you install an OpenShift Container Platform cluster.

#### Procedure

1. From the vCenter home page, download the vCenter's root CA certificates. Click **Download trusted root CA certificates** in the vSphere Web Services SDK section. The **<vCenter>/certs/download.zip** file downloads.
2. Extract the compressed file that contains the vCenter root CA certificates. The contents of the compressed file resemble the following file structure:

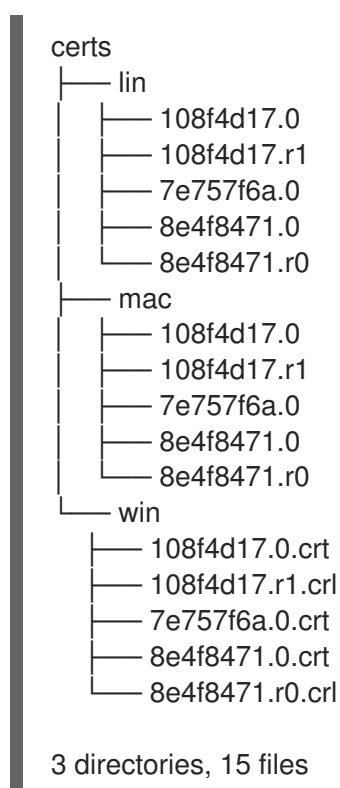

3. Add the files for your operating system to the system trust. For example, on a Fedora operating system, run the following command:

```
# cp certs/lin/* /etc/pki/ca-trust/source/anchors
```

4. Update your system trust. For example, on a Fedora operating system, run the following command:

```
# update-ca-trust extract
```

### 21.5.11. Creating the RHCOS image for restricted network installations

Download the Red Hat Enterprise Linux CoreOS (RHCOS) image to install OpenShift Container Platform on a restricted network VMware vSphere environment.

## Prerequisites

- Obtain the OpenShift Container Platform installation program. For a restricted network installation, the program is on your mirror registry host.

## Procedure

1. Log in to the Red Hat Customer Portal's [Product Downloads page](#).
2. Under **Version**, select the most recent release of OpenShift Container Platform 4.10 for RHEL 8.

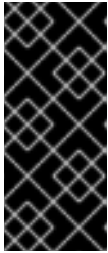

### IMPORTANT

The RHCOS images might not change with every release of OpenShift Container Platform. You must download images with the highest version that is less than or equal to the OpenShift Container Platform version that you install. Use the image versions that match your OpenShift Container Platform version if they are available.

3. Download the **Red Hat Enterprise Linux CoreOS (RHCOS) - vSphere** image.
4. Upload the image you downloaded to a location that is accessible from the bastion server.

The image is now available for a restricted installation. Note the image name or location for use in OpenShift Container Platform deployment.

## 21.5.12. Creating the installation configuration file

You can customize the OpenShift Container Platform cluster you install on VMware vSphere.

### Prerequisites

- Obtain the OpenShift Container Platform installation program and the pull secret for your cluster. For a restricted network installation, these files are on your mirror host.
- Have the **imageContentSources** values that were generated during mirror registry creation.
- Obtain the contents of the certificate for your mirror registry.
- Retrieve a Red Hat Enterprise Linux CoreOS (RHCOS) image and upload it to an accessible location.
- Obtain service principal permissions at the subscription level.

### Procedure

1. Create the **install-config.yaml** file.
  - a. Change to the directory that contains the installation program and run the following command:

```
$ ./openshift-install create install-config --dir <installation_directory> 1
```

- 1** For **<installation\_directory>**, specify the directory name to store the files that the

installation program creates.



### IMPORTANT

Specify an empty directory. Some installation assets, like bootstrap X.509 certificates have short expiration intervals, so you must not reuse an installation directory. If you want to reuse individual files from another cluster installation, you can copy them into your directory. However, the file names for the installation assets might change between releases. Use caution when copying installation files from an earlier OpenShift Container Platform version.

- b. At the prompts, provide the configuration details for your cloud:
  - i. Optional: Select an SSH key to use to access your cluster machines.



### NOTE

For production OpenShift Container Platform clusters on which you want to perform installation debugging or disaster recovery, specify an SSH key that your **ssh-agent** process uses.

- ii. Select **vsphere** as the platform to target.
  - iii. Specify the name of your vCenter instance.
  - iv. Specify the user name and password for the vCenter account that has the required permissions to create the cluster.  
The installation program connects to your vCenter instance.
  - v. Select the datacenter in your vCenter instance to connect to.
  - vi. Select the default vCenter datastore to use.
  - vii. Select the vCenter cluster to install the OpenShift Container Platform cluster in. The installation program uses the root resource pool of the vSphere cluster as the default resource pool.
  - viii. Select the network in the vCenter instance that contains the virtual IP addresses and DNS records that you configured.
  - ix. Enter the virtual IP address that you configured for control plane API access.
  - x. Enter the virtual IP address that you configured for cluster ingress.
  - xi. Enter the base domain. This base domain must be the same one that you used in the DNS records that you configured.
  - xii. Enter a descriptive name for your cluster. The cluster name you enter must match the cluster name you specified when configuring the DNS records.
  - xiii. Paste the [pull secret from the Red Hat OpenShift Cluster Manager](#) .
2. In the **install-config.yaml** file, set the value of **platform.vsphere.clusterOSImage** to the image location or name. For example:

```
platform:
  vsphere:
    clusterOSImage: http://mirror.example.com/images/rhcos-43.81.201912131630.0-
    vmware.x86_64.ova?
    sha256=ffebbd68e8a1f2a245ca19522c16c86f67f9ac8e4e0c1f0a812b068b16f7265d
```

3. Edit the **install-config.yaml** file to give the additional information that is required for an installation in a restricted network.

- a. Update the **pullSecret** value to contain the authentication information for your registry:

```
pullSecret: '{"auths":{"<mirror_host_name>:5000": {"auth": "<credentials>","email":
"you@example.com"}}}'
```

For **<mirror\_host\_name>**, specify the registry domain name that you specified in the certificate for your mirror registry, and for **<credentials>**, specify the base64-encoded user name and password for your mirror registry.

- b. Add the **additionalTrustBundle** parameter and value.

```
additionalTrustBundle: |
  -----BEGIN CERTIFICATE-----

  /-----/
  -----END CERTIFICATE-----
```

The value must be the contents of the certificate file that you used for your mirror registry. The certificate file can be an existing, trusted certificate authority, or the self-signed certificate that you generated for the mirror registry.

- c. Add the image content resources, which resemble the following YAML excerpt:

```
imageContentSources:
- mirrors:
  - <mirror_host_name>:5000/<repo_name>/release
    source: quay.io/openshift-release-dev/ocp-release
- mirrors:
  - <mirror_host_name>:5000/<repo_name>/release
    source: registry.redhat.io/ocp/release
```

For these values, use the **imageContentSources** that you recorded during mirror registry creation.

4. Make any other modifications to the **install-config.yaml** file that you require. You can find more information about the available parameters in the **Installation configuration parameters** section.
5. Back up the **install-config.yaml** file so that you can use it to install multiple clusters.

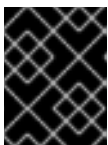

### IMPORTANT

The **install-config.yaml** file is consumed during the installation process. If you want to reuse the file, you must back it up now.



### 21.5.12.1. Installation configuration parameters

Before you deploy an OpenShift Container Platform cluster, you provide parameter values to describe your account on the cloud platform that hosts your cluster and optionally customize your cluster's platform. When you create the **install-config.yaml** installation configuration file, you provide values for the required parameters through the command line. If you customize your cluster, you can modify the **install-config.yaml** file to provide more details about the platform.



#### NOTE

After installation, you cannot modify these parameters in the **install-config.yaml** file.

#### 21.5.12.1.1. Required configuration parameters

Required installation configuration parameters are described in the following table:

Table 21.44. Required parameters

Parameter	Description	Values
<b>apiVersion</b>	The API version for the <b>install-config.yaml</b> content. The current version is <b>v1</b> . The installer may also support older API versions.	String
<b>baseDomain</b>	The base domain of your cloud provider. The base domain is used to create routes to your OpenShift Container Platform cluster components. The full DNS name for your cluster is a combination of the <b>baseDomain</b> and <b>metadata.name</b> parameter values that uses the <b>&lt;metadata.name&gt;</b> . <b>&lt;baseDomain&gt;</b> format.	A fully-qualified domain or subdomain name, such as <b>example.com</b> .
<b>metadata</b>	Kubernetes resource <b>ObjectMeta</b> , from which only the <b>name</b> parameter is consumed.	Object
<b>metadata.name</b>	The name of the cluster. DNS records for the cluster are all subdomains of <b>{{.metadata.name}}</b> . <b>{{.baseDomain}}</b> .	String of lowercase letters and hyphens (-), such as <b>dev</b> .

Parameter	Description	Values
<b>platform</b>	The configuration for the specific platform upon which to perform the installation: <b>alibabacloud</b> , <b>aws</b> , <b>baremetal</b> , <b>azure</b> , <b>gcp</b> , <b>ibmcloud</b> , <b>openstack</b> , <b>ovirt</b> , <b>vsphere</b> , or <b>{}</b> . For additional information about <b>platform.&lt;platform&gt;</b> parameters, consult the table for your specific platform that follows.	Object
<b>pullSecret</b>	Get a <a href="#">pull secret from the Red Hat OpenShift Cluster Manager</a> to authenticate downloading container images for OpenShift Container Platform components from services such as Quay.io.	<pre>{   "auths":{     "cloud.openshift.com":{       "auth":"b3Blb=",       "email":"you@example.com"     },     "quay.io":{       "auth":"b3Blb=",       "email":"you@example.com"     }   } }</pre>

### 21.5.12.1.2. Network configuration parameters

You can customize your installation configuration based on the requirements of your existing network infrastructure. For example, you can expand the IP address block for the cluster network or provide different IP address blocks than the defaults.

Only IPv4 addresses are supported.

Table 21.45. Network parameters

Parameter	Description	Values
-----------	-------------	--------

Parameter	Description	Values
<b>networking</b>	The configuration for the cluster network.	Object  <b>NOTE</b> You cannot modify parameters specified by the <b>networking</b> object after installation.
<b>networking.networkType</b>	The cluster network provider Container Network Interface (CNI) plugin to install.	Either <b>OpenShiftSDN</b> or <b>OVNKubernetes</b> . <b>OpenShiftSDN</b> is a CNI provider for all-Linux networks. <b>OVNKubernetes</b> is a CNI provider for Linux networks and hybrid networks that contain both Linux and Windows servers. The default value is <b>OpenShiftSDN</b> .
<b>networking.clusterNetwork</b>	The IP address blocks for pods.  The default value is <b>10.128.0.0/14</b> with a host prefix of <b>/23</b> .  If you specify multiple IP address blocks, the blocks must not overlap.	An array of objects. For example:  <pre>networking:   clusterNetwork:     - cidr: 10.128.0.0/14       hostPrefix: 23</pre>
<b>networking.clusterNetwork.cidr</b>	Required if you use <b>networking.clusterNetwork</b> . An IP address block.  An IPv4 network.	An IP address block in Classless Inter-Domain Routing (CIDR) notation. The prefix length for an IPv4 block is between <b>0</b> and <b>32</b> .
<b>networking.clusterNetwork.hostPrefix</b>	The subnet prefix length to assign to each individual node. For example, if <b>hostPrefix</b> is set to <b>23</b> then each node is assigned a <b>/23</b> subnet out of the given <b>cidr</b> . A <b>hostPrefix</b> value of <b>23</b> provides 510 ( $2^{(32 - 23)} - 2$ ) pod IP addresses.	A subnet prefix.  The default value is <b>23</b> .
<b>networking.serviceNetwork</b>	The IP address block for services. The default value is <b>172.30.0.0/16</b> .  The OpenShift SDN and OVN-Kubernetes network providers support only a single IP address block for the service network.	An array with an IP address block in CIDR format. For example:  <pre>networking:   serviceNetwork:     - 172.30.0.0/16</pre>

Parameter	Description	Values
<b>networking.machineNetwork</b>	The IP address blocks for machines.  If you specify multiple IP address blocks, the blocks must not overlap.	An array of objects. For example:  <pre>networking:   machineNetwork:   - cidr: 10.0.0.0/16</pre>
<b>networking.machineNetwork.cidr</b>	Required if you use <b>networking.machineNetwork</b> . An IP address block. The default value is <b>10.0.0.0/16</b> for all platforms other than libvirt. For libvirt, the default value is <b>192.168.126.0/24</b> .	An IP network block in CIDR notation.  For example, <b>10.0.0.0/16</b> .   <p><b>NOTE</b></p> <p>Set the <b>networking.machineNetwork</b> to match the CIDR that the preferred NIC resides in.</p>

### 21.5.12.1.3. Optional configuration parameters



Optional installation configuration parameters are described in the following table:

Table 21.46. Optional parameters

Parameter	Description	Values
<b>additionalTrustBundle</b>	A PEM-encoded X.509 certificate bundle that is added to the nodes' trusted certificate store. This trust bundle may also be used when a proxy has been configured.	String
<b>cgroupsV2</b>	Enables <a href="#">Linux control groups version 2</a> (cgroups v2) on specific nodes in your cluster. The OpenShift Container Platform process for enabling cgroups v2 disables all cgroup version 1 controllers and hierarchies. The OpenShift Container Platform cgroups version 2 feature is in Developer Preview and is not supported by Red Hat at this time.	<b>true</b>
<b>compute</b>	The configuration for the machines that comprise the compute nodes.	Array of <b>MachinePool</b> objects.



Parameter	Description	Values
<b>compute.architecture</b>	Determines the instruction set architecture of the machines in the pool. Currently, clusters with varied architectures are not supported. All pools must specify the same architecture. Valid values are <b>amd64</b> (the default).	String
<b>compute.hyperthreading</b>	Whether to enable or disable simultaneous multithreading, or <b>hyperthreading</b> , on compute machines. By default, simultaneous multithreading is enabled to increase the performance of your machines' cores.   <b>IMPORTANT</b>  If you disable simultaneous multithreading, ensure that your capacity planning accounts for the dramatically decreased machine performance.	<b>Enabled</b> or <b>Disabled</b>
<b>compute.name</b>	Required if you use <b>compute</b> . The name of the machine pool.	<b>worker</b>
<b>compute.platform</b>	Required if you use <b>compute</b> . Use this parameter to specify the cloud provider to host the worker machines. This parameter value must match the <b>controlPlane.platform</b> parameter value.	<b>alibabacloud, aws, azure, gcp, ibmcloud, openstack, ovirt, vsphere</b> , or <b>{}</b>
<b>compute.replicas</b>	The number of compute machines, which are also known as worker machines, to provision.	A positive integer greater than or equal to <b>2</b> . The default value is <b>3</b> .
<b>controlPlane</b>	The configuration for the machines that comprise the control plane.	Array of <b>MachinePool</b> objects.

Parameter	Description	Values
<b>controlPlane.architecture</b>	Determines the instruction set architecture of the machines in the pool. Currently, clusters with varied architectures are not supported. All pools must specify the same architecture. Valid values are <b>amd64</b> (the default).	String
<b>controlPlane.hyperthreading</b>	<p>Whether to enable or disable simultaneous multithreading, or <b>hyperthreading</b>, on control plane machines. By default, simultaneous multithreading is enabled to increase the performance of your machines' cores.</p> <div style="display: flex; align-items: center;">  <div> <p><b>IMPORTANT</b></p> <p>If you disable simultaneous multithreading, ensure that your capacity planning accounts for the dramatically decreased machine performance.</p> </div> </div>	<b>Enabled</b> or <b>Disabled</b>
<b>controlPlane.name</b>	Required if you use <b>controlPlane</b> . The name of the machine pool.	<b>master</b>
<b>controlPlane.platform</b>	Required if you use <b>controlPlane</b> . Use this parameter to specify the cloud provider that hosts the control plane machines. This parameter value must match the <b>compute.platform</b> parameter value.	<b>alibabacloud, aws, azure, gcp, ibmcloud, openstack, ovirt, vsphere</b> , or <b>{}</b>
<b>controlPlane.replicas</b>	The number of control plane machines to provision.	The only supported value is <b>3</b> , which is the default value.

Parameter	Description	Values
<b>credentialsMode</b>	<p>The Cloud Credential Operator (CCO) mode. If no mode is specified, the CCO dynamically tries to determine the capabilities of the provided credentials, with a preference for mint mode on the platforms where multiple modes are supported.</p> <div data-bbox="485 510 595 860" style="border: 1px solid black; padding: 5px; margin-bottom: 10px;">  </div> <p><b>NOTE</b></p> <p>Not all CCO modes are supported for all cloud providers. For more information on CCO modes, see the <i>Cloud Credential Operator</i> entry in the <i>Cluster Operators</i> reference content.</p> <div data-bbox="485 909 595 1258" style="border: 1px solid black; padding: 5px;">  </div> <p><b>NOTE</b></p> <p>If your AWS account has service control policies (SCP) enabled, you must configure the <b>credentialsMode</b> parameter to <b>Mint</b>, <b>Passthrough</b> or <b>Manual</b>.</p>	<b>Mint, Passthrough, Manual</b> or an empty string ("").

Parameter	Description	Values
<b>fips</b>	<p>Enable or disable FIPS mode. The default is <b>false</b> (disabled). If FIPS mode is enabled, the Red Hat Enterprise Linux CoreOS (RHCOS) machines that OpenShift Container Platform runs on bypass the default Kubernetes cryptography suite and use the cryptography modules that are provided with RHCOS instead.</p> <div style="display: flex; align-items: flex-start;"> <div style="width: 20px; height: 100px; background: repeating-linear-gradient(45deg, transparent, transparent 2px, black 2px, black 4px); margin-right: 10px;"></div> <div> <p><b>IMPORTANT</b></p> <p>To enable FIPS mode for your cluster, you must run the installation program from a Red Hat Enterprise Linux (RHEL) computer configured to operate in FIPS mode. For more information about configuring FIPS mode on RHEL, see <a href="#">Installing the system in FIPS mode</a>. The use of FIPS validated or Modules In Process cryptographic libraries is only supported on OpenShift Container Platform deployments on the <b>x86_64</b> architecture.</p> </div> </div> <div style="display: flex; align-items: flex-start; margin-top: 10px;"> <div style="width: 20px; height: 50px; background: repeating-linear-gradient(45deg, transparent, transparent 2px, black 2px, black 4px); margin-right: 10px;"></div> <div> <p><b>NOTE</b></p> <p>If you are using Azure File storage, you cannot enable FIPS mode.</p> </div> </div>	<b>false</b> or <b>true</b>
<b>imageContentSources</b>	Sources and repositories for the release-image content.	Array of objects. Includes a <b>source</b> and, optionally, <b>mirrors</b> , as described in the following rows of this table.
<b>imageContentSources.source</b>	Required if you use <b>imageContentSources</b> . Specify the repository that users refer to, for example, in image pull specifications.	String
<b>imageContentSources.mirrors</b>	Specify one or more repositories that may also contain the same images.	Array of strings



Parameter	Description	Values
<b>publish</b>	How to publish or expose the user-facing endpoints of your cluster, such as the Kubernetes API, OpenShift routes.	<p><b>Internal</b> or <b>External</b>. The default value is <b>External</b>.</p> <p>Setting this field to <b>Internal</b> is not supported on non-cloud platforms and IBM Cloud VPC.</p> <div style="display: flex; align-items: flex-start;">  <div> <p><b>IMPORTANT</b></p> <p>If the value of the field is set to <b>Internal</b>, the cluster will become non-functional. For more information, refer to <a href="#">BZ#1953035</a>.</p> </div> </div>
<b>sshKey</b>	<p>The SSH key or keys to authenticate access your cluster machines.</p> <div style="display: flex; align-items: flex-start;">  <div> <p><b>NOTE</b></p> <p>For production OpenShift Container Platform clusters on which you want to perform installation debugging or disaster recovery, specify an SSH key that your <b>ssh-agent</b> process uses.</p> </div> </div>	<p>One or more keys. For example:</p> <pre>sshKey:   &lt;key1&gt;   &lt;key2&gt;   &lt;key3&gt;</pre>

#### 21.5.12.1.4. Additional VMware vSphere configuration parameters

Additional VMware vSphere configuration parameters are described in the following table:

Table 21.47. Additional VMware vSphere cluster parameters

Parameter	Description	Values
<b>platform.vsphere.vCenter</b>	The fully-qualified hostname or IP address of the vCenter server.	String
<b>platform.vsphere.username</b>	The user name to use to connect to the vCenter instance with. This user must have at least the roles and privileges that are required for <a href="#">static or dynamic persistent volume provisioning</a> in vSphere.	String

Parameter	Description	Values
<b>platform.vsphere.password</b>	The password for the vCenter user name.	String
<b>platform.vsphere.datacenter</b>	The name of the datacenter to use in the vCenter instance.	String
<b>platform.vsphere.defaultDatastore</b>	The name of the default datastore to use for provisioning volumes.	String
<b>platform.vsphere.folder</b>	Optional. The absolute path of an existing folder where the installation program creates the virtual machines. If you do not provide this value, the installation program creates a folder that is named with the infrastructure ID in the datacenter virtual machine folder.	String, for example, <code>/&lt;datacenter_name&gt;/vm/&lt;folder_name&gt;/&lt;subfolder_name&gt;</code> .
<b>platform.vsphere.resourcePool</b>	Optional. The absolute path of an existing resource pool where the installer creates the virtual machines. If you do not specify a value, resources are installed in the root of the cluster <code>/&lt;datacenter_name&gt;/host/&lt;cluster_name&gt;/Resources</code> .	String, for example, <code>/&lt;datacenter_name&gt;/host/&lt;cluster_name&gt;/Resources/&lt;resource_pool_name&gt;/&lt;optional_nested_resource_pool_name&gt;</code> .
<b>platform.vsphere.network</b>	The network in the vCenter instance that contains the virtual IP addresses and DNS records that you configured.	String
<b>platform.vsphere.cluster</b>	The vCenter cluster to install the OpenShift Container Platform cluster in.	String
<b>platform.vsphere.apiVIP</b>	The virtual IP (VIP) address that you configured for control plane API access.	An IP address, for example <b>128.0.0.1</b> .
<b>platform.vsphere.ingressVIP</b>	The virtual IP (VIP) address that you configured for cluster ingress.	An IP address, for example <b>128.0.0.1</b> .
<b>platform.vsphere.diskType</b>	Optional. The disk provisioning method. This value defaults to the vSphere default storage policy if not set.	Valid values are <b>thin</b> , <b>thick</b> , or <b>eagerZeroedThick</b> .

#### 21.5.12.1.5. Optional VMware vSphere machine pool configuration parameters

Optional VMware vSphere machine pool configuration parameters are described in the following table:

**Table 21.48. Optional VMware vSphere machine pool parameters**

Parameter	Description	Values
<b>platform.vsphere.clusterOSImage</b>	The location from which the installer downloads the RHCOS image. You must set this parameter to perform an installation in a restricted network.	An HTTP or HTTPS URL, optionally with a SHA-256 checksum. For example, <b>https://mirror.openshift.com/images/rhcos-&lt;version&gt;-vmware.&lt;architecture&gt;.ova.</b>
<b>platform.vsphere.osDisk.diskSizeGB</b>	The size of the disk in gigabytes.	Integer
<b>platform.vsphere.cpus</b>	The total number of virtual processor cores to assign a virtual machine. The value of <b>platform.vsphere.cpus</b> must be a multiple of <b>platform.vsphere.coresPerSocket</b> value.	Integer
<b>platform.vsphere.coresPerSocket</b>	The number of cores per socket in a virtual machine. The number of virtual sockets on the virtual machine is <b>platform.vsphere.cpus/platform.vsphere.coresPerSocket</b> . The default value for control plane nodes and worker nodes is <b>4</b> and <b>2</b> , respectively.	Integer
<b>platform.vsphere.memoryMB</b>	The size of a virtual machine's memory in megabytes.	Integer

### 21.5.12.2. Sample install-config.yaml file for an installer-provisioned VMware vSphere cluster

You can customize the install-config.yaml file to specify more details about your OpenShift Container Platform cluster's platform or modify the values of the required parameters.

```

apiVersion: v1
baseDomain: example.com 1
compute: 2
- hypervthreading: Enabled 3
  name: worker
  replicas: 3
  platform:
    vsphere: 4
      cpus: 2
      coresPerSocket: 2
      memoryMB: 8192

```



- 3 6 Whether to enable or disable simultaneous multithreading, or **hyperthreading**. By default, simultaneous multithreading is enabled to increase the performance of your machines' cores. You



### IMPORTANT

If you disable simultaneous multithreading, ensure that your capacity planning accounts for the dramatically decreased machine performance. Your machines must use at least 8 CPUs and 32 GB of RAM if you disable simultaneous multithreading.

- 4 7 Optional: Provide additional configuration for the machine pool parameters for the compute and control plane machines.
- 8 The cluster name that you specified in your DNS records.
- 9 Optional: Provide an existing resource pool for machine creation. If you do not specify a value, the installation program uses the root resource pool of the vSphere cluster.
- 10 The vSphere disk provisioning method.
- 11 The vSphere cluster to install the OpenShift Container Platform cluster in.
- 12 The location of the Red Hat Enterprise Linux CoreOS (RHCOS) image that is accessible from the bastion server.
- 13 For **<local\_registry>**, specify the registry domain name, and optionally the port, that your mirror registry uses to serve content. For example **registry.example.com** or **registry.example.com:5000**. For **<credentials>**, specify the base64-encoded user name and password for your mirror registry.
- 14 Provide the contents of the certificate file that you used for your mirror registry.
- 15 Provide the **imageContentSources** section from the output of the command to mirror the repository.

### 21.5.12.3. Configuring the cluster-wide proxy during installation

Production environments can deny direct access to the internet and instead have an HTTP or HTTPS proxy available. You can configure a new OpenShift Container Platform cluster to use a proxy by configuring the proxy settings in the **install-config.yaml** file.

#### Prerequisites

- You have an existing **install-config.yaml** file.
- You reviewed the sites that your cluster requires access to and determined whether any of them need to bypass the proxy. By default, all cluster egress traffic is proxied, including calls to hosting cloud provider APIs. You added sites to the **Proxy** object's **spec.noProxy** field to bypass the proxy if necessary.



## NOTE

The **Proxy** object **status.noProxy** field is populated with the values of the **networking.machineNetwork[].cidr**, **networking.clusterNetwork[].cidr**, and **networking.serviceNetwork[]** fields from your installation configuration.

For installations on Amazon Web Services (AWS), Google Cloud Platform (GCP), Microsoft Azure, and Red Hat OpenStack Platform (RHOSP), the **Proxy** object **status.noProxy** field is also populated with the instance metadata endpoint (**169.254.169.254**).

## Procedure

1. Edit your **install-config.yaml** file and add the proxy settings. For example:

```
apiVersion: v1
baseDomain: my.domain.com
proxy:
  httpProxy: http://<username>:<pswd>@<ip>:<port> 1
  httpsProxy: https://<username>:<pswd>@<ip>:<port> 2
  noProxy: example.com 3
  additionalTrustBundle: | 4
    -----BEGIN CERTIFICATE-----
    <MY_TRUSTED_CA_CERT>
    -----END CERTIFICATE-----
  ...
```

- 1 A proxy URL to use for creating HTTP connections outside the cluster. The URL scheme must be **http**.
- 2 A proxy URL to use for creating HTTPS connections outside the cluster.
- 3 A comma-separated list of destination domain names, IP addresses, or other network CIDRs to exclude from proxying. Preface a domain with **.** to match subdomains only. For example, **.y.com** matches **x.y.com**, but not **y.com**. Use **\*** to bypass the proxy for all destinations. You must include vCenter's IP address and the IP range that you use for its machines.
- 4 If provided, the installation program generates a config map that is named **user-ca-bundle** in the **openshift-config** namespace that contains one or more additional CA certificates that are required for proxying HTTPS connections. The Cluster Network Operator then creates a **trusted-ca-bundle** config map that merges these contents with the Red Hat Enterprise Linux CoreOS (RHCOS) trust bundle, and this config map is referenced in the **trustedCA** field of the **Proxy** object. The **additionalTrustBundle** field is required unless the proxy's identity certificate is signed by an authority from the RHCOS trust bundle.



## NOTE

The installation program does not support the proxy **readinessEndpoints** field.

**NOTE**

If the installer times out, restart and then complete the deployment by using the **wait-for** command of the installer. For example:

```
$ ./openshift-install wait-for install-complete --log-level debug
```

2. Save the file and reference it when installing OpenShift Container Platform.

The installation program creates a cluster-wide proxy that is named **cluster** that uses the proxy settings in the provided **install-config.yaml** file. If no proxy settings are provided, a **cluster Proxy** object is still created, but it will have a nil **spec**.

**NOTE**

Only the **Proxy** object named **cluster** is supported, and no additional proxies can be created.

### 21.5.13. Deploying the cluster

You can install OpenShift Container Platform on a compatible cloud platform.

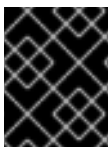
**IMPORTANT**

You can run the **create cluster** command of the installation program only once, during initial installation.

#### Prerequisites

- Configure an account with the cloud platform that hosts your cluster.
- Obtain the OpenShift Container Platform installation program and the pull secret for your cluster.

#### Procedure

1. Change to the directory that contains the installation program and initialize the cluster deployment:

```
$ ./openshift-install create cluster --dir <installation_directory> \ 1  
--log-level=info 2
```

- 1** For **<installation\_directory>**, specify the location of your customized **./install-config.yaml** file.
- 2** To view different installation details, specify **warn**, **debug**, or **error** instead of **info**.

**IMPORTANT**

Use the **openshift-install** command from the bastion hosted in the VMC environment.

**NOTE**

If the cloud provider account that you configured on your host does not have sufficient permissions to deploy the cluster, the installation process stops, and the missing permissions are displayed.

When the cluster deployment completes, directions for accessing your cluster, including a link to its web console and credentials for the **kubeadmin** user, display in your terminal.

**Example output**

```
...
INFO Install complete!
INFO To access the cluster as the system:admin user when using 'oc', run 'export
KUBECONFIG=/home/myuser/install_dir/auth/kubeconfig'
INFO Access the OpenShift web-console here: https://console-openshift-
console.apps.mycluster.example.com
INFO Login to the console with user: "kubeadmin", and password: "4vYBz-Ee6gm-ymBZj-
Wt5AL"
INFO Time elapsed: 36m22s
```

**NOTE**

The cluster access and credential information also outputs to **<installation\_directory>/openshift\_install.log** when an installation succeeds.

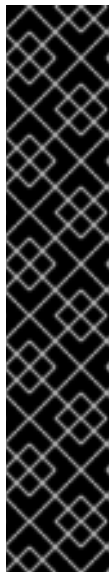
**IMPORTANT**

- The Ignition config files that the installation program generates contain certificates that expire after 24 hours, which are then renewed at that time. If the cluster is shut down before renewing the certificates and the cluster is later restarted after the 24 hours have elapsed, the cluster automatically recovers the expired certificates. The exception is that you must manually approve the pending **node-bootstrapper** certificate signing requests (CSRs) to recover kubelet certificates. See the documentation for *Recovering from expired control plane certificates* for more information.
- It is recommended that you use Ignition config files within 12 hours after they are generated because the 24-hour certificate rotates from 16 to 22 hours after the cluster is installed. By using the Ignition config files within 12 hours, you can avoid installation failure if the certificate update runs during installation.

**IMPORTANT**

You must not delete the installation program or the files that the installation program creates. Both are required to delete the cluster.

**21.5.14. Installing the OpenShift CLI by downloading the binary**

You can install the OpenShift CLI (**oc**) to interact with OpenShift Container Platform from a command-line interface. You can install **oc** on Linux, Windows, or macOS.





## IMPORTANT

If you installed an earlier version of **oc**, you cannot use it to complete all of the commands in OpenShift Container Platform 4.10. Download and install the new version of **oc**.

### Installing the OpenShift CLI on Linux

You can install the OpenShift CLI (**oc**) binary on Linux by using the following procedure.

#### Procedure

1. Navigate to the [OpenShift Container Platform downloads page](#) on the Red Hat Customer Portal.
2. Select the appropriate version in the **Version** drop-down menu.
3. Click **Download Now** next to the **OpenShift v4.10 Linux Client** entry and save the file.
4. Unpack the archive:

```
$ tar xvf <file>
```

5. Place the **oc** binary in a directory that is on your **PATH**.  
To check your **PATH**, execute the following command:

```
$ echo $PATH
```

After you install the OpenShift CLI, it is available using the **oc** command:

```
$ oc <command>
```

### Installing the OpenShift CLI on Windows

You can install the OpenShift CLI (**oc**) binary on Windows by using the following procedure.

#### Procedure

1. Navigate to the [OpenShift Container Platform downloads page](#) on the Red Hat Customer Portal.
2. Select the appropriate version in the **Version** drop-down menu.
3. Click **Download Now** next to the **OpenShift v4.10 Windows Client** entry and save the file.
4. Unzip the archive with a ZIP program.
5. Move the **oc** binary to a directory that is on your **PATH**.  
To check your **PATH**, open the command prompt and execute the following command:

```
C:\> path
```

After you install the OpenShift CLI, it is available using the **oc** command:

```
C:\> oc <command>
```

## Installing the OpenShift CLI on macOS

You can install the OpenShift CLI (**oc**) binary on macOS by using the following procedure.

### Procedure

1. Navigate to the [OpenShift Container Platform downloads page](#) on the Red Hat Customer Portal.
2. Select the appropriate version in the **Version** drop-down menu.
3. Click **Download Now** next to the **OpenShift v4.10 MacOSX Client** entry and save the file.
4. Unpack and unzip the archive.
5. Move the **oc** binary to a directory on your PATH.  
To check your **PATH**, open a terminal and execute the following command:

```
$ echo $PATH
```

After you install the OpenShift CLI, it is available using the **oc** command:

```
$ oc <command>
```

## 21.5.15. Logging in to the cluster by using the CLI

You can log in to your cluster as a default system user by exporting the cluster **kubeconfig** file. The **kubeconfig** file contains information about the cluster that is used by the CLI to connect a client to the correct cluster and API server. The file is specific to a cluster and is created during OpenShift Container Platform installation.

### Prerequisites

- You deployed an OpenShift Container Platform cluster.
- You installed the **oc** CLI.

### Procedure

1. Export the **kubeadmin** credentials:

```
$ export KUBECONFIG=<installation_directory>/auth/kubeconfig 1
```

- 1** For **<installation\_directory>**, specify the path to the directory that you stored the installation files in.

2. Verify you can run **oc** commands successfully using the exported configuration:

```
$ oc whoami
```

### Example output

```
system:admin
```

## 21.5.16. Disabling the default OperatorHub sources

Operator catalogs that source content provided by Red Hat and community projects are configured for OperatorHub by default during an OpenShift Container Platform installation. In a restricted network environment, you must disable the default catalogs as a cluster administrator.

### Procedure

- Disable the sources for the default catalogs by adding **disableAllDefaultSources: true** to the **OperatorHub** object:

```
$ oc patch OperatorHub cluster --type json \
  -p '[{"op": "add", "path": "/spec/disableAllDefaultSources", "value": true}]'
```

### TIP

Alternatively, you can use the web console to manage catalog sources. From the **Administration** → **Cluster Settings** → **Configuration** → **OperatorHub** page, click the **Sources** tab, where you can create, delete, disable, and enable individual sources.

## 21.5.17. Creating registry storage

After you install the cluster, you must create storage for the Registry Operator.

### 21.5.17.1. Image registry removed during installation

On platforms that do not provide shareable object storage, the OpenShift Image Registry Operator bootstraps itself as **Removed**. This allows **openshift-installer** to complete installations on these platform types.

After installation, you must edit the Image Registry Operator configuration to switch the **managementState** from **Removed** to **Managed**.

### 21.5.17.2. Image registry storage configuration

The Image Registry Operator is not initially available for platforms that do not provide default storage. After installation, you must configure your registry to use storage so that the Registry Operator is made available.

Instructions are shown for configuring a persistent volume, which is required for production clusters. Where applicable, instructions are shown for configuring an empty directory as the storage location, which is available for only non-production clusters.

Additional instructions are provided for allowing the image registry to use block storage types by using the **Recreate** rollout strategy during upgrades.

#### 21.5.17.2.1. Configuring registry storage for VMware vSphere

As a cluster administrator, following installation you must configure your registry to use storage.

### Prerequisites

- Cluster administrator permissions.

- A cluster on VMware vSphere.
- Persistent storage provisioned for your cluster, such as Red Hat OpenShift Data Foundation.

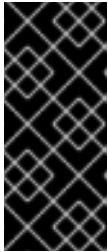

### IMPORTANT

OpenShift Container Platform supports **ReadWriteOnce** access for image registry storage when you have only one replica. **ReadWriteOnce** access also requires that the registry uses the **Recreate** rollout strategy. To deploy an image registry that supports high availability with two or more replicas, **ReadWriteMany** access is required.

- Must have "100Gi" capacity.

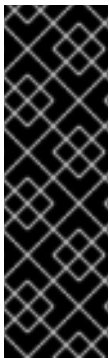

### IMPORTANT

Testing shows issues with using the NFS server on RHEL as storage backend for core services. This includes the OpenShift Container Registry and Quay, Prometheus for monitoring storage, and Elasticsearch for logging storage. Therefore, using RHEL NFS to back PVs used by core services is not recommended.

Other NFS implementations on the marketplace might not have these issues. Contact the individual NFS implementation vendor for more information on any testing that was possibly completed against these OpenShift Container Platform core components.

## Procedure

1. To configure your registry to use storage, change the **spec.storage.pvc** in the **configs.imageregistry/cluster** resource.



### NOTE

When using shared storage, review your security settings to prevent outside access.

2. Verify that you do not have a registry pod:

```
$ oc get pod -n openshift-image-registry -l docker-registry=default
```

### Example output

```
No resources found in openshift-image-registry namespace
```



### NOTE

If you do have a registry pod in your output, you do not need to continue with this procedure.

3. Check the registry configuration:

```
$ oc edit configs.imageregistry.operator.openshift.io
```

### Example output

```
storage:
  pvc:
    claim: 1
```

- 1 Leave the **claim** field blank to allow the automatic creation of an **image-registry-storage** persistent volume claim (PVC). The PVC is generated based on the default storage class. However, be aware that the default storage class might provide ReadWriteOnce (RWO) volumes, such as a RADOS Block Device (RBD), which can cause issues when replicating to more than one replica.

4. Check the **clusteroperator** status:

```
$ oc get clusteroperator image-registry
```

### Example output

NAME	VERSION	AVAILABLE	PROGRESSING	DEGRADED
image-registry	4.7	True	False	6h50m

## 21.5.18. Telemetry access for OpenShift Container Platform

In OpenShift Container Platform 4.10, the Telemetry service, which runs by default to provide metrics about cluster health and the success of updates, requires internet access. If your cluster is connected to the internet, Telemetry runs automatically, and your cluster is registered to [OpenShift Cluster Manager](#).

After you confirm that your [OpenShift Cluster Manager](#) inventory is correct, either maintained automatically by Telemetry or manually by using OpenShift Cluster Manager, [use subscription watch](#) to track your OpenShift Container Platform subscriptions at the account or multi-cluster level.

### Additional resources

- See [About remote health monitoring](#) for more information about the Telemetry service

## 21.5.19. Next steps

- [Customize your cluster](#).
- [Configure image streams](#) for the Cluster Samples Operator and the **must-gather** tool.
- Learn how to [use Operator Lifecycle Manager \(OLM\) on restricted networks](#) .
- If necessary, you can [opt out of remote health reporting](#) .
- [Set up your registry and configure registry storage](#) .

## 21.6. INSTALLING A CLUSTER ON VMC WITH USER-PROVISIONED INFRASTRUCTURE

In OpenShift Container Platform version 4.10, you can install a cluster on VMware vSphere infrastructure that you provision by deploying it to [VMware Cloud \(VMC\) on AWS](#).

Once you configure your VMC environment for OpenShift Container Platform deployment, you use the OpenShift Container Platform installation program from the bastion management host, co-located in the VMC environment. The installation program and control plane automates the process of deploying and managing the resources needed for the OpenShift Container Platform cluster.



#### NOTE

OpenShift Container Platform supports deploying a cluster to a single VMware vCenter only. Deploying a cluster with machines/machine sets on multiple vCenters is not supported.

### 21.6.1. Setting up VMC for vSphere

You can install OpenShift Container Platform on VMware Cloud (VMC) on AWS hosted vSphere clusters to enable applications to be deployed and managed both on-premise and off-premise, across the hybrid cloud.

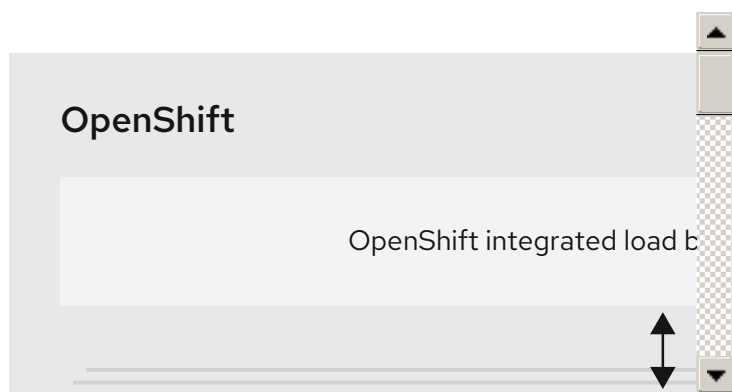

You must configure several options in your VMC environment prior to installing OpenShift Container Platform on VMware vSphere. Ensure your VMC environment has the following prerequisites:

- Create a non-exclusive, DHCP-enabled, NSX-T network segment and subnet. Other virtual machines (VMs) can be hosted on the subnet, but at least eight IP addresses must be available for the OpenShift Container Platform deployment.
- Configure the following firewall rules:
  - An ANY:ANY firewall rule between the OpenShift Container Platform compute network and the internet. This is used by nodes and applications to download container images.
  - An ANY:ANY firewall rule between the installation host and the software-defined data center (SDDC) management network on port 443. This allows you to upload the Red Hat Enterprise Linux CoreOS (RHCOS) OVA during deployment.
  - An HTTPS firewall rule between the OpenShift Container Platform compute network and vCenter. This connection allows OpenShift Container Platform to communicate with vCenter for provisioning and managing nodes, persistent volume claims (PVCs), and other resources.
- You must have the following information to deploy OpenShift Container Platform:
  - The OpenShift Container Platform cluster name, such as **vmc-prod-1**.

- The base DNS name, such as **companyname.com**.
- If not using the default, the pod network CIDR and services network CIDR must be identified, which are set by default to **10.128.0.0/14** and **172.30.0.0/16**, respectively. These CIDRs are used for pod-to-pod and pod-to-service communication and are not accessible externally; however, they must not overlap with existing subnets in your organization.
- The following vCenter information:
  - vCenter hostname, username, and password
  - Datacenter name, such as **SDDC-Datacenter**
  - Cluster name, such as **Cluster-1**
  - Network name
  - Datastore name, such as **WorkloadDatastore**



#### NOTE

It is recommended to move your vSphere cluster to the VMC **Compute-ResourcePool** resource pool after your cluster installation is finished.

- A Linux-based host deployed to VMC as a bastion.
  - The bastion host can be Red Hat Enterprise Linux (RHEL) or any another Linux-based host; it must have internet connectivity and the ability to upload an OVA to the ESXi hosts.
  - Download and install the OpenShift CLI tools to the bastion host.
    - The **openshift-install** installation program
    - The OpenShift CLI (**oc**) tool



#### NOTE

You cannot use the VMware NSX Container Plugin for Kubernetes (NCP), and NSX is not used as the OpenShift SDN. The version of NSX currently available with VMC is incompatible with the version of NCP certified with OpenShift Container Platform.

However, the NSX DHCP service is used for virtual machine IP management with the full-stack automated OpenShift Container Platform deployment and with nodes provisioned, either manually or automatically, by the Machine API integration with vSphere. Additionally, NSX firewall rules are created to enable access with the OpenShift Container Platform cluster and between the bastion host and the VMC vSphere hosts.

### 21.6.1.1. VMC Sizer tool

VMware Cloud on AWS is built on top of AWS bare metal infrastructure; this is the same bare metal infrastructure which runs AWS native services. When a VMware cloud on AWS software-defined data center (SDDC) is deployed, you consume these physical server nodes and run the VMware ESXi hypervisor in a single tenant fashion. This means the physical infrastructure is not accessible to anyone else using VMC. It is important to consider how many physical hosts you will need to host your virtual infrastructure.

To determine this, VMware provides the [VMC on AWS Sizer](#). With this tool, you can define the resources you intend to host on VMC:

- Types of workloads
- Total number of virtual machines
- Specification information such as:
  - Storage requirements
  - vCPUs
  - vRAM
  - Overcommit ratios

With these details, the sizer tool can generate a report, based on VMware best practices, and recommend your cluster configuration and the number of hosts you will need.

### 21.6.2. vSphere prerequisites

- You reviewed details about the [OpenShift Container Platform installation and update](#) processes.
- You read the documentation on [selecting a cluster installation method and preparing it for users](#).
- You provisioned [block registry storage](#). For more information on persistent storage, see [Understanding persistent storage](#).
- If you use a firewall, you [configured it to allow the sites](#) that your cluster requires access to.

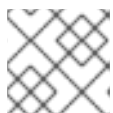

#### NOTE

Be sure to also review this site list if you are configuring a proxy.

### 21.6.3. Internet access for OpenShift Container Platform

In OpenShift Container Platform 4.10, you require access to the internet to install your cluster.

You must have internet access to:

- Access [OpenShift Cluster Manager](#) to download the installation program and perform subscription management. If the cluster has internet access and you do not disable Telemetry, that service automatically entitles your cluster.
- Access [Quay.io](#) to obtain the packages that are required to install your cluster.
- Obtain the packages that are required to perform cluster updates.



**IMPORTANT**

If your cluster cannot have direct internet access, you can perform a restricted network installation on some types of infrastructure that you provision. During that process, you download the required content and use it to populate a mirror registry with the installation packages. With some installation types, the environment that you install your cluster in will not require internet access. Before you update the cluster, you update the content of the mirror registry.

**21.6.4. VMware vSphere infrastructure requirements**

You must install the OpenShift Container Platform cluster on a VMware vSphere version 7 instance that meets the requirements for the components that you use.

**NOTE**

OpenShift Container Platform version 4.10 does not support VMware vSphere version 8.0.

You can host the VMware vSphere infrastructure on-premise or on a [VMware Cloud Verified provider](#) that meets the requirements outlined in the following table:

**Table 21.49. Version requirements for vSphere virtual environments**

Virtual environment product	Required version
VM hardware version	15 or later
vSphere ESXi hosts	7
vCenter host	7

**IMPORTANT**

Installing a cluster on VMware vSphere version 7.0 Update 1 is now deprecated. These versions are still fully supported, but version 4.10 of OpenShift Container Platform requires vSphere virtual hardware version 15 or later. Hardware version 15 is now the default for vSphere virtual machines in OpenShift Container Platform. To update the hardware version for your vSphere nodes, see the "Updating hardware on nodes running in vSphere" article.

If your vSphere nodes are below hardware version 15 or your VMware vSphere version is earlier than 6.7U3, upgrading from OpenShift Container Platform 4.10 to OpenShift Container Platform 4.11 is not available.

**Table 21.50. Minimum supported vSphere version for VMware components**

Component	Minimum supported versions	Description
-----------	----------------------------	-------------

Component	Minimum supported versions	Description
Hypervisor	vSphere 7 with HW version 15	This version is the minimum version that Red Hat Enterprise Linux CoreOS (RHCOS) supports. For more information about supported hardware on the latest version of Red Hat Enterprise Linux (RHEL) that is compatible with RHCOS, see <a href="#">Hardware</a> on the Red Hat Customer Portal.
Storage with in-tree drivers	vSphere 7	This plugin creates vSphere storage by using the in-tree storage drivers for vSphere included in OpenShift Container Platform.

If you use a vSphere version 6.5 instance, upgrade to 7.0 before you install OpenShift Container Platform.



### IMPORTANT

You must ensure that the time on your ESXi hosts is synchronized before you install OpenShift Container Platform. See [Edit Time Configuration for a Host](#) in the VMware documentation.

## 21.6.5. VMware vSphere CSI Driver Operator requirements

To install the vSphere CSI Driver Operator, the following requirements must be met:

- VMware vSphere version 6.7U3 or later
- Virtual machines of hardware version 15 or later
- No third-party vSphere CSI driver already installed in the cluster



### IMPORTANT

If a third-party vSphere CSI driver is present in the cluster, OpenShift Container Platform does not overwrite it. If you continue with the third-party vSphere CSI driver when upgrading to the next major version of OpenShift Container Platform, the **oc** CLI prompts you with the following message:

```
VSphereCSIDriverOperatorCRUpgradeable: VMwareVSphereControllerUpgradeable:
found existing unsupported csi.vsphere.vmware.com driver
```

The previous message informs you that Red Hat does not support the third-party vSphere CSI driver during an OpenShift Container Platform upgrade operation. You can choose to ignore this message and continue with the upgrade operation.

## Additional resources

- To remove a third-party CSI driver, see [Removing a third-party vSphere CSI Driver](#) .
- To update the hardware version for your vSphere nodes, see [Updating hardware on nodes running in vSphere](#).

## 21.6.6. Requirements for a cluster with user-provisioned infrastructure

For a cluster that contains user-provisioned infrastructure, you must deploy all of the required machines.

This section describes the requirements for deploying OpenShift Container Platform on user-provisioned infrastructure.

### 21.6.6.1. Required machines for cluster installation

The smallest OpenShift Container Platform clusters require the following hosts:

**Table 21.51. Minimum required hosts**

Hosts	Description
One temporary bootstrap machine	The cluster requires the bootstrap machine to deploy the OpenShift Container Platform cluster on the three control plane machines. You can remove the bootstrap machine after you install the cluster.
Three control plane machines	The control plane machines run the Kubernetes and OpenShift Container Platform services that form the control plane.
At least two compute machines, which are also known as worker machines.	The workloads requested by OpenShift Container Platform users run on the compute machines.

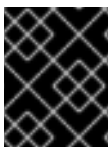

### IMPORTANT

To maintain high availability of your cluster, use separate physical hosts for these cluster machines.

The bootstrap and control plane machines must use Red Hat Enterprise Linux CoreOS (RHCOS) as the operating system. However, the compute machines can choose between Red Hat Enterprise Linux CoreOS (RHCOS), Red Hat Enterprise Linux (RHEL) 8.4, or RHEL 8.5.

Note that RHCOS is based on Red Hat Enterprise Linux (RHEL) 8 and inherits all of its hardware certifications and requirements. See [Red Hat Enterprise Linux technology capabilities and limits](#) .

### 21.6.6.2. Minimum resource requirements for cluster installation

Each cluster machine must meet the following minimum requirements:

**Table 21.52. Minimum resource requirements**

Machine	Operating System	vCPU [1]	Virtual RAM	Storage	IOPS [2]
Bootstrap	RHCOS	4	16 GB	100 GB	300
Control plane	RHCOS	4	16 GB	100 GB	300
Compute	RHCOS, RHEL 8.4, or RHEL 8.5 [3]	2	8 GB	100 GB	300

1. One vCPU is equivalent to one physical core when simultaneous multithreading (SMT), or hyperthreading, is not enabled. When enabled, use the following formula to calculate the corresponding ratio: (threads per core × cores) × sockets = vCPUs.
2. OpenShift Container Platform and Kubernetes are sensitive to disk performance, and faster storage is recommended, particularly for etcd on the control plane nodes which require a 10 ms p99 fsync duration. Note that on many cloud platforms, storage size and IOPS scale together, so you might need to over-allocate storage volume to obtain sufficient performance.
3. As with all user-provisioned installations, if you choose to use RHEL compute machines in your cluster, you take responsibility for all operating system life cycle management and maintenance, including performing system updates, applying patches, and completing all other required tasks. Use of RHEL 7 compute machines is deprecated and has been removed in OpenShift Container Platform 4.10 and later.

If an instance type for your platform meets the minimum requirements for cluster machines, it is supported to use in OpenShift Container Platform.

### 21.6.6.3. Certificate signing requests management

Because your cluster has limited access to automatic machine management when you use infrastructure that you provision, you must provide a mechanism for approving cluster certificate signing requests (CSRs) after installation. The **kube-controller-manager** only approves the kubelet client CSRs. The **machine-approver** cannot guarantee the validity of a serving certificate that is requested by using kubelet credentials because it cannot confirm that the correct machine issued the request. You must determine and implement a method of verifying the validity of the kubelet serving certificate requests and approving them.

### 21.6.6.4. Networking requirements for user-provisioned infrastructure

All the Red Hat Enterprise Linux CoreOS (RHCOS) machines require networking to be configured in **inittamfs** during boot to fetch their Ignition config files.

During the initial boot, the machines require an IP address configuration that is set either through a DHCP server or statically by providing the required boot options. After a network connection is established, the machines download their Ignition config files from an HTTP or HTTPS server. The Ignition config files are then used to set the exact state of each machine. The Machine Config Operator completes more changes to the machines, such as the application of new certificates or keys, after installation.

It is recommended to use a DHCP server for long-term management of the cluster machines. Ensure that the DHCP server is configured to provide persistent IP addresses, DNS server information, and hostnames to the cluster machines.



## NOTE

If a DHCP service is not available for your user-provisioned infrastructure, you can instead provide the IP networking configuration and the address of the DNS server to the nodes at RHCOS install time. These can be passed as boot arguments if you are installing from an ISO image. See the *Installing RHCOS and starting the OpenShift Container Platform bootstrap process* section for more information about static IP provisioning and advanced networking options.

The Kubernetes API server must be able to resolve the node names of the cluster machines. If the API servers and worker nodes are in different zones, you can configure a default DNS search zone to allow the API server to resolve the node names. Another supported approach is to always refer to hosts by their fully-qualified domain names in both the node objects and all DNS requests.

### 21.6.6.4.1. Setting the cluster node hostnames through DHCP

On Red Hat Enterprise Linux CoreOS (RHCOS) machines, the hostname is set through NetworkManager. By default, the machines obtain their hostname through DHCP. If the hostname is not provided by DHCP, set statically through kernel arguments, or another method, it is obtained through a reverse DNS lookup. Reverse DNS lookup occurs after the network has been initialized on a node and can take time to resolve. Other system services can start prior to this and detect the hostname as **localhost** or similar. You can avoid this by using DHCP to provide the hostname for each cluster node.

Additionally, setting the hostnames through DHCP can bypass any manual DNS record name configuration errors in environments that have a DNS split-horizon implementation.

### 21.6.6.4.2. Network connectivity requirements

You must configure the network connectivity between machines to allow OpenShift Container Platform cluster components to communicate. Each machine must be able to resolve the hostnames of all other machines in the cluster.

This section provides details about the ports that are required.



## IMPORTANT

In connected OpenShift Container Platform environments, all nodes are required to have internet access to pull images for platform containers and provide telemetry data to Red Hat.

Table 21.53. Ports used for all-machine to all-machine communications

Protocol	Port	Description
ICMP	N/A	Network reachability tests
TCP	<b>1936</b>	Metrics

Protocol	Port	Description
	<b>9000-9999</b>	Host level services, including the node exporter on ports <b>9100-9101</b> and the Cluster Version Operator on port <b>9099</b> .
	<b>10250-10259</b>	The default ports that Kubernetes reserves
	<b>10256</b>	openshift-sdn
UDP	<b>4789</b>	VXLAN
	<b>6081</b>	Geneve
	<b>9000-9999</b>	Host level services, including the node exporter on ports <b>9100-9101</b> .
	<b>500</b>	IPsec IKE packets
	<b>4500</b>	IPsec NAT-T packets
TCP/UDP	<b>30000-32767</b>	Kubernetes node port
ESP	N/A	IPsec Encapsulating Security Payload (ESP)

Table 21.54. Ports used for all-machine to control plane communications

Protocol	Port	Description
TCP	<b>6443</b>	Kubernetes API

Table 21.55. Ports used for control plane machine to control plane machine communications

Protocol	Port	Description
TCP	<b>2379-2380</b>	etcd server and peer ports

### Ethernet adaptor hardware address requirements

When provisioning VMs for the cluster, the ethernet interfaces configured for each VM must use a MAC address from the VMware Organizationally Unique Identifier (OUI) allocation ranges:

- **00:05:69:00:00:00** to **00:05:69:FF:FF:FF**
- **00:0c:29:00:00:00** to **00:0c:29:FF:FF:FF**
- **00:1c:14:00:00:00** to **00:1c:14:FF:FF:FF**
- **00:50:56:00:00:00** to **00:50:56:3F:FF:FF**

If a MAC address outside the VMware OUI is used, the cluster installation will not succeed.

### NTP configuration for user-provisioned infrastructure

OpenShift Container Platform clusters are configured to use a public Network Time Protocol (NTP) server by default. If you want to use a local enterprise NTP server, or if your cluster is being deployed in a disconnected network, you can configure the cluster to use a specific time server. For more information, see the documentation for *Configuring chrony time service*.

If a DHCP server provides NTP server information, the chrony time service on the Red Hat Enterprise Linux CoreOS (RHCOS) machines read the information and can sync the clock with the NTP servers.

#### 21.6.6.5. User-provisioned DNS requirements

In OpenShift Container Platform deployments, DNS name resolution is required for the following components:

- The Kubernetes API
- The OpenShift Container Platform application wildcard
- The bootstrap, control plane, and compute machines

Reverse DNS resolution is also required for the Kubernetes API, the bootstrap machine, the control plane machines, and the compute machines.

DNS A/AAAA or CNAME records are used for name resolution and PTR records are used for reverse name resolution. The reverse records are important because Red Hat Enterprise Linux CoreOS (RHCOS) uses the reverse records to set the hostnames for all the nodes, unless the hostnames are provided by DHCP. Additionally, the reverse records are used to generate the certificate signing requests (CSR) that OpenShift Container Platform needs to operate.



#### NOTE

It is recommended to use a DHCP server to provide the hostnames to each cluster node. See the *DHCP recommendations for user-provisioned infrastructure* section for more information.

The following DNS records are required for a user-provisioned OpenShift Container Platform cluster and they must be in place before installation. In each record, **<cluster\_name>** is the cluster name and **<base\_domain>** is the base domain that you specify in the **install-config.yaml** file. A complete DNS record takes the form: **<component>.<cluster\_name>.<base\_domain>.**

**Table 21.56. Required DNS records**

Component	Record	Description
Kubernetes API	<b>api.&lt;cluster_name&gt;.&lt;base_domain&gt;.</b>	A DNS A/AAAA or CNAME record, and a DNS PTR record, to identify the API load balancer. These records must be resolvable by both clients external to the cluster and from all the nodes within the cluster.

Component	Record	Description
	<b>api-int.&lt;cluster_name&gt;.&lt;base_domain&gt;.</b>	<p>A DNS A/AAAA or CNAME record, and a DNS PTR record, to internally identify the API load balancer. These records must be resolvable from all the nodes within the cluster.</p> <div style="display: flex; align-items: flex-start;">  <div> <p><b>IMPORTANT</b></p> <p>The API server must be able to resolve the worker nodes by the hostnames that are recorded in Kubernetes. If the API server cannot resolve the node names, then proxied API calls can fail, and you cannot retrieve logs from pods.</p> </div> </div>
Routes	<b>*.apps.&lt;cluster_name&gt;.&lt;base_domain&gt;.</b>	<p>A wildcard DNS A/AAAA or CNAME record that refers to the application ingress load balancer. The application ingress load balancer targets the machines that run the Ingress Controller pods. The Ingress Controller pods run on the compute machines by default. These records must be resolvable by both clients external to the cluster and from all the nodes within the cluster.</p> <p>For example, <b>console-openshift-console.apps.&lt;cluster_name&gt;.&lt;base_domain&gt;</b> is used as a wildcard route to the OpenShift Container Platform console.</p>
Bootstrap machine	<b>bootstrap.&lt;cluster_name&gt;.&lt;base_domain&gt;.</b>	A DNS A/AAAA or CNAME record, and a DNS PTR record, to identify the bootstrap machine. These records must be resolvable by the nodes within the cluster.
Control plane machines	<b>&lt;master&gt;&lt;n&gt;.&lt;cluster_name&gt;.&lt;base_domain&gt;.</b>	DNS A/AAAA or CNAME records and DNS PTR records to identify each machine for the control plane nodes. These records must be resolvable by the nodes within the cluster.
Compute machines	<b>&lt;worker&gt;&lt;n&gt;.&lt;cluster_name&gt;.&lt;base_domain&gt;.</b>	DNS A/AAAA or CNAME records and DNS PTR records to identify each machine for the worker nodes. These records must be resolvable by the nodes within the cluster.

**NOTE**

In OpenShift Container Platform 4.4 and later, you do not need to specify etcd host and SRV records in your DNS configuration.

**TIP**

You can use the **dig** command to verify name and reverse name resolution. See the section on *Validating DNS resolution for user-provisioned infrastructure* for detailed validation steps.



### 21.6.6.5.1. Example DNS configuration for user-provisioned clusters

This section provides A and PTR record configuration samples that meet the DNS requirements for deploying OpenShift Container Platform on user-provisioned infrastructure. The samples are not meant to provide advice for choosing one DNS solution over another.

In the examples, the cluster name is **ocp4** and the base domain is **example.com**.

#### Example DNS A record configuration for a user-provisioned cluster

The following example is a BIND zone file that shows sample A records for name resolution in a user-provisioned cluster.

##### Example 21.13. Sample DNS zone database

```
$TTL 1W
@ IN SOA ns1.example.com. root (
  2019070700 ; serial
  3H ; refresh (3 hours)
  30M ; retry (30 minutes)
  2W ; expiry (2 weeks)
  1W ) ; minimum (1 week)
IN NS ns1.example.com.
IN MX 10 smtp.example.com.
;
;
ns1.example.com. IN A 192.168.1.5
smtp.example.com. IN A 192.168.1.5
;
helper.example.com. IN A 192.168.1.5
helper.ocp4.example.com. IN A 192.168.1.5
;
api.ocp4.example.com. IN A 192.168.1.5 1
api-int.ocp4.example.com. IN A 192.168.1.5 2
;
*.apps.ocp4.example.com. IN A 192.168.1.5 3
;
bootstrap.ocp4.example.com. IN A 192.168.1.96 4
;
master0.ocp4.example.com. IN A 192.168.1.97 5
master1.ocp4.example.com. IN A 192.168.1.98 6
master2.ocp4.example.com. IN A 192.168.1.99 7
;
worker0.ocp4.example.com. IN A 192.168.1.11 8
worker1.ocp4.example.com. IN A 192.168.1.7 9
;
;EOF
```

- 1 Provides name resolution for the Kubernetes API. The record refers to the IP address of the API load balancer.
- 2 Provides name resolution for the Kubernetes API. The record refers to the IP address of the API load balancer and is used for internal cluster communications.
- 3 Provides name resolution for the wildcard routes. The record refers to the IP address of the

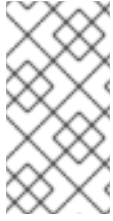
**NOTE**

In the example, the same load balancer is used for the Kubernetes API and application ingress traffic. In production scenarios, you can deploy the API and application ingress load balancers separately so that you can scale the load balancer infrastructure for each in isolation.

- 4 Provides name resolution for the bootstrap machine.
- 5 6 7 Provides name resolution for the control plane machines.
- 8 9 Provides name resolution for the compute machines.

**Example DNS PTR record configuration for a user-provisioned cluster**

The following example BIND zone file shows sample PTR records for reverse name resolution in a user-provisioned cluster.

**Example 21.14. Sample DNS zone database for reverse records**

```
$TTL 1W
@ IN SOA ns1.example.com. root (
    2019070700 ; serial
    3H ; refresh (3 hours)
    30M ; retry (30 minutes)
    2W ; expiry (2 weeks)
    1W ) ; minimum (1 week)
IN NS ns1.example.com.
;
5.1.168.192.in-addr.arpa. IN PTR api.ocp4.example.com. 1
5.1.168.192.in-addr.arpa. IN PTR api-int.ocp4.example.com. 2
;
96.1.168.192.in-addr.arpa. IN PTR bootstrap.ocp4.example.com. 3
;
97.1.168.192.in-addr.arpa. IN PTR master0.ocp4.example.com. 4
98.1.168.192.in-addr.arpa. IN PTR master1.ocp4.example.com. 5
99.1.168.192.in-addr.arpa. IN PTR master2.ocp4.example.com. 6
;
11.1.168.192.in-addr.arpa. IN PTR worker0.ocp4.example.com. 7
7.1.168.192.in-addr.arpa. IN PTR worker1.ocp4.example.com. 8
;
;EOF
```

- 1 Provides reverse DNS resolution for the Kubernetes API. The PTR record refers to the record name of the API load balancer.
- 2 Provides reverse DNS resolution for the Kubernetes API. The PTR record refers to the record name of the API load balancer and is used for internal cluster communications.
- 3 Provides reverse DNS resolution for the bootstrap machine.
- 4 5 6 Provides reverse DNS resolution for the control plane machines.

**7 8** Provides reverse DNS resolution for the compute machines.



#### NOTE

A PTR record is not required for the OpenShift Container Platform application wildcard.

### 21.6.6.6. Load balancing requirements for user-provisioned infrastructure

Before you install OpenShift Container Platform, you must provision the API and application ingress load balancing infrastructure. In production scenarios, you can deploy the API and application ingress load balancers separately so that you can scale the load balancer infrastructure for each in isolation.



#### NOTE

If you want to deploy the API and application Ingress load balancers with a Red Hat Enterprise Linux (RHEL) instance, you must purchase the RHEL subscription separately.

The load balancing infrastructure must meet the following requirements:

1. **API load balancer.** Provides a common endpoint for users, both human and machine, to interact with and configure the platform. Configure the following conditions:
  - Layer 4 load balancing only. This can be referred to as Raw TCP, SSL Passthrough, or SSL Bridge mode. If you use SSL Bridge mode, you must enable Server Name Indication (SNI) for the API routes.
  - A stateless load balancing algorithm. The options vary based on the load balancer implementation.



#### IMPORTANT

Do not configure session persistence for an API load balancer. Configuring session persistence for a Kubernetes API server might cause performance issues from excess application traffic for your OpenShift Container Platform cluster and the Kubernetes API that runs inside the cluster.

Configure the following ports on both the front and back of the load balancers:

**Table 21.57. API load balancer**

Port	Back-end machines (pool members)	Internal	External	Description
<b>6443</b>	Bootstrap and control plane. You remove the bootstrap machine from the load balancer after the bootstrap machine initializes the cluster control plane. You must configure the <b>/readyz</b> endpoint for the API server health check probe.	X	X	Kubernetes API server

Port	Back-end machines (pool members)	Internal	External	Description
<b>22623</b>	Bootstrap and control plane. You remove the bootstrap machine from the load balancer after the bootstrap machine initializes the cluster control plane.	X		Machine config server

**NOTE**

The load balancer must be configured to take a maximum of 30 seconds from the time the API server turns off the **/readyz** endpoint to the removal of the API server instance from the pool. Within the time frame after **/readyz** returns an error or becomes healthy, the endpoint must have been removed or added. Probing every 5 or 10 seconds, with two successful requests to become healthy and three to become unhealthy, are well-tested values.

2. **Application Ingress load balancer.** Provides an ingress point for application traffic flowing in from outside the cluster. A working configuration for the Ingress router is required for an OpenShift Container Platform cluster.

Configure the following conditions:

- Layer 4 load balancing only. This can be referred to as Raw TCP, SSL Passthrough, or SSL Bridge mode. If you use SSL Bridge mode, you must enable Server Name Indication (SNI) for the ingress routes.
- A connection-based or session-based persistence is recommended, based on the options available and types of applications that will be hosted on the platform.

**TIP**

If the true IP address of the client can be seen by the application Ingress load balancer, enabling source IP-based session persistence can improve performance for applications that use end-to-end TLS encryption.

Configure the following ports on both the front and back of the load balancers:

**Table 21.58. Application Ingress load balancer**

Port	Back-end machines (pool members)	Internal	External	Description
<b>443</b>	The machines that run the Ingress Controller pods, compute, or worker, by default.	X	X	HTTPS traffic
<b>80</b>	The machines that run the Ingress Controller pods, compute, or worker, by default.	X	X	HTTP traffic

**NOTE**

If you are deploying a three-node cluster with zero compute nodes, the Ingress Controller pods run on the control plane nodes. In three-node cluster deployments, you must configure your application Ingress load balancer to route HTTP and HTTPS traffic to the control plane nodes.

**21.6.6.6.1. Example load balancer configuration for user-provisioned clusters**

This section provides an example API and application ingress load balancer configuration that meets the load balancing requirements for user-provisioned clusters. The sample is an `/etc/haproxy/haproxy.cfg` configuration for an HAProxy load balancer. The example is not meant to provide advice for choosing one load balancing solution over another.

In the example, the same load balancer is used for the Kubernetes API and application ingress traffic. In production scenarios, you can deploy the API and application ingress load balancers separately so that you can scale the load balancer infrastructure for each in isolation.

**NOTE**

If you are using HAProxy as a load balancer and SELinux is set to **enforcing**, you must ensure that the HAProxy service can bind to the configured TCP port by running **setsebool -P haproxy\_connect\_any=1**.

**Example 21.15. Sample API and application Ingress load balancer configuration**

```

global
  log      127.0.0.1 local2
  pidfile  /var/run/haproxy.pid
  maxconn  4000
  daemon
defaults
  mode            http
  log             global
  option          dontlognull
  option http-server-close
  option          redispatch
  retries         3
  timeout http-request  10s
  timeout queue       1m
  timeout connect    10s
  timeout client     1m
  timeout server     1m
  timeout http-keep-alive 10s
  timeout check      10s
  maxconn          3000
listen api-server-6443 1
  bind *:6443
  mode tcp
  server bootstrap bootstrap.ocp4.example.com:6443 check inter 1s backup 2
  server master0 master0.ocp4.example.com:6443 check inter 1s
  server master1 master1.ocp4.example.com:6443 check inter 1s
  server master2 master2.ocp4.example.com:6443 check inter 1s
listen machine-config-server-22623 3

```

```

bind *:22623
mode tcp
server bootstrap bootstrap.ocp4.example.com:22623 check inter 1s backup 4
server master0 master0.ocp4.example.com:22623 check inter 1s
server master1 master1.ocp4.example.com:22623 check inter 1s
server master2 master2.ocp4.example.com:22623 check inter 1s
listen ingress-router-443 5
bind *:443
mode tcp
balance source
server worker0 worker0.ocp4.example.com:443 check inter 1s
server worker1 worker1.ocp4.example.com:443 check inter 1s
listen ingress-router-80 6
bind *:80
mode tcp
balance source
server worker0 worker0.ocp4.example.com:80 check inter 1s
server worker1 worker1.ocp4.example.com:80 check inter 1s

```

- 1** Port **6443** handles the Kubernetes API traffic and points to the control plane machines.
- 2** **4** The bootstrap entries must be in place before the OpenShift Container Platform cluster installation and they must be removed after the bootstrap process is complete.
- 3** Port **22623** handles the machine config server traffic and points to the control plane machines.
- 5** Port **443** handles the HTTPS traffic and points to the machines that run the Ingress Controller pods. The Ingress Controller pods run on the compute machines by default.
- 6** Port **80** handles the HTTP traffic and points to the machines that run the Ingress Controller pods. The Ingress Controller pods run on the compute machines by default.



#### NOTE

If you are deploying a three-node cluster with zero compute nodes, the Ingress Controller pods run on the control plane nodes. In three-node cluster deployments, you must configure your application Ingress load balancer to route HTTP and HTTPS traffic to the control plane nodes.

#### TIP

If you are using HAProxy as a load balancer, you can check that the **haproxy** process is listening on ports **6443**, **22623**, **443**, and **80** by running **netstat -nltp** on the HAProxy node.

### 21.6.7. Preparing the user-provisioned infrastructure

Before you install OpenShift Container Platform on user-provisioned infrastructure, you must prepare the underlying infrastructure.

This section provides details about the high-level steps required to set up your cluster infrastructure in preparation for an OpenShift Container Platform installation. This includes configuring IP networking and network connectivity for your cluster nodes, enabling the required ports through your firewall, and

setting up the required DNS and load balancing infrastructure.

After preparation, your cluster infrastructure must meet the requirements outlined in the *Requirements for a cluster with user-provisioned infrastructure* section.

## Prerequisites

- You have reviewed the [OpenShift Container Platform 4.x Tested Integrations](#) page.
- You have reviewed the infrastructure requirements detailed in the *Requirements for a cluster with user-provisioned infrastructure* section.

## Procedure

1. If you are using DHCP to provide the IP networking configuration to your cluster nodes, configure your DHCP service.
  - a. Add persistent IP addresses for the nodes to your DHCP server configuration. In your configuration, match the MAC address of the relevant network interface to the intended IP address for each node.
  - b. When you use DHCP to configure IP addressing for the cluster machines, the machines also obtain the DNS server information through DHCP. Define the persistent DNS server address that is used by the cluster nodes through your DHCP server configuration.



### NOTE

If you are not using a DHCP service, you must provide the IP networking configuration and the address of the DNS server to the nodes at RHCOS install time. These can be passed as boot arguments if you are installing from an ISO image. See the *Installing RHCOS and starting the OpenShift Container Platform bootstrap process* section for more information about static IP provisioning and advanced networking options.

- c. Define the hostnames of your cluster nodes in your DHCP server configuration. See the *Setting the cluster node hostnames through DHCP* section for details about hostname considerations.



### NOTE

If you are not using a DHCP service, the cluster nodes obtain their hostname through a reverse DNS lookup.

2. Ensure that your network infrastructure provides the required network connectivity between the cluster components. See the *Networking requirements for user-provisioned infrastructure* section for details about the requirements.
3. Configure your firewall to enable the ports required for the OpenShift Container Platform cluster components to communicate. See *Networking requirements for user-provisioned infrastructure* section for details about the ports that are required.

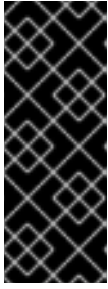
**IMPORTANT**

By default, port **1936** is accessible for an OpenShift Container Platform cluster, because each control plane node needs access to this port.

Avoid using the Ingress load balancer to expose this port, because doing so might result in the exposure of sensitive information, such as statistics and metrics, related to Ingress Controllers.

4. Setup the required DNS infrastructure for your cluster.
  - a. Configure DNS name resolution for the Kubernetes API, the application wildcard, the bootstrap machine, the control plane machines, and the compute machines.
  - b. Configure reverse DNS resolution for the Kubernetes API, the bootstrap machine, the control plane machines, and the compute machines.  
See the *User-provisioned DNS requirements* section for more information about the OpenShift Container Platform DNS requirements.
5. Validate your DNS configuration.
  - a. From your installation node, run DNS lookups against the record names of the Kubernetes API, the wildcard routes, and the cluster nodes. Validate that the IP addresses in the responses correspond to the correct components.
  - b. From your installation node, run reverse DNS lookups against the IP addresses of the load balancer and the cluster nodes. Validate that the record names in the responses correspond to the correct components.  
See the *Validating DNS resolution for user-provisioned infrastructure* section for detailed DNS validation steps.
6. Provision the required API and application ingress load balancing infrastructure. See the *Load balancing requirements for user-provisioned infrastructure* section for more information about the requirements.

**NOTE**

Some load balancing solutions require the DNS name resolution for the cluster nodes to be in place before the load balancing is initialized.

**21.6.8. Validating DNS resolution for user-provisioned infrastructure**

You can validate your DNS configuration before installing OpenShift Container Platform on user-provisioned infrastructure.

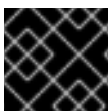
**IMPORTANT**

The validation steps detailed in this section must succeed before you install your cluster.

**Prerequisites**

- You have configured the required DNS records for your user-provisioned infrastructure.

**Procedure**



1. From your installation node, run DNS lookups against the record names of the Kubernetes API, the wildcard routes, and the cluster nodes. Validate that the IP addresses contained in the responses correspond to the correct components.
  - a. Perform a lookup against the Kubernetes API record name. Check that the result points to the IP address of the API load balancer:

```
$ dig +noall +answer @<nameserver_ip> api.<cluster_name>.<base_domain> 1
```

- 1 Replace **<nameserver\_ip>** with the IP address of the nameserver, **<cluster\_name>** with your cluster name, and **<base\_domain>** with your base domain name.

#### Example output

```
api.ocp4.example.com. 0 IN A 192.168.1.5
```

- b. Perform a lookup against the Kubernetes internal API record name. Check that the result points to the IP address of the API load balancer:

```
$ dig +noall +answer @<nameserver_ip> api-int.<cluster_name>.<base_domain>
```

#### Example output

```
api-int.ocp4.example.com. 0 IN A 192.168.1.5
```

- c. Test an example **\*.apps.<cluster\_name>.<base\_domain>** DNS wildcard lookup. All of the application wildcard lookups must resolve to the IP address of the application ingress load balancer:

```
$ dig +noall +answer @<nameserver_ip> random.apps.<cluster_name>.<base_domain>
```

#### Example output

```
random.apps.ocp4.example.com. 0 IN A 192.168.1.5
```



#### NOTE

In the example outputs, the same load balancer is used for the Kubernetes API and application ingress traffic. In production scenarios, you can deploy the API and application ingress load balancers separately so that you can scale the load balancer infrastructure for each in isolation.

You can replace **random** with another wildcard value. For example, you can query the route to the OpenShift Container Platform console:

```
$ dig +noall +answer @<nameserver_ip> console-openshift-console.apps.<cluster_name>.<base_domain>
```

#### Example output

```
console-openshift-console.apps.ocp4.example.com. 0 IN A 192.168.1.5
```

- d. Run a lookup against the bootstrap DNS record name. Check that the result points to the IP address of the bootstrap node:

```
$ dig +noall +answer @<nameserver_ip> bootstrap.<cluster_name>.<base_domain>
```

### Example output

```
bootstrap.ocp4.example.com. 0 IN A 192.168.1.96
```

- e. Use this method to perform lookups against the DNS record names for the control plane and compute nodes. Check that the results correspond to the IP addresses of each node.
2. From your installation node, run reverse DNS lookups against the IP addresses of the load balancer and the cluster nodes. Validate that the record names contained in the responses correspond to the correct components.

- a. Perform a reverse lookup against the IP address of the API load balancer. Check that the response includes the record names for the Kubernetes API and the Kubernetes internal API:

```
$ dig +noall +answer @<nameserver_ip> -x 192.168.1.5
```

### Example output

```
5.1.168.192.in-addr.arpa. 0 IN PTR api-int.ocp4.example.com. 1  
5.1.168.192.in-addr.arpa. 0 IN PTR api.ocp4.example.com. 2
```

**1** Provides the record name for the Kubernetes internal API.

**2** Provides the record name for the Kubernetes API.



### NOTE

A PTR record is not required for the OpenShift Container Platform application wildcard. No validation step is needed for reverse DNS resolution against the IP address of the application ingress load balancer.

- b. Perform a reverse lookup against the IP address of the bootstrap node. Check that the result points to the DNS record name of the bootstrap node:

```
$ dig +noall +answer @<nameserver_ip> -x 192.168.1.96
```

### Example output

```
96.1.168.192.in-addr.arpa. 0 IN PTR bootstrap.ocp4.example.com.
```

- c. Use this method to perform reverse lookups against the IP addresses for the control plane and compute nodes. Check that the results correspond to the DNS record names of each node.

## 21.6.9. Generating a key pair for cluster node SSH access

During an OpenShift Container Platform installation, you can provide an SSH public key to the installation program. The key is passed to the Red Hat Enterprise Linux CoreOS (RHCOS) nodes through their Ignition config files and is used to authenticate SSH access to the nodes. The key is added to the `~/.ssh/authorized_keys` list for the **core** user on each node, which enables password-less authentication.

After the key is passed to the nodes, you can use the key pair to SSH in to the RHCOS nodes as the user **core**. To access the nodes through SSH, the private key identity must be managed by SSH for your local user.

If you want to SSH in to your cluster nodes to perform installation debugging or disaster recovery, you must provide the SSH public key during the installation process. The `./openshift-install gather` command also requires the SSH public key to be in place on the cluster nodes.

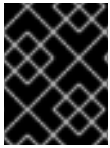

### IMPORTANT

Do not skip this procedure in production environments, where disaster recovery and debugging is required.



### NOTE

You must use a local key, not one that you configured with platform-specific approaches such as [AWS key pairs](#).

### Procedure

1. If you do not have an existing SSH key pair on your local machine to use for authentication onto your cluster nodes, create one. For example, on a computer that uses a Linux operating system, run the following command:

```
$ ssh-keygen -t ed25519 -N "" -f <path>/<file_name> 1
```

- 1 Specify the path and file name, such as `~/.ssh/id_ed25519`, of the new SSH key. If you have an existing key pair, ensure your public key is in the your `~/.ssh` directory.

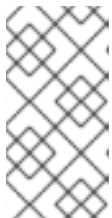

### NOTE

If you plan to install an OpenShift Container Platform cluster that uses FIPS validated or Modules In Process cryptographic libraries on the **x86\_64** architecture, do not create a key that uses the **ed25519** algorithm. Instead, create a key that uses the **rsa** or **ecdsa** algorithm.

2. View the public SSH key:

```
$ cat <path>/<file_name>.pub
```

For example, run the following to view the `~/.ssh/id_ed25519.pub` public key:

```
$ cat ~/.ssh/id_ed25519.pub
```

3. Add the SSH private key identity to the SSH agent for your local user, if it has not already been added. SSH agent management of the key is required for password-less SSH authentication onto your cluster nodes, or if you want to use the **./openshift-install gather** command.

**NOTE**

On some distributions, default SSH private key identities such as `~/.ssh/id_rsa` and `~/.ssh/id_dsa` are managed automatically.

- a. If the **ssh-agent** process is not already running for your local user, start it as a background task:

```
$ eval "$(ssh-agent -s)"
```

**Example output**

```
Agent pid 31874
```

**NOTE**

If your cluster is in FIPS mode, only use FIPS-compliant algorithms to generate the SSH key. The key must be either RSA or ECDSA.

4. Add your SSH private key to the **ssh-agent**:

```
$ ssh-add <path>/<file_name> 1
```

- 1** Specify the path and file name for your SSH private key, such as `~/.ssh/id_ed25519`

**Example output**

```
Identity added: /home/<you>/<path>/<file_name> (<computer_name>)
```

**Next steps**

- When you install OpenShift Container Platform, provide the SSH public key to the installation program. If you install a cluster on infrastructure that you provision, you must provide the key to the installation program.

**21.6.10. Obtaining the installation program**

Before you install OpenShift Container Platform, download the installation file on a local computer.

**Prerequisites**

- You have a computer that runs Linux or macOS, with 500 MB of local disk space

**Procedure**

1. Access the [Infrastructure Provider](#) page on the OpenShift Cluster Manager site. If you have a Red Hat account, log in with your credentials. If you do not, create an account.
2. Select your infrastructure provider.
3. Navigate to the page for your installation type, download the installation program that corresponds with your host operating system and architecture, and place the file in the directory where you will store the installation configuration files.

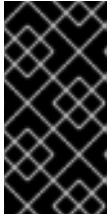

### IMPORTANT

The installation program creates several files on the computer that you use to install your cluster. You must keep the installation program and the files that the installation program creates after you finish installing the cluster. Both files are required to delete the cluster.

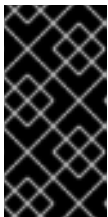

### IMPORTANT

Deleting the files created by the installation program does not remove your cluster, even if the cluster failed during installation. To remove your cluster, complete the OpenShift Container Platform uninstallation procedures for your specific cloud provider.

4. Extract the installation program. For example, on a computer that uses a Linux operating system, run the following command:

```
$ tar -xvf openshift-install-linux.tar.gz
```

5. Download your installation [pull secret from the Red Hat OpenShift Cluster Manager](#). This pull secret allows you to authenticate with the services that are provided by the included authorities, including Quay.io, which serves the container images for OpenShift Container Platform components.

## 21.6.11. Manually creating the installation configuration file

For user-provisioned installations of OpenShift Container Platform, you manually generate your installation configuration file.

### Prerequisites

- You have an SSH public key on your local machine to provide to the installation program. The key will be used for SSH authentication onto your cluster nodes for debugging and disaster recovery.
- You have obtained the OpenShift Container Platform installation program and the pull secret for your cluster.

### Procedure

1. Create an installation directory to store your required installation assets in:

```
$ mkdir <installation_directory>
```

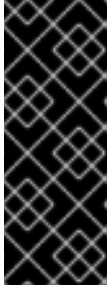
**IMPORTANT**

You must create a directory. Some installation assets, like bootstrap X.509 certificates have short expiration intervals, so you must not reuse an installation directory. If you want to reuse individual files from another cluster installation, you can copy them into your directory. However, the file names for the installation assets might change between releases. Use caution when copying installation files from an earlier OpenShift Container Platform version.

2. Customize the sample **install-config.yaml** file template that is provided and save it in the **<installation\_directory>**.

**NOTE**

You must name this configuration file **install-config.yaml**.

**NOTE**

For some platform types, you can alternatively run **./openshift-install create install-config --dir <installation\_directory>** to generate an **install-config.yaml** file. You can provide details about your cluster configuration at the prompts.

3. Back up the **install-config.yaml** file so that you can use it to install multiple clusters.

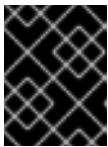
**IMPORTANT**

The **install-config.yaml** file is consumed during the next step of the installation process. You must back it up now.

**21.6.11.1. Sample install-config.yaml file for VMware vSphere**

You can customize the **install-config.yaml** file to specify more details about your OpenShift Container Platform cluster's platform or modify the values of the required parameters.

```

apiVersion: v1
baseDomain: example.com 1
compute: 2
- hyperthreading: Enabled 3
  name: worker
  replicas: 0 4
controlPlane: 5
  hyperthreading: Enabled 6
  name: master
  replicas: 3 7
metadata:
  name: test 8
platform:
  vsphere:
    vcenter: your.vcenter.server 9
    username: username 10
    password: password 11
    datacenter: datacenter 12

```

```

defaultDatastore: datastore 13
folder: "/<datacenter_name>/vm/<folder_name>/<subfolder_name>" 14
resourcePool: "/<datacenter_name>/host/<cluster_name>/Resources/<resource_pool_name>" 15
diskType: thin 16
fips: false 17
pullSecret: '{"auths": ...}' 18
sshKey: 'ssh-ed25519 AAAA...' 19

```

- 1** The base domain of the cluster. All DNS records must be sub-domains of this base and include the cluster name.
- 2** **5** The **controlPlane** section is a single mapping, but the compute section is a sequence of mappings. To meet the requirements of the different data structures, the first line of the **compute** section must begin with a hyphen, -, and the first line of the **controlPlane** section must not. Although both sections currently define a single machine pool, it is possible that future versions of OpenShift Container Platform will support defining multiple compute pools during installation. Only one control plane pool is used.
- 3** **6** Whether to enable or disable simultaneous multithreading, or **hyperthreading**. By default, simultaneous multithreading is enabled to increase the performance of your machines' cores. You can disable it by setting the parameter value to **Disabled**. If you disable simultaneous multithreading in some cluster machines, you must disable it in all cluster machines.



### IMPORTANT

If you disable simultaneous multithreading, ensure that your capacity planning accounts for the dramatically decreased machine performance. Your machines must use at least 8 CPUs and 32 GB of RAM if you disable simultaneous multithreading.

- 4** You must set the value of the **replicas** parameter to **0**. This parameter controls the number of workers that the cluster creates and manages for you, which are functions that the cluster does not perform when you use user-provisioned infrastructure. You must manually deploy worker machines for the cluster to use before you finish installing OpenShift Container Platform.
- 7** The number of control plane machines that you add to the cluster. Because the cluster uses this values as the number of etcd endpoints in the cluster, the value must match the number of control plane machines that you deploy.
- 8** The cluster name that you specified in your DNS records.
- 9** The fully-qualified hostname or IP address of the vCenter server.
- 10** The name of the user for accessing the server. This user must have at least the roles and privileges that are required for [static or dynamic persistent volume provisioning](#) in vSphere.
- 11** The password associated with the vSphere user.
- 12** The vSphere datacenter.
- 13** The default vSphere datastore to use.
- 14** Optional parameter: For installer-provisioned infrastructure, the absolute path of an existing folder where the installation program creates the virtual machines, for example, `/<datacenter_name>/vm/<folder_name>/<subfolder_name>`. If you do not provide this value, the installation program creates a top-level folder in the datacenter virtual machine folder that is

named with the infrastructure ID. If you are providing the infrastructure for the cluster and you do not want to use the default **StorageClass** object, named **thin**, you can omit the **folder** parameter from the **install-config.yaml** file.

- 15 Optional parameter: For installer-provisioned infrastructure, the absolute path of an existing resource pool where the installation program creates the virtual machines, for example, `/<datacenter_name>/host/<cluster_name>/Resources/<resource_pool_name>/<optional_nested_resource_pool_name>`. If you do not specify a value, resources are installed in the root of the cluster `/example_datacenter/host/example_cluster/Resources`.
- 16 The vSphere disk provisioning method.
- 17 Whether to enable or disable FIPS mode. By default, FIPS mode is not enabled. If FIPS mode is enabled, the Red Hat Enterprise Linux CoreOS (RHCOS) machines that OpenShift Container Platform runs on bypass the default Kubernetes cryptography suite and use the cryptography modules that are provided with RHCOS instead.



### IMPORTANT

To enable FIPS mode for your cluster, you must run the installation program from a Red Hat Enterprise Linux (RHEL) computer configured to operate in FIPS mode. For more information about configuring FIPS mode on RHEL, see [Installing the system in FIPS mode](#). The use of FIPS validated or Modules In Process cryptographic libraries is only supported on OpenShift Container Platform deployments on the **x86\_64** architecture.

- 18 The pull secret that you obtained from [OpenShift Cluster Manager](#). This pull secret allows you to authenticate with the services that are provided by the included authorities, including Quay.io, which serves the container images for OpenShift Container Platform components.
- 19 The public portion of the default SSH key for the **core** user in Red Hat Enterprise Linux CoreOS (RHCOS).

## 21.6.11.2. Configuring the cluster-wide proxy during installation

Production environments can deny direct access to the internet and instead have an HTTP or HTTPS proxy available. You can configure a new OpenShift Container Platform cluster to use a proxy by configuring the proxy settings in the **install-config.yaml** file.

### Prerequisites

- You have an existing **install-config.yaml** file.
- You reviewed the sites that your cluster requires access to and determined whether any of them need to bypass the proxy. By default, all cluster egress traffic is proxied, including calls to hosting cloud provider APIs. You added sites to the **Proxy** object's **spec.noProxy** field to bypass the proxy if necessary.



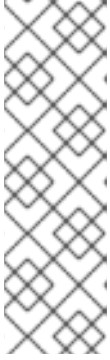

## NOTE

The **Proxy** object **status.noProxy** field is populated with the values of the **networking.machineNetwork[].cidr**, **networking.clusterNetwork[].cidr**, and **networking.serviceNetwork[]** fields from your installation configuration.

For installations on Amazon Web Services (AWS), Google Cloud Platform (GCP), Microsoft Azure, and Red Hat OpenStack Platform (RHOSP), the **Proxy** object **status.noProxy** field is also populated with the instance metadata endpoint (**169.254.169.254**).

## Procedure

1. Edit your **install-config.yaml** file and add the proxy settings. For example:

```
apiVersion: v1
baseDomain: my.domain.com
proxy:
  httpProxy: http://<username>:<pswd>@<ip>:<port> 1
  httpsProxy: https://<username>:<pswd>@<ip>:<port> 2
  noProxy: example.com 3
  additionalTrustBundle: | 4
    -----BEGIN CERTIFICATE-----
    <MY_TRUSTED_CA_CERT>
    -----END CERTIFICATE-----
  ...
```

- 1 A proxy URL to use for creating HTTP connections outside the cluster. The URL scheme must be **http**.
- 2 A proxy URL to use for creating HTTPS connections outside the cluster.
- 3 A comma-separated list of destination domain names, IP addresses, or other network CIDRs to exclude from proxying. Preface a domain with **.** to match subdomains only. For example, **.y.com** matches **x.y.com**, but not **y.com**. Use **\*** to bypass the proxy for all destinations. You must include vCenter's IP address and the IP range that you use for its machines.
- 4 If provided, the installation program generates a config map that is named **user-ca-bundle** in the **openshift-config** namespace that contains one or more additional CA certificates that are required for proxying HTTPS connections. The Cluster Network Operator then creates a **trusted-ca-bundle** config map that merges these contents with the Red Hat Enterprise Linux CoreOS (RHCOS) trust bundle, and this config map is referenced in the **trustedCA** field of the **Proxy** object. The **additionalTrustBundle** field is required unless the proxy's identity certificate is signed by an authority from the RHCOS trust bundle.

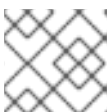

## NOTE

The installation program does not support the proxy **readinessEndpoints** field.

**NOTE**

If the installer times out, restart and then complete the deployment by using the **wait-for** command of the installer. For example:

```
$ ./openshift-install wait-for install-complete --log-level debug
```

2. Save the file and reference it when installing OpenShift Container Platform.

The installation program creates a cluster-wide proxy that is named **cluster** that uses the proxy settings in the provided **install-config.yaml** file. If no proxy settings are provided, a **cluster Proxy** object is still created, but it will have a nil **spec**.

**NOTE**

Only the **Proxy** object named **cluster** is supported, and no additional proxies can be created.

## 21.6.12. Creating the Kubernetes manifest and Ignition config files

Because you must modify some cluster definition files and manually start the cluster machines, you must generate the Kubernetes manifest and Ignition config files that the cluster needs to configure the machines.

The installation configuration file transforms into the Kubernetes manifests. The manifests wrap into the Ignition configuration files, which are later used to configure the cluster machines.

**IMPORTANT**

- The Ignition config files that the OpenShift Container Platform installation program generates contain certificates that expire after 24 hours, which are then renewed at that time. If the cluster is shut down before renewing the certificates and the cluster is later restarted after the 24 hours have elapsed, the cluster automatically recovers the expired certificates. The exception is that you must manually approve the pending **node-bootstrapper** certificate signing requests (CSRs) to recover kubelet certificates. See the documentation for *Recovering from expired control plane certificates* for more information.
- It is recommended that you use Ignition config files within 12 hours after they are generated because the 24-hour certificate rotates from 16 to 22 hours after the cluster is installed. By using the Ignition config files within 12 hours, you can avoid installation failure if the certificate update runs during installation.

**Prerequisites**

- You obtained the OpenShift Container Platform installation program.
- You created the **install-config.yaml** installation configuration file.

**Procedure**

1. Change to the directory that contains the OpenShift Container Platform installation program and generate the Kubernetes manifests for the cluster:

```
$ ./openshift-install create manifests --dir <installation_directory> 1
```

- 1 For **<installation\_directory>**, specify the installation directory that contains the **install-config.yaml** file you created.

2. Remove the Kubernetes manifest files that define the control plane machines and compute machine sets:

```
$ rm -f openshift/99_openshift-cluster-api_master-machines-*.yaml openshift/99_openshift-cluster-api_worker-machineset-*.yaml
```

Because you create and manage these resources yourself, you do not have to initialize them.

- You can preserve the machine set files to create compute machines by using the machine API, but you must update references to them to match your environment.
3. Check that the **mastersSchedulable** parameter in the **<installation\_directory>/manifests/cluster-scheduler-02-config.yml** Kubernetes manifest file is set to **false**. This setting prevents pods from being scheduled on the control plane machines:
- a. Open the **<installation\_directory>/manifests/cluster-scheduler-02-config.yml** file.
  - b. Locate the **mastersSchedulable** parameter and ensure that it is set to **false**.
  - c. Save and exit the file.
4. To create the Ignition configuration files, run the following command from the directory that contains the installation program:

```
$ ./openshift-install create ignition-configs --dir <installation_directory> 1
```

- 1 For **<installation\_directory>**, specify the same installation directory.

Ignition config files are created for the bootstrap, control plane, and compute nodes in the installation directory. The **kubeadmin-password** and **kubeconfig** files are created in the **./<installation\_directory>/auth** directory:

```
.
├── auth
│   ├── kubeadmin-password
│   └── kubeconfig
├── bootstrap.ign
├── master.ign
├── metadata.json
└── worker.ign
```

### 21.6.13. Extracting the infrastructure name

The Ignition config files contain a unique cluster identifier that you can use to uniquely identify your cluster in VMware Cloud on AWS. If you plan to use the cluster identifier as the name of your virtual machine folder, you must extract it.

## Prerequisites

- You obtained the OpenShift Container Platform installation program and the pull secret for your cluster.
- You generated the Ignition config files for your cluster.
- You installed the **jq** package.

## Procedure

- To extract and view the infrastructure name from the Ignition config file metadata, run the following command:

```
$ jq -r .infraID <installation_directory>/metadata.json 1
```

- 1 For **<installation\_directory>**, specify the path to the directory that you stored the installation files in.

## Example output

```
openshift-vw9j6 1
```

- 1 The output of this command is your cluster name and a random string.

## 21.6.14. Installing RHCOS and starting the OpenShift Container Platform bootstrap process

To install OpenShift Container Platform on user-provisioned infrastructure on VMware vSphere, you must install Red Hat Enterprise Linux CoreOS (RHCOS) on vSphere hosts. When you install RHCOS, you must provide the Ignition config file that was generated by the OpenShift Container Platform installation program for the type of machine you are installing. If you have configured suitable networking, DNS, and load balancing infrastructure, the OpenShift Container Platform bootstrap process begins automatically after the RHCOS machines have rebooted.

## Prerequisites

- You have obtained the Ignition config files for your cluster.
- You have access to an HTTP server that you can access from your computer and that the machines that you create can access.
- You have created a [vSphere cluster](#).

## Procedure

1. Upload the bootstrap Ignition config file, which is named **<installation\_directory>/bootstrap.ign**, that the installation program created to your HTTP server. Note the URL of this file.
2. Save the following secondary Ignition config file for your bootstrap node to your computer as **<installation\_directory>/merge-bootstrap.ign**:

■

```

{
  "ignition": {
    "config": {
      "merge": [
        {
          "source": "<bootstrap_ignition_config_url>", 1
          "verification": {}
        }
      ]
    },
    "timeouts": {},
    "version": "3.2.0"
  },
  "networkd": {},
  "passwd": {},
  "storage": {},
  "systemd": {}
}

```

- 1 Specify the URL of the bootstrap Ignition config file that you hosted.

When you create the virtual machine (VM) for the bootstrap machine, you use this Ignition config file.

- Locate the following Ignition config files that the installation program created:
  - <installation\_directory>/master.ign**
  - <installation\_directory>/worker.ign**
  - <installation\_directory>/merge-bootstrap.ign**
- Convert the Ignition config files to Base64 encoding. Later in this procedure, you must add these files to the extra configuration parameter **guestinfo.ignition.config.data** in your VM. For example, if you use a Linux operating system, you can use the **base64** command to encode the files.

```
$ base64 -w0 <installation_directory>/master.ign > <installation_directory>/master.64
```

```
$ base64 -w0 <installation_directory>/worker.ign > <installation_directory>/worker.64
```

```
$ base64 -w0 <installation_directory>/merge-bootstrap.ign > <installation_directory>/merge-bootstrap.64
```

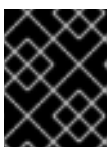

### IMPORTANT

If you plan to add more compute machines to your cluster after you finish installation, do not delete these files.

- Obtain the RHCOS OVA image. Images are available from the [RHCOS image mirror](#) page.



## IMPORTANT

The RHCOS images might not change with every release of OpenShift Container Platform. You must download an image with the highest version that is less than or equal to the OpenShift Container Platform version that you install. Use the image version that matches your OpenShift Container Platform version if it is available.

The filename contains the OpenShift Container Platform version number in the format **rhcos-vmware.<architecture>.ova**.

6. In the vSphere Client, create a folder in your datacenter to store your VMs.
  - a. Click the **VMs and Templates** view.
  - b. Right-click the name of your datacenter.
  - c. Click **New Folder → New VM and Template Folder**.
  - d. In the window that is displayed, enter the folder name. If you did not specify an existing folder in the **install-config.yaml** file, then create a folder with the same name as the infrastructure ID. You use this folder name so vCenter dynamically provisions storage in the appropriate location for its Workspace configuration.
7. In the vSphere Client, create a template for the OVA image and then clone the template as needed.



## NOTE

In the following steps, you create a template and then clone the template for all of your cluster machines. You then provide the location for the Ignition config file for that cloned machine type when you provision the VMs.

- a. From the **Hosts and Clusters** tab, right-click your cluster name and select **Deploy OVF Template**.
- b. On the **Select an OVF** tab, specify the name of the RHCOS OVA file that you downloaded.
- c. On the **Select a name and folder** tab, set a **Virtual machine name** for your template, such as **Template-RHCOS**. Click the name of your vSphere cluster and select the folder you created in the previous step.
- d. On the **Select a compute resource** tab, click the name of your vSphere cluster.
- e. On the **Select storage** tab, configure the storage options for your VM.
  - Select **Thin Provision** or **Thick Provision**, based on your storage preferences.
  - Select the datastore that you specified in your **install-config.yaml** file.
- f. On the **Select network** tab, specify the network that you configured for the cluster, if available.
- g. When creating the OVF template, do not specify values on the **Customize template** tab or configure the template any further.



### IMPORTANT

Do not start the original VM template. The VM template must remain off and must be cloned for new RHCOS machines. Starting the VM template configures the VM template as a VM on the platform, which prevents it from being used as a template that machine sets can apply configurations to.

8. Optional: Update the configured virtual hardware version in the VM template, if necessary. Follow [Upgrading a virtual machine to the latest hardware version](#) in the VMware documentation for more information.



### IMPORTANT

It is recommended that you update the hardware version of the VM template to version 15 before creating VMs from it, if necessary. Using hardware version 13 for your cluster nodes running on vSphere is now deprecated. If your imported template defaults to hardware version 13, you must ensure that your ESXi host is on 6.7U3 or later before upgrading the VM template to hardware version 15. If your vSphere version is less than 6.7U3, you can skip this upgrade step; however, a future version of OpenShift Container Platform is scheduled to remove support for hardware version 13 and vSphere versions less than 6.7U3.

9. After the template deploys, deploy a VM for a machine in the cluster.
  - a. Right-click the template name and click **Clone** → **Clone to Virtual Machine**
  - b. On the **Select a name and folder** tab, specify a name for the VM. You might include the machine type in the name, such as **control-plane-0** or **compute-1**.



### NOTE

Ensure that all virtual machine names across a vSphere installation are unique.

- c. On the **Select a name and folder** tab, select the name of the folder that you created for the cluster.
- d. On the **Select a compute resource** tab, select the name of a host in your datacenter.
- e. On the **Select clone options**, select **Customize this virtual machine's hardware**
- f. Optional: On the **Customize hardware** tab, click **VM Options** → **Advanced**.



### IMPORTANT

The following configuration suggestions are for example purposes only. As a cluster administrator, you must configure resources according to the resource demands placed on your cluster. To best manage cluster resources, consider creating a resource pool from the cluster's root resource pool.

- Override default DHCP networking in vSphere. To enable static IP networking:
  - Set your static IP configuration:

```
$ export IPCFG="ip=<ip>::<gateway>:<netmask>:<hostname>:<iface>:none
nameserver=svr1 [nameserver=svr2 [nameserver=svr3 [...]]]"
```

### Example command

```
$ export IPCFG="ip=192.168.100.101::192.168.100.254:255.255.255.0::none
nameserver=8.8.8.8"
```

- Click **Edit Configuration**, and on the **Configuration Parameters** window, search the list of available parameters for steal clock accounting (**stealclock.enable**). Set the parameter to the value of **TRUE**. Enabling steal clock accounting can help with troubleshooting cluster issues.
- Click **Add Configuration Params**. Define the following parameter names and values:
  - **disk.EnableUUID**: Specify **TRUE**.
  - **stealclock.enable**: If this parameter was not defined, add it and specify **TRUE**.
  - Create a child resource pool from the cluster's root resource pool. Perform resource allocation in this child resource pool.
- g. In the **Virtual Hardware** panel of the **Customize hardware** tab, modify the specified values as required. Ensure that the amount of RAM, CPU, and disk storage meets the minimum requirements for the machine type.
- h. Complete the configuration and power on the VM.
- i. Check the console output to verify that Ignition ran.

### Example command

```
Ignition: ran on 2022/03/14 14:48:33 UTC (this boot)
Ignition: user-provided config was applied
```

10. Create the rest of the machines for your cluster by following the preceding steps for each machine.

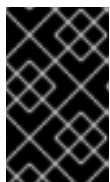

### IMPORTANT

You must create the bootstrap and control plane machines at this time. Because some pods are deployed on compute machines by default, also create at least two compute machines before you install the cluster.

## 21.6.15. Adding more compute machines to a cluster in vSphere

You can add more compute machines to a user-provisioned OpenShift Container Platform cluster on VMware vSphere.

### Prerequisites

- Obtain the base64-encoded Ignition file for your compute machines.
- You have access to the vSphere template that you created for your cluster.



## Procedure

1. After the template deploys, deploy a VM for a machine in the cluster.
  - a. Right-click the template's name and click **Clone → Clone to Virtual Machine**
  - b. On the **Select a name and folder** tab, specify a name for the VM. You might include the machine type in the name, such as **compute-1**.



### NOTE

Ensure that all virtual machine names across a vSphere installation are unique.

- c. On the **Select a name and folder** tab, select the name of the folder that you created for the cluster.
  - d. On the **Select a compute resource** tab, select the name of a host in your datacenter.
  - e. On the **Select clone options**, select **Customize this virtual machine's hardware**
  - f. On the **Customize hardware** tab, click **VM Options → Advanced**.
    - Click **Edit Configuration**, and on the **Configuration Parameters** window, click **Add Configuration Params**. Define the following parameter names and values:
      - **guestinfo.ignition.config.data**: Paste the contents of the base64-encoded compute Ignition config file for this machine type.
      - **guestinfo.ignition.config.data.encoding**: Specify **base64**.
      - **disk.EnableUUID**: Specify **TRUE**.
  - g. In the **Virtual Hardware** panel of the **Customize hardware** tab, modify the specified values as required. Ensure that the amount of RAM, CPU, and disk storage meets the minimum requirements for the machine type. Also, make sure to select the correct network under **Add network adapter** if there are multiple networks available.
  - h. Complete the configuration and power on the VM.
2. Continue to create more compute machines for your cluster.

## 21.6.16. Disk partitioning

In most cases, data partitions are originally created by installing RHCOS, rather than by installing another operating system. In such cases, the OpenShift Container Platform installer should be allowed to configure your disk partitions.

However, there are two cases where you might want to intervene to override the default partitioning when installing an OpenShift Container Platform node:

- **Create separate partitions:** For greenfield installations on an empty disk, you might want to add separate storage to a partition. This is officially supported for making **/var** or a subdirectory of **/var**, such as **/var/lib/etcd**, a separate partition, but not both.

**IMPORTANT**

For disk sizes larger than 100GB, and especially disk sizes larger than 1TB, create a separate **/var** partition. See "Creating a separate **/var** partition" and this [Red Hat Knowledgebase article](#) for more information.

**IMPORTANT**

Kubernetes supports only two file system partitions. If you add more than one partition to the original configuration, Kubernetes cannot monitor all of them.

- **Retain existing partitions:** For a brownfield installation where you are reinstalling OpenShift Container Platform on an existing node and want to retain data partitions installed from your previous operating system, there are both boot arguments and options to **coreos-installer** that allow you to retain existing data partitions.

### Creating a separate **/var** partition

In general, disk partitioning for OpenShift Container Platform should be left to the installer. However, there are cases where you might want to create separate partitions in a part of the filesystem that you expect to grow.

OpenShift Container Platform supports the addition of a single partition to attach storage to either the **/var** partition or a subdirectory of **/var**. For example:

- **/var/lib/containers:** Holds container-related content that can grow as more images and containers are added to a system.
- **/var/lib/etcd:** Holds data that you might want to keep separate for purposes such as performance optimization of etcd storage.
- **/var:** Holds data that you might want to keep separate for purposes such as auditing.

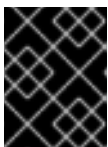
**IMPORTANT**

For disk sizes larger than 100GB, and especially larger than 1TB, create a separate **/var** partition.

Storing the contents of a **/var** directory separately makes it easier to grow storage for those areas as needed and reinstall OpenShift Container Platform at a later date and keep that data intact. With this method, you will not have to pull all your containers again, nor will you have to copy massive log files when you update systems.

Because **/var** must be in place before a fresh installation of Red Hat Enterprise Linux CoreOS (RHCOS), the following procedure sets up the separate **/var** partition by creating a machine config manifest that is inserted during the **openshift-install** preparation phases of an OpenShift Container Platform installation.

### Procedure

1. Create a directory to hold the OpenShift Container Platform installation files:

```
$ mkdir $HOME/clusterconfig
```

- Run **openshift-install** to create a set of files in the **manifest** and **openshift** subdirectories. Answer the system questions as you are prompted:

```
$ openshift-install create manifests --dir $HOME/clusterconfig
? SSH Public Key ...
$ ls $HOME/clusterconfig/openshift/
99_kubeadmin-password-secret.yaml
99_openshift-cluster-api_master-machines-0.yaml
99_openshift-cluster-api_master-machines-1.yaml
99_openshift-cluster-api_master-machines-2.yaml
...
```

- Create a Butane config that configures the additional partition. For example, name the file **\$HOME/clusterconfig/98-var-partition.bu**, change the disk device name to the name of the storage device on the **worker** systems, and set the storage size as appropriate. This example places the **/var** directory on a separate partition:

```
variant: openshift
version: 4.10.0
metadata:
  labels:
    machineconfiguration.openshift.io/role: worker
  name: 98-var-partition
storage:
  disks:
    - device: /dev/<device_name> ❶
    partitions:
      - label: var
        start_mib: <partition_start_offset> ❷
        size_mib: <partition_size> ❸
    filesystems:
      - device: /dev/disk/by-partlabel/var
        path: /var
        format: xfs
        mount_options: [defaults, prjquota] ❹
        with_mount_unit: true
```

- The storage device name of the disk that you want to partition.
- When adding a data partition to the boot disk, a minimum value of 25000 mebibytes is recommended. The root file system is automatically resized to fill all available space up to the specified offset. If no value is specified, or if the specified value is smaller than the recommended minimum, the resulting root file system will be too small, and future reinstalls of RHCOS might overwrite the beginning of the data partition.
- The size of the data partition in mebibytes.
- The **prjquota** mount option must be enabled for filesystems used for container storage.



## NOTE

When creating a separate **/var** partition, you cannot use different instance types for worker nodes, if the different instance types do not have the same device name.

4. Create a manifest from the Butane config and save it to the **clusterconfig/openshift** directory. For example, run the following command:

```
$ butane $HOME/clusterconfig/98-var-partition.bu -o $HOME/clusterconfig/openshift/98-var-partition.yaml
```

5. Run **openshift-install** again to create Ignition configs from a set of files in the **manifest** and **openshift** subdirectories:

```
$ openshift-install create ignition-configs --dir $HOME/clusterconfig
$ ls $HOME/clusterconfig/
auth bootstrap.ign master.ign metadata.json worker.ign
```

Now you can use the Ignition config files as input to the vSphere installation procedures to install Red Hat Enterprise Linux CoreOS (RHCOS) systems.

### 21.6.17. Updating the bootloader using bootupd

To update the bootloader by using **bootupd**, you must either install **bootupd** on RHCOS machines manually or provide a machine config with the enabled **systemd** unit. Unlike **grubby** or other bootloader tools, **bootupd** does not manage kernel space configuration such as passing kernel arguments.

After you have installed **bootupd**, you can manage it remotely from the OpenShift Container Platform cluster.



#### NOTE

It is recommended that you use **bootupd** only on bare metal or virtualized hypervisor installations, such as for protection against the BootHole vulnerability.

#### Manual install method

You can manually install **bootupd** by using the **bootctl** command-line tool.

1. Inspect the system status:

```
# bootupctl status
```

#### Example output for x86\_64

```
Component EFI
Installed: grub2-efi-x64-1:2.04-31.fc33.x86_64,shim-x64-15-8.x86_64
Update: At latest version
```

#### Example output for aarch64

```
Component EFI
Installed: grub2-efi-aa64-1:2.02-99.el8_4.1.aarch64,shim-aa64-15.4-2.el8_1.aarch64
Update: At latest version
```

2. RHCOS images created without **bootupd** installed on them require an explicit adoption phase. If the system status is **Adoptable**, perform the adoption:

```
# bootupctl adopt-and-update
```

### Example output

```
Updated: grub2-efi-x64-1:2.04-31.fc33.x86_64,shim-x64-15-8.x86_64
```

- If an update is available, apply the update so that the changes take effect on the next reboot:

```
# bootupctl update
```

### Example output

```
Updated: grub2-efi-x64-1:2.04-31.fc33.x86_64,shim-x64-15-8.x86_64
```

## Machine config method

Another way to enable **bootupd** is by providing a machine config.

- Provide a machine config file with the enabled **systemd** unit, as shown in the following example:

### Example output

```
variant: rhcos
version: 1.1.0
systemd:
  units:
    - name: custom-bootupd-auto.service
      enabled: true
      contents: |
        [Unit]
        Description=Bootupd automatic update

        [Service]
        ExecStart=/usr/bin/bootupctl update
        RemainAfterExit=yes

        [Install]
        WantedBy=multi-user.target
```

## 21.6.18. Installing the OpenShift CLI by downloading the binary

You can install the OpenShift CLI (**oc**) to interact with OpenShift Container Platform from a command-line interface. You can install **oc** on Linux, Windows, or macOS.



### IMPORTANT

If you installed an earlier version of **oc**, you cannot use it to complete all of the commands in OpenShift Container Platform 4.10. Download and install the new version of **oc**.

### Installing the OpenShift CLI on Linux

You can install the OpenShift CLI (**oc**) binary on Linux by using the following procedure.

## Procedure

1. Navigate to the [OpenShift Container Platform downloads page](#) on the Red Hat Customer Portal.
2. Select the appropriate version in the **Version** drop-down menu.
3. Click **Download Now** next to the **OpenShift v4.10 Linux Client** entry and save the file.
4. Unpack the archive:

```
$ tar xvf <file>
```

5. Place the **oc** binary in a directory that is on your **PATH**.  
To check your **PATH**, execute the following command:

```
$ echo $PATH
```

After you install the OpenShift CLI, it is available using the **oc** command:

```
$ oc <command>
```

## Installing the OpenShift CLI on Windows

You can install the OpenShift CLI (**oc**) binary on Windows by using the following procedure.

## Procedure

1. Navigate to the [OpenShift Container Platform downloads page](#) on the Red Hat Customer Portal.
2. Select the appropriate version in the **Version** drop-down menu.
3. Click **Download Now** next to the **OpenShift v4.10 Windows Client** entry and save the file.
4. Unzip the archive with a ZIP program.
5. Move the **oc** binary to a directory that is on your **PATH**.  
To check your **PATH**, open the command prompt and execute the following command:

```
C:\> path
```

After you install the OpenShift CLI, it is available using the **oc** command:

```
C:\> oc <command>
```

## Installing the OpenShift CLI on macOS

You can install the OpenShift CLI (**oc**) binary on macOS by using the following procedure.

## Procedure

1. Navigate to the [OpenShift Container Platform downloads page](#) on the Red Hat Customer Portal.
2. Select the appropriate version in the **Version** drop-down menu.

3. Click **Download Now** next to the **OpenShift v4.10 MacOSX Client** entry and save the file.
4. Unpack and unzip the archive.
5. Move the **oc** binary to a directory on your PATH.  
To check your **PATH**, open a terminal and execute the following command:

```
$ echo $PATH
```

After you install the OpenShift CLI, it is available using the **oc** command:

```
$ oc <command>
```

### 21.6.19. Waiting for the bootstrap process to complete

The OpenShift Container Platform bootstrap process begins after the cluster nodes first boot into the persistent RHCOS environment that has been installed to disk. The configuration information provided through the Ignition config files is used to initialize the bootstrap process and install OpenShift Container Platform on the machines. You must wait for the bootstrap process to complete.

#### Prerequisites

- You have created the Ignition config files for your cluster.
- You have configured suitable network, DNS and load balancing infrastructure.
- You have obtained the installation program and generated the Ignition config files for your cluster.
- You installed RHCOS on your cluster machines and provided the Ignition config files that the OpenShift Container Platform installation program generated.
- Your machines have direct internet access or have an HTTP or HTTPS proxy available.

#### Procedure

1. Monitor the bootstrap process:

```
$ ./openshift-install --dir <installation_directory> wait-for bootstrap-complete \ 1  
--log-level=info 2
```

1 For **<installation\_directory>**, specify the path to the directory that you stored the installation files in.

2 To view different installation details, specify **warn**, **debug**, or **error** instead of **info**.

#### Example output

```
INFO Waiting up to 30m0s for the Kubernetes API at https://api.test.example.com:6443...  
INFO API v1.23.0 up  
INFO Waiting up to 30m0s for bootstrapping to complete...  
INFO It is now safe to remove the bootstrap resources
```

The command succeeds when the Kubernetes API server signals that it has been bootstrapped on the control plane machines.

2. After bootstrap process is complete, remove the bootstrap machine from the load balancer.

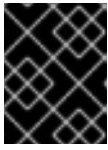

### IMPORTANT

You must remove the bootstrap machine from the load balancer at this point. You can also remove or reformat the bootstrap machine itself.

## 21.6.20. Logging in to the cluster by using the CLI

You can log in to your cluster as a default system user by exporting the cluster **kubeconfig** file. The **kubeconfig** file contains information about the cluster that is used by the CLI to connect a client to the correct cluster and API server. The file is specific to a cluster and is created during OpenShift Container Platform installation.

### Prerequisites

- You deployed an OpenShift Container Platform cluster.
- You installed the **oc** CLI.

### Procedure

1. Export the **kubeadmin** credentials:

```
$ export KUBECONFIG=<installation_directory>/auth/kubeconfig 1
```

- 1** For **<installation\_directory>**, specify the path to the directory that you stored the installation files in.

2. Verify you can run **oc** commands successfully using the exported configuration:

```
$ oc whoami
```

### Example output

```
system:admin
```

## 21.6.21. Approving the certificate signing requests for your machines

When you add machines to a cluster, two pending certificate signing requests (CSRs) are generated for each machine that you added. You must confirm that these CSRs are approved or, if necessary, approve them yourself. The client requests must be approved first, followed by the server requests.

### Prerequisites

- You added machines to your cluster.

### Procedure



1. Confirm that the cluster recognizes the machines:

```
$ oc get nodes
```

### Example output

```
NAME      STATUS    ROLES    AGE   VERSION
master-0  Ready     master   63m   v1.23.0
master-1  Ready     master   63m   v1.23.0
master-2  Ready     master   64m   v1.23.0
```

The output lists all of the machines that you created.

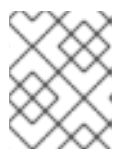

### NOTE

The preceding output might not include the compute nodes, also known as worker nodes, until some CSRs are approved.

2. Review the pending CSRs and ensure that you see the client requests with the **Pending** or **Approved** status for each machine that you added to the cluster:

```
$ oc get csr
```

### Example output

```
NAME      AGE   REQUESTOR                                     CONDITION
csr-8b2br  15m   system:serviceaccount:openshift-machine-config-operator:node-
bootstrapper  Pending
csr-8vnps  15m   system:serviceaccount:openshift-machine-config-operator:node-
bootstrapper  Pending
...
```

In this example, two machines are joining the cluster. You might see more approved CSRs in the list.

3. If the CSRs were not approved, after all of the pending CSRs for the machines you added are in **Pending** status, approve the CSRs for your cluster machines:

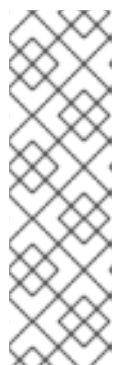

### NOTE

Because the CSRs rotate automatically, approve your CSRs within an hour of adding the machines to the cluster. If you do not approve them within an hour, the certificates will rotate, and more than two certificates will be present for each node. You must approve all of these certificates. After the client CSR is approved, the Kubelet creates a secondary CSR for the serving certificate, which requires manual approval. Then, subsequent serving certificate renewal requests are automatically approved by the **machine-approver** if the Kubelet requests a new certificate with identical parameters.

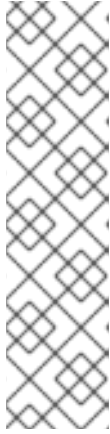
**NOTE**

For clusters running on platforms that are not machine API enabled, such as bare metal and other user-provisioned infrastructure, you must implement a method of automatically approving the kubelet serving certificate requests (CSRs). If a request is not approved, then the **oc exec**, **oc rsh**, and **oc logs** commands cannot succeed, because a serving certificate is required when the API server connects to the kubelet. Any operation that contacts the Kubelet endpoint requires this certificate approval to be in place. The method must watch for new CSRs, confirm that the CSR was submitted by the **node-bootstrap** service account in the **system:node** or **system:admin** groups, and confirm the identity of the node.

- To approve them individually, run the following command for each valid CSR:

```
$ oc adm certificate approve <csr_name> 1
```

- 1** **<csr\_name>** is the name of a CSR from the list of current CSRs.

- To approve all pending CSRs, run the following command:

```
$ oc get csr -o go-template='{{range .items}}{{if not .status}}{{.metadata.name}}{"\n"}{{end}}{{end}}' | xargs --no-run-if-empty oc adm certificate approve
```

**NOTE**

Some Operators might not become available until some CSRs are approved.

- Now that your client requests are approved, you must review the server requests for each machine that you added to the cluster:

```
$ oc get csr
```

**Example output**

```
NAME      AGE   REQUESTOR                                     CONDITION
csr-bfd72 5m26s system:node:ip-10-0-50-126.us-east-2.compute.internal
Pending
csr-c57lv 5m26s system:node:ip-10-0-95-157.us-east-2.compute.internal
Pending
...
```

- If the remaining CSRs are not approved, and are in the **Pending** status, approve the CSRs for your cluster machines:

- To approve them individually, run the following command for each valid CSR:

```
$ oc adm certificate approve <csr_name> 1
```

- 1** **<csr\_name>** is the name of a CSR from the list of current CSRs.

- To approve all pending CSRs, run the following command:

```
$ oc get csr -o go-template='{{range .items}}{{if not .status}}{{.metadata.name}}{\n"}\n{{end}}' | xargs oc adm certificate approve
```

6. After all client and server CSRs have been approved, the machines have the **Ready** status. Verify this by running the following command:

```
$ oc get nodes
```

### Example output

```
NAME      STATUS  ROLES  AGE  VERSION
master-0  Ready   master 73m  v1.23.0
master-1  Ready   master 73m  v1.23.0
master-2  Ready   master 74m  v1.23.0
worker-0  Ready   worker 11m  v1.23.0
worker-1  Ready   worker 11m  v1.23.0
```



### NOTE

It can take a few minutes after approval of the server CSRs for the machines to transition to the **Ready** status.

### Additional information

- For more information on CSRs, see [Certificate Signing Requests](#).

## 21.6.22. Initial Operator configuration

After the control plane initializes, you must immediately configure some Operators so that they all become available.

### Prerequisites

- Your control plane has initialized.

### Procedure

1. Watch the cluster components come online:

```
$ watch -n5 oc get clusteroperators
```

### Example output

NAME	VERSION	AVAILABLE	PROGRESSING	DEGRADED	SINCE
authentication	4.10.0	True	False	False	19m
baremetal	4.10.0	True	False	False	37m
cloud-credential	4.10.0	True	False	False	40m
cluster-autoscaler	4.10.0	True	False	False	37m
config-operator	4.10.0	True	False	False	38m

console	4.10.0	True	False	False	26m
csi-snapshot-controller	4.10.0	True	False	False	37m
dns	4.10.0	True	False	False	37m
etcd	4.10.0	True	False	False	36m
image-registry	4.10.0	True	False	False	31m
ingress	4.10.0	True	False	False	30m
insights	4.10.0	True	False	False	31m
kube-apiserver	4.10.0	True	False	False	26m
kube-controller-manager	4.10.0	True	False	False	36m
kube-scheduler	4.10.0	True	False	False	36m
kube-storage-version-migrator	4.10.0	True	False	False	37m
machine-api	4.10.0	True	False	False	29m
machine-approver	4.10.0	True	False	False	37m
machine-config	4.10.0	True	False	False	36m
marketplace	4.10.0	True	False	False	37m
monitoring	4.10.0	True	False	False	29m
network	4.10.0	True	False	False	38m
node-tuning	4.10.0	True	False	False	37m
openshift-apiserver	4.10.0	True	False	False	32m
openshift-controller-manager	4.10.0	True	False	False	30m
openshift-samples	4.10.0	True	False	False	32m
operator-lifecycle-manager	4.10.0	True	False	False	37m
operator-lifecycle-manager-catalog	4.10.0	True	False	False	37m
operator-lifecycle-manager-packageserver	4.10.0	True	False	False	32m
service-ca	4.10.0	True	False	False	38m
storage	4.10.0	True	False	False	37m

2. Configure the Operators that are not available.

### 21.6.22.1. Image registry removed during installation

On platforms that do not provide shareable object storage, the OpenShift Image Registry Operator bootstraps itself as **Removed**. This allows **openshift-installer** to complete installations on these platform types.

After installation, you must edit the Image Registry Operator configuration to switch the **managementState** from **Removed** to **Managed**.

### 21.6.22.2. Image registry storage configuration

The Image Registry Operator is not initially available for platforms that do not provide default storage. After installation, you must configure your registry to use storage so that the Registry Operator is made available.

Instructions are shown for configuring a persistent volume, which is required for production clusters. Where applicable, instructions are shown for configuring an empty directory as the storage location, which is available for only non-production clusters.

Additional instructions are provided for allowing the image registry to use block storage types by using the **Recreate** rollout strategy during upgrades.

#### 21.6.22.2.1. Configuring registry storage for VMware vSphere

As a cluster administrator, following installation you must configure your registry to use storage.

## Prerequisites

- Cluster administrator permissions.
- A cluster on VMware vSphere.
- Persistent storage provisioned for your cluster, such as Red Hat OpenShift Data Foundation.

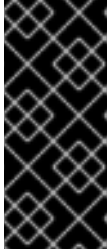

### IMPORTANT

OpenShift Container Platform supports **ReadWriteOnce** access for image registry storage when you have only one replica. **ReadWriteOnce** access also requires that the registry uses the **Recreate** rollout strategy. To deploy an image registry that supports high availability with two or more replicas, **ReadWriteMany** access is required.

- Must have "100Gi" capacity.

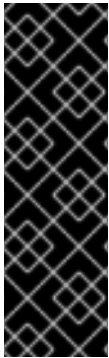

### IMPORTANT

Testing shows issues with using the NFS server on RHEL as storage backend for core services. This includes the OpenShift Container Registry and Quay, Prometheus for monitoring storage, and Elasticsearch for logging storage. Therefore, using RHEL NFS to back PVs used by core services is not recommended.

Other NFS implementations on the marketplace might not have these issues. Contact the individual NFS implementation vendor for more information on any testing that was possibly completed against these OpenShift Container Platform core components.

## Procedure

1. To configure your registry to use storage, change the **spec.storage.pvc** in the **configs.imageregistry/cluster** resource.



### NOTE

When using shared storage, review your security settings to prevent outside access.

2. Verify that you do not have a registry pod:

```
$ oc get pod -n openshift-image-registry -l docker-registry=default
```

### Example output

```
No resources found in openshift-image-registry namespace
```



### NOTE

If you do have a registry pod in your output, you do not need to continue with this procedure.

3. Check the registry configuration:

```
$ oc edit configs.imageregistry.operator.openshift.io
```

#### Example output

```
storage:
  pvc:
    claim: 1
```

- 1** Leave the **claim** field blank to allow the automatic creation of an **image-registry-storage** persistent volume claim (PVC). The PVC is generated based on the default storage class. However, be aware that the default storage class might provide ReadWriteOnce (RWO) volumes, such as a RADOS Block Device (RBD), which can cause issues when replicating to more than one replica.

4. Check the **clusteroperator** status:

```
$ oc get clusteroperator image-registry
```

#### Example output

NAME	VERSION	AVAILABLE	PROGRESSING	DEGRADED
image-registry	4.7	True	False	6h50m

#### 21.6.22.2.2. Configuring storage for the image registry in non-production clusters

You must configure storage for the Image Registry Operator. For non-production clusters, you can set the image registry to an empty directory. If you do so, all images are lost if you restart the registry.

#### Procedure

- To set the image registry storage to an empty directory:

```
$ oc patch configs.imageregistry.operator.openshift.io cluster --type merge --patch '{"spec": {"storage":{"emptyDir":{}}}'
```



#### WARNING

Configure this option for only non-production clusters.

If you run this command before the Image Registry Operator initializes its components, the **oc patch** command fails with the following error:

```
Error from server (NotFound): configs.imageregistry.operator.openshift.io "cluster" not found
```

Wait a few minutes and run the command again.

### 21.6.22.2.3. Configuring block registry storage for VMware vSphere

To allow the image registry to use block storage types such as vSphere Virtual Machine Disk (VMDK) during upgrades as a cluster administrator, you can use the **Recreate** rollout strategy.

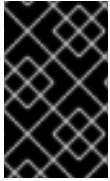

#### IMPORTANT

Block storage volumes are supported but not recommended for use with image registry on production clusters. An installation where the registry is configured on block storage is not highly available because the registry cannot have more than one replica.

#### Procedure

1. To set the image registry storage as a block storage type, patch the registry so that it uses the **Recreate** rollout strategy and runs with only **1** replica:

```
$ oc patch config.imageregistry.operator.openshift.io/cluster --type=merge -p '{"spec": {"rolloutStrategy": "Recreate", "replicas": 1}}'
```

2. Provision the PV for the block storage device, and create a PVC for that volume. The requested block volume uses the ReadWriteOnce (RWO) access mode.

- a. Create a **pvc.yaml** file with the following contents to define a VMware vSphere **PersistentVolumeClaim** object:

```
kind: PersistentVolumeClaim
apiVersion: v1
metadata:
  name: image-registry-storage 1
  namespace: openshift-image-registry 2
spec:
  accessModes:
  - ReadWriteOnce 3
  resources:
    requests:
      storage: 100Gi 4
```

- 1 A unique name that represents the **PersistentVolumeClaim** object.
- 2 The namespace for the **PersistentVolumeClaim** object, which is **openshift-image-registry**.
- 3 The access mode of the persistent volume claim. With **ReadWriteOnce**, the volume can be mounted with read and write permissions by a single node.
- 4 The size of the persistent volume claim.

- b. Create the **PersistentVolumeClaim** object from the file:

```
$ oc create -f pvc.yaml -n openshift-image-registry
```

3. Edit the registry configuration so that it references the correct PVC:

```
$ oc edit config.imageregistry.operator.openshift.io -o yaml
```

### Example output

```
storage:
  pvc:
    claim: 1
```

- 1** Creating a custom PVC allows you to leave the **claim** field blank for the default automatic creation of an **image-registry-storage** PVC.

For instructions about configuring registry storage so that it references the correct PVC, see [Configuring the registry for vSphere](#).

## 21.6.23. Completing installation on user-provisioned infrastructure

After you complete the Operator configuration, you can finish installing the cluster on infrastructure that you provide.

### Prerequisites

- Your control plane has initialized.
- You have completed the initial Operator configuration.

### Procedure

1. Confirm that all the cluster components are online with the following command:

```
$ watch -n5 oc get clusteroperators
```

### Example output

NAME	VERSION	AVAILABLE	PROGRESSING	DEGRADED	SINCE
authentication	4.10.0	True	False	False	19m
baremetal	4.10.0	True	False	False	37m
cloud-credential	4.10.0	True	False	False	40m
cluster-autoscaler	4.10.0	True	False	False	37m
config-operator	4.10.0	True	False	False	38m
console	4.10.0	True	False	False	26m
csi-snapshot-controller	4.10.0	True	False	False	37m
dns	4.10.0	True	False	False	37m
etcd	4.10.0	True	False	False	36m
image-registry	4.10.0	True	False	False	31m
ingress	4.10.0	True	False	False	30m
insights	4.10.0	True	False	False	31m
kube-apiserver	4.10.0	True	False	False	26m
kube-controller-manager	4.10.0	True	False	False	36m
kube-scheduler	4.10.0	True	False	False	36m
kube-storage-version-migrator	4.10.0	True	False	False	37m



machine-api	4.10.0	True	False	False	29m
machine-approver	4.10.0	True	False	False	37m
machine-config	4.10.0	True	False	False	36m
marketplace	4.10.0	True	False	False	37m
monitoring	4.10.0	True	False	False	29m
network	4.10.0	True	False	False	38m
node-tuning	4.10.0	True	False	False	37m
openshift-apiserver	4.10.0	True	False	False	32m
openshift-controller-manager	4.10.0	True	False	False	30m
openshift-samples	4.10.0	True	False	False	32m
operator-lifecycle-manager	4.10.0	True	False	False	37m
operator-lifecycle-manager-catalog	4.10.0	True	False	False	37m
operator-lifecycle-manager-packageserver	4.10.0	True	False	False	32m
service-ca	4.10.0	True	False	False	38m
storage	4.10.0	True	False	False	37m

Alternatively, the following command notifies you when all of the clusters are available. It also retrieves and displays credentials:

```
$ ./openshift-install --dir <installation_directory> wait-for install-complete 1
```

- 1** For **<installation\_directory>**, specify the path to the directory that you stored the installation files in.

### Example output

```
INFO Waiting up to 30m0s for the cluster to initialize...
```

The command succeeds when the Cluster Version Operator finishes deploying the OpenShift Container Platform cluster from Kubernetes API server.

### IMPORTANT

- The Ignition config files that the installation program generates contain certificates that expire after 24 hours, which are then renewed at that time. If the cluster is shut down before renewing the certificates and the cluster is later restarted after the 24 hours have elapsed, the cluster automatically recovers the expired certificates. The exception is that you must manually approve the pending **node-bootstrapper** certificate signing requests (CSRs) to recover kubelet certificates. See the documentation for *Recovering from expired control plane certificates* for more information.
- It is recommended that you use Ignition config files within 12 hours after they are generated because the 24-hour certificate rotates from 16 to 22 hours after the cluster is installed. By using the Ignition config files within 12 hours, you can avoid installation failure if the certificate update runs during installation.

2. Confirm that the Kubernetes API server is communicating with the pods.

- a. To view a list of all pods, use the following command:

```
$ oc get pods --all-namespaces
```

**Example output**

```

NAMESPACE          NAME          READY STATUS
RESTARTS AGE
openshift-apiserver-operator  openshift-apiserver-operator-85cb746d55-zqhs8  1/1
Running 1 9m
openshift-apiserver          apiserver-67b9g          1/1 Running 0
3m
openshift-apiserver          apiserver-ljcmx          1/1 Running 0
1m
openshift-apiserver          apiserver-z25h4          1/1 Running 0
2m
openshift-authentication-operator  authentication-operator-69d5d8bf84-vh2n8  1/1
Running 0 5m
...

```

- b. View the logs for a pod that is listed in the output of the previous command by using the following command:

```
$ oc logs <pod_name> -n <namespace> 1
```

- 1** Specify the pod name and namespace, as shown in the output of the previous command.

If the pod logs display, the Kubernetes API server can communicate with the cluster machines.

3. For an installation with Fibre Channel Protocol (FCP), additional steps are required to enable multipathing. Do not enable multipathing during installation. See "Enabling multipathing with kernel arguments on RHCOS" in the *Post-installation machine configuration tasks* documentation for more information.

You can add extra compute machines after the cluster installation is completed by following [Adding compute machines to vSphere](#).

## 21.6.24. Backing up VMware vSphere volumes

OpenShift Container Platform provisions new volumes as independent persistent disks to freely attach and detach the volume on any node in the cluster. As a consequence, it is not possible to back up volumes that use snapshots, or to restore volumes from snapshots. See [Snapshot Limitations](#) for more information.

### Procedure

To create a backup of persistent volumes:

1. Stop the application that is using the persistent volume.
2. Clone the persistent volume.
3. Restart the application.
4. Create a backup of the cloned volume.
5. Delete the cloned volume.

### 21.6.25. Telemetry access for OpenShift Container Platform

In OpenShift Container Platform 4.10, the Telemetry service, which runs by default to provide metrics about cluster health and the success of updates, requires internet access. If your cluster is connected to the internet, Telemetry runs automatically, and your cluster is registered to [OpenShift Cluster Manager](#).

After you confirm that your [OpenShift Cluster Manager](#) inventory is correct, either maintained automatically by Telemetry or manually by using OpenShift Cluster Manager, [use subscription watch](#) to track your OpenShift Container Platform subscriptions at the account or multi-cluster level.

#### Additional resources

- See [About remote health monitoring](#) for more information about the Telemetry service

### 21.6.26. Next steps

- [Customize your cluster](#).
- If necessary, you can [opt out of remote health reporting](#).
- [Set up your registry and configure registry storage](#).
- Optional: [View the events from the vSphere Problem Detector Operator](#) to determine if the cluster has permission or storage configuration issues.

## 21.7. INSTALLING A CLUSTER ON VMC WITH USER-PROVISIONED INFRASTRUCTURE AND NETWORK CUSTOMIZATIONS

In OpenShift Container Platform version 4.10, you can install a cluster on your VMware vSphere instance using infrastructure you provision with customized network configuration options by deploying it to [VMware Cloud \(VMC\) on AWS](#).

Once you configure your VMC environment for OpenShift Container Platform deployment, you use the OpenShift Container Platform installation program from the bastion management host, co-located in the VMC environment. The installation program and control plane automates the process of deploying and managing the resources needed for the OpenShift Container Platform cluster.

By customizing your network configuration, your cluster can coexist with existing IP address allocations in your environment and integrate with existing VXLAN configurations. You must set most of the network configuration parameters during installation, and you can modify only **kubeProxy** configuration parameters in a running cluster.

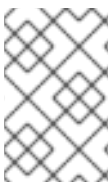

#### NOTE

OpenShift Container Platform supports deploying a cluster to a single VMware vCenter only. Deploying a cluster with machines/machine sets on multiple vCenters is not supported.

### 21.7.1. Setting up VMC for vSphere

You can install OpenShift Container Platform on VMware Cloud (VMC) on AWS hosted vSphere clusters to enable applications to be deployed and managed both on-premise and off-premise, across the hybrid cloud.

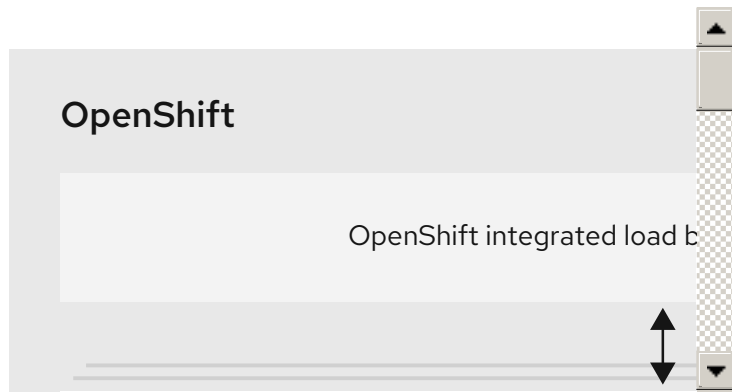

You must configure several options in your VMC environment prior to installing OpenShift Container Platform on VMware vSphere. Ensure your VMC environment has the following prerequisites:

- Create a non-exclusive, DHCP-enabled, NSX-T network segment and subnet. Other virtual machines (VMs) can be hosted on the subnet, but at least eight IP addresses must be available for the OpenShift Container Platform deployment.
- Configure the following firewall rules:
  - An ANY:ANY firewall rule between the OpenShift Container Platform compute network and the internet. This is used by nodes and applications to download container images.
  - An ANY:ANY firewall rule between the installation host and the software-defined data center (SDDC) management network on port 443. This allows you to upload the Red Hat Enterprise Linux CoreOS (RHCOS) OVA during deployment.
  - An HTTPS firewall rule between the OpenShift Container Platform compute network and vCenter. This connection allows OpenShift Container Platform to communicate with vCenter for provisioning and managing nodes, persistent volume claims (PVCs), and other resources.
- You must have the following information to deploy OpenShift Container Platform:
  - The OpenShift Container Platform cluster name, such as **vmc-prod-1**.
  - The base DNS name, such as **companyname.com**.
  - If not using the default, the pod network CIDR and services network CIDR must be identified, which are set by default to **10.128.0.0/14** and **172.30.0.0/16**, respectively. These CIDRs are used for pod-to-pod and pod-to-service communication and are not accessible externally; however, they must not overlap with existing subnets in your organization.
  - The following vCenter information:
    - vCenter hostname, username, and password
    - Datacenter name, such as **SDDC-Datacenter**
    - Cluster name, such as **Cluster-1**
    - Network name
    - Datastore name, such as **WorkloadDatastore**

**NOTE**

It is recommended to move your vSphere cluster to the VMC **Compute-ResourcePool** resource pool after your cluster installation is finished.

- A Linux-based host deployed to VMC as a bastion.
  - The bastion host can be Red Hat Enterprise Linux (RHEL) or any another Linux-based host; it must have internet connectivity and the ability to upload an OVA to the ESXi hosts.
  - Download and install the OpenShift CLI tools to the bastion host.
    - The **openshift-install** installation program
    - The OpenShift CLI (**oc**) tool

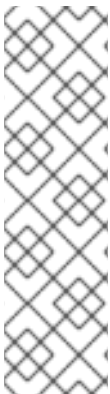
**NOTE**

You cannot use the VMware NSX Container Plugin for Kubernetes (NCP), and NSX is not used as the OpenShift SDN. The version of NSX currently available with VMC is incompatible with the version of NCP certified with OpenShift Container Platform.

However, the NSX DHCP service is used for virtual machine IP management with the full-stack automated OpenShift Container Platform deployment and with nodes provisioned, either manually or automatically, by the Machine API integration with vSphere. Additionally, NSX firewall rules are created to enable access with the OpenShift Container Platform cluster and between the bastion host and the VMC vSphere hosts.

### 21.7.1.1. VMC Sizer tool

VMware Cloud on AWS is built on top of AWS bare metal infrastructure; this is the same bare metal infrastructure which runs AWS native services. When a VMware cloud on AWS software-defined data center (SDDC) is deployed, you consume these physical server nodes and run the VMware ESXi hypervisor in a single tenant fashion. This means the physical infrastructure is not accessible to anyone else using VMC. It is important to consider how many physical hosts you will need to host your virtual infrastructure.

To determine this, VMware provides the [VMC on AWS Sizer](#). With this tool, you can define the resources you intend to host on VMC:

- Types of workloads
- Total number of virtual machines
- Specification information such as:
  - Storage requirements
  - vCPUs
  - vRAM
  - Overcommit ratios

With these details, the sizer tool can generate a report, based on VMware best practices, and recommend your cluster configuration and the number of hosts you will need.

### 21.7.2. vSphere prerequisites

- You reviewed details about the [OpenShift Container Platform installation and update processes](#).
- You read the documentation on [selecting a cluster installation method and preparing it for users](#).
- You provisioned [block registry storage](#). For more information on persistent storage, see [Understanding persistent storage](#).
- If you use a firewall, you [configured it to allow the sites](#) that your cluster requires access to.

### 21.7.3. Internet access for OpenShift Container Platform

In OpenShift Container Platform 4.10, you require access to the internet to install your cluster.

You must have internet access to:

- Access [OpenShift Cluster Manager](#) to download the installation program and perform subscription management. If the cluster has internet access and you do not disable Telemetry, that service automatically entitles your cluster.
- Access [Quay.io](#) to obtain the packages that are required to install your cluster.
- Obtain the packages that are required to perform cluster updates.



#### IMPORTANT

If your cluster cannot have direct internet access, you can perform a restricted network installation on some types of infrastructure that you provision. During that process, you download the required content and use it to populate a mirror registry with the installation packages. With some installation types, the environment that you install your cluster in will not require internet access. Before you update the cluster, you update the content of the mirror registry.

### 21.7.4. VMware vSphere infrastructure requirements

You must install the OpenShift Container Platform cluster on a VMware vSphere version 7 instance that meets the requirements for the components that you use.



#### NOTE

OpenShift Container Platform version 4.10 does not support VMware vSphere version 8.0.

You can host the VMware vSphere infrastructure on-premise or on a [VMware Cloud Verified provider](#) that meets the requirements outlined in the following table:

**Table 21.59. Version requirements for vSphere virtual environments**

Virtual environment product	Required version
VM hardware version	15 or later

Virtual environment product	Required version
vSphere ESXi hosts	7
vCenter host	7



### IMPORTANT

Installing a cluster on VMware vSphere version 7.0 Update 1 is now deprecated. These versions are still fully supported, but version 4.10 of OpenShift Container Platform requires vSphere virtual hardware version 15 or later. Hardware version 15 is now the default for vSphere virtual machines in OpenShift Container Platform. To update the hardware version for your vSphere nodes, see the "Updating hardware on nodes running in vSphere" article.

If your vSphere nodes are below hardware version 15 or your VMware vSphere version is earlier than 6.7U3, upgrading from OpenShift Container Platform 4.10 to OpenShift Container Platform 4.11 is not available.

**Table 21.60. Minimum supported vSphere version for VMware components**

Component	Minimum supported versions	Description
Hypervisor	vSphere 7 with HW version 15	This version is the minimum version that Red Hat Enterprise Linux CoreOS (RHCOS) supports. For more information about supported hardware on the latest version of Red Hat Enterprise Linux (RHEL) that is compatible with RHCOS, see <a href="#">Hardware</a> on the Red Hat Customer Portal.
Storage with in-tree drivers	vSphere 7	This plugin creates vSphere storage by using the in-tree storage drivers for vSphere included in OpenShift Container Platform.

If you use a vSphere version 6.5 instance, upgrade to 7.0 before you install OpenShift Container Platform.

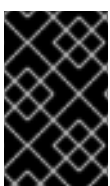

### IMPORTANT

You must ensure that the time on your ESXi hosts is synchronized before you install OpenShift Container Platform. See [Edit Time Configuration for a Host](#) in the VMware documentation.

## 21.7.5. VMware vSphere CSI Driver Operator requirements

To install the vSphere CSI Driver Operator, the following requirements must be met:

- VMware vSphere version 6.7U3 or later
- Virtual machines of hardware version 15 or later
- No third-party vSphere CSI driver already installed in the cluster



### IMPORTANT

If a third-party vSphere CSI driver is present in the cluster, OpenShift Container Platform does not overwrite it. If you continue with the third-party vSphere CSI driver when upgrading to the next major version of OpenShift Container Platform, the **oc** CLI prompts you with the following message:

```
VSphereCSIDriverOperatorCRUpgradeable: VMwareVSphereControllerUpgradeable:
found existing unsupported csi.vsphere.vmware.com driver
```

The previous message informs you that Red Hat does not support the third-party vSphere CSI driver during an OpenShift Container Platform upgrade operation. You can choose to ignore this message and continue with the upgrade operation.

#### Additional resources

- To remove a third-party CSI driver, see [Removing a third-party vSphere CSI Driver](#) .
- To update the hardware version for your vSphere nodes, see [Updating hardware on nodes running in vSphere](#).

## 21.7.6. Requirements for a cluster with user-provisioned infrastructure

For a cluster that contains user-provisioned infrastructure, you must deploy all of the required machines.

This section describes the requirements for deploying OpenShift Container Platform on user-provisioned infrastructure.

### 21.7.6.1. Required machines for cluster installation

The smallest OpenShift Container Platform clusters require the following hosts:

**Table 21.61. Minimum required hosts**

Hosts	Description
One temporary bootstrap machine	The cluster requires the bootstrap machine to deploy the OpenShift Container Platform cluster on the three control plane machines. You can remove the bootstrap machine after you install the cluster.
Three control plane machines	The control plane machines run the Kubernetes and OpenShift Container Platform services that form the control plane.



Hosts	Description
At least two compute machines, which are also known as worker machines.	The workloads requested by OpenShift Container Platform users run on the compute machines.

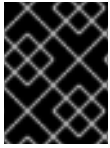

### IMPORTANT

To maintain high availability of your cluster, use separate physical hosts for these cluster machines.

The bootstrap and control plane machines must use Red Hat Enterprise Linux CoreOS (RHCOS) as the operating system. However, the compute machines can choose between Red Hat Enterprise Linux CoreOS (RHCOS), Red Hat Enterprise Linux (RHEL) 8.4, or RHEL 8.5.

Note that RHCOS is based on Red Hat Enterprise Linux (RHEL) 8 and inherits all of its hardware certifications and requirements. See [Red Hat Enterprise Linux technology capabilities and limits](#).

#### 21.7.6.2. Minimum resource requirements for cluster installation

Each cluster machine must meet the following minimum requirements:

**Table 21.62. Minimum resource requirements**

Machine	Operating System	vCPU [1]	Virtual RAM	Storage	IOPS [2]
Bootstrap	RHCOS	4	16 GB	100 GB	300
Control plane	RHCOS	4	16 GB	100 GB	300
Compute	RHCOS, RHEL 8.4, or RHEL 8.5 <sup>[3]</sup>	2	8 GB	100 GB	300

1. One vCPU is equivalent to one physical core when simultaneous multithreading (SMT), or hyperthreading, is not enabled. When enabled, use the following formula to calculate the corresponding ratio:  $(\text{threads per core} \times \text{cores}) \times \text{sockets} = \text{vCPUs}$ .
2. OpenShift Container Platform and Kubernetes are sensitive to disk performance, and faster storage is recommended, particularly for etcd on the control plane nodes which require a 10 ms p99 fsync duration. Note that on many cloud platforms, storage size and IOPS scale together, so you might need to over-allocate storage volume to obtain sufficient performance.
3. As with all user-provisioned installations, if you choose to use RHEL compute machines in your cluster, you take responsibility for all operating system life cycle management and maintenance, including performing system updates, applying patches, and completing all other required tasks. Use of RHEL 7 compute machines is deprecated and has been removed in OpenShift Container Platform 4.10 and later.

If an instance type for your platform meets the minimum requirements for cluster machines, it is supported to use in OpenShift Container Platform.

### 21.7.6.3. Certificate signing requests management

Because your cluster has limited access to automatic machine management when you use infrastructure that you provision, you must provide a mechanism for approving cluster certificate signing requests (CSRs) after installation. The **kube-controller-manager** only approves the kubelet client CSRs. The **machine-approver** cannot guarantee the validity of a serving certificate that is requested by using kubelet credentials because it cannot confirm that the correct machine issued the request. You must determine and implement a method of verifying the validity of the kubelet serving certificate requests and approving them.

### 21.7.6.4. Networking requirements for user-provisioned infrastructure

All the Red Hat Enterprise Linux CoreOS (RHCOS) machines require networking to be configured in **initramfs** during boot to fetch their Ignition config files.

During the initial boot, the machines require an IP address configuration that is set either through a DHCP server or statically by providing the required boot options. After a network connection is established, the machines download their Ignition config files from an HTTP or HTTPS server. The Ignition config files are then used to set the exact state of each machine. The Machine Config Operator completes more changes to the machines, such as the application of new certificates or keys, after installation.

It is recommended to use a DHCP server for long-term management of the cluster machines. Ensure that the DHCP server is configured to provide persistent IP addresses, DNS server information, and hostnames to the cluster machines.



#### NOTE

If a DHCP service is not available for your user-provisioned infrastructure, you can instead provide the IP networking configuration and the address of the DNS server to the nodes at RHCOS install time. These can be passed as boot arguments if you are installing from an ISO image. See the *Installing RHCOS and starting the OpenShift Container Platform bootstrap process* section for more information about static IP provisioning and advanced networking options.

The Kubernetes API server must be able to resolve the node names of the cluster machines. If the API servers and worker nodes are in different zones, you can configure a default DNS search zone to allow the API server to resolve the node names. Another supported approach is to always refer to hosts by their fully-qualified domain names in both the node objects and all DNS requests.

#### 21.7.6.4.1. Setting the cluster node hostnames through DHCP

On Red Hat Enterprise Linux CoreOS (RHCOS) machines, the hostname is set through NetworkManager. By default, the machines obtain their hostname through DHCP. If the hostname is not provided by DHCP, set statically through kernel arguments, or another method, it is obtained through a reverse DNS lookup. Reverse DNS lookup occurs after the network has been initialized on a node and can take time to resolve. Other system services can start prior to this and detect the hostname as **localhost** or similar. You can avoid this by using DHCP to provide the hostname for each cluster node.

Additionally, setting the hostnames through DHCP can bypass any manual DNS record name configuration errors in environments that have a DNS split-horizon implementation.

#### 21.7.6.4.2. Network connectivity requirements

You must configure the network connectivity between machines to allow OpenShift Container Platform cluster components to communicate. Each machine must be able to resolve the hostnames of all other machines in the cluster.

This section provides details about the ports that are required.

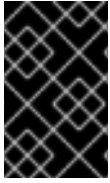

### IMPORTANT

In connected OpenShift Container Platform environments, all nodes are required to have internet access to pull images for platform containers and provide telemetry data to Red Hat.

**Table 21.63. Ports used for all-machine to all-machine communications**

Protocol	Port	Description
ICMP	N/A	Network reachability tests
TCP	<b>1936</b>	Metrics
	<b>9000-9999</b>	Host level services, including the node exporter on ports <b>9100-9101</b> and the Cluster Version Operator on port <b>9099</b> .
	<b>10250-10259</b>	The default ports that Kubernetes reserves
	<b>10256</b>	openshift-sdn
UDP	<b>4789</b>	VXLAN
	<b>6081</b>	Geneve
	<b>9000-9999</b>	Host level services, including the node exporter on ports <b>9100-9101</b> .
	<b>500</b>	IPsec IKE packets
	<b>4500</b>	IPsec NAT-T packets
TCP/UDP	<b>30000-32767</b>	Kubernetes node port
ESP	N/A	IPsec Encapsulating Security Payload (ESP)

**Table 21.64. Ports used for all-machine to control plane communications**

Protocol	Port	Description
TCP	<b>6443</b>	Kubernetes API

**Table 21.65. Ports used for control plane machine to control plane machine communications**

Protocol	Port	Description
TCP	<b>2379-2380</b>	etcd server and peer ports

### Ethernet adaptor hardware address requirements

When provisioning VMs for the cluster, the ethernet interfaces configured for each VM must use a MAC address from the VMware Organizationally Unique Identifier (OUI) allocation ranges:

- **00:05:69:00:00:00 to 00:05:69:FF:FF:FF**
- **00:0c:29:00:00:00 to 00:0c:29:FF:FF:FF**
- **00:1c:14:00:00:00 to 00:1c:14:FF:FF:FF**
- **00:50:56:00:00:00 to 00:50:56:3F:FF:FF**

If a MAC address outside the VMware OUI is used, the cluster installation will not succeed.

### NTP configuration for user-provisioned infrastructure

OpenShift Container Platform clusters are configured to use a public Network Time Protocol (NTP) server by default. If you want to use a local enterprise NTP server, or if your cluster is being deployed in a disconnected network, you can configure the cluster to use a specific time server. For more information, see the documentation for *Configuring chrony time service*.

If a DHCP server provides NTP server information, the chrony time service on the Red Hat Enterprise Linux CoreOS (RHCOS) machines read the information and can sync the clock with the NTP servers.

#### 21.7.6.5. User-provisioned DNS requirements

In OpenShift Container Platform deployments, DNS name resolution is required for the following components:

- The Kubernetes API
- The OpenShift Container Platform application wildcard
- The bootstrap, control plane, and compute machines

Reverse DNS resolution is also required for the Kubernetes API, the bootstrap machine, the control plane machines, and the compute machines.

DNS A/AAAA or CNAME records are used for name resolution and PTR records are used for reverse name resolution. The reverse records are important because Red Hat Enterprise Linux CoreOS (RHCOS) uses the reverse records to set the hostnames for all the nodes, unless the hostnames are provided by DHCP. Additionally, the reverse records are used to generate the certificate signing requests (CSR) that OpenShift Container Platform needs to operate.



#### NOTE

It is recommended to use a DHCP server to provide the hostnames to each cluster node. See the *DHCP recommendations for user-provisioned infrastructure* section for more information.

The following DNS records are required for a user-provisioned OpenShift Container Platform cluster

and they must be in place before installation. In each record, `<cluster_name>` is the cluster name and `<base_domain>` is the base domain that you specify in the `install-config.yaml` file. A complete DNS record takes the form: `<component>.<cluster_name>.<base_domain>.`

Table 21.66. Required DNS records

Component	Record	Description
Kubernetes API	<code>api.&lt;cluster_name&gt;.&lt;base_domain&gt;.</code>	A DNS A/AAAA or CNAME record, and a DNS PTR record, to identify the API load balancer. These records must be resolvable by both clients external to the cluster and from all the nodes within the cluster.
	<code>api-int.&lt;cluster_name&gt;.&lt;base_domain&gt;.</code>	<p>A DNS A/AAAA or CNAME record, and a DNS PTR record, to internally identify the API load balancer. These records must be resolvable from all the nodes within the cluster.</p> <div style="display: flex; align-items: flex-start;">  <div> <p><b>IMPORTANT</b></p> <p>The API server must be able to resolve the worker nodes by the hostnames that are recorded in Kubernetes. If the API server cannot resolve the node names, then proxied API calls can fail, and you cannot retrieve logs from pods.</p> </div> </div>
Routes	<code>*.apps.&lt;cluster_name&gt;.&lt;base_domain&gt;.</code>	<p>A wildcard DNS A/AAAA or CNAME record that refers to the application ingress load balancer. The application ingress load balancer targets the machines that run the Ingress Controller pods. The Ingress Controller pods run on the compute machines by default. These records must be resolvable by both clients external to the cluster and from all the nodes within the cluster.</p> <p>For example, <code>console-openshift-console.apps.&lt;cluster_name&gt;.&lt;base_domain&gt;</code> is used as a wildcard route to the OpenShift Container Platform console.</p>
Bootstrap machine	<code>bootstrap.&lt;cluster_name&gt;.&lt;base_domain&gt;.</code>	A DNS A/AAAA or CNAME record, and a DNS PTR record, to identify the bootstrap machine. These records must be resolvable by the nodes within the cluster.
Control plane machines	<code>&lt;master&gt;&lt;n&gt;.&lt;cluster_name&gt;.&lt;base_domain&gt;.</code>	DNS A/AAAA or CNAME records and DNS PTR records to identify each machine for the control plane nodes. These records must be resolvable by the nodes within the cluster.
Compute machines	<code>&lt;worker&gt;&lt;n&gt;.&lt;cluster_name&gt;.&lt;base_domain&gt;.</code>	DNS A/AAAA or CNAME records and DNS PTR records to identify each machine for the worker nodes. These records must be resolvable by the nodes within the cluster.

**NOTE**

In OpenShift Container Platform 4.4 and later, you do not need to specify `etcd` host and `SRV` records in your DNS configuration.

**TIP**

You can use the **dig** command to verify name and reverse name resolution. See the section on *Validating DNS resolution for user-provisioned infrastructure* for detailed validation steps.

**21.7.6.5.1. Example DNS configuration for user-provisioned clusters**

This section provides A and PTR record configuration samples that meet the DNS requirements for deploying OpenShift Container Platform on user-provisioned infrastructure. The samples are not meant to provide advice for choosing one DNS solution over another.

In the examples, the cluster name is **ocp4** and the base domain is **example.com**.

**Example DNS A record configuration for a user-provisioned cluster**

The following example is a BIND zone file that shows sample A records for name resolution in a user-provisioned cluster.

**Example 21.16. Sample DNS zone database**

```
$TTL 1W
@ IN SOA ns1.example.com. root (
    2019070700 ; serial
    3H ; refresh (3 hours)
    30M ; retry (30 minutes)
    2W ; expiry (2 weeks)
    1W ) ; minimum (1 week)
IN NS ns1.example.com.
IN MX 10 smtp.example.com.
;
;
ns1.example.com. IN A 192.168.1.5
smtp.example.com. IN A 192.168.1.5
;
helper.example.com. IN A 192.168.1.5
helper.ocp4.example.com. IN A 192.168.1.5
;
api.ocp4.example.com. IN A 192.168.1.5 1
api-int.ocp4.example.com. IN A 192.168.1.5 2
;
*.apps.ocp4.example.com. IN A 192.168.1.5 3
;
bootstrap.ocp4.example.com. IN A 192.168.1.96 4
;
master0.ocp4.example.com. IN A 192.168.1.97 5
master1.ocp4.example.com. IN A 192.168.1.98 6
master2.ocp4.example.com. IN A 192.168.1.99 7
;
worker0.ocp4.example.com. IN A 192.168.1.11 8
```

```
worker1.ocp4.example.com. IN A 192.168.1.7 9
```

```
;
;EOF
```

- 1 Provides name resolution for the Kubernetes API. The record refers to the IP address of the API load balancer.
- 2 Provides name resolution for the Kubernetes API. The record refers to the IP address of the API load balancer and is used for internal cluster communications.
- 3 Provides name resolution for the wildcard routes. The record refers to the IP address of the application ingress load balancer. The application ingress load balancer targets the machines that run the Ingress Controller pods. The Ingress Controller pods run on the compute machines by default.



#### NOTE

In the example, the same load balancer is used for the Kubernetes API and application ingress traffic. In production scenarios, you can deploy the API and application ingress load balancers separately so that you can scale the load balancer infrastructure for each in isolation.

- 4 Provides name resolution for the bootstrap machine.
- 5 6 7 Provides name resolution for the control plane machines.
- 8 9 Provides name resolution for the compute machines.

### Example DNS PTR record configuration for a user-provisioned cluster

The following example BIND zone file shows sample PTR records for reverse name resolution in a user-provisioned cluster.

#### Example 21.17. Sample DNS zone database for reverse records

```
$TTL 1W
@ IN SOA ns1.example.com. root (
  2019070700 ; serial
  3H ; refresh (3 hours)
  30M ; retry (30 minutes)
  2W ; expiry (2 weeks)
  1W ) ; minimum (1 week)
IN NS ns1.example.com.
;
5.1.168.192.in-addr.arpa. IN PTR api.ocp4.example.com. 1
5.1.168.192.in-addr.arpa. IN PTR api-int.ocp4.example.com. 2
;
96.1.168.192.in-addr.arpa. IN PTR bootstrap.ocp4.example.com. 3
;
97.1.168.192.in-addr.arpa. IN PTR master0.ocp4.example.com. 4
98.1.168.192.in-addr.arpa. IN PTR master1.ocp4.example.com. 5
99.1.168.192.in-addr.arpa. IN PTR master2.ocp4.example.com. 6
```

```

;
11.1.168.192.in-addr.arpa. IN PTR worker0.ocp4.example.com. 7
7.1.168.192.in-addr.arpa. IN PTR worker1.ocp4.example.com. 8
;
;EOF

```

- 1 Provides reverse DNS resolution for the Kubernetes API. The PTR record refers to the record name of the API load balancer.
- 2 Provides reverse DNS resolution for the Kubernetes API. The PTR record refers to the record name of the API load balancer and is used for internal cluster communications.
- 3 Provides reverse DNS resolution for the bootstrap machine.
- 4 5 6 Provides reverse DNS resolution for the control plane machines.
- 7 8 Provides reverse DNS resolution for the compute machines.



#### NOTE

A PTR record is not required for the OpenShift Container Platform application wildcard.

### 21.7.6.6. Load balancing requirements for user-provisioned infrastructure

Before you install OpenShift Container Platform, you must provision the API and application ingress load balancing infrastructure. In production scenarios, you can deploy the API and application ingress load balancers separately so that you can scale the load balancer infrastructure for each in isolation.



#### NOTE

If you want to deploy the API and application Ingress load balancers with a Red Hat Enterprise Linux (RHEL) instance, you must purchase the RHEL subscription separately.

The load balancing infrastructure must meet the following requirements:

1. **API load balancer.** Provides a common endpoint for users, both human and machine, to interact with and configure the platform. Configure the following conditions:
  - Layer 4 load balancing only. This can be referred to as Raw TCP, SSL Passthrough, or SSL Bridge mode. If you use SSL Bridge mode, you must enable Server Name Indication (SNI) for the API routes.
  - A stateless load balancing algorithm. The options vary based on the load balancer implementation.

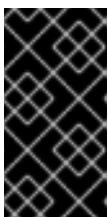

#### IMPORTANT

Do not configure session persistence for an API load balancer. Configuring session persistence for a Kubernetes API server might cause performance issues from excess application traffic for your OpenShift Container Platform cluster and the Kubernetes API that runs inside the cluster.



Configure the following ports on both the front and back of the load balancers:

**Table 21.67. API load balancer**

Port	Back-end machines (pool members)	Internal	External	Description
<b>6443</b>	Bootstrap and control plane. You remove the bootstrap machine from the load balancer after the bootstrap machine initializes the cluster control plane. You must configure the <b>/readyz</b> endpoint for the API server health check probe.	X	X	Kubernetes API server
<b>22623</b>	Bootstrap and control plane. You remove the bootstrap machine from the load balancer after the bootstrap machine initializes the cluster control plane.	X		Machine config server



#### NOTE

The load balancer must be configured to take a maximum of 30 seconds from the time the API server turns off the **/readyz** endpoint to the removal of the API server instance from the pool. Within the time frame after **/readyz** returns an error or becomes healthy, the endpoint must have been removed or added. Probing every 5 or 10 seconds, with two successful requests to become healthy and three to become unhealthy, are well-tested values.

2. **Application Ingress load balancer:** Provides an ingress point for application traffic flowing in from outside the cluster. A working configuration for the Ingress router is required for an OpenShift Container Platform cluster.

Configure the following conditions:

- Layer 4 load balancing only. This can be referred to as Raw TCP, SSL Passthrough, or SSL Bridge mode. If you use SSL Bridge mode, you must enable Server Name Indication (SNI) for the ingress routes.
- A connection-based or session-based persistence is recommended, based on the options available and types of applications that will be hosted on the platform.

#### TIP

If the true IP address of the client can be seen by the application Ingress load balancer, enabling source IP-based session persistence can improve performance for applications that use end-to-end TLS encryption.

Configure the following ports on both the front and back of the load balancers:

**Table 21.68. Application Ingress load balancer**

Port	Back-end machines (pool members)	Internal	External	Description
<b>443</b>	The machines that run the Ingress Controller pods, compute, or worker, by default.	X	X	HTTPS traffic
<b>80</b>	The machines that run the Ingress Controller pods, compute, or worker, by default.	X	X	HTTP traffic

**NOTE**

If you are deploying a three-node cluster with zero compute nodes, the Ingress Controller pods run on the control plane nodes. In three-node cluster deployments, you must configure your application Ingress load balancer to route HTTP and HTTPS traffic to the control plane nodes.

**21.7.6.6.1. Example load balancer configuration for user-provisioned clusters**

This section provides an example API and application ingress load balancer configuration that meets the load balancing requirements for user-provisioned clusters. The sample is an **/etc/haproxy/haproxy.cfg** configuration for an HAProxy load balancer. The example is not meant to provide advice for choosing one load balancing solution over another.

In the example, the same load balancer is used for the Kubernetes API and application ingress traffic. In production scenarios, you can deploy the API and application ingress load balancers separately so that you can scale the load balancer infrastructure for each in isolation.

**NOTE**

If you are using HAProxy as a load balancer and SELinux is set to **enforcing**, you must ensure that the HAProxy service can bind to the configured TCP port by running **setsebool -P haproxy\_connect\_any=1**.

**Example 21.18. Sample API and application Ingress load balancer configuration**

```
global
  log      127.0.0.1 local2
  pidfile /var/run/haproxy.pid
  maxconn 4000
  daemon
defaults
  mode          http
  log           global
  option        dontlognull
  option http-server-close
  option        redispatch
  retries       3
  timeout http-request 10s
  timeout queue    1m
  timeout connect 10s
  timeout client  1m
```

```

timeout server      1m
timeout http-keep-alive 10s
timeout check       10s
maxconn             3000
listen api-server-6443 1
bind *:6443
mode tcp
server bootstrap bootstrap.ocp4.example.com:6443 check inter 1s backup 2
server master0 master0.ocp4.example.com:6443 check inter 1s
server master1 master1.ocp4.example.com:6443 check inter 1s
server master2 master2.ocp4.example.com:6443 check inter 1s
listen machine-config-server-22623 3
bind *:22623
mode tcp
server bootstrap bootstrap.ocp4.example.com:22623 check inter 1s backup 4
server master0 master0.ocp4.example.com:22623 check inter 1s
server master1 master1.ocp4.example.com:22623 check inter 1s
server master2 master2.ocp4.example.com:22623 check inter 1s
listen ingress-router-443 5
bind *:443
mode tcp
balance source
server worker0 worker0.ocp4.example.com:443 check inter 1s
server worker1 worker1.ocp4.example.com:443 check inter 1s
listen ingress-router-80 6
bind *:80
mode tcp
balance source
server worker0 worker0.ocp4.example.com:80 check inter 1s
server worker1 worker1.ocp4.example.com:80 check inter 1s

```

- 1** Port **6443** handles the Kubernetes API traffic and points to the control plane machines.
- 2** **4** The bootstrap entries must be in place before the OpenShift Container Platform cluster installation and they must be removed after the bootstrap process is complete.
- 3** Port **22623** handles the machine config server traffic and points to the control plane machines.
- 5** Port **443** handles the HTTPS traffic and points to the machines that run the Ingress Controller pods. The Ingress Controller pods run on the compute machines by default.
- 6** Port **80** handles the HTTP traffic and points to the machines that run the Ingress Controller pods. The Ingress Controller pods run on the compute machines by default.



#### NOTE

If you are deploying a three-node cluster with zero compute nodes, the Ingress Controller pods run on the control plane nodes. In three-node cluster deployments, you must configure your application Ingress load balancer to route HTTP and HTTPS traffic to the control plane nodes.

**TIP**

If you are using HAProxy as a load balancer, you can check that the **haproxy** process is listening on ports **6443**, **22623**, **443**, and **80** by running **netstat -nltp** on the HAProxy node.

### 21.7.7. Preparing the user-provisioned infrastructure

Before you install OpenShift Container Platform on user-provisioned infrastructure, you must prepare the underlying infrastructure.

This section provides details about the high-level steps required to set up your cluster infrastructure in preparation for an OpenShift Container Platform installation. This includes configuring IP networking and network connectivity for your cluster nodes, enabling the required ports through your firewall, and setting up the required DNS and load balancing infrastructure.

After preparation, your cluster infrastructure must meet the requirements outlined in the *Requirements for a cluster with user-provisioned infrastructure* section.

**Prerequisites**

- You have reviewed the [OpenShift Container Platform 4.x Tested Integrations](#) page.
- You have reviewed the infrastructure requirements detailed in the *Requirements for a cluster with user-provisioned infrastructure* section.

**Procedure**

1. If you are using DHCP to provide the IP networking configuration to your cluster nodes, configure your DHCP service.
  - a. Add persistent IP addresses for the nodes to your DHCP server configuration. In your configuration, match the MAC address of the relevant network interface to the intended IP address for each node.
  - b. When you use DHCP to configure IP addressing for the cluster machines, the machines also obtain the DNS server information through DHCP. Define the persistent DNS server address that is used by the cluster nodes through your DHCP server configuration.

**NOTE**

If you are not using a DHCP service, you must provide the IP networking configuration and the address of the DNS server to the nodes at RHCOS install time. These can be passed as boot arguments if you are installing from an ISO image. See the *Installing RHCOS and starting the OpenShift Container Platform bootstrap process* section for more information about static IP provisioning and advanced networking options.

- c. Define the hostnames of your cluster nodes in your DHCP server configuration. See the *Setting the cluster node hostnames through DHCP* section for details about hostname considerations.

**NOTE**

If you are not using a DHCP service, the cluster nodes obtain their hostname through a reverse DNS lookup.

2. Ensure that your network infrastructure provides the required network connectivity between the cluster components. See the *Networking requirements for user-provisioned infrastructure* section for details about the requirements.
3. Configure your firewall to enable the ports required for the OpenShift Container Platform cluster components to communicate. See *Networking requirements for user-provisioned infrastructure* section for details about the ports that are required.

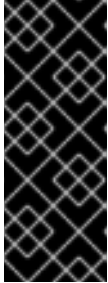

### IMPORTANT

By default, port **1936** is accessible for an OpenShift Container Platform cluster, because each control plane node needs access to this port.

Avoid using the Ingress load balancer to expose this port, because doing so might result in the exposure of sensitive information, such as statistics and metrics, related to Ingress Controllers.

4. Setup the required DNS infrastructure for your cluster.
  - a. Configure DNS name resolution for the Kubernetes API, the application wildcard, the bootstrap machine, the control plane machines, and the compute machines.
  - b. Configure reverse DNS resolution for the Kubernetes API, the bootstrap machine, the control plane machines, and the compute machines.  
See the *User-provisioned DNS requirements* section for more information about the OpenShift Container Platform DNS requirements.
5. Validate your DNS configuration.
  - a. From your installation node, run DNS lookups against the record names of the Kubernetes API, the wildcard routes, and the cluster nodes. Validate that the IP addresses in the responses correspond to the correct components.
  - b. From your installation node, run reverse DNS lookups against the IP addresses of the load balancer and the cluster nodes. Validate that the record names in the responses correspond to the correct components.  
See the *Validating DNS resolution for user-provisioned infrastructure* section for detailed DNS validation steps.
6. Provision the required API and application ingress load balancing infrastructure. See the *Load balancing requirements for user-provisioned infrastructure* section for more information about the requirements.



### NOTE

Some load balancing solutions require the DNS name resolution for the cluster nodes to be in place before the load balancing is initialized.

## 21.7.8. Validating DNS resolution for user-provisioned infrastructure

You can validate your DNS configuration before installing OpenShift Container Platform on user-provisioned infrastructure.



## IMPORTANT

The validation steps detailed in this section must succeed before you install your cluster.

### Prerequisites

- You have configured the required DNS records for your user-provisioned infrastructure.

### Procedure

- From your installation node, run DNS lookups against the record names of the Kubernetes API, the wildcard routes, and the cluster nodes. Validate that the IP addresses contained in the responses correspond to the correct components.
  - Perform a lookup against the Kubernetes API record name. Check that the result points to the IP address of the API load balancer:

```
$ dig +noall +answer @<nameserver_ip> api.<cluster_name>.<base_domain> 1
```

- Replace **<nameserver\_ip>** with the IP address of the nameserver, **<cluster\_name>** with your cluster name, and **<base\_domain>** with your base domain name.

#### Example output

```
api.ocp4.example.com. 0 IN A 192.168.1.5
```

- Perform a lookup against the Kubernetes internal API record name. Check that the result points to the IP address of the API load balancer:

```
$ dig +noall +answer @<nameserver_ip> api-int.<cluster_name>.<base_domain>
```

#### Example output

```
api-int.ocp4.example.com. 0 IN A 192.168.1.5
```

- Test an example **\*.apps.<cluster\_name>.<base\_domain>** DNS wildcard lookup. All of the application wildcard lookups must resolve to the IP address of the application ingress load balancer:

```
$ dig +noall +answer @<nameserver_ip> random.apps.<cluster_name>.<base_domain>
```

#### Example output

```
random.apps.ocp4.example.com. 0 IN A 192.168.1.5
```



## NOTE

In the example outputs, the same load balancer is used for the Kubernetes API and application ingress traffic. In production scenarios, you can deploy the API and application ingress load balancers separately so that you can scale the load balancer infrastructure for each in isolation.

You can replace **random** with another wildcard value. For example, you can query the route to the OpenShift Container Platform console:

```
$ dig +noall +answer @<nameserver_ip> console-openshift-console.apps.
<cluster_name>.<base_domain>
```

### Example output

```
console-openshift-console.apps.ocp4.example.com. 0 IN A 192.168.1.5
```

- d. Run a lookup against the bootstrap DNS record name. Check that the result points to the IP address of the bootstrap node:

```
$ dig +noall +answer @<nameserver_ip> bootstrap.<cluster_name>.<base_domain>
```

### Example output

```
bootstrap.ocp4.example.com. 0 IN A 192.168.1.96
```

- e. Use this method to perform lookups against the DNS record names for the control plane and compute nodes. Check that the results correspond to the IP addresses of each node.
2. From your installation node, run reverse DNS lookups against the IP addresses of the load balancer and the cluster nodes. Validate that the record names contained in the responses correspond to the correct components.

- a. Perform a reverse lookup against the IP address of the API load balancer. Check that the response includes the record names for the Kubernetes API and the Kubernetes internal API:

```
$ dig +noall +answer @<nameserver_ip> -x 192.168.1.5
```

### Example output

```
5.1.168.192.in-addr.arpa. 0 IN PTR api-int.ocp4.example.com. 1
5.1.168.192.in-addr.arpa. 0 IN PTR api.ocp4.example.com. 2
```

**1** Provides the record name for the Kubernetes internal API.

**2** Provides the record name for the Kubernetes API.



### NOTE

A PTR record is not required for the OpenShift Container Platform application wildcard. No validation step is needed for reverse DNS resolution against the IP address of the application ingress load balancer.

- b. Perform a reverse lookup against the IP address of the bootstrap node. Check that the result points to the DNS record name of the bootstrap node:

```
$ dig +noall +answer @<nameserver_ip> -x 192.168.1.96
```

## Example output

```
96.1.168.192.in-addr.arpa. 0 IN PTR bootstrap.ocp4.example.com.
```

- c. Use this method to perform reverse lookups against the IP addresses for the control plane and compute nodes. Check that the results correspond to the DNS record names of each node.

### 21.7.9. Generating a key pair for cluster node SSH access

During an OpenShift Container Platform installation, you can provide an SSH public key to the installation program. The key is passed to the Red Hat Enterprise Linux CoreOS (RHCOS) nodes through their Ignition config files and is used to authenticate SSH access to the nodes. The key is added to the `~/.ssh/authorized_keys` list for the **core** user on each node, which enables password-less authentication.

After the key is passed to the nodes, you can use the key pair to SSH in to the RHCOS nodes as the user **core**. To access the nodes through SSH, the private key identity must be managed by SSH for your local user.

If you want to SSH in to your cluster nodes to perform installation debugging or disaster recovery, you must provide the SSH public key during the installation process. The `./openshift-install gather` command also requires the SSH public key to be in place on the cluster nodes.



#### IMPORTANT

Do not skip this procedure in production environments, where disaster recovery and debugging is required.



#### NOTE

You must use a local key, not one that you configured with platform-specific approaches such as [AWS key pairs](#).

#### Procedure

1. If you do not have an existing SSH key pair on your local machine to use for authentication onto your cluster nodes, create one. For example, on a computer that uses a Linux operating system, run the following command:

```
$ ssh-keygen -t ed25519 -N "" -f <path>/<file_name> 1
```

- 1 Specify the path and file name, such as `~/.ssh/id_ed25519`, of the new SSH key. If you have an existing key pair, ensure your public key is in the your `~/.ssh` directory.



#### NOTE

If you plan to install an OpenShift Container Platform cluster that uses FIPS validated or Modules In Process cryptographic libraries on the **x86\_64** architecture, do not create a key that uses the **ed25519** algorithm. Instead, create a key that uses the **rsa** or **ecdsa** algorithm.



- View the public SSH key:

```
$ cat <path>/<file_name>.pub
```

For example, run the following to view the `~/.ssh/id_ed25519.pub` public key:

```
$ cat ~/.ssh/id_ed25519.pub
```

- Add the SSH private key identity to the SSH agent for your local user, if it has not already been added. SSH agent management of the key is required for password-less SSH authentication onto your cluster nodes, or if you want to use the `./openshift-install gather` command.

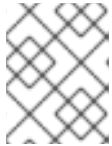

#### NOTE

On some distributions, default SSH private key identities such as `~/.ssh/id_rsa` and `~/.ssh/id_dsa` are managed automatically.

- If the `ssh-agent` process is not already running for your local user, start it as a background task:

```
$ eval "$(ssh-agent -s)"
```

#### Example output

```
Agent pid 31874
```



#### NOTE

If your cluster is in FIPS mode, only use FIPS-compliant algorithms to generate the SSH key. The key must be either RSA or ECDSA.

- Add your SSH private key to the `ssh-agent`:

```
$ ssh-add <path>/<file_name> 1
```

- 1** Specify the path and file name for your SSH private key, such as `~/.ssh/id_ed25519`

#### Example output

```
Identity added: /home/<you>/<path>/<file_name> (<computer_name>)
```

#### Next steps

- When you install OpenShift Container Platform, provide the SSH public key to the installation program.

### 21.7.10. Obtaining the installation program

Before you install OpenShift Container Platform, download the installation file on a local computer.

## Prerequisites

- You have a computer that runs Linux or macOS, with 500 MB of local disk space

## Procedure

1. Access the [Infrastructure Provider](#) page on the OpenShift Cluster Manager site. If you have a Red Hat account, log in with your credentials. If you do not, create an account.
2. Select your infrastructure provider.
3. Navigate to the page for your installation type, download the installation program that corresponds with your host operating system and architecture, and place the file in the directory where you will store the installation configuration files.



### IMPORTANT

The installation program creates several files on the computer that you use to install your cluster. You must keep the installation program and the files that the installation program creates after you finish installing the cluster. Both files are required to delete the cluster.



### IMPORTANT

Deleting the files created by the installation program does not remove your cluster, even if the cluster failed during installation. To remove your cluster, complete the OpenShift Container Platform uninstallation procedures for your specific cloud provider.

4. Extract the installation program. For example, on a computer that uses a Linux operating system, run the following command:

```
$ tar -xvf openshift-install-linux.tar.gz
```

5. Download your installation [pull secret from the Red Hat OpenShift Cluster Manager](#) . This pull secret allows you to authenticate with the services that are provided by the included authorities, including Quay.io, which serves the container images for OpenShift Container Platform components.

## 21.7.11. Manually creating the installation configuration file

For user-provisioned installations of OpenShift Container Platform, you manually generate your installation configuration file.

## Prerequisites

- You have an SSH public key on your local machine to provide to the installation program. The key will be used for SSH authentication onto your cluster nodes for debugging and disaster recovery.
- You have obtained the OpenShift Container Platform installation program and the pull secret for your cluster.

## Procedure

1. Create an installation directory to store your required installation assets in:

```
$ mkdir <installation_directory>
```



### IMPORTANT

You must create a directory. Some installation assets, like bootstrap X.509 certificates have short expiration intervals, so you must not reuse an installation directory. If you want to reuse individual files from another cluster installation, you can copy them into your directory. However, the file names for the installation assets might change between releases. Use caution when copying installation files from an earlier OpenShift Container Platform version.

2. Customize the sample **install-config.yaml** file template that is provided and save it in the **<installation\_directory>**.



### NOTE

You must name this configuration file **install-config.yaml**.



### NOTE

For some platform types, you can alternatively run **./openshift-install create install-config --dir <installation\_directory>** to generate an **install-config.yaml** file. You can provide details about your cluster configuration at the prompts.

3. Back up the **install-config.yaml** file so that you can use it to install multiple clusters.



### IMPORTANT

The **install-config.yaml** file is consumed during the next step of the installation process. You must back it up now.

#### 21.7.11.1. Sample **install-config.yaml** file for VMware vSphere

You can customize the **install-config.yaml** file to specify more details about your OpenShift Container Platform cluster's platform or modify the values of the required parameters.

```
apiVersion: v1
baseDomain: example.com 1
compute: 2
- hyperthreading: Enabled 3
  name: worker
  replicas: 0 4
controlPlane: 5
  hyperthreading: Enabled 6
  name: master
  replicas: 3 7
metadata:
  name: test 8
platform:
  vsphere:
```

```

vcenter: your.vcenter.server 9
username: username 10
password: password 11
datacenter: datacenter 12
defaultDatastore: datastore 13
folder: "/<datacenter_name>/vm/<folder_name>/<subfolder_name>" 14
resourcePool: "/<datacenter_name>/host/<cluster_name>/Resources/<resource_pool_name>" 15
diskType: thin 16
fips: false 17
pullSecret: '{"auths": ...}' 18
sshKey: 'ssh-ed25519 AAAA...' 19

```

- 1** The base domain of the cluster. All DNS records must be sub-domains of this base and include the cluster name.
- 2** **5** The **controlPlane** section is a single mapping, but the compute section is a sequence of mappings. To meet the requirements of the different data structures, the first line of the **compute** section must begin with a hyphen, -, and the first line of the **controlPlane** section must not. Although both sections currently define a single machine pool, it is possible that future versions of OpenShift Container Platform will support defining multiple compute pools during installation. Only one control plane pool is used.
- 3** **6** Whether to enable or disable simultaneous multithreading, or **hyperthreading**. By default, simultaneous multithreading is enabled to increase the performance of your machines' cores. You can disable it by setting the parameter value to **Disabled**. If you disable simultaneous multithreading in some cluster machines, you must disable it in all cluster machines.



### IMPORTANT

If you disable simultaneous multithreading, ensure that your capacity planning accounts for the dramatically decreased machine performance. Your machines must use at least 8 CPUs and 32 GB of RAM if you disable simultaneous multithreading.

- 4** You must set the value of the **replicas** parameter to **0**. This parameter controls the number of workers that the cluster creates and manages for you, which are functions that the cluster does not perform when you use user-provisioned infrastructure. You must manually deploy worker machines for the cluster to use before you finish installing OpenShift Container Platform.
- 7** The number of control plane machines that you add to the cluster. Because the cluster uses this values as the number of etcd endpoints in the cluster, the value must match the number of control plane machines that you deploy.
- 8** The cluster name that you specified in your DNS records.
- 9** The fully-qualified hostname or IP address of the vCenter server.
- 10** The name of the user for accessing the server. This user must have at least the roles and privileges that are required for [static or dynamic persistent volume provisioning](#) in vSphere.
- 11** The password associated with the vSphere user.
- 12** The vSphere datacenter.
- 13** The default vSphere datastore to use.

- 14 Optional parameter: For installer-provisioned infrastructure, the absolute path of an existing folder where the installation program creates the virtual machines, for example,
- 15 Optional parameter: For installer-provisioned infrastructure, the absolute path of an existing resource pool where the installation program creates the virtual machines, for example, `/<datacenter_name>/host/<cluster_name>/Resources/<resource_pool_name>/<optional_nested_resource_pool_name>`. If you do not specify a value, resources are installed in the root of the cluster `/example_datacenter/host/example_cluster/Resources`.
- 16 The vSphere disk provisioning method.
- 17 Whether to enable or disable FIPS mode. By default, FIPS mode is not enabled. If FIPS mode is enabled, the Red Hat Enterprise Linux CoreOS (RHCOS) machines that OpenShift Container Platform runs on bypass the default Kubernetes cryptography suite and use the cryptography modules that are provided with RHCOS instead.

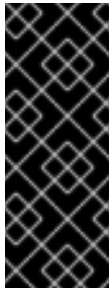

### IMPORTANT

To enable FIPS mode for your cluster, you must run the installation program from a Red Hat Enterprise Linux (RHEL) computer configured to operate in FIPS mode. For more information about configuring FIPS mode on RHEL, see [Installing the system in FIPS mode](#). The use of FIPS validated or Modules In Process cryptographic libraries is only supported on OpenShift Container Platform deployments on the **x86\_64** architecture.

- 18 The pull secret that you obtained from [OpenShift Cluster Manager](#). This pull secret allows you to authenticate with the services that are provided by the included authorities, including Quay.io, which serves the container images for OpenShift Container Platform components.
- 19 The public portion of the default SSH key for the **core** user in Red Hat Enterprise Linux CoreOS (RHCOS).

#### 21.7.11.2. Configuring the cluster-wide proxy during installation

Production environments can deny direct access to the internet and instead have an HTTP or HTTPS proxy available. You can configure a new OpenShift Container Platform cluster to use a proxy by configuring the proxy settings in the **install-config.yaml** file.

#### Prerequisites

- You have an existing **install-config.yaml** file.
- You reviewed the sites that your cluster requires access to and determined whether any of them need to bypass the proxy. By default, all cluster egress traffic is proxied, including calls to hosting cloud provider APIs. You added sites to the **Proxy** object's **spec.noProxy** field to bypass the proxy if necessary.



## NOTE

The **Proxy** object **status.noProxy** field is populated with the values of the **networking.machineNetwork[].cidr**, **networking.clusterNetwork[].cidr**, and **networking.serviceNetwork[]** fields from your installation configuration.

For installations on Amazon Web Services (AWS), Google Cloud Platform (GCP), Microsoft Azure, and Red Hat OpenStack Platform (RHOSP), the **Proxy** object **status.noProxy** field is also populated with the instance metadata endpoint (**169.254.169.254**).

## Procedure

1. Edit your **install-config.yaml** file and add the proxy settings. For example:

```
apiVersion: v1
baseDomain: my.domain.com
proxy:
  httpProxy: http://<username>:<pswd>@<ip>:<port> 1
  httpsProxy: https://<username>:<pswd>@<ip>:<port> 2
  noProxy: example.com 3
  additionalTrustBundle: | 4
    -----BEGIN CERTIFICATE-----
    <MY_TRUSTED_CA_CERT>
    -----END CERTIFICATE-----
  ...
```

- 1 A proxy URL to use for creating HTTP connections outside the cluster. The URL scheme must be **http**.
- 2 A proxy URL to use for creating HTTPS connections outside the cluster.
- 3 A comma-separated list of destination domain names, IP addresses, or other network CIDRs to exclude from proxying. Preface a domain with **.** to match subdomains only. For example, **.y.com** matches **x.y.com**, but not **y.com**. Use **\*** to bypass the proxy for all destinations. You must include vCenter's IP address and the IP range that you use for its machines.
- 4 If provided, the installation program generates a config map that is named **user-ca-bundle** in the **openshift-config** namespace that contains one or more additional CA certificates that are required for proxying HTTPS connections. The Cluster Network Operator then creates a **trusted-ca-bundle** config map that merges these contents with the Red Hat Enterprise Linux CoreOS (RHCOS) trust bundle, and this config map is referenced in the **trustedCA** field of the **Proxy** object. The **additionalTrustBundle** field is required unless the proxy's identity certificate is signed by an authority from the RHCOS trust bundle.



## NOTE

The installation program does not support the proxy **readinessEndpoints** field.

**NOTE**

If the installer times out, restart and then complete the deployment by using the **wait-for** command of the installer. For example:

```
$ ./openshift-install wait-for install-complete --log-level debug
```

2. Save the file and reference it when installing OpenShift Container Platform.

The installation program creates a cluster-wide proxy that is named **cluster** that uses the proxy settings in the provided **install-config.yaml** file. If no proxy settings are provided, a **cluster Proxy** object is still created, but it will have a nil **spec**.

**NOTE**

Only the **Proxy** object named **cluster** is supported, and no additional proxies can be created.

## 21.7.12. Specifying advanced network configuration

You can use advanced network configuration for your cluster network provider to integrate your cluster into your existing network environment. You can specify advanced network configuration only before you install the cluster.

**IMPORTANT**

Customizing your network configuration by modifying the OpenShift Container Platform manifest files created by the installation program is not supported. Applying a manifest file that you create, as in the following procedure, is supported.

### Prerequisites

- You have created the **install-config.yaml** file and completed any modifications to it.

### Procedure

1. Change to the directory that contains the installation program and create the manifests:

```
$ ./openshift-install create manifests --dir <installation_directory> 1
```

- 1** **<installation\_directory>** specifies the name of the directory that contains the **install-config.yaml** file for your cluster.

2. Create a stub manifest file for the advanced network configuration that is named **cluster-network-03-config.yml** in the **<installation\_directory>/manifests/** directory:

```
apiVersion: operator.openshift.io/v1
kind: Network
metadata:
  name: cluster
spec:
```

- Specify the advanced network configuration for your cluster in the **cluster-network-03-config.yml** file, such as in the following examples:

### Specify a different VXLAN port for the OpenShift SDN network provider

```
apiVersion: operator.openshift.io/v1
kind: Network
metadata:
  name: cluster
spec:
  defaultNetwork:
    openshiftSDNConfig:
      vxlanPort: 4800
```

### Enable IPsec for the OVN-Kubernetes network provider

```
apiVersion: operator.openshift.io/v1
kind: Network
metadata:
  name: cluster
spec:
  defaultNetwork:
    ovnKubernetesConfig:
      ipsecConfig: {}
```

- Optional: Back up the **manifests/cluster-network-03-config.yml** file. The installation program consumes the **manifests/** directory when you create the Ignition config files.
- Remove the Kubernetes manifest files that define the control plane machines and compute machineSets:

```
$ rm -f openshift/99_openshift-cluster-api_master-machines-*.yaml openshift/99_openshift-cluster-api_worker-machineset-*.yaml
```

Because you create and manage these resources yourself, you do not have to initialize them.

- You can preserve the MachineSet files to create compute machines by using the machine API, but you must update references to them to match your environment.

## 21.7.13. Cluster Network Operator configuration

The configuration for the cluster network is specified as part of the Cluster Network Operator (CNO) configuration and stored in a custom resource (CR) object that is named **cluster**. The CR specifies the fields for the **Network** API in the **operator.openshift.io** API group.

The CNO configuration inherits the following fields during cluster installation from the **Network** API in the **Network.config.openshift.io** API group and these fields cannot be changed:

### **clusterNetwork**

IP address pools from which pod IP addresses are allocated.

### **serviceNetwork**

IP address pool for services.

### **defaultNetwork.type**



Cluster network provider, such as OpenShift SDN or OVN-Kubernetes.

You can specify the cluster network provider configuration for your cluster by setting the fields for the **defaultNetwork** object in the CNO object named **cluster**.

### 21.7.13.1. Cluster Network Operator configuration object

The fields for the Cluster Network Operator (CNO) are described in the following table:

**Table 21.69. Cluster Network Operator configuration object**

Field	Type	Description
<b>metadata.name</b>	<b>string</b>	The name of the CNO object. This name is always <b>cluster</b> .
<b>spec.clusterNetwork</b>	<b>array</b>	<p>A list specifying the blocks of IP addresses from which pod IP addresses are allocated and the subnet prefix length assigned to each individual node in the cluster. For example:</p> <pre>spec:   clusterNetwork:   - cidr: 10.128.0.0/19     hostPrefix: 23   - cidr: 10.128.32.0/19     hostPrefix: 23</pre> <p>You can customize this field only in the <b>install-config.yaml</b> file before you create the manifests. The value is read-only in the manifest file.</p>
<b>spec.serviceNetwork</b>	<b>array</b>	<p>A block of IP addresses for services. The OpenShift SDN and OVN-Kubernetes Container Network Interface (CNI) network providers support only a single IP address block for the service network. For example:</p> <pre>spec:   serviceNetwork:   - 172.30.0.0/14</pre> <p>You can customize this field only in the <b>install-config.yaml</b> file before you create the manifests. The value is read-only in the manifest file.</p>
<b>spec.defaultNetwork</b>	<b>object</b>	Configures the Container Network Interface (CNI) cluster network provider for the cluster network.
<b>spec.kubeProxyConfig</b>	<b>object</b>	The fields for this object specify the kube-proxy configuration. If you are using the OVN-Kubernetes cluster network provider, the kube-proxy configuration has no effect.

#### defaultNetwork object configuration

The values for the **defaultNetwork** object are defined in the following table:

Table 21.70. `defaultNetwork` object

Field	Type	Description
<code>type</code>	<code>string</code>	<p>Either <b>OpenShiftSDN</b> or <b>OVNKubernetes</b>. The cluster network provider is selected during installation. This value cannot be changed after cluster installation.</p> <div style="display: flex; align-items: flex-start;">  <div> <p><b>NOTE</b></p> <p>OpenShift Container Platform uses the OpenShift SDN Container Network Interface (CNI) cluster network provider by default.</p> </div> </div>
<code>openshiftSDNConfig</code>	<code>object</code>	This object is only valid for the OpenShift SDN cluster network provider.
<code>ovnKubernetesConfig</code>	<code>object</code>	This object is only valid for the OVN-Kubernetes cluster network provider.

#### Configuration for the OpenShift SDN CNI cluster network provider

The following table describes the configuration fields for the OpenShift SDN Container Network Interface (CNI) cluster network provider.

Table 21.71. `openshiftSDNConfig` object

Field	Type	Description
<code>mode</code>	<code>string</code>	<p>Configures the network isolation mode for OpenShift SDN. The default value is <b>NetworkPolicy</b>.</p> <p>The values <b>Multitenant</b> and <b>Subnet</b> are available for backwards compatibility with OpenShift Container Platform 3.x but are not recommended. This value cannot be changed after cluster installation.</p>

Field	Type	Description
<b>mtu</b>	<b>integer</b>	<p>The maximum transmission unit (MTU) for the VXLAN overlay network. This is detected automatically based on the MTU of the primary network interface. You do not normally need to override the detected MTU.</p> <p>If the auto-detected value is not what you expect it to be, confirm that the MTU on the primary network interface on your nodes is correct. You cannot use this option to change the MTU value of the primary network interface on the nodes.</p> <p>If your cluster requires different MTU values for different nodes, you must set this value to <b>50</b> less than the lowest MTU value in your cluster. For example, if some nodes in your cluster have an MTU of <b>9001</b>, and some have an MTU of <b>1500</b>, you must set this value to <b>1450</b>.</p> <p>This value cannot be changed after cluster installation.</p>
<b>vxlanPort</b>	<b>integer</b>	<p>The port to use for all VXLAN packets. The default value is <b>4789</b>. This value cannot be changed after cluster installation.</p> <p>If you are running in a virtualized environment with existing nodes that are part of another VXLAN network, then you might be required to change this. For example, when running an OpenShift SDN overlay on top of VMware NSX-T, you must select an alternate port for the VXLAN, because both SDNs use the same default VXLAN port number.</p> <p>On Amazon Web Services (AWS), you can select an alternate port for the VXLAN between port <b>9000</b> and port <b>9999</b>.</p>

### Example OpenShift SDN configuration

```
defaultNetwork:
  type: OpenShiftSDN
  openshiftSDNConfig:
    mode: NetworkPolicy
    mtu: 1450
    vxlanPort: 4789
```

### Configuration for the OVN-Kubernetes CNI cluster network provider

The following table describes the configuration fields for the OVN-Kubernetes CNI cluster network provider.

Table 21.72. `ovnKubernetesConfig` object

Field	Type	Description
-------	------	-------------

Field	Type	Description
<b>mtu</b>	<b>integer</b>	<p>The maximum transmission unit (MTU) for the Geneve (Generic Network Virtualization Encapsulation) overlay network. This is detected automatically based on the MTU of the primary network interface. You do not normally need to override the detected MTU.</p> <p>If the auto-detected value is not what you expect it to be, confirm that the MTU on the primary network interface on your nodes is correct. You cannot use this option to change the MTU value of the primary network interface on the nodes.</p> <p>If your cluster requires different MTU values for different nodes, you must set this value to <b>100</b> less than the lowest MTU value in your cluster. For example, if some nodes in your cluster have an MTU of <b>9001</b>, and some have an MTU of <b>1500</b>, you must set this value to <b>1400</b>.</p>
<b>genevePort</b>	<b>integer</b>	The port to use for all Geneve packets. The default value is <b>6081</b> . This value cannot be changed after cluster installation.
<b>ipsecConfig</b>	<b>object</b>	Specify an empty object to enable IPsec encryption. This value cannot be changed after cluster installation.
<b>policyAuditConfig</b>	<b>object</b>	Specify a configuration object for customizing network policy audit logging. If unset, the defaults audit log settings are used.
<b>gatewayConfig</b>	<b>object</b>	<p>Optional: Specify a configuration object for customizing how egress traffic is sent to the node gateway.</p> <div style="display: flex; align-items: flex-start;"> <div style="flex: 1;">  </div> <div style="flex: 2;"> <p><b>NOTE</b></p> <p>While migrating egress traffic, you can expect some disruption to workloads and service traffic until the Cluster Network Operator (CNO) successfully rolls out the changes.</p> </div> </div>

Table 21.73. **policyAuditConfig** object

Field	Type	Description
<b>rateLimit</b>	integer	The maximum number of messages to generate every second per node. The default value is <b>20</b> messages per second.
<b>maxFileSize</b>	integer	The maximum size for the audit log in bytes. The default value is <b>50000000</b> or 50 MB.

Field	Type	Description
<b>destination</b>	string	<p>One of the following additional audit log targets:</p> <p><b>libc</b> The libc <b>syslog()</b> function of the journald process on the host.</p> <p><b>udp:&lt;host&gt;:&lt;port&gt;</b> A syslog server. Replace <b>&lt;host&gt;:&lt;port&gt;</b> with the host and port of the syslog server.</p> <p><b>unix:&lt;file&gt;</b> A Unix Domain Socket file specified by <b>&lt;file&gt;</b>.</p> <p><b>null</b> Do not send the audit logs to any additional target.</p>
<b>syslogFacility</b>	string	The syslog facility, such as <b>kern</b> , as defined by RFC5424. The default value is <b>local0</b> .

Table 21.74. gatewayConfig object

Field	Type	Description
<b>routingViaHost</b>	<b>boolean</b>	<p>Set this field to <b>true</b> to send egress traffic from pods to the host networking stack. For highly-specialized installations and applications that rely on manually configured routes in the kernel routing table, you might want to route egress traffic to the host networking stack. By default, egress traffic is processed in OVN to exit the cluster and is not affected by specialized routes in the kernel routing table. The default value is <b>false</b>.</p> <p>This field has an interaction with the Open vSwitch hardware offloading feature. If you set this field to <b>true</b>, you do not receive the performance benefits of the offloading because egress traffic is processed by the host networking stack.</p>

### Example OVN-Kubernetes configuration with IPsec enabled

```
defaultNetwork:
  type: OVNKubernetes
  ovnKubernetesConfig:
    mtu: 1400
    genevePort: 6081
    ipsecConfig: {}
```

### kubeProxyConfig object configuration

The values for the **kubeProxyConfig** object are defined in the following table:

Table 21.75. kubeProxyConfig object

Field	Type	Description
<b>iptablesSyncPeriod</b>	<b>string</b>	<p>The refresh period for <b>iptables</b> rules. The default value is <b>30s</b>. Valid suffixes include <b>s</b>, <b>m</b>, and <b>h</b> and are described in the <a href="#">Go time package</a> documentation.</p> <div style="display: flex; align-items: flex-start;">  <div> <p><b>NOTE</b></p> <p>Because of performance improvements introduced in OpenShift Container Platform 4.3 and greater, adjusting the <b>iptablesSyncPeriod</b> parameter is no longer necessary.</p> </div> </div>
<b>proxyArguments.iptables-min-sync-period</b>	<b>array</b>	<p>The minimum duration before refreshing <b>iptables</b> rules. This field ensures that the refresh does not happen too frequently. Valid suffixes include <b>s</b>, <b>m</b>, and <b>h</b> and are described in the <a href="#">Go time package</a>. The default value is:</p> <pre>kubeProxyConfig:   proxyArguments:     iptables-min-sync-period:       - 0s</pre>

### 21.7.14. Creating the Ignition config files

Because you must manually start the cluster machines, you must generate the Ignition config files that the cluster needs to make its machines.



#### IMPORTANT

- The Ignition config files that the installation program generates contain certificates that expire after 24 hours, which are then renewed at that time. If the cluster is shut down before renewing the certificates and the cluster is later restarted after the 24 hours have elapsed, the cluster automatically recovers the expired certificates. The exception is that you must manually approve the pending **node-bootstrapper** certificate signing requests (CSRs) to recover kubelet certificates. See the documentation for *Recovering from expired control plane certificates* for more information.
- It is recommended that you use Ignition config files within 12 hours after they are generated because the 24-hour certificate rotates from 16 to 22 hours after the cluster is installed. By using the Ignition config files within 12 hours, you can avoid installation failure if the certificate update runs during installation.

#### Prerequisites

- Obtain the OpenShift Container Platform installation program and the pull secret for your cluster. For a restricted network installation, these files are on your mirror host.

## Procedure

- Obtain the Ignition config files:

```
$ ./openshift-install create ignition-configs --dir <installation_directory> 1
```

- 1 For **<installation\_directory>**, specify the directory name to store the files that the installation program creates.

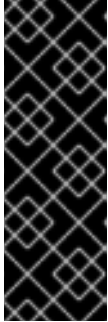

### IMPORTANT

If you created an **install-config.yaml** file, specify the directory that contains it. Otherwise, specify an empty directory. Some installation assets, like bootstrap X.509 certificates have short expiration intervals, so you must not reuse an installation directory. If you want to reuse individual files from another cluster installation, you can copy them into your directory. However, the file names for the installation assets might change between releases. Use caution when copying installation files from an earlier OpenShift Container Platform version.

The following files are generated in the directory:

```
.
├── auth
│   ├── kubeadmin-password
│   └── kubeconfig
├── bootstrap.ign
├── master.ign
├── metadata.json
└── worker.ign
```

## 21.7.15. Extracting the infrastructure name

The Ignition config files contain a unique cluster identifier that you can use to uniquely identify your cluster in VMware Cloud on AWS. If you plan to use the cluster identifier as the name of your virtual machine folder, you must extract it.

### Prerequisites

- You obtained the OpenShift Container Platform installation program and the pull secret for your cluster.
- You generated the Ignition config files for your cluster.
- You installed the **jq** package.

## Procedure

- To extract and view the infrastructure name from the Ignition config file metadata, run the following command:

```
$ jq -r .infraID <installation_directory>/metadata.json 1
```

- 1 For **<installation\_directory>**, specify the path to the directory that you stored the installation files in.

### Example output

```
openshift-vw9j6 1
```

- 1 The output of this command is your cluster name and a random string.

## 21.7.16. Installing RHCOS and starting the OpenShift Container Platform bootstrap process

To install OpenShift Container Platform on user-provisioned infrastructure on VMware vSphere, you must install Red Hat Enterprise Linux CoreOS (RHCOS) on vSphere hosts. When you install RHCOS, you must provide the Ignition config file that was generated by the OpenShift Container Platform installation program for the type of machine you are installing. If you have configured suitable networking, DNS, and load balancing infrastructure, the OpenShift Container Platform bootstrap process begins automatically after the RHCOS machines have rebooted.

### Prerequisites

- You have obtained the Ignition config files for your cluster.
- You have access to an HTTP server that you can access from your computer and that the machines that you create can access.
- You have created a [vSphere cluster](#).

### Procedure

1. Upload the bootstrap Ignition config file, which is named **<installation\_directory>/bootstrap.ign**, that the installation program created to your HTTP server. Note the URL of this file.
2. Save the following secondary Ignition config file for your bootstrap node to your computer as **<installation\_directory>/merge-bootstrap.ign**:

```
{
  "ignition": {
    "config": {
      "merge": [
        {
          "source": "<bootstrap_ignition_config_url>", 1
          "verification": {}
        }
      ]
    },
    "timeouts": {},
    "version": "3.2.0"
  },
  "networkd": {},
  "passwd": {},
```



```
"storage": {},
"systemd": {}
}
```

- 1 Specify the URL of the bootstrap Ignition config file that you hosted.

When you create the virtual machine (VM) for the bootstrap machine, you use this Ignition config file.

3. Locate the following Ignition config files that the installation program created:

- **<installation\_directory>/master.ign**
- **<installation\_directory>/worker.ign**
- **<installation\_directory>/merge-bootstrap.ign**

4. Convert the Ignition config files to Base64 encoding. Later in this procedure, you must add these files to the extra configuration parameter **guestinfo.ignition.config.data** in your VM. For example, if you use a Linux operating system, you can use the **base64** command to encode the files.

```
$ base64 -w0 <installation_directory>/master.ign > <installation_directory>/master.64
```

```
$ base64 -w0 <installation_directory>/worker.ign > <installation_directory>/worker.64
```

```
$ base64 -w0 <installation_directory>/merge-bootstrap.ign > <installation_directory>/merge-bootstrap.64
```

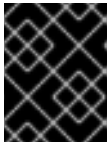

### IMPORTANT

If you plan to add more compute machines to your cluster after you finish installation, do not delete these files.

5. Obtain the RHCOS OVA image. Images are available from the [RHCOS image mirror](#) page.

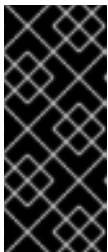

### IMPORTANT

The RHCOS images might not change with every release of OpenShift Container Platform. You must download an image with the highest version that is less than or equal to the OpenShift Container Platform version that you install. Use the image version that matches your OpenShift Container Platform version if it is available.

The filename contains the OpenShift Container Platform version number in the format **rhcos-vmware.<architecture>.ova**.

6. In the vSphere Client, create a folder in your datacenter to store your VMs.
  - a. Click the **VMs and Templates** view.
  - b. Right-click the name of your datacenter.

- c. Click **New Folder → New VM and Template Folder**.
  - d. In the window that is displayed, enter the folder name. If you did not specify an existing folder in the **install-config.yaml** file, then create a folder with the same name as the infrastructure ID. You use this folder name so vCenter dynamically provisions storage in the appropriate location for its Workspace configuration.
7. In the vSphere Client, create a template for the OVA image and then clone the template as needed.



#### NOTE

In the following steps, you create a template and then clone the template for all of your cluster machines. You then provide the location for the Ignition config file for that cloned machine type when you provision the VMs.

- a. From the **Hosts and Clusters** tab, right-click your cluster name and select **Deploy OVF Template**.
- b. On the **Select an OVF** tab, specify the name of the RHCOS OVA file that you downloaded.
- c. On the **Select a name and folder** tab, set a **Virtual machine name** for your template, such as **Template-RHCOS**. Click the name of your vSphere cluster and select the folder you created in the previous step.
- d. On the **Select a compute resource** tab, click the name of your vSphere cluster.
- e. On the **Select storage** tab, configure the storage options for your VM.
  - Select **Thin Provision** or **Thick Provision**, based on your storage preferences.
  - Select the datastore that you specified in your **install-config.yaml** file.
- f. On the **Select network** tab, specify the network that you configured for the cluster, if available.
- g. When creating the OVF template, do not specify values on the **Customize template** tab or configure the template any further.



#### IMPORTANT

Do not start the original VM template. The VM template must remain off and must be cloned for new RHCOS machines. Starting the VM template configures the VM template as a VM on the platform, which prevents it from being used as a template that machine sets can apply configurations to.

8. Optional: Update the configured virtual hardware version in the VM template, if necessary. Follow [Upgrading a virtual machine to the latest hardware version](#) in the VMware documentation for more information.

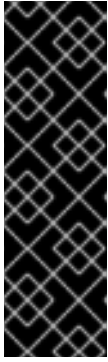

## IMPORTANT

It is recommended that you update the hardware version of the VM template to version 15 before creating VMs from it, if necessary. Using hardware version 13 for your cluster nodes running on vSphere is now deprecated. If your imported template defaults to hardware version 13, you must ensure that your ESXi host is on 6.7U3 or later before upgrading the VM template to hardware version 15. If your vSphere version is less than 6.7U3, you can skip this upgrade step; however, a future version of OpenShift Container Platform is scheduled to remove support for hardware version 13 and vSphere versions less than 6.7U3.

9. After the template deploys, deploy a VM for a machine in the cluster.
  - a. Right-click the template name and click **Clone → Clone to Virtual Machine**
  - b. On the **Select a name and folder** tab, specify a name for the VM. You might include the machine type in the name, such as **control-plane-0** or **compute-1**.



## NOTE

Ensure that all virtual machine names across a vSphere installation are unique.

- c. On the **Select a name and folder** tab, select the name of the folder that you created for the cluster.
- d. On the **Select a compute resource** tab, select the name of a host in your datacenter.
- e. On the **Select clone options**, select **Customize this virtual machine's hardware**
- f. Optional: On the **Customize hardware** tab, click **VM Options → Advanced**.

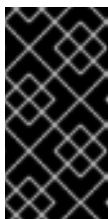

## IMPORTANT

The following configuration suggestions are for example purposes only. As a cluster administrator, you must configure resources according to the resource demands placed on your cluster. To best manage cluster resources, consider creating a resource pool from the cluster's root resource pool.

- Override default DHCP networking in vSphere. To enable static IP networking:
  - Set your static IP configuration:

```
$ export IPCFG="ip=<ip>::<gateway>:<netmask>:<hostname>:<iface>:none
nameserver=svr1 [nameserver=svr2 [nameserver=svr3 [...]]]"
```

### Example command

```
$ export IPCFG="ip=192.168.100.101::192.168.100.254:255.255.255.0:::none
nameserver=8.8.8.8"
```

- Click **Edit Configuration**, and on the **Configuration Parameters** window, search the list of available parameters for steal clock accounting (**stealclock.enable**). Set the parameter to the value of **TRUE**. Enabling steal clock accounting can help with

troubleshooting cluster issues.

- Click **Add Configuration Params**. Define the following parameter names and values:
  - **disk.EnableUUID**: Specify **TRUE**.
  - **stealclock.enable**: If this parameter was not defined, add it and specify **TRUE**.
  - Create a child resource pool from the cluster's root resource pool. Perform resource allocation in this child resource pool.
- g. In the **Virtual Hardware** panel of the **Customize hardware** tab, modify the specified values as required. Ensure that the amount of RAM, CPU, and disk storage meets the minimum requirements for the machine type.
- h. Complete the configuration and power on the VM.
- i. Check the console output to verify that Ignition ran.

### Example command

```
Ignition: ran on 2022/03/14 14:48:33 UTC (this boot)
Ignition: user-provided config was applied
```

10. Create the rest of the machines for your cluster by following the preceding steps for each machine.



### IMPORTANT

You must create the bootstrap and control plane machines at this time. Because some pods are deployed on compute machines by default, also create at least two compute machines before you install the cluster.

## 21.7.17. Adding more compute machines to a cluster in vSphere

You can add more compute machines to a user-provisioned OpenShift Container Platform cluster on VMware vSphere.

### Prerequisites

- Obtain the base64-encoded Ignition file for your compute machines.
- You have access to the vSphere template that you created for your cluster.

### Procedure

1. After the template deploys, deploy a VM for a machine in the cluster.
  - a. Right-click the template's name and click **Clone** → **Clone to Virtual Machine**
  - b. On the **Select a name and folder** tab, specify a name for the VM. You might include the machine type in the name, such as **compute-1**.

**NOTE**

Ensure that all virtual machine names across a vSphere installation are unique.

- c. On the **Select a name and folder** tab, select the name of the folder that you created for the cluster.
  - d. On the **Select a compute resource** tab, select the name of a host in your datacenter.
  - e. On the **Select clone options**, select **Customize this virtual machine's hardware**.
  - f. On the **Customize hardware** tab, click **VM Options → Advanced**.
    - Click **Edit Configuration**, and on the **Configuration Parameters** window, click **Add Configuration Params**. Define the following parameter names and values:
      - **guestinfo.ignition.config.data**: Paste the contents of the base64-encoded compute Ignition config file for this machine type.
      - **guestinfo.ignition.config.data.encoding**: Specify **base64**.
      - **disk.EnableUUID**: Specify **TRUE**.
  - g. In the **Virtual Hardware** panel of the **Customize hardware** tab, modify the specified values as required. Ensure that the amount of RAM, CPU, and disk storage meets the minimum requirements for the machine type. Also, make sure to select the correct network under **Add network adapter** if there are multiple networks available.
  - h. Complete the configuration and power on the VM.
2. Continue to create more compute machines for your cluster.

### 21.7.18. Disk partitioning

In most cases, data partitions are originally created by installing RHCOS, rather than by installing another operating system. In such cases, the OpenShift Container Platform installer should be allowed to configure your disk partitions.

However, there are two cases where you might want to intervene to override the default partitioning when installing an OpenShift Container Platform node:

- **Create separate partitions:** For greenfield installations on an empty disk, you might want to add separate storage to a partition. This is officially supported for making **/var** or a subdirectory of **/var**, such as **/var/lib/etcd**, a separate partition, but not both.

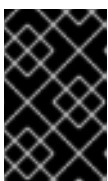
**IMPORTANT**

For disk sizes larger than 100GB, and especially disk sizes larger than 1TB, create a separate **/var** partition. See "Creating a separate **/var** partition" and this [Red Hat Knowledgebase article](#) for more information.

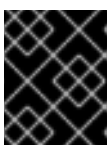
**IMPORTANT**

Kubernetes supports only two file system partitions. If you add more than one partition to the original configuration, Kubernetes cannot monitor all of them.

- **Retain existing partitions:** For a brownfield installation where you are reinstalling OpenShift Container Platform on an existing node and want to retain data partitions installed from your previous operating system, there are both boot arguments and options to **coreos-installer** that allow you to retain existing data partitions.

### Creating a separate `/var` partition

In general, disk partitioning for OpenShift Container Platform should be left to the installer. However, there are cases where you might want to create separate partitions in a part of the filesystem that you expect to grow.

OpenShift Container Platform supports the addition of a single partition to attach storage to either the `/var` partition or a subdirectory of `/var`. For example:

- **`/var/lib/containers`:** Holds container-related content that can grow as more images and containers are added to a system.
- **`/var/lib/etcd`:** Holds data that you might want to keep separate for purposes such as performance optimization of etcd storage.
- **`/var`:** Holds data that you might want to keep separate for purposes such as auditing.

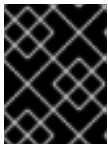

#### IMPORTANT

For disk sizes larger than 100GB, and especially larger than 1TB, create a separate `/var` partition.

Storing the contents of a `/var` directory separately makes it easier to grow storage for those areas as needed and reinstall OpenShift Container Platform at a later date and keep that data intact. With this method, you will not have to pull all your containers again, nor will you have to copy massive log files when you update systems.

Because `/var` must be in place before a fresh installation of Red Hat Enterprise Linux CoreOS (RHCOS), the following procedure sets up the separate `/var` partition by creating a machine config manifest that is inserted during the **openshift-install** preparation phases of an OpenShift Container Platform installation.

### Procedure

1. Create a directory to hold the OpenShift Container Platform installation files:

```
$ mkdir $HOME/clusterconfig
```

2. Run **openshift-install** to create a set of files in the **manifest** and **openshift** subdirectories. Answer the system questions as you are prompted:

```
$ openshift-install create manifests --dir $HOME/clusterconfig
? SSH Public Key ...
$ ls $HOME/clusterconfig/openshift/
99_kubeadmin-password-secret.yaml
99_openshift-cluster-api_master-machines-0.yaml
99_openshift-cluster-api_master-machines-1.yaml
99_openshift-cluster-api_master-machines-2.yaml
...
```

3. Create a Butane config that configures the additional partition. For example, name the file **\$HOME/clusterconfig/98-var-partition.bu**, change the disk device name to the name of the storage device on the **worker** systems, and set the storage size as appropriate. This example places the **/var** directory on a separate partition:

```
variant: openshift
version: 4.10.0
metadata:
  labels:
    machineconfiguration.openshift.io/role: worker
  name: 98-var-partition
storage:
  disks:
    - device: /dev/<device_name> 1
  partitions:
    - label: var
      start_mib: <partition_start_offset> 2
      size_mib: <partition_size> 3
  filesystems:
    - device: /dev/disk/by-partlabel/var
      path: /var
      format: xfs
      mount_options: [defaults, prjquota] 4
      with_mount_unit: true
```

- 1 The storage device name of the disk that you want to partition.
- 2 When adding a data partition to the boot disk, a minimum value of 25000 mebibytes is recommended. The root file system is automatically resized to fill all available space up to the specified offset. If no value is specified, or if the specified value is smaller than the recommended minimum, the resulting root file system will be too small, and future reinstalls of RHCOS might overwrite the beginning of the data partition.
- 3 The size of the data partition in mebibytes.
- 4 The **prjquota** mount option must be enabled for filesystems used for container storage.

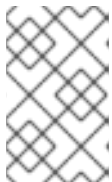

#### NOTE

When creating a separate **/var** partition, you cannot use different instance types for worker nodes, if the different instance types do not have the same device name.

4. Create a manifest from the Butane config and save it to the **clusterconfig/openshift** directory. For example, run the following command:

```
$ butane $HOME/clusterconfig/98-var-partition.bu -o $HOME/clusterconfig/openshift/98-var-partition.yaml
```

5. Run **openshift-install** again to create Ignition configs from a set of files in the **manifest** and **openshift** subdirectories:

```
$ openshift-install create ignition-configs --dir $HOME/clusterconfig
$ ls $HOME/clusterconfig/
auth bootstrap.ign master.ign metadata.json worker.ign
```

Now you can use the Ignition config files as input to the vSphere installation procedures to install Red Hat Enterprise Linux CoreOS (RHCOS) systems.

### 21.7.19. Updating the bootloader using bootupd

To update the bootloader by using **bootupd**, you must either install **bootupd** on RHCOS machines manually or provide a machine config with the enabled **systemd** unit. Unlike **grubby** or other bootloader tools, **bootupd** does not manage kernel space configuration such as passing kernel arguments.

After you have installed **bootupd**, you can manage it remotely from the OpenShift Container Platform cluster.



#### NOTE

It is recommended that you use **bootupd** only on bare metal or virtualized hypervisor installations, such as for protection against the BootHole vulnerability.

#### Manual install method

You can manually install **bootupd** by using the **bootctl** command-line tool.

1. Inspect the system status:

```
# bootupctl status
```

#### Example output for x86\_64

```
Component EFI
Installed: grub2-efi-x64-1:2.04-31.fc33.x86_64,shim-x64-15-8.x86_64
Update: At latest version
```

#### Example output for aarch64

```
Component EFI
Installed: grub2-efi-aa64-1:2.02-99.el8_4.1.aarch64,shim-aa64-15.4-2.el8_1.aarch64
Update: At latest version
```

2. RHCOS images created without **bootupd** installed on them require an explicit adoption phase. If the system status is **Adoptable**, perform the adoption:

```
# bootupctl adopt-and-update
```

#### Example output

```
Updated: grub2-efi-x64-1:2.04-31.fc33.x86_64,shim-x64-15-8.x86_64
```

3. If an update is available, apply the update so that the changes take effect on the next reboot:



```
# bootupctl update
```

### Example output

```
Updated: grub2-efi-x64-1:2.04-31.fc33.x86_64,shim-x64-15-8.x86_64
```

## Machine config method

Another way to enable **bootupd** is by providing a machine config.

- Provide a machine config file with the enabled **systemd** unit, as shown in the following example:

### Example output

```
variant: rhcos
version: 1.1.0
systemd:
  units:
    - name: custom-bootupd-auto.service
      enabled: true
      contents: |
        [Unit]
        Description=Bootupd automatic update

        [Service]
        ExecStart=/usr/bin/bootupctl update
        RemainAfterExit=yes

        [Install]
        WantedBy=multi-user.target
```

## 21.7.20. Waiting for the bootstrap process to complete

The OpenShift Container Platform bootstrap process begins after the cluster nodes first boot into the persistent RHCOS environment that has been installed to disk. The configuration information provided through the Ignition config files is used to initialize the bootstrap process and install OpenShift Container Platform on the machines. You must wait for the bootstrap process to complete.

### Prerequisites

- You have created the Ignition config files for your cluster.
- You have configured suitable network, DNS and load balancing infrastructure.
- You have obtained the installation program and generated the Ignition config files for your cluster.
- You installed RHCOS on your cluster machines and provided the Ignition config files that the OpenShift Container Platform installation program generated.
- Your machines have direct internet access or have an HTTP or HTTPS proxy available.

### Procedure

1. Monitor the bootstrap process:

```
$ ./openshift-install --dir <installation_directory> wait-for bootstrap-complete \ 1
--log-level=info 2
```

1 For **<installation\_directory>**, specify the path to the directory that you stored the installation files in.

2 To view different installation details, specify **warn**, **debug**, or **error** instead of **info**.

### Example output

```
INFO Waiting up to 30m0s for the Kubernetes API at https://api.test.example.com:6443...
INFO API v1.23.0 up
INFO Waiting up to 30m0s for bootstrapping to complete...
INFO It is now safe to remove the bootstrap resources
```

The command succeeds when the Kubernetes API server signals that it has been bootstrapped on the control plane machines.

2. After bootstrap process is complete, remove the bootstrap machine from the load balancer.



### IMPORTANT

You must remove the bootstrap machine from the load balancer at this point. You can also remove or reformat the bootstrap machine itself.

## 21.7.21. Logging in to the cluster by using the CLI

You can log in to your cluster as a default system user by exporting the cluster **kubeconfig** file. The **kubeconfig** file contains information about the cluster that is used by the CLI to connect a client to the correct cluster and API server. The file is specific to a cluster and is created during OpenShift Container Platform installation.

### Prerequisites

- You deployed an OpenShift Container Platform cluster.
- You installed the **oc** CLI.

### Procedure

1. Export the **kubeadmin** credentials:

```
$ export KUBECONFIG=<installation_directory>/auth/kubeconfig 1
```

1 For **<installation\_directory>**, specify the path to the directory that you stored the installation files in.

2. Verify you can run **oc** commands successfully using the exported configuration:

```
$ oc whoami
```

-

**Example output**

```
system:admin
```

**21.7.22. Approving the certificate signing requests for your machines**

When you add machines to a cluster, two pending certificate signing requests (CSRs) are generated for each machine that you added. You must confirm that these CSRs are approved or, if necessary, approve them yourself. The client requests must be approved first, followed by the server requests.

**Prerequisites**

- You added machines to your cluster.

**Procedure**

1. Confirm that the cluster recognizes the machines:

```
$ oc get nodes
```

**Example output**

```
NAME      STATUS   ROLES    AGE   VERSION
master-0  Ready    master   63m   v1.23.0
master-1  Ready    master   63m   v1.23.0
master-2  Ready    master   64m   v1.23.0
```

The output lists all of the machines that you created.

**NOTE**

The preceding output might not include the compute nodes, also known as worker nodes, until some CSRs are approved.

2. Review the pending CSRs and ensure that you see the client requests with the **Pending** or **Approved** status for each machine that you added to the cluster:

```
$ oc get csr
```

**Example output**

```
NAME      AGE   REQUESTOR                                     CONDITION
csr-8b2br  15m   system:serviceaccount:openshift-machine-config-operator:node-
bootstrapper  Pending
csr-8vnps  15m   system:serviceaccount:openshift-machine-config-operator:node-
bootstrapper  Pending
...
```

In this example, two machines are joining the cluster. You might see more approved CSRs in the list.

- If the CSRs were not approved, after all of the pending CSRs for the machines you added are in **Pending** status, approve the CSRs for your cluster machines:



#### NOTE

Because the CSRs rotate automatically, approve your CSRs within an hour of adding the machines to the cluster. If you do not approve them within an hour, the certificates will rotate, and more than two certificates will be present for each node. You must approve all of these certificates. After the client CSR is approved, the Kubelet creates a secondary CSR for the serving certificate, which requires manual approval. Then, subsequent serving certificate renewal requests are automatically approved by the **machine-approver** if the Kubelet requests a new certificate with identical parameters.



#### NOTE

For clusters running on platforms that are not machine API enabled, such as bare metal and other user-provisioned infrastructure, you must implement a method of automatically approving the kubelet serving certificate requests (CSRs). If a request is not approved, then the **oc exec**, **oc rsh**, and **oc logs** commands cannot succeed, because a serving certificate is required when the API server connects to the kubelet. Any operation that contacts the Kubelet endpoint requires this certificate approval to be in place. The method must watch for new CSRs, confirm that the CSR was submitted by the **node-bootstrap** service account in the **system:node** or **system:admin** groups, and confirm the identity of the node.

- To approve them individually, run the following command for each valid CSR:

```
$ oc adm certificate approve <csr_name> 1
```

- 1** **<csr\_name>** is the name of a CSR from the list of current CSRs.

- To approve all pending CSRs, run the following command:

```
$ oc get csr -o go-template='{{range .items}}{{if not .status}}{{.metadata.name}}{"\n"}{{end}}{{end}}' | xargs --no-run-if-empty oc adm certificate approve
```



#### NOTE

Some Operators might not become available until some CSRs are approved.

- Now that your client requests are approved, you must review the server requests for each machine that you added to the cluster:

```
$ oc get csr
```

#### Example output

```
NAME      AGE    REQUESTOR                                     CONDITION
csr-bfd72 5m26s  system:node:ip-10-0-50-126.us-east-2.compute.internal
Pending
```

```
csr-c57lv 5m26s system:node:ip-10-0-95-157.us-east-2.compute.internal
Pending
...
```

- If the remaining CSRs are not approved, and are in the **Pending** status, approve the CSRs for your cluster machines:

- To approve them individually, run the following command for each valid CSR:

```
$ oc adm certificate approve <csr_name> 1
```

- 1** `<csr_name>` is the name of a CSR from the list of current CSRs.

- To approve all pending CSRs, run the following command:

```
$ oc get csr -o go-template='{{range .items}}{{if not .status}}{{.metadata.name}}{"\n"}
{{end}}{{end}}' | xargs oc adm certificate approve
```

- After all client and server CSRs have been approved, the machines have the **Ready** status. Verify this by running the following command:

```
$ oc get nodes
```

### Example output

```
NAME      STATUS  ROLES  AGE  VERSION
master-0  Ready   master 73m  v1.23.0
master-1  Ready   master 73m  v1.23.0
master-2  Ready   master 74m  v1.23.0
worker-0  Ready   worker 11m  v1.23.0
worker-1  Ready   worker 11m  v1.23.0
```

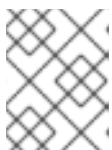

### NOTE

It can take a few minutes after approval of the server CSRs for the machines to transition to the **Ready** status.

### Additional information

- For more information on CSRs, see [Certificate Signing Requests](#).

## 21.7.23. Initial Operator configuration

After the control plane initializes, you must immediately configure some Operators so that they all become available.

### Prerequisites

- Your control plane has initialized.

### Procedure

1. Watch the cluster components come online:

```
$ watch -n5 oc get clusteroperators
```

### Example output

NAME	VERSION	AVAILABLE	PROGRESSING	DEGRADED	SINCE
authentication	4.10.0	True	False	False	19m
baremetal	4.10.0	True	False	False	37m
cloud-credential	4.10.0	True	False	False	40m
cluster-autoscaler	4.10.0	True	False	False	37m
config-operator	4.10.0	True	False	False	38m
console	4.10.0	True	False	False	26m
csi-snapshot-controller	4.10.0	True	False	False	37m
dns	4.10.0	True	False	False	37m
etcd	4.10.0	True	False	False	36m
image-registry	4.10.0	True	False	False	31m
ingress	4.10.0	True	False	False	30m
insights	4.10.0	True	False	False	31m
kube-apiserver	4.10.0	True	False	False	26m
kube-controller-manager	4.10.0	True	False	False	36m
kube-scheduler	4.10.0	True	False	False	36m
kube-storage-version-migrator	4.10.0	True	False	False	37m
machine-api	4.10.0	True	False	False	29m
machine-approver	4.10.0	True	False	False	37m
machine-config	4.10.0	True	False	False	36m
marketplace	4.10.0	True	False	False	37m
monitoring	4.10.0	True	False	False	29m
network	4.10.0	True	False	False	38m
node-tuning	4.10.0	True	False	False	37m
openshift-apiserver	4.10.0	True	False	False	32m
openshift-controller-manager	4.10.0	True	False	False	30m
openshift-samples	4.10.0	True	False	False	32m
operator-lifecycle-manager	4.10.0	True	False	False	37m
operator-lifecycle-manager-catalog	4.10.0	True	False	False	37m
operator-lifecycle-manager-packageserver	4.10.0	True	False	False	32m
service-ca	4.10.0	True	False	False	38m
storage	4.10.0	True	False	False	37m

2. Configure the Operators that are not available.

#### 21.7.23.1. Image registry removed during installation

On platforms that do not provide shareable object storage, the OpenShift Image Registry Operator bootstraps itself as **Removed**. This allows **openshift-installer** to complete installations on these platform types.

After installation, you must edit the Image Registry Operator configuration to switch the **managementState** from **Removed** to **Managed**.

#### 21.7.23.2. Image registry storage configuration

The Image Registry Operator is not initially available for platforms that do not provide default storage. After installation, you must configure your registry to use storage so that the Registry Operator is made available.

Instructions are shown for configuring a persistent volume, which is required for production clusters. Where applicable, instructions are shown for configuring an empty directory as the storage location, which is available for only non-production clusters.

Additional instructions are provided for allowing the image registry to use block storage types by using the **Recreate** rollout strategy during upgrades.

### 21.7.23.2.1. Configuring block registry storage for VMware vSphere

To allow the image registry to use block storage types such as vSphere Virtual Machine Disk (VMDK) during upgrades as a cluster administrator, you can use the **Recreate** rollout strategy.



#### IMPORTANT

Block storage volumes are supported but not recommended for use with image registry on production clusters. An installation where the registry is configured on block storage is not highly available because the registry cannot have more than one replica.

#### Procedure

1. To set the image registry storage as a block storage type, patch the registry so that it uses the **Recreate** rollout strategy and runs with only **1** replica:

```
$ oc patch config.imageregistry.operator.openshift.io/cluster --type=merge -p '{"spec": {"rolloutStrategy": "Recreate", "replicas": 1}}'
```

2. Provision the PV for the block storage device, and create a PVC for that volume. The requested block volume uses the ReadWriteOnce (RWO) access mode.
  - a. Create a **pvc.yaml** file with the following contents to define a VMware vSphere **PersistentVolumeClaim** object:

```
kind: PersistentVolumeClaim
apiVersion: v1
metadata:
  name: image-registry-storage 1
  namespace: openshift-image-registry 2
spec:
  accessModes:
  - ReadWriteOnce 3
  resources:
    requests:
      storage: 100Gi 4
```

- 1 A unique name that represents the **PersistentVolumeClaim** object.
- 2 The namespace for the **PersistentVolumeClaim** object, which is **openshift-image-registry**.
- 3 The access mode of the persistent volume claim. With **ReadWriteOnce**, the volume can be mounted with read and write permissions by a single node.

4 The size of the persistent volume claim.

b. Create the **PersistentVolumeClaim** object from the file:

```
$ oc create -f pvc.yaml -n openshift-image-registry
```

3. Edit the registry configuration so that it references the correct PVC:

```
$ oc edit config.imageregistry.operator.openshift.io -o yaml
```

### Example output

```
storage:
  pvc:
    claim: 1
```

1 Creating a custom PVC allows you to leave the **claim** field blank for the default automatic creation of an **image-registry-storage** PVC.

For instructions about configuring registry storage so that it references the correct PVC, see [Configuring the registry for vSphere](#).

## 21.7.24. Completing installation on user-provisioned infrastructure

After you complete the Operator configuration, you can finish installing the cluster on infrastructure that you provide.

### Prerequisites

- Your control plane has initialized.
- You have completed the initial Operator configuration.

### Procedure

1. Confirm that all the cluster components are online with the following command:

```
$ watch -n5 oc get clusteroperators
```

### Example output

NAME	VERSION	AVAILABLE	PROGRESSING	DEGRADED	SINCE
authentication	4.10.0	True	False	False	19m
baremetal	4.10.0	True	False	False	37m
cloud-credential	4.10.0	True	False	False	40m
cluster-autoscaler	4.10.0	True	False	False	37m
config-operator	4.10.0	True	False	False	38m
console	4.10.0	True	False	False	26m
csi-snapshot-controller	4.10.0	True	False	False	37m
dns	4.10.0	True	False	False	37m



etcd	4.10.0	True	False	False	36m
image-registry	4.10.0	True	False	False	31m
ingress	4.10.0	True	False	False	30m
insights	4.10.0	True	False	False	31m
kube-apiserver	4.10.0	True	False	False	26m
kube-controller-manager	4.10.0	True	False	False	36m
kube-scheduler	4.10.0	True	False	False	36m
kube-storage-version-migrator	4.10.0	True	False	False	37m
machine-api	4.10.0	True	False	False	29m
machine-approver	4.10.0	True	False	False	37m
machine-config	4.10.0	True	False	False	36m
marketplace	4.10.0	True	False	False	37m
monitoring	4.10.0	True	False	False	29m
network	4.10.0	True	False	False	38m
node-tuning	4.10.0	True	False	False	37m
openshift-apiserver	4.10.0	True	False	False	32m
openshift-controller-manager	4.10.0	True	False	False	30m
openshift-samples	4.10.0	True	False	False	32m
operator-lifecycle-manager	4.10.0	True	False	False	37m
operator-lifecycle-manager-catalog	4.10.0	True	False	False	37m
operator-lifecycle-manager-packageserver	4.10.0	True	False	False	32m
service-ca	4.10.0	True	False	False	38m
storage	4.10.0	True	False	False	37m

Alternatively, the following command notifies you when all of the clusters are available. It also retrieves and displays credentials:

```
$ ./openshift-install --dir <installation_directory> wait-for install-complete 1
```

- 1** For **<installation\_directory>**, specify the path to the directory that you stored the installation files in.

## Example output

```
INFO Waiting up to 30m0s for the cluster to initialize...
```

The command succeeds when the Cluster Version Operator finishes deploying the OpenShift Container Platform cluster from Kubernetes API server.

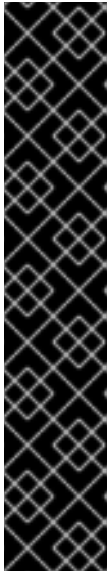

## IMPORTANT

- The Ignition config files that the installation program generates contain certificates that expire after 24 hours, which are then renewed at that time. If the cluster is shut down before renewing the certificates and the cluster is later restarted after the 24 hours have elapsed, the cluster automatically recovers the expired certificates. The exception is that you must manually approve the pending **node-bootstrapper** certificate signing requests (CSRs) to recover kubelet certificates. See the documentation for *Recovering from expired control plane certificates* for more information.
- It is recommended that you use Ignition config files within 12 hours after they are generated because the 24-hour certificate rotates from 16 to 22 hours after the cluster is installed. By using the Ignition config files within 12 hours, you can avoid installation failure if the certificate update runs during installation.

2. Confirm that the Kubernetes API server is communicating with the pods.

- a. To view a list of all pods, use the following command:

```
$ oc get pods --all-namespaces
```

### Example output

```

NAMESPACE           NAME                                     READY  STATUS
RESTARTS  AGE
openshift-apiserver-operator  openshift-apiserver-operator-85cb746d55-zqhs8  1/1
Running   1    9m
openshift-apiserver          apiserver-67b9g                                1/1  Running  0
3m
openshift-apiserver          apiserver-ljcmx                                1/1  Running  0
1m
openshift-apiserver          apiserver-z25h4                                1/1  Running  0
2m
openshift-authentication-operator  authentication-operator-69d5d8bf84-vh2n8      1/1
Running   0    5m
...

```

- b. View the logs for a pod that is listed in the output of the previous command by using the following command:

```
$ oc logs <pod_name> -n <namespace> ❶
```

- ❶ Specify the pod name and namespace, as shown in the output of the previous command.

If the pod logs display, the Kubernetes API server can communicate with the cluster machines.

3. For an installation with Fibre Channel Protocol (FCP), additional steps are required to enable multipathing. Do not enable multipathing during installation. See "Enabling multipathing with kernel arguments on RHCOS" in the *Post-installation machine configuration tasks* documentation for more information.

You can add extra compute machines after the cluster installation is completed by following [Adding compute machines to vSphere](#).

### 21.7.25. Backing up VMware vSphere volumes

OpenShift Container Platform provisions new volumes as independent persistent disks to freely attach and detach the volume on any node in the cluster. As a consequence, it is not possible to back up volumes that use snapshots, or to restore volumes from snapshots. See [Snapshot Limitations](#) for more information.

#### Procedure

To create a backup of persistent volumes:

1. Stop the application that is using the persistent volume.
2. Clone the persistent volume.
3. Restart the application.
4. Create a backup of the cloned volume.
5. Delete the cloned volume.

### 21.7.26. Telemetry access for OpenShift Container Platform

In OpenShift Container Platform 4.10, the Telemetry service, which runs by default to provide metrics about cluster health and the success of updates, requires internet access. If your cluster is connected to the internet, Telemetry runs automatically, and your cluster is registered to [OpenShift Cluster Manager](#).

After you confirm that your [OpenShift Cluster Manager](#) inventory is correct, either maintained automatically by Telemetry or manually by using OpenShift Cluster Manager, [use subscription watch](#) to track your OpenShift Container Platform subscriptions at the account or multi-cluster level.

#### Additional resources

- See [About remote health monitoring](#) for more information about the Telemetry service

### 21.7.27. Next steps

- [Customize your cluster](#).
- If necessary, you can [opt out of remote health reporting](#) .
- [Set up your registry and configure registry storage](#) .
- Optional: [View the events from the vSphere Problem Detector Operator](#) to determine if the cluster has permission or storage configuration issues.

## 21.8. INSTALLING A CLUSTER ON VMC IN A RESTRICTED NETWORK WITH USER-PROVISIONED INFRASTRUCTURE

In OpenShift Container Platform version 4.10, you can install a cluster on VMware vSphere infrastructure that you provision in a restricted network by deploying it to [VMware Cloud \(VMC\) on AWS](#).

Once you configure your VMC environment for OpenShift Container Platform deployment, you use the OpenShift Container Platform installation program from the bastion management host, co-located in the VMC environment. The installation program and control plane automates the process of deploying and managing the resources needed for the OpenShift Container Platform cluster.



#### NOTE

OpenShift Container Platform supports deploying a cluster to a single VMware vCenter only. Deploying a cluster with machines/machine sets on multiple vCenters is not supported.

### 21.8.1. Setting up VMC for vSphere

You can install OpenShift Container Platform on VMware Cloud (VMC) on AWS hosted vSphere clusters to enable applications to be deployed and managed both on-premise and off-premise, across the hybrid cloud.

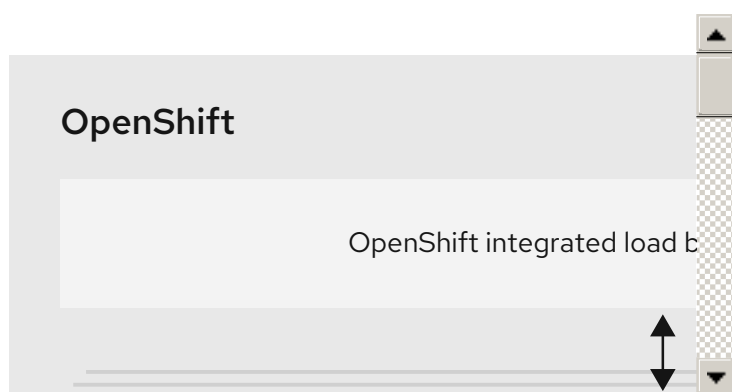

You must configure several options in your VMC environment prior to installing OpenShift Container Platform on VMware vSphere. Ensure your VMC environment has the following prerequisites:

- Create a non-exclusive, DHCP-enabled, NSX-T network segment and subnet. Other virtual machines (VMs) can be hosted on the subnet, but at least eight IP addresses must be available for the OpenShift Container Platform deployment.
- Configure the following firewall rules:
  - An ANY:ANY firewall rule between the installation host and the software-defined data center (SDDC) management network on port 443. This allows you to upload the Red Hat Enterprise Linux CoreOS (RHCOS) OVA during deployment.
  - An HTTPS firewall rule between the OpenShift Container Platform compute network and vCenter. This connection allows OpenShift Container Platform to communicate with vCenter for provisioning and managing nodes, persistent volume claims (PVCs), and other resources.
- You must have the following information to deploy OpenShift Container Platform:
  - The OpenShift Container Platform cluster name, such as **vmc-prod-1**.
  - The base DNS name, such as **companyname.com**.
  - If not using the default, the pod network CIDR and services network CIDR must be identified, which are set by default to **10.128.0.0/14** and **172.30.0.0/16**, respectively. These CIDRs are used for pod-to-pod and pod-to-service communication and are not accessible externally; however, they must not overlap with existing subnets in your organization.

- The following vCenter information:
  - vCenter hostname, username, and password
  - Datacenter name, such as **SDDC-Datacenter**
  - Cluster name, such as **Cluster-1**
  - Network name
  - Datastore name, such as **WorkloadDatastore**



#### NOTE

It is recommended to move your vSphere cluster to the VMC **Compute-ResourcePool** resource pool after your cluster installation is finished.

- A Linux-based host deployed to VMC as a bastion.
  - The bastion host can be Red Hat Enterprise Linux (RHEL) or any another Linux-based host; it must have internet connectivity and the ability to upload an OVA to the ESXi hosts.
  - Download and install the OpenShift CLI tools to the bastion host.
    - The **openshift-install** installation program
    - The OpenShift CLI (**oc**) tool



#### NOTE

You cannot use the VMware NSX Container Plugin for Kubernetes (NCP), and NSX is not used as the OpenShift SDN. The version of NSX currently available with VMC is incompatible with the version of NCP certified with OpenShift Container Platform.

However, the NSX DHCP service is used for virtual machine IP management with the full-stack automated OpenShift Container Platform deployment and with nodes provisioned, either manually or automatically, by the Machine API integration with vSphere. Additionally, NSX firewall rules are created to enable access with the OpenShift Container Platform cluster and between the bastion host and the VMC vSphere hosts.

### 21.8.1.1. VMC Sizer tool

VMware Cloud on AWS is built on top of AWS bare metal infrastructure; this is the same bare metal infrastructure which runs AWS native services. When a VMware cloud on AWS software-defined data center (SDDC) is deployed, you consume these physical server nodes and run the VMware ESXi hypervisor in a single tenant fashion. This means the physical infrastructure is not accessible to anyone else using VMC. It is important to consider how many physical hosts you will need to host your virtual infrastructure.

To determine this, VMware provides the [VMC on AWS Sizer](#). With this tool, you can define the resources you intend to host on VMC:

- Types of workloads
- Total number of virtual machines

- Specification information such as:
  - Storage requirements
  - vCPUs
  - vRAM
  - Overcommit ratios

With these details, the sizer tool can generate a report, based on VMware best practices, and recommend your cluster configuration and the number of hosts you will need.

### 21.8.2. vSphere prerequisites

- You reviewed details about the [OpenShift Container Platform installation and update](#) processes.
- You read the documentation on [selecting a cluster installation method and preparing it for users](#).
- You [created a registry on your mirror host](#) and obtain the **imageContentSources** data for your version of OpenShift Container Platform.



#### IMPORTANT

Because the installation media is on the mirror host, you can use that computer to complete all installation steps.

- You provisioned [block registry storage](#). For more information on persistent storage, see [Understanding persistent storage](#).
- If you use a firewall and plan to use the Telemetry service, you [configured the firewall to allow the sites](#) that your cluster requires access to.



#### NOTE

Be sure to also review this site list if you are configuring a proxy.

### 21.8.3. About installations in restricted networks

In OpenShift Container Platform 4.10, you can perform an installation that does not require an active connection to the internet to obtain software components. Restricted network installations can be completed using installer-provisioned infrastructure or user-provisioned infrastructure, depending on the cloud platform to which you are installing the cluster.

If you choose to perform a restricted network installation on a cloud platform, you still require access to its cloud APIs. Some cloud functions, like Amazon Web Service's Route 53 DNS and IAM services, require internet access. Depending on your network, you might require less internet access for an installation on bare metal hardware or on VMware vSphere.

To complete a restricted network installation, you must create a registry that mirrors the contents of the OpenShift image registry and contains the installation media. You can create this registry on a mirror host, which can access both the internet and your closed network, or by using other methods that meet your restrictions.

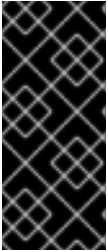

## IMPORTANT

Because of the complexity of the configuration for user-provisioned installations, consider completing a standard user-provisioned infrastructure installation before you attempt a restricted network installation using user-provisioned infrastructure. Completing this test installation might make it easier to isolate and troubleshoot any issues that might arise during your installation in a restricted network.

### 21.8.3.1. Additional limits

Clusters in restricted networks have the following additional limitations and restrictions:

- The **ClusterVersion** status includes an **Unable to retrieve available updates** error.
- By default, you cannot use the contents of the Developer Catalog because you cannot access the required image stream tags.

### 21.8.4. Internet access for OpenShift Container Platform

In OpenShift Container Platform 4.10, you require access to the internet to obtain the images that are necessary to install your cluster.

You must have internet access to:

- Access [OpenShift Cluster Manager](#) to download the installation program and perform subscription management. If the cluster has internet access and you do not disable Telemetry, that service automatically entitles your cluster.
- Access [Quay.io](#) to obtain the packages that are required to install your cluster.
- Obtain the packages that are required to perform cluster updates.

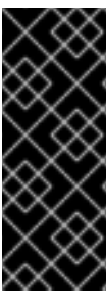

## IMPORTANT

If your cluster cannot have direct internet access, you can perform a restricted network installation on some types of infrastructure that you provision. During that process, you download the required content and use it to populate a mirror registry with the installation packages. With some installation types, the environment that you install your cluster in will not require internet access. Before you update the cluster, you update the content of the mirror registry.

### 21.8.5. VMware vSphere infrastructure requirements

You must install the OpenShift Container Platform cluster on a VMware vSphere version 7 instance that meets the requirements for the components that you use.



## NOTE

OpenShift Container Platform version 4.10 does not support VMware vSphere version 8.0.

You can host the VMware vSphere infrastructure on-premise or on a [VMware Cloud Verified provider](#) that meets the requirements outlined in the following table:

**Table 21.76. Version requirements for vSphere virtual environments**

Virtual environment product	Required version
VM hardware version	15 or later
vSphere ESXi hosts	7
vCenter host	7



### IMPORTANT

Installing a cluster on VMware vSphere version 7.0 Update 1 is now deprecated. These versions are still fully supported, but version 4.10 of OpenShift Container Platform requires vSphere virtual hardware version 15 or later. Hardware version 15 is now the default for vSphere virtual machines in OpenShift Container Platform. To update the hardware version for your vSphere nodes, see the "Updating hardware on nodes running in vSphere" article.

If your vSphere nodes are below hardware version 15 or your VMware vSphere version is earlier than 6.7U3, upgrading from OpenShift Container Platform 4.10 to OpenShift Container Platform 4.11 is not available.

**Table 21.77. Minimum supported vSphere version for VMware components**

Component	Minimum supported versions	Description
Hypervisor	vSphere 7 with HW version 15	This version is the minimum version that Red Hat Enterprise Linux CoreOS (RHCOS) supports. For more information about supported hardware on the latest version of Red Hat Enterprise Linux (RHEL) that is compatible with RHCOS, see <a href="#">Hardware</a> on the Red Hat Customer Portal.
Storage with in-tree drivers	vSphere 7	This plugin creates vSphere storage by using the in-tree storage drivers for vSphere included in OpenShift Container Platform.

If you use a vSphere version 6.5 instance, upgrade to 7.0 before you install OpenShift Container Platform.

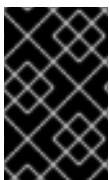

### IMPORTANT

You must ensure that the time on your ESXi hosts is synchronized before you install OpenShift Container Platform. See [Edit Time Configuration for a Host](#) in the VMware documentation.



## 21.8.6. VMware vSphere CSI Driver Operator requirements

To install the vSphere CSI Driver Operator, the following requirements must be met:

- VMware vSphere version 6.7U3 or later
- Virtual machines of hardware version 15 or later
- No third-party vSphere CSI driver already installed in the cluster



### IMPORTANT

If a third-party vSphere CSI driver is present in the cluster, OpenShift Container Platform does not overwrite it. If you continue with the third-party vSphere CSI driver when upgrading to the next major version of OpenShift Container Platform, the **oc** CLI prompts you with the following message:

```
VSphereCSIDriverOperatorCRUpgradeable: VMwareVSphereControllerUpgradeable:
found existing unsupported csi.vsphere.vmware.com driver
```

The previous message informs you that Red Hat does not support the third-party vSphere CSI driver during an OpenShift Container Platform upgrade operation. You can choose to ignore this message and continue with the upgrade operation.

### Additional resources

- To remove a third-party CSI driver, see [Removing a third-party vSphere CSI Driver](#) .
- To update the hardware version for your vSphere nodes, see [Updating hardware on nodes running in vSphere](#).

## 21.8.7. Requirements for a cluster with user-provisioned infrastructure

For a cluster that contains user-provisioned infrastructure, you must deploy all of the required machines.

This section describes the requirements for deploying OpenShift Container Platform on user-provisioned infrastructure.

### 21.8.7.1. Required machines for cluster installation

The smallest OpenShift Container Platform clusters require the following hosts:

**Table 21.78. Minimum required hosts**

Hosts	Description
One temporary bootstrap machine	The cluster requires the bootstrap machine to deploy the OpenShift Container Platform cluster on the three control plane machines. You can remove the bootstrap machine after you install the cluster.

Hosts	Description
Three control plane machines	The control plane machines run the Kubernetes and OpenShift Container Platform services that form the control plane.
At least two compute machines, which are also known as worker machines.	The workloads requested by OpenShift Container Platform users run on the compute machines.

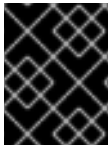

### IMPORTANT

To maintain high availability of your cluster, use separate physical hosts for these cluster machines.

The bootstrap and control plane machines must use Red Hat Enterprise Linux CoreOS (RHCOS) as the operating system. However, the compute machines can choose between Red Hat Enterprise Linux CoreOS (RHCOS), Red Hat Enterprise Linux (RHEL) 8.4, or RHEL 8.5.

Note that RHCOS is based on Red Hat Enterprise Linux (RHEL) 8 and inherits all of its hardware certifications and requirements. See [Red Hat Enterprise Linux technology capabilities and limits](#).

#### 21.8.7.2. Minimum resource requirements for cluster installation

Each cluster machine must meet the following minimum requirements:

**Table 21.79. Minimum resource requirements**

Machine	Operating System	vCPU [1]	Virtual RAM	Storage	IOPS [2]
Bootstrap	RHCOS	4	16 GB	100 GB	300
Control plane	RHCOS	4	16 GB	100 GB	300
Compute	RHCOS, RHEL 8.4, or RHEL 8.5 [3]	2	8 GB	100 GB	300

1. One vCPU is equivalent to one physical core when simultaneous multithreading (SMT), or hyperthreading, is not enabled. When enabled, use the following formula to calculate the corresponding ratio:  $(\text{threads per core} \times \text{cores}) \times \text{sockets} = \text{vCPUs}$ .
2. OpenShift Container Platform and Kubernetes are sensitive to disk performance, and faster storage is recommended, particularly for etcd on the control plane nodes which require a 10 ms p99 fsync duration. Note that on many cloud platforms, storage size and IOPS scale together, so you might need to over-allocate storage volume to obtain sufficient performance.
3. As with all user-provisioned installations, if you choose to use RHEL compute machines in your cluster, you take responsibility for all operating system life cycle management and maintenance, including performing system updates, applying patches, and completing all other required tasks.

Use of RHEL 7 compute machines is deprecated and has been removed in OpenShift Container Platform 4.10 and later.

If an instance type for your platform meets the minimum requirements for cluster machines, it is supported to use in OpenShift Container Platform.

### 21.8.7.3. Certificate signing requests management

Because your cluster has limited access to automatic machine management when you use infrastructure that you provision, you must provide a mechanism for approving cluster certificate signing requests (CSRs) after installation. The **kube-controller-manager** only approves the kubelet client CSRs. The **machine-approver** cannot guarantee the validity of a serving certificate that is requested by using kubelet credentials because it cannot confirm that the correct machine issued the request. You must determine and implement a method of verifying the validity of the kubelet serving certificate requests and approving them.

### 21.8.7.4. Networking requirements for user-provisioned infrastructure

All the Red Hat Enterprise Linux CoreOS (RHCOS) machines require networking to be configured in **initramfs** during boot to fetch their Ignition config files.

During the initial boot, the machines require an IP address configuration that is set either through a DHCP server or statically by providing the required boot options. After a network connection is established, the machines download their Ignition config files from an HTTP or HTTPS server. The Ignition config files are then used to set the exact state of each machine. The Machine Config Operator completes more changes to the machines, such as the application of new certificates or keys, after installation.

It is recommended to use a DHCP server for long-term management of the cluster machines. Ensure that the DHCP server is configured to provide persistent IP addresses, DNS server information, and hostnames to the cluster machines.



#### NOTE

If a DHCP service is not available for your user-provisioned infrastructure, you can instead provide the IP networking configuration and the address of the DNS server to the nodes at RHCOS install time. These can be passed as boot arguments if you are installing from an ISO image. See the *Installing RHCOS and starting the OpenShift Container Platform bootstrap process* section for more information about static IP provisioning and advanced networking options.

The Kubernetes API server must be able to resolve the node names of the cluster machines. If the API servers and worker nodes are in different zones, you can configure a default DNS search zone to allow the API server to resolve the node names. Another supported approach is to always refer to hosts by their fully-qualified domain names in both the node objects and all DNS requests.

#### 21.8.7.4.1. Setting the cluster node hostnames through DHCP

On Red Hat Enterprise Linux CoreOS (RHCOS) machines, the hostname is set through NetworkManager. By default, the machines obtain their hostname through DHCP. If the hostname is not provided by DHCP, set statically through kernel arguments, or another method, it is obtained through a reverse DNS lookup. Reverse DNS lookup occurs after the network has been initialized on a node and can take time to resolve. Other system services can start prior to this and detect the hostname as **localhost** or similar. You can avoid this by using DHCP to provide the hostname for each cluster node.

Additionally, setting the hostnames through DHCP can bypass any manual DNS record name configuration errors in environments that have a DNS split-horizon implementation.

#### 21.8.7.4.2. Network connectivity requirements

You must configure the network connectivity between machines to allow OpenShift Container Platform cluster components to communicate. Each machine must be able to resolve the hostnames of all other machines in the cluster.

This section provides details about the ports that are required.



#### IMPORTANT

In connected OpenShift Container Platform environments, all nodes are required to have internet access to pull images for platform containers and provide telemetry data to Red Hat.

Table 21.80. Ports used for all-machine to all-machine communications

Protocol	Port	Description
ICMP	N/A	Network reachability tests
TCP	<b>1936</b>	Metrics
	<b>9000-9999</b>	Host level services, including the node exporter on ports <b>9100-9101</b> and the Cluster Version Operator on port <b>9099</b> .
	<b>10250-10259</b>	The default ports that Kubernetes reserves
	<b>10256</b>	openshift-sdn
UDP	<b>4789</b>	VXLAN
	<b>6081</b>	Geneve
	<b>9000-9999</b>	Host level services, including the node exporter on ports <b>9100-9101</b> .
	<b>500</b>	IPsec IKE packets
	<b>4500</b>	IPsec NAT-T packets
TCP/UDP	<b>30000-32767</b>	Kubernetes node port
ESP	N/A	IPsec Encapsulating Security Payload (ESP)

Table 21.81. Ports used for all-machine to control plane communications

Protocol	Port	Description
TCP	<b>6443</b>	Kubernetes API

**Table 21.82. Ports used for control plane machine to control plane machine communications**

Protocol	Port	Description
TCP	<b>2379-2380</b>	etcd server and peer ports

### Ethernet adaptor hardware address requirements

When provisioning VMs for the cluster, the ethernet interfaces configured for each VM must use a MAC address from the VMware Organizationally Unique Identifier (OUI) allocation ranges:

- **00:05:69:00:00:00 to 00:05:69:FF:FF:FF**
- **00:0c:29:00:00:00 to 00:0c:29:FF:FF:FF**
- **00:1c:14:00:00:00 to 00:1c:14:FF:FF:FF**
- **00:50:56:00:00:00 to 00:50:56:3F:FF:FF**

If a MAC address outside the VMware OUI is used, the cluster installation will not succeed.

### NTP configuration for user-provisioned infrastructure

OpenShift Container Platform clusters are configured to use a public Network Time Protocol (NTP) server by default. If you want to use a local enterprise NTP server, or if your cluster is being deployed in a disconnected network, you can configure the cluster to use a specific time server. For more information, see the documentation for *Configuring chrony time service*.

If a DHCP server provides NTP server information, the chrony time service on the Red Hat Enterprise Linux CoreOS (RHCOS) machines read the information and can sync the clock with the NTP servers.

#### 21.8.7.5. User-provisioned DNS requirements

In OpenShift Container Platform deployments, DNS name resolution is required for the following components:

- The Kubernetes API
- The OpenShift Container Platform application wildcard
- The bootstrap, control plane, and compute machines

Reverse DNS resolution is also required for the Kubernetes API, the bootstrap machine, the control plane machines, and the compute machines.

DNS A/AAAA or CNAME records are used for name resolution and PTR records are used for reverse name resolution. The reverse records are important because Red Hat Enterprise Linux CoreOS (RHCOS) uses the reverse records to set the hostnames for all the nodes, unless the hostnames are provided by DHCP. Additionally, the reverse records are used to generate the certificate signing requests (CSR) that OpenShift Container Platform needs to operate.

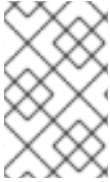
**NOTE**

It is recommended to use a DHCP server to provide the hostnames to each cluster node. See the *DHCP recommendations for user-provisioned infrastructure* section for more information.

The following DNS records are required for a user-provisioned OpenShift Container Platform cluster and they must be in place before installation. In each record, **<cluster\_name>** is the cluster name and **<base\_domain>** is the base domain that you specify in the **install-config.yaml** file. A complete DNS record takes the form: **<component>.<cluster\_name>.<base\_domain>.**

**Table 21.83. Required DNS records**

Component	Record	Description
Kubernetes API	<b>api.&lt;cluster_name&gt;.&lt;base_domain&gt;.</b>	A DNS A/AAAA or CNAME record, and a DNS PTR record, to identify the API load balancer. These records must be resolvable by both clients external to the cluster and from all the nodes within the cluster.
	<b>api-int.&lt;cluster_name&gt;.&lt;base_domain&gt;.</b>	A DNS A/AAAA or CNAME record, and a DNS PTR record, to internally identify the API load balancer. These records must be resolvable from all the nodes within the cluster.
		 <p><b>IMPORTANT</b></p> <p>The API server must be able to resolve the worker nodes by the hostnames that are recorded in Kubernetes. If the API server cannot resolve the node names, then proxied API calls can fail, and you cannot retrieve logs from pods.</p>
Routes	<b>*.apps.&lt;cluster_name&gt;.&lt;base_domain&gt;.</b>	A wildcard DNS A/AAAA or CNAME record that refers to the application ingress load balancer. The application ingress load balancer targets the machines that run the Ingress Controller pods. The Ingress Controller pods run on the compute machines by default. These records must be resolvable by both clients external to the cluster and from all the nodes within the cluster.
		For example, <b>console-openshift-console.apps.&lt;cluster_name&gt;.&lt;base_domain&gt;</b> is used as a wildcard route to the OpenShift Container Platform console.
Bootstrap machine	<b>bootstrap.&lt;cluster_name&gt;.&lt;base_domain&gt;.</b>	A DNS A/AAAA or CNAME record, and a DNS PTR record, to identify the bootstrap machine. These records must be resolvable by the nodes within the cluster.

Component	Record	Description
Control plane machines	<b>&lt;master&gt;&lt;n&gt;. &lt;cluster_name&gt;. &lt;base_domain&gt;.</b>	DNS A/AAAA or CNAME records and DNS PTR records to identify each machine for the control plane nodes. These records must be resolvable by the nodes within the cluster.
Compute machines	<b>&lt;worker&gt;&lt;n&gt;. &lt;cluster_name&gt;. &lt;base_domain&gt;.</b>	DNS A/AAAA or CNAME records and DNS PTR records to identify each machine for the worker nodes. These records must be resolvable by the nodes within the cluster.



## NOTE

In OpenShift Container Platform 4.4 and later, you do not need to specify etcd host and SRV records in your DNS configuration.

## TIP

You can use the **dig** command to verify name and reverse name resolution. See the section on *Validating DNS resolution for user-provisioned infrastructure* for detailed validation steps.

### 21.8.7.5.1. Example DNS configuration for user-provisioned clusters

This section provides A and PTR record configuration samples that meet the DNS requirements for deploying OpenShift Container Platform on user-provisioned infrastructure. The samples are not meant to provide advice for choosing one DNS solution over another.

In the examples, the cluster name is **ocp4** and the base domain is **example.com**.

#### Example DNS A record configuration for a user-provisioned cluster

The following example is a BIND zone file that shows sample A records for name resolution in a user-provisioned cluster.

#### Example 21.19. Sample DNS zone database

```
$TTL 1W
@ IN SOA ns1.example.com. root (
    2019070700 ; serial
    3H ; refresh (3 hours)
    30M ; retry (30 minutes)
    2W ; expiry (2 weeks)
    1W ) ; minimum (1 week)
IN NS ns1.example.com.
IN MX 10 smtp.example.com.
;
;
ns1.example.com. IN A 192.168.1.5
smtp.example.com. IN A 192.168.1.5
;
helper.example.com. IN A 192.168.1.5
```

```

helper.ocp4.example.com. IN A 192.168.1.5
;
api.ocp4.example.com. IN A 192.168.1.5 1
api-int.ocp4.example.com. IN A 192.168.1.5 2
;
*.apps.ocp4.example.com. IN A 192.168.1.5 3
;
bootstrap.ocp4.example.com. IN A 192.168.1.96 4
;
master0.ocp4.example.com. IN A 192.168.1.97 5
master1.ocp4.example.com. IN A 192.168.1.98 6
master2.ocp4.example.com. IN A 192.168.1.99 7
;
worker0.ocp4.example.com. IN A 192.168.1.11 8
worker1.ocp4.example.com. IN A 192.168.1.7 9
;
;EOF

```

- 1 Provides name resolution for the Kubernetes API. The record refers to the IP address of the API load balancer.
- 2 Provides name resolution for the Kubernetes API. The record refers to the IP address of the API load balancer and is used for internal cluster communications.
- 3 Provides name resolution for the wildcard routes. The record refers to the IP address of the application ingress load balancer. The application ingress load balancer targets the machines that run the Ingress Controller pods. The Ingress Controller pods run on the compute machines by default.



#### NOTE

In the example, the same load balancer is used for the Kubernetes API and application ingress traffic. In production scenarios, you can deploy the API and application ingress load balancers separately so that you can scale the load balancer infrastructure for each in isolation.

- 4 Provides name resolution for the bootstrap machine.
- 5 6 7 Provides name resolution for the control plane machines.
- 8 9 Provides name resolution for the compute machines.

### Example DNS PTR record configuration for a user-provisioned cluster

The following example BIND zone file shows sample PTR records for reverse name resolution in a user-provisioned cluster.

#### Example 21.20. Sample DNS zone database for reverse records

```

$TTL 1W
@ IN SOA ns1.example.com. root (
  2019070700 ; serial

```



```

3H ; refresh (3 hours)
30M ; retry (30 minutes)
2W ; expiry (2 weeks)
1W ) ; minimum (1 week)
IN NS ns1.example.com.
;
5.1.168.192.in-addr.arpa. IN PTR api.ocp4.example.com. 1
5.1.168.192.in-addr.arpa. IN PTR api-int.ocp4.example.com. 2
;
96.1.168.192.in-addr.arpa. IN PTR bootstrap.ocp4.example.com. 3
;
97.1.168.192.in-addr.arpa. IN PTR master0.ocp4.example.com. 4
98.1.168.192.in-addr.arpa. IN PTR master1.ocp4.example.com. 5
99.1.168.192.in-addr.arpa. IN PTR master2.ocp4.example.com. 6
;
11.1.168.192.in-addr.arpa. IN PTR worker0.ocp4.example.com. 7
7.1.168.192.in-addr.arpa. IN PTR worker1.ocp4.example.com. 8
;
;EOF

```

- 1 Provides reverse DNS resolution for the Kubernetes API. The PTR record refers to the record name of the API load balancer.
- 2 Provides reverse DNS resolution for the Kubernetes API. The PTR record refers to the record name of the API load balancer and is used for internal cluster communications.
- 3 Provides reverse DNS resolution for the bootstrap machine.
- 4 5 6 Provides reverse DNS resolution for the control plane machines.
- 7 8 Provides reverse DNS resolution for the compute machines.

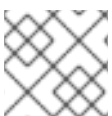

#### NOTE

A PTR record is not required for the OpenShift Container Platform application wildcard.

### 21.8.7.6. Load balancing requirements for user-provisioned infrastructure

Before you install OpenShift Container Platform, you must provision the API and application ingress load balancing infrastructure. In production scenarios, you can deploy the API and application ingress load balancers separately so that you can scale the load balancer infrastructure for each in isolation.

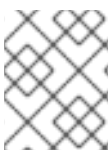

#### NOTE

If you want to deploy the API and application Ingress load balancers with a Red Hat Enterprise Linux (RHEL) instance, you must purchase the RHEL subscription separately.

The load balancing infrastructure must meet the following requirements:

1. **API load balancer.** Provides a common endpoint for users, both human and machine, to interact with and configure the platform. Configure the following conditions:

- Layer 4 load balancing only. This can be referred to as Raw TCP, SSL Passthrough, or SSL Bridge mode. If you use SSL Bridge mode, you must enable Server Name Indication (SNI) for the API routes.
- A stateless load balancing algorithm. The options vary based on the load balancer implementation.



### IMPORTANT

Do not configure session persistence for an API load balancer. Configuring session persistence for a Kubernetes API server might cause performance issues from excess application traffic for your OpenShift Container Platform cluster and the Kubernetes API that runs inside the cluster.

Configure the following ports on both the front and back of the load balancers:

**Table 21.84. API load balancer**

Port	Back-end machines (pool members)	Internal	External	Description
<b>6443</b>	Bootstrap and control plane. You remove the bootstrap machine from the load balancer after the bootstrap machine initializes the cluster control plane. You must configure the <b>/readyz</b> endpoint for the API server health check probe.	X	X	Kubernetes API server
<b>22623</b>	Bootstrap and control plane. You remove the bootstrap machine from the load balancer after the bootstrap machine initializes the cluster control plane.	X		Machine config server



### NOTE

The load balancer must be configured to take a maximum of 30 seconds from the time the API server turns off the **/readyz** endpoint to the removal of the API server instance from the pool. Within the time frame after **/readyz** returns an error or becomes healthy, the endpoint must have been removed or added. Probing every 5 or 10 seconds, with two successful requests to become healthy and three to become unhealthy, are well-tested values.

2. **Application Ingress load balancer.** Provides an ingress point for application traffic flowing in from outside the cluster. A working configuration for the Ingress router is required for an OpenShift Container Platform cluster.

Configure the following conditions:

- Layer 4 load balancing only. This can be referred to as Raw TCP, SSL Passthrough, or SSL Bridge mode. If you use SSL Bridge mode, you must enable Server Name Indication (SNI) for the ingress routes.

- A connection-based or session-based persistence is recommended, based on the options available and types of applications that will be hosted on the platform.

## TIP

If the true IP address of the client can be seen by the application Ingress load balancer, enabling source IP-based session persistence can improve performance for applications that use end-to-end TLS encryption.

Configure the following ports on both the front and back of the load balancers:

**Table 21.85. Application Ingress load balancer**

Port	Back-end machines (pool members)	Internal	External	Description
<b>443</b>	The machines that run the Ingress Controller pods, compute, or worker, by default.	X	X	HTTPS traffic
<b>80</b>	The machines that run the Ingress Controller pods, compute, or worker, by default.	X	X	HTTP traffic



## NOTE

If you are deploying a three-node cluster with zero compute nodes, the Ingress Controller pods run on the control plane nodes. In three-node cluster deployments, you must configure your application Ingress load balancer to route HTTP and HTTPS traffic to the control plane nodes.

### 21.8.7.6.1. Example load balancer configuration for user-provisioned clusters

This section provides an example API and application ingress load balancer configuration that meets the load balancing requirements for user-provisioned clusters. The sample is an `/etc/haproxy/haproxy.cfg` configuration for an HAProxy load balancer. The example is not meant to provide advice for choosing one load balancing solution over another.

In the example, the same load balancer is used for the Kubernetes API and application ingress traffic. In production scenarios, you can deploy the API and application ingress load balancers separately so that you can scale the load balancer infrastructure for each in isolation.



## NOTE

If you are using HAProxy as a load balancer and SELinux is set to **enforcing**, you must ensure that the HAProxy service can bind to the configured TCP port by running `setsebool -P haproxy_connect_any=1`.

### Example 21.21. Sample API and application Ingress load balancer configuration

```
global
log    127.0.0.1 local2
pidfile /var/run/haproxy.pid
```

```

maxconn 4000
daemon
defaults
mode http
log global
option dontlognull
option http-server-close
option redispatch
retries 3
timeout http-request 10s
timeout queue 1m
timeout connect 10s
timeout client 1m
timeout server 1m
timeout http-keep-alive 10s
timeout check 10s
maxconn 3000
listen api-server-6443 1
bind *:6443
mode tcp
server bootstrap bootstrap.ocp4.example.com:6443 check inter 1s backup 2
server master0 master0.ocp4.example.com:6443 check inter 1s
server master1 master1.ocp4.example.com:6443 check inter 1s
server master2 master2.ocp4.example.com:6443 check inter 1s
listen machine-config-server-22623 3
bind *:22623
mode tcp
server bootstrap bootstrap.ocp4.example.com:22623 check inter 1s backup 4
server master0 master0.ocp4.example.com:22623 check inter 1s
server master1 master1.ocp4.example.com:22623 check inter 1s
server master2 master2.ocp4.example.com:22623 check inter 1s
listen ingress-router-443 5
bind *:443
mode tcp
balance source
server worker0 worker0.ocp4.example.com:443 check inter 1s
server worker1 worker1.ocp4.example.com:443 check inter 1s
listen ingress-router-80 6
bind *:80
mode tcp
balance source
server worker0 worker0.ocp4.example.com:80 check inter 1s
server worker1 worker1.ocp4.example.com:80 check inter 1s

```

- 1** Port **6443** handles the Kubernetes API traffic and points to the control plane machines.
- 2** **4** The bootstrap entries must be in place before the OpenShift Container Platform cluster installation and they must be removed after the bootstrap process is complete.
- 3** Port **22623** handles the machine config server traffic and points to the control plane machines.
- 5** Port **443** handles the HTTPS traffic and points to the machines that run the Ingress Controller pods. The Ingress Controller pods run on the compute machines by default.
- 6** Port **80** handles the HTTP traffic and points to the machines that run the Ingress Controller pods. The Ingress Controller pods run on the compute machines by default.

**NOTE**

If you are deploying a three-node cluster with zero compute nodes, the Ingress Controller pods run on the control plane nodes. In three-node cluster deployments, you must configure your application Ingress load balancer to route HTTP and HTTPS traffic to the control plane nodes.

**TIP**

If you are using HAProxy as a load balancer, you can check that the **haproxy** process is listening on ports **6443**, **22623**, **443**, and **80** by running **netstat -nltp** on the HAProxy node.

### 21.8.8. Preparing the user-provisioned infrastructure

Before you install OpenShift Container Platform on user-provisioned infrastructure, you must prepare the underlying infrastructure.

This section provides details about the high-level steps required to set up your cluster infrastructure in preparation for an OpenShift Container Platform installation. This includes configuring IP networking and network connectivity for your cluster nodes, enabling the required ports through your firewall, and setting up the required DNS and load balancing infrastructure.

After preparation, your cluster infrastructure must meet the requirements outlined in the *Requirements for a cluster with user-provisioned infrastructure* section.

**Prerequisites**

- You have reviewed the [OpenShift Container Platform 4.x Tested Integrations](#) page.
- You have reviewed the infrastructure requirements detailed in the *Requirements for a cluster with user-provisioned infrastructure* section.

**Procedure**

1. If you are using DHCP to provide the IP networking configuration to your cluster nodes, configure your DHCP service.
  - a. Add persistent IP addresses for the nodes to your DHCP server configuration. In your configuration, match the MAC address of the relevant network interface to the intended IP address for each node.
  - b. When you use DHCP to configure IP addressing for the cluster machines, the machines also obtain the DNS server information through DHCP. Define the persistent DNS server address that is used by the cluster nodes through your DHCP server configuration.

**NOTE**

If you are not using a DHCP service, you must provide the IP networking configuration and the address of the DNS server to the nodes at RHCOS install time. These can be passed as boot arguments if you are installing from an ISO image. See the *Installing RHCOS and starting the OpenShift Container Platform bootstrap process* section for more information about static IP provisioning and advanced networking options.

- c. Define the hostnames of your cluster nodes in your DHCP server configuration. See the *Setting the cluster node hostnames through DHCP* section for details about hostname considerations.

**NOTE**

If you are not using a DHCP service, the cluster nodes obtain their hostname through a reverse DNS lookup.

2. Ensure that your network infrastructure provides the required network connectivity between the cluster components. See the *Networking requirements for user-provisioned infrastructure* section for details about the requirements.
3. Configure your firewall to enable the ports required for the OpenShift Container Platform cluster components to communicate. See *Networking requirements for user-provisioned infrastructure* section for details about the ports that are required.

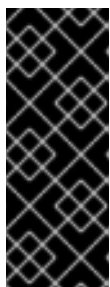
**IMPORTANT**

By default, port **1936** is accessible for an OpenShift Container Platform cluster, because each control plane node needs access to this port.

Avoid using the Ingress load balancer to expose this port, because doing so might result in the exposure of sensitive information, such as statistics and metrics, related to Ingress Controllers.

4. Setup the required DNS infrastructure for your cluster.
  - a. Configure DNS name resolution for the Kubernetes API, the application wildcard, the bootstrap machine, the control plane machines, and the compute machines.
  - b. Configure reverse DNS resolution for the Kubernetes API, the bootstrap machine, the control plane machines, and the compute machines.  
See the *User-provisioned DNS requirements* section for more information about the OpenShift Container Platform DNS requirements.
5. Validate your DNS configuration.
  - a. From your installation node, run DNS lookups against the record names of the Kubernetes API, the wildcard routes, and the cluster nodes. Validate that the IP addresses in the responses correspond to the correct components.
  - b. From your installation node, run reverse DNS lookups against the IP addresses of the load balancer and the cluster nodes. Validate that the record names in the responses correspond to the correct components.

See the *Validating DNS resolution for user-provisioned infrastructure* section for detailed DNS validation steps.

6. Provision the required API and application ingress load balancing infrastructure. See the *Load balancing requirements for user-provisioned infrastructure* section for more information about the requirements.



#### NOTE

Some load balancing solutions require the DNS name resolution for the cluster nodes to be in place before the load balancing is initialized.

### 21.8.9. Validating DNS resolution for user-provisioned infrastructure

You can validate your DNS configuration before installing OpenShift Container Platform on user-provisioned infrastructure.

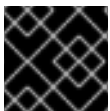

#### IMPORTANT

The validation steps detailed in this section must succeed before you install your cluster.

#### Prerequisites

- You have configured the required DNS records for your user-provisioned infrastructure.

#### Procedure

1. From your installation node, run DNS lookups against the record names of the Kubernetes API, the wildcard routes, and the cluster nodes. Validate that the IP addresses contained in the responses correspond to the correct components.
  - a. Perform a lookup against the Kubernetes API record name. Check that the result points to the IP address of the API load balancer:

```
$ dig +noall +answer @<nameserver_ip> api.<cluster_name>.<base_domain> 1
```

- 1 Replace **<nameserver\_ip>** with the IP address of the nameserver, **<cluster\_name>** with your cluster name, and **<base\_domain>** with your base domain name.

#### Example output

```
api.ocp4.example.com. 0 IN A 192.168.1.5
```

- b. Perform a lookup against the Kubernetes internal API record name. Check that the result points to the IP address of the API load balancer:

```
$ dig +noall +answer @<nameserver_ip> api-int.<cluster_name>.<base_domain>
```

#### Example output

```
api-int.ocp4.example.com. 0 IN A 192.168.1.5
```

- c. Test an example **\*.apps.<cluster\_name>.<base\_domain>** DNS wildcard lookup. All of the application wildcard lookups must resolve to the IP address of the application ingress load balancer:

```
$ dig +noall +answer @<nameserver_ip> random.apps.<cluster_name>.<base_domain>
```

### Example output

```
random.apps.ocp4.example.com. 0 IN A 192.168.1.5
```



### NOTE

In the example outputs, the same load balancer is used for the Kubernetes API and application ingress traffic. In production scenarios, you can deploy the API and application ingress load balancers separately so that you can scale the load balancer infrastructure for each in isolation.

You can replace **random** with another wildcard value. For example, you can query the route to the OpenShift Container Platform console:

```
$ dig +noall +answer @<nameserver_ip> console-openshift-console.apps.<cluster_name>.<base_domain>
```

### Example output

```
console-openshift-console.apps.ocp4.example.com. 0 IN A 192.168.1.5
```

- d. Run a lookup against the bootstrap DNS record name. Check that the result points to the IP address of the bootstrap node:

```
$ dig +noall +answer @<nameserver_ip> bootstrap.<cluster_name>.<base_domain>
```

### Example output

```
bootstrap.ocp4.example.com. 0 IN A 192.168.1.96
```

- e. Use this method to perform lookups against the DNS record names for the control plane and compute nodes. Check that the results correspond to the IP addresses of each node.
2. From your installation node, run reverse DNS lookups against the IP addresses of the load balancer and the cluster nodes. Validate that the record names contained in the responses correspond to the correct components.
    - a. Perform a reverse lookup against the IP address of the API load balancer. Check that the response includes the record names for the Kubernetes API and the Kubernetes internal API:

```
$ dig +noall +answer @<nameserver_ip> -x 192.168.1.5
```

### Example output



```
5.1.168.192.in-addr.arpa. 0 IN PTR api-int.ocp4.example.com. 1
5.1.168.192.in-addr.arpa. 0 IN PTR api.ocp4.example.com. 2
```

- 1 Provides the record name for the Kubernetes internal API.
- 2 Provides the record name for the Kubernetes API.



#### NOTE

A PTR record is not required for the OpenShift Container Platform application wildcard. No validation step is needed for reverse DNS resolution against the IP address of the application ingress load balancer.

- b. Perform a reverse lookup against the IP address of the bootstrap node. Check that the result points to the DNS record name of the bootstrap node:

```
$ dig +noall +answer @<nameserver_ip> -x 192.168.1.96
```

#### Example output

```
96.1.168.192.in-addr.arpa. 0 IN PTR bootstrap.ocp4.example.com.
```

- c. Use this method to perform reverse lookups against the IP addresses for the control plane and compute nodes. Check that the results correspond to the DNS record names of each node.

### 21.8.10. Generating a key pair for cluster node SSH access

During an OpenShift Container Platform installation, you can provide an SSH public key to the installation program. The key is passed to the Red Hat Enterprise Linux CoreOS (RHCOS) nodes through their Ignition config files and is used to authenticate SSH access to the nodes. The key is added to the `~/.ssh/authorized_keys` list for the **core** user on each node, which enables password-less authentication.

After the key is passed to the nodes, you can use the key pair to SSH in to the RHCOS nodes as the user **core**. To access the nodes through SSH, the private key identity must be managed by SSH for your local user.

If you want to SSH in to your cluster nodes to perform installation debugging or disaster recovery, you must provide the SSH public key during the installation process. The `./openshift-install gather` command also requires the SSH public key to be in place on the cluster nodes.

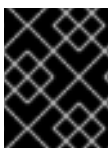

#### IMPORTANT

Do not skip this procedure in production environments, where disaster recovery and debugging is required.



#### NOTE

You must use a local key, not one that you configured with platform-specific approaches such as [AWS key pairs](#).

## Procedure

1. If you do not have an existing SSH key pair on your local machine to use for authentication onto your cluster nodes, create one. For example, on a computer that uses a Linux operating system, run the following command:

```
$ ssh-keygen -t ed25519 -N "" -f <path>/<file_name> 1
```

- 1 Specify the path and file name, such as `~/.ssh/id_ed25519`, of the new SSH key. If you have an existing key pair, ensure your public key is in the your `~/.ssh` directory.



### NOTE

If you plan to install an OpenShift Container Platform cluster that uses FIPS validated or Modules In Process cryptographic libraries on the **x86\_64** architecture, do not create a key that uses the **ed25519** algorithm. Instead, create a key that uses the **rsa** or **ecdsa** algorithm.

2. View the public SSH key:

```
$ cat <path>/<file_name>.pub
```

For example, run the following to view the `~/.ssh/id_ed25519.pub` public key:

```
$ cat ~/.ssh/id_ed25519.pub
```

3. Add the SSH private key identity to the SSH agent for your local user, if it has not already been added. SSH agent management of the key is required for password-less SSH authentication onto your cluster nodes, or if you want to use the `./openshift-install gather` command.



### NOTE

On some distributions, default SSH private key identities such as `~/.ssh/id_rsa` and `~/.ssh/id_dsa` are managed automatically.

- a. If the **ssh-agent** process is not already running for your local user, start it as a background task:

```
$ eval "$(ssh-agent -s)"
```

### Example output

```
Agent pid 31874
```



### NOTE

If your cluster is in FIPS mode, only use FIPS-compliant algorithms to generate the SSH key. The key must be either RSA or ECDSA.

4. Add your SSH private key to the **ssh-agent**:



```
$ ssh-add <path>/<file_name> 1
```

- 1 Specify the path and file name for your SSH private key, such as `~/.ssh/id_ed25519`

### Example output

```
Identity added: /home/<you>/<path>/<file_name> (<computer_name>)
```

### Next steps

- When you install OpenShift Container Platform, provide the SSH public key to the installation program. If you install a cluster on infrastructure that you provision, you must provide the key to the installation program.

## 21.8.11. Manually creating the installation configuration file

For user-provisioned installations of OpenShift Container Platform, you manually generate your installation configuration file.

### Prerequisites

- You have an SSH public key on your local machine to provide to the installation program. The key will be used for SSH authentication onto your cluster nodes for debugging and disaster recovery.
- You have obtained the OpenShift Container Platform installation program and the pull secret for your cluster.
- Obtain the **imageContentSources** section from the output of the command to mirror the repository.
- Obtain the contents of the certificate for your mirror registry.

### Procedure

1. Create an installation directory to store your required installation assets in:

```
$ mkdir <installation_directory>
```

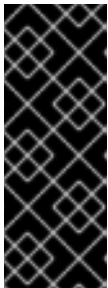

### IMPORTANT

You must create a directory. Some installation assets, like bootstrap X.509 certificates have short expiration intervals, so you must not reuse an installation directory. If you want to reuse individual files from another cluster installation, you can copy them into your directory. However, the file names for the installation assets might change between releases. Use caution when copying installation files from an earlier OpenShift Container Platform version.

2. Customize the sample **install-config.yaml** file template that is provided and save it in the **<installation\_directory>**.

**NOTE**

You must name this configuration file **install-config.yaml**.

- Unless you use a registry that RHCOS trusts by default, such as **docker.io**, you must provide the contents of the certificate for your mirror repository in the **additionalTrustBundle** section. In most cases, you must provide the certificate for your mirror.
- You must include the **imageContentSources** section from the output of the command to mirror the repository.

**NOTE**

For some platform types, you can alternatively run **./openshift-install create install-config --dir <installation\_directory>** to generate an **install-config.yaml** file. You can provide details about your cluster configuration at the prompts.

3. Back up the **install-config.yaml** file so that you can use it to install multiple clusters.

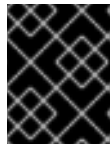
**IMPORTANT**

The **install-config.yaml** file is consumed during the next step of the installation process. You must back it up now.

**21.8.11.1. Sample install-config.yaml file for VMware vSphere**

You can customize the **install-config.yaml** file to specify more details about your OpenShift Container Platform cluster's platform or modify the values of the required parameters.

```

apiVersion: v1
baseDomain: example.com 1
compute: 2
- hyperthreading: Enabled 3
  name: worker
  replicas: 0 4
controlPlane: 5
  hyperthreading: Enabled 6
  name: master
  replicas: 3 7
metadata:
  name: test 8
platform:
  vsphere:
    vcenter: your.vcenter.server 9
    username: username 10
    password: password 11
    datacenter: datacenter 12
    defaultDatastore: datastore 13
    folder: "/<datacenter_name>/vm/<folder_name>/<subfolder_name>" 14
    resourcePool: "/<datacenter_name>/host/<cluster_name>/Resources/<resource_pool_name>" 15
    diskType: thin 16

```



- 13 The default vSphere datastore to use.
- 14 Optional parameter: For installer-provisioned infrastructure, the absolute path of an existing folder where the installation program creates the virtual machines, for example, `/<datacenter_name>/vm/<folder_name>/<subfolder_name>`. If you do not provide this value, the installation program creates a top-level folder in the datacenter virtual machine folder that is named with the infrastructure ID. If you are providing the infrastructure for the cluster and you do not want to use the default **StorageClass** object, named **thin**, you can omit the **folder** parameter from the **install-config.yaml** file.
- 15 Optional parameter: For installer-provisioned infrastructure, the absolute path of an existing resource pool where the installation program creates the virtual machines, for example, `/<datacenter_name>/host/<cluster_name>/Resources/<resource_pool_name>/<optional_nested_resource_pool_name>`. If you do not specify a value, resources are installed in the root of the cluster `/example_datacenter/host/example_cluster/Resources`.
- 16 The vSphere disk provisioning method.
- 17 Whether to enable or disable FIPS mode. By default, FIPS mode is not enabled. If FIPS mode is enabled, the Red Hat Enterprise Linux CoreOS (RHCOS) machines that OpenShift Container Platform runs on bypass the default Kubernetes cryptography suite and use the cryptography modules that are provided with RHCOS instead.



### IMPORTANT

To enable FIPS mode for your cluster, you must run the installation program from a Red Hat Enterprise Linux (RHEL) computer configured to operate in FIPS mode. For more information about configuring FIPS mode on RHEL, see [Installing the system in FIPS mode](#). The use of FIPS validated or Modules In Process cryptographic libraries is only supported on OpenShift Container Platform deployments on the **x86\_64** architecture.

- 18 For **<local\_registry>**, specify the registry domain name, and optionally the port, that your mirror registry uses to serve content. For example **registry.example.com** or **registry.example.com:5000**. For **<credentials>**, specify the base64-encoded user name and password for your mirror registry.
- 19 The public portion of the default SSH key for the **core** user in Red Hat Enterprise Linux CoreOS (RHCOS).



### NOTE

For production OpenShift Container Platform clusters on which you want to perform installation debugging or disaster recovery, specify an SSH key that your **ssh-agent** process uses.

- 20 Provide the contents of the certificate file that you used for your mirror registry.
- 21 Provide the **imageContentSources** section from the output of the command to mirror the repository.

## 21.8.11.2. Configuring the cluster-wide proxy during installation

Production environments can deny direct access to the internet and instead have an HTTP or HTTPS proxy available. You can configure a new OpenShift Container Platform cluster to use a proxy by configuring the proxy settings in the **install-config.yaml** file.

## Prerequisites

- You have an existing **install-config.yaml** file.
- You reviewed the sites that your cluster requires access to and determined whether any of them need to bypass the proxy. By default, all cluster egress traffic is proxied, including calls to hosting cloud provider APIs. You added sites to the **Proxy** object's **spec.noProxy** field to bypass the proxy if necessary.

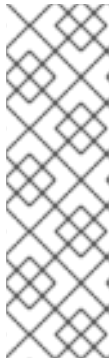

### NOTE

The **Proxy** object **status.noProxy** field is populated with the values of the **networking.machineNetwork[].cidr**, **networking.clusterNetwork[].cidr**, and **networking.serviceNetwork[]** fields from your installation configuration.

For installations on Amazon Web Services (AWS), Google Cloud Platform (GCP), Microsoft Azure, and Red Hat OpenStack Platform (RHOSP), the **Proxy** object **status.noProxy** field is also populated with the instance metadata endpoint (**169.254.169.254**).

## Procedure

1. Edit your **install-config.yaml** file and add the proxy settings. For example:

```
apiVersion: v1
baseDomain: my.domain.com
proxy:
  httpProxy: http://<username>:<pswd>@<ip>:<port> 1
  httpsProxy: https://<username>:<pswd>@<ip>:<port> 2
  noProxy: example.com 3
  additionalTrustBundle: | 4
    -----BEGIN CERTIFICATE-----
    <MY_TRUSTED_CA_CERT>
    -----END CERTIFICATE-----
  ...
```

- 1 A proxy URL to use for creating HTTP connections outside the cluster. The URL scheme must be **http**.
- 2 A proxy URL to use for creating HTTPS connections outside the cluster.
- 3 A comma-separated list of destination domain names, IP addresses, or other network CIDRs to exclude from proxying. Preface a domain with **.** to match subdomains only. For example, **.y.com** matches **x.y.com**, but not **y.com**. Use **\*** to bypass the proxy for all destinations. You must include vCenter's IP address and the IP range that you use for its machines.
- 4 If provided, the installation program generates a config map that is named **user-ca-bundle** in the **openshift-config** namespace that contains one or more additional CA certificates that are required for proxying HTTPS connections. The Cluster Network Operator then creates a **trusted-ca-bundle** config map that merges these contents with the Red Hat

Enterprise Linux CoreOS (RHCOS) trust bundle, and this config map is referenced in the **trustedCA** field of the **Proxy** object. The **additionalTrustBundle** field is required unless the proxy's identity certificate is signed by an authority from the RHCOS trust bundle.



#### NOTE

The installation program does not support the proxy **readinessEndpoints** field.



#### NOTE

If the installer times out, restart and then complete the deployment by using the **wait-for** command of the installer. For example:

```
$ ./openshift-install wait-for install-complete --log-level debug
```

2. Save the file and reference it when installing OpenShift Container Platform.

The installation program creates a cluster-wide proxy that is named **cluster** that uses the proxy settings in the provided **install-config.yaml** file. If no proxy settings are provided, a **cluster Proxy** object is still created, but it will have a nil **spec**.



#### NOTE

Only the **Proxy** object named **cluster** is supported, and no additional proxies can be created.

## 21.8.12. Creating the Kubernetes manifest and Ignition config files

Because you must modify some cluster definition files and manually start the cluster machines, you must generate the Kubernetes manifest and Ignition config files that the cluster needs to configure the machines.

The installation configuration file transforms into the Kubernetes manifests. The manifests wrap into the Ignition configuration files, which are later used to configure the cluster machines.



#### IMPORTANT

- The Ignition config files that the OpenShift Container Platform installation program generates contain certificates that expire after 24 hours, which are then renewed at that time. If the cluster is shut down before renewing the certificates and the cluster is later restarted after the 24 hours have elapsed, the cluster automatically recovers the expired certificates. The exception is that you must manually approve the pending **node-bootstrapper** certificate signing requests (CSRs) to recover kubelet certificates. See the documentation for *Recovering from expired control plane certificates* for more information.
- It is recommended that you use Ignition config files within 12 hours after they are generated because the 24-hour certificate rotates from 16 to 22 hours after the cluster is installed. By using the Ignition config files within 12 hours, you can avoid installation failure if the certificate update runs during installation.

### Prerequisites



- You obtained the OpenShift Container Platform installation program. For a restricted network installation, these files are on your mirror host.
- You created the **install-config.yaml** installation configuration file.

## Procedure

1. Change to the directory that contains the OpenShift Container Platform installation program and generate the Kubernetes manifests for the cluster:

```
$ ./openshift-install create manifests --dir <installation_directory> 1
```

- 1 For **<installation\_directory>**, specify the installation directory that contains the **install-config.yaml** file you created.

2. Remove the Kubernetes manifest files that define the control plane machines and compute machine sets:

```
$ rm -f openshift/99_openshift-cluster-api_master-machines-*.yaml openshift/99_openshift-cluster-api_worker-machineset-*.yaml
```

Because you create and manage these resources yourself, you do not have to initialize them.

- You can preserve the machine set files to create compute machines by using the machine API, but you must update references to them to match your environment.
3. Check that the **mastersSchedulable** parameter in the **<installation\_directory>/manifests/cluster-scheduler-02-config.yml** Kubernetes manifest file is set to **false**. This setting prevents pods from being scheduled on the control plane machines:
    - a. Open the **<installation\_directory>/manifests/cluster-scheduler-02-config.yml** file.
    - b. Locate the **mastersSchedulable** parameter and ensure that it is set to **false**.
    - c. Save and exit the file.
  4. To create the Ignition configuration files, run the following command from the directory that contains the installation program:

```
$ ./openshift-install create ignition-configs --dir <installation_directory> 1
```

- 1 For **<installation\_directory>**, specify the same installation directory.

Ignition config files are created for the bootstrap, control plane, and compute nodes in the installation directory. The **kubeadmin-password** and **kubeconfig** files are created in the **./<installation\_directory>/auth** directory:

```
.
├── auth
│   ├── kubeadmin-password
│   └── kubeconfig
└── bootstrap.ign
```

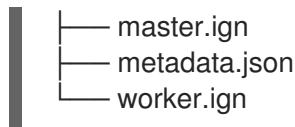

### 21.8.13. Extracting the infrastructure name

The Ignition config files contain a unique cluster identifier that you can use to uniquely identify your cluster in VMware Cloud on AWS. If you plan to use the cluster identifier as the name of your virtual machine folder, you must extract it.

#### Prerequisites

- You obtained the OpenShift Container Platform installation program and the pull secret for your cluster.
- You generated the Ignition config files for your cluster.
- You installed the **jq** package.

#### Procedure

- To extract and view the infrastructure name from the Ignition config file metadata, run the following command:

```
$ jq -r .infraID <installation_directory>/metadata.json 1
```

- 1 For **<installation\_directory>**, specify the path to the directory that you stored the installation files in.

#### Example output

```
openshift-vw9j6 1
```

- 1 The output of this command is your cluster name and a random string.

### 21.8.14. Installing RHCOS and starting the OpenShift Container Platform bootstrap process

To install OpenShift Container Platform on user-provisioned infrastructure on VMware vSphere, you must install Red Hat Enterprise Linux CoreOS (RHCOS) on vSphere hosts. When you install RHCOS, you must provide the Ignition config file that was generated by the OpenShift Container Platform installation program for the type of machine you are installing. If you have configured suitable networking, DNS, and load balancing infrastructure, the OpenShift Container Platform bootstrap process begins automatically after the RHCOS machines have rebooted.

#### Prerequisites

- You have obtained the Ignition config files for your cluster.
- You have access to an HTTP server that you can access from your computer and that the machines that you create can access.

- You have created a [vSphere cluster](#).

## Procedure

1. Upload the bootstrap Ignition config file, which is named **<installation\_directory>/bootstrap.ign**, that the installation program created to your HTTP server. Note the URL of this file.
2. Save the following secondary Ignition config file for your bootstrap node to your computer as **<installation\_directory>/merge-bootstrap.ign**:

```
{
  "ignition": {
    "config": {
      "merge": [
        {
          "source": "<bootstrap_ignition_config_url>", 1
          "verification": {}
        }
      ]
    },
    "timeouts": {},
    "version": "3.2.0"
  },
  "networkd": {},
  "passwd": {},
  "storage": {},
  "systemd": {}
}
```

- 1** Specify the URL of the bootstrap Ignition config file that you hosted.

When you create the virtual machine (VM) for the bootstrap machine, you use this Ignition config file.

3. Locate the following Ignition config files that the installation program created:
  - **<installation\_directory>/master.ign**
  - **<installation\_directory>/worker.ign**
  - **<installation\_directory>/merge-bootstrap.ign**
4. Convert the Ignition config files to Base64 encoding. Later in this procedure, you must add these files to the extra configuration parameter **guestinfo.ignition.config.data** in your VM. For example, if you use a Linux operating system, you can use the **base64** command to encode the files.

```
$ base64 -w0 <installation_directory>/master.ign > <installation_directory>/master.64
```

```
$ base64 -w0 <installation_directory>/worker.ign > <installation_directory>/worker.64
```

```
$ base64 -w0 <installation_directory>/merge-bootstrap.ign > <installation_directory>/merge-bootstrap.64
```

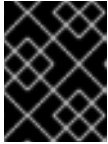
**IMPORTANT**

If you plan to add more compute machines to your cluster after you finish installation, do not delete these files.

5. Obtain the RHCOS OVA image. Images are available from the [RHCOS image mirror](#) page.

**IMPORTANT**

The RHCOS images might not change with every release of OpenShift Container Platform. You must download an image with the highest version that is less than or equal to the OpenShift Container Platform version that you install. Use the image version that matches your OpenShift Container Platform version if it is available.

The filename contains the OpenShift Container Platform version number in the format **rhcos-vmware.<architecture>.ova**.

6. In the vSphere Client, create a folder in your datacenter to store your VMs.
  - a. Click the **VMs and Templates** view.
  - b. Right-click the name of your datacenter.
  - c. Click **New Folder → New VM and Template Folder**.
  - d. In the window that is displayed, enter the folder name. If you did not specify an existing folder in the **install-config.yaml** file, then create a folder with the same name as the infrastructure ID. You use this folder name so vCenter dynamically provisions storage in the appropriate location for its Workspace configuration.
7. In the vSphere Client, create a template for the OVA image and then clone the template as needed.

**NOTE**

In the following steps, you create a template and then clone the template for all of your cluster machines. You then provide the location for the Ignition config file for that cloned machine type when you provision the VMs.

- a. From the **Hosts and Clusters** tab, right-click your cluster name and select **Deploy OVF Template**.
- b. On the **Select an OVF** tab, specify the name of the RHCOS OVA file that you downloaded.
- c. On the **Select a name and folder** tab, set a **Virtual machine name** for your template, such as **Template-RHCOS**. Click the name of your vSphere cluster and select the folder you created in the previous step.
- d. On the **Select a compute resource** tab, click the name of your vSphere cluster.
- e. On the **Select storage** tab, configure the storage options for your VM.
  - Select **Thin Provision** or **Thick Provision**, based on your storage preferences.

- Select the datastore that you specified in your **install-config.yaml** file.
- f. On the **Select network** tab, specify the network that you configured for the cluster, if available.
  - g. When creating the OVF template, do not specify values on the **Customize template** tab or configure the template any further.



### IMPORTANT

Do not start the original VM template. The VM template must remain off and must be cloned for new RHCOS machines. Starting the VM template configures the VM template as a VM on the platform, which prevents it from being used as a template that machine sets can apply configurations to.

8. Optional: Update the configured virtual hardware version in the VM template, if necessary. Follow [Upgrading a virtual machine to the latest hardware version](#) in the VMware documentation for more information.



### IMPORTANT

It is recommended that you update the hardware version of the VM template to version 15 before creating VMs from it, if necessary. Using hardware version 13 for your cluster nodes running on vSphere is now deprecated. If your imported template defaults to hardware version 13, you must ensure that your ESXi host is on 6.7U3 or later before upgrading the VM template to hardware version 15. If your vSphere version is less than 6.7U3, you can skip this upgrade step; however, a future version of OpenShift Container Platform is scheduled to remove support for hardware version 13 and vSphere versions less than 6.7U3.

9. After the template deploys, deploy a VM for a machine in the cluster.
  - a. Right-click the template name and click **Clone → Clone to Virtual Machine**
  - b. On the **Select a name and folder** tab, specify a name for the VM. You might include the machine type in the name, such as **control-plane-0** or **compute-1**.



### NOTE

Ensure that all virtual machine names across a vSphere installation are unique.

- c. On the **Select a name and folder** tab, select the name of the folder that you created for the cluster.
- d. On the **Select a compute resource** tab, select the name of a host in your datacenter.
- e. On the **Select clone options**, select **Customize this virtual machine's hardware**
- f. Optional: On the **Customize hardware** tab, click **VM Options → Advanced**.



## IMPORTANT

The following configuration suggestions are for example purposes only. As a cluster administrator, you must configure resources according to the resource demands placed on your cluster. To best manage cluster resources, consider creating a resource pool from the cluster's root resource pool.

- Override default DHCP networking in vSphere. To enable static IP networking:
  - Set your static IP configuration:

```
$ export IPCFG="ip=<ip>::<gateway>:<netmask>:<hostname>:<iface>:none
nameserver=svr1 [nameserver=svr2 [nameserver=svr3 [...]]]"
```

### Example command

```
$ export IPCFG="ip=192.168.100.101::192.168.100.254:255.255.255.0::none
nameserver=8.8.8.8"
```

- Click **Edit Configuration**, and on the **Configuration Parameters** window, search the list of available parameters for steal clock accounting (**stealclock.enable**). Set the parameter to the value of **TRUE**. Enabling steal clock accounting can help with troubleshooting cluster issues.
  - Click **Add Configuration Params**. Define the following parameter names and values:
    - **disk.EnableUUID**: Specify **TRUE**.
    - **stealclock.enable**: If this parameter was not defined, add it and specify **TRUE**.
    - Create a child resource pool from the cluster's root resource pool. Perform resource allocation in this child resource pool.
- g. In the **Virtual Hardware** panel of the **Customize hardware** tab, modify the specified values as required. Ensure that the amount of RAM, CPU, and disk storage meets the minimum requirements for the machine type.
- h. Complete the configuration and power on the VM.
- i. Check the console output to verify that Ignition ran.

### Example command

```
Ignition: ran on 2022/03/14 14:48:33 UTC (this boot)
Ignition: user-provided config was applied
```

10. Create the rest of the machines for your cluster by following the preceding steps for each machine.



## IMPORTANT

You must create the bootstrap and control plane machines at this time. Because some pods are deployed on compute machines by default, also create at least two compute machines before you install the cluster.

## 21.8.15. Adding more compute machines to a cluster in vSphere

You can add more compute machines to a user-provisioned OpenShift Container Platform cluster on VMware vSphere.

### Prerequisites

- Obtain the base64-encoded Ignition file for your compute machines.
- You have access to the vSphere template that you created for your cluster.

### Procedure

1. After the template deploys, deploy a VM for a machine in the cluster.
  - a. Right-click the template's name and click **Clone** → **Clone to Virtual Machine**
  - b. On the **Select a name and folder** tab, specify a name for the VM. You might include the machine type in the name, such as **compute-1**.



#### NOTE

Ensure that all virtual machine names across a vSphere installation are unique.

- c. On the **Select a name and folder** tab, select the name of the folder that you created for the cluster.
  - d. On the **Select a compute resource** tab, select the name of a host in your datacenter.
  - e. On the **Select clone options**, select **Customize this virtual machine's hardware**
  - f. On the **Customize hardware** tab, click **VM Options** → **Advanced**.
    - Click **Edit Configuration**, and on the **Configuration Parameters** window, click **Add Configuration Params**. Define the following parameter names and values:
      - **guestinfo.ignition.config.data**: Paste the contents of the base64-encoded compute Ignition config file for this machine type.
      - **guestinfo.ignition.config.data.encoding**: Specify **base64**.
      - **disk.EnableUUID**: Specify **TRUE**.
  - g. In the **Virtual Hardware** panel of the **Customize hardware** tab, modify the specified values as required. Ensure that the amount of RAM, CPU, and disk storage meets the minimum requirements for the machine type. Also, make sure to select the correct network under **Add network adapter** if there are multiple networks available.
  - h. Complete the configuration and power on the VM.
2. Continue to create more compute machines for your cluster.

## 21.8.16. Disk partitioning

In most cases, data partitions are originally created by installing RHCOS, rather than by installing another operating system. In such cases, the OpenShift Container Platform installer should be allowed to configure your disk partitions.

However, there are two cases where you might want to intervene to override the default partitioning when installing an OpenShift Container Platform node:

- **Create separate partitions:** For greenfield installations on an empty disk, you might want to add separate storage to a partition. This is officially supported for making **/var** or a subdirectory of **/var**, such as **/var/lib/etcd**, a separate partition, but not both.



#### IMPORTANT

For disk sizes larger than 100GB, and especially disk sizes larger than 1TB, create a separate **/var** partition. See "Creating a separate **/var** partition" and this [Red Hat Knowledgebase article](#) for more information.



#### IMPORTANT

Kubernetes supports only two file system partitions. If you add more than one partition to the original configuration, Kubernetes cannot monitor all of them.

- **Retain existing partitions:** For a brownfield installation where you are reinstalling OpenShift Container Platform on an existing node and want to retain data partitions installed from your previous operating system, there are both boot arguments and options to **coreos-installer** that allow you to retain existing data partitions.

### Creating a separate **/var** partition

In general, disk partitioning for OpenShift Container Platform should be left to the installer. However, there are cases where you might want to create separate partitions in a part of the filesystem that you expect to grow.

OpenShift Container Platform supports the addition of a single partition to attach storage to either the **/var** partition or a subdirectory of **/var**. For example:

- **/var/lib/containers:** Holds container-related content that can grow as more images and containers are added to a system.
- **/var/lib/etcd:** Holds data that you might want to keep separate for purposes such as performance optimization of etcd storage.
- **/var:** Holds data that you might want to keep separate for purposes such as auditing.



#### IMPORTANT

For disk sizes larger than 100GB, and especially larger than 1TB, create a separate **/var** partition.

Storing the contents of a **/var** directory separately makes it easier to grow storage for those areas as needed and reinstall OpenShift Container Platform at a later date and keep that data intact. With this method, you will not have to pull all your containers again, nor will you have to copy massive log files when you update systems.

Because **/var** must be in place before a fresh installation of Red Hat Enterprise Linux CoreOS (RHCOS), the following procedure sets up the separate **/var** partition by creating a machine config manifest that is



inserted during the **openshift-install** preparation phases of an OpenShift Container Platform installation.

## Procedure

1. Create a directory to hold the OpenShift Container Platform installation files:

```
$ mkdir $HOME/clusterconfig
```

2. Run **openshift-install** to create a set of files in the **manifest** and **openshift** subdirectories. Answer the system questions as you are prompted:

```
$ openshift-install create manifests --dir $HOME/clusterconfig
? SSH Public Key ...
$ ls $HOME/clusterconfig/openshift/
99_kubeadmin-password-secret.yaml
99_openshift-cluster-api_master-machines-0.yaml
99_openshift-cluster-api_master-machines-1.yaml
99_openshift-cluster-api_master-machines-2.yaml
...
```

3. Create a Butane config that configures the additional partition. For example, name the file **\$HOME/clusterconfig/98-var-partition.bu**, change the disk device name to the name of the storage device on the **worker** systems, and set the storage size as appropriate. This example places the **/var** directory on a separate partition:

```
variant: openshift
version: 4.10.0
metadata:
  labels:
    machineconfiguration.openshift.io/role: worker
  name: 98-var-partition
storage:
  disks:
    - device: /dev/<device_name> 1
      partitions:
        - label: var
          start_mib: <partition_start_offset> 2
          size_mib: <partition_size> 3
      filesystems:
        - device: /dev/disk/by-partlabel/var
          path: /var
          format: xfs
          mount_options: [defaults, prjquota] 4
          with_mount_unit: true
```

- 1 The storage device name of the disk that you want to partition.
- 2 When adding a data partition to the boot disk, a minimum value of 25000 mebibytes is recommended. The root file system is automatically resized to fill all available space up to the specified offset. If no value is specified, or if the specified value is smaller than the recommended minimum, the resulting root file system will be too small, and future reinstalls of RHCOS might overwrite the beginning of the data partition.

- 3 The size of the data partition in mebibytes.
- 4 The **prjquota** mount option must be enabled for filesystems used for container storage.

**NOTE**

When creating a separate **/var** partition, you cannot use different instance types for worker nodes, if the different instance types do not have the same device name.

4. Create a manifest from the Butane config and save it to the **clusterconfig/openshift** directory. For example, run the following command:

```
$ butane $HOME/clusterconfig/98-var-partition.bu -o $HOME/clusterconfig/openshift/98-var-partition.yaml
```

5. Run **openshift-install** again to create Ignition configs from a set of files in the **manifest** and **openshift** subdirectories:

```
$ openshift-install create ignition-configs --dir $HOME/clusterconfig
$ ls $HOME/clusterconfig/
auth bootstrap.ign master.ign metadata.json worker.ign
```

Now you can use the Ignition config files as input to the vSphere installation procedures to install Red Hat Enterprise Linux CoreOS (RHCOS) systems.

### 21.8.17. Updating the bootloader using **bootupd**

To update the bootloader by using **bootupd**, you must either install **bootupd** on RHCOS machines manually or provide a machine config with the enabled **systemd** unit. Unlike **grubby** or other bootloader tools, **bootupd** does not manage kernel space configuration such as passing kernel arguments.

After you have installed **bootupd**, you can manage it remotely from the OpenShift Container Platform cluster.

**NOTE**

It is recommended that you use **bootupd** only on bare metal or virtualized hypervisor installations, such as for protection against the BootHole vulnerability.

#### Manual install method

You can manually install **bootupd** by using the **bootctl** command-line tool.

1. Inspect the system status:

```
# bootupctl status
```

**Example output for x86\_64**

```
Component EFI
```

```
Installed: grub2-efi-x64-1:2.04-31.fc33.x86_64,shim-x64-15-8.x86_64
```

```
Update: At latest version
```

### Example output for aarch64

```
Component EFI
```

```
Installed: grub2-efi-aa64-1:2.02-99.el8_4.1.aarch64,shim-aa64-15.4-2.el8_1.aarch64
```

```
Update: At latest version
```

- RHCOS images created without **bootupd** installed on them require an explicit adoption phase. If the system status is **Adoptable**, perform the adoption:

```
# bootupctl adopt-and-update
```

### Example output

```
Updated: grub2-efi-x64-1:2.04-31.fc33.x86_64,shim-x64-15-8.x86_64
```

- If an update is available, apply the update so that the changes take effect on the next reboot:

```
# bootupctl update
```

### Example output

```
Updated: grub2-efi-x64-1:2.04-31.fc33.x86_64,shim-x64-15-8.x86_64
```

## Machine config method

Another way to enable **bootupd** is by providing a machine config.

- Provide a machine config file with the enabled **systemd** unit, as shown in the following example:

### Example output

```
variant: rhcos
version: 1.1.0
systemd:
  units:
    - name: custom-bootupd-auto.service
      enabled: true
      contents: |
        [Unit]
        Description=Bootupd automatic update

        [Service]
        ExecStart=/usr/bin/bootupctl update
        RemainAfterExit=yes

        [Install]
        WantedBy=multi-user.target
```

## 21.8.18. Waiting for the bootstrap process to complete

The OpenShift Container Platform bootstrap process begins after the cluster nodes first boot into the persistent RHCOS environment that has been installed to disk. The configuration information provided through the Ignition config files is used to initialize the bootstrap process and install OpenShift Container Platform on the machines. You must wait for the bootstrap process to complete.

### Prerequisites

- You have created the Ignition config files for your cluster.
- You have configured suitable network, DNS and load balancing infrastructure.
- You have obtained the installation program and generated the Ignition config files for your cluster.
- You installed RHCOS on your cluster machines and provided the Ignition config files that the OpenShift Container Platform installation program generated.

### Procedure

1. Monitor the bootstrap process:

```
$ ./openshift-install --dir <installation_directory> wait-for bootstrap-complete \ 1
--log-level=info 2
```

- 1 For **<installation\_directory>**, specify the path to the directory that you stored the installation files in.

- 2 To view different installation details, specify **warn**, **debug**, or **error** instead of **info**.

### Example output

```
INFO Waiting up to 30m0s for the Kubernetes API at https://api.test.example.com:6443...
INFO API v1.23.0 up
INFO Waiting up to 30m0s for bootstrapping to complete...
INFO It is now safe to remove the bootstrap resources
```

The command succeeds when the Kubernetes API server signals that it has been bootstrapped on the control plane machines.

2. After bootstrap process is complete, remove the bootstrap machine from the load balancer.



### IMPORTANT

You must remove the bootstrap machine from the load balancer at this point. You can also remove or reformat the bootstrap machine itself.

## 21.8.19. Logging in to the cluster by using the CLI

You can log in to your cluster as a default system user by exporting the cluster **kubeconfig** file. The **kubeconfig** file contains information about the cluster that is used by the CLI to connect a client to the correct cluster and API server. The file is specific to a cluster and is created during OpenShift Container

Platform installation.

### Prerequisites

- You deployed an OpenShift Container Platform cluster.
- You installed the **oc** CLI.

### Procedure

1. Export the **kubeadmin** credentials:

```
$ export KUBECONFIG=<installation_directory>/auth/kubeconfig 1
```

- 1** For **<installation\_directory>**, specify the path to the directory that you stored the installation files in.

2. Verify you can run **oc** commands successfully using the exported configuration:

```
$ oc whoami
```

#### Example output

```
system:admin
```

## 21.8.20. Approving the certificate signing requests for your machines

When you add machines to a cluster, two pending certificate signing requests (CSRs) are generated for each machine that you added. You must confirm that these CSRs are approved or, if necessary, approve them yourself. The client requests must be approved first, followed by the server requests.

### Prerequisites

- You added machines to your cluster.

### Procedure

1. Confirm that the cluster recognizes the machines:

```
$ oc get nodes
```

#### Example output

```
NAME      STATUS  ROLES  AGE  VERSION
master-0  Ready   master 63m  v1.23.0
master-1  Ready   master 63m  v1.23.0
master-2  Ready   master 64m  v1.23.0
```

The output lists all of the machines that you created.

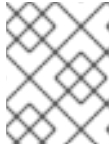
**NOTE**

The preceding output might not include the compute nodes, also known as worker nodes, until some CSRs are approved.

- Review the pending CSRs and ensure that you see the client requests with the **Pending** or **Approved** status for each machine that you added to the cluster:

```
$ oc get csr
```

**Example output**

```
NAME      AGE  REQUESTOR                                     CONDITION
csr-8b2br 15m  system:serviceaccount:openshift-machine-config-operator:node-
bootstrapper Pending
csr-8vnps 15m  system:serviceaccount:openshift-machine-config-operator:node-
bootstrapper Pending
...
```

In this example, two machines are joining the cluster. You might see more approved CSRs in the list.

- If the CSRs were not approved, after all of the pending CSRs for the machines you added are in **Pending** status, approve the CSRs for your cluster machines:

**NOTE**

Because the CSRs rotate automatically, approve your CSRs within an hour of adding the machines to the cluster. If you do not approve them within an hour, the certificates will rotate, and more than two certificates will be present for each node. You must approve all of these certificates. After the client CSR is approved, the Kubelet creates a secondary CSR for the serving certificate, which requires manual approval. Then, subsequent serving certificate renewal requests are automatically approved by the **machine-approver** if the Kubelet requests a new certificate with identical parameters.

**NOTE**

For clusters running on platforms that are not machine API enabled, such as bare metal and other user-provisioned infrastructure, you must implement a method of automatically approving the kubelet serving certificate requests (CSRs). If a request is not approved, then the **oc exec**, **oc rsh**, and **oc logs** commands cannot succeed, because a serving certificate is required when the API server connects to the kubelet. Any operation that contacts the Kubelet endpoint requires this certificate approval to be in place. The method must watch for new CSRs, confirm that the CSR was submitted by the **node-bootstrapper** service account in the **system:node** or **system:admin** groups, and confirm the identity of the node.

- To approve them individually, run the following command for each valid CSR:

```
$ oc adm certificate approve <csr_name> 1
```

1 **<csr\_name>** is the name of a CSR from the list of current CSRs.

- To approve all pending CSRs, run the following command:

```
$ oc get csr -o go-template='{{range .items}}{{if not .status}}{{.metadata.name}}{\n"}\n' | xargs --no-run-if-empty oc adm certificate approve
```



#### NOTE

Some Operators might not become available until some CSRs are approved.

- Now that your client requests are approved, you must review the server requests for each machine that you added to the cluster:

```
$ oc get csr
```

#### Example output

```
NAME      AGE   REQUESTOR                                     CONDITION
csr-bfd72 5m26s system:node:ip-10-0-50-126.us-east-2.compute.internal
Pending
csr-c57lv 5m26s system:node:ip-10-0-95-157.us-east-2.compute.internal
Pending
...
```

- If the remaining CSRs are not approved, and are in the **Pending** status, approve the CSRs for your cluster machines:

- To approve them individually, run the following command for each valid CSR:

```
$ oc adm certificate approve <csr_name> 1
```

1 **<csr\_name>** is the name of a CSR from the list of current CSRs.

- To approve all pending CSRs, run the following command:

```
$ oc get csr -o go-template='{{range .items}}{{if not .status}}{{.metadata.name}}{\n"}\n' | xargs oc adm certificate approve
```

- After all client and server CSRs have been approved, the machines have the **Ready** status. Verify this by running the following command:

```
$ oc get nodes
```

#### Example output

```
NAME      STATUS  ROLES  AGE  VERSION
master-0  Ready   master 73m  v1.23.0
master-1  Ready   master 73m  v1.23.0
```

```

master-2 Ready   master 74m v1.23.0
worker-0 Ready   worker 11m v1.23.0
worker-1 Ready   worker 11m v1.23.0

```

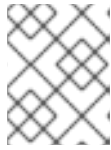
**NOTE**

It can take a few minutes after approval of the server CSRs for the machines to transition to the **Ready** status.

**Additional information**

- For more information on CSRs, see [Certificate Signing Requests](#).

**21.8.21. Initial Operator configuration**

After the control plane initializes, you must immediately configure some Operators so that they all become available.

**Prerequisites**

- Your control plane has initialized.

**Procedure**

1. Watch the cluster components come online:

```
$ watch -n5 oc get clusteroperators
```

**Example output**

NAME	VERSION	AVAILABLE	PROGRESSING	DEGRADED	SINCE
authentication	4.10.0	True	False	False	19m
baremetal	4.10.0	True	False	False	37m
cloud-credential	4.10.0	True	False	False	40m
cluster-autoscaler	4.10.0	True	False	False	37m
config-operator	4.10.0	True	False	False	38m
console	4.10.0	True	False	False	26m
csi-snapshot-controller	4.10.0	True	False	False	37m
dns	4.10.0	True	False	False	37m
etcd	4.10.0	True	False	False	36m
image-registry	4.10.0	True	False	False	31m
ingress	4.10.0	True	False	False	30m
insights	4.10.0	True	False	False	31m
kube-apiserver	4.10.0	True	False	False	26m
kube-controller-manager	4.10.0	True	False	False	36m
kube-scheduler	4.10.0	True	False	False	36m
kube-storage-version-migrator	4.10.0	True	False	False	37m
machine-api	4.10.0	True	False	False	29m
machine-approver	4.10.0	True	False	False	37m
machine-config	4.10.0	True	False	False	36m
marketplace	4.10.0	True	False	False	37m
monitoring	4.10.0	True	False	False	29m
network	4.10.0	True	False	False	38m



node-tuning	4.10.0	True	False	False	37m
openshift-apiserver	4.10.0	True	False	False	32m
openshift-controller-manager	4.10.0	True	False	False	30m
openshift-samples	4.10.0	True	False	False	32m
operator-lifecycle-manager	4.10.0	True	False	False	37m
operator-lifecycle-manager-catalog	4.10.0	True	False	False	37m
operator-lifecycle-manager-packageserver	4.10.0	True	False	False	32m
service-ca	4.10.0	True	False	False	38m
storage	4.10.0	True	False	False	37m

2. Configure the Operators that are not available.

### 21.8.21.1. Disabling the default OperatorHub sources

Operator catalogs that source content provided by Red Hat and community projects are configured for OperatorHub by default during an OpenShift Container Platform installation. In a restricted network environment, you must disable the default catalogs as a cluster administrator.

#### Procedure

- Disable the sources for the default catalogs by adding **disableAllDefaultSources: true** to the **OperatorHub** object:

```
$ oc patch OperatorHub cluster --type json \
  -p '[{"op": "add", "path": "/spec/disableAllDefaultSources", "value": true}]'
```

#### TIP

Alternatively, you can use the web console to manage catalog sources. From the **Administration** → **Cluster Settings** → **Configuration** → **OperatorHub** page, click the **Sources** tab, where you can create, delete, disable, and enable individual sources.

### 21.8.21.2. Image registry storage configuration

The Image Registry Operator is not initially available for platforms that do not provide default storage. After installation, you must configure your registry to use storage so that the Registry Operator is made available.

Instructions are shown for configuring a persistent volume, which is required for production clusters. Where applicable, instructions are shown for configuring an empty directory as the storage location, which is available for only non-production clusters.

Additional instructions are provided for allowing the image registry to use block storage types by using the **Recreate** rollout strategy during upgrades.

#### 21.8.21.2.1. Configuring registry storage for VMware vSphere

As a cluster administrator, following installation you must configure your registry to use storage.

#### Prerequisites

- Cluster administrator permissions.
- A cluster on VMware vSphere.

- Persistent storage provisioned for your cluster, such as Red Hat OpenShift Data Foundation.



### IMPORTANT

OpenShift Container Platform supports **ReadWriteOnce** access for image registry storage when you have only one replica. **ReadWriteOnce** access also requires that the registry uses the **Recreate** rollout strategy. To deploy an image registry that supports high availability with two or more replicas, **ReadWriteMany** access is required.

- Must have "100Gi" capacity.



### IMPORTANT

Testing shows issues with using the NFS server on RHEL as storage backend for core services. This includes the OpenShift Container Registry and Quay, Prometheus for monitoring storage, and Elasticsearch for logging storage. Therefore, using RHEL NFS to back PVs used by core services is not recommended.

Other NFS implementations on the marketplace might not have these issues. Contact the individual NFS implementation vendor for more information on any testing that was possibly completed against these OpenShift Container Platform core components.

## Procedure

1. To configure your registry to use storage, change the **spec.storage.pvc** in the **configs.imageregistry/cluster** resource.



### NOTE

When using shared storage, review your security settings to prevent outside access.

2. Verify that you do not have a registry pod:

```
$ oc get pod -n openshift-image-registry -l docker-registry=default
```

### Example output

```
No resources found in openshift-image-registry namespace
```



### NOTE

If you do have a registry pod in your output, you do not need to continue with this procedure.

3. Check the registry configuration:

```
$ oc edit configs.imageregistry.operator.openshift.io
```

### Example output

```
■
```

```
storage:
pvc:
claim: 1
```

- 1 Leave the **claim** field blank to allow the automatic creation of an **image-registry-storage** persistent volume claim (PVC). The PVC is generated based on the default storage class. However, be aware that the default storage class might provide ReadWriteOnce (RWO) volumes, such as a RADOS Block Device (RBD), which can cause issues when replicating to more than one replica.

4. Check the **clusteroperator** status:

```
$ oc get clusteroperator image-registry
```

#### Example output

NAME	VERSION	AVAILABLE	PROGRESSING	DEGRADED
image-registry	4.7	True	False	6h50m

#### 21.8.21.2.2. Configuring storage for the image registry in non-production clusters

You must configure storage for the Image Registry Operator. For non-production clusters, you can set the image registry to an empty directory. If you do so, all images are lost if you restart the registry.

#### Procedure

- To set the image registry storage to an empty directory:

```
$ oc patch configs.imageregistry.operator.openshift.io cluster --type merge --patch '{"spec": {"storage":{"emptyDir":{}}}'
```



#### WARNING

Configure this option for only non-production clusters.

If you run this command before the Image Registry Operator initializes its components, the **oc patch** command fails with the following error:

```
Error from server (NotFound): configs.imageregistry.operator.openshift.io "cluster" not found
```

Wait a few minutes and run the command again.

#### 21.8.21.2.3. Configuring block registry storage for VMware vSphere

To allow the image registry to use block storage types such as vSphere Virtual Machine Disk (VMDK) during upgrades as a cluster administrator, you can use the **Recreate** rollout strategy.

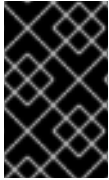

## IMPORTANT

Block storage volumes are supported but not recommended for use with image registry on production clusters. An installation where the registry is configured on block storage is not highly available because the registry cannot have more than one replica.

### Procedure

1. To set the image registry storage as a block storage type, patch the registry so that it uses the **Recreate** rollout strategy and runs with only **1** replica:

```
$ oc patch config.imageregistry.operator.openshift.io/cluster --type=merge -p '{"spec": {"rolloutStrategy": "Recreate", "replicas": 1}}'
```

2. Provision the PV for the block storage device, and create a PVC for that volume. The requested block volume uses the ReadWriteOnce (RWO) access mode.
  - a. Create a **pvc.yaml** file with the following contents to define a VMware vSphere **PersistentVolumeClaim** object:

```
kind: PersistentVolumeClaim
apiVersion: v1
metadata:
  name: image-registry-storage 1
  namespace: openshift-image-registry 2
spec:
  accessModes:
    - ReadWriteOnce 3
  resources:
    requests:
      storage: 100Gi 4
```

- 1 A unique name that represents the **PersistentVolumeClaim** object.
- 2 The namespace for the **PersistentVolumeClaim** object, which is **openshift-image-registry**.
- 3 The access mode of the persistent volume claim. With **ReadWriteOnce**, the volume can be mounted with read and write permissions by a single node.
- 4 The size of the persistent volume claim.

- b. Create the **PersistentVolumeClaim** object from the file:

```
$ oc create -f pvc.yaml -n openshift-image-registry
```

3. Edit the registry configuration so that it references the correct PVC:

```
$ oc edit config.imageregistry.operator.openshift.io -o yaml
```

### Example output

```
storage:
pvc:
claim: 1
```

- 1 Creating a custom PVC allows you to leave the **claim** field blank for the default automatic creation of an **image-registry-storage** PVC.

For instructions about configuring registry storage so that it references the correct PVC, see [Configuring registry storage for VMware vSphere](#).

## 21.8.22. Completing installation on user-provisioned infrastructure

After you complete the Operator configuration, you can finish installing the cluster on infrastructure that you provide.

### Prerequisites

- Your control plane has initialized.
- You have completed the initial Operator configuration.

### Procedure

1. Confirm that all the cluster components are online with the following command:

```
$ watch -n5 oc get clusteroperators
```

### Example output

NAME	VERSION	AVAILABLE	PROGRESSING	DEGRADED	SINCE
authentication	4.10.0	True	False	False	19m
baremetal	4.10.0	True	False	False	37m
cloud-credential	4.10.0	True	False	False	40m
cluster-autoscaler	4.10.0	True	False	False	37m
config-operator	4.10.0	True	False	False	38m
console	4.10.0	True	False	False	26m
csi-snapshot-controller	4.10.0	True	False	False	37m
dns	4.10.0	True	False	False	37m
etcd	4.10.0	True	False	False	36m
image-registry	4.10.0	True	False	False	31m
ingress	4.10.0	True	False	False	30m
insights	4.10.0	True	False	False	31m
kube-apiserver	4.10.0	True	False	False	26m
kube-controller-manager	4.10.0	True	False	False	36m
kube-scheduler	4.10.0	True	False	False	36m
kube-storage-version-migrator	4.10.0	True	False	False	37m
machine-api	4.10.0	True	False	False	29m
machine-approver	4.10.0	True	False	False	37m
machine-config	4.10.0	True	False	False	36m
marketplace	4.10.0	True	False	False	37m
monitoring	4.10.0	True	False	False	29m
network	4.10.0	True	False	False	38m

node-tuning	4.10.0	True	False	False	37m
openshift-apiserver	4.10.0	True	False	False	32m
openshift-controller-manager	4.10.0	True	False	False	30m
openshift-samples	4.10.0	True	False	False	32m
operator-lifecycle-manager	4.10.0	True	False	False	37m
operator-lifecycle-manager-catalog	4.10.0	True	False	False	37m
operator-lifecycle-manager-packageserver	4.10.0	True	False	False	32m
service-ca	4.10.0	True	False	False	38m
storage	4.10.0	True	False	False	37m

Alternatively, the following command notifies you when all of the clusters are available. It also retrieves and displays credentials:

```
$ ./openshift-install --dir <installation_directory> wait-for install-complete 1
```

- 1** For **<installation\_directory>**, specify the path to the directory that you stored the installation files in.

### Example output

```
INFO Waiting up to 30m0s for the cluster to initialize...
```

The command succeeds when the Cluster Version Operator finishes deploying the OpenShift Container Platform cluster from Kubernetes API server.

### IMPORTANT

- The Ignition config files that the installation program generates contain certificates that expire after 24 hours, which are then renewed at that time. If the cluster is shut down before renewing the certificates and the cluster is later restarted after the 24 hours have elapsed, the cluster automatically recovers the expired certificates. The exception is that you must manually approve the pending **node-bootstrapper** certificate signing requests (CSRs) to recover kubelet certificates. See the documentation for *Recovering from expired control plane certificates* for more information.
- It is recommended that you use Ignition config files within 12 hours after they are generated because the 24-hour certificate rotates from 16 to 22 hours after the cluster is installed. By using the Ignition config files within 12 hours, you can avoid installation failure if the certificate update runs during installation.

2. Confirm that the Kubernetes API server is communicating with the pods.
  - a. To view a list of all pods, use the following command:

```
$ oc get pods --all-namespaces
```

### Example output

```

NAMESPACE          NAME                                     READY STATUS
RESTARTS AGE
openshift-apiserver-operator  openshift-apiserver-operator-85cb746d55-zqhs8  1/1
```

```

Running 1 9m
openshift-apiserver apiserver-67b9g 1/1 Running 0
3m
openshift-apiserver apiserver-ljcmx 1/1 Running 0
1m
openshift-apiserver apiserver-z25h4 1/1 Running 0
2m
openshift-authentication-operator authentication-operator-69d5d8bf84-vh2n8 1/1
Running 0 5m
...

```

- b. View the logs for a pod that is listed in the output of the previous command by using the following command:

```
$ oc logs <pod_name> -n <namespace> 1
```

- 1 Specify the pod name and namespace, as shown in the output of the previous command.

If the pod logs display, the Kubernetes API server can communicate with the cluster machines.

- For an installation with Fibre Channel Protocol (FCP), additional steps are required to enable multipathing. Do not enable multipathing during installation. See "Enabling multipathing with kernel arguments on RHCOS" in the *Post-installation machine configuration tasks* documentation for more information.
- Register your cluster on the [Cluster registration](#) page.

You can add extra compute machines after the cluster installation is completed by following [Adding compute machines to vSphere](#).

### 21.8.23. Backing up VMware vSphere volumes

OpenShift Container Platform provisions new volumes as independent persistent disks to freely attach and detach the volume on any node in the cluster. As a consequence, it is not possible to back up volumes that use snapshots, or to restore volumes from snapshots. See [Snapshot Limitations](#) for more information.

#### Procedure

To create a backup of persistent volumes:

- Stop the application that is using the persistent volume.
- Clone the persistent volume.
- Restart the application.
- Create a backup of the cloned volume.
- Delete the cloned volume.

### 21.8.24. Telemetry access for OpenShift Container Platform

In OpenShift Container Platform 4.10, the Telemetry service, which runs by default to provide metrics about cluster health and the success of updates, requires internet access. If your cluster is connected to the internet, Telemetry runs automatically, and your cluster is registered to [OpenShift Cluster Manager](#).

After you confirm that your [OpenShift Cluster Manager](#) inventory is correct, either maintained automatically by Telemetry or manually by using OpenShift Cluster Manager, [use subscription watch](#) to track your OpenShift Container Platform subscriptions at the account or multi-cluster level.

### Additional resources

- See [About remote health monitoring](#) for more information about the Telemetry service

### 21.8.25. Next steps

- [Customize your cluster](#).
- [Configure image streams](#) for the Cluster Samples Operator and the **must-gather** tool.
- Learn how to [use Operator Lifecycle Manager \(OLM\) on restricted networks](#).
- If the mirror registry that you used to install your cluster has a trusted CA, add it to the cluster by [configuring additional trust stores](#).
- If necessary, you can [opt out of remote health reporting](#).
- Optional: [View the events from the vSphere Problem Detector Operator](#) to determine if the cluster has permission or storage configuration issues.

## 21.9. UNINSTALLING A CLUSTER ON VMC

You can remove a cluster installed on VMware vSphere infrastructure that you deployed to [VMware Cloud \(VMC\) on AWS](#) by using installer-provisioned infrastructure.

### 21.9.1. Removing a cluster that uses installer-provisioned infrastructure

You can remove a cluster that uses installer-provisioned infrastructure from your cloud.



#### NOTE

After uninstallation, check your cloud provider for any resources not removed properly, especially with User Provisioned Infrastructure (UPI) clusters. There might be resources that the installer did not create or that the installer is unable to access.

### Prerequisites

- Have a copy of the installation program that you used to deploy the cluster.
- Have the files that the installation program generated when you created your cluster.

### Procedure

1. From the directory that contains the installation program on the computer that you used to install the cluster, run the following command:



```
$. /openshift-install destroy cluster \  
--dir <installation_directory> --log-level info 1 2
```

- 1 For **<installation\_directory>**, specify the path to the directory that you stored the installation files in.
- 2 To view different details, specify **warn**, **debug**, or **error** instead of **info**.

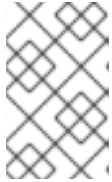

#### NOTE

You must specify the directory that contains the cluster definition files for your cluster. The installation program requires the **metadata.json** file in this directory to delete the cluster.

1. Optional: Delete the **<installation\_directory>** directory and the OpenShift Container Platform installation program.

## CHAPTER 22. INSTALLING ON ANY PLATFORM

### 22.1. INSTALLING A CLUSTER ON ANY PLATFORM

In OpenShift Container Platform version 4.10, you can install a cluster on any infrastructure that you provision, including virtualization and cloud environments.

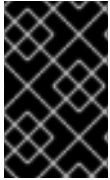

#### IMPORTANT

Review the information in the [guidelines for deploying OpenShift Container Platform on non-tested platforms](#) before you attempt to install an OpenShift Container Platform cluster in virtualized or cloud environments.

#### 22.1.1. Prerequisites

- You reviewed details about the [OpenShift Container Platform installation and update](#) processes.
- You read the documentation on [selecting a cluster installation method and preparing it for users](#).
- If you use a firewall, you [configured it to allow the sites](#) that your cluster requires access to.

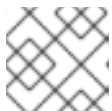

#### NOTE

Be sure to also review this site list if you are configuring a proxy.

#### 22.1.2. Internet access for OpenShift Container Platform

In OpenShift Container Platform 4.10, you require access to the internet to install your cluster.

You must have internet access to:

- Access [OpenShift Cluster Manager](#) to download the installation program and perform subscription management. If the cluster has internet access and you do not disable Telemetry, that service automatically entitles your cluster.
- Access [Quay.io](#) to obtain the packages that are required to install your cluster.
- Obtain the packages that are required to perform cluster updates.



#### IMPORTANT

If your cluster cannot have direct internet access, you can perform a restricted network installation on some types of infrastructure that you provision. During that process, you download the required content and use it to populate a mirror registry with the installation packages. With some installation types, the environment that you install your cluster in will not require internet access. Before you update the cluster, you update the content of the mirror registry.

#### 22.1.3. Requirements for a cluster with user-provisioned infrastructure

For a cluster that contains user-provisioned infrastructure, you must deploy all of the required machines.

This section describes the requirements for deploying OpenShift Container Platform on user-provisioned infrastructure.

### 22.1.3.1. Required machines for cluster installation

The smallest OpenShift Container Platform clusters require the following hosts:

**Table 22.1. Minimum required hosts**

Hosts	Description
One temporary bootstrap machine	The cluster requires the bootstrap machine to deploy the OpenShift Container Platform cluster on the three control plane machines. You can remove the bootstrap machine after you install the cluster.
Three control plane machines	The control plane machines run the Kubernetes and OpenShift Container Platform services that form the control plane.
At least two compute machines, which are also known as worker machines.	The workloads requested by OpenShift Container Platform users run on the compute machines.



#### IMPORTANT

To maintain high availability of your cluster, use separate physical hosts for these cluster machines.

The bootstrap and control plane machines must use Red Hat Enterprise Linux CoreOS (RHCOS) as the operating system. However, the compute machines can choose between Red Hat Enterprise Linux CoreOS (RHCOS), Red Hat Enterprise Linux (RHEL) 8.4, or RHEL 8.5.

Note that RHCOS is based on Red Hat Enterprise Linux (RHEL) 8 and inherits all of its hardware certifications and requirements. See [Red Hat Enterprise Linux technology capabilities and limits](#) .

### 22.1.3.2. Minimum resource requirements for cluster installation

Each cluster machine must meet the following minimum requirements:

**Table 22.2. Minimum resource requirements**

Machine	Operating System	vCPU [1]	Virtual RAM	Storage	IOPS [2]
Bootstrap	RHCOS	4	16 GB	100 GB	300
Control plane	RHCOS	4	16 GB	100 GB	300
Compute	RHCOS, RHEL 8.4, or RHEL 8.5 <sup>[3]</sup>	2	8 GB	100 GB	300

1. One vCPU is equivalent to one physical core when simultaneous multithreading (SMT), or hyperthreading, is not enabled. When enabled, use the following formula to calculate the corresponding ratio:  $(\text{threads per core} \times \text{cores}) \times \text{sockets} = \text{vCPUs}$ .
2. OpenShift Container Platform and Kubernetes are sensitive to disk performance, and faster storage is recommended, particularly for etcd on the control plane nodes which require a 10 ms p99 fsync duration. Note that on many cloud platforms, storage size and IOPS scale together, so you might need to over-allocate storage volume to obtain sufficient performance.
3. As with all user-provisioned installations, if you choose to use RHEL compute machines in your cluster, you take responsibility for all operating system life cycle management and maintenance, including performing system updates, applying patches, and completing all other required tasks. Use of RHEL 7 compute machines is deprecated and has been removed in OpenShift Container Platform 4.10 and later.

If an instance type for your platform meets the minimum requirements for cluster machines, it is supported to use in OpenShift Container Platform.

### 22.1.3.3. Certificate signing requests management

Because your cluster has limited access to automatic machine management when you use infrastructure that you provision, you must provide a mechanism for approving cluster certificate signing requests (CSRs) after installation. The **kube-controller-manager** only approves the kubelet client CSRs. The **machine-approver** cannot guarantee the validity of a serving certificate that is requested by using kubelet credentials because it cannot confirm that the correct machine issued the request. You must determine and implement a method of verifying the validity of the kubelet serving certificate requests and approving them.

### 22.1.3.4. Networking requirements for user-provisioned infrastructure

All the Red Hat Enterprise Linux CoreOS (RHCOS) machines require networking to be configured in **initramfs** during boot to fetch their Ignition config files.

During the initial boot, the machines require an IP address configuration that is set either through a DHCP server or statically by providing the required boot options. After a network connection is established, the machines download their Ignition config files from an HTTP or HTTPS server. The Ignition config files are then used to set the exact state of each machine. The Machine Config Operator completes more changes to the machines, such as the application of new certificates or keys, after installation.

It is recommended to use a DHCP server for long-term management of the cluster machines. Ensure that the DHCP server is configured to provide persistent IP addresses, DNS server information, and hostnames to the cluster machines.



#### NOTE

If a DHCP service is not available for your user-provisioned infrastructure, you can instead provide the IP networking configuration and the address of the DNS server to the nodes at RHCOS install time. These can be passed as boot arguments if you are installing from an ISO image. See the *Installing RHCOS and starting the OpenShift Container Platform bootstrap process* section for more information about static IP provisioning and advanced networking options.

The Kubernetes API server must be able to resolve the node names of the cluster machines. If the API servers and worker nodes are in different zones, you can configure a default DNS search zone to allow

the API server to resolve the node names. Another supported approach is to always refer to hosts by their fully-qualified domain names in both the node objects and all DNS requests.

#### 22.1.3.4.1. Setting the cluster node hostnames through DHCP

On Red Hat Enterprise Linux CoreOS (RHCOS) machines, the hostname is set through NetworkManager. By default, the machines obtain their hostname through DHCP. If the hostname is not provided by DHCP, set statically through kernel arguments, or another method, it is obtained through a reverse DNS lookup. Reverse DNS lookup occurs after the network has been initialized on a node and can take time to resolve. Other system services can start prior to this and detect the hostname as **localhost** or similar. You can avoid this by using DHCP to provide the hostname for each cluster node.

Additionally, setting the hostnames through DHCP can bypass any manual DNS record name configuration errors in environments that have a DNS split-horizon implementation.

#### 22.1.3.4.2. Network connectivity requirements

You must configure the network connectivity between machines to allow OpenShift Container Platform cluster components to communicate. Each machine must be able to resolve the hostnames of all other machines in the cluster.

This section provides details about the ports that are required.



#### IMPORTANT

In connected OpenShift Container Platform environments, all nodes are required to have internet access to pull images for platform containers and provide telemetry data to Red Hat.

Table 22.3. Ports used for all-machine to all-machine communications

Protocol	Port	Description
ICMP	N/A	Network reachability tests
TCP	<b>1936</b>	Metrics
	<b>9000-9999</b>	Host level services, including the node exporter on ports <b>9100-9101</b> and the Cluster Version Operator on port <b>9099</b> .
	<b>10250-10259</b>	The default ports that Kubernetes reserves
	<b>10256</b>	openshift-sdn
UDP	<b>4789</b>	VXLAN
	<b>6081</b>	Geneve
	<b>9000-9999</b>	Host level services, including the node exporter on ports <b>9100-9101</b> .

Protocol	Port	Description
	<b>500</b>	IPsec IKE packets
	<b>4500</b>	IPsec NAT-T packets
TCP/UDP	<b>30000-32767</b>	Kubernetes node port
ESP	N/A	IPsec Encapsulating Security Payload (ESP)

**Table 22.4. Ports used for all-machine to control plane communications**

Protocol	Port	Description
TCP	<b>6443</b>	Kubernetes API

**Table 22.5. Ports used for control plane machine to control plane machine communications**

Protocol	Port	Description
TCP	<b>2379-2380</b>	etcd server and peer ports

### NTP configuration for user-provisioned infrastructure

OpenShift Container Platform clusters are configured to use a public Network Time Protocol (NTP) server by default. If you want to use a local enterprise NTP server, or if your cluster is being deployed in a disconnected network, you can configure the cluster to use a specific time server. For more information, see the documentation for *Configuring chrony time service*.

If a DHCP server provides NTP server information, the chrony time service on the Red Hat Enterprise Linux CoreOS (RHCOS) machines read the information and can sync the clock with the NTP servers.

### Additional resources

- [Configuring chrony time service](#)

### 22.1.3.5. User-provisioned DNS requirements

In OpenShift Container Platform deployments, DNS name resolution is required for the following components:

- The Kubernetes API
- The OpenShift Container Platform application wildcard
- The bootstrap, control plane, and compute machines

Reverse DNS resolution is also required for the Kubernetes API, the bootstrap machine, the control plane machines, and the compute machines.

DNS A/AAAA or CNAME records are used for name resolution and PTR records are used for reverse

name resolution. The reverse records are important because Red Hat Enterprise Linux CoreOS (RHCOS) uses the reverse records to set the hostnames for all the nodes, unless the hostnames are provided by DHCP. Additionally, the reverse records are used to generate the certificate signing requests (CSR) that OpenShift Container Platform needs to operate.



## NOTE

It is recommended to use a DHCP server to provide the hostnames to each cluster node. See the *DHCP recommendations for user-provisioned infrastructure* section for more information.

The following DNS records are required for a user-provisioned OpenShift Container Platform cluster and they must be in place before installation. In each record, **<cluster\_name>** is the cluster name and **<base\_domain>** is the base domain that you specify in the **install-config.yaml** file. A complete DNS record takes the form: **<component>.<cluster\_name>.<base\_domain>..**

**Table 22.6. Required DNS records**

Component	Record	Description
Kubernetes API	<b>api.&lt;cluster_name&gt;.&lt;base_domain&gt;..</b>	A DNS A/AAAA or CNAME record, and a DNS PTR record, to identify the API load balancer. These records must be resolvable by both clients external to the cluster and from all the nodes within the cluster.
	<b>api-int.&lt;cluster_name&gt;.&lt;base_domain&gt;..</b>	A DNS A/AAAA or CNAME record, and a DNS PTR record, to internally identify the API load balancer. These records must be resolvable from all the nodes within the cluster. <div data-bbox="740 1249 844 1505" data-label="Image"> </div> <div data-bbox="919 1252 1115 1285" data-label="Section-Header"> <h2>IMPORTANT</h2> </div> <div data-bbox="919 1317 1415 1505" data-label="Text"> <p>The API server must be able to resolve the worker nodes by the hostnames that are recorded in Kubernetes. If the API server cannot resolve the node names, then proxied API calls can fail, and you cannot retrieve logs from pods.</p> </div>
Routes	<b>*.apps.&lt;cluster_name&gt;.&lt;base_domain&gt;..</b>	A wildcard DNS A/AAAA or CNAME record that refers to the application ingress load balancer. The application ingress load balancer targets the machines that run the Ingress Controller pods. The Ingress Controller pods run on the compute machines by default. These records must be resolvable by both clients external to the cluster and from all the nodes within the cluster. <p>For example, <b>console-openshift-console.apps.&lt;cluster_name&gt;.&lt;base_domain&gt;..</b> is used as a wildcard route to the OpenShift Container Platform console.</p>

Component	Record	Description
Bootstrap machine	<b>bootstrap.&lt;cluster_name&gt;.&lt;base_domain&gt;.</b>	A DNS A/AAAA or CNAME record, and a DNS PTR record, to identify the bootstrap machine. These records must be resolvable by the nodes within the cluster.
Control plane machines	<b>&lt;master&gt;&lt;n&gt;.&lt;cluster_name&gt;.&lt;base_domain&gt;.</b>	DNS A/AAAA or CNAME records and DNS PTR records to identify each machine for the control plane nodes. These records must be resolvable by the nodes within the cluster.
Compute machines	<b>&lt;worker&gt;&lt;n&gt;.&lt;cluster_name&gt;.&lt;base_domain&gt;.</b>	DNS A/AAAA or CNAME records and DNS PTR records to identify each machine for the worker nodes. These records must be resolvable by the nodes within the cluster.



## NOTE

In OpenShift Container Platform 4.4 and later, you do not need to specify etcd host and SRV records in your DNS configuration.

## TIP

You can use the **dig** command to verify name and reverse name resolution. See the section on *Validating DNS resolution for user-provisioned infrastructure* for detailed validation steps.

### 22.1.3.5.1. Example DNS configuration for user-provisioned clusters

This section provides A and PTR record configuration samples that meet the DNS requirements for deploying OpenShift Container Platform on user-provisioned infrastructure. The samples are not meant to provide advice for choosing one DNS solution over another.

In the examples, the cluster name is **ocp4** and the base domain is **example.com**.

#### Example DNS A record configuration for a user-provisioned cluster

The following example is a BIND zone file that shows sample A records for name resolution in a user-provisioned cluster.

#### Example 22.1. Sample DNS zone database

```
$TTL 1W
@ IN SOA ns1.example.com. root (
  2019070700 ; serial
  3H ; refresh (3 hours)
  30M ; retry (30 minutes)
  2W ; expiry (2 weeks)
  1W ) ; minimum (1 week)
IN NS ns1.example.com.
IN MX 10 smtp.example.com.
```



```

;
;
;
ns1.example.com. IN A 192.168.1.5
smtp.example.com. IN A 192.168.1.5
;
helper.example.com. IN A 192.168.1.5
helper.ocp4.example.com. IN A 192.168.1.5
;
api.ocp4.example.com. IN A 192.168.1.5 1
api-int.ocp4.example.com. IN A 192.168.1.5 2
;
*.apps.ocp4.example.com. IN A 192.168.1.5 3
;
bootstrap.ocp4.example.com. IN A 192.168.1.96 4
;
master0.ocp4.example.com. IN A 192.168.1.97 5
master1.ocp4.example.com. IN A 192.168.1.98 6
master2.ocp4.example.com. IN A 192.168.1.99 7
;
worker0.ocp4.example.com. IN A 192.168.1.11 8
worker1.ocp4.example.com. IN A 192.168.1.7 9
;
;EOF

```

- 1 Provides name resolution for the Kubernetes API. The record refers to the IP address of the API load balancer.
- 2 Provides name resolution for the Kubernetes API. The record refers to the IP address of the API load balancer and is used for internal cluster communications.
- 3 Provides name resolution for the wildcard routes. The record refers to the IP address of the application ingress load balancer. The application ingress load balancer targets the machines that run the Ingress Controller pods. The Ingress Controller pods run on the compute machines by default.



#### NOTE

In the example, the same load balancer is used for the Kubernetes API and application ingress traffic. In production scenarios, you can deploy the API and application ingress load balancers separately so that you can scale the load balancer infrastructure for each in isolation.

- 4 Provides name resolution for the bootstrap machine.
- 5 6 7 Provides name resolution for the control plane machines.
- 8 9 Provides name resolution for the compute machines.

### Example DNS PTR record configuration for a user-provisioned cluster

The following example BIND zone file shows sample PTR records for reverse name resolution in a user-provisioned cluster.

-

**Example 22.2. Sample DNS zone database for reverse records**

```

$TTL 1W
@ IN SOA ns1.example.com. root (
    2019070700 ; serial
    3H ; refresh (3 hours)
    30M ; retry (30 minutes)
    2W ; expiry (2 weeks)
    1W ) ; minimum (1 week)
IN NS ns1.example.com.
;
5.1.168.192.in-addr.arpa. IN PTR api.ocp4.example.com. 1
5.1.168.192.in-addr.arpa. IN PTR api-int.ocp4.example.com. 2
;
96.1.168.192.in-addr.arpa. IN PTR bootstrap.ocp4.example.com. 3
;
97.1.168.192.in-addr.arpa. IN PTR master0.ocp4.example.com. 4
98.1.168.192.in-addr.arpa. IN PTR master1.ocp4.example.com. 5
99.1.168.192.in-addr.arpa. IN PTR master2.ocp4.example.com. 6
;
11.1.168.192.in-addr.arpa. IN PTR worker0.ocp4.example.com. 7
7.1.168.192.in-addr.arpa. IN PTR worker1.ocp4.example.com. 8
;
;EOF

```

- 1** Provides reverse DNS resolution for the Kubernetes API. The PTR record refers to the record name of the API load balancer.
- 2** Provides reverse DNS resolution for the Kubernetes API. The PTR record refers to the record name of the API load balancer and is used for internal cluster communications.
- 3** Provides reverse DNS resolution for the bootstrap machine.
- 4 5 6** Provides reverse DNS resolution for the control plane machines.
- 7 8** Provides reverse DNS resolution for the compute machines.

**NOTE**

A PTR record is not required for the OpenShift Container Platform application wildcard.

**22.1.3.6. Load balancing requirements for user-provisioned infrastructure**

Before you install OpenShift Container Platform, you must provision the API and application ingress load balancing infrastructure. In production scenarios, you can deploy the API and application ingress load balancers separately so that you can scale the load balancer infrastructure for each in isolation.

**NOTE**

If you want to deploy the API and application Ingress load balancers with a Red Hat Enterprise Linux (RHEL) instance, you must purchase the RHEL subscription separately.

The load balancing infrastructure must meet the following requirements:

1. **API load balancer.** Provides a common endpoint for users, both human and machine, to interact with and configure the platform. Configure the following conditions:
  - Layer 4 load balancing only. This can be referred to as Raw TCP, SSL Passthrough, or SSL Bridge mode. If you use SSL Bridge mode, you must enable Server Name Indication (SNI) for the API routes.
  - A stateless load balancing algorithm. The options vary based on the load balancer implementation.



### IMPORTANT

Do not configure session persistence for an API load balancer. Configuring session persistence for a Kubernetes API server might cause performance issues from excess application traffic for your OpenShift Container Platform cluster and the Kubernetes API that runs inside the cluster.

Configure the following ports on both the front and back of the load balancers:

Table 22.7. API load balancer

Port	Back-end machines (pool members)	Internal	External	Description
<b>6443</b>	Bootstrap and control plane. You remove the bootstrap machine from the load balancer after the bootstrap machine initializes the cluster control plane. You must configure the <b>/readyz</b> endpoint for the API server health check probe.	X	X	Kubernetes API server
<b>22623</b>	Bootstrap and control plane. You remove the bootstrap machine from the load balancer after the bootstrap machine initializes the cluster control plane.	X		Machine config server



### NOTE

The load balancer must be configured to take a maximum of 30 seconds from the time the API server turns off the **/readyz** endpoint to the removal of the API server instance from the pool. Within the time frame after **/readyz** returns an error or becomes healthy, the endpoint must have been removed or added. Probing every 5 or 10 seconds, with two successful requests to become healthy and three to become unhealthy, are well-tested values.

2. **Application Ingress load balancer.** Provides an ingress point for application traffic flowing in from outside the cluster. A working configuration for the Ingress router is required for an OpenShift Container Platform cluster. Configure the following conditions:

- Layer 4 load balancing only. This can be referred to as Raw TCP, SSL Passthrough, or SSL Bridge mode. If you use SSL Bridge mode, you must enable Server Name Indication (SNI) for the ingress routes.
- A connection-based or session-based persistence is recommended, based on the options available and types of applications that will be hosted on the platform.

**TIP**

If the true IP address of the client can be seen by the application Ingress load balancer, enabling source IP-based session persistence can improve performance for applications that use end-to-end TLS encryption.

Configure the following ports on both the front and back of the load balancers:

**Table 22.8. Application Ingress load balancer**

Port	Back-end machines (pool members)	Internal	External	Description
<b>443</b>	The machines that run the Ingress Controller pods, compute, or worker, by default.	X	X	HTTPS traffic
<b>80</b>	The machines that run the Ingress Controller pods, compute, or worker, by default.	X	X	HTTP traffic

**NOTE**

If you are deploying a three-node cluster with zero compute nodes, the Ingress Controller pods run on the control plane nodes. In three-node cluster deployments, you must configure your application Ingress load balancer to route HTTP and HTTPS traffic to the control plane nodes.

**22.1.3.6.1. Example load balancer configuration for user-provisioned clusters**

This section provides an example API and application ingress load balancer configuration that meets the load balancing requirements for user-provisioned clusters. The sample is an `/etc/haproxy/haproxy.cfg` configuration for an HAProxy load balancer. The example is not meant to provide advice for choosing one load balancing solution over another.

In the example, the same load balancer is used for the Kubernetes API and application ingress traffic. In production scenarios, you can deploy the API and application ingress load balancers separately so that you can scale the load balancer infrastructure for each in isolation.

**NOTE**

If you are using HAProxy as a load balancer and SELinux is set to **enforcing**, you must ensure that the HAProxy service can bind to the configured TCP port by running `setsebool -P haproxy_connect_any=1`.

**Example 22.3. Sample API and application Ingress load balancer configuration**

```

global
  log      127.0.0.1 local2
  pidfile  /var/run/haproxy.pid
  maxconn  4000
  daemon
defaults
  mode          http
  log           global
  option        dontlognull
  option http-server-close
  option        redispatch
  retries       3
  timeout http-request  10s
  timeout queue        1m
  timeout connect      10s
  timeout client       1m
  timeout server       1m
  timeout http-keep-alive 10s
  timeout check        10s
  maxconn             3000
listen api-server-6443 1
  bind *:6443
  mode tcp
  server bootstrap bootstrap.ocp4.example.com:6443 check inter 1s backup 2
  server master0 master0.ocp4.example.com:6443 check inter 1s
  server master1 master1.ocp4.example.com:6443 check inter 1s
  server master2 master2.ocp4.example.com:6443 check inter 1s
listen machine-config-server-22623 3
  bind *:22623
  mode tcp
  server bootstrap bootstrap.ocp4.example.com:22623 check inter 1s backup 4
  server master0 master0.ocp4.example.com:22623 check inter 1s
  server master1 master1.ocp4.example.com:22623 check inter 1s
  server master2 master2.ocp4.example.com:22623 check inter 1s
listen ingress-router-443 5
  bind *:443
  mode tcp
  balance source
  server worker0 worker0.ocp4.example.com:443 check inter 1s
  server worker1 worker1.ocp4.example.com:443 check inter 1s
listen ingress-router-80 6
  bind *:80
  mode tcp
  balance source
  server worker0 worker0.ocp4.example.com:80 check inter 1s
  server worker1 worker1.ocp4.example.com:80 check inter 1s

```

- 1** Port **6443** handles the Kubernetes API traffic and points to the control plane machines.
- 2** **4** The bootstrap entries must be in place before the OpenShift Container Platform cluster installation and they must be removed after the bootstrap process is complete.
- 3** Port **22623** handles the machine config server traffic and points to the control plane machines.
- 5** Port **443** handles the HTTPS traffic and points to the machines that run the Ingress Controller pods. The Ingress Controller pods run on the compute machines by default.

Pods. The Ingress Controller pods run on the compute machines by default.

- 6** Port **80** handles the HTTP traffic and points to the machines that run the Ingress Controller pods. The Ingress Controller pods run on the compute machines by default.

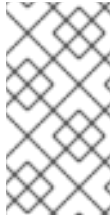

#### NOTE

If you are deploying a three-node cluster with zero compute nodes, the Ingress Controller pods run on the control plane nodes. In three-node cluster deployments, you must configure your application Ingress load balancer to route HTTP and HTTPS traffic to the control plane nodes.

#### TIP

If you are using HAProxy as a load balancer, you can check that the **haproxy** process is listening on ports **6443**, **22623**, **443**, and **80** by running **netstat -nltp** on the HAProxy node.

### 22.1.4. Preparing the user-provisioned infrastructure

Before you install OpenShift Container Platform on user-provisioned infrastructure, you must prepare the underlying infrastructure.

This section provides details about the high-level steps required to set up your cluster infrastructure in preparation for an OpenShift Container Platform installation. This includes configuring IP networking and network connectivity for your cluster nodes, enabling the required ports through your firewall, and setting up the required DNS and load balancing infrastructure.

After preparation, your cluster infrastructure must meet the requirements outlined in the *Requirements for a cluster with user-provisioned infrastructure* section.

#### Prerequisites

- You have reviewed the [OpenShift Container Platform 4.x Tested Integrations](#) page.
- You have reviewed the infrastructure requirements detailed in the *Requirements for a cluster with user-provisioned infrastructure* section.

#### Procedure

1. If you are using DHCP to provide the IP networking configuration to your cluster nodes, configure your DHCP service.
  - a. Add persistent IP addresses for the nodes to your DHCP server configuration. In your configuration, match the MAC address of the relevant network interface to the intended IP address for each node.
  - b. When you use DHCP to configure IP addressing for the cluster machines, the machines also obtain the DNS server information through DHCP. Define the persistent DNS server address that is used by the cluster nodes through your DHCP server configuration.

**NOTE**

If you are not using a DHCP service, you must provide the IP networking configuration and the address of the DNS server to the nodes at RHCOS install time. These can be passed as boot arguments if you are installing from an ISO image. See the *Installing RHCOS and starting the OpenShift Container Platform bootstrap process* section for more information about static IP provisioning and advanced networking options.

- c. Define the hostnames of your cluster nodes in your DHCP server configuration. See the *Setting the cluster node hostnames through DHCP* section for details about hostname considerations.

**NOTE**

If you are not using a DHCP service, the cluster nodes obtain their hostname through a reverse DNS lookup.

2. Ensure that your network infrastructure provides the required network connectivity between the cluster components. See the *Networking requirements for user-provisioned infrastructure* section for details about the requirements.
3. Configure your firewall to enable the ports required for the OpenShift Container Platform cluster components to communicate. See *Networking requirements for user-provisioned infrastructure* section for details about the ports that are required.

**IMPORTANT**

By default, port **1936** is accessible for an OpenShift Container Platform cluster, because each control plane node needs access to this port.

Avoid using the Ingress load balancer to expose this port, because doing so might result in the exposure of sensitive information, such as statistics and metrics, related to Ingress Controllers.

4. Setup the required DNS infrastructure for your cluster.
  - a. Configure DNS name resolution for the Kubernetes API, the application wildcard, the bootstrap machine, the control plane machines, and the compute machines.
  - b. Configure reverse DNS resolution for the Kubernetes API, the bootstrap machine, the control plane machines, and the compute machines.  
See the *User-provisioned DNS requirements* section for more information about the OpenShift Container Platform DNS requirements.
5. Validate your DNS configuration.
  - a. From your installation node, run DNS lookups against the record names of the Kubernetes API, the wildcard routes, and the cluster nodes. Validate that the IP addresses in the responses correspond to the correct components.
  - b. From your installation node, run reverse DNS lookups against the IP addresses of the load balancer and the cluster nodes. Validate that the record names in the responses correspond to the correct components.

See the *Validating DNS resolution for user-provisioned infrastructure* section for detailed DNS validation steps.

6. Provision the required API and application ingress load balancing infrastructure. See the *Load balancing requirements for user-provisioned infrastructure* section for more information about the requirements.



#### NOTE

Some load balancing solutions require the DNS name resolution for the cluster nodes to be in place before the load balancing is initialized.

### 22.1.5. Validating DNS resolution for user-provisioned infrastructure

You can validate your DNS configuration before installing OpenShift Container Platform on user-provisioned infrastructure.

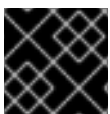

#### IMPORTANT

The validation steps detailed in this section must succeed before you install your cluster.

#### Prerequisites

- You have configured the required DNS records for your user-provisioned infrastructure.

#### Procedure

1. From your installation node, run DNS lookups against the record names of the Kubernetes API, the wildcard routes, and the cluster nodes. Validate that the IP addresses contained in the responses correspond to the correct components.
  - a. Perform a lookup against the Kubernetes API record name. Check that the result points to the IP address of the API load balancer:

```
$ dig +noall +answer @<nameserver_ip> api.<cluster_name>.<base_domain> 1
```

- 1 Replace **<nameserver\_ip>** with the IP address of the nameserver, **<cluster\_name>** with your cluster name, and **<base\_domain>** with your base domain name.

#### Example output

```
api.ocp4.example.com. 0 IN A 192.168.1.5
```

- b. Perform a lookup against the Kubernetes internal API record name. Check that the result points to the IP address of the API load balancer:

```
$ dig +noall +answer @<nameserver_ip> api-int.<cluster_name>.<base_domain>
```

#### Example output

```
api-int.ocp4.example.com. 0 IN A 192.168.1.5
```



- c. Test an example `*.apps.<cluster_name>.<base_domain>` DNS wildcard lookup. All of the application wildcard lookups must resolve to the IP address of the application ingress load balancer:

```
$ dig +noall +answer @<nameserver_ip> random.apps.<cluster_name>.<base_domain>
```

### Example output

```
random.apps.ocp4.example.com. 0 IN A 192.168.1.5
```



### NOTE

In the example outputs, the same load balancer is used for the Kubernetes API and application ingress traffic. In production scenarios, you can deploy the API and application ingress load balancers separately so that you can scale the load balancer infrastructure for each in isolation.

You can replace **random** with another wildcard value. For example, you can query the route to the OpenShift Container Platform console:

```
$ dig +noall +answer @<nameserver_ip> console-openshift-console.apps.<cluster_name>.<base_domain>
```

### Example output

```
console-openshift-console.apps.ocp4.example.com. 0 IN A 192.168.1.5
```

- d. Run a lookup against the bootstrap DNS record name. Check that the result points to the IP address of the bootstrap node:

```
$ dig +noall +answer @<nameserver_ip> bootstrap.<cluster_name>.<base_domain>
```

### Example output

```
bootstrap.ocp4.example.com. 0 IN A 192.168.1.96
```

- e. Use this method to perform lookups against the DNS record names for the control plane and compute nodes. Check that the results correspond to the IP addresses of each node.
2. From your installation node, run reverse DNS lookups against the IP addresses of the load balancer and the cluster nodes. Validate that the record names contained in the responses correspond to the correct components.
    - a. Perform a reverse lookup against the IP address of the API load balancer. Check that the response includes the record names for the Kubernetes API and the Kubernetes internal API:

```
$ dig +noall +answer @<nameserver_ip> -x 192.168.1.5
```

### Example output

```
5.1.168.192.in-addr.arpa. 0 IN PTR api-int.ocp4.example.com. 1
5.1.168.192.in-addr.arpa. 0 IN PTR api.ocp4.example.com. 2
```

- 1 Provides the record name for the Kubernetes internal API.
- 2 Provides the record name for the Kubernetes API.



#### NOTE

A PTR record is not required for the OpenShift Container Platform application wildcard. No validation step is needed for reverse DNS resolution against the IP address of the application ingress load balancer.

- b. Perform a reverse lookup against the IP address of the bootstrap node. Check that the result points to the DNS record name of the bootstrap node:

```
$ dig +noall +answer @<nameserver_ip> -x 192.168.1.96
```

#### Example output

```
96.1.168.192.in-addr.arpa. 0 IN PTR bootstrap.ocp4.example.com.
```

- c. Use this method to perform reverse lookups against the IP addresses for the control plane and compute nodes. Check that the results correspond to the DNS record names of each node.

### 22.1.6. Generating a key pair for cluster node SSH access

During an OpenShift Container Platform installation, you can provide an SSH public key to the installation program. The key is passed to the Red Hat Enterprise Linux CoreOS (RHCOS) nodes through their Ignition config files and is used to authenticate SSH access to the nodes. The key is added to the `~/.ssh/authorized_keys` list for the **core** user on each node, which enables password-less authentication.

After the key is passed to the nodes, you can use the key pair to SSH in to the RHCOS nodes as the user **core**. To access the nodes through SSH, the private key identity must be managed by SSH for your local user.

If you want to SSH in to your cluster nodes to perform installation debugging or disaster recovery, you must provide the SSH public key during the installation process. The `./openshift-install gather` command also requires the SSH public key to be in place on the cluster nodes.



#### IMPORTANT

Do not skip this procedure in production environments, where disaster recovery and debugging is required.



#### NOTE

You must use a local key, not one that you configured with platform-specific approaches such as [AWS key pairs](#).

## Procedure

1. If you do not have an existing SSH key pair on your local machine to use for authentication onto your cluster nodes, create one. For example, on a computer that uses a Linux operating system, run the following command:

```
$ ssh-keygen -t ed25519 -N "" -f <path>/<file_name> 1
```

- 1 Specify the path and file name, such as `~/.ssh/id_ed25519`, of the new SSH key. If you have an existing key pair, ensure your public key is in the your `~/.ssh` directory.

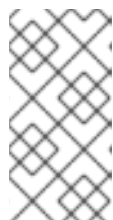

### NOTE

If you plan to install an OpenShift Container Platform cluster that uses FIPS validated or Modules In Process cryptographic libraries on the **x86\_64** architecture, do not create a key that uses the **ed25519** algorithm. Instead, create a key that uses the **rsa** or **ecdsa** algorithm.

2. View the public SSH key:

```
$ cat <path>/<file_name>.pub
```

For example, run the following to view the `~/.ssh/id_ed25519.pub` public key:

```
$ cat ~/.ssh/id_ed25519.pub
```

3. Add the SSH private key identity to the SSH agent for your local user, if it has not already been added. SSH agent management of the key is required for password-less SSH authentication onto your cluster nodes, or if you want to use the `./openshift-install gather` command.



### NOTE

On some distributions, default SSH private key identities such as `~/.ssh/id_rsa` and `~/.ssh/id_dsa` are managed automatically.

- a. If the **ssh-agent** process is not already running for your local user, start it as a background task:

```
$ eval "$(ssh-agent -s)"
```

### Example output

```
Agent pid 31874
```



### NOTE

If your cluster is in FIPS mode, only use FIPS-compliant algorithms to generate the SSH key. The key must be either RSA or ECDSA.

4. Add your SSH private key to the **ssh-agent**:

■

```
$ ssh-add <path>/<file_name> 1
```

- 1 Specify the path and file name for your SSH private key, such as `~/.ssh/id_ed25519`

### Example output

```
Identity added: /home/<you>/<path>/<file_name> (<computer_name>)
```

### Next steps

- When you install OpenShift Container Platform, provide the SSH public key to the installation program. If you install a cluster on infrastructure that you provision, you must provide the key to the installation program.

## 22.1.7. Obtaining the installation program

Before you install OpenShift Container Platform, download the installation file on a local computer.

### Prerequisites

- You have a computer that runs Linux or macOS, with 500 MB of local disk space

### Procedure

1. Access the [Infrastructure Provider](#) page on the OpenShift Cluster Manager site. If you have a Red Hat account, log in with your credentials. If you do not, create an account.
2. Select your infrastructure provider.
3. Navigate to the page for your installation type, download the installation program that corresponds with your host operating system and architecture, and place the file in the directory where you will store the installation configuration files.

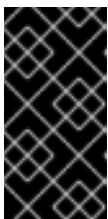

#### IMPORTANT

The installation program creates several files on the computer that you use to install your cluster. You must keep the installation program and the files that the installation program creates after you finish installing the cluster. Both files are required to delete the cluster.

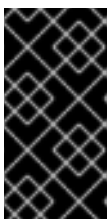

#### IMPORTANT

Deleting the files created by the installation program does not remove your cluster, even if the cluster failed during installation. To remove your cluster, complete the OpenShift Container Platform uninstallation procedures for your specific cloud provider.

4. Extract the installation program. For example, on a computer that uses a Linux operating system, run the following command:

```
$ tar -xvf openshift-install-linux.tar.gz
```

5. Download your installation [pull secret from the Red Hat OpenShift Cluster Manager](#) . This pull secret allows you to authenticate with the services that are provided by the included authorities, including Quay.io, which serves the container images for OpenShift Container Platform components.

## 22.1.8. Installing the OpenShift CLI by downloading the binary

You can install the OpenShift CLI (**oc**) to interact with OpenShift Container Platform from a command-line interface. You can install **oc** on Linux, Windows, or macOS.



### IMPORTANT

If you installed an earlier version of **oc**, you cannot use it to complete all of the commands in OpenShift Container Platform 4.10. Download and install the new version of **oc**.

### Installing the OpenShift CLI on Linux

You can install the OpenShift CLI (**oc**) binary on Linux by using the following procedure.

#### Procedure

1. Navigate to the [OpenShift Container Platform downloads page](#) on the Red Hat Customer Portal.
2. Select the appropriate version in the **Version** drop-down menu.
3. Click **Download Now** next to the **OpenShift v4.10 Linux Client** entry and save the file.
4. Unpack the archive:

```
$ tar xvf <file>
```

5. Place the **oc** binary in a directory that is on your **PATH**.  
To check your **PATH**, execute the following command:

```
$ echo $PATH
```

After you install the OpenShift CLI, it is available using the **oc** command:

```
$ oc <command>
```

### Installing the OpenShift CLI on Windows

You can install the OpenShift CLI (**oc**) binary on Windows by using the following procedure.

#### Procedure

1. Navigate to the [OpenShift Container Platform downloads page](#) on the Red Hat Customer Portal.
2. Select the appropriate version in the **Version** drop-down menu.
3. Click **Download Now** next to the **OpenShift v4.10 Windows Client** entry and save the file.
4. Unzip the archive with a ZIP program.

5. Move the **oc** binary to a directory that is on your **PATH**.  
To check your **PATH**, open the command prompt and execute the following command:

```
C:\> path
```

After you install the OpenShift CLI, it is available using the **oc** command:

```
C:\> oc <command>
```

### Installing the OpenShift CLI on macOS

You can install the OpenShift CLI (**oc**) binary on macOS by using the following procedure.

#### Procedure

1. Navigate to the [OpenShift Container Platform downloads page](#) on the Red Hat Customer Portal.
2. Select the appropriate version in the **Version** drop-down menu.
3. Click **Download Now** next to the **OpenShift v4.10 MacOSX Client** entry and save the file.
4. Unpack and unzip the archive.
5. Move the **oc** binary to a directory on your PATH.  
To check your **PATH**, open a terminal and execute the following command:

```
$ echo $PATH
```

After you install the OpenShift CLI, it is available using the **oc** command:

```
$ oc <command>
```

## 22.1.9. Manually creating the installation configuration file

For user-provisioned installations of OpenShift Container Platform, you manually generate your installation configuration file.

#### Prerequisites

- You have an SSH public key on your local machine to provide to the installation program. The key will be used for SSH authentication onto your cluster nodes for debugging and disaster recovery.
- You have obtained the OpenShift Container Platform installation program and the pull secret for your cluster.

#### Procedure

1. Create an installation directory to store your required installation assets in:

```
$ mkdir <installation_directory>
```

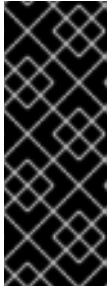
**IMPORTANT**

You must create a directory. Some installation assets, like bootstrap X.509 certificates have short expiration intervals, so you must not reuse an installation directory. If you want to reuse individual files from another cluster installation, you can copy them into your directory. However, the file names for the installation assets might change between releases. Use caution when copying installation files from an earlier OpenShift Container Platform version.

2. Customize the sample **install-config.yaml** file template that is provided and save it in the **<installation\_directory>**.

**NOTE**

You must name this configuration file **install-config.yaml**.

**NOTE**

For some platform types, you can alternatively run **./openshift-install create install-config --dir <installation\_directory>** to generate an **install-config.yaml** file. You can provide details about your cluster configuration at the prompts.

3. Back up the **install-config.yaml** file so that you can use it to install multiple clusters.

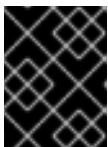
**IMPORTANT**

The **install-config.yaml** file is consumed during the next step of the installation process. You must back it up now.

**22.1.9.1. Sample install-config.yaml file for other platforms**

You can customize the **install-config.yaml** file to specify more details about your OpenShift Container Platform cluster's platform or modify the values of the required parameters.

```

apiVersion: v1
baseDomain: example.com 1
compute: 2
- hyperthreading: Enabled 3
  name: worker
  replicas: 0 4
controlPlane: 5
  hyperthreading: Enabled 6
  name: master
  replicas: 3 7
metadata:
  name: test 8
networking:
  clusterNetwork:
  - cidr: 10.128.0.0/14 9
    hostPrefix: 23 10
  networkType: OpenShiftSDN
  serviceNetwork: 11

```

```

- 172.30.0.0/16
platform:
  none: {} 12
  fips: false 13
  pullSecret: '{"auths": ...}' 14
  sshKey: 'ssh-ed25519 AAAA...' 15

```

- 1** The base domain of the cluster. All DNS records must be sub-domains of this base and include the cluster name.
- 2** **5** The **controlPlane** section is a single mapping, but the **compute** section is a sequence of mappings. To meet the requirements of the different data structures, the first line of the **compute** section must begin with a hyphen, -, and the first line of the **controlPlane** section must not. Only one control plane pool is used.
- 3** **6** Specifies whether to enable or disable simultaneous multithreading (SMT), or hyperthreading. By default, SMT is enabled to increase the performance of the cores in your machines. You can disable it by setting the parameter value to **Disabled**. If you disable SMT, you must disable it in all cluster machines; this includes both control plane and compute machines.



#### NOTE

Simultaneous multithreading (SMT) is enabled by default. If SMT is not enabled in your BIOS settings, the **hyperthreading** parameter has no effect.



#### IMPORTANT

If you disable **hyperthreading**, whether in the BIOS or in the **install-config.yaml** file, ensure that your capacity planning accounts for the dramatically decreased machine performance.

- 4** You must set this value to **0** when you install OpenShift Container Platform on user-provisioned infrastructure. In installer-provisioned installations, the parameter controls the number of compute machines that the cluster creates and manages for you. In user-provisioned installations, you must manually deploy the compute machines before you finish installing the cluster.



#### NOTE

If you are installing a three-node cluster, do not deploy any compute machines when you install the Red Hat Enterprise Linux CoreOS (RHCOS) machines.

- 7** The number of control plane machines that you add to the cluster. Because the cluster uses these values as the number of etcd endpoints in the cluster, the value must match the number of control plane machines that you deploy.
- 8** The cluster name that you specified in your DNS records.
- 9** A block of IP addresses from which pod IP addresses are allocated. This block must not overlap with existing physical networks. These IP addresses are used for the pod network. If you need to access the pods from an external network, you must configure load balancers and routers to manage the traffic.





## NOTE

Class E CIDR range is reserved for a future use. To use the Class E CIDR range, you must ensure your networking environment accepts the IP addresses within the Class E CIDR range.

- 10 The subnet prefix length to assign to each individual node. For example, if **hostPrefix** is set to **23**, then each node is assigned a **/23** subnet out of the given **cidr**, which allows for 510 ( $2^{(32 - 23)} - 2$ ) pod IP addresses. If you are required to provide access to nodes from an external network, configure load balancers and routers to manage the traffic.
- 11 The IP address pool to use for service IP addresses. You can enter only one IP address pool. This block must not overlap with existing physical networks. If you need to access the services from an external network, configure load balancers and routers to manage the traffic.
- 12 You must set the platform to **none**. You cannot provide additional platform configuration variables for your platform.



## IMPORTANT

Clusters that are installed with the platform type **none** are unable to use some features, such as managing compute machines with the Machine API. This limitation applies even if the compute machines that are attached to the cluster are installed on a platform that would normally support the feature. This parameter cannot be changed after installation.

- 13 Whether to enable or disable FIPS mode. By default, FIPS mode is not enabled. If FIPS mode is enabled, the Red Hat Enterprise Linux CoreOS (RHCOS) machines that OpenShift Container Platform runs on bypass the default Kubernetes cryptography suite and use the cryptography modules that are provided with RHCOS instead.



## IMPORTANT

To enable FIPS mode for your cluster, you must run the installation program from a Red Hat Enterprise Linux (RHEL) computer configured to operate in FIPS mode. For more information about configuring FIPS mode on RHEL, see [Installing the system in FIPS mode](#). The use of FIPS validated or Modules In Process cryptographic libraries is only supported on OpenShift Container Platform deployments on the **x86\_64** architecture.

- 14 The [pull secret from the Red Hat OpenShift Cluster Manager](#) . This pull secret allows you to authenticate with the services that are provided by the included authorities, including Quay.io, which serves the container images for OpenShift Container Platform components.
- 15 The SSH public key for the **core** user in Red Hat Enterprise Linux CoreOS (RHCOS).



## NOTE

For production OpenShift Container Platform clusters on which you want to perform installation debugging or disaster recovery, specify an SSH key that your **ssh-agent** process uses.

### 22.1.9.2. Configuring the cluster-wide proxy during installation

Production environments can deny direct access to the internet and instead have an HTTP or HTTPS proxy available. You can configure a new OpenShift Container Platform cluster to use a proxy by configuring the proxy settings in the **install-config.yaml** file.

#### Prerequisites

- You have an existing **install-config.yaml** file.
- You reviewed the sites that your cluster requires access to and determined whether any of them need to bypass the proxy. By default, all cluster egress traffic is proxied, including calls to hosting cloud provider APIs. You added sites to the **Proxy** object's **spec.noProxy** field to bypass the proxy if necessary.

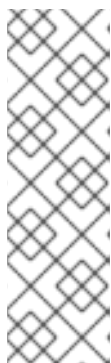

#### NOTE

The **Proxy** object **status.noProxy** field is populated with the values of the **networking.machineNetwork[].cidr**, **networking.clusterNetwork[].cidr**, and **networking.serviceNetwork[]** fields from your installation configuration.

For installations on Amazon Web Services (AWS), Google Cloud Platform (GCP), Microsoft Azure, and Red Hat OpenStack Platform (RHOSP), the **Proxy** object **status.noProxy** field is also populated with the instance metadata endpoint (**169.254.169.254**).

#### Procedure

1. Edit your **install-config.yaml** file and add the proxy settings. For example:

```
apiVersion: v1
baseDomain: my.domain.com
proxy:
  httpProxy: http://<username>:<pswd>@<ip>:<port> 1
  httpsProxy: https://<username>:<pswd>@<ip>:<port> 2
  noProxy: example.com 3
  additionalTrustBundle: | 4
    -----BEGIN CERTIFICATE-----
    <MY_TRUSTED_CA_CERT>
    -----END CERTIFICATE-----
  ...
```

- 1 A proxy URL to use for creating HTTP connections outside the cluster. The URL scheme must be **http**.
- 2 A proxy URL to use for creating HTTPS connections outside the cluster.
- 3 A comma-separated list of destination domain names, IP addresses, or other network CIDRs to exclude from proxying. Preface a domain with **.** to match subdomains only. For example, **.y.com** matches **x.y.com**, but not **y.com**. Use **\*** to bypass the proxy for all destinations.
- 4 If provided, the installation program generates a config map that is named **user-ca-bundle** in the **openshift-config** namespace that contains one or more additional CA certificates that are required for proxying HTTPS connections. The Cluster Network Operator then

creates a **trusted-ca-bundle** config map that merges these contents with the Red Hat Enterprise Linux CoreOS (RHCOS) trust bundle, and this config map is referenced in the **trustedCA** field of the **Proxy** object. The **additionalTrustBundle** field is required unless the proxy's identity certificate is signed by an authority from the RHCOS trust bundle.

**NOTE**

The installation program does not support the proxy **readinessEndpoints** field.

**NOTE**

If the installer times out, restart and then complete the deployment by using the **wait-for** command of the installer. For example:

```
$ ./openshift-install wait-for install-complete --log-level debug
```

2. Save the file and reference it when installing OpenShift Container Platform.

The installation program creates a cluster-wide proxy that is named **cluster** that uses the proxy settings in the provided **install-config.yaml** file. If no proxy settings are provided, a **cluster Proxy** object is still created, but it will have a nil **spec**.

**NOTE**

Only the **Proxy** object named **cluster** is supported, and no additional proxies can be created.

### 22.1.9.3. Configuring a three-node cluster

Optionally, you can deploy zero compute machines in a bare metal cluster that consists of three control plane machines only. This provides smaller, more resource efficient clusters for cluster administrators and developers to use for testing, development, and production.

In three-node OpenShift Container Platform environments, the three control plane machines are schedulable, which means that your application workloads are scheduled to run on them.

#### Prerequisites

- You have an existing **install-config.yaml** file.

#### Procedure

- Ensure that the number of compute replicas is set to **0** in your **install-config.yaml** file, as shown in the following **compute** stanza:

```
compute:
- name: worker
  platform: {}
  replicas: 0
```

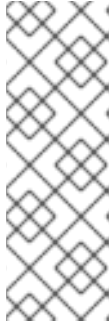

## NOTE

You must set the value of the **replicas** parameter for the compute machines to **0** when you install OpenShift Container Platform on user-provisioned infrastructure, regardless of the number of compute machines you are deploying. In installer-provisioned installations, the parameter controls the number of compute machines that the cluster creates and manages for you. This does not apply to user-provisioned installations, where the compute machines are deployed manually.

For three-node cluster installations, follow these next steps:

- If you are deploying a three-node cluster with zero compute nodes, the Ingress Controller pods run on the control plane nodes. In three-node cluster deployments, you must configure your application ingress load balancer to route HTTP and HTTPS traffic to the control plane nodes. See the *Load balancing requirements for user-provisioned infrastructure* section for more information.
- When you create the Kubernetes manifest files in the following procedure, ensure that the **mastersSchedulable** parameter in the `<installation_directory>/manifests/cluster-scheduler-02-config.yml` file is set to **true**. This enables your application workloads to run on the control plane nodes.
- Do not deploy any compute nodes when you create the Red Hat Enterprise Linux CoreOS (RHCOS) machines.

### 22.1.10. Creating the Kubernetes manifest and Ignition config files

Because you must modify some cluster definition files and manually start the cluster machines, you must generate the Kubernetes manifest and Ignition config files that the cluster needs to configure the machines.

The installation configuration file transforms into the Kubernetes manifests. The manifests wrap into the Ignition configuration files, which are later used to configure the cluster machines.

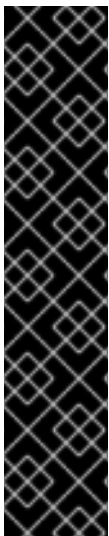

## IMPORTANT

- The Ignition config files that the OpenShift Container Platform installation program generates contain certificates that expire after 24 hours, which are then renewed at that time. If the cluster is shut down before renewing the certificates and the cluster is later restarted after the 24 hours have elapsed, the cluster automatically recovers the expired certificates. The exception is that you must manually approve the pending **node-bootstrapper** certificate signing requests (CSRs) to recover kubelet certificates. See the documentation for *Recovering from expired control plane certificates* for more information.
- It is recommended that you use Ignition config files within 12 hours after they are generated because the 24-hour certificate rotates from 16 to 22 hours after the cluster is installed. By using the Ignition config files within 12 hours, you can avoid installation failure if the certificate update runs during installation.

### Prerequisites

- You obtained the OpenShift Container Platform installation program.

- You created the **install-config.yaml** installation configuration file.

## Procedure

- Change to the directory that contains the OpenShift Container Platform installation program and generate the Kubernetes manifests for the cluster:

```
$ ./openshift-install create manifests --dir <installation_directory> 1
```

- For **<installation\_directory>**, specify the installation directory that contains the **install-config.yaml** file you created.



### WARNING

If you are installing a three-node cluster, skip the following step to allow the control plane nodes to be schedulable.



### IMPORTANT

When you configure control plane nodes from the default unschedulable to schedulable, additional subscriptions are required. This is because control plane nodes then become worker nodes.

- Check that the **mastersSchedulable** parameter in the **<installation\_directory>/manifests/cluster-scheduler-02-config.yml** Kubernetes manifest file is set to **false**. This setting prevents pods from being scheduled on the control plane machines:
  - Open the **<installation\_directory>/manifests/cluster-scheduler-02-config.yml** file.
  - Locate the **mastersSchedulable** parameter and ensure that it is set to **false**.
  - Save and exit the file.
- To create the Ignition configuration files, run the following command from the directory that contains the installation program:

```
$ ./openshift-install create ignition-configs --dir <installation_directory> 1
```

- For **<installation\_directory>**, specify the same installation directory.

Ignition config files are created for the bootstrap, control plane, and compute nodes in the installation directory. The **kubeadmin-password** and **kubeconfig** files are created in the **./<installation\_directory>/auth** directory:

```
.
├── auth
│   ├── kubeadmin-password
```

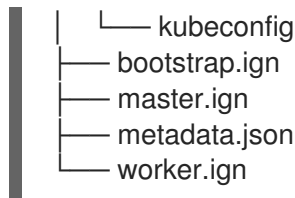

### 22.1.11. Installing RHCOS and starting the OpenShift Container Platform bootstrap process

To install OpenShift Container Platform on bare metal infrastructure that you provision, you must install Red Hat Enterprise Linux CoreOS (RHCOS) on the machines. When you install RHCOS, you must provide the Ignition config file that was generated by the OpenShift Container Platform installation program for the type of machine you are installing. If you have configured suitable networking, DNS, and load balancing infrastructure, the OpenShift Container Platform bootstrap process begins automatically after the RHCOS machines have rebooted.

To install RHCOS on the machines, follow either the steps to use an ISO image or network PXE booting.



#### NOTE

The compute node deployment steps included in this installation document are RHCOS-specific. If you choose instead to deploy RHEL-based compute nodes, you take responsibility for all operating system life cycle management and maintenance, including performing system updates, applying patches, and completing all other required tasks. Only RHEL 8 compute machines are supported.

You can configure RHCOS during ISO and PXE installations by using the following methods:

- **Kernel arguments:** You can use kernel arguments to provide installation-specific information. For example, you can specify the locations of the RHCOS installation files that you uploaded to your HTTP server and the location of the Ignition config file for the type of node you are installing. For a PXE installation, you can use the **APPEND** parameter to pass the arguments to the kernel of the live installer. For an ISO installation, you can interrupt the live installation boot process to add the kernel arguments. In both installation cases, you can use special **coreos.inst.\*** arguments to direct the live installer, as well as standard installation boot arguments for turning standard kernel services on or off.
- **Ignition configs:** OpenShift Container Platform Ignition config files (**\*.ign**) are specific to the type of node you are installing. You pass the location of a bootstrap, control plane, or compute node Ignition config file during the RHCOS installation so that it takes effect on first boot. In special cases, you can create a separate, limited Ignition config to pass to the live system. That Ignition config could do a certain set of tasks, such as reporting success to a provisioning system after completing installation. This special Ignition config is consumed by the **coreos-installer** to be applied on first boot of the installed system. Do not provide the standard control plane and compute node Ignition configs to the live ISO directly.
- **coreos-installer:** You can boot the live ISO installer to a shell prompt, which allows you to prepare the permanent system in a variety of ways before first boot. In particular, you can run the **coreos-installer** command to identify various artifacts to include, work with disk partitions, and set up networking. In some cases, you can configure features on the live system and copy them to the installed system.

Whether to use an ISO or PXE install depends on your situation. A PXE install requires an available DHCP service and more preparation, but can make the installation process more automated. An ISO install is a more manual process and can be inconvenient if you are setting up more than a few machines.



Replace **bootstrap.ign** with **master.ign** or **worker.ign** in the command to validate that the Ignition config files for the control plane and compute nodes are also available.

- Although it is possible to obtain the RHCOS images that are required for your preferred method of installing operating system instances from the [RHCOS image mirror](#) page, the recommended way to obtain the correct version of your RHCOS images are from the output of **openshift-install** command:

```
$ openshift-install coreos print-stream-json | grep '\.iso[^\.]'
```

### Example output

```
"location": "<url>/art/storage/releases/rhcos-4.10-aarch64/<release>/aarch64/rhcos-
<release>-live.aarch64.iso",
"location": "<url>/art/storage/releases/rhcos-4.10-ppc64le/<release>/ppc64le/rhcos-
<release>-live.ppc64le.iso",
"location": "<url>/art/storage/releases/rhcos-4.10-s390x/<release>/s390x/rhcos-<release>-
live.s390x.iso",
"location": "<url>/art/storage/releases/rhcos-4.10/<release>/x86_64/rhcos-<release>-
live.x86_64.iso",
```



### IMPORTANT

The RHCOS images might not change with every release of OpenShift Container Platform. You must download images with the highest version that is less than or equal to the OpenShift Container Platform version that you install. Use the image versions that match your OpenShift Container Platform version if they are available. Use only ISO images for this procedure. RHCOS qcow2 images are not supported for this installation type.

ISO file names resemble the following example:

**rhcos-<version>-live.<architecture>.iso**

- Use the ISO to start the RHCOS installation. Use one of the following installation options:
  - Burn the ISO image to a disk and boot it directly.
  - Use ISO redirection by using a lights-out management (LOM) interface.
- Boot the RHCOS ISO image without specifying any options or interrupting the live boot sequence. Wait for the installer to boot into a shell prompt in the RHCOS live environment.



### NOTE

It is possible to interrupt the RHCOS installation boot process to add kernel arguments. However, for this ISO procedure you should use the **coreos-installer** command as outlined in the following steps, instead of adding kernel arguments.

- Run the **coreos-installer** command and specify the options that meet your installation requirements. At a minimum, you must specify the URL that points to the Ignition config file for the node type, and the device that you are installing to:



```
$ sudo coreos-installer install --ignition-url=http://<HTTP_server>/<node_type>.ign <device>
--ignition-hash=sha512-<digest> 1 2
```

**1** You must run the **coreos-installer** command by using **sudo**, because the **core** user does not have the required root privileges to perform the installation.

**2** The **--ignition-hash** option is required when the Ignition config file is obtained through an HTTP URL to validate the authenticity of the Ignition config file on the cluster node. **<digest>** is the Ignition config file SHA512 digest obtained in a preceding step.



## NOTE

If you want to provide your Ignition config files through an HTTPS server that uses TLS, you can add the internal certificate authority (CA) to the system trust store before running **coreos-installer**.

The following example initializes a bootstrap node installation to the **/dev/sda** device. The Ignition config file for the bootstrap node is obtained from an HTTP web server with the IP address 192.168.1.2:

```
$ sudo coreos-installer install --ignition-
url=http://192.168.1.2:80/installation_directory/bootstrap.ign /dev/sda --ignition-hash=sha512-
a5a2d43879223273c9b60af66b44202a1d1248fc01cf156c46d4a79f552b6bad47bc8cc78ddf011
6e80c59d2ea9e32ba53bc807afbca581aa059311def2c3e3b
```

8. Monitor the progress of the RHCOS installation on the console of the machine.



## IMPORTANT

Be sure that the installation is successful on each node before commencing with the OpenShift Container Platform installation. Observing the installation process can also help to determine the cause of RHCOS installation issues that might arise.

9. After RHCOS installs, you must reboot the system. During the system reboot, it applies the Ignition config file that you specified.

10. Check the console output to verify that Ignition ran.

### Example command

```
Ignition: ran on 2022/03/14 14:48:33 UTC (this boot)
Ignition: user-provided config was applied
```

11. Continue to create the other machines for your cluster.



## IMPORTANT

You must create the bootstrap and control plane machines at this time. If the control plane machines are not made schedulable, also create at least two compute machines before you install OpenShift Container Platform.

If the required network, DNS, and load balancer infrastructure are in place, the OpenShift Container Platform bootstrap process begins automatically after the RHCOS nodes have rebooted.



#### NOTE

RHCOS nodes do not include a default password for the **core** user. You can access the nodes by running **ssh core@<node>.<cluster\_name>.<base\_domain>** as a user with access to the SSH private key that is paired to the public key that you specified in your **install\_config.yaml** file. OpenShift Container Platform 4 cluster nodes running RHCOS are immutable and rely on Operators to apply cluster changes. Accessing cluster nodes by using SSH is not recommended. However, when investigating installation issues, if the OpenShift Container Platform API is not available, or the kubelet is not properly functioning on a target node, SSH access might be required for debugging or disaster recovery.

### 22.1.11.2. Installing RHCOS by using PXE or iPXE booting

You can use PXE or iPXE booting to install RHCOS on the machines.

#### Prerequisites

- You have created the Ignition config files for your cluster.
- You have configured suitable network, DNS and load balancing infrastructure.
- You have configured suitable PXE or iPXE infrastructure.
- You have an HTTP server that can be accessed from your computer, and from the machines that you create.
- You have reviewed the *Advanced RHCOS installation configuration* section for different ways to configure features, such as networking and disk partitioning.

#### Procedure

1. Upload the bootstrap, control plane, and compute node Ignition config files that the installation program created to your HTTP server. Note the URLs of these files.



#### IMPORTANT

You can add or change configuration settings in your Ignition configs before saving them to your HTTP server. If you plan to add more compute machines to your cluster after you finish installation, do not delete these files.

2. From the installation host, validate that the Ignition config files are available on the URLs. The following example gets the Ignition config file for the bootstrap node:

```
$ curl -k http://<HTTP_server>/bootstrap.ign 1
```

#### Example output

```
% Total % Received % Xferd Average Speed Time Time Time Current
```

```

Dload Upload Total Spent Left Speed
0 0 0 0 0 0 0 0 --:--:-- --:--:-- --:--:-- 0{"ignition":
{"version":"3.2.0"},"passwd":{"users":[{"name":"core","sshAuthorizedKeys":["ssh-rsa...

```

Replace **bootstrap.ign** with **master.ign** or **worker.ign** in the command to validate that the Ignition config files for the control plane and compute nodes are also available.

- Although it is possible to obtain the RHCOS **kernel**, **initramfs** and **rootfs** files that are required for your preferred method of installing operating system instances from the [RHCOS image mirror](#) page, the recommended way to obtain the correct version of your RHCOS files are from the output of **openshift-install** command:

```
$ openshift-install coreos print-stream-json | grep -Eo "https.*(kernel-|initramfs-|rootfs-)\w+(\.img)?"
```

### Example output

```

"<url>/art/storage/releases/rhcos-4.10-aarch64/<release>/aarch64/rhcos-<release>-live-
kernel-aarch64"
"<url>/art/storage/releases/rhcos-4.10-aarch64/<release>/aarch64/rhcos-<release>-live-
initramfs.aarch64.img"
"<url>/art/storage/releases/rhcos-4.10-aarch64/<release>/aarch64/rhcos-<release>-live-
rootfs.aarch64.img"
"<url>/art/storage/releases/rhcos-4.10-ppc64le/49.84.202110081256-0/ppc64le/rhcos-
<release>-live-kernel-ppc64le"
"<url>/art/storage/releases/rhcos-4.10-ppc64le/<release>/ppc64le/rhcos-<release>-live-
initramfs.ppc64le.img"
"<url>/art/storage/releases/rhcos-4.10-ppc64le/<release>/ppc64le/rhcos-<release>-live-
rootfs.ppc64le.img"
"<url>/art/storage/releases/rhcos-4.10-s390x/<release>/s390x/rhcos-<release>-live-kernel-
s390x"
"<url>/art/storage/releases/rhcos-4.10-s390x/<release>/s390x/rhcos-<release>-live-
initramfs.s390x.img"
"<url>/art/storage/releases/rhcos-4.10-s390x/<release>/s390x/rhcos-<release>-live-
rootfs.s390x.img"
"<url>/art/storage/releases/rhcos-4.10/<release>/x86_64/rhcos-<release>-live-kernel-
x86_64"
"<url>/art/storage/releases/rhcos-4.10/<release>/x86_64/rhcos-<release>-live-
initramfs.x86_64.img"
"<url>/art/storage/releases/rhcos-4.10/<release>/x86_64/rhcos-<release>-live-
rootfs.x86_64.img"

```



### IMPORTANT

The RHCOS artifacts might not change with every release of OpenShift Container Platform. You must download images with the highest version that is less than or equal to the OpenShift Container Platform version that you install. Only use the appropriate **kernel**, **initramfs**, and **rootfs** artifacts described below for this procedure. RHCOS QCOW2 images are not supported for this installation type.

The file names contain the OpenShift Container Platform version number. They resemble the following examples:

- **kernel:** `rhcos-<version>-live-kernel-<architecture>`
- **initramfs:** `rhcos-<version>-live-initramfs.<architecture>.img`
- **rootfs:** `rhcos-<version>-live-rootfs.<architecture>.img`

4. Upload the **rootfs**, **kernel**, and **initramfs** files to your HTTP server.

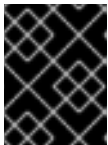

### IMPORTANT

If you plan to add more compute machines to your cluster after you finish installation, do not delete these files.

5. Configure the network boot infrastructure so that the machines boot from their local disks after RHCOS is installed on them.
6. Configure PXE or iPXE installation for the RHCOS images and begin the installation. Modify one of the following example menu entries for your environment and verify that the image and Ignition files are properly accessible:

- For PXE (**x86\_64**):

```

DEFAULT pxeboot
TIMEOUT 20
PROMPT 0
LABEL pxeboot
  KERNEL http://<HTTP_server>/rhcos-<version>-live-kernel-<architecture> 1
  APPEND initrd=http://<HTTP_server>/rhcos-<version>-live-initramfs.
<architecture>.img coreos.live.rootfs_url=http://<HTTP_server>/rhcos-<version>-live-
rootfs.<architecture>.img coreos.inst.install_dev=/dev/sda
coreos.inst.ignition_url=http://<HTTP_server>/bootstrap.ign 2 3

```

- 1** Specify the location of the live **kernel** file that you uploaded to your HTTP server. The URL must be HTTP, TFTP, or FTP; HTTPS and NFS are not supported.
- 2** If you use multiple NICs, specify a single interface in the **ip** option. For example, to use DHCP on a NIC that is named **eno1**, set **ip=eno1:dhcp**.
- 3** Specify the locations of the RHCOS files that you uploaded to your HTTP server. The **initrd** parameter value is the location of the **initramfs** file, the **coreos.live.rootfs\_url** parameter value is the location of the **rootfs** file, and the **coreos.inst.ignition\_url** parameter value is the location of the bootstrap Ignition config file. You can also add more kernel arguments to the **APPEND** line to configure networking or other boot options.



### NOTE

This configuration does not enable serial console access on machines with a graphical console. To configure a different console, add one or more **console=** arguments to the **APPEND** line. For example, add **console=tty0 console=ttyS0** to set the first PC serial port as the primary console and the graphical console as a secondary console. For more information, see [How does one set up a serial terminal and/or console in Red Hat Enterprise Linux?](#)

- For iPXE (**x86\_64** + **aarch64**):

```
kernel http://<HTTP_server>/rhcos-<version>-live-kernel-<architecture> initrd=main
coreos.live.rootfs_url=http://<HTTP_server>/rhcos-<version>-live-rootfs.
<architecture>.img coreos.inst.install_dev=/dev/sda
coreos.inst.ignition_url=http://<HTTP_server>/bootstrap.ign 1 2
initrd --name main http://<HTTP_server>/rhcos-<version>-live-initramfs.
<architecture>.img 3
boot
```

- 1 Specify the locations of the RHCOS files that you uploaded to your HTTP server. The **kernel** parameter value is the location of the **kernel** file, the **initrd=main** argument is needed for booting on UEFI systems, the **coreos.live.rootfs\_url** parameter value is the location of the **rootfs** file, and the **coreos.inst.ignition\_url** parameter value is the location of the bootstrap Ignition config file.
- 2 If you use multiple NICs, specify a single interface in the **ip** option. For example, to use DHCP on a NIC that is named **eno1**, set **ip=eno1:dhcp**.
- 3 Specify the location of the **initramfs** file that you uploaded to your HTTP server.



#### NOTE

This configuration does not enable serial console access on machines with a graphical console. To configure a different console, add one or more **console=** arguments to the **kernel** line. For example, add **console=tty0 console=ttyS0** to set the first PC serial port as the primary console and the graphical console as a secondary console. For more information, see [How does one set up a serial terminal and/or console in Red Hat Enterprise Linux?](#)



#### NOTE

To network boot the CoreOS **kernel** on **aarch64** architecture, you need to use a version of iPXE build with the **IMAGE\_GZIP** option enabled. See [IMAGE\\_GZIP option in iPXE](#).

- For PXE (with UEFI and Grub as second stage) on **aarch64**:

```
menuentry 'Install CoreOS' {
  linux rhcos-<version>-live-kernel-<architecture>
  coreos.live.rootfs_url=http://<HTTP_server>/rhcos-<version>-live-rootfs.
  <architecture>.img coreos.inst.install_dev=/dev/sda
  coreos.inst.ignition_url=http://<HTTP_server>/bootstrap.ign 1 2
  initrd rhcos-<version>-live-initramfs.<architecture>.img 3
}
```

- 1 Specify the locations of the RHCOS files that you uploaded to your HTTP/TFTP server. The **kernel** parameter value is the location of the **kernel** file on your TFTP server. The **coreos.live.rootfs\_url** parameter value is the location of the **rootfs** file, and the **coreos.inst.ignition\_url** parameter value is the location of the bootstrap Ignition config file on your HTTP Server.

- 2 If you use multiple NICs, specify a single interface in the **ip** option. For example, to use DHCP on a NIC that is named **eno1**, set **ip=eno1:dhcp**.
- 3 Specify the location of the **initramfs** file that you uploaded to your TFTP server.

7. Monitor the progress of the RHCOS installation on the console of the machine.

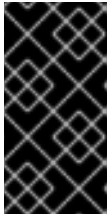

### IMPORTANT

Be sure that the installation is successful on each node before commencing with the OpenShift Container Platform installation. Observing the installation process can also help to determine the cause of RHCOS installation issues that might arise.

8. After RHCOS installs, the system reboots. During reboot, the system applies the Ignition config file that you specified.
9. Check the console output to verify that Ignition ran.

### Example command

```
Ignition: ran on 2022/03/14 14:48:33 UTC (this boot)
Ignition: user-provided config was applied
```

10. Continue to create the machines for your cluster.

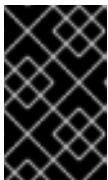

### IMPORTANT

You must create the bootstrap and control plane machines at this time. If the control plane machines are not made schedulable, also create at least two compute machines before you install the cluster.

If the required network, DNS, and load balancer infrastructure are in place, the OpenShift Container Platform bootstrap process begins automatically after the RHCOS nodes have rebooted.



### NOTE

RHCOS nodes do not include a default password for the **core** user. You can access the nodes by running **ssh core@<node>.<cluster\_name>.<base\_domain>** as a user with access to the SSH private key that is paired to the public key that you specified in your **install\_config.yaml** file. OpenShift Container Platform 4 cluster nodes running RHCOS are immutable and rely on Operators to apply cluster changes. Accessing cluster nodes by using SSH is not recommended. However, when investigating installation issues, if the OpenShift Container Platform API is not available, or the kubelet is not properly functioning on a target node, SSH access might be required for debugging or disaster recovery.

### 22.1.11.3. Advanced RHCOS installation configuration

A key benefit for manually provisioning the Red Hat Enterprise Linux CoreOS (RHCOS) nodes for OpenShift Container Platform is to be able to do configuration that is not available through default

OpenShift Container Platform installation methods. This section describes some of the configurations that you can do using techniques that include:

- Passing kernel arguments to the live installer
- Running **coreos-installer** manually from the live system
- Customizing a live ISO or PXE boot image

The advanced configuration topics for manual Red Hat Enterprise Linux CoreOS (RHCOS) installations detailed in this section relate to disk partitioning, networking, and using Ignition configs in different ways.

### 22.1.11.3.1. Using advanced networking options for PXE and ISO installations

Networking for OpenShift Container Platform nodes uses DHCP by default to gather all necessary configuration settings. To set up static IP addresses or configure special settings, such as bonding, you can do one of the following:

- Pass special kernel parameters when you boot the live installer.
- Use a machine config to copy networking files to the installed system.
- Configure networking from a live installer shell prompt, then copy those settings to the installed system so that they take effect when the installed system first boots.

To configure a PXE or iPXE installation, use one of the following options:

- See the "Advanced RHCOS installation reference" tables.
- Use a machine config to copy networking files to the installed system.

To configure an ISO installation, use the following procedure.

#### Procedure

1. Boot the ISO installer.
2. From the live system shell prompt, configure networking for the live system using available RHEL tools, such as **nmcli** or **nmtui**.
3. Run the **coreos-installer** command to install the system, adding the **--copy-network** option to copy networking configuration. For example:

```
$ sudo coreos-installer install --copy-network \
  --ignition-url=http://host/worker.ign /dev/sda
```



#### IMPORTANT

The **--copy-network** option only copies networking configuration found under **/etc/NetworkManager/system-connections**. In particular, it does not copy the system hostname.

4. Reboot into the installed system.

#### Additional resources

- See [Getting started with nmcli](#) and [Getting started with nmtui](#) in the RHEL 8 documentation for more information about the **nmcli** and **nmtui** tools.

### 22.1.11.3.2. Disk partitioning

The disk partitions are created on OpenShift Container Platform cluster nodes during the Red Hat Enterprise Linux CoreOS (RHCOS) installation. Each RHCOS node of a particular architecture uses the same partition layout, unless the default partitioning configuration is overridden. During the RHCOS installation, the size of the root file system is increased to use the remaining available space on the target device.

There are two cases where you might want to override the default partitioning when installing RHCOS on an OpenShift Container Platform cluster node:

- Creating separate partitions: For greenfield installations on an empty disk, you might want to add separate storage to a partition. This is officially supported for mounting **/var** or a subdirectory of **/var**, such as **/var/lib/etcd**, on a separate partition, but not both.

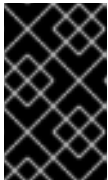

#### IMPORTANT

For disk sizes larger than 100GB, and especially disk sizes larger than 1TB, create a separate **/var** partition. See "Creating a separate **/var** partition" and this [Red Hat Knowledgebase article](#) for more information.

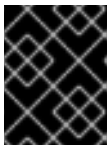

#### IMPORTANT

Kubernetes supports only two file system partitions. If you add more than one partition to the original configuration, Kubernetes cannot monitor all of them.

- Retaining existing partitions: For a brownfield installation where you are reinstalling OpenShift Container Platform on an existing node and want to retain data partitions installed from your previous operating system, there are both boot arguments and options to **coreos-installer** that allow you to retain existing data partitions.



#### WARNING

The use of custom partitions could result in those partitions not being monitored by OpenShift Container Platform or alerted on. If you are overriding the default partitioning, see [Understanding OpenShift File System Monitoring \(eviction conditions\)](#) for more information about how OpenShift Container Platform monitors your host file systems.

#### 22.1.11.3.2.1. Creating a separate **/var** partition

In general, you should use the default disk partitioning that is created during the RHCOS installation. However, there are cases where you might want to create a separate partition for a directory that you expect to grow.

OpenShift Container Platform supports the addition of a single partition to attach storage to either the **/var** directory or a subdirectory of **/var**. For example:



- **/var/lib/containers**: Holds container-related content that can grow as more images and containers are added to a system.
- **/var/lib/etcd**: Holds data that you might want to keep separate for purposes such as performance optimization of etcd storage.
- **/var**: Holds data that you might want to keep separate for purposes such as auditing.

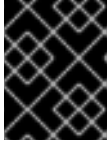

### IMPORTANT

For disk sizes larger than 100GB, and especially larger than 1TB, create a separate **/var** partition.

Storing the contents of a **/var** directory separately makes it easier to grow storage for those areas as needed and reinstall OpenShift Container Platform at a later date and keep that data intact. With this method, you will not have to pull all your containers again, nor will you have to copy massive log files when you update systems.

The use of a separate partition for the **/var** directory or a subdirectory of **/var** also prevents data growth in the partitioned directory from filling up the root file system.

The following procedure sets up a separate **/var** partition by adding a machine config manifest that is wrapped into the Ignition config file for a node type during the preparation phase of an installation.

### Procedure

1. On your installation host, change to the directory that contains the OpenShift Container Platform installation program and generate the Kubernetes manifests for the cluster:

```
$ openshift-install create manifests --dir <installation_directory>
```

2. Create a Butane config that configures the additional partition. For example, name the file **\$HOME/clusterconfig/98-var-partition.bu**, change the disk device name to the name of the storage device on the **worker** systems, and set the storage size as appropriate. This example places the **/var** directory on a separate partition:

```
variant: openshift
version: 4.10.0
metadata:
  labels:
    machineconfiguration.openshift.io/role: worker
  name: 98-var-partition
storage:
  disks:
    - device: /dev/<device_name> 1
      partitions:
        - label: var
          start_mib: <partition_start_offset> 2
          size_mib: <partition_size> 3
  filesystems:
    - device: /dev/disk/by-partlabel/var
      path: /var
```

```
format: xfs
mount_options: [defaults, prjquota] 4
with_mount_unit: true
```

- 1 The storage device name of the disk that you want to partition.
- 2 When adding a data partition to the boot disk, a minimum offset value of 25000 mebibytes is recommended. The root file system is automatically resized to fill all available space up to the specified offset. If no offset value is specified, or if the specified value is smaller than the recommended minimum, the resulting root file system will be too small, and future reinstalls of RHCOS might overwrite the beginning of the data partition.
- 3 The size of the data partition in mebibytes.
- 4 The **prjquota** mount option must be enabled for filesystems used for container storage.



#### NOTE

When creating a separate **/var** partition, you cannot use different instance types for compute nodes, if the different instance types do not have the same device name.

3. Create a manifest from the Butane config and save it to the **clusterconfig/openshift** directory. For example, run the following command:

```
$ butane $HOME/clusterconfig/98-var-partition.bu -o $HOME/clusterconfig/openshift/98-var-partition.yaml
```

4. Create the Ignition config files:

```
$ openshift-install create ignition-configs --dir <installation_directory> 1
```

- 1 For **<installation\_directory>**, specify the same installation directory.

Ignition config files are created for the bootstrap, control plane, and compute nodes in the installation directory:

```
.
├── auth
│   ├── kubeadmin-password
│   └── kubeconfig
├── bootstrap.ign
├── master.ign
├── metadata.json
└── worker.ign
```

The files in the **<installation\_directory>/manifest** and **<installation\_directory>/openshift** directories are wrapped into the Ignition config files, including the file that contains the **98-var-partition** custom **MachineConfig** object.

#### Next steps

- You can apply the custom disk partitioning by referencing the Ignition config files during the RHCOS installations.

### 22.1.11.3.2.2. Retaining existing partitions

For an ISO installation, you can add options to the **coreos-installer** command that cause the installer to maintain one or more existing partitions. For a PXE installation, you can add **coreos.inst.\*** options to the **APPEND** parameter to preserve partitions.

Saved partitions might be data partitions from an existing OpenShift Container Platform system. You can identify the disk partitions you want to keep either by partition label or by number.



#### NOTE

If you save existing partitions, and those partitions do not leave enough space for RHCOS, the installation will fail without damaging the saved partitions.

### Retaining existing partitions during an ISO installation

This example preserves any partition in which the partition label begins with **data** (**data\***):

```
# coreos-installer install --ignition-url http://10.0.2.2:8080/user.ign \
  --save-partlabel 'data*' /dev/sda
```

The following example illustrates running the **coreos-installer** in a way that preserves the sixth (6) partition on the disk:

```
# coreos-installer install --ignition-url http://10.0.2.2:8080/user.ign \
  --save-partindex 6 /dev/sda
```

This example preserves partitions 5 and higher:

```
# coreos-installer install --ignition-url http://10.0.2.2:8080/user.ign
  --save-partindex 5- /dev/sda
```

In the previous examples where partition saving is used, **coreos-installer** recreates the partition immediately.

### Retaining existing partitions during a PXE installation

This **APPEND** option preserves any partition in which the partition label begins with 'data' ('data\*'):

```
coreos.inst.save_partlabel=data*
```

This **APPEND** option preserves partitions 5 and higher:

```
coreos.inst.save_partindex=5-
```

This **APPEND** option preserves partition 6:

```
coreos.inst.save_partindex=6
```

### 22.1.11.3.3. Identifying Ignition configs

When doing an RHCOS manual installation, there are two types of Ignition configs that you can provide, with different reasons for providing each one:

- **Permanent install Ignition config:** Every manual RHCOS installation needs to pass one of the Ignition config files generated by **openshift-installer**, such as **bootstrap.ign**, **master.ign** and **worker.ign**, to carry out the installation.



### IMPORTANT

It is not recommended to modify these Ignition config files directly. You can update the manifest files that are wrapped into the Ignition config files, as outlined in examples in the preceding sections.

For PXE installations, you pass the Ignition configs on the **APPEND** line using the **coreos.inst.ignition\_url=** option. For ISO installations, after the ISO boots to the shell prompt, you identify the Ignition config on the **coreos-installer** command line with the **--ignition-url=** option. In both cases, only HTTP and HTTPS protocols are supported.

- **Live install Ignition config:** This type can be created by using the **coreos-installer customize** subcommand and its various options. With this method, the Ignition config passes to the live install medium, runs immediately upon booting, and performs setup tasks before or after the RHCOS system installs to disk. This method should only be used for performing tasks that must be done once and not applied again later, such as with advanced partitioning that cannot be done using a machine config.

For PXE or ISO boots, you can create the Ignition config and **APPEND** the **ignition.config.url=** option to identify the location of the Ignition config. You also need to append **ignition.firstboot** **ignition.platform.id=metal** or the **ignition.config.url** option will be ignored.

#### 22.1.11.3.4. Advanced RHCOS installation reference

This section illustrates the networking configuration and other advanced options that allow you to modify the Red Hat Enterprise Linux CoreOS (RHCOS) manual installation process. The following tables describe the kernel arguments and command-line options you can use with the RHCOS live installer and the **coreos-installer** command.

##### 22.1.11.3.4.1. Networking and bonding options for ISO installations

If you install RHCOS from an ISO image, you can add kernel arguments manually when you boot the image to configure networking for a node. If no networking arguments are specified, DHCP is activated in the initramfs when RHCOS detects that networking is required to fetch the Ignition config file.



### IMPORTANT

When adding networking arguments manually, you must also add the **rd.neednet=1** kernel argument to bring the network up in the initramfs.

The following table provides examples for configuring networking and bonding on your RHCOS nodes for ISO installations. The examples describe how to use the **ip=**, **nameserver=**, and **bond=** kernel arguments.



### NOTE

Ordering is important when adding the kernel arguments: **ip=**, **nameserver=**, and then **bond=**.

The networking options are passed to the **dracut** tool during system boot. For more information about the networking options supported by **dracut**, see the **dracut.cmdline** manual page.

The following examples are the networking options for ISO installation.

#### Configuring DHCP or static IP addresses

To configure an IP address, either use DHCP (**ip=dhcp**) or set an individual static IP address (**ip=<host\_ip>**). If setting a static IP, you must then identify the DNS server IP address (**nameserver=<dns\_ip>**) on each node. The following example sets:

- The node's IP address to **10.10.10.2**
- The gateway address to **10.10.10.254**
- The netmask to **255.255.255.0**
- The hostname to **core0.example.com**
- The DNS server address to **4.4.4.41**
- The auto-configuration value to **none**. No auto-configuration is required when IP networking is configured statically.

```
ip=10.10.10.2::10.10.10.254:255.255.255.0:core0.example.com:enp1s0:none
nameserver=4.4.4.41
```



#### NOTE

When you use DHCP to configure IP addressing for the RHCOS machines, the machines also obtain the DNS server information through DHCP. For DHCP-based deployments, you can define the DNS server address that is used by the RHCOS nodes through your DHCP server configuration.

#### Configuring an IP address without a static hostname

You can configure an IP address without assigning a static hostname. If a static hostname is not set by the user, it will be picked up and automatically set by a reverse DNS lookup. To configure an IP address without a static hostname refer to the following example:

- The node's IP address to **10.10.10.2**
- The gateway address to **10.10.10.254**
- The netmask to **255.255.255.0**
- The DNS server address to **4.4.4.41**
- The auto-configuration value to **none**. No auto-configuration is required when IP networking is configured statically.

```
ip=10.10.10.2::10.10.10.254:255.255.255.0::enp1s0:none
nameserver=4.4.4.41
```

#### Specifying multiple network interfaces

You can specify multiple network interfaces by setting multiple **ip=** entries.

```
ip=10.10.10.2::10.10.10.254:255.255.255.0:core0.example.com:enp1s0:none
ip=10.10.10.3::10.10.10.254:255.255.255.0:core0.example.com:enp2s0:none
```

Configuring default gateway and route

Optional: You can configure routes to additional networks by setting an **rd.route=** value.



#### NOTE

When you configure one or multiple networks, one default gateway is required. If the additional network gateway is different from the primary network gateway, the default gateway must be the primary network gateway.

- Run the following command to configure the default gateway:

```
ip=::10.10.10.254:::
```

- Enter the following command to configure the route for the additional network:

```
rd.route=20.20.20.0/24:20.20.20.254:enp2s0
```

Disabling DHCP on a single interface

You can disable DHCP on a single interface, such as when there are two or more network interfaces and only one interface is being used. In the example, the **enp1s0** interface has a static networking configuration and DHCP is disabled for **enp2s0**, which is not used:

```
ip=10.10.10.2::10.10.10.254:255.255.255.0:core0.example.com:enp1s0:none
ip=::::core0.example.com:enp2s0:none
```

Combining DHCP and static IP configurations

You can combine DHCP and static IP configurations on systems with multiple network interfaces, for example:

```
ip=enp1s0:dhcp
ip=10.10.10.2::10.10.10.254:255.255.255.0:core0.example.com:enp2s0:none
```

Configuring VLANs on individual interfaces

Optional: You can configure VLANs on individual interfaces by using the **vlan=** parameter.

- To configure a VLAN on a network interface and use a static IP address, run the following command:

```
ip=10.10.10.2::10.10.10.254:255.255.255.0:core0.example.com:enp2s0.100:none
vlan=enp2s0.100:enp2s0
```

- To configure a VLAN on a network interface and to use DHCP, run the following command:

```
ip=enp2s0.100:dhcp
vlan=enp2s0.100:enp2s0
```

Providing multiple DNS servers

You can provide multiple DNS servers by adding a **nameserver=** entry for each server, for example:

```
nameserver=1.1.1.1
nameserver=8.8.8.8
```

Bonding multiple network interfaces to a single interface

Optional: You can bond multiple network interfaces to a single interface by using the **bond=** option. Refer to the following examples:

- The syntax for configuring a bonded interface is: **bond=name[:network\_interfaces][:options]** *name* is the bonding device name (**bond0**), *network\_interfaces* represents a comma-separated list of physical (ethernet) interfaces (**em1,em2**), and *options* is a comma-separated list of bonding options. Enter **modinfo bonding** to see available options.
- When you create a bonded interface using **bond=**, you must specify how the IP address is assigned and other information for the bonded interface.
- To configure the bonded interface to use DHCP, set the bond's IP address to **dhcp**. For example:

```
bond=bond0:em1,em2:mode=active-backup
ip=bond0:dhcp
```

- To configure the bonded interface to use a static IP address, enter the specific IP address you want and related information. For example:

```
bond=bond0:em1,em2:mode=active-backup
ip=10.10.10.2::10.10.10.254:255.255.255.0:core0.example.com:bond0:none
```

Bonding multiple network interfaces to a single interface

Optional: You can configure VLANs on bonded interfaces by using the **vlan=** parameter and to use DHCP, for example:

```
ip=bond0.100:dhcp
bond=bond0:em1,em2:mode=active-backup
vlan=bond0.100:bond0
```

Use the following example to configure the bonded interface with a VLAN and to use a static IP address:

```
ip=10.10.10.2::10.10.10.254:255.255.255.0:core0.example.com:bond0.100:none
bond=bond0:em1,em2:mode=active-backup
vlan=bond0.100:bond0
```

Using network teaming

Optional: You can use a network teaming as an alternative to bonding by using the **team=** parameter:

- The syntax for configuring a team interface is: **team=name[:network\_interfaces]** *name* is the team device name (**team0**) and *network\_interfaces* represents a comma-separated list of physical (ethernet) interfaces (**em1, em2**).

Teaming is planned to be deprecated when RHCOS switches to an upcoming version of RHEL. For more information, see this [Red Hat Knowledgebase Article](#) .

Use the following example to configure a network team:

```
team=team0:em1,em2
ip=team0:dhcp
```

#### 22.1.11.3.4.2. coreos-installer options for ISO and PXE installations

You can install RHCOS by running **coreos-installer install <options> <device>** at the command prompt, after booting into the RHCOS live environment from an ISO image.

The following table shows the subcommands, options, and arguments you can pass to the **coreos-installer** command.

**Table 22.9. coreos-installer subcommands, command-line options, and arguments**

coreos-installer install subcommand	
<i>Subcommand</i>	<i>Description</i>
<b>\$ coreos-installer install &lt;options&gt; &lt;device&gt;</b>	Embed an Ignition config in an ISO image.
coreos-installer install subcommand options	
<i>Option</i>	<i>Description</i>
<b>-u, --image-url &lt;url&gt;</b>	Specify the image URL manually.
<b>-f, --image-file &lt;path&gt;</b>	Specify a local image file manually. Used for debugging.
<b>-i, --ignition-file &lt;path&gt;</b>	Embed an Ignition config from a file.
<b>-l, --ignition-url &lt;URL&gt;</b>	Embed an Ignition config from a URL.
<b>--ignition-hash &lt;digest&gt;</b>	Digest <b>type-value</b> of the Ignition config.
<b>-p, --platform &lt;name&gt;</b>	Override the Ignition platform ID for the installed system.
<b>--append-karg &lt;arg&gt;...</b>	Append a default kernel argument to the installed system.
<b>--delete-karg &lt;arg&gt;...</b>	Delete a default kernel argument from the installed system.



<b>-n, --copy-network</b>	Copy the network configuration from the install environment.
	 <p><b>IMPORTANT</b></p> <p>The <b>--copy-network</b> option only copies networking configuration found under <b>/etc/NetworkManager/system-connections</b>. In particular, it does not copy the system hostname.</p>
<b>--network-dir &lt;path&gt;</b>	For use with <b>-n</b> . Default is <b>/etc/NetworkManager/system-connections/</b> .
<b>--save-partlabel &lt;lx&gt;..</b>	Save partitions with this label glob.
<b>--save-partindex &lt;id&gt;...</b>	Save partitions with this number or range.
<b>--insecure</b>	Skip RHCOS image signature verification.
<b>--insecure-ignition</b>	Allow Ignition URL without HTTPS or hash.
<b>--architecture &lt;name&gt;</b>	Target CPU architecture. Valid values are <b>x86_64</b> and <b>aarch64</b> .
<b>--preserve-on-error</b>	Do not clear partition table on error.
<b>-h, --help</b>	Print help information.
<b>coreos-installer install subcommand argument</b>	
<i>Argument</i>	<i>Description</i>
<b>&lt;device&gt;</b>	The destination device.
<b>coreos-installer ISO subcommands</b>	
<i>Subcommand</i>	<i>Description</i>
<b>\$ coreos-installer iso customize &lt;options&gt; &lt;ISO_image&gt;</b>	Customize a RHCOS live ISO image.

<b>coreos-installer iso reset &lt;options&gt; &lt;ISO_image&gt;</b>	Restore a RHCOS live ISO image to default settings.
<b>coreos-installer iso ignition remove &lt;options&gt; &lt;ISO_image&gt;</b>	Remove the embedded Ignition config from an ISO image.
coreos-installer ISO customize subcommand options	
<i>Option</i>	<i>Description</i>
<b>--dest-ignition &lt;path&gt;</b>	Merge the specified Ignition config file into a new configuration fragment for the destination system.
<b>--dest-device &lt;path&gt;</b>	Install and overwrite the specified destination device.
<b>--dest-karg-append &lt;arg&gt;</b>	Add a kernel argument to each boot of the destination system.
<b>--dest-karg-delete &lt;arg&gt;</b>	Delete a kernel argument from each boot of the destination system.
<b>--network-keyfile &lt;path&gt;</b>	Configure networking by using the specified NetworkManager keyfile for live and destination systems.
<b>--ignition-ca &lt;path&gt;</b>	Specify an additional TLS certificate authority to be trusted by Ignition.
<b>--pre-install &lt;path&gt;</b>	Run the specified script before installation.
<b>--post-install &lt;path&gt;</b>	Run the specified script after installation.
<b>--installer-config &lt;path&gt;</b>	Apply the specified installer configuration file.
<b>--live-ignition &lt;path&gt;</b>	Merge the specified Ignition config file into a new configuration fragment for the live environment.
<b>--live-karg-append &lt;arg&gt;</b>	Add a kernel argument to each boot of the live environment.
<b>--live-karg-delete &lt;arg&gt;</b>	Delete a kernel argument from each boot of the live environment.
<b>--live-karg-replace &lt;k=o=n&gt;</b>	Replace a kernel argument in each boot of the live environment, in the form <b>key=old=new</b> .
<b>-f, --force</b>	Overwrite an existing Ignition config.

<b>-o, --output &lt;path&gt;</b>	Write the ISO to a new output file.
<b>-h, --help</b>	Print help information.
coreos-installer PXE subcommands	
<i>Subcommand</i>	<i>Description</i>
Note that not all of these options are accepted by all subcommands.	
<b>coreos-installer pxe customize &lt;options&gt; &lt;path&gt;</b>	Customize a RHCOS live PXE boot config.
<b>coreos-installer pxe ignition wrap &lt;options&gt;</b>	Wrap an Ignition config in an image.
<b>coreos-installer pxe ignition unwrap &lt;options&gt; &lt;image_name&gt;</b>	Show the wrapped Ignition config in an image.
coreos-installer PXE customize subcommand options	
<i>Option</i>	<i>Description</i>
Note that not all of these options are accepted by all subcommands.	
<b>--dest-ignition &lt;path&gt;</b>	Merge the specified Ignition config file into a new configuration fragment for the destination system.
<b>--dest-device &lt;path&gt;</b>	Install and overwrite the specified destination device.
<b>--network-keyfile &lt;path&gt;</b>	Configure networking by using the specified NetworkManager keyfile for live and destination systems.
<b>--ignition-ca &lt;path&gt;</b>	Specify an additional TLS certificate authority to be trusted by Ignition.
<b>--pre-install &lt;path&gt;</b>	Run the specified script before installation.
<b>post-install &lt;path&gt;</b>	Run the specified script after installation.
<b>--installer-config &lt;path&gt;</b>	Apply the specified installer configuration file.
<b>--live-ignition &lt;path&gt;</b>	Merge the specified Ignition config file into a new configuration fragment for the live environment.

<b>-o, --output &lt;path&gt;</b>	Write the initramfs to a new output file.   <b>NOTE</b> This option is required for PXE environments.
<b>-h, --help</b>	Print help information.

#### 22.1.11.3.4.3. coreos.inst boot options for ISO or PXE installations

You can automatically invoke **coreos-installer** options at boot time by passing **coreos.inst** boot arguments to the RHCOS live installer. These are provided in addition to the standard boot arguments.

- For ISO installations, the **coreos.inst** options can be added by interrupting the automatic boot at the bootloader menu. You can interrupt the automatic boot by pressing **TAB** while the **RHEL CoreOS (Live)** menu option is highlighted.
- For PXE or iPXE installations, the **coreos.inst** options must be added to the **APPEND** line before the RHCOS live installer is booted.

The following table shows the RHCOS live installer **coreos.inst** boot options for ISO and PXE installations.

Table 22.10. coreos.inst boot options

Argument	Description
<b>coreos.inst.install_dev</b>	Required. The block device on the system to install to. It is recommended to use the full path, such as <b>/dev/sda</b> , although <b>sda</b> is allowed.
<b>coreos.inst.ignition_url</b>	Optional: The URL of the Ignition config to embed into the installed system. If no URL is specified, no Ignition config is embedded. Only HTTP and HTTPS protocols are supported.
<b>coreos.inst.save_partlabel</b>	Optional: Comma-separated labels of partitions to preserve during the install. Glob-style wildcards are permitted. The specified partitions do not need to exist.
<b>coreos.inst.save_partindex</b>	Optional: Comma-separated indexes of partitions to preserve during the install. Ranges <b>m-n</b> are permitted, and either <b>m</b> or <b>n</b> can be omitted. The specified partitions do not need to exist.
<b>coreos.inst.insecure</b>	Optional: Permits the OS image that is specified by <b>coreos.inst.image_url</b> to be unsigned.

Argument	Description
<b>coreos.inst.image_url</b>	<p>Optional: Download and install the specified RHCOS image.</p> <ul style="list-style-type: none"> <li>• This argument should not be used in production environments and is intended for debugging purposes only.</li> <li>• While this argument can be used to install a version of RHCOS that does not match the live media, it is recommended that you instead use the media that matches the version you want to install.</li> <li>• If you are using <b>coreos.inst.image_url</b>, you must also use <b>coreos.inst.insecure</b>. This is because the bare-metal media are not GPG-signed for OpenShift Container Platform.</li> <li>• Only HTTP and HTTPS protocols are supported.</li> </ul>
<b>coreos.inst.skip_reboot</b>	<p>Optional: The system will not reboot after installing. After the install finishes, you will receive a prompt that allows you to inspect what is happening during installation. This argument should not be used in production environments and is intended for debugging purposes only.</p>
<b>coreos.inst.platform_id</b>	<p>Optional: The Ignition platform ID of the platform the RHCOS image is being installed on. Default is <b>metal</b>. This option determines whether or not to request an Ignition config from the cloud provider, such as VMware. For example: <b>coreos.inst.platform_id=vmware</b>.</p>
<b>ignition.config.url</b>	<p>Optional: The URL of the Ignition config for the live boot. For example, this can be used to customize how <b>coreos-installer</b> is invoked, or to run code before or after the installation. This is different from <b>coreos.inst.ignition_url</b>, which is the Ignition config for the installed system.</p>

#### 22.1.11.4. Updating the bootloader using bootupd

To update the bootloader by using **bootupd**, you must either install **bootupd** on RHCOS machines manually or provide a machine config with the enabled **systemd** unit. Unlike **grubby** or other bootloader tools, **bootupd** does not manage kernel space configuration such as passing kernel arguments.

After you have installed **bootupd**, you can manage it remotely from the OpenShift Container Platform cluster.



## NOTE

It is recommended that you use **bootupd** only on bare metal or virtualized hypervisor installations, such as for protection against the BootHole vulnerability.

## Manual install method

You can manually install **bootupd** by using the **bootctl** command-line tool.

1. Inspect the system status:

```
# bootupctl status
```

### Example output for x86\_64

```
Component EFI
Installed: grub2-efi-x64-1:2.04-31.fc33.x86_64,shim-x64-15-8.x86_64
Update: At latest version
```

### Example output for aarch64

```
Component EFI
Installed: grub2-efi-aa64-1:2.02-99.el8_4.1.aarch64,shim-aa64-15.4-2.el8_1.aarch64
Update: At latest version
```

2. RHCOS images created without **bootupd** installed on them require an explicit adoption phase. If the system status is **Adoptable**, perform the adoption:

```
# bootupctl adopt-and-update
```

### Example output

```
Updated: grub2-efi-x64-1:2.04-31.fc33.x86_64,shim-x64-15-8.x86_64
```

3. If an update is available, apply the update so that the changes take effect on the next reboot:

```
# bootupctl update
```

### Example output

```
Updated: grub2-efi-x64-1:2.04-31.fc33.x86_64,shim-x64-15-8.x86_64
```

## Machine config method

Another way to enable **bootupd** is by providing a machine config.

- Provide a machine config file with the enabled **systemd** unit, as shown in the following example:

### Example output

```

variant: rhcos
version: 1.1.0
systemd:
  units:
    - name: custom-bootupd-auto.service
      enabled: true
      contents: |
        [Unit]
        Description=Bootupd automatic update

        [Service]
        ExecStart=/usr/bin/bootupctl update
        RemainAfterExit=yes

        [Install]
        WantedBy=multi-user.target

```

## 22.1.12. Waiting for the bootstrap process to complete

The OpenShift Container Platform bootstrap process begins after the cluster nodes first boot into the persistent RHCOS environment that has been installed to disk. The configuration information provided through the Ignition config files is used to initialize the bootstrap process and install OpenShift Container Platform on the machines. You must wait for the bootstrap process to complete.

### Prerequisites

- You have created the Ignition config files for your cluster.
- You have configured suitable network, DNS and load balancing infrastructure.
- You have obtained the installation program and generated the Ignition config files for your cluster.
- You installed RHCOS on your cluster machines and provided the Ignition config files that the OpenShift Container Platform installation program generated.
- Your machines have direct internet access or have an HTTP or HTTPS proxy available.

### Procedure

1. Monitor the bootstrap process:

```

$ ./openshift-install --dir <installation_directory> wait-for bootstrap-complete \ 1
--log-level=info 2

```

1 For **<installation\_directory>**, specify the path to the directory that you stored the installation files in.

2 To view different installation details, specify **warn**, **debug**, or **error** instead of **info**.

### Example output

```

INFO Waiting up to 30m0s for the Kubernetes API at https://api.test.example.com:6443...

```

```
INFO API v1.23.0 up
INFO Waiting up to 30m0s for bootstrapping to complete...
INFO It is now safe to remove the bootstrap resources
```

The command succeeds when the Kubernetes API server signals that it has been bootstrapped on the control plane machines.

2. After bootstrap process is complete, remove the bootstrap machine from the load balancer.

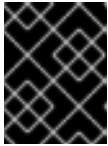

### IMPORTANT

You must remove the bootstrap machine from the load balancer at this point. You can also remove or reformat the bootstrap machine itself.

## 22.1.13. Logging in to the cluster by using the CLI

You can log in to your cluster as a default system user by exporting the cluster **kubeconfig** file. The **kubeconfig** file contains information about the cluster that is used by the CLI to connect a client to the correct cluster and API server. The file is specific to a cluster and is created during OpenShift Container Platform installation.

### Prerequisites

- You deployed an OpenShift Container Platform cluster.
- You installed the **oc** CLI.

### Procedure

1. Export the **kubeadmin** credentials:

```
$ export KUBECONFIG=<installation_directory>/auth/kubeconfig 1
```

- 1** For **<installation\_directory>**, specify the path to the directory that you stored the installation files in.

2. Verify you can run **oc** commands successfully using the exported configuration:

```
$ oc whoami
```

### Example output

```
system:admin
```

## 22.1.14. Approving the certificate signing requests for your machines

When you add machines to a cluster, two pending certificate signing requests (CSRs) are generated for each machine that you added. You must confirm that these CSRs are approved or, if necessary, approve them yourself. The client requests must be approved first, followed by the server requests.

### Prerequisites



- You added machines to your cluster.

## Procedure

1. Confirm that the cluster recognizes the machines:

```
$ oc get nodes
```

### Example output

```
NAME      STATUS    ROLES    AGE   VERSION
master-0  Ready     master   63m   v1.23.0
master-1  Ready     master   63m   v1.23.0
master-2  Ready     master   64m   v1.23.0
```

The output lists all of the machines that you created.



### NOTE

The preceding output might not include the compute nodes, also known as worker nodes, until some CSRs are approved.

2. Review the pending CSRs and ensure that you see the client requests with the **Pending** or **Approved** status for each machine that you added to the cluster:

```
$ oc get csr
```

### Example output

```
NAME      AGE   REQUESTOR                                     CONDITION
csr-8b2br  15m   system:serviceaccount:openshift-machine-config-operator:node-
bootstrapper  Pending
csr-8vnps  15m   system:serviceaccount:openshift-machine-config-operator:node-
bootstrapper  Pending
...
```

In this example, two machines are joining the cluster. You might see more approved CSRs in the list.

3. If the CSRs were not approved, after all of the pending CSRs for the machines you added are in **Pending** status, approve the CSRs for your cluster machines:



### NOTE

Because the CSRs rotate automatically, approve your CSRs within an hour of adding the machines to the cluster. If you do not approve them within an hour, the certificates will rotate, and more than two certificates will be present for each node. You must approve all of these certificates. After the client CSR is approved, the Kubelet creates a secondary CSR for the serving certificate, which requires manual approval. Then, subsequent serving certificate renewal requests are automatically approved by the **machine-approver** if the Kubelet requests a new certificate with identical parameters.

**NOTE**

For clusters running on platforms that are not machine API enabled, such as bare metal and other user-provisioned infrastructure, you must implement a method of automatically approving the kubelet serving certificate requests (CSRs). If a request is not approved, then the **oc exec**, **oc rsh**, and **oc logs** commands cannot succeed, because a serving certificate is required when the API server connects to the kubelet. Any operation that contacts the Kubelet endpoint requires this certificate approval to be in place. The method must watch for new CSRs, confirm that the CSR was submitted by the **node-bootstrap** service account in the **system:node** or **system:admin** groups, and confirm the identity of the node.

- To approve them individually, run the following command for each valid CSR:

```
$ oc adm certificate approve <csr_name> 1
```

- 1** **<csr\_name>** is the name of a CSR from the list of current CSRs.

- To approve all pending CSRs, run the following command:

```
$ oc get csr -o go-template='{{range .items}}{{if not .status}}{{.metadata.name}}{\n"}\n{{end}}' | xargs --no-run-if-empty oc adm certificate approve
```

**NOTE**

Some Operators might not become available until some CSRs are approved.

- Now that your client requests are approved, you must review the server requests for each machine that you added to the cluster:

```
$ oc get csr
```

**Example output**

```
NAME      AGE   REQUESTOR                                     CONDITION
csr-bfd72 5m26s system:node:ip-10-0-50-126.us-east-2.compute.internal
Pending
csr-c57lv 5m26s system:node:ip-10-0-95-157.us-east-2.compute.internal
Pending
...
```

- If the remaining CSRs are not approved, and are in the **Pending** status, approve the CSRs for your cluster machines:

- To approve them individually, run the following command for each valid CSR:

```
$ oc adm certificate approve <csr_name> 1
```

- 1** **<csr\_name>** is the name of a CSR from the list of current CSRs.

- To approve all pending CSRs, run the following command:

```
$ oc get csr -o go-template='{{range .items}}{{if not .status}}{{.metadata.name}}{\n"}\n{{end}}\n{{end}}' | xargs oc adm certificate approve
```

6. After all client and server CSRs have been approved, the machines have the **Ready** status. Verify this by running the following command:

```
$ oc get nodes
```

### Example output

```
NAME      STATUS  ROLES  AGE  VERSION
master-0  Ready   master 73m  v1.23.0
master-1  Ready   master 73m  v1.23.0
master-2  Ready   master 74m  v1.23.0
worker-0  Ready   worker 11m  v1.23.0
worker-1  Ready   worker 11m  v1.23.0
```



### NOTE

It can take a few minutes after approval of the server CSRs for the machines to transition to the **Ready** status.

### Additional information

- For more information on CSRs, see [Certificate Signing Requests](#).

## 22.1.15. Initial Operator configuration

After the control plane initializes, you must immediately configure some Operators so that they all become available.

### Prerequisites

- Your control plane has initialized.

### Procedure

1. Watch the cluster components come online:

```
$ watch -n5 oc get clusteroperators
```

### Example output

NAME	VERSION	AVAILABLE	PROGRESSING	DEGRADED	SINCE
authentication	4.10.0	True	False	False	19m
baremetal	4.10.0	True	False	False	37m
cloud-credential	4.10.0	True	False	False	40m
cluster-autoscaler	4.10.0	True	False	False	37m
config-operator	4.10.0	True	False	False	38m

console	4.10.0	True	False	False	26m
csi-snapshot-controller	4.10.0	True	False	False	37m
dns	4.10.0	True	False	False	37m
etcd	4.10.0	True	False	False	36m
image-registry	4.10.0	True	False	False	31m
ingress	4.10.0	True	False	False	30m
insights	4.10.0	True	False	False	31m
kube-apiserver	4.10.0	True	False	False	26m
kube-controller-manager	4.10.0	True	False	False	36m
kube-scheduler	4.10.0	True	False	False	36m
kube-storage-version-migrator	4.10.0	True	False	False	37m
machine-api	4.10.0	True	False	False	29m
machine-approver	4.10.0	True	False	False	37m
machine-config	4.10.0	True	False	False	36m
marketplace	4.10.0	True	False	False	37m
monitoring	4.10.0	True	False	False	29m
network	4.10.0	True	False	False	38m
node-tuning	4.10.0	True	False	False	37m
openshift-apiserver	4.10.0	True	False	False	32m
openshift-controller-manager	4.10.0	True	False	False	30m
openshift-samples	4.10.0	True	False	False	32m
operator-lifecycle-manager	4.10.0	True	False	False	37m
operator-lifecycle-manager-catalog	4.10.0	True	False	False	37m
operator-lifecycle-manager-packageserver	4.10.0	True	False	False	32m
service-ca	4.10.0	True	False	False	38m
storage	4.10.0	True	False	False	37m

2. Configure the Operators that are not available.

### 22.1.15.1. Disabling the default OperatorHub sources

Operator catalogs that source content provided by Red Hat and community projects are configured for OperatorHub by default during an OpenShift Container Platform installation. In a restricted network environment, you must disable the default catalogs as a cluster administrator.

#### Procedure

- Disable the sources for the default catalogs by adding **disableAllDefaultSources: true** to the **OperatorHub** object:

```
$ oc patch OperatorHub cluster --type json \
  -p '[{"op": "add", "path": "/spec/disableAllDefaultSources", "value": true}]'
```

#### TIP

Alternatively, you can use the web console to manage catalog sources. From the **Administration** → **Cluster Settings** → **Configuration** → **OperatorHub** page, click the **Sources** tab, where you can create, delete, disable, and enable individual sources.

### 22.1.15.2. Image registry removed during installation

On platforms that do not provide shareable object storage, the OpenShift Image Registry Operator bootstraps itself as **Removed**. This allows **openshift-installer** to complete installations on these platform types.

After installation, you must edit the Image Registry Operator configuration to switch the **managementState** from **Removed** to **Managed**.

### 22.1.15.3. Image registry storage configuration

The Image Registry Operator is not initially available for platforms that do not provide default storage. After installation, you must configure your registry to use storage so that the Registry Operator is made available.

Instructions are shown for configuring a persistent volume, which is required for production clusters. Where applicable, instructions are shown for configuring an empty directory as the storage location, which is available for only non-production clusters.

Additional instructions are provided for allowing the image registry to use block storage types by using the **Recreate** rollout strategy during upgrades.

#### 22.1.15.3.1. Configuring registry storage for bare metal and other manual installations

As a cluster administrator, following installation you must configure your registry to use storage.

#### Prerequisites

- You have access to the cluster as a user with the **cluster-admin** role.
- You have a cluster that uses manually-provisioned Red Hat Enterprise Linux CoreOS (RHCOS) nodes, such as bare metal.
- You have provisioned persistent storage for your cluster, such as Red Hat OpenShift Data Foundation.



#### IMPORTANT

OpenShift Container Platform supports **ReadWriteOnce** access for image registry storage when you have only one replica. **ReadWriteOnce** access also requires that the registry uses the **Recreate** rollout strategy. To deploy an image registry that supports high availability with two or more replicas, **ReadWriteMany** access is required.

- Must have 100Gi capacity.

#### Procedure

1. To configure your registry to use storage, change the **spec.storage.pvc** in the **configs.imageregistry/cluster** resource.



#### NOTE

When using shared storage, review your security settings to prevent outside access.

2. Verify that you do not have a registry pod:

```
$ oc get pod -n openshift-image-registry -l docker-registry=default
```

### Example output

```
No resources found in openshift-image-registry namespace
```



#### NOTE

If you do have a registry pod in your output, you do not need to continue with this procedure.

3. Check the registry configuration:

```
$ oc edit configs.imageregistry.operator.openshift.io
```

### Example output

```
storage:
  pvc:
    claim:
```

Leave the **claim** field blank to allow the automatic creation of an **image-registry-storage** PVC.

4. Check the **clusteroperator** status:

```
$ oc get clusteroperator image-registry
```

### Example output

NAME	VERSION	AVAILABLE	PROGRESSING	DEGRADED	SINCE
image-registry	4.10	True	False	False	6h50m

5. Ensure that your registry is set to managed to enable building and pushing of images.

- Run:

```
$ oc edit configs.imageregistry/cluster
```

Then, change the line

```
managementState: Removed
```

to

```
managementState: Managed
```

#### 22.1.15.3.2. Configuring storage for the image registry in non-production clusters

You must configure storage for the Image Registry Operator. For non-production clusters, you can set the image registry to an empty directory. If you do so, all images are lost if you restart the registry.

#### Procedure

- To set the image registry storage to an empty directory:

```
$ oc patch configs.imageregistry.operator.openshift.io cluster --type merge --patch '{"spec": {"storage":{"emptyDir":{}}}'
```



### WARNING

Configure this option for only non-production clusters.

If you run this command before the Image Registry Operator initializes its components, the **oc patch** command fails with the following error:

```
Error from server (NotFound): configs.imageregistry.operator.openshift.io "cluster" not found
```

Wait a few minutes and run the command again.

#### 22.15.3.3. Configuring block registry storage

To allow the image registry to use block storage types during upgrades as a cluster administrator, you can use the **Recreate** rollout strategy.



### IMPORTANT

Block storage volumes, or block persistent volumes, are supported but not recommended for use with the image registry on production clusters. An installation where the registry is configured on block storage is not highly available because the registry cannot have more than one replica.

If you choose to use a block storage volume with the image registry, you must use a filesystem Persistent Volume Claim (PVC).

#### Procedure

1. To set the image registry storage as a block storage type, patch the registry so that it uses the **Recreate** rollout strategy and runs with only one ( **1** ) replica:

```
$ oc patch config.imageregistry.operator.openshift.io/cluster --type=merge -p '{"spec": {"rolloutStrategy":"Recreate","replicas":1}}'
```

2. Provision the PV for the block storage device, and create a PVC for that volume. The requested block volume uses the ReadWriteOnce (RWO) access mode.
3. Edit the registry configuration so that it references the correct PVC.

#### 22.16. Completing installation on user-provisioned infrastructure

After you complete the Operator configuration, you can finish installing the cluster on infrastructure that you provide.

## Prerequisites

- Your control plane has initialized.
- You have completed the initial Operator configuration.

## Procedure

1. Confirm that all the cluster components are online with the following command:

```
$ watch -n5 oc get clusteroperators
```

### Example output

NAME	VERSION	AVAILABLE	PROGRESSING	DEGRADED	SINCE
authentication	4.10.0	True	False	False	19m
baremetal	4.10.0	True	False	False	37m
cloud-credential	4.10.0	True	False	False	40m
cluster-autoscaler	4.10.0	True	False	False	37m
config-operator	4.10.0	True	False	False	38m
console	4.10.0	True	False	False	26m
csi-snapshot-controller	4.10.0	True	False	False	37m
dns	4.10.0	True	False	False	37m
etcd	4.10.0	True	False	False	36m
image-registry	4.10.0	True	False	False	31m
ingress	4.10.0	True	False	False	30m
insights	4.10.0	True	False	False	31m
kube-apiserver	4.10.0	True	False	False	26m
kube-controller-manager	4.10.0	True	False	False	36m
kube-scheduler	4.10.0	True	False	False	36m
kube-storage-version-migrator	4.10.0	True	False	False	37m
machine-api	4.10.0	True	False	False	29m
machine-approver	4.10.0	True	False	False	37m
machine-config	4.10.0	True	False	False	36m
marketplace	4.10.0	True	False	False	37m
monitoring	4.10.0	True	False	False	29m
network	4.10.0	True	False	False	38m
node-tuning	4.10.0	True	False	False	37m
openshift-apiserver	4.10.0	True	False	False	32m
openshift-controller-manager	4.10.0	True	False	False	30m
openshift-samples	4.10.0	True	False	False	32m
operator-lifecycle-manager	4.10.0	True	False	False	37m
operator-lifecycle-manager-catalog	4.10.0	True	False	False	37m
operator-lifecycle-manager-packageserver	4.10.0	True	False	False	32m
service-ca	4.10.0	True	False	False	38m
storage	4.10.0	True	False	False	37m

Alternatively, the following command notifies you when all of the clusters are available. It also retrieves and displays credentials:

```
$ ./openshift-install --dir <installation_directory> wait-for install-complete 1
```

- 1** For **<installation\_directory>**, specify the path to the directory that you stored the installation files in.



## Example output

```
INFO Waiting up to 30m0s for the cluster to initialize...
```

The command succeeds when the Cluster Version Operator finishes deploying the OpenShift Container Platform cluster from Kubernetes API server.



### IMPORTANT

- The Ignition config files that the installation program generates contain certificates that expire after 24 hours, which are then renewed at that time. If the cluster is shut down before renewing the certificates and the cluster is later restarted after the 24 hours have elapsed, the cluster automatically recovers the expired certificates. The exception is that you must manually approve the pending **node-bootstrapper** certificate signing requests (CSRs) to recover kubelet certificates. See the documentation for *Recovering from expired control plane certificates* for more information.
- It is recommended that you use Ignition config files within 12 hours after they are generated because the 24-hour certificate rotates from 16 to 22 hours after the cluster is installed. By using the Ignition config files within 12 hours, you can avoid installation failure if the certificate update runs during installation.

2. Confirm that the Kubernetes API server is communicating with the pods.

a. To view a list of all pods, use the following command:

```
$ oc get pods --all-namespaces
```

### Example output

```
NAMESPACE          NAME                                READY  STATUS
RESTARTS  AGE
openshift-apiserver-operator  openshift-apiserver-operator-85cb746d55-zqhs8  1/1
Running    1    9m
openshift-apiserver          apiserver-67b9g                                1/1  Running  0
3m
openshift-apiserver          apiserver-ljcmx                                1/1  Running  0
1m
openshift-apiserver          apiserver-z25h4                                1/1  Running  0
2m
openshift-authentication-operator  authentication-operator-69d5d8bf84-vh2n8      1/1
Running    0    5m
...
```

b. View the logs for a pod that is listed in the output of the previous command by using the following command:

```
$ oc logs <pod_name> -n <namespace> 1
```

- 1** Specify the pod name and namespace, as shown in the output of the previous command.

If the pod logs display, the Kubernetes API server can communicate with the cluster machines.

3. For an installation with Fibre Channel Protocol (FCP), additional steps are required to enable multipathing. Do not enable multipathing during installation.  
See "Enabling multipathing with kernel arguments on RHCOS" in the *Post-installation machine configuration tasks* documentation for more information.

### 22.1.17. Telemetry access for OpenShift Container Platform

In OpenShift Container Platform 4.10, the Telemetry service, which runs by default to provide metrics about cluster health and the success of updates, requires internet access. If your cluster is connected to the internet, Telemetry runs automatically, and your cluster is registered to [OpenShift Cluster Manager](#).

After you confirm that your [OpenShift Cluster Manager](#) inventory is correct, either maintained automatically by Telemetry or manually by using OpenShift Cluster Manager, [use subscription watch](#) to track your OpenShift Container Platform subscriptions at the account or multi-cluster level.

#### Additional resources

- See [About remote health monitoring](#) for more information about the Telemetry service

### 22.1.18. Next steps

- [Customize your cluster](#).
- If necessary, you can [opt out of remote health reporting](#) .
- [Set up your registry and configure registry storage](#) .

## CHAPTER 23. INSTALLATION CONFIGURATION

### 23.1. CUSTOMIZING NODES

OpenShift Container Platform supports both cluster-wide and per-machine configuration via Ignition, which allows arbitrary partitioning and file content changes to the operating system. In general, if a configuration file is documented in Red Hat Enterprise Linux (RHEL), then modifying it via Ignition is supported.

There are two ways to deploy machine config changes:

- Creating machine configs that are included in manifest files to start up a cluster during **openshift-install**.
- Creating machine configs that are passed to running OpenShift Container Platform nodes via the Machine Config Operator.

Additionally, modifying the reference config, such as the Ignition config that is passed to **coreos-installer** when installing bare-metal nodes allows per-machine configuration. These changes are currently not visible to the Machine Config Operator.

The following sections describe features that you might want to configure on your nodes in this way.

#### 23.1.1. Creating machine configs with Butane

Machine configs are used to configure control plane and worker machines by instructing machines how to create users and file systems, set up the network, install systemd units, and more.

Because modifying machine configs can be difficult, you can use Butane configs to create machine configs for you, thereby making node configuration much easier.

##### 23.1.1.1. About Butane

Butane is a command-line utility that OpenShift Container Platform uses to provide convenient, short-hand syntax for writing machine configs, as well as for performing additional validation of machine configs. The format of the Butane config file that Butane accepts is defined in the [OpenShift Butane config spec](#).

##### 23.1.1.2. Installing Butane

You can install the Butane tool (**butane**) to create OpenShift Container Platform machine configs from a command-line interface. You can install **butane** on Linux, Windows, or macOS by downloading the corresponding binary file.

#### TIP

Butane releases are backwards-compatible with older releases and with the Fedora CoreOS Config Transpiler (FCCT).

#### Procedure

1. Navigate to the Butane image download page at <https://mirror.openshift.com/pub/openshift-v4/clients/butane/>.

2. Get the **butane** binary:

- a. For the newest version of Butane, save the latest **butane** image to your current directory:

```
$ curl https://mirror.openshift.com/pub/openshift-v4/clients/butane/latest/butane --output butane
```

- b. Optional: For a specific type of architecture you are installing Butane on, such as aarch64 or ppc64le, indicate the appropriate URL. For example:

```
$ curl https://mirror.openshift.com/pub/openshift-v4/clients/butane/latest/butane-aarch64 --output butane
```

3. Make the downloaded binary file executable:

```
$ chmod +x butane
```

4. Move the **butane** binary file to a directory on your **PATH**.

To check your **PATH**, open a terminal and execute the following command:

```
$ echo $PATH
```

### Verification steps

- You can now use the Butane tool by running the **butane** command:

```
$ butane <butane_file>
```

### 23.1.1.3. Creating a MachineConfig object by using Butane

You can use Butane to produce a **MachineConfig** object so that you can configure worker or control plane nodes at installation time or via the Machine Config Operator.

#### Prerequisites

- You have installed the **butane** utility.

#### Procedure

1. Create a Butane config file. The following example creates a file named **99-worker-custom.bu** that configures the system console to show kernel debug messages and specifies custom settings for the chrony time service:

```
variant: openshift
version: 4.10.0
metadata:
  name: 99-worker-custom
  labels:
    machineconfiguration.openshift.io/role: worker
openshift:
  kernel_arguments:
    - loglevel=7
storage:
```

files:

```
- path: /etc/chrony.conf
  mode: 0644
  overwrite: true
  contents:
    inline: |
      pool 0.rhel.pool.ntp.org iburst
      driftfile /var/lib/chrony/drift
      makestep 1.0 3
      rtcsync
      logdir /var/log/chrony
```



## NOTE

The **99-worker-custom.bu** file is set to create a machine config for worker nodes. To deploy on control plane nodes, change the role from **worker** to **master**. To do both, you could repeat the whole procedure using different file names for the two types of deployments.

2. Create a **MachineConfig** object by giving Butane the file that you created in the previous step:

```
$ butane 99-worker-custom.bu -o ./99-worker-custom.yaml
```

A **MachineConfig** object YAML file is created for you to finish configuring your machines.

3. Save the Butane config in case you need to update the **MachineConfig** object in the future.
4. If the cluster is not running yet, generate manifest files and add the **MachineConfig** object YAML file to the **openshift** directory. If the cluster is already running, apply the file as follows:

```
$ oc create -f 99-worker-custom.yaml
```

## Additional resources

- [Adding kernel modules to nodes](#)
- [Encrypting and mirroring disks during installation](#)

### 23.1.2. Adding day-1 kernel arguments

Although it is often preferable to modify kernel arguments as a day-2 activity, you might want to add kernel arguments to all master or worker nodes during initial cluster installation. Here are some reasons you might want to add kernel arguments during cluster installation so they take effect before the systems first boot up:

- You want to disable a feature, such as SELinux, so it has no impact on the systems when they first come up.

**WARNING**

Disabling SELinux on RHCOS is not supported.

- You need to do some low-level network configuration before the systems start.

To add kernel arguments to master or worker nodes, you can create a **MachineConfig** object and inject that object into the set of manifest files used by Ignition during cluster setup.

For a listing of arguments you can pass to a RHEL 8 kernel at boot time, see [Kernel.org kernel parameters](https://kernel.org/kernel-parameters). It is best to only add kernel arguments with this procedure if they are needed to complete the initial OpenShift Container Platform installation.

**Procedure**

1. Change to the directory that contains the installation program and generate the Kubernetes manifests for the cluster:

```
$ ./openshift-install create manifests --dir <installation_directory>
```

2. Decide if you want to add kernel arguments to worker or control plane nodes.
3. In the **openshift** directory, create a file (for example, **99-openshift-machineconfig-master-kargs.yaml**) to define a **MachineConfig** object to add the kernel settings. This example adds a **loglevel=7** kernel argument to control plane nodes:

```
$ cat << EOF > 99-openshift-machineconfig-master-kargs.yaml
apiVersion: machineconfiguration.openshift.io/v1
kind: MachineConfig
metadata:
  labels:
    machineconfiguration.openshift.io/role: master
  name: 99-openshift-machineconfig-master-kargs
spec:
  kernelArguments:
    - loglevel=7
EOF
```

You can change **master** to **worker** to add kernel arguments to worker nodes instead. Create a separate YAML file to add to both master and worker nodes.

You can now continue on to create the cluster.

**23.1.3. Adding kernel modules to nodes**

For most common hardware, the Linux kernel includes the device driver modules needed to use that hardware when the computer starts up. For some hardware, however, modules are not available in Linux. Therefore, you must find a way to provide those modules to each host computer. This procedure describes how to do that for nodes in an OpenShift Container Platform cluster.

When a kernel module is first deployed by following these instructions, the module is made available for the current kernel. If a new kernel is installed, the `kmods-via-containers` software will rebuild and deploy the module so a compatible version of that module is available with the new kernel.

The way that this feature is able to keep the module up to date on each node is by:

- Adding a `systemd` service to each node that starts at boot time to detect if a new kernel has been installed and
- If a new kernel is detected, the service rebuilds the module and installs it to the kernel

For information on the software needed for this procedure, see the [kmods-via-containers](#) github site.

A few important issues to keep in mind:

- This procedure is Technology Preview.
- Software tools and examples are not yet available in official RPM form and can only be obtained for now from unofficial **github.com** sites noted in the procedure.
- Third-party kernel modules you might add through these procedures are not supported by Red Hat.
- In this procedure, the software needed to build your kernel modules is deployed in a RHEL 8 container. Keep in mind that modules are rebuilt automatically on each node when that node gets a new kernel. For that reason, each node needs access to a **yum** repository that contains the kernel and related packages needed to rebuild the module. That content is best provided with a valid RHEL subscription.

### 23.1.3.1. Building and testing the kernel module container

Before deploying kernel modules to your OpenShift Container Platform cluster, you can test the process on a separate RHEL system. Gather the kernel module's source code, the KVC framework, and the `kmod-via-containers` software. Then build and test the module. To do that on a RHEL 8 system, do the following:

#### Procedure

1. Register a RHEL 8 system:

```
# subscription-manager register
```

2. Attach a subscription to the RHEL 8 system:

```
# subscription-manager attach --auto
```

3. Install software that is required to build the software and container:

```
# yum install podman make git -y
```

4. Clone the **kmod-via-containers** repository:

- a. Create a folder for the repository:

```
$ mkdir kmods; cd kmods
```

- b. Clone the repository:

```
$ git clone https://github.com/kmods-via-containers/kmods-via-containers
```

5. Install a KVC framework instance on your RHEL 8 build host to test the module. This adds a **kmods-via-container** systemd service and loads it:

- a. Change to the **kmod-via-containers** directory:

```
$ cd kmods-via-containers/
```

- b. Install the KVC framework instance:

```
$ sudo make install
```

- c. Reload the systemd manager configuration:

```
$ sudo systemctl daemon-reload
```

6. Get the kernel module source code. The source code might be used to build a third-party module that you do not have control over, but is supplied by others. You will need content similar to the content shown in the **kvc-simple-kmod** example that can be cloned to your system as follows:

```
$ cd .. ; git clone https://github.com/kmods-via-containers/kvc-simple-kmod
```

7. Edit the configuration file, **simple-kmod.conf** file, in this example, and change the name of the Dockerfile to **Dockerfile.rhel**:

- a. Change to the **kvc-simple-kmod** directory:

```
$ cd kvc-simple-kmod
```

- b. Rename the Dockerfile:

```
$ cat simple-kmod.conf
```

### Example Dockerfile

```
KMOD_CONTAINER_BUILD_CONTEXT="https://github.com/kmods-via-containers/kvc-  
simple-kmod.git"  
KMOD_CONTAINER_BUILD_FILE=Dockerfile.rhel  
KMOD_SOFTWARE_VERSION=dd1a7d4  
KMOD_NAMES="simple-kmod simple-procfs-kmod"
```

8. Create an instance of **kmods-via-containers@.service** for your kernel module, **simple-kmod** in this example:

```
$ sudo make install
```

9. Enable the **kmods-via-containers@.service** instance:



```
$ sudo kmods-via-containers build simple-kmod $(uname -r)
```

10. Enable and start the systemd service:

```
$ sudo systemctl enable kmods-via-containers@simple-kmod.service --now
```

- a. Review the service status:

```
$ sudo systemctl status kmods-via-containers@simple-kmod.service
```

#### Example output

- `kmods-via-containers@simple-kmod.service` - Kmods Via Containers - simple-kmod  
Loaded: loaded (/etc/systemd/system/kmods-via-containers@.service;  
enabled; vendor preset: disabled)  
Active: active (exited) since Sun 2020-01-12 23:49:49 EST; 5s ago...

11. To confirm that the kernel modules are loaded, use the **lsmod** command to list the modules:

```
$ lsmod | grep simple_
```

#### Example output

```
simple_procfs_kmod 16384 0
simple_kmod 16384 0
```

12. Optional. Use other methods to check that the **simple-kmod** example is working:

- Look for a "Hello world" message in the kernel ring buffer with **dmesg**:

```
$ dmesg | grep 'Hello world'
```

#### Example output

```
[ 6420.761332] Hello world from simple_kmod.
```

- Check the value of **simple-procfs-kmod** in **/proc**:

```
$ sudo cat /proc/simple-procfs-kmod
```

#### Example output

```
simple-procfs-kmod number = 0
```

- Run the **spkut** command to get more information from the module:

```
$ sudo spkut 44
```

#### Example output

```

KVC: wrapper simple-kmod for 4.18.0-147.3.1.el8_1.x86_64
Running userspace wrapper using the kernel module container...
+ podman run -i --rm --privileged
  simple-kmod-dd1a7d4:4.18.0-147.3.1.el8_1.x86_64 spkut 44
simple-procfs-kmod number = 0
simple-procfs-kmod number = 44

```

Going forward, when the system boots this service will check if a new kernel is running. If there is a new kernel, the service builds a new version of the kernel module and then loads it. If the module is already built, it will just load it.

### 23.1.3.2. Provisioning a kernel module to OpenShift Container Platform

Depending on whether or not you must have the kernel module in place when OpenShift Container Platform cluster first boots, you can set up the kernel modules to be deployed in one of two ways:

- **Provision kernel modules at cluster install time (day-1)** You can create the content as a **MachineConfig** object and provide it to **openshift-install** by including it with a set of manifest files.
- **Provision kernel modules via Machine Config Operator (day-2)** If you can wait until the cluster is up and running to add your kernel module, you can deploy the kernel module software via the Machine Config Operator (MCO).

In either case, each node needs to be able to get the kernel packages and related software packages at the time that a new kernel is detected. There are a few ways you can set up each node to be able to obtain that content.

- Provide RHEL entitlements to each node.
- Get RHEL entitlements from an existing RHEL host, from the **/etc/pki/entitlement** directory and copy them to the same location as the other files you provide when you build your Ignition config.
- Inside the Dockerfile, add pointers to a **yum** repository containing the kernel and other packages. This must include new kernel packages as they are needed to match newly installed kernels.

#### 23.1.3.2.1. Provision kernel modules via a MachineConfig object

By packaging kernel module software with a **MachineConfig** object, you can deliver that software to worker or control plane nodes at installation time or via the Machine Config Operator.

#### Procedure

1. Register a RHEL 8 system:

```
# subscription-manager register
```

2. Attach a subscription to the RHEL 8 system:

```
# subscription-manager attach --auto
```

3. Install software needed to build the software:

```
-
```

```
# yum install podman make git -y
```

4. Create a directory to host the kernel module and tooling:

```
$ mkdir kmods; cd kmods
```

5. Get the **kmods-via-containers** software:

- a. Clone the **kmods-via-containers** repository:

```
$ git clone https://github.com/kmods-via-containers/kmods-via-containers
```

- b. Clone the **kvc-simple-kmod** repository:

```
$ git clone https://github.com/kmods-via-containers/kvc-simple-kmod
```

6. Get your module software. In this example, **kvc-simple-kmod** is used.

7. Create a fakeroot directory and populate it with files that you want to deliver via Ignition, using the repositories cloned earlier:

- a. Create the directory:

```
$ FAKEROOT=$(mktemp -d)
```

- b. Change to the **kmod-via-containers** directory:

```
$ cd kmods-via-containers
```

- c. Install the KVC framework instance:

```
$ make install DESTDIR=${FAKEROOT}/usr/local CONFDIR=${FAKEROOT}/etc/
```

- d. Change to the **kvc-simple-kmod** directory:

```
$ cd ../kvc-simple-kmod
```

- e. Create the instance:

```
$ make install DESTDIR=${FAKEROOT}/usr/local CONFDIR=${FAKEROOT}/etc/
```

8. Clone the fakeroot directory, replacing any symbolic links with copies of their targets, by running the following command:

```
$ cd .. && rm -rf kmod-tree && cp -Lpr ${FAKEROOT} kmod-tree
```

9. Create a Butane config file, **99-simple-kmod.bu**, that embeds the kernel module tree and enables the systemd service.

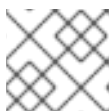

#### NOTE

See "Creating machine configs with Butane" for information about Butane.

```

variant: openshift
version: 4.10.0
metadata:
  name: 99-simple-kmod
  labels:
    machineconfiguration.openshift.io/role: worker 1
storage:
  trees:
    - local: kmod-tree
systemd:
  units:
    - name: kmods-via-containers@simple-kmod.service
      enabled: true

```

- 1** To deploy on control plane nodes, change **worker** to **master**. To deploy on both control plane and worker nodes, perform the remainder of these instructions once for each node type.

10. Use Butane to generate a machine config YAML file, **99-simple-kmod.yaml**, containing the files and configuration to be delivered:

```
$ butane 99-simple-kmod.bu --files-dir . -o 99-simple-kmod.yaml
```

11. If the cluster is not up yet, generate manifest files and add this file to the **openshift** directory. If the cluster is already running, apply the file as follows:

```
$ oc create -f 99-simple-kmod.yaml
```

Your nodes will start the **kmods-via-containers@simple-kmod.service** service and the kernel modules will be loaded.

12. To confirm that the kernel modules are loaded, you can log in to a node (using **oc debug node/<openshift-node>**, then **chroot /host**). To list the modules, use the **lsmod** command:

```
$ lsmod | grep simple_
```

### Example output

```

simple_procfs_kmod 16384 0
simple_kmod        16384 0

```

## 23.1.4. Encrypting and mirroring disks during installation

During an OpenShift Container Platform installation, you can enable boot disk encryption and mirroring on the cluster nodes.

### 23.1.4.1. About disk encryption

You can enable encryption for the boot disks on the control plane and compute nodes at installation time. OpenShift Container Platform supports the Trusted Platform Module (TPM) v2 and Tang encryption modes.

- TPM v2: This is the preferred mode. TPM v2 stores passphrases in a secure cryptoprocessor contained within a server. You can use this mode to prevent the boot disk data on a cluster node from being decrypted if the disk is removed from the server.
- Tang: Tang and Clevis are server and client components that enable network-bound disk encryption (NBDE). You can bind the boot disk data on your cluster nodes to one or more Tang servers. This prevents the data from being decrypted unless the nodes are on a secure network where the Tang servers can be accessed. Clevis is an automated decryption framework that is used to implement the decryption on the client side.



### IMPORTANT

The use of the Tang encryption mode to encrypt your disks is only supported for bare metal and vSphere installations on user-provisioned infrastructure.



### NOTE

On previous versions of Red Hat Enterprise Linux CoreOS (RHCOS), disk encryption was configured by specifying `/etc/clevis.json` in the Ignition config. That file is not supported in clusters created with OpenShift Container Platform 4.7 or above, and disk encryption should be configured by using the following procedure.

When the TPM v2 or Tang encryption modes are enabled, the RHCOS boot disks are encrypted using the LUKS2 format.

This feature:

- Is available for installer-provisioned infrastructure and user-provisioned infrastructure deployments
- Is supported on Red Hat Enterprise Linux CoreOS (RHCOS) systems only
- Sets up disk encryption during the manifest installation phase so all data written to disk, from first boot forward, is encrypted
- Requires no user intervention for providing passphrases
- Uses AES-256-XTS encryption, or AES-256-CBC if FIPS mode is enabled

#### 23.1.4.1.1. Configuring an encryption threshold

In OpenShift Container Platform, you can specify a requirement for more than one Tang server. You can also configure the TPM v2 and Tang encryption modes simultaneously, so that the boot disk data can be decrypted only if the TPM secure cryptoprocessor is present and the Tang servers can be accessed over a secure network.

You can use the **threshold** attribute in your Butane configuration to define the minimum number of TPM v2 and Tang encryption conditions that must be met for decryption to occur. The threshold is met when the stated value is reached through any combination of the declared conditions. For example, the **threshold** value of **2** in the following configuration can be reached by accessing the two Tang servers, or by accessing the TPM secure cryptoprocessor and one of the Tang servers:

#### Example Butane configuration for disk encryption

variant: openshift

```

version: 4.10.0
metadata:
  name: worker-storage
  labels:
    machineconfiguration.openshift.io/role: worker
boot_device:
  layout: x86_64
  luks:
    tpm2: true ①
    tang: ②
      - url: http://tang1.example.com:7500
        thumbprint: jwGN5tRFK-kF6pIX89ssF3khxxX
      - url: http://tang2.example.com:7500
        thumbprint: VCJsvZFjBSIHsldw78rOrq7h2ZF
    threshold: 2 ③
  openshift:
    fips: true

```

- ① Include this field if you want to use a Trusted Platform Module (TPM) to encrypt the root file system.
- ② Include this section if you want to use one or more Tang servers.
- ③ Specify the minimum number of TPM v2 and Tang encryption conditions that must be met for decryption to occur.

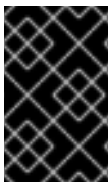

### IMPORTANT

The default **threshold** value is **1**. If you include multiple encryption conditions in your configuration but do not specify a threshold, decryption can occur if any of the conditions are met.



### NOTE

If you require both TPM v2 and Tang for decryption, the value of the **threshold** attribute must equal the total number of stated Tang servers plus one. If the **threshold** value is lower, it is possible for the threshold to be reached by using one of the encryption modes only. For example, if **tpm2** is set to **true** and you specify two Tang servers, a threshold of **2** can be met by accessing the two Tang servers even if the TPM secure cryptoprocessor is not available.

#### 23.1.4.2. About disk mirroring

During OpenShift Container Platform installation on control plane and worker nodes, you can enable mirroring of the boot and other disks to two or more redundant storage devices. A node continues to function after storage device failure as long as one device remains available.

Mirroring does not support replacement of a failed disk. To restore the mirror to a pristine, non-degraded state, reprovision the node.

**NOTE**

For user-provisioned infrastructure deployments, mirroring is available only on RHCOS systems. Support for mirroring is available on **x86\_64** nodes booted with BIOS or UEFI and on **ppc64le** nodes.

### 23.1.4.3. Configuring disk encryption and mirroring

You can enable and configure encryption and mirroring during an OpenShift Container Platform installation.

#### Prerequisites

- You have downloaded the OpenShift Container Platform installation program on your installation node.
- You installed Butane on your installation node.

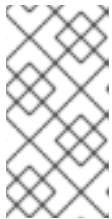
**NOTE**

Butane is a command-line utility that OpenShift Container Platform uses to provide convenient, short-hand syntax for writing machine configs, as well as for performing additional validation of machine configs. For more information, see the *Creating machine configs with Butane* section.

- You have access to a Red Hat Enterprise Linux (RHEL) 8 machine that can be used to generate a thumbprint of the Tang exchange key.

#### Procedure

1. If you want to use TPM v2 to encrypt your cluster, check to see if TPM v2 encryption needs to be enabled in the BIOS on each node. This is required on most Dell systems. Check the manual for your computer.
2. If you want to use Tang to encrypt your cluster, follow these preparatory steps:
  - a. Set up a Tang server or access an existing one. See [Network-bound disk encryption](#) for instructions.
  - b. Install the **clevis** package on a RHEL 8 machine, if it is not already installed:

```
$ sudo yum install clevis
```

- c. On the RHEL 8 machine, run the following command to generate a thumbprint of the exchange key. Replace **http://tang.example.com:7500** with the URL of your Tang server:

```
$ clevis-encrypt-tang '{"url":"http://tang.example.com:7500"}' < /dev/null > /dev/null 1
```

- 1** In this example, **tangd.socket** is listening on port **7500** on the Tang server.

**NOTE**

The **clevis-encrypt-tang** command is used in this step only to generate a thumbprint of the exchange key. No data is being passed to the command for encryption at this point, so **/dev/null** is provided as an input instead of plain text. The encrypted output is also sent to **/dev/null**, because it is not required for this procedure.

**Example output**

The advertisement contains the following signing keys:

PLjNyRdGw03zIRoGjQYMahSZGu9 **1**

- 1** The thumbprint of the exchange key.

When the **Do you wish to trust these keys? [ynYN]** prompt displays, type **Y**.

**NOTE**

RHEL 8 provides Clevis version 15, which uses the SHA-1 hash algorithm to generate thumbprints. Some other distributions provide Clevis version 17 or later, which use the SHA-256 hash algorithm for thumbprints. You must use a Clevis version that uses SHA-1 to create the thumbprint, to prevent Clevis binding issues when you install Red Hat Enterprise Linux CoreOS (RHCOS) on your OpenShift Container Platform cluster nodes.

- d. If the nodes are configured with static IP addressing, run **coreos-installer iso customize --dest-karg-append** or use the **coreos-installer --append-karg** option when installing RHCOS nodes to set the IP address of the installed system. Append the **ip=** and other arguments needed for your network.

**IMPORTANT**

Some methods for configuring static IPs do not affect the initramfs after the first boot and will not work with Tang encryption. These include the **coreos-installer --copy-network** option, the **coreos-installer iso customize --network-keyfile** option, and the **coreos-installer pxe customize --network-keyfile** option, as well as adding **ip=** arguments to the kernel command line of the live ISO or PXE image during installation. Incorrect static IP configuration causes the second boot of the node to fail.

3. On your installation node, change to the directory that contains the installation program and generate the Kubernetes manifests for the cluster:

```
$ ./openshift-install create manifests --dir <installation_directory> 1
```

- 1** Replace **<installation\_directory>** with the path to the directory that you want to store the installation files in.



4. Create a Butane config that configures disk encryption, mirroring, or both. For example, to configure storage for compute nodes, create a **\$HOME/clusterconfig/worker-storage.bu** file.

### Butane config example for a boot device

```

variant: openshift
version: 4.10.0
metadata:
  name: worker-storage 1
  labels:
    machineconfiguration.openshift.io/role: worker 2
boot_device:
  layout: x86_64 3
  luks: 4
  tpm2: true 5
  tang: 6
    - url: http://tang.example.com:7500 7
      thumbprint: PLjNyRdGw03zlRoGjQYMahSZGu9 8
  threshold: 1 9
  mirror: 10
  devices: 11
    - /dev/sda
    - /dev/sdb
openshift:
  fips: true 12

```

- 1 2 For control plane configurations, replace **worker** with **master** in both of these locations.
- 3 On ppc64le nodes, set this field to **ppc64le**. On all other nodes, this field can be omitted.
- 4 Include this section if you want to encrypt the root file system. For more details, see the *About disk encryption* section.
- 5 Include this field if you want to use a Trusted Platform Module (TPM) to encrypt the root file system.
- 6 Include this section if you want to use one or more Tang servers.
- 7 Specify the URL of a Tang server. In this example, **tangd.socket** is listening on port **7500** on the Tang server.
- 8 Specify the exchange key thumbprint, which was generated in a preceding step.
- 9 Specify the minimum number of TPM v2 and Tang encryption conditions that must be met for decryption to occur. The default value is **1**. For more information on this topic, see the *Configuring an encryption threshold* section.
- 10 Include this section if you want to mirror the boot disk. For more details, see *About disk mirroring*.
- 11 List all disk devices that should be included in the boot disk mirror, including the disk that RHCOS will be installed onto.
- 12 Include this directive to enable FIPS mode on your cluster.

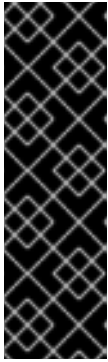

## IMPORTANT

To enable FIPS mode for your cluster, you must run the installation program from a Red Hat Enterprise Linux (RHEL) computer configured to operate in FIPS mode. For more information about configuring FIPS mode on RHEL, see [Installing the system in FIPS mode](#) . If you are configuring nodes to use both disk encryption and mirroring, both features must be configured in the same Butane configuration file. In addition, if you are configuring disk encryption on a node with FIPS mode enabled, you must include the **fips** directive in the same Butane configuration file, even if FIPS mode is also enabled in a separate manifest.

5. Create a control plane or compute node manifest from the corresponding Butane configuration file and save it to the **<installation\_directory>/openshift** directory. For example, to create a manifest for the compute nodes, run the following command:

```
$ butane $HOME/clusterconfig/worker-storage.bu -o <installation_directory>/openshift/99-
worker-storage.yaml
```

Repeat this step for each node type that requires disk encryption or mirroring.

6. Save the Butane configuration file in case you need to update the manifests in the future.
7. Continue with the remainder of the OpenShift Container Platform installation.

## TIP

You can monitor the console log on the RHCOS nodes during installation for error messages relating to disk encryption or mirroring.

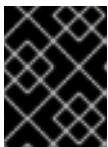

## IMPORTANT

If you configure additional data partitions, they will not be encrypted unless encryption is explicitly requested.

## Verification

After installing OpenShift Container Platform, you can verify if boot disk encryption or mirroring is enabled on the cluster nodes.

1. From the installation host, access a cluster node by using a debug pod:
  - a. Start a debug pod for the node. The following example starts a debug pod for the **compute-1** node:

```
$ oc debug node/compute-1
```

- b. Set **/host** as the root directory within the debug shell. The debug pod mounts the root file system of the node in **/host** within the pod. By changing the root directory to **/host**, you can run binaries contained in the executable paths on the node:

```
# chroot /host
```



## NOTE

OpenShift Container Platform cluster nodes running Red Hat Enterprise Linux CoreOS (RHCOS) are immutable and rely on Operators to apply cluster changes. Accessing cluster nodes using SSH is not recommended. However, if the OpenShift Container Platform API is not available, or **kubelet** is not properly functioning on the target node, **oc** operations will be impacted. In such situations, it is possible to access nodes using **ssh core@<node>.<cluster\_name>.<base\_domain>** instead.

2. If you configured boot disk encryption, verify if it is enabled:
  - a. From the debug shell, review the status of the root mapping on the node:

```
# cryptsetup status root
```

### Example output

```
/dev/mapper/root is active and is in use.
type: LUKS2 1
cipher: aes-xts-plain64 2
keysize: 512 bits
key location: keyring
device: /dev/sda4 3
sector size: 512
offset: 32768 sectors
size: 15683456 sectors
mode: read/write
```

- 1 The encryption format. When the TPM v2 or Tang encryption modes are enabled, the RHCOS boot disks are encrypted using the LUKS2 format.
- 2 The encryption algorithm used to encrypt the LUKS2 volume. The **aes-cbc-essiv:sha256** cipher is used if FIPS mode is enabled.
- 3 The device that contains the encrypted LUKS2 volume. If mirroring is enabled, the value will represent a software mirror device, for example **/dev/md126**.

- b. List the Clevis plugins that are bound to the encrypted device:

```
# clevis luks list -d /dev/sda4 1
```

- 1 Specify the device that is listed in the **device** field in the output of the preceding step.

### Example output

```
1: sss '{"t":1,"pins":{"tang":{"url":"http://tang.example.com:7500"}}}' 1
```

- 1 In the example output, the Tang plugin is used by the Shamir's Secret Sharing (SSS) Clevis plugin for the **/dev/sda4** device.

3. If you configured mirroring, verify if it is enabled:

a. From the debug shell, list the software RAID devices on the node:

```
# cat /proc/mdstat
```

### Example output

```
Personalities : [raid1]
md126 : active raid1 sdb3[1] sda3[0] 1
      393152 blocks super 1.0 [2/2] [UU]

md127 : active raid1 sda4[0] sdb4[1] 2
      51869632 blocks super 1.2 [2/2] [UU]

unused devices: <none>
```

- 1** In the example, the **/dev/md126** software RAID mirror device uses the **/dev/sda3** and **/dev/sdb3** disk devices on the cluster node.
- 2** In the example, the **/dev/md127** software RAID mirror device uses the **/dev/sda4** and **/dev/sdb4** disk devices on the cluster node.

b. Review the details of each of the software RAID devices listed in the output of the preceding command. The following example lists the details of the **/dev/md126** device:

```
# mdadm --detail /dev/md126
```

### Example output

```
/dev/md126:
  Version : 1.0
  Creation Time : Wed Jul 7 11:07:36 2021
  Raid Level : raid1 1
  Array Size : 393152 (383.94 MiB 402.59 MB)
  Used Dev Size : 393152 (383.94 MiB 402.59 MB)
  Raid Devices : 2
  Total Devices : 2
  Persistence : Superblock is persistent

  Update Time : Wed Jul 7 11:18:24 2021
  State : clean 2
  Active Devices : 2 3
  Working Devices : 2 4
  Failed Devices : 0 5
  Spare Devices : 0

  Consistency Policy : resync

  Name : any:md-boot 6
  UUID : ccfa3801:c520e0b5:2bee2755:69043055
  Events : 19
```

```

Number Major Minor RaidDevice State
 0   252    3    0   active sync  /dev/sda3 7
 1   252   19    1   active sync  /dev/sdb3 8

```

- 1** Specifies the RAID level of the device. **raid1** indicates RAID 1 disk mirroring.
- 2** Specifies the state of the RAID device.
- 3** **4** States the number of underlying disk devices that are active and working.
- 5** States the number of underlying disk devices that are in a failed state.
- 6** The name of the software RAID device.
- 7** **8** Provides information about the underlying disk devices that are used by the software RAID device.

- c. List the file systems that are mounted on the software RAID devices:

```
# mount | grep /dev/md
```

### Example output

```

/dev/md127 on / type xfs
(rw,relatime,seclabel,attr2,inode64,logbufs=8,logbsize=32k,prjquota)
/dev/md127 on /etc type xfs
(rw,relatime,seclabel,attr2,inode64,logbufs=8,logbsize=32k,prjquota)
/dev/md127 on /usr type xfs
(ro,relatime,seclabel,attr2,inode64,logbufs=8,logbsize=32k,prjquota)
/dev/md127 on /sysroot type xfs
(ro,relatime,seclabel,attr2,inode64,logbufs=8,logbsize=32k,prjquota)
/dev/md127 on /var type xfs
(rw,relatime,seclabel,attr2,inode64,logbufs=8,logbsize=32k,prjquota)
/dev/md127 on /var/lib/containers/storage/overlay type xfs
(rw,relatime,seclabel,attr2,inode64,logbufs=8,logbsize=32k,prjquota)
/dev/md127 on /var/lib/kubelet/pods/e5054ed5-f882-4d14-b599-99c050d4e0c0/volume-
subpaths/etc/tuned/1 type xfs
(rw,relatime,seclabel,attr2,inode64,logbufs=8,logbsize=32k,prjquota)
/dev/md127 on /var/lib/kubelet/pods/e5054ed5-f882-4d14-b599-99c050d4e0c0/volume-
subpaths/etc/tuned/2 type xfs
(rw,relatime,seclabel,attr2,inode64,logbufs=8,logbsize=32k,prjquota)
/dev/md127 on /var/lib/kubelet/pods/e5054ed5-f882-4d14-b599-99c050d4e0c0/volume-
subpaths/etc/tuned/3 type xfs
(rw,relatime,seclabel,attr2,inode64,logbufs=8,logbsize=32k,prjquota)
/dev/md127 on /var/lib/kubelet/pods/e5054ed5-f882-4d14-b599-99c050d4e0c0/volume-
subpaths/etc/tuned/4 type xfs
(rw,relatime,seclabel,attr2,inode64,logbufs=8,logbsize=32k,prjquota)
/dev/md127 on /var/lib/kubelet/pods/e5054ed5-f882-4d14-b599-99c050d4e0c0/volume-
subpaths/etc/tuned/5 type xfs
(rw,relatime,seclabel,attr2,inode64,logbufs=8,logbsize=32k,prjquota)
/dev/md126 on /boot type ext4 (rw,relatime,seclabel)

```

In the example output, the **/boot** file system is mounted on the **/dev/md126** software RAID device and the root file system is mounted on **/dev/md127**.

- Repeat the verification steps for each OpenShift Container Platform node type.

### Additional resources

- For more information about the TPM v2 and Tang encryption modes, see [Configuring automated unlocking of encrypted volumes using policy-based decryption](#).

#### 23.1.4.4. Configuring a RAID-enabled data volume

You can enable software RAID partitioning to provide an external data volume. OpenShift Container Platform supports RAID 0, RAID 1, RAID 4, RAID 5, RAID 6, and RAID 10 for data protection and fault tolerance. See "About disk mirroring" for more details.

### Prerequisites

- You have downloaded the OpenShift Container Platform installation program on your installation node.
- You have installed Butane on your installation node.



### NOTE

Butane is a command-line utility that OpenShift Container Platform uses to provide convenient, short-hand syntax for writing machine configs, as well as for performing additional validation of machine configs. For more information, see the *Creating machine configs with Butane* section.

### Procedure

- Create a Butane config that configures a data volume by using software RAID.
  - To configure a data volume with RAID 1 on the same disks that are used for a mirrored boot disk, create a `$HOME/clusterconfig/raid1-storage.bu` file, for example:

#### RAID 1 on mirrored boot disk

```
variant: openshift
version: 4.10.0
metadata:
  name: raid1-storage
  labels:
    machineconfiguration.openshift.io/role: worker
boot_device:
  mirror:
    devices:
      - /dev/sda
      - /dev/sdb
storage:
  disks:
    - device: /dev/sda
      partitions:
        - label: root-1
          size_mib: 25000 1
        - label: var-1
      - device: /dev/sdb
```

```

partitions:
  - label: root-2
    size_mib: 25000 2
  - label: var-2
raid:
  - name: md-var
    level: raid1
    devices:
      - /dev/disk/by-partlabel/var-1
      - /dev/disk/by-partlabel/var-2
filesystems:
  - device: /dev/md/md-var
    path: /var
    format: xfs
    wipe_filesystem: true
    with_mount_unit: true

```

- 1 2 When adding a data partition to the boot disk, a minimum value of 25000 mebibytes is recommended. If no value is specified, or if the specified value is smaller than the recommended minimum, the resulting root file system will be too small, and future reinstalls of RHCOS might overwrite the beginning of the data partition.

- To configure a data volume with RAID 1 on secondary disks, create a **\$HOME/clusterconfig/raid1-alt-storage.bu** file, for example:

### RAID 1 on secondary disks

```

variant: openshift
version: 4.10.0
metadata:
  name: raid1-alt-storage
  labels:
    machineconfiguration.openshift.io/role: worker
storage:
  disks:
    - device: /dev/sdc
      wipe_table: true
      partitions:
        - label: data-1
    - device: /dev/sdd
      wipe_table: true
      partitions:
        - label: data-2
  raid:
    - name: md-var-lib-containers
      level: raid1
      devices:
        - /dev/disk/by-partlabel/data-1
        - /dev/disk/by-partlabel/data-2
  filesystems:
    - device: /dev/md/md-var-lib-containers
      path: /var/lib/containers
      format: xfs
      wipe_filesystem: true
      with_mount_unit: true

```

- 2. Create a RAID manifest from the Butane config you created in the previous step and save it to the **<installation\_directory>/openshift** directory. For example, to create a manifest for the compute nodes, run the following command:

```
$ butane $HOME/clusterconfig/<butane_config>.bu -o
<installation_directory>/openshift/<manifest_name>.yaml 1
```

- 1 Replace **<butane\_config>** and **<manifest\_name>** with the file names from the previous step. For example, **raid1-alt-storage.bu** and **raid1-alt-storage.yaml** for secondary disks.

- 3. Save the Butane config in case you need to update the manifest in the future.
- 4. Continue with the remainder of the OpenShift Container Platform installation.

### 23.1.5. Configuring chrony time service

You can set the time server and related settings used by the chrony time service (**chronyd**) by modifying the contents of the **chrony.conf** file and passing those contents to your nodes as a machine config.

#### Procedure

- 1. Create a Butane config including the contents of the **chrony.conf** file. For example, to configure chrony on worker nodes, create a **99-worker-chrony.bu** file.



#### NOTE

See "Creating machine configs with Butane" for information about Butane.

```
variant: openshift
version: 4.10.0
metadata:
  name: 99-worker-chrony 1
  labels:
    machineconfiguration.openshift.io/role: worker 2
storage:
  files:
  - path: /etc/chrony.conf
    mode: 0644 3
    overwrite: true
    contents:
      inline: |
        pool 0.rhel.pool.ntp.org iburst 4
        driftfile /var/lib/chrony/drift
        makestep 1.0 3
        rtsync
        logdir /var/log/chrony
```

- 1 2 On control plane nodes, substitute **master** for **worker** in both of these locations.

3



Specify an octal value mode for the **mode** field in the machine config file. After creating the file and applying the changes, the **mode** is converted to a decimal value. You can check

- 4 Specify any valid, reachable time source, such as the one provided by your DHCP server. Alternately, you can specify any of the following NTP servers: **1.rhel.pool.ntp.org**, **2.rhel.pool.ntp.org**, or **3.rhel.pool.ntp.org**.

2. Use Butane to generate a **MachineConfig** object file, **99-worker-chrony.yaml**, containing the configuration to be delivered to the nodes:

```
$ butane 99-worker-chrony.bu -o 99-worker-chrony.yaml
```

3. Apply the configurations in one of two ways:

- If the cluster is not running yet, after you generate manifest files, add the **MachineConfig** object file to the **<installation\_directory>/openshift** directory, and then continue to create the cluster.
- If the cluster is already running, apply the file:

```
$ oc apply -f ./99-worker-chrony.yaml
```

### 23.1.6. Additional resources

- For information on Butane, see [Creating machine configs with Butane](#).
- For information on FIPS support, see [Support for FIPS cryptography](#).

## 23.2. CONFIGURING YOUR FIREWALL

If you use a firewall, you must configure it so that OpenShift Container Platform can access the sites that it requires to function. You must always grant access to some sites, and you grant access to more if you use Red Hat Insights, the Telemetry service, a cloud to host your cluster, and certain build strategies.

### 23.2.1. Configuring your firewall for OpenShift Container Platform

Before you install OpenShift Container Platform, you must configure your firewall to grant access to the sites that OpenShift Container Platform requires.

There are no special configuration considerations for services running on only controller nodes compared to worker nodes.



#### NOTE

If your environment has a dedicated load balancer in front of your OpenShift Container Platform cluster, review the allowlists between your firewall and load balancer to prevent unwanted network restrictions to your cluster.

#### Procedure

1. Allowlist the following registry URLs:

URL	Port	Function
<b>registry.redhat.io</b>	443, 80	Provides core container images
<b>access.redhat.com</b> <sup>[1]</sup>	443, 80	Hosts all the container images that are stored on the Red Hat Ecosystem Catalog, including core container images.
<b>quay.io</b>	443, 80	Provides core container images
<b>cdn.quay.io</b>	443, 80	Provides core container images
<b>cdn01.quay.io</b>	443, 80	Provides core container images
<b>cdn02.quay.io</b>	443, 80	Provides core container images
<b>cdn03.quay.io</b>	443, 80	Provides core container images
<b>sso.redhat.com</b>	443, 80	The <a href="https://console.redhat.com/openshift">https://console.redhat.com/openshift</a> site uses authentication from <b>sso.redhat.com</b> <small>[.small]</small>

1. In a firewall environment, ensure that the **access.redhat.com** resource is on the allowlist. This resource hosts a signature store that a container client requires for verifying images when pulling them from **registry.access.redhat.com**.

You can use the wildcard **\*.quay.io** instead of **cdn0[1-3].quay.io** in your allowlist. When you add a site, such as **quay.io**, to your allowlist, do not add a wildcard entry, such as **\*.quay.io**, to your denylist. In most cases, image registries use a content delivery network (CDN) to serve images. If a firewall blocks access, image downloads are denied when the initial download request redirects to a hostname such as **cdn01.quay.io**.

2. Allowlist any site that provides resources for a language or framework that your builds require.
3. If you do not disable Telemetry, you must grant access to the following URLs to access Red Hat Insights:

URL	Port	Function
<b>cert-api.access.redhat.com</b>	443, 80	Required for Telemetry
<b>api.access.redhat.com</b>	443, 80	Required for Telemetry
<b>infogw.api.openshift.com</b>	443, 80	Required for Telemetry

URL	Port	Function
<b>console.redhat.com/api/ingress,</b> <b>cloud.redhat.com/api/ingress</b>	443, 80	Required for Telemetry and for <b>insights-operator</b>

4. If you use Alibaba Cloud, Amazon Web Services (AWS), Microsoft Azure, or Google Cloud Platform (GCP) to host your cluster, you must grant access to the URLs that provide the cloud provider API and DNS for that cloud:

Cloud	URL	Port	Function
Alibaba	<b>*.aliyuncs.com</b>	443, 80	Required to access Alibaba Cloud services and resources. Review the <a href="#">Alibaba endpoints_config.go file</a> to determine the exact endpoints to allow for the regions that you use.
AWS	<b>*.amazonaws.com</b>  Alternatively, if you choose to not use a wildcard for AWS APIs, you must allowlist the following URLs:	443, 80	Required to access AWS services and resources. Review the <a href="#">AWS Service Endpoints</a> in the AWS documentation to determine the exact endpoints to allow for the regions that you use.
	<b>ec2.amazonaws.com</b>	443	Used to install and manage clusters in an AWS environment.
	<b>events.amazonaws.com</b>	443	Used to install and manage clusters in an AWS environment.
	<b>iam.amazonaws.com</b>	443	Used to install and manage clusters in an AWS environment.
	<b>route53.amazonaws.com</b>	443	Used to install and manage clusters in an AWS environment.
	<b>s3.amazonaws.com</b>	443	Used to install and manage clusters in an AWS environment.
	<b>s3.&lt;aws_region&gt;.amazonaws.com</b>	443	Used to install and manage clusters in an AWS environment.
	<b>s3.dualstack.&lt;aws_region&gt;.amazonaws.com</b>	443	Used to install and manage clusters in an AWS environment.
	<b>sts.amazonaws.com</b>	443	Used to install and manage clusters in an AWS environment.

Cloud	URL	Port	Function
	<b>sts.</b> <b>&lt;aws_region&gt;.amazonaws.com</b>	443	Used to install and manage clusters in an AWS environment.
	<b>tagging.us-east-1.</b> <b>amazonaws.com</b>	443	Used to install and manage clusters in an AWS environment. This endpoint is always <b>us-east-1</b> , regardless of the region the cluster is deployed in.
	<b>ec2.</b> <b>&lt;aws_region&gt;.amazonaws.com</b>	443	Used to install and manage clusters in an AWS environment.
	<b>elasticloadbalancing.</b> <b>&lt;aws_region&gt;.amazonaws.com</b>	443	Used to install and manage clusters in an AWS environment.
	<b>servicequotas.</b> <b>&lt;aws_region&gt;.amazonaws.com</b>	443, 80	Required. Used to confirm quotas for deploying the service.
	<b>tagging.</b> <b>&lt;aws_region&gt;.amazonaws.com</b>	443, 80	Allows the assignment of metadata about AWS resources in the form of tags.
GCP	<b>*.googleapis.com</b>	443, 80	Required to access GCP services and resources. Review <a href="#">Cloud Endpoints</a> in the GCP documentation to determine the endpoints to allow for your APIs.
	<b>accounts.google.com</b>	443, 80	Required to access your GCP account.
Azure	<b>management.azure.com</b>	443, 80	Required to access Azure services and resources. Review the <a href="#">Azure REST API reference</a> in the Azure documentation to determine the endpoints to allow for your APIs.
	<b>*.blob.core.windows.net</b>	443, 80	Required to download Ignition files.
	<b>login.microsoftonline.com</b>	443, 80	Required to access Azure services and resources. Review the <a href="#">Azure REST API reference</a> in the Azure documentation to determine the endpoints to allow for your APIs.

5. Allowlist the following URLs:

URL	Port	Function
<b>mirror.openshift.com</b>	443, 80	Required to access mirrored installation content and images. This site is also a source of release image signatures, although the Cluster Version Operator needs only a single functioning source.
<b>storage.googleapis.com/openshift-release</b>	443, 80	A source of release image signatures, although the Cluster Version Operator needs only a single functioning source.
<b>*.apps.&lt;cluster_name&gt;.&lt;base_domain&gt;</b>	443, 80	Required to access the default cluster routes unless you set an ingress wildcard during installation.
<b>quayio-production-s3.s3.amazonaws.com</b>	443, 80	Required to access Quay image content in AWS.
<b>api.openshift.com</b>	443, 80	Required both for your cluster token and to check if updates are available for the cluster.
<b>rhcos-redirector.apps.art.xq1c.p1.openshiftapps.com, rhcos.mirror.openshift.com</b>	443, 80	Required to download Red Hat Enterprise Linux CoreOS (RHCOS) images.
<b>console.redhat.com/openshift</b>	443, 80	Required for your cluster token.
<b>sso.redhat.com</b>	443, 80	The <a href="https://console.redhat.com/openshift">https://console.redhat.com/openshift</a> site uses authentication from <b>sso.redhat.com</b>

Operators require route access to perform health checks. Specifically, the authentication and web console Operators connect to two routes to verify that the routes work. If you are the cluster administrator and do not want to allow **\*.apps.<cluster\_name>.<base\_domain>**, then allow these routes:

- **oauth-openshift.apps.<cluster\_name>.<base\_domain>**

- **console-openshift-console.apps.<cluster\_name>.<base\_domain>**, or the hostname that is specified in the **spec.route.hostname** field of the **consoles.operator/cluster** object if the field is not empty.

6. Allowlist the following URLs for optional third-party content:

URL	Port	Function
<b>registry.connect.redhat.com</b>	443, 80	Required for all third-party images and certified operators.
<b>rhc4tp-prod-z8cxf-image-registry-us-east-1-evenkyleffocxqvofrk.s3.dualstack.us-east-1.amazonaws.com</b>	443, 80	Provides access to container images hosted on <b>registry.connect.redhat.com</b>
<b>oso-rhc4tp-docker-registry.s3-us-west-2.amazonaws.com</b>	443, 80	Required for Sonatype Nexus, F5 Big IP operators.

7. If you use a default Red Hat Network Time Protocol (NTP) server allow the following URLs:

- **1.rhel.pool.ntp.org**
- **2.rhel.pool.ntp.org**
- **3.rhel.pool.ntp.org**



#### NOTE

If you do not use a default Red Hat NTP server, verify the NTP server for your platform and allow it in your firewall.

## CHAPTER 24. VALIDATING AN INSTALLATION

You can check the status of an OpenShift Container Platform cluster after an installation by following the procedures in this document.

### 24.1. REVIEWING THE INSTALLATION LOG

You can review a summary of an installation in the OpenShift Container Platform installation log. If an installation succeeds, the information required to access the cluster is included in the log.

#### Prerequisites

- You have access to the installation host.

#### Procedure

- Review the `.openshift_install.log` log file in the installation directory on your installation host:

```
$ cat <install_dir>/openshift_install.log
```

#### Example output

Cluster credentials are included at the end of the log if the installation is successful, as outlined in the following example:

```
...
time="2020-12-03T09:50:47Z" level=info msg="Install complete!"
time="2020-12-03T09:50:47Z" level=info msg="To access the cluster as the system:admin
user when using 'oc', run 'export KUBECONFIG=/home/myuser/install_dir/auth/kubeconfig'"
time="2020-12-03T09:50:47Z" level=info msg="Access the OpenShift web-console here:
https://console-openshift-console.apps.mycluster.example.com"
time="2020-12-03T09:50:47Z" level=info msg="Login to the console with user: \"kubeadmin\",
and password: \"password\""
time="2020-12-03T09:50:47Z" level=debug msg="Time elapsed per stage:"
time="2020-12-03T09:50:47Z" level=debug msg="  Infrastructure: 6m45s"
time="2020-12-03T09:50:47Z" level=debug msg="Bootstrap Complete: 11m30s"
time="2020-12-03T09:50:47Z" level=debug msg=" Bootstrap Destroy: 1m5s"
time="2020-12-03T09:50:47Z" level=debug msg=" Cluster Operators: 17m31s"
time="2020-12-03T09:50:47Z" level=info msg="Time elapsed: 37m26s"
```

### 24.2. VIEWING THE IMAGE PULL SOURCE

For clusters with unrestricted network connectivity, you can view the source of your pulled images by using a command on a node, such as `crictl images`.

However, for disconnected installations, to view the source of pulled images, you must review the CRI-O logs to locate the **Trying to access** log entry, as shown in the following procedure. Other methods to view the image pull source, such as the `crictl images` command, show the non-mirrored image name, even though the image is pulled from the mirrored location.

#### Prerequisites

- You have access to the cluster as a user with the `cluster-admin` role.

## Procedure

- Review the CRI-O logs for a master or worker node:

```
$ oc adm node-logs <node_name> -u crio
```

## Example output

The **Trying to access** log entry indicates where the image is being pulled from.

```
...
Mar 17 02:52:50 ip-10-0-138-140.ec2.internal crio[1366]: time="2021-08-05
10:33:21.594930907Z" level=info msg="Pulling image: quay.io/openshift-release-dev/ocp-
release:4.10.0-ppc64le" id=abcd713b-d0e1-4844-ac1c-474c5b60c07c
name=/runtime.v1alpha2.ImageService/PullImage
Mar 17 02:52:50 ip-10-0-138-140.ec2.internal crio[1484]: time="2021-03-17
02:52:50.194341109Z" level=info msg="Trying to access \"li0317gcp1.mirror-
registry.qe.gcp.devcluster.openshift.com:5000/ocp/release@sha256:1926eae7cacb9c00f142ec
98b00628970e974284b6ddaf9a6a086cb9af7a6c31\""
Mar 17 02:52:50 ip-10-0-138-140.ec2.internal crio[1484]: time="2021-03-17
02:52:50.226788351Z" level=info msg="Trying to access \"li0317gcp1.mirror-
registry.qe.gcp.devcluster.openshift.com:5000/ocp/release@sha256:1926eae7cacb9c00f142ec
98b00628970e974284b6ddaf9a6a086cb9af7a6c31\""
...
```

The log might show the image pull source twice, as shown in the preceding example.

If your **ImageContentSourcePolicy** object lists multiple mirrors, OpenShift Container Platform attempts to pull the images in the order listed in the configuration, for example:

```
Trying to access \"li0317gcp1.mirror-
registry.qe.gcp.devcluster.openshift.com:5000/ocp/release@sha256:1926eae7cacb9c00f142ec
98b00628970e974284b6ddaf9a6a086cb9af7a6c31\""
Trying to access \"li0317gcp2.mirror-
registry.qe.gcp.devcluster.openshift.com:5000/ocp/release@sha256:1926eae7cacb9c00f142ec
98b00628970e974284b6ddaf9a6a086cb9af7a6c31\""
```

## 24.3. GETTING CLUSTER VERSION, STATUS, AND UPDATE DETAILS

You can view the cluster version and status by running the **oc get clusterversion** command. If the status shows that the installation is still progressing, you can review the status of the Operators for more information.

You can also list the current update channel and review the available cluster updates.

### Prerequisites

- You have access to the cluster as a user with the **cluster-admin** role.
- You have installed the OpenShift CLI (**oc**).

### Procedure

- Obtain the cluster version and overall status:

-



```
$ oc get clusterversion
```

### Example output

```
NAME     VERSION  AVAILABLE  PROGRESSING  SINCE  STATUS
version  4.6.4    True       False        6m25s Cluster version is 4.6.4
```

The example output indicates that the cluster has been installed successfully.

2. If the cluster status indicates that the installation is still progressing, you can obtain more detailed progress information by checking the status of the Operators:

```
$ oc get clusteroperators.config.openshift.io
```

3. View a detailed summary of cluster specifications, update availability, and update history:

```
$ oc describe clusterversion
```

4. List the current update channel:

```
$ oc get clusterversion -o jsonpath='{.items[0].spec}{"\n"}'
```

### Example output

```
{"channel":"stable-4.6","clusterID":"245539c1-72a3-41aa-9cec-72ed8cf25c5c"}
```

5. Review the available cluster updates:

```
$ oc adm upgrade
```

### Example output

```
Cluster version is 4.6.4
```

```
Updates:
```

```
VERSION IMAGE
```

```
4.6.6 quay.io/openshift-release-dev/ocp-
release@sha256:c7e8f18e8116356701bd23ae3a23fb9892dd5ea66c8300662ef30563d7104f3
9
```

### Additional resources

- See [Querying Operator status after installation](#) for more information about querying Operator status if your installation is still progressing.
- See [Troubleshooting Operator issues](#) for information about investigating issues with Operators.
- See [Updating a cluster between minor versions](#) for more information on updating your cluster.
- See [Understanding update channels and releases](#) for an overview about update release channels.

## 24.4. QUERYING THE STATUS OF THE CLUSTER NODES BY USING THE CLI

You can verify the status of the cluster nodes after an installation.

### Prerequisites

- You have access to the cluster as a user with the **cluster-admin** role.
- You have installed the OpenShift CLI (**oc**).

### Procedure

1. List the status of the cluster nodes. Verify that the output lists all of the expected control plane and compute nodes and that each node has a **Ready** status:

```
$ oc get nodes
```

### Example output

```
NAME                                STATUS  ROLES  AGE  VERSION
compute-1.example.com              Ready  worker  33m  v1.23.0
control-plane-1.example.com        Ready  master  41m  v1.23.0
control-plane-2.example.com        Ready  master  45m  v1.23.0
compute-2.example.com              Ready  worker  38m  v1.23.0
compute-3.example.com              Ready  worker  33m  v1.23.0
control-plane-3.example.com        Ready  master  41m  v1.23.0
```

2. Review CPU and memory resource availability for each cluster node:

```
$ oc adm top nodes
```

### Example output

```
NAME                                CPU(cores)  CPU%  MEMORY(bytes)  MEMORY%
compute-1.example.com              128m        8%    1132Mi         16%
control-plane-1.example.com        801m        22%    3471Mi         23%
control-plane-2.example.com        1718m       49%    6085Mi         40%
compute-2.example.com              935m        62%    5178Mi         75%
compute-3.example.com              111m        7%    1131Mi         16%
control-plane-3.example.com        942m        26%    4100Mi         27%
```

### Additional resources

- See [Verifying node health](#) for more details about reviewing node health and investigating node issues.

## 24.5. REVIEWING THE CLUSTER STATUS FROM THE OPENSIFT CONTAINER PLATFORM WEB CONSOLE

You can review the following information in the **Overview** page in the OpenShift Container Platform web console:

- The general status of your cluster
- The status of the control plane, cluster Operators, and storage
- CPU, memory, file system, network transfer, and pod availability
- The API address of the cluster, the cluster ID, and the name of the provider
- Cluster version information
- Cluster update status, including details of the current update channel and available updates
- A cluster inventory detailing node, pod, storage class, and persistent volume claim (PVC) information
- A list of ongoing cluster activities and recent events

### Prerequisites

- You have access to the cluster as a user with the **cluster-admin** role.

### Procedure

- In the **Administrator** perspective, navigate to **Home** → **Overview**.

## 24.6. REVIEWING THE CLUSTER STATUS FROM RED HAT OPENSIFT CLUSTER MANAGER

From the OpenShift Container Platform web console, you can review detailed information about the status of your cluster on OpenShift Cluster Manager.

### Prerequisites

- You have access to the cluster as a user with the **cluster-admin** role.

### Procedure

1. In the **Administrator** perspective, navigate to **Home** → **Overview** → **Details** → **Cluster ID** → **OpenShift Cluster Manager** to open your cluster's **Overview** tab in the OpenShift Cluster Manager web console.
2. From the **Overview** tab on [OpenShift Cluster Manager](#), review the following information about your cluster:
  - vCPU and memory availability and resource usage
  - The cluster ID, status, type, region, and the provider name
  - Node counts by node type
  - Cluster version details, the creation date of the cluster, and the name of the cluster owner
  - The life cycle support status of the cluster

- Subscription information, including the service level agreement (SLA) status, the subscription unit type, the production status of the cluster, the subscription obligation, and the service level

### TIP

To view the history for your cluster, click the **Cluster history** tab.

3. Navigate to the **Monitoring** page to review the following information:
  - A list of any issues that have been detected
  - A list of alerts that are firing
  - The cluster Operator status and version
  - The cluster's resource usage
4. Optional: You can view information about your cluster that Red Hat Insights collects by navigating to the **Overview** menu. From this menu you can view the following information:
  - Potential issues that your cluster might be exposed to, categorized by risk level
  - Health-check status by category

### Additional resources

- See [Using Insights to identify issues with your cluster](#) for more information about reviewing potential issues with your cluster.

## 24.7. CHECKING CLUSTER RESOURCE AVAILABILITY AND UTILIZATION

OpenShift Container Platform provides a comprehensive set of monitoring dashboards that help you understand the state of cluster components.

In the **Administrator** perspective, you can access dashboards for core OpenShift Container Platform components, including:

- etcd
- Kubernetes compute resources
- Kubernetes network resources
- Prometheus
- Dashboards relating to cluster and node performance

Figure 24.1. Example compute resources dashboard

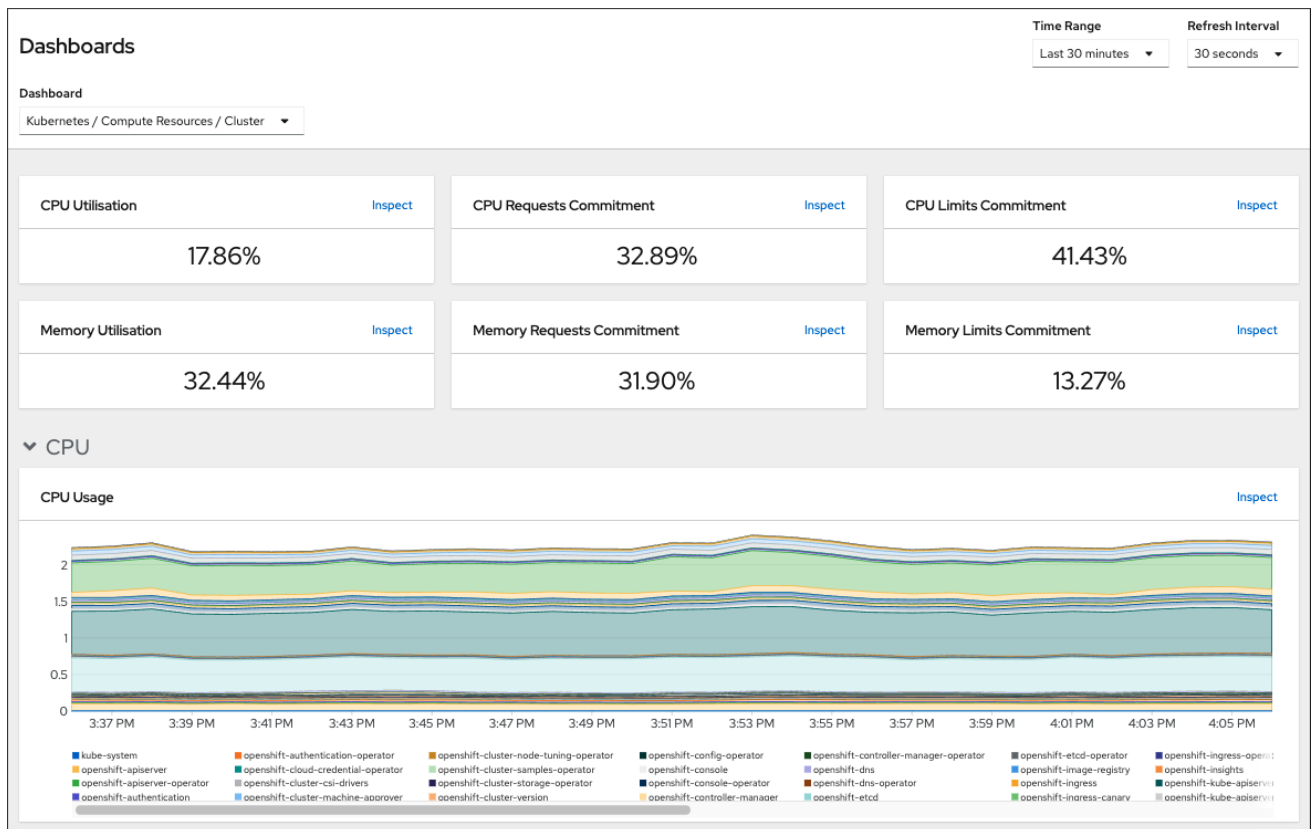

## Prerequisites

- You have access to the cluster as a user with the **cluster-admin** role.

## Procedure

- In the **Administrator** perspective in the OpenShift Container Platform web console, navigate to **Observe → Dashboards**.
- Choose a dashboard in the **Dashboard** list. Some dashboards, such as the **etcd** dashboard, produce additional sub-menus when selected.
- Optional: Select a time range for the graphs in the **Time Range** list.
  - Select a pre-defined time period.
  - Set a custom time range by selecting **Custom time range** in the **Time Range** list.
    - Input or select the **From** and **To** dates and times.
    - Click **Save** to save the custom time range.
- Optional: Select a **Refresh Interval**
- Hover over each of the graphs within a dashboard to display detailed information about specific items.

## Additional resources

- See [Monitoring overview](#) for more information about the OpenShift Container Platform monitoring stack.

## 24.8. LISTING ALERTS THAT ARE FIRING

Alerts provide notifications when a set of defined conditions are true in an OpenShift Container Platform cluster. You can review the alerts that are firing in your cluster by using the Alerting UI in the OpenShift Container Platform web console.

### Prerequisites

- You have access to the cluster as a user with the **cluster-admin** role.

### Procedure

1. In the **Administrator** perspective, navigate to the **Observe → Alerting → Alerts** page.
2. Review the alerts that are firing, including their **Severity**, **State**, and **Source**.
3. Select an alert to view more detailed information in the **Alert Details** page.

### Additional resources

- See [Managing alerts](#) for further details about alerting in OpenShift Container Platform.

## 24.9. NEXT STEPS

- See [Troubleshooting installations](#) if you experience issues when installing your cluster.
- After installing OpenShift Container Platform, you can [further expand and customize your cluster](#).

## CHAPTER 25. TROUBLESHOOTING INSTALLATION ISSUES

To assist in troubleshooting a failed OpenShift Container Platform installation, you can gather logs from the bootstrap and control plane machines. You can also get debug information from the installation program. If you are unable to resolve the issue using the logs and debug information, see [Determining where installation issues occur](#) for component-specific troubleshooting.



### NOTE

If your OpenShift Container Platform installation fails and the debug output or logs contain network timeouts or other connectivity errors, review the guidelines for [configuring your firewall](#). Gathering logs from your firewall and load balancer can help you diagnose network-related errors.

### 25.1. PREREQUISITES

- You attempted to install an OpenShift Container Platform cluster and the installation failed.

### 25.2. GATHERING LOGS FROM A FAILED INSTALLATION

If you gave an SSH key to your installation program, you can gather data about your failed installation.



### NOTE

You use a different command to gather logs about an unsuccessful installation than to gather logs from a running cluster. If you must gather logs from a running cluster, use the **oc adm must-gather** command.

#### Prerequisites

- Your OpenShift Container Platform installation failed before the bootstrap process finished. The bootstrap node is running and accessible through SSH.
- The **ssh-agent** process is active on your computer, and you provided the same SSH key to both the **ssh-agent** process and the installation program.
- If you tried to install a cluster on infrastructure that you provisioned, you must have the fully qualified domain names of the bootstrap and control plane nodes.

#### Procedure

1. Generate the commands that are required to obtain the installation logs from the bootstrap and control plane machines:
  - If you used installer-provisioned infrastructure, change to the directory that contains the installation program and run the following command:

```
$ ./openshift-install gather bootstrap --dir <installation_directory> 1
```

- 1** **installation\_directory** is the directory you specified when you ran **./openshift-install create cluster**. This directory contains the OpenShift Container Platform definition files that the installation program creates.

For installer-provisioned infrastructure, the installation program stores information about the cluster, so you do not specify the hostnames or IP addresses.

- If you used infrastructure that you provisioned yourself, change to the directory that contains the installation program and run the following command:

```
$ ./openshift-install gather bootstrap --dir <installation_directory> \ 1
--bootstrap <bootstrap_address> \ 2
--master <master_1_address> \ 3
--master <master_2_address> \ 4
--master <master_3_address>" 5
```

- 1** For **installation\_directory**, specify the same directory you specified when you ran **./openshift-install create cluster**. This directory contains the OpenShift Container Platform definition files that the installation program creates.
- 2** **<bootstrap\_address>** is the fully qualified domain name or IP address of the cluster's bootstrap machine.
- 3** **4** **5** For each control plane, or master, machine in your cluster, replace **<master\_\*\_address>** with its fully qualified domain name or IP address.



#### NOTE

A default cluster contains three control plane machines. List all of your control plane machines as shown, no matter how many your cluster uses.

#### Example output

```
INFO Pulling debug logs from the bootstrap machine
INFO Bootstrap gather logs captured here "<installation_directory>/log-bundle-
<timestamp>.tar.gz"
```

If you open a Red Hat support case about your installation failure, include the compressed logs in the case.

## 25.3. MANUALLY GATHERING LOGS WITH SSH ACCESS TO YOUR HOST(S)

Manually gather logs in situations where **must-gather** or automated collection methods do not work.



#### IMPORTANT

By default, SSH access to the OpenShift Container Platform nodes is disabled on the Red Hat OpenStack Platform (RHOSP) based installations.

#### Prerequisites

- You must have SSH access to your host(s).

#### Procedure



1. Collect the **bootkube.service** service logs from the bootstrap host using the **journalctl** command by running:

```
$ journalctl -b -f -u bootkube.service
```

2. Collect the bootstrap host's container logs using the podman logs. This is shown as a loop to get all of the container logs from the host:

```
$ for pod in $(sudo podman ps -a -q); do sudo podman logs $pod; done
```

3. Alternatively, collect the host's container logs using the **tail** command by running:

```
# tail -f /var/lib/containers/storage/overlay-containers/*/userdata/ctr.log
```

4. Collect the **kubelet.service** and **crio.service** service logs from the master and worker hosts using the **journalctl** command by running:

```
$ journalctl -b -f -u kubelet.service -u crio.service
```

5. Collect the master and worker host container logs using the **tail** command by running:

```
$ sudo tail -f /var/log/containers/*
```

## 25.4. MANUALLY GATHERING LOGS WITHOUT SSH ACCESS TO YOUR HOST(S)

Manually gather logs in situations where **must-gather** or automated collection methods do not work.

If you do not have SSH access to your node, you can access the systems journal to investigate what is happening on your host.

### Prerequisites

- Your OpenShift Container Platform installation must be complete.
- Your API service is still functional.
- You have system administrator privileges.

### Procedure

1. Access **journald** unit logs under **/var/log** by running:

```
$ oc adm node-logs --role=master -u kubelet
```

2. Access host file paths under **/var/log** by running:

```
$ oc adm node-logs --role=master --path=openshift-apiserver
```

## 25.5. GETTING DEBUG INFORMATION FROM THE INSTALLATION PROGRAM

You can use any of the following actions to get debug information from the installation program.

- Look at debug messages from a past installation in the hidden **.openshift\_install.log** file. For example, enter:

```
$ cat ~/<installation_directory>/.openshift_install.log 1
```

- 1 For **installation\_directory**, specify the same directory you specified when you ran **./openshift-install create cluster**.

- Change to the directory that contains the installation program and re-run it with **--log-level=debug**:

```
$ ./openshift-install create cluster --dir <installation_directory> --log-level debug 1
```

- 1 For **installation\_directory**, specify the same directory you specified when you ran **./openshift-install create cluster**.

## 25.6. REINSTALLING THE OPENSIFT CONTAINER PLATFORM CLUSTER

If you are unable to debug and resolve issues in the failed OpenShift Container Platform installation, consider installing a new OpenShift Container Platform cluster. Before starting the installation process again, you must complete thorough cleanup. For a user-provisioned infrastructure (UPI) installation, you must manually destroy the cluster and delete all associated resources. The following procedure is for an installer-provisioned infrastructure (IPI) installation.

### Procedure

1. Destroy the cluster and remove all the resources associated with the cluster, including the hidden installer state files in the installation directory:

```
$ ./openshift-install destroy cluster --dir <installation_directory> 1
```

- 1 **installation\_directory** is the directory you specified when you ran **./openshift-install create cluster**. This directory contains the OpenShift Container Platform definition files that the installation program creates.

2. Before reinstalling the cluster, delete the installation directory:

```
$ rm -rf <installation_directory>
```

3. Follow the procedure for installing a new OpenShift Container Platform cluster.

### Additional resources

- [Installing an OpenShift Container Platform cluster](#)

## CHAPTER 26. SUPPORT FOR FIPS CRYPTOGRAPHY

You can install an OpenShift Container Platform cluster that uses FIPS validated or Modules In Process cryptographic libraries on the **x86\_64** architecture.



### IMPORTANT

To enable FIPS mode for your cluster, you must run the installation program from a Red Hat Enterprise Linux (RHEL) computer configured to operate in FIPS mode. For more information about configuring FIPS mode on RHEL, see [Installing the system in FIPS mode](#).

For the Red Hat Enterprise Linux CoreOS (RHCOS) machines in your cluster, this change is applied when the machines are deployed based on the status of an option in the **install-config.yaml** file, which governs the cluster options that a user can change during cluster deployment. With Red Hat Enterprise Linux (RHEL) machines, you must enable FIPS mode when you install the operating system on the machines that you plan to use as worker machines. These configuration methods ensure that your cluster meets the requirements of a FIPS compliance audit: only FIPS validated or Modules In Process cryptography packages are enabled before the initial system boot.

Because FIPS must be enabled before the operating system that your cluster uses boots for the first time, you cannot enable FIPS after you deploy a cluster.

### 26.1. FIPS VALIDATION IN OPENSIFT CONTAINER PLATFORM

OpenShift Container Platform uses certain FIPS validated or Modules In Process modules within RHEL and RHCOS for the operating system components that it uses. See [RHEL8 core crypto components](#). For example, when users use SSH to connect to OpenShift Container Platform clusters and containers, those connections are properly encrypted.

OpenShift Container Platform components are written in Go and built with Red Hat's golang compiler. When you enable FIPS mode for your cluster, all OpenShift Container Platform components that require cryptographic signing call RHEL and RHCOS cryptographic libraries.

**Table 26.1. FIPS mode attributes and limitations in OpenShift Container Platform 4.10**

Attributes	Limitations
FIPS support in RHEL 8 and RHCOS operating systems.	The FIPS implementation does not offer a single function that both computes hash functions and validates the keys that are based on that hash. This limitation will continue to be evaluated and improved in future OpenShift Container Platform releases.
FIPS support in CRI-O runtimes.	
FIPS support in OpenShift Container Platform services.	
FIPS validated or Modules In Process cryptographic module and algorithms that are obtained from RHEL 8 and RHCOS binaries and images.	
Use of FIPS compatible golang compiler.	TLS FIPS support is not complete but is planned for future OpenShift Container Platform releases.

Attributes	Limitations
FIPS support across multiple architectures.	FIPS is currently only supported on OpenShift Container Platform deployments using the <b>x86_64</b> architecture.

## 26.2. FIPS SUPPORT IN COMPONENTS THAT THE CLUSTER USES

Although the OpenShift Container Platform cluster itself uses FIPS validated or Modules In Process modules, ensure that the systems that support your OpenShift Container Platform cluster use FIPS validated or Modules In Process modules for cryptography.

### 26.2.1. etcd

To ensure that the secrets that are stored in etcd use FIPS validated or Modules In Process encryption, boot the node in FIPS mode. After you install the cluster in FIPS mode, you can [encrypt the etcd data](#) by using the FIPS-approved **aes cbc** cryptographic algorithm.

### 26.2.2. Storage

For local storage, use RHEL-provided disk encryption or Container Native Storage that uses RHEL-provided disk encryption. By storing all data in volumes that use RHEL-provided disk encryption and enabling FIPS mode for your cluster, both data at rest and data in motion, or network data, are protected by FIPS validated or Modules In Process encryption. You can configure your cluster to encrypt the root filesystem of each node, as described in [Customizing nodes](#).

### 26.2.3. Runtimes

To ensure that containers know that they are running on a host that is using FIPS validated or Modules In Process cryptography modules, use CRI-O to manage your runtimes. CRI-O supports FIPS mode, in that it configures the containers to know that they are running in FIPS mode.

## 26.3. INSTALLING A CLUSTER IN FIPS MODE

To install a cluster in FIPS mode, follow the instructions to install a customized cluster on your preferred infrastructure. Ensure that you set **fips: true** in the **install-config.yaml** file before you deploy your cluster.

- [Amazon Web Services](#)
- [Alibaba Cloud](#)
- [Microsoft Azure](#)
- [Bare metal](#)
- [Google Cloud Platform](#)
- [Red Hat OpenStack Platform \(RHOSP\)](#)
- [VMware vSphere](#)

**NOTE**

If you are using Azure File storage, you cannot enable FIPS mode.

To apply **AES CBC** encryption to your etcd data store, follow the [Encrypting etcd data](#) process after you install your cluster.

If you add RHEL nodes to your cluster, ensure that you enable FIPS mode on the machines before their initial boot. See [Adding RHEL compute machines to an OpenShift Container Platform cluster](#) and [Enabling FIPS Mode](#) in the RHEL 8 documentation.