



Red Hat Enterprise Linux 9

Configuring and managing networking

Managing network interfaces and advanced networking features

Red Hat Enterprise Linux 9 Configuring and managing networking

Managing network interfaces and advanced networking features

Legal Notice

Copyright © 2024 Red Hat, Inc.

The text of and illustrations in this document are licensed by Red Hat under a Creative Commons Attribution–Share Alike 3.0 Unported license ("CC-BY-SA"). An explanation of CC-BY-SA is available at

<http://creativecommons.org/licenses/by-sa/3.0/>

. In accordance with CC-BY-SA, if you distribute this document or an adaptation of it, you must provide the URL for the original version.

Red Hat, as the licensor of this document, waives the right to enforce, and agrees not to assert, Section 4d of CC-BY-SA to the fullest extent permitted by applicable law.

Red Hat, Red Hat Enterprise Linux, the Shadowman logo, the Red Hat logo, JBoss, OpenShift, Fedora, the Infinity logo, and RHCE are trademarks of Red Hat, Inc., registered in the United States and other countries.

Linux[®] is the registered trademark of Linus Torvalds in the United States and other countries.

Java[®] is a registered trademark of Oracle and/or its affiliates.

XFS[®] is a trademark of Silicon Graphics International Corp. or its subsidiaries in the United States and/or other countries.

MySQL[®] is a registered trademark of MySQL AB in the United States, the European Union and other countries.

Node.js[®] is an official trademark of Joyent. Red Hat is not formally related to or endorsed by the official Joyent Node.js open source or commercial project.

The OpenStack[®] Word Mark and OpenStack logo are either registered trademarks/service marks or trademarks/service marks of the OpenStack Foundation, in the United States and other countries and are used with the OpenStack Foundation's permission. We are not affiliated with, endorsed or sponsored by the OpenStack Foundation, or the OpenStack community.

All other trademarks are the property of their respective owners.

Abstract

Using the networking capabilities of Red Hat Enterprise Linux (RHEL), you can configure your host to meet your organization's network and security requirements. For example: You can configure bonds, VLANs, bridges, tunnels and other network types to connect the host to the network. IPsec and WireGuard provide secure VPNs between hosts and networks. RHEL also supports advanced networking features, such as policy-based routing and MultiPath TCP (MPTCP).

Table of Contents

MAKING OPEN SOURCE MORE INCLUSIVE	9
PROVIDING FEEDBACK ON RED HAT DOCUMENTATION	10
CHAPTER 1. IMPLEMENTING CONSISTENT NETWORK INTERFACE NAMING	11
1.1. HOW THE UDEV DEVICE MANAGER RENAMES NETWORK INTERFACES	11
1.2. NETWORK INTERFACE NAMING POLICIES	12
1.3. NETWORK INTERFACE NAMING SCHEMES	13
1.4. CUSTOMIZING THE PREFIX FOR ETHERNET INTERFACES DURING INSTALLATION	13
1.5. CONFIGURING USER-DEFINED NETWORK INTERFACE NAMES BY USING UDEV RULES	14
1.6. CONFIGURING USER-DEFINED NETWORK INTERFACE NAMES BY USING SYSTEMD LINK FILES	16
1.7. ASSIGNING ALTERNATIVE NAMES TO A NETWORK INTERFACE BY USING SYSTEMD LINK FILES	18
CHAPTER 2. CONFIGURING AN ETHERNET CONNECTION	20
2.1. CONFIGURING AN ETHERNET CONNECTION BY USING NMCLI	20
2.2. CONFIGURING AN ETHERNET CONNECTION BY USING THE NMCLI INTERACTIVE EDITOR	23
2.3. CONFIGURING AN ETHERNET CONNECTION BY USING NMTUI	26
2.4. CONFIGURING AN ETHERNET CONNECTION BY USING CONTROL-CENTER	29
2.5. CONFIGURING AN ETHERNET CONNECTION BY USING NM-CONNECTION-EDITOR	32
2.6. CONFIGURING AN ETHERNET CONNECTION WITH A STATIC IP ADDRESS BY USING NMSTATECTL	34
2.7. CONFIGURING AN ETHERNET CONNECTION WITH A STATIC IP ADDRESS BY USING THE NETWORK RHEL SYSTEM ROLE WITH AN INTERFACE NAME	37
2.8. CONFIGURING AN ETHERNET CONNECTION WITH A STATIC IP ADDRESS BY USING THE NETWORK RHEL SYSTEM ROLE WITH A DEVICE PATH	38
2.9. CONFIGURING AN ETHERNET CONNECTION WITH A DYNAMIC IP ADDRESS BY USING NMSTATECTL	40
2.10. CONFIGURING AN ETHERNET CONNECTION WITH A DYNAMIC IP ADDRESS BY USING THE NETWORK RHEL SYSTEM ROLE WITH AN INTERFACE NAME	42
2.11. CONFIGURING AN ETHERNET CONNECTION WITH A DYNAMIC IP ADDRESS BY USING THE NETWORK RHEL SYSTEM ROLE WITH A DEVICE PATH	43
2.12. CONFIGURING MULTIPLE ETHERNET INTERFACES BY USING A SINGLE CONNECTION PROFILE BY INTERFACE NAME	45
2.13. CONFIGURING A SINGLE CONNECTION PROFILE FOR MULTIPLE ETHERNET INTERFACES USING PCI IDS	46
CHAPTER 3. CONFIGURING NETWORK BONDING	48
3.1. UNDERSTANDING THE DEFAULT BEHAVIOR OF CONTROLLER AND PORT INTERFACES	48
3.2. UPSTREAM SWITCH CONFIGURATION DEPENDING ON THE BONDING MODES	48
3.3. CONFIGURING A NETWORK BOND BY USING NMCLI	49
3.4. CONFIGURING A NETWORK BOND BY USING THE RHEL WEB CONSOLE	52
3.5. CONFIGURING A NETWORK BOND BY USING NMTUI	55
3.6. CONFIGURING A NETWORK BOND BY USING NM-CONNECTION-EDITOR	58
3.7. CONFIGURING A NETWORK BOND BY USING NMSTATECTL	60
3.8. CONFIGURING A NETWORK BOND BY USING THE NETWORK RHEL SYSTEM ROLE	62
3.9. CREATING A NETWORK BOND TO ENABLE SWITCHING BETWEEN AN ETHERNET AND WIRELESS CONNECTION WITHOUT INTERRUPTING THE VPN	64
3.10. THE DIFFERENT NETWORK BONDING MODES	67
3.11. THE XMIT_HASH_POLICY BONDING PARAMETER	68
CHAPTER 4. CONFIGURING NETWORK TEAMING	71
4.1. MIGRATING A NETWORK TEAM CONFIGURATION TO NETWORK BOND	71
4.2. UNDERSTANDING THE DEFAULT BEHAVIOR OF CONTROLLER AND PORT INTERFACES	74
4.3. UNDERSTANDING THE TEAMD SERVICE, RUNNERS, AND LINK-WATCHERS	74
4.4. CONFIGURING A NETWORK TEAM BY USING NMCLI	75

4.5. CONFIGURING A NETWORK TEAM BY USING THE RHEL WEB CONSOLE	78
4.6. CONFIGURING A NETWORK TEAM BY USING NM-CONNECTION-EDITOR	82
CHAPTER 5. CONFIGURING VLAN TAGGING	85
5.1. CONFIGURING VLAN TAGGING BY USING NMCLI	85
5.2. CONFIGURING NESTED VLANS BY USING NMCLI	87
5.3. CONFIGURING VLAN TAGGING BY USING THE RHEL WEB CONSOLE	89
5.4. CONFIGURING VLAN TAGGING BY USING NMTUI	91
5.5. CONFIGURING VLAN TAGGING BY USING NM-CONNECTION-EDITOR	95
5.6. CONFIGURING VLAN TAGGING BY USING NMSTATECTL	97
5.7. CONFIGURING VLAN TAGGING BY USING THE NETWORK RHEL SYSTEM ROLE	99
5.8. ADDITIONAL RESOURCES	101
CHAPTER 6. CONFIGURING A NETWORK BRIDGE	102
6.1. CONFIGURING A NETWORK BRIDGE BY USING NMCLI	102
6.2. CONFIGURING A NETWORK BRIDGE BY USING THE RHEL WEB CONSOLE	105
6.3. CONFIGURING A NETWORK BRIDGE BY USING NMTUI	107
6.4. CONFIGURING A NETWORK BRIDGE BY USING NM-CONNECTION-EDITOR	111
6.5. CONFIGURING A NETWORK BRIDGE BY USING NMSTATECTL	113
6.6. CONFIGURING A NETWORK BRIDGE BY USING THE NETWORK RHEL SYSTEM ROLE	115
CHAPTER 7. SETTING UP AN IPSEC VPN	118
7.1. CONFIGURING A VPN CONNECTION WITH CONTROL-CENTER	118
7.2. CONFIGURING A VPN CONNECTION USING NM-CONNECTION-EDITOR	122
7.3. CONFIGURING AUTOMATIC DETECTION AND USAGE OF ESP HARDWARE OFFLOAD TO ACCELERATE AN IPSEC CONNECTION	125
7.4. CONFIGURING ESP HARDWARE OFFLOAD ON A BOND TO ACCELERATE AN IPSEC CONNECTION	126
CHAPTER 8. SETTING UP A WIREGUARD VPN	128
8.1. PROTOCOLS AND PRIMITIVES USED BY WIREGUARD	128
8.2. HOW WIREGUARD USES TUNNEL IP ADDRESSES, PUBLIC KEYS, AND REMOTE ENDPOINTS	129
8.3. USING A WIREGUARD CLIENT BEHIND NAT AND FIREWALLS	129
8.4. CREATING PRIVATE AND PUBLIC KEYS TO BE USED IN WIREGUARD CONNECTIONS	129
8.5. CONFIGURING A WIREGUARD SERVER BY USING NMCLI	130
8.6. CONFIGURING A WIREGUARD SERVER BY USING NMTUI	133
8.7. CONFIGURING A WIREGUARD SERVER BY USING NM-CONNECTION-EDITOR	136
8.8. CONFIGURING A WIREGUARD SERVER BY USING THE WG-QUICK SERVICE	138
8.9. CONFIGURING FIREWALLD ON A WIREGUARD SERVER BY USING THE COMMAND LINE	140
8.10. CONFIGURING FIREWALLD ON A WIREGUARD SERVER BY USING THE GRAPHICAL INTERFACE	141
8.11. CONFIGURING A WIREGUARD CLIENT BY USING NMCLI	141
8.12. CONFIGURING A WIREGUARD CLIENT BY USING NMTUI	144
8.13. CONFIGURING A WIREGUARD CLIENT BY USING NM-CONNECTION-EDITOR	148
8.14. CONFIGURING A WIREGUARD CLIENT BY USING THE WG-QUICK SERVICE	150
CHAPTER 9. CONFIGURING IP TUNNELS	154
9.1. CONFIGURING AN IPIP TUNNEL USING NMCLI TO ENCAPSULATE IPV4 TRAFFIC IN IPV4 PACKETS	154
9.2. CONFIGURING A GRE TUNNEL USING NMCLI TO ENCAPSULATE LAYER-3 TRAFFIC IN IPV4 PACKETS	157
9.3. CONFIGURING A GRE-TAP TUNNEL TO TRANSFER ETHERNET FRAMES OVER IPV4	159
9.4. ADDITIONAL RESOURCES	162
CHAPTER 10. USING A VXLAN TO CREATE A VIRTUAL LAYER-2 DOMAIN FOR VMS	163
10.1. BENEFITS OF VXLANs	163
10.2. CONFIGURING THE ETHERNET INTERFACE ON THE HOSTS	164
10.3. CREATING A NETWORK BRIDGE WITH A VXLAN ATTACHED	165

10.4. CREATING A VIRTUAL NETWORK IN LIBVIRT WITH AN EXISTING BRIDGE	166
10.5. CONFIGURING VIRTUAL MACHINES TO USE VXLAN	167
CHAPTER 11. MANAGING WIFI CONNECTIONS	169
11.1. SUPPORTED WIFI SECURITY TYPES	169
11.2. CONNECTING TO A WIFI NETWORK BY USING NMCLI	169
11.3. CONNECTING TO A WIFI NETWORK BY USING THE GNOME SYSTEM MENU	171
11.4. CONNECTING TO A WIFI NETWORK BY USING THE GNOME SETTINGS APPLICATION	172
11.5. CONFIGURING A WIFI CONNECTION BY USING NMTUI	173
11.6. CONFIGURING A WIFI CONNECTION BY USING NM-CONNECTION-EDITOR	175
11.7. CONFIGURING A WIFI CONNECTION WITH 802.1X NETWORK AUTHENTICATION BY USING THE NETWORK RHEL SYSTEM ROLE	177
11.8. CONFIGURING A WIFI CONNECTION WITH 802.1X NETWORK AUTHENTICATION IN AN EXISTING PROFILE BY USING NMCLI	178
11.9. MANUALLY SETTING THE WIRELESS REGULATORY DOMAIN	180
CHAPTER 12. CONFIGURING RHEL AS A WPA2 OR WPA3 PERSONAL ACCESS POINT	182
CHAPTER 13. USING MACSEC TO ENCRYPT LAYER-2 TRAFFIC IN THE SAME PHYSICAL NETWORK	185
13.1. CONFIGURING A MACSEC CONNECTION USING NMCLI	185
13.2. CONFIGURING A MACSEC CONNECTION USING NMSTATECTL	187
13.3. ADDITIONAL RESOURCES	189
CHAPTER 14. GETTING STARTED WITH IPVLAN	190
14.1. IPVLAN MODES	190
14.2. COMPARISON OF IPVLAN AND MACVLAN	190
14.3. CREATING AND CONFIGURING THE IPVLAN DEVICE USING IPROUTE2	191
CHAPTER 15. CONFIGURING NETWORKMANAGER TO IGNORE CERTAIN DEVICES	193
15.1. CONFIGURING THE LOOPBACK INTERFACE BY USING NMCLI	193
15.2. PERMANENTLY CONFIGURING A DEVICE AS UNMANAGED IN NETWORKMANAGER	194
15.3. TEMPORARILY CONFIGURING A DEVICE AS UNMANAGED IN NETWORKMANAGER	195
CHAPTER 16. CREATING A DUMMY INTERFACE	197
16.1. CREATING A DUMMY INTERFACE WITH BOTH AN IPV4 AND IPV6 ADDRESS USING NMCLI	197
CHAPTER 17. USING NETWORKMANAGER TO DISABLE IPV6 FOR A SPECIFIC CONNECTION	198
17.1. DISABLING IPV6 ON A CONNECTION USING NMCLI	198
CHAPTER 18. CHANGING A HOSTNAME	200
18.1. CHANGING A HOSTNAME USING NMCLI	200
18.2. CHANGING A HOSTNAME USING HOSTNAMECTL	200
CHAPTER 19. CONFIGURING NETWORKMANAGER DHCP SETTINGS	202
19.1. CHANGING THE DHCP CLIENT OF NETWORKMANAGER	202
19.2. CONFIGURING THE DHCP BEHAVIOR OF A NETWORKMANAGER CONNECTION	202
CHAPTER 20. RUNNING DHCLIENT EXIT HOOKS USING NETWORKMANAGER A DISPATCHER SCRIPT	204
20.1. THE CONCEPT OF NETWORKMANAGER DISPATCHER SCRIPTS	204
20.2. CREATING A NETWORKMANAGER DISPATCHER SCRIPT THAT RUNS DHCLIENT EXIT HOOKS	204
CHAPTER 21. MANUALLY CONFIGURING THE /ETC/RESOLV.CONF FILE	206
21.1. DISABLING DNS PROCESSING IN THE NETWORKMANAGER CONFIGURATION	206
21.2. REPLACING /ETC/RESOLV.CONF WITH A SYMBOLIC LINK TO MANUALLY CONFIGURE DNS SETTINGS	207
CHAPTER 22. CONFIGURING THE ORDER OF DNS SERVERS	208

22.1. HOW NETWORKMANAGER ORDERS DNS SERVERS IN /ETC/RESOLV.CONF	208
Default values of DNS priority parameters	208
Valid DNS priority values:	208
22.2. SETTING A NETWORKMANAGER-WIDE DEFAULT DNS SERVER PRIORITY VALUE	209
22.3. SETTING THE DNS PRIORITY OF A NETWORKMANAGER CONNECTION	210
CHAPTER 23. USING DIFFERENT DNS SERVERS FOR DIFFERENT DOMAINS	211
23.1. USING DNSMASQ IN NETWORKMANAGER TO SEND DNS REQUESTS FOR A SPECIFIC DOMAIN TO A SELECTED DNS SERVER	211
23.2. USING SYSTEMD-RESOLVED IN NETWORKMANAGER TO SEND DNS REQUESTS FOR A SPECIFIC DOMAIN TO A SELECTED DNS SERVER	213
CHAPTER 24. MANAGING THE DEFAULT GATEWAY SETTING	216
24.1. SETTING THE DEFAULT GATEWAY ON AN EXISTING CONNECTION BY USING NMCLI	216
24.2. SETTING THE DEFAULT GATEWAY ON AN EXISTING CONNECTION BY USING THE NMCLI INTERACTIVE MODE	217
24.3. SETTING THE DEFAULT GATEWAY ON AN EXISTING CONNECTION BY USING NM-CONNECTION-EDITOR	218
24.4. SETTING THE DEFAULT GATEWAY ON AN EXISTING CONNECTION BY USING CONTROL-CENTER	220
24.5. SETTING THE DEFAULT GATEWAY ON AN EXISTING CONNECTION BY USING NMSTATECTL	221
24.6. SETTING THE DEFAULT GATEWAY ON AN EXISTING CONNECTION BY USING THE NETWORK RHEL SYSTEM ROLE	222
24.7. HOW NETWORKMANAGER MANAGES MULTIPLE DEFAULT GATEWAYS	223
24.8. CONFIGURING NETWORKMANAGER TO AVOID USING A SPECIFIC PROFILE TO PROVIDE A DEFAULT GATEWAY	225
24.9. FIXING UNEXPECTED ROUTING BEHAVIOR DUE TO MULTIPLE DEFAULT GATEWAYS	225
CHAPTER 25. CONFIGURING STATIC ROUTES	228
25.1. EXAMPLE OF A NETWORK THAT REQUIRES STATIC ROUTES	228
25.2. HOW TO USE THE NMCLI COMMAND TO CONFIGURE A STATIC ROUTE	230
25.3. CONFIGURING A STATIC ROUTE BY USING NMCLI	231
25.4. CONFIGURING A STATIC ROUTE BY USING NMTUI	232
25.5. CONFIGURING A STATIC ROUTE BY USING CONTROL-CENTER	234
25.6. CONFIGURING A STATIC ROUTE BY USING NM-CONNECTION-EDITOR	236
25.7. CONFIGURING A STATIC ROUTE BY USING THE NMCLI INTERACTIVE MODE	237
25.8. CONFIGURING A STATIC ROUTE BY USING NMSTATECTL	239
25.9. CONFIGURING A STATIC ROUTE BY USING THE NETWORK RHEL SYSTEM ROLE	240
CHAPTER 26. CONFIGURING POLICY-BASED ROUTING TO DEFINE ALTERNATIVE ROUTES	243
26.1. ROUTING TRAFFIC FROM A SPECIFIC SUBNET TO A DIFFERENT DEFAULT GATEWAY BY USING NMCLI	243
26.2. ROUTING TRAFFIC FROM A SPECIFIC SUBNET TO A DIFFERENT DEFAULT GATEWAY BY USING THE NETWORK RHEL SYSTEM ROLE	247
CHAPTER 27. REUSING THE SAME IP ADDRESS ON DIFFERENT INTERFACES	251
27.1. PERMANENTLY REUSING THE SAME IP ADDRESS ON DIFFERENT INTERFACES	251
27.2. TEMPORARILY REUSING THE SAME IP ADDRESS ON DIFFERENT INTERFACES	252
27.3. ADDITIONAL RESOURCES	254
CHAPTER 28. STARTING A SERVICE WITHIN AN ISOLATED VRF NETWORK	255
28.1. CONFIGURING A VRF DEVICE	255
28.2. STARTING A SERVICE WITHIN AN ISOLATED VRF NETWORK	256
CHAPTER 29. CONFIGURING ETHTOOL SETTINGS IN NETWORKMANAGER CONNECTION PROFILES	259
29.1. CONFIGURING AN ETHTOOL OFFLOAD FEATURE BY USING NMCLI	259

29.2. CONFIGURING AN ETHTOOL OFFLOAD FEATURE BY USING THE NETWORK RHEL SYSTEM ROLE	260
29.3. CONFIGURING AN ETHTOOL COALESCE SETTINGS BY USING NMCLI	261
29.4. CONFIGURING AN ETHTOOL COALESCE SETTINGS BY USING THE NETWORK RHEL SYSTEM ROLE	262
29.5. INCREASING THE RING BUFFER SIZE TO REDUCE A HIGH PACKET DROP RATE BY USING NMCLI	264
29.6. INCREASING THE RING BUFFER SIZE TO REDUCE A HIGH PACKET DROP RATE BY USING THE NETWORK RHEL SYSTEM ROLE	265
CHAPTER 30. INTRODUCTION TO NETWORKMANAGER DEBUGGING	268
30.1. INTRODUCTION TO NETWORKMANAGER REAPPLY METHOD	268
30.2. SETTING THE NETWORKMANAGER LOG LEVEL	270
30.3. TEMPORARILY SETTING LOG LEVELS AT RUN TIME USING NMCLI	271
30.4. VIEWING NETWORKMANAGER LOGS	272
30.5. DEBUGGING LEVELS AND DOMAINS	272
CHAPTER 31. USING LLDP TO DEBUG NETWORK CONFIGURATION PROBLEMS	274
31.1. DEBUGGING AN INCORRECT VLAN CONFIGURATION USING LLDP INFORMATION	274
CHAPTER 32. LINUX TRAFFIC CONTROL	277
32.1. OVERVIEW OF QUEUING DISCIPLINES	277
32.2. INTRODUCTION TO CONNECTION TRACKING	277
32.3. INSPECTING QDISCS OF A NETWORK INTERFACE USING THE TC UTILITY	278
32.4. UPDATING THE DEFAULT QDISC	279
32.5. TEMPORARILY SETTING THE CURRENT QDISC OF A NETWORK INTERFACE USING THE TC UTILITY	279
32.6. PERMANENTLY SETTING THE CURRENT QDISC OF A NETWORK INTERFACE USING NETWORKMANAGER	280
32.7. CONFIGURING THE RATE LIMITING OF PACKETS BY USING THE TC-CTINFO UTILITY	281
32.8. AVAILABLE QDISCS IN RHEL	285
CHAPTER 33. AUTHENTICATING A RHEL CLIENT TO THE NETWORK BY USING THE 802.1X STANDARD WITH A CERTIFICATE STORED ON THE FILE SYSTEM	287
33.1. CONFIGURING 802.1X NETWORK AUTHENTICATION ON AN EXISTING ETHERNET CONNECTION BY USING NMCLI	287
33.2. CONFIGURING A STATIC ETHERNET CONNECTION WITH 802.1X NETWORK AUTHENTICATION BY USING NMSTATECTL	288
33.3. CONFIGURING A STATIC ETHERNET CONNECTION WITH 802.1X NETWORK AUTHENTICATION BY USING THE NETWORK RHEL SYSTEM ROLE	290
33.4. CONFIGURING A WIFI CONNECTION WITH 802.1X NETWORK AUTHENTICATION BY USING THE NETWORK RHEL SYSTEM ROLE	292
CHAPTER 34. SETTING UP AN 802.1X NETWORK AUTHENTICATION SERVICE FOR LAN CLIENTS BY USING HOSTAPD WITH FREERADIUS BACKEND	295
34.1. PREREQUISITES	295
34.2. SETTING UP THE BRIDGE ON THE AUTHENTICATOR	295
34.3. CERTIFICATE REQUIREMENTS BY FREERADIUS	296
34.4. CREATING A SET OF CERTIFICATES ON A FREERADIUS SERVER FOR TESTING PURPOSES	297
34.5. CONFIGURING FREERADIUS TO AUTHENTICATE NETWORK CLIENTS SECURELY BY USING EAP	299
34.6. CONFIGURING HOSTAPD AS AN AUTHENTICATOR IN A WIRED NETWORK	302
34.7. TESTING EAP-TTLS AUTHENTICATION AGAINST A FREERADIUS SERVER OR AUTHENTICATOR	305
34.8. TESTING EAP-TLS AUTHENTICATION AGAINST A FREERADIUS SERVER OR AUTHENTICATOR	306
34.9. BLOCKING AND ALLOWING TRAFFIC BASED ON HOSTAPD AUTHENTICATION EVENTS	308
CHAPTER 35. GETTING STARTED WITH MULTIPATH TCP	311
35.1. UNDERSTANDING MPTCP	311

35.2. PREPARING RHEL TO ENABLE MPTCP SUPPORT	311
35.3. USING IPROUTE2 TO TEMPORARILY CONFIGURE AND ENABLE MULTIPLE PATHS FOR MPTCP APPLICATIONS	312
35.4. PERMANENTLY CONFIGURING MULTIPLE PATHS FOR MPTCP APPLICATIONS	314
35.5. MONITORING MPTCP SUB-FLOWS	316
35.6. DISABLING MULTIPATH TCP IN THE KERNEL	319
CHAPTER 36. MANAGING THE MPTCPD SERVICE	320
36.1. CONFIGURING MPTCPD	320
36.2. MANAGING APPLICATIONS WITH MPTCPIZE TOOL	320
36.3. ENABLING MPTCP SOCKETS FOR A SERVICES USING THE MPTCPIZE UTILITY	321
CHAPTER 37. NETWORKMANAGER CONNECTION PROFILES IN KEYFILE FORMAT	322
37.1. THE KEYFILE FORMAT OF NETWORKMANAGER PROFILES	322
37.2. USING NMCLI TO CREATE KEYFILE CONNECTION PROFILES IN OFFLINE MODE	323
37.3. MANUALLY CREATING A NETWORKMANAGER PROFILE IN KEYFILE FORMAT	325
37.4. THE DIFFERENCES IN INTERFACE RENAMING WITH PROFILES IN IFCFG AND KEYFILE FORMAT	326
37.5. MIGRATING NETWORKMANAGER PROFILES FROM IFCFG TO KEYFILE FORMAT	327
CHAPTER 38. SYSTEMD NETWORK TARGETS AND SERVICES	329
38.1. DIFFERENCES BETWEEN THE NETWORK AND NETWORK-ONLINE SYSTEMD TARGET	329
38.2. OVERVIEW OF NETWORKMANAGER-WAIT-ONLINE	329
38.3. CONFIGURING A SYSTEMD SERVICE TO START AFTER THE NETWORK HAS BEEN STARTED	330
CHAPTER 39. INTRODUCTION TO NMSTATE	331
39.1. USING THE LIBNMSTATE LIBRARY IN A PYTHON APPLICATION	331
39.2. UPDATING THE CURRENT NETWORK CONFIGURATION USING NMSTATECTL	331
39.3. THE NMSTATE SYSTEMD SERVICE	332
39.4. NETWORK STATES FOR THE NETWORK RHEL SYSTEM ROLE	332
39.5. ADDITIONAL RESOURCES	334
CHAPTER 40. CAPTURING NETWORK PACKETS	335
40.1. USING XDPDUMP TO CAPTURE NETWORK PACKETS INCLUDING PACKETS DROPPED BY XDP PROGRAMS	335
40.2. ADDITIONAL RESOURCES	336
CHAPTER 41. UNDERSTANDING THE EBPF NETWORKING FEATURES IN RHEL 9	337
41.1. OVERVIEW OF NETWORKING EBPF FEATURES IN RHEL 9	337
XDP	337
AF_XDP	338
Traffic Control	338
Socket filter	338
Control Groups	339
Stream Parser	339
SO_REUSEPORT socket selection	339
Flow dissector	339
TCP Congestion Control	340
Routes with encapsulation	340
Socket lookup	340
41.2. OVERVIEW OF XDP FEATURES IN RHEL 9 BY NETWORK CARDS	340
CHAPTER 42. NETWORK TRACING USING THE BPF COMPILER COLLECTION	343
42.1. INSTALLING THE BCC-TOOLS PACKAGE	343
42.2. DISPLAYING TCP CONNECTIONS ADDED TO THE KERNEL'S ACCEPT QUEUE	343
42.3. TRACING OUTGOING TCP CONNECTION ATTEMPTS	344

42.4. MEASURING THE LATENCY OF OUTGOING TCP CONNECTIONS	345
42.5. DISPLAYING DETAILS ABOUT TCP PACKETS AND SEGMENTS THAT WERE DROPPED BY THE KERNEL	345
42.6. TRACING TCP SESSIONS	346
42.7. TRACING TCP RETRANSMISSIONS	347
42.8. DISPLAYING TCP STATE CHANGE INFORMATION	347
42.9. SUMMARIZING AND AGGREGATING TCP TRAFFIC SENT TO SPECIFIC SUBNETS	348
42.10. DISPLAYING THE NETWORK THROUGHPUT BY IP ADDRESS AND PORT	349
42.11. TRACING ESTABLISHED TCP CONNECTIONS	349
42.12. TRACING IPV4 AND IPV6 LISTEN ATTEMPTS	350
42.13. SUMMARIZING THE SERVICE TIME OF SOFT INTERRUPTS	350
42.14. SUMMARIZING PACKETS SIZE AND COUNT ON A NETWORK INTERFACE	351
42.15. ADDITIONAL RESOURCES	352
CHAPTER 43. CONFIGURING NETWORK DEVICES TO ACCEPT TRAFFIC FROM ALL MAC ADDRESSES	353
43.1. TEMPORARILY CONFIGURING A DEVICE TO ACCEPT ALL TRAFFIC	353
43.2. PERMANENTLY CONFIGURING A NETWORK DEVICE TO ACCEPT ALL TRAFFIC USING NMCLI	354
43.3. PERMANENTLY CONFIGURING A NETWORK DEVICE TO ACCEPT ALL TRAFFIC USING NMSTATECTL	354
CHAPTER 44. MIRRORING A NETWORK INTERFACE BY USING NMCLI	356
CHAPTER 45. USING NMSTATE-AUTOCONF TO AUTOMATICALLY CONFIGURE THE NETWORK STATE USING LLDP	358
45.1. USING NMSTATE-AUTOCONF TO AUTOMATICALLY CONFIGURE NETWORK INTERFACES	358
CHAPTER 46. CONFIGURING 802.3 LINK SETTINGS	361
46.1. CONFIGURING 802.3 LINK SETTINGS USING THE NMCLI UTILITY	361
CHAPTER 47. GETTING STARTED WITH DPDK	363
47.1. INSTALLING THE DPDK PACKAGE	363
47.2. ADDITIONAL RESOURCES	363
CHAPTER 48. GETTING STARTED WITH TIPC	364
48.1. THE ARCHITECTURE OF TIPC	364
48.2. LOADING THE TIPC MODULE WHEN THE SYSTEM BOOTS	364
48.3. CREATING A TIPC NETWORK	365
48.4. ADDITIONAL RESOURCES	366
CHAPTER 49. AUTOMATICALLY CONFIGURING NETWORK INTERFACES IN PUBLIC CLOUDS USING NM-CLOUD-SETUP	367
49.1. CONFIGURING AND PRE-DEPLOYING NM-CLOUD-SETUP	367
49.2. UNDERSTANDING THE ROLE OF IMDSV2 AND NM-CLOUD-SETUP IN THE RHEL EC2 INSTANCE	368

MAKING OPEN SOURCE MORE INCLUSIVE

Red Hat is committed to replacing problematic language in our code, documentation, and web properties. We are beginning with these four terms: master, slave, blacklist, and whitelist. Because of the enormity of this endeavor, these changes will be implemented gradually over several upcoming releases. For more details, see [our CTO Chris Wright's message](#).

PROVIDING FEEDBACK ON RED HAT DOCUMENTATION

We appreciate your feedback on our documentation. Let us know how we can improve it.

Submitting feedback through Jira (account required)

1. Log in to the [Jira](#) website.
2. Click **Create** in the top navigation bar
3. Enter a descriptive title in the **Summary** field.
4. Enter your suggestion for improvement in the **Description** field. Include links to the relevant parts of the documentation.
5. Click **Create** at the bottom of the dialogue.

CHAPTER 1. IMPLEMENTING CONSISTENT NETWORK INTERFACE NAMING

The **udev** device manager implements consistent device naming in Red Hat Enterprise Linux. The device manager supports different naming schemes and, by default, assigns fixed names based on firmware, topology, and location information.

Without consistent device naming, the Linux kernel assigns names to network interfaces by combining a fixed prefix and an index. The index increases as the kernel initializes the network devices. For example, **eth0** represents the first Ethernet device being probed on start-up. If you add another network interface controller to the system, the assignment of the kernel device names is no longer fixed because, after a reboot, the devices can initialize in a different order. In that case, the kernel can name the devices differently.

To solve this problem, **udev** assigns consistent device names. This has the following advantages:

- Device names are stable across reboots.
- Device names stay fixed even if you add or remove hardware.
- Defective hardware can be seamlessly replaced.
- The network naming is stateless and does not require explicit configuration files.



WARNING

Generally, Red Hat does not support systems where consistent device naming is disabled. For exceptions, see the [ls it safe to set net.ifnames=0](#) solution.

1.1. HOW THE UDEV DEVICE MANAGER RENAMES NETWORK INTERFACES

To implement a consistent naming scheme for network interfaces, the **udev** device manager processes the following rule files in the listed order:

1. Optional: **/usr/lib/udev/rules.d/60-net.rules**
This file exists only if you install the **initscripts-rename-device** package. The **/usr/lib/udev/rules.d/60-net.rules** file defines that the deprecated **/usr/lib/udev/rename_device** helper utility searches for the **HWADDR** parameter in **/etc/sysconfig/network-scripts/ifcfg-*** files. If the value set in the variable matches the MAC address of an interface, the helper utility renames the interface to the name set in the **DEVICE** parameter of the **ifcfg** file.

If the system uses only NetworkManager connection profiles in keyfile format, **udev** skips this step.

2. Only on Dell systems: **/usr/lib/udev/rules.d/71-biosdevname.rules**
This file exists only if the **biosdevname** package is installed, and the rules file defines that the **biosdevname** utility renames the interface according to its naming policy, if it was not renamed in the previous step.

**NOTE**

Install and use **biosdevname** only on Dell systems.

3. **/usr/lib/udev/rules.d/75-net-description.rules**

This file defines how **udev** examines the network interface and sets the properties in **udev-**internal variables. These variables are then processed in the next step by the **/usr/lib/udev/rules.d/80-net-setup-link.rules** file. Some of the properties can be undefined.

4. **/usr/lib/udev/rules.d/80-net-setup-link.rules**

This file calls the **net_setup_link** builtin of the **udev** service, and **udev** renames the interface based on the order of the policies in the **NamePolicy** parameter in the **/usr/lib/systemd/network/99-default.link** file. For further details, see [Network interface naming policies](#).

If none of the policies applies, **udev** does not rename the interface.

Additional resources

- [Why are systemd network interface names different between major RHEL versions](#) solution

1.2. NETWORK INTERFACE NAMING POLICIES

By default, the **udev** device manager uses the **/usr/lib/systemd/network/99-default.link** file to determine which device naming policies to apply when it renames interfaces. The **NamePolicy** parameter in this file defines which policies **udev** uses and in which order:

NamePolicy=keep kernel database onboard slot path

The following table describes the different actions of **udev** based on which policy matches first as specified by the **NamePolicy** parameter:

Policy	Description	Example name
keep	If the device already has a name that was assigned in the user space, udev does not rename this device. For example, this is the case if the name was assigned during device creation or by a rename operation.	
kernel	If the kernel indicates that a device name is predictable, udev does not rename this device.	lo
database	This policy assigns names based on mappings in the udev hardware database. For details, see the hwdb(7) man page.	idrac
onboard	Device names incorporate firmware or BIOS-provided index numbers for onboard devices.	eno1
slot	Device names incorporate firmware or BIOS-provided PCI Express (PCIe) hot-plug slot-index numbers.	ens1

Policy	Description	Example name
path	Device names incorporate the physical location of the connector of the hardware.	enp1s0
mac	Device names incorporate the MAC address. By default, Red Hat Enterprise Linux does not use this policy, but administrators can enable it.	enx525400d5e0fb

Additional resources

- [How the udev device manager renames network interfaces](#)
- **systemd.link(5)** man page

1.3. NETWORK INTERFACE NAMING SCHEMES

The **udev** device manager uses certain stable interface attributes to generate consistent device names. For details about the naming schemes for different device types and platforms, see the **systemd.net-naming-scheme(7)** man page.

1.4. CUSTOMIZING THE PREFIX FOR ETHERNET INTERFACES DURING INSTALLATION

If you do not want to use the default device-naming policy for Ethernet interfaces, you can set a custom device prefix during the Red Hat Enterprise Linux (RHEL) installation.



IMPORTANT

Red Hat supports systems with customized Ethernet prefixes only if you set the prefix during the RHEL installation. Using the **prefixdevname** utility on already deployed systems is not supported.

If you set a device prefix during the installation, the **udev** service uses the **<prefix><index>** format for Ethernet interfaces after the installation. For example, if you set the prefix **net**, the service assigns the names **net0**, **net1**, and so on to the Ethernet interfaces.

The **udev** service appends the index to the custom prefix, and preserves the index values of known Ethernet interfaces. If you add an interface, **udev** assigns an index value that is one greater than the previously-assigned index value to the new interface.

Prerequisites

- The prefix consists of ASCII characters.
- The prefix is an alphanumeric string.
- The prefix is shorter than 16 characters.

- The prefix does not conflict with any other well-known network interface prefix, such as **eth**, **eno**, **ens**, and **em**.

Procedure

1. Boot the Red Hat Enterprise Linux installation media.
2. In the boot manager, follow these steps:
 - a. Select the **Install Red Hat Enterprise Linux <version>** entry.
 - b. Press **Tab** to edit the entry.
 - c. Append **net.ifnames.prefix=<prefix>** to the kernel options.
 - d. Press **Enter** to start the installation program.
3. Install Red Hat Enterprise Linux.

Verification

- To verify the interface names, display the network interfaces:

```
# ip link show
...
2: net0: <BROADCAST,MULTICAST,UP,LOWER_UP> mtu 1500 qdisc fq_codel state UP
mode DEFAULT group default qlen 1000
   link/ether 00:00:5e:00:53:1a brd ff:ff:ff:ff:ff:ff
...
```

Additional resources

- [Performing a standard RHEL 9 installation](#)

1.5. CONFIGURING USER-DEFINED NETWORK INTERFACE NAMES BY USING UDEV RULES

You can use **udev** rules to implement custom network interface names that reflect your organization's requirements.

Procedure

1. Identify the network interface that you want to rename:

```
# ip link show
...
enp1s0: <BROADCAST,MULTICAST,UP,LOWER_UP> mtu 1500 qdisc fq_codel state UP
mode DEFAULT group default qlen 1000
   link/ether 00:00:5e:00:53:1a brd ff:ff:ff:ff:ff:ff
...
```

Record the MAC address of the interface.

2. Display the device type ID of the interface:

-

```
# cat /sys/class/net/enp1s0/type
1
```

3. Create the `/etc/udev/rules.d/70-persistent-net.rules` file, and add a rule for each interface that you want to rename:

```
SUBSYSTEM=="net",ACTION=="add",ATTR{address}=="<MAC_address>",ATTR{type}
=="<device_type_id>",NAME="<new_interface_name>"
```

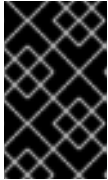

IMPORTANT

Use only **70-persistent-net.rules** as a file name if you require consistent device names during the boot process. The **dracut** utility adds a file with this name to the **initrd** image if you regenerate the RAM disk image.

For example, use the following rule to rename the interface with MAC address **00:00:5e:00:53:1a** to **provider0**:

```
SUBSYSTEM=="net",ACTION=="add",ATTR{address}=="00:00:5e:00:53:1a",ATTR{type}
=="1",NAME="provider0"
```

4. Optional: Regenerate the **initrd** RAM disk image:

```
# dracut -f
```

You require this step only if you need networking capabilities in the RAM disk. For example, this is the case if the root file system is stored on a network device, such as iSCSI.

5. Identify which NetworkManager connection profile uses the interface that you want to rename:

```
# nmcli -f device,name connection show
DEVICE NAME
enp1s0 example_profile
...
```

6. Unset the **connection.interface-name** property in the connection profile:

```
# nmcli connection modify example_profile connection.interface-name ""
```

7. Temporarily, configure the connection profile to match both the new and the previous interface name:

```
# nmcli connection modify example_profile match.interface-name "provider0 enp1s0"
```

8. Reboot the system:

```
# reboot
```

9. Verify that the device with the MAC address that you specified in the link file has been renamed to **provider0**:

```
# ip link show
```

```
provider0: <BROADCAST,MULTICAST,UP,LOWER_UP> mtu 1500 qdisc mq state UP mode
DEFAULT group default qlen 1000
link/ether 00:00:5e:00:53:1a brd ff:ff:ff:ff:ff:ff
...
```

- Configure the connection profile to match only the new interface name:

```
# nmcli connection modify example_profile match.interface-name "provider0"
```

You have now removed the old interface name from the connection profile.

- Reactivate the connection profile:

```
# nmcli connection up example_profile
```

Additional resources

- [udev\(7\)](#) man page

1.6. CONFIGURING USER-DEFINED NETWORK INTERFACE NAMES BY USING SYSTEMD LINK FILES

You can use **systemd** link files to implement custom network interface names that reflect your organization's requirements.

Prerequisites

- You must meet one of these conditions: NetworkManager does not manage this interface, or the corresponding connection profile uses the [keyfile format](#).

Procedure

- Identify the network interface that you want to rename:

```
# ip link show
...
enp1s0: <BROADCAST,MULTICAST,UP,LOWER_UP> mtu 1500 qdisc fq_codel state UP
mode DEFAULT group default qlen 1000
link/ether 00:00:5e:00:53:1a brd ff:ff:ff:ff:ff:ff
...
```

Record the MAC address of the interface.

- If it does not already exist, create the `/etc/systemd/network/` directory:

```
# mkdir -p /etc/systemd/network/
```

- For each interface that you want to rename, create a **70-*.link** file in the `/etc/systemd/network/` directory with the following content:

```
[Match]
MACAddress=<MAC_address>
```

```
[Link]
Name=<new_interface_name>
```

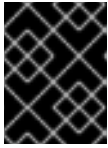

IMPORTANT

Use a file name with a **70-** prefix to keep the file names consistent with the **udev** rules-based solution.

For example, create the `/etc/systemd/network/70-provider0.link` file with the following content to rename the interface with MAC address `00:00:5e:00:53:1a` to **provider0**:

```
[Match]
MACAddress=00:00:5e:00:53:1a
```

```
[Link]
Name=provider0
```

- Optional: Regenerate the **initrd** RAM disk image:

```
# dracut -f
```

You require this step only if you need networking capabilities in the RAM disk. For example, this is the case if the root file system is stored on a network device, such as iSCSI.

- Identify which NetworkManager connection profile uses the interface that you want to rename:

```
# nmcli -f device,name connection show
DEVICE NAME
enp1s0 example_profile
...
```

- Unset the **connection.interface-name** property in the connection profile:

```
# nmcli connection modify example_profile connection.interface-name ""
```

- Temporarily, configure the connection profile to match both the new and the previous interface name:

```
# nmcli connection modify example_profile match.interface-name "provider0 enp1s0"
```

- Reboot the system:

```
# reboot
```

- Verify that the device with the MAC address that you specified in the link file has been renamed to **provider0**:

```
# ip link show
provider0: <BROADCAST,MULTICAST,UP,LOWER_UP> mtu 1500 qdisc mq state UP mode
DEFAULT group default qlen 1000
    link/ether 00:00:5e:00:53:1a brd ff:ff:ff:ff:ff:ff
...
```

- Configure the connection profile to match only the new interface name:

```
# nmcli connection modify example_profile match.interface-name "provider0"
```

You have now removed the old interface name from the connection profile.

- Reactivate the connection profile.

```
# nmcli connection up example_profile
```

Additional resources

- [systemd.link\(5\)](#) man page

1.7. ASSIGNING ALTERNATIVE NAMES TO A NETWORK INTERFACE BY USING SYSTEMD LINK FILES

With alternative interface naming, the kernel can assign additional names to network interfaces. You can use these alternative names in the same way as the normal interface names in commands that require a network interface name.

Prerequisites

- You must use ASCII characters for the alternative name.
- The alternative name must be shorter than 128 characters.

Procedure

- Display the network interface names and their MAC addresses:

```
# ip link show
...
enp1s0: <BROADCAST,MULTICAST,UP,LOWER_UP> mtu 1500 qdisc fq_codel state UP
mode DEFAULT group default qlen 1000
    link/ether 00:00:5e:00:53:1a brd ff:ff:ff:ff:ff:ff
...
```

Record the MAC address of the interface to which you want to assign an alternative name.

- If it does not already exist, create the `/etc/systemd/network/` directory:

```
# mkdir -p /etc/systemd/network/
```

- For each interface that must have an alternative name, create a `*.link` file in the `/etc/systemd/network/` directory with the following content:

```
[Match]
MACAddress=<MAC_address>

[Link]
```

```

AlternativeName=<alternative_interface_name_1>
AlternativeName=<alternative_interface_name_2>
AlternativeName=<alternative_interface_name_n>

```

For example, create the `/etc/systemd/network/70-altname.link` file with the following content to assign **provider** as an alternative name to the interface with MAC address **00:00:5e:00:53:1a**:

```

[Match]
MACAddress=00:00:5e:00:53:1a

[Link]
AlternativeName=provider

```

4. Regenerate the **initrd** RAM disk image:

```

# dracut -f

```

5. Reboot the system:

```

# reboot

```

Verification

- Use the alternative interface name. For example, display the IP address settings of the device with the alternative name **provider**:

```

# ip address show provider
2: enp1s0: <BROADCAST,MULTICAST,UP,LOWER_UP> mtu 1500 qdisc fq_codel state UP
group default qlen 1000
    link/ether 00:00:5e:00:53:1a brd ff:ff:ff:ff:ff:ff
    altname provider
    ...

```

Additional resources

- [What is AlternativeNamesPolicy in Interface naming scheme?](#)

CHAPTER 2. CONFIGURING AN ETHERNET CONNECTION

NetworkManager creates a connection profile for each Ethernet adapter that is installed in a host. By default, this profile uses DHCP for both IPv4 and IPv6 connections. Modify this automatically-created profile or add a new one in the following cases:

- The network requires custom settings, such as a static IP address configuration.
- You require multiple profiles because the host roams among different networks.

Red Hat Enterprise Linux provides administrators different options to configure Ethernet connections. For example:

- Use **nmcli** to configure connections on the command line.
- Use **nmtui** to configure connections in a text-based user interface.
- Use the GNOME Settings menu or **nm-connection-editor** application to configure connections in a graphical interface.
- Use **nmstatectl** to configure connections through the Nmstate API.
- Use RHEL system roles to automate the configuration of connections on one or multiple hosts.

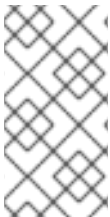

NOTE

If you want to manually configure Ethernet connections on hosts running in the Microsoft Azure cloud, disable the **cloud-init** service or configure it to ignore the network settings retrieved from the cloud environment. Otherwise, **cloud-init** will override on the next reboot the network settings that you have manually configured.

2.1. CONFIGURING AN ETHERNET CONNECTION BY USING NMCLI

If you connect a host to the network over Ethernet, you can manage the connection's settings on the command line by using the **nmcli** utility.

Prerequisites

- A physical or virtual Ethernet Network Interface Controller (NIC) exists in the server's configuration.

Procedure

1. List the NetworkManager connection profiles:

```
# nmcli connection show
NAME                UUID                                TYPE  DEVICE
Wired connection 1  a5eb6490-cc20-3668-81f8-0314a27f3f75  ethernet  enp1s0
```

By default, NetworkManager creates a profile for each NIC in the host. If you plan to connect this NIC only to a specific network, adapt the automatically-created profile. If you plan to connect this NIC to networks with different settings, create individual profiles for each network.

2. If you want to create an additional connection profile, enter:

```
# nmcli connection add con-name <connection-name> ifname <device-name> type ethernet
```

Skip this step to modify an existing profile.

- Optional: Rename the connection profile:

```
# nmcli connection modify "Wired connection 1" connection.id "Internal-LAN"
```

On hosts with multiple profiles, a meaningful name makes it easier to identify the purpose of a profile.

- Display the current settings of the connection profile:

```
# nmcli connection show Internal-LAN
...
connection.interface-name: enp1s0
connection.autoconnect:   yes
ipv4.method:              auto
ipv6.method:              auto
...
```

- Configure the IPv4 settings:

- To use DHCP, enter:

```
# nmcli connection modify Internal-LAN ipv4.method auto
```

Skip this step if **ipv4.method** is already set to **auto** (default).

- To set a static IPv4 address, network mask, default gateway, DNS servers, and search domain, enter:

```
# nmcli connection modify Internal-LAN ipv4.method manual ipv4.addresses 192.0.2.1/24 ipv4.gateway 192.0.2.254 ipv4.dns 192.0.2.200 ipv4.dns-search example.com
```

- Configure the IPv6 settings:

- To use stateless address autoconfiguration (SLAAC), enter:

```
# nmcli connection modify Internal-LAN ipv6.method auto
```

Skip this step if **ipv6.method** is already set to **auto** (default).

- To set a static IPv6 address, network mask, default gateway, DNS servers, and search domain, enter:

```
# nmcli connection modify Internal-LAN ipv6.method manual ipv6.addresses 2001:db8:1::fffe/64 ipv6.gateway 2001:db8:1::fffe ipv6.dns 2001:db8:1::ffbb ipv6.dns-search example.com
```

- To customize other settings in the profile, use the following command:

```
# nmcli connection modify <connection-name> <setting> <value>
```

Enclose values with spaces or semicolons in quotes.

8. Activate the profile:

```
# nmcli connection up Internal-LAN
```

Verification

1. Display the IP settings of the NIC:

```
# ip address show enp1s0
2: enp1s0: <BROADCAST,MULTICAST,UP,LOWER_UP> mtu 1500 qdisc fq_codel state UP
group default qlen 1000
    link/ether 52:54:00:17:b8:b6 brd ff:ff:ff:ff:ff:ff
    inet 192.0.2.1/24 brd 192.0.2.255 scope global noprefixroute enp1s0
        valid_lft forever preferred_lft forever
    inet6 2001:db8:1::ffe/64 scope global noprefixroute
        valid_lft forever preferred_lft forever
```

2. Display the IPv4 default gateway:

```
# ip route show default
default via 192.0.2.254 dev enp1s0 proto static metric 102
```

3. Display the IPv6 default gateway:

```
# ip -6 route show default
default via 2001:db8:1::fee dev enp1s0 proto static metric 102 pref medium
```

4. Display the DNS settings:

```
# cat /etc/resolv.conf
search example.com
nameserver 192.0.2.200
nameserver 2001:db8:1::ffbb
```

If multiple connection profiles are active at the same time, the order of **nameserver** entries depend on the DNS priority values in these profile and the connection types.

5. Use the **ping** utility to verify that this host can send packets to other hosts:

```
# ping <host-name-or-IP-address>
```

Troubleshooting

- Verify that the network cable is plugged-in to the host and a switch.
- Check whether the link failure exists only on this host or also on other hosts connected to the same switch.

- Verify that the network cable and the network interface are working as expected. Perform hardware diagnosis steps and replace defect cables and network interface cards.
- If the configuration on the disk does not match the configuration on the device, starting or restarting NetworkManager creates an in-memory connection that reflects the configuration of the device. For further details and how to avoid this problem, see the [NetworkManager duplicates a connection after restart of NetworkManager service](#) solution.

Additional resources

- [nm-settings\(5\)](#) man page
- [Configuring NetworkManager to avoid using a specific profile to provide a default gateway](#)
- [Configuring the order of DNS servers](#)

2.2. CONFIGURING AN ETHERNET CONNECTION BY USING THE NMCLI INTERACTIVE EDITOR

If you connect a host to the network over Ethernet, you can manage the connection's settings on the command line by using the **nmcli** utility.

Prerequisites

- A physical or virtual Ethernet Network Interface Controller (NIC) exists in the server's configuration.

Procedure

1. List the NetworkManager connection profiles:

```
# nmcli connection show
NAME                UUID                                TYPE  DEVICE
Wired connection 1  a5eb6490-cc20-3668-81f8-0314a27f3f75  ethernet  enp1s0
```

By default, NetworkManager creates a profile for each NIC in the host. If you plan to connect this NIC only to a specific network, adapt the automatically-created profile. If you plan to connect this NIC to networks with different settings, create individual profiles for each network.

2. Start **nmcli** in interactive mode:

- To create an additional connection profile, enter:

```
# nmcli connection edit type ethernet con-name "<connection-name>"
```

- To modify an existing connection profile, enter:

```
# nmcli connection edit con-name "<connection-name>"
```

3. Optional: Rename the connection profile:

```
nmcli> set connection.id Internal-LAN
```

On hosts with multiple profiles, a meaningful name makes it easier to identify the purpose of a profile.

Do not use quotes to set an ID that contains spaces to avoid that **nmcli** makes the quotes part of the name. For example, to set **Example Connection** as ID, enter **set connection.id Example Connection**.

4. Display the current settings of the connection profile:

```
nmcli> print
...
connection.interface-name: enp1s0
connection.autoconnect:   yes
ipv4.method:              auto
ipv6.method:              auto
...
```

5. If you create a new connection profile, set the network interface:

```
nmcli> set connection.interface-name enp1s0
```

6. Configure the IPv4 settings:

- To use DHCP, enter:

```
nmcli> set ipv4.method auto
```

Skip this step if **ipv4.method** is already set to **auto** (default).

- To set a static IPv4 address, network mask, default gateway, DNS servers, and search domain, enter:

```
nmcli> ipv4.addresses 192.0.2.1/24
Do you also want to set 'ipv4.method' to 'manual'? [yes]: yes
nmcli> ipv4.gateway 192.0.2.254
nmcli> ipv4.dns 192.0.2.200
nmcli> ipv4.dns-search example.com
```

7. Configure the IPv6 settings:

- To use stateless address autoconfiguration (SLAAC), enter:

```
nmcli> set ipv6.method auto
```

Skip this step if **ipv6.method** is already set to **auto** (default).

- To set a static IPv6 address, network mask, default gateway, DNS servers, and search domain, enter:

```
nmcli> ipv6.addresses 2001:db8:1::ffe/64
Do you also want to set 'ipv6.method' to 'manual'? [yes]: yes
nmcli> ipv6.gateway 2001:db8:1::ffe
nmcli> ipv6.dns 2001:db8:1::ffbb
nmcli> ipv6.dns-search example.com
```

- Save and activate the connection:

```
nmcli> save persistent
```

- Leave the interactive mode:

```
nmcli> quit
```

Verification

- Display the IP settings of the NIC:

```
# ip address show enp1s0
2: enp1s0: <BROADCAST,MULTICAST,UP,LOWER_UP> mtu 1500 qdisc fq_codel state UP
group default qlen 1000
    link/ether 52:54:00:17:b8:b6 brd ff:ff:ff:ff:ff:ff
    inet 192.0.2.1/24 brd 192.0.2.255 scope global noprefixroute enp1s0
        valid_lft forever preferred_lft forever
    inet6 2001:db8:1::ffe/64 scope global noprefixroute
        valid_lft forever preferred_lft forever
```

- Display the IPv4 default gateway:

```
# ip route show default
default via 192.0.2.254 dev enp1s0 proto static metric 102
```

- Display the IPv6 default gateway:

```
# ip -6 route show default
default via 2001:db8:1::fee dev enp1s0 proto static metric 102 pref medium
```

- Display the DNS settings:

```
# cat /etc/resolv.conf
search example.com
nameserver 192.0.2.200
nameserver 2001:db8:1::ffbb
```

If multiple connection profiles are active at the same time, the order of **nameserver** entries depend on the DNS priority values in these profile and the connection types.

- Use the **ping** utility to verify that this host can send packets to other hosts:

```
# ping <host-name-or-IP-address>
```

Troubleshooting

- Verify that the network cable is plugged-in to the host and a switch.
- Check whether the link failure exists only on this host or also on other hosts connected to the same switch.

- Verify that the network cable and the network interface are working as expected. Perform hardware diagnosis steps and replace defect cables and network interface cards.
- If the configuration on the disk does not match the configuration on the device, starting or restarting NetworkManager creates an in-memory connection that reflects the configuration of the device. For further details and how to avoid this problem, see the [NetworkManager duplicates a connection after restart of NetworkManager service](#) solution

Additional resources

- [nm-settings\(5\)](#) man page
- [nmcli\(1\)](#) man page
- [Configuring NetworkManager to avoid using a specific profile to provide a default gateway](#)
- [Configuring the order of DNS servers](#)

2.3. CONFIGURING AN ETHERNET CONNECTION BY USING NMTUI

If you connect a host to the network over Ethernet, you can manage the connection's settings in a text-based user interface by using the `nmtui` application. Use `nmtui` to create new profiles and to update existing ones on a host without a graphical interface.



NOTE

In `nmtui`:

- Navigate by using the cursor keys.
- Press a button by selecting it and hitting **Enter**.
- Select and deselect checkboxes by using **Space**.

Prerequisites

- A physical or virtual Ethernet Network Interface Controller (NIC) exists in the server's configuration.

Procedure

1. If you do not know the network device name you want to use in the connection, display the available devices:

```
# nmcli device status
DEVICE  TYPE    STATE      CONNECTION
enp1s0  ethernet unavailable --
...
```

2. Start `nmtui`:

```
# nmtui
```

3. Select **Edit a connection**, and press **Enter**.

4. Choose whether to add a new connection profile or to modify an existing one:
 - To create a new profile:
 - i. Press the **Add** button.
 - ii. Select **Ethernet** from the list of network types, and press **Enter**.
 - To modify an existing profile, select the profile from the list, and press **Enter**.
5. Optional: Update the name of the connection profile.

On hosts with multiple profiles, a meaningful name makes it easier to identify the purpose of a profile.
6. If you create a new connection profile, enter the network device name into the **Device** field.
7. Depending on your environment, configure the IP address settings in the **IPv4 configuration** and **IPv6 configuration** areas accordingly. For this, press the button next to these areas, and select:
 - **Disabled**, if this connection does not require an IP address.
 - **Automatic**, if a DHCP server dynamically assigns an IP address to this NIC.
 - **Manual**, if the network requires static IP address settings. In this case, you must fill further fields:
 - i. Press the **Show** button next to the protocol you want to configure to display additional fields.
 - ii. Press the **Add** button next to **Addresses**, and enter the IP address and the subnet mask in Classless Inter-Domain Routing (CIDR) format.

If you do not specify a subnet mask, NetworkManager sets a **/32** subnet mask for IPv4 addresses and **/64** for IPv6 addresses.
 - iii. Enter the address of the default gateway.
 - iv. Press the **Add** button next to **DNS servers**, and enter the DNS server address.
 - v. Press the **Add** button next to **Search domains**, and enter the DNS search domain.

Figure 2.1. Example of an Ethernet connection with static IP address settings

Edit Connection

Profile name `Example-Connection`
 Device `enp7s0`

= ETHERNET <Show>

IPv4 CONFIGURATION `<Manual>` <Hide>

Addresses `192.0.2.1/24` <Remove>
<Add...>

Gateway `192.0.2.254`

DNS servers `192.0.2.200` <Remove>
<Add...>

Search domains `example.com` <Remove>
<Add...>

Routing (No custom routes) <Edit...>

Never use this network for default route
 Ignore automatically obtained routes
 Ignore automatically obtained DNS parameters

Require IPv4 addressing for this connection

IPv6 CONFIGURATION `<Manual>` <Hide>

Addresses `2001:db8:1::1/64` <Remove>
<Add...>

Gateway `2001:db8:1::fffe`

DNS servers `2001:db8:1::ffbb` <Remove>
<Add...>

Search domains `example.com` <Remove>
<Add...>

Routing (No custom routes) <Edit...>

Never use this network for default route
 Ignore automatically obtained routes
 Ignore automatically obtained DNS parameters

Require IPv6 addressing for this connection

Automatically connect
 Available to all users

<Cancel> <OK>

8. Press the **OK** button to create and automatically activate the new connection.
9. Press the **Back** button to return to the main menu.
10. Select **Quit**, and press **Enter** to close the **nmtui** application.

Verification

1. Display the IP settings of the NIC:

```
# ip address show enp1s0
```

```
2: enp1s0: <BROADCAST,MULTICAST,UP,LOWER_UP> mtu 1500 qdisc fq_codel state UP
group default qlen 1000
link/ether 52:54:00:17:b8:b6 brd ff:ff:ff:ff:ff:ff
```



```
inet 192.0.2.1/24 brd 192.0.2.255 scope global noprefixroute enp1s0
    valid_lft forever preferred_lft forever
inet6 2001:db8:1::fffe/64 scope global noprefixroute
    valid_lft forever preferred_lft forever
```

2. Display the IPv4 default gateway:

```
# ip route show default
default via 192.0.2.254 dev enp1s0 proto static metric 102
```

3. Display the IPv6 default gateway:

```
# ip -6 route show default
default via 2001:db8:1::ffee dev enp1s0 proto static metric 102 pref medium
```

4. Display the DNS settings:

```
# cat /etc/resolv.conf
search example.com
nameserver 192.0.2.200
nameserver 2001:db8:1::ffbb
```

If multiple connection profiles are active at the same time, the order of **nameserver** entries depend on the DNS priority values in these profile and the connection types.

5. Use the **ping** utility to verify that this host can send packets to other hosts:

```
# ping <host-name-or-IP-address>
```

Troubleshooting

- Verify that the network cable is plugged-in to the host and a switch.
- Check whether the link failure exists only on this host or also on other hosts connected to the same switch.
- Verify that the network cable and the network interface are working as expected. Perform hardware diagnosis steps and replace defect cables and network interface cards.
- If the configuration on the disk does not match the configuration on the device, starting or restarting NetworkManager creates an in-memory connection that reflects the configuration of the device. For further details and how to avoid this problem, see the [NetworkManager duplicates a connection after restart of NetworkManager service](#) solution.

Additional resources

- [Configuring NetworkManager to avoid using a specific profile to provide a default gateway](#)
- [Configuring the order of DNS servers](#)

2.4. CONFIGURING AN ETHERNET CONNECTION BY USING CONTROL-CENTER

If you connect a host to the network over Ethernet, you can manage the connection's settings with a graphical interface by using the GNOME Settings menu.

Note that **control-center** does not support as many configuration options as the **nm-connection-editor** application or the **nmcli** utility.

Prerequisites

- A physical or virtual Ethernet Network Interface Controller (NIC) exists in the server's configuration.
- GNOME is installed.

Procedure

1. Press the **Super** key, enter **Settings**, and press **Enter**.
2. Select **Network** in the navigation on the left.
3. Choose whether to add a new connection profile or to modify an existing one:
 - To create a new profile, click the **+** button next to the **Ethernet** entry.
 - To modify an existing profile, click the gear icon next to the profile entry.
4. Optional: On the **Identity** tab, update the name of the connection profile.
On hosts with multiple profiles, a meaningful name makes it easier to identify the purpose of a profile.
5. Depending on your environment, configure the IP address settings on the **IPv4** and **IPv6** tabs accordingly:
 - To use DHCP or IPv6 stateless address autoconfiguration (SLAAC), select **Automatic (DHCP)** as method (default).
 - To set a static IP address, network mask, default gateway, DNS servers, and search domain, select **Manual** as method, and fill the fields on the tabs:

The image shows two side-by-side screenshots of the 'New Profile' dialog box in GNOME Settings. Both screenshots have 'Cancel' on the top left and 'Add' on the top right. The left screenshot is on the 'IPv4' tab, showing the 'IPv4 Method' section with 'Manual' selected (indicated by a blue dot). Below it, the 'Addresses' section has a table with columns for Address, Netmask, and Gateway. The first row contains '192.0.2.1', '24', and '192.0.2.254'. The 'DNS' section has a text field containing '192.0.2.1' and an 'Automatic' toggle switch that is turned off. The right screenshot is on the 'IPv6' tab, showing the 'IPv6 Method' section with 'Manual' selected. The 'Addresses' section has a table with columns for Address, Prefix, and Gateway. The first row contains '2001:db8:1::1', '64', and '2001:db8:1::fff3'. The 'DNS' section has a text field containing '2001:db8:1::fffd' and an 'Automatic' toggle switch that is turned off. Both screenshots have a small note at the bottom: 'Separate IP addresses with commas'.

6. Depending on whether you add or modify a connection profile, click the **Add** or **Apply** button to save the connection.
The GNOME **control-center** automatically activates the connection.

Verification

1. Display the IP settings of the NIC:

ip address show enp1s0

```
2: enp1s0: <BROADCAST,MULTICAST,UP,LOWER_UP> mtu 1500 qdisc fq_codel state UP
group default qlen 1000
link/ether 52:54:00:17:b8:b6 brd ff:ff:ff:ff:ff:ff
inet 192.0.2.1/24 brd 192.0.2.255 scope global noprefixroute enp1s0
    valid_lft forever preferred_lft forever
inet6 2001:db8:1::ffe/64 scope global noprefixroute
    valid_lft forever preferred_lft forever
```

2. Display the IPv4 default gateway:

ip route show default

```
default via 192.0.2.254 dev enp1s0 proto static metric 102
```

3. Display the IPv6 default gateway:

ip -6 route show default

```
default via 2001:db8:1::fee dev enp1s0 proto static metric 102 pref medium
```

4. Display the DNS settings:

cat /etc/resolv.conf

```
search example.com
nameserver 192.0.2.200
nameserver 2001:db8:1::ffbb
```

If multiple connection profiles are active at the same time, the order of **nameserver** entries depend on the DNS priority values in these profile and the connection types.

5. Use the **ping** utility to verify that this host can send packets to other hosts:

```
# ping <host-name-or-IP-address>
```

Troubleshooting steps

- Verify that the network cable is plugged-in to the host and a switch.
- Check whether the link failure exists only on this host or also on other hosts connected to the same switch.
- Verify that the network cable and the network interface are working as expected. Perform hardware diagnosis steps and replace defect cables and network interface cards.
- If the configuration on the disk does not match the configuration on the device, starting or restarting NetworkManager creates an in-memory connection that reflects the configuration of the device. For further details and how to avoid this problem, see the [NetworkManager duplicates a connection after restart of NetworkManager service](#) solution.

Additional Resources

- [Configuring NetworkManager to avoid using a specific profile to provide a default gateway](#)
- [Configuring the order of DNS servers](#)

2.5. CONFIGURING AN ETHERNET CONNECTION BY USING NM-CONNECTION-EDITOR

If you connect a host to the network over Ethernet, you can manage the connection's settings with a graphical interface by using the `nm-connection-editor` application.

Prerequisites

- A physical or virtual Ethernet Network Interface Controller (NIC) exists in the server's configuration.
- GNOME is installed.

Procedure

1. Open a terminal, and enter:

```
$ nm-connection-editor
```

2. Choose whether to add a new connection profile or to modify an existing one:

- To create a new profile:
 - i. Click the **+** button
 - ii. Select **Ethernet** as connection type, and click **Create**.
- To modify an existing profile, double-click the profile entry.

3. Optional: Update the name of the profile in the **Connection Name** field.

On hosts with multiple profiles, a meaningful name makes it easier to identify the purpose of a profile.

4. If you create a new profile, select the device on the **Ethernet** tab:

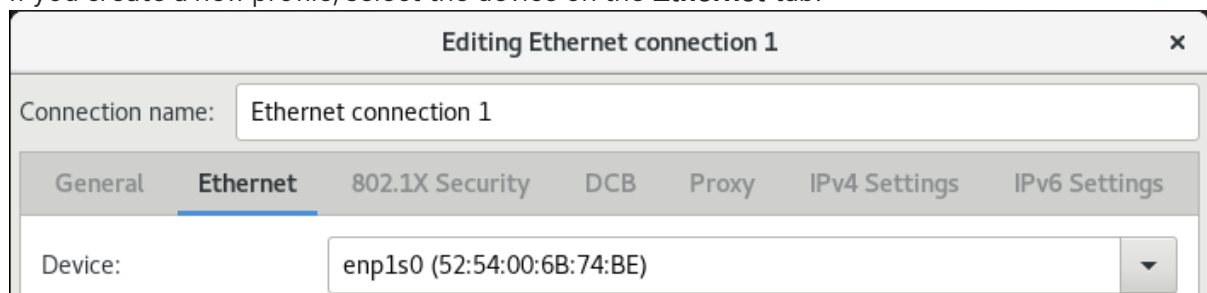

5. Depending on your environment, configure the IP address settings on the **IPv4 Settings** and **IPv6 Settings** tabs accordingly:

- To use DHCP or IPv6 stateless address autoconfiguration (SLAAC), select **Automatic (DHCP)** as method (default).
- To set a static IP address, network mask, default gateway, DNS servers, and search domain, select **Manual** as method, and fill the fields on the tabs:

6. Click **Save**.
7. Close `nm-connection-editor`.

Verification

1. Display the IP settings of the NIC:

```
# ip address show enp1s0
2: enp1s0: <BROADCAST,MULTICAST,UP,LOWER_UP> mtu 1500 qdisc fq_codel state UP
group default qlen 1000
link/ether 52:54:00:17:b8:b6 brd ff:ff:ff:ff:ff:ff
inet 192.0.2.1/24 brd 192.0.2.255 scope global noprefixroute enp1s0
    valid_lft forever preferred_lft forever
inet6 2001:db8:1::ffe/64 scope global noprefixroute
    valid_lft forever preferred_lft forever
```

2. Display the IPv4 default gateway:

```
# ip route show default
default via 192.0.2.254 dev enp1s0 proto static metric 102
```

3. Display the IPv6 default gateway:

```
# ip -6 route show default
default via 2001:db8:1::fee dev enp1s0 proto static metric 102 pref medium
```

4. Display the DNS settings:

```
# cat /etc/resolv.conf
search example.com
nameserver 192.0.2.200
nameserver 2001:db8:1::ffbb
```

If multiple connection profiles are active at the same time, the order of **nameserver** entries depend on the DNS priority values in these profile and the connection types.

5. Use the **ping** utility to verify that this host can send packets to other hosts:

```
# ping <host-name-or-IP-address>
```

Troubleshooting steps

- Verify that the network cable is plugged-in to the host and a switch.

- Check whether the link failure exists only on this host or also on other hosts connected to the same switch.
- Verify that the network cable and the network interface are working as expected. Perform hardware diagnosis steps and replace defect cables and network interface cards.
- If the configuration on the disk does not match the configuration on the device, starting or restarting NetworkManager creates an in-memory connection that reflects the configuration of the device. For further details and how to avoid this problem, see the [NetworkManager duplicates a connection after restart of NetworkManager service](#) solution.

Additional Resources

- [Configuring NetworkManager to avoid using a specific profile to provide a default gateway](#)
- [Configuring the order of DNS servers](#)

2.6. CONFIGURING AN ETHERNET CONNECTION WITH A STATIC IP ADDRESS BY USING NMSTATECTL

Use the **nmstatectl** utility to configure an Ethernet connection through the Nmstate API. The Nmstate API ensures that, after setting the configuration, the result matches the configuration file. If anything fails, **nmstatectl** automatically rolls back the changes to avoid leaving the system in an incorrect state.

Prerequisites

- A physical or virtual Ethernet Network Interface Controller (NIC) exists in the server's configuration.
- The **nmstate** package is installed.

Procedure

1. Create a YAML file, for example `~/create-ethernet-profile.yml`, with the following content:

```
---
interfaces:
- name: enp1s0
  type: ethernet
  state: up
  ipv4:
    enabled: true
    address:
    - ip: 192.0.2.1
      prefix-length: 24
    dhcp: false
  ipv6:
    enabled: true
    address:
    - ip: 2001:db8:1::1
      prefix-length: 64
    autoconf: false
    dhcp: false
routes:
  config:
```

```

- destination: 0.0.0.0/0
  next-hop-address: 192.0.2.254
  next-hop-interface: enp1s0
- destination: ::0
  next-hop-address: 2001:db8:1::fffe
  next-hop-interface: enp1s0
dns-resolver:
config:
search:
- example.com
server:
- 192.0.2.200
- 2001:db8:1::ffbb

```

These settings define an Ethernet connection profile for the **enp1s0** device with the following settings:

- A static IPv4 address - **192.0.2.1** with the **/24** subnet mask
- A static IPv6 address - **2001:db8:1::1** with the **/64** subnet mask
- An IPv4 default gateway - **192.0.2.254**
- An IPv6 default gateway - **2001:db8:1::fffe**
- An IPv4 DNS server - **192.0.2.200**
- An IPv6 DNS server - **2001:db8:1::ffbb**
- A DNS search domain - **example.com**

NOTE

You can define **identifier: mac-address** and **mac-address: <ACTUAL-NIC-MACADDRESS>** properties directly to the **interfaces** property to identify the network interface card by its MAC address instead of its name (such as **enp1s0**).

For example:

```

---
interfaces:
- name: <profile-name>
  type: ethernet
  identifier: mac-address
  mac-address: <ACTUAL-NIC-MACADDRESS>
  state: up
  ipv4:
    enabled: true
    auto-dns: true
    auto-gateway: true
    auto-routes: true
  dhcp: true
...

```

2. Apply the settings to the system:

```
# nmstatectl apply ~/create-ethernet-profile.yml
```

Verification

1. Display the current state in YAML format:

```
# nmstatectl show enp1s0
```

2. Display the IP settings of the NIC:

```
# ip address show enp1s0
2: enp1s0: <BROADCAST,MULTICAST,UP,LOWER_UP> mtu 1500 qdisc fq_codel state UP
group default qlen 1000
    link/ether 52:54:00:17:b8:b6 brd ff:ff:ff:ff:ff:ff
    inet 192.0.2.1/24 brd 192.0.2.255 scope global noprefixroute enp1s0
        valid_lft forever preferred_lft forever
    inet6 2001:db8:1::fffe/64 scope global noprefixroute
        valid_lft forever preferred_lft forever
```

3. Display the IPv4 default gateway:

```
# ip route show default
default via 192.0.2.254 dev enp1s0 proto static metric 102
```

4. Display the IPv6 default gateway:

```
# ip -6 route show default
default via 2001:db8:1::fffe dev enp1s0 proto static metric 102 pref medium
```

5. Display the DNS settings:

```
# cat /etc/resolv.conf
search example.com
nameserver 192.0.2.200
nameserver 2001:db8:1::ffbb
```

If multiple connection profiles are active at the same time, the order of **nameserver** entries depend on the DNS priority values in these profile and the connection types.

6. Use the **ping** utility to verify that this host can send packets to other hosts:

```
# ping <host-name-or-IP-address>
```

Additional resources

- **nmstatectl(8)** man page
- **/usr/share/doc/nmstate/examples/** directory

2.7. CONFIGURING AN ETHERNET CONNECTION WITH A STATIC IP ADDRESS BY USING THE NETWORK RHEL SYSTEM ROLE WITH AN INTERFACE NAME

You can remotely configure an Ethernet connection by using the **network** RHEL system role.

Prerequisites

- You have prepared the control node and the managed nodes
- You are logged in to the control node as a user who can run playbooks on the managed nodes.
- The account you use to connect to the managed nodes has **sudo** permissions on them.
- A physical or virtual Ethernet device exists in the server's configuration.
- The managed nodes use NetworkManager to configure the network.

Procedure

1. Create a playbook file, for example `~/playbook.yml`, with the following content:

```
---
- name: Configure the network
  hosts: managed-node-01.example.com
  tasks:
    - name: Configure an Ethernet connection with static IP
      ansible.builtin.include_role:
        name: rhel-system-roles.network
      vars:
        network_connections:
          - name: enp1s0
            interface_name: enp1s0
            type: ethernet
            autoconnect: yes
            ip:
              address:
                - 192.0.2.1/24
                - 2001:db8:1::1/64
              gateway4: 192.0.2.254
              gateway6: 2001:db8:1::ffe
            dns:
              - 192.0.2.200
              - 2001:db8:1::ffbb
            dns_search:
              - example.com
            state: up
```

These settings define an Ethernet connection profile for the **enp1s0** device with the following settings:

- A static IPv4 address - **192.0.2.1** with a **/24** subnet mask
- A static IPv6 address - **2001:db8:1::1** with a **/64** subnet mask

- An IPv4 default gateway - **192.0.2.254**
- An IPv6 default gateway - **2001:db8:1::ffe**
- An IPv4 DNS server - **192.0.2.200**
- An IPv6 DNS server - **2001:db8:1::ffbb**
- A DNS search domain - **example.com**

2. Validate the playbook syntax:

```
$ ansible-playbook --syntax-check ~/playbook.yml
```

Note that this command only validates the syntax and does not protect against a wrong but valid configuration.

3. Run the playbook:

```
$ ansible-playbook ~/playbook.yml
```

Additional resources

- `/usr/share/ansible/roles/rhel-system-roles.network/README.md` file
- `/usr/share/doc/rhel-system-roles/network/` directory

2.8. CONFIGURING AN ETHERNET CONNECTION WITH A STATIC IP ADDRESS BY USING THE NETWORK RHEL SYSTEM ROLE WITH A DEVICE PATH

You can remotely configure an Ethernet connection using the **network** RHEL system role.

You can identify the device path with the following command:

```
# udevadm info /sys/class/net/<device_name> | grep ID_PATH=
```

Prerequisites

- [You have prepared the control node and the managed nodes](#)
- You are logged in to the control node as a user who can run playbooks on the managed nodes.
- The account you use to connect to the managed nodes has **sudo** permissions on them.
- A physical or virtual Ethernet device exists in the server's configuration.
- The managed nodes use NetworkManager to configure the network.

Procedure

1. Create a playbook file, for example `~/playbook.yml`, with the following content:

```

---
- name: Configure the network
  hosts: managed-node-01.example.com
  tasks:
    - name: Configure an Ethernet connection with static IP
      ansible.builtin.include_role:
        name: rhel-system-roles.network
      vars:
        network_connections:
          - name: example
            match:
              path:
                - pci-0000:00:0[1-3].0
                - &!pci-0000:00:02.0
            type: ethernet
            autoconnect: yes
            ip:
              address:
                - 192.0.2.1/24
                - 2001:db8:1::1/64
              gateway4: 192.0.2.254
              gateway6: 2001:db8:1::fffe
            dns:
              - 192.0.2.200
              - 2001:db8:1::ffbb
            dns_search:
              - example.com
            state: up

```

These settings define an Ethernet connection profile with the following settings:

- A static IPv4 address - **192.0.2.1** with a **/24** subnet mask
- A static IPv6 address - **2001:db8:1::1** with a **/64** subnet mask
- An IPv4 default gateway - **192.0.2.254**
- An IPv6 default gateway - **2001:db8:1::fffe**
- An IPv4 DNS server - **192.0.2.200**
- An IPv6 DNS server - **2001:db8:1::ffbb**
- A DNS search domain - **example.com**

The **match** parameter in this example defines that Ansible applies the play to devices that match PCI ID **0000:00:0[1-3].0**, but not **0000:00:02.0**. For further details about special modifiers and wild cards you can use, see the **match** parameter description in the **/usr/share/ansible/roles/rhel-system-roles.network/README.md** file.

2. Validate the playbook syntax:

```
$ ansible-playbook --syntax-check ~/playbook.yml
```

Note that this command only validates the syntax and does not protect against a wrong but valid configuration.

3. Run the playbook:

```
$ ansible-playbook ~/playbook.yml
```

Additional resources

- `/usr/share/ansible/roles/rhel-system-roles.network/README.md` file
- `/usr/share/doc/rhel-system-roles/network/` directory

2.9. CONFIGURING AN ETHERNET CONNECTION WITH A DYNAMIC IP ADDRESS BY USING NMSTATECTL

Use the `nmstatectl` utility to configure an Ethernet connection through the Nmstate API. The Nmstate API ensures that, after setting the configuration, the result matches the configuration file. If anything fails, `nmstatectl` automatically rolls back the changes to avoid leaving the system in an incorrect state.

Prerequisites

- A physical or virtual Ethernet Network Interface Controller (NIC) exists in the server's configuration.
- A DHCP server is available in the network.
- The `nmstate` package is installed.

Procedure

1. Create a YAML file, for example `~/create-ethernet-profile.yml`, with the following content:

```
---
interfaces:
- name: enp1s0
  type: ethernet
  state: up
  ipv4:
    enabled: true
    auto-dns: true
    auto-gateway: true
    auto-routes: true
    dhcp: true
  ipv6:
    enabled: true
    auto-dns: true
    auto-gateway: true
    auto-routes: true
    autoconf: true
    dhcp: true
```

These settings define an Ethernet connection profile for the `enp1s0` device. The connection retrieves IPv4 addresses, IPv6 addresses, default gateway, routes, DNS servers, and search domains from a DHCP server and IPv6 stateless address autoconfiguration (SLAAC).



NOTE

You can define **identifier: mac-address** and **mac-address: <ACTUAL-NIC-MACADDRESS>** properties directly to the **interfaces** property to identify the network interface card by its MAC address instead of its name (such as **enp1s0**).

For example:

```
---
interfaces:
- name: <profile-name>
  type: ethernet
  identifier: mac-address
  mac-address: <ACTUAL-NIC-MACADDRESS>
  state: up
  ipv4:
    enabled: true
    auto-dns: true
    auto-gateway: true
    auto-routes: true
    dhcp: true
  ...
```

2. Apply the settings to the system:

```
# nmstatectl apply ~/create-ethernet-profile.yml
```

Verification

1. Display the current state in YAML format:

```
# nmstatectl show enp1s0
```

2. Display the IP settings of the NIC:

```
# ip address show enp1s0
2: enp1s0: <BROADCAST,MULTICAST,UP,LOWER_UP> mtu 1500 qdisc fq_codel state UP
group default qlen 1000
link/ether 52:54:00:17:b8:b6 brd ff:ff:ff:ff:ff:ff
inet 192.0.2.1/24 brd 192.0.2.255 scope global noprefixroute enp1s0
    valid_lft forever preferred_lft forever
inet6 2001:db8:1::ffe/64 scope global noprefixroute
    valid_lft forever preferred_lft forever
```

3. Display the IPv4 default gateway:

```
# ip route show default
default via 192.0.2.254 dev enp1s0 proto static metric 102
```

4. Display the IPv6 default gateway:

```
# ip -6 route show default
default via 2001:db8:1::ffe dev enp1s0 proto static metric 102 pref medium
```

5. Display the DNS settings:

```
# cat /etc/resolv.conf
search example.com
nameserver 192.0.2.200
nameserver 2001:db8:1::ffbb
```

If multiple connection profiles are active at the same time, the order of **nameserver** entries depend on the DNS priority values in these profile and the connection types.

6. Use the **ping** utility to verify that this host can send packets to other hosts:

```
# ping <host-name-or-IP-address>
```

Additional resources

- **nmstatectl(8)** man page
- `/usr/share/doc/nmstate/examples/` directory

2.10. CONFIGURING AN ETHERNET CONNECTION WITH A DYNAMIC IP ADDRESS BY USING THE NETWORK RHEL SYSTEM ROLE WITH AN INTERFACE NAME

You can remotely configure an Ethernet connection using the **network** RHEL system role. For connections with dynamic IP address settings, NetworkManager requests the IP settings for the connection from a DHCP server.

Prerequisites

- [You have prepared the control node and the managed nodes](#)
- You are logged in to the control node as a user who can run playbooks on the managed nodes.
- The account you use to connect to the managed nodes has **sudo** permissions on them.
- A physical or virtual Ethernet device exists in the server's configuration.
- A DHCP server is available in the network
- The managed nodes use NetworkManager to configure the network.

Procedure

1. Create a playbook file, for example `~/playbook.yml`, with the following content:

```
---
- name: Configure the network
  hosts: managed-node-01.example.com
  tasks:
    - name: Configure an Ethernet connection with dynamic IP
      ansible.builtin.include_role:
        name: rhel-system-roles.network
      vars:
```

```
network_connections:
- name: enp1s0
  interface_name: enp1s0
  type: ethernet
  autoconnect: yes
  ip:
    dhcp4: yes
    auto6: yes
  state: up
```

These settings define an Ethernet connection profile for the **enp1s0** device. The connection retrieves IPv4 addresses, IPv6 addresses, default gateway, routes, DNS servers, and search domains from a DHCP server and IPv6 stateless address autoconfiguration (SLAAC).

2. Validate the playbook syntax:

```
$ ansible-playbook --syntax-check ~/playbook.yml
```

Note that this command only validates the syntax and does not protect against a wrong but valid configuration.

3. Run the playbook:

```
$ ansible-playbook ~/playbook.yml
```

Additional resources

- `/usr/share/ansible/roles/rhel-system-roles.network/README.md` file
- `/usr/share/doc/rhel-system-roles/network/` directory

2.11. CONFIGURING AN ETHERNET CONNECTION WITH A DYNAMIC IP ADDRESS BY USING THE NETWORK RHEL SYSTEM ROLE WITH A DEVICE PATH

You can remotely configure an Ethernet connection using the **network** RHEL system role. For connections with dynamic IP address settings, NetworkManager requests the IP settings for the connection from a DHCP server.

You can identify the device path with the following command:

```
# udevadm info /sys/class/net/<device_name> | grep ID_PATH=
```

Prerequisites

- You have prepared the control node and the managed nodes
- You are logged in to the control node as a user who can run playbooks on the managed nodes.
- The account you use to connect to the managed nodes has **sudo** permissions on them.
- A physical or virtual Ethernet device exists in the server's configuration.

- A DHCP server is available in the network.
- The managed hosts use NetworkManager to configure the network.

Procedure

1. Create a playbook file, for example `~/playbook.yml`, with the following content:

```
---
- name: Configure the network
  hosts: managed-node-01.example.com
  tasks:
    - name: Configure an Ethernet connection with dynamic IP
      ansible.builtin.include_role:
        name: rhel-system-roles.network
      vars:
        network_connections:
          - name: example
            match:
              path:
                - pci-0000:00:0[1-3].0
                - &!pci-0000:00:02.0
            type: ethernet
            autoconnect: yes
            ip:
              dhcp4: yes
              auto6: yes
            state: up
```

These settings define an Ethernet connection profile. The connection retrieves IPv4 addresses, IPv6 addresses, default gateway, routes, DNS servers, and search domains from a DHCP server and IPv6 stateless address autoconfiguration (SLAAC).

The **match** parameter defines that Ansible applies the play to devices that match PCI ID **0000:00:0[1-3].0**, but not **0000:00:02.0**.

2. Validate the playbook syntax:

```
$ ansible-playbook --syntax-check ~/playbook.yml
```

Note that this command only validates the syntax and does not protect against a wrong but valid configuration.

3. Run the playbook:

```
$ ansible-playbook ~/playbook.yml
```

Additional resources

- `/usr/share/ansible/roles/rhel-system-roles.network/README.md` file
- `/usr/share/doc/rhel-system-roles/network/` directory

2.12. CONFIGURING MULTIPLE ETHERNET INTERFACES BY USING A SINGLE CONNECTION PROFILE BY INTERFACE NAME

In most cases, one connection profile contains the settings of one network device. However, NetworkManager also supports wildcards when you set the interface name in connection profiles. If a host roams between Ethernet networks with dynamic IP address assignment, you can use this feature to create a single connection profile that you can use for multiple Ethernet interfaces.

Prerequisites

- Multiple physical or virtual Ethernet devices exist in the server's configuration.
- A DHCP server is available in the network.
- No connection profile exists on the host.

Procedure

1. Add a connection profile that applies to all interface names starting with **enp**:

```
# nmcli connection add con-name Example connection.multi-connect multiple
match.interface-name enp* type ethernet
```

Verification

1. Display all settings of the single connection profile:

```
# nmcli connection show Example
connection.id:          Example
...
connection.multi-connect: 3 (multiple)
match.interface-name:   enp*
...
```

3 indicates the number of interfaces active on the connection profile at the same time, and not the number of network interfaces in the connection profile. The connection profile uses all devices that match the pattern in the **match.interface-name** parameter and, therefore, the connection profiles have the same Universally Unique Identifier (UUID).

2. Display the status of the connections:

```
# nmcli connection show
NAME          UUID          TYPE  DEVICE
...
Example 6f22402e-c0cc-49cf-b702-eaf0cd5ea7d1 ethernet enp7s0
Example 6f22402e-c0cc-49cf-b702-eaf0cd5ea7d1 ethernet enp8s0
Example 6f22402e-c0cc-49cf-b702-eaf0cd5ea7d1 ethernet enp9s0
```

Additional resources

- **nmcli(1)** man page
- **nm-settings(5)** man page

2.13. CONFIGURING A SINGLE CONNECTION PROFILE FOR MULTIPLE ETHERNET INTERFACES USING PCI IDS

The PCI ID is a unique identifier of the devices connected to the system. The connection profile adds multiple devices by matching interfaces based on a list of PCI IDs. You can use this procedure to connect multiple device PCI IDs to the single connection profile.

Prerequisites

- Multiple physical or virtual Ethernet devices exist in the server's configuration.
- A DHCP server is available in the network.
- No connection profile exists on the host.

Procedure

1. Identify the device path. For example, to display the device paths of all interfaces starting with **enp**, enter :

```
# udevadm info /sys/class/net/enp* | grep ID_PATH=
...
E: ID_PATH=pci-0000:07:00.0
E: ID_PATH=pci-0000:08:00.0
```

2. Add a connection profile that applies to all PCI IDs matching the **0000:00:0[7-8].0** expression:

```
# nmcli connection add type ethernet connection.multi-connect multiple match.path
"pci-0000:07:00.0 pci-0000:08:00.0" con-name Example
```

Verification

1. Display the status of the connection:

```
# nmcli connection show
NAME UUID TYPE DEVICE
Example 9cee0958-512f-4203-9d3d-b57af1d88466 ethernet enp7s0
Example 9cee0958-512f-4203-9d3d-b57af1d88466 ethernet enp8s0
...
```

2. To display all settings of the connection profile:

```
# nmcli connection show Example
connection.id: Example
...
connection.multi-connect: 3 (multiple)
match.path: pci-0000:07:00.0,pci-0000:08:00.0
...
```

This connection profile uses all devices with a PCI ID which match the pattern in the **match.path** parameter and, therefore, the connection profiles have the same Universally Unique Identifier (UUID).

Additional resources

Additional resources

- **nmcli(1)** man page
- **nm-settings(5)** man page

CHAPTER 3. CONFIGURING NETWORK BONDING

A network bond is a method to combine or aggregate physical and virtual network interfaces to provide a logical interface with higher throughput or redundancy. In a bond, the kernel handles all operations exclusively. You can create bonds on different types of devices, such as Ethernet devices or VLANs.

Red Hat Enterprise Linux provides administrators different options to configure team devices. For example:

- Use **nmcli** to configure bond connections using the command line.
- Use the RHEL web console to configure bond connections using a web browser.
- Use **nmtui** to configure bond connections in a text-based user interface.
- Use the **nm-connection-editor** application to configure bond connections in a graphical interface.
- Use **nmstatectl** to configure bond connections through the Nmstate API.
- Use RHEL system roles to automate the bond configuration on one or multiple hosts.

3.1. UNDERSTANDING THE DEFAULT BEHAVIOR OF CONTROLLER AND PORT INTERFACES

Consider the following default behavior when managing or troubleshooting team or bond port interfaces using the **NetworkManager** service:

- Starting the controller interface does not automatically start the port interfaces.
- Starting a port interface always starts the controller interface.
- Stopping the controller interface also stops the port interface.
- A controller without ports can start static IP connections.
- A controller without ports waits for ports when starting DHCP connections.
- A controller with a DHCP connection waiting for ports completes when you add a port with a carrier.
- A controller with a DHCP connection waiting for ports continues waiting when you add a port without carrier.

3.2. UPSTREAM SWITCH CONFIGURATION DEPENDING ON THE BONDING MODES

Depending on the bonding mode you want to use, you must configure the ports on the switch:

Bonding mode	Configuration on the switch
0 - balance-rr	Requires static EtherChannel enabled, not Link Aggregation Control Protocol (LACP)-negotiated.

Bonding mode	Configuration on the switch
1 - active-backup	No configuration required on the switch.
2 - balance-xor	Requires static EtherChannel enabled, not LACP-negotiated.
3 - broadcast	Requires static EtherChannel enabled, not LACP-negotiated.
4 - 802.3ad	Requires LACP-negotiated EtherChannel enabled.
5 - balance-tlb	No configuration required on the switch.
6 - balance-alb	No configuration required on the switch.

For details how to configure your switch, see the documentation of the switch.

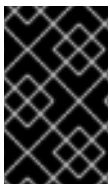

IMPORTANT

Certain network bonding features, such as the fail-over mechanism, do not support direct cable connections without a network switch. For further details, see the [Is bonding supported with direct connection using crossover cables? KCS solution](#).

3.3. CONFIGURING A NETWORK BOND BY USING NMCLI

To configure a network bond on the command line, use the **nmcli** utility.

Prerequisites

- Two or more physical or virtual network devices are installed on the server.
- To use Ethernet devices as ports of the bond, the physical or virtual Ethernet devices must be installed on the server.
- To use team, bridge, or VLAN devices as ports of the bond, you can either create these devices while you create the bond or you can create them in advance as described in:
 - [Configuring a network team by using nmcli](#)
 - [Configuring a network bridge by using nmcli](#)
 - [Configuring VLAN tagging by using nmcli](#)

Procedure

1. Create a bond interface:

```
# nmcli connection add type bond con-name bond0 ifname bond0 bond.options
"mode=active-backup"
```

This command creates a bond named **bond0** that uses the **active-backup** mode.

To additionally set a Media Independent Interface (MII) monitoring interval, add the **miimon=*interval*** option to the **bond.options** property, for example:

```
# nmcli connection add type bond con-name bond0 ifname bond0 bond.options
"mode=active-backup,miimon=1000"
```

2. Display the network interfaces, and note names of interfaces you plan to add to the bond:

```
# nmcli device status
DEVICE TYPE STATE CONNECTION
enp7s0 ethernet disconnected --
enp8s0 ethernet disconnected --
bridge0 bridge connected bridge0
bridge1 bridge connected bridge1
...
```

In this example:

- **enp7s0** and **enp8s0** are not configured. To use these devices as ports, add connection profiles in the next step.
- **bridge0** and **bridge1** have existing connection profiles. To use these devices as ports, modify their profiles in the next step.

3. Assign interfaces to the bond:

- a. If the interfaces you want to assign to the bond are not configured, create new connection profiles for them:

```
# nmcli connection add type ethernet slave-type bond con-name bond0-port1
ifname enp7s0 master bond0
# nmcli connection add type ethernet slave-type bond con-name bond0-port2
ifname enp8s0 master bond0
```

These commands create profiles for **enp7s0** and **enp8s0**, and add them to the **bond0** connection.

- b. To assign an existing connection profile to the bond:

- i. Set the **master** parameter of these connections to **bond0**:

```
# nmcli connection modify bridge0 master bond0
# nmcli connection modify bridge1 master bond0
```

These commands assign the existing connection profiles named **bridge0** and **bridge1** to the **bond0** connection.

- ii. Reactivate the connections:

```
# nmcli connection up bridge0
# nmcli connection up bridge1
```

4. Configure the IPv4 settings:

- To use this bond device as a port of other devices, enter:

```
# nmcli connection modify bond0 ipv4.method disabled
```

- To use DHCP, no action is required.
- To set a static IPv4 address, network mask, default gateway, and DNS server to the **bond0** connection, enter:

```
# nmcli connection modify bond0 ipv4.addresses '192.0.2.1/24' ipv4.gateway
'192.0.2.254' ipv4.dns '192.0.2.253' ipv4.dns-search 'example.com' ipv4.method
manual
```

5. Configure the IPv6 settings:

- To use this bond device as a port of other devices, enter:

```
# nmcli connection modify bond0 ipv6.method disabled
```

- To use stateless address autoconfiguration (SLAAC), no action is required.
- To set a static IPv6 address, network mask, default gateway, and DNS server to the **bond0** connection, enter:

```
# nmcli connection modify bond0 ipv6.addresses '2001:db8:1::1/64' ipv6.gateway
'2001:db8:1::ffe' ipv6.dns '2001:db8:1::fffd' ipv6.dns-search 'example.com'
ipv6.method manual
```

6. Optional: If you want to set any parameters on the bond ports, use the following command:

```
# nmcli connection modify bond0-port1 bond-port.<parameter> <value>
```

7. Activate the connection:

```
# nmcli connection up bond0
```

8. Verify that the ports are connected, and the **CONNECTION** column displays the port's connection name:

```
# nmcli device
DEVICE TYPE STATE CONNECTION
...
enp7s0 ethernet connected bond0-port1
enp8s0 ethernet connected bond0-port2
```

When you activate any port of the connection, NetworkManager also activates the bond, but not the other ports of it. You can configure that Red Hat Enterprise Linux enables all ports automatically when the bond is enabled:

- Enable the **connection.autoconnect-slaves** parameter of the bond's connection:

```
# nmcli connection modify bond0 connection.autoconnect-slaves 1
```

- Reactivate the bridge:

```
# nmcli connection up bond0
```

Verification

1. Temporarily remove the network cable from the host.
Note that there is no method to properly test link failure events using software utilities. Tools that deactivate connections, such as **nmcli**, show only the bonding driver's ability to handle port configuration changes and not actual link failure events.
2. Display the status of the bond:

```
# cat /proc/net/bonding/bond0
```

Additional resources

- [Configuring NetworkManager to avoid using a specific profile to provide a default gateway](#)
- [Network bonding documentation](#)

3.4. CONFIGURING A NETWORK BOND BY USING THE RHEL WEB CONSOLE

Use the RHEL web console to configure a network bond if you prefer to manage network settings using a web browser-based interface.

Prerequisites

- You are logged in to the RHEL web console.
- Two or more physical or virtual network devices are installed on the server.
- To use Ethernet devices as members of the bond, the physical or virtual Ethernet devices must be installed on the server.
- To use team, bridge, or VLAN devices as members of the bond, create them in advance as described in:
 - [Configuring a network team by using the RHEL web console](#)
 - [Configuring a network bridge by using the RHEL web console](#)
 - [Configuring VLAN tagging by using the RHEL web console](#)

Procedure

1. Select the **Networking** tab in the navigation on the left side of the screen.
2. Click **Add bond** in the **Interfaces** section.
3. Enter the name of the bond device you want to create.
4. Select the interfaces that should be members of the bond.
5. Select the mode of the bond.

If you select **Active backup**, the web console shows the additional field **Primary** in which you can select the preferred active device.

6. Set the link monitoring mode. For example, when you use the **Adaptive load balancing** mode, set it to **ARP**.
7. Optional: Adjust the monitoring interval, link up delay, and link down delay settings. Typically, you only change the defaults for troubleshooting purposes.

Bond settings ⓘ ✕

Name

Interfaces enp7s0
 enp8s0

MAC

Mode

Primary

Link monitoring

Monitoring interval

Link up delay

Link down delay

8. Click **Apply**.
9. By default, the bond uses a dynamic IP address. If you want to set a static IP address:
 - a. Click the name of the bond in the **Interfaces** section.

- b. Click **Edit** next to the protocol you want to configure.
- c. Select **Manual** next to **Addresses**, and enter the IP address, prefix, and default gateway.
- d. In the **DNS** section, click the **+** button, and enter the IP address of the DNS server. Repeat this step to set multiple DNS servers.
- e. In the **DNS search domains** section, click the **+** button, and enter the search domain.
- f. If the interface requires static routes, configure them in the **Routes** section.

IPv4 settings ✕

Addresses Manual ▾ +

Address	Prefix length or netmask	Gateway	
192.0.2.1	24	192.0.2.254	-

DNS Automatic +

Server

192.0.2.253
-

DNS search domains Automatic +

Search domain

example.com
-

Routes Automatic +

Apply
Cancel

- g. Click **Apply**

Verification

1. Select the **Networking** tab in the navigation on the left side of the screen, and check if there is incoming and outgoing traffic on the interface:

Interfaces Add bond Add team Add bridge Add VLAN 				
Name	IP address	Sending	Receiving	
bond0	192.0.2.1/24	1.11 Mbps	61.2 Mbps	

2. Temporarily remove the network cable from the host.

Note that there is no method to properly test link failure events using software utilities. Tools that deactivate connections, such as the web console, show only the bonding driver's ability to handle member configuration changes and not actual link failure events.

3. Display the status of the bond:

```
# cat /proc/net/bonding/bond0
```

3.5. CONFIGURING A NETWORK BOND BY USING NMTUI

The **nmtui** application provides a text-based user interface for NetworkManager. You can use **nmtui** to configure a network bond on a host without a graphical interface.



NOTE

In **nmtui**:

- Navigate by using the cursor keys.
- Press a button by selecting it and hitting **Enter**.
- Select and deselect checkboxes by using **Space**.

Prerequisites

- Two or more physical or virtual network devices are installed on the server.
- To use Ethernet devices as ports of the bond, the physical or virtual Ethernet devices must be installed on the server.

Procedure

1. If you do not know the network device names on which you want configure a network bond, display the available devices:

```
# nmcli device status
DEVICE  TYPE    STATE      CONNECTION
enp7s0  ethernet unavailable --
enp8s0  ethernet unavailable --
...
```

2. Start **nmtui**:

```
# nmtui
```

3. Select **Edit a connection**, and press **Enter**.
4. Press the **Add** button.
5. Select **Bond** from the list of network types, and press **Enter**.
6. Optional: Enter a name for the NetworkManager profile to be created.
On hosts with multiple profiles, a meaningful name makes it easier to identify the purpose of a profile.

7. Enter the bond device name to be created into the **Device** field.
8. Add ports to the bond to be created:
 - a. Press the **Add** button next to the **Slaves** list.
 - b. Select the type of the interface you want to add as port to the bond, for example, **Ethernet**.
 - c. Optional: Enter a name for the NetworkManager profile to be created for this bond port.
 - d. Enter the port's device name into the **Device** field.
 - e. Press the **OK** button to return to the window with the bond settings.

Figure 3.1. Adding an Ethernet device as port to a bond

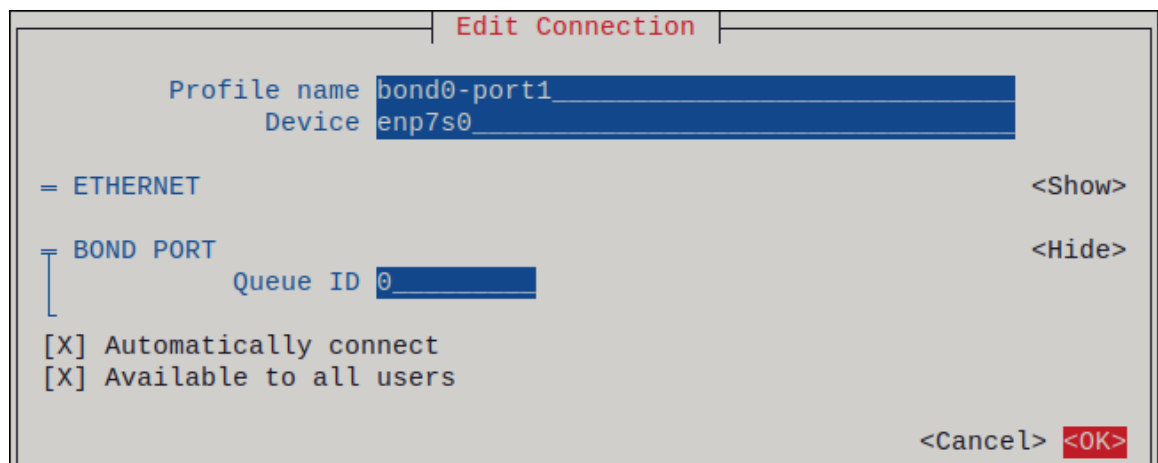

- f. Repeat these steps to add more ports to the bond.
9. Set the bond mode. Depending on the value you set, **nmtui** displays additional fields for settings that are related to the selected mode.
10. Depending on your environment, configure the IP address settings in the **IPv4 configuration** and **IPv6 configuration** areas accordingly. For this, press the button next to these areas, and select:
 - **Disabled**, if the bond does not require an IP address.
 - **Automatic**, if a DHCP server or stateless address autoconfiguration (SLAAC) dynamically assigns an IP address to the bond.
 - **Manual**, if the network requires static IP address settings. In this case, you must fill further fields:
 - i. Press the **Show** button next to the protocol you want to configure to display additional fields.
 - ii. Press the **Add** button next to **Addresses**, and enter the IP address and the subnet mask in Classless Inter-Domain Routing (CIDR) format.
If you do not specify a subnet mask, NetworkManager sets a **/32** subnet mask for IPv4 addresses and **/64** for IPv6 addresses.
 - iii. Enter the address of the default gateway.
 - iv. Press the **Add** button next to **DNS servers**, and enter the DNS server address.

- v. Press the **Add** button next to **Search domains**, and enter the DNS search domain.

Figure 3.2. Example of a bond connection with static IP address settings

Edit Connection

Profile name
 Device

BOND <Hide>
 Slaves

↑
 ↓

<Add>
<Edit...>
<Delete>

Mode
 Primary
 Link monitoring
 Monitoring frequency ms
 Link up delay ms
 Link down delay ms
 Cloned MAC address

IPv4 CONFIGURATION <Hide>

Addresses <Remove>
<Add...>

Gateway
 DNS servers <Remove>
<Add...>

Search domains

Routing (No custom routes)

Never use this network for default route
 Ignore automatically obtained routes
 Ignore automatically obtained DNS parameters

Require IPv4 addressing for this connection

IPv6 CONFIGURATION <Hide>

Addresses <Remove>
<Add...>

Gateway
 DNS servers <Remove>
<Add...>

Search domains

Routing (No custom routes)

Never use this network for default route
 Ignore automatically obtained routes
 Ignore automatically obtained DNS parameters

Require IPv6 addressing for this connection

Automatically connect
 Available to all users

<Cancel> <OK>

11. Press the **OK** button to create and automatically activate the new connection.
12. Press the **Back** button to return to the main menu.
13. Select **Quit**, and press **Enter** to close the **nmtui** application.

Verification

1. Temporarily remove the network cable from the host.
Note that there is no method to properly test link failure events using software utilities. Tools that deactivate connections, such as **nmcli**, show only the bonding driver's ability to handle port configuration changes and not actual link failure events.
2. Display the status of the bond:

```
# cat /proc/net/bonding/bond0
```

3.6. CONFIGURING A NETWORK BOND BY USING NM-CONNECTION-EDITOR

If you use Red Hat Enterprise Linux with a graphical interface, you can configure network bonds using the **nm-connection-editor** application.

Note that **nm-connection-editor** can add only new ports to a bond. To use an existing connection profile as a port, create the bond by using the **nmcli** utility as described in [Configuring a network bond by using nmcli](#).

Prerequisites

- Two or more physical or virtual network devices are installed on the server.
- To use Ethernet devices as ports of the bond, the physical or virtual Ethernet devices must be installed on the server.
- To use team, bond, or VLAN devices as ports of the bond, ensure that these devices are not already configured.

Procedure

1. Open a terminal, and enter **nm-connection-editor**:

```
$ nm-connection-editor
```

2. Click the **+** button to add a new connection.
3. Select the **Bond** connection type, and click **Create**.
4. On the **Bond** tab:
 - a. Optional: Set the name of the bond interface in the **Interface name** field.
 - b. Click the **Add** button to add a network interface as a port to the bond.
 - i. Select the connection type of the interface. For example, select **Ethernet** for a wired connection.

- ii. Optional: Set a connection name for the port.
 - iii. If you create a connection profile for an Ethernet device, open the **Ethernet** tab, and select in the **Device** field the network interface you want to add as a port to the bond. If you selected a different device type, configure it accordingly. Note that you can only use Ethernet interfaces in a bond that are not configured.
 - iv. Click **Save**.
- c. Repeat the previous step for each interface you want to add to the bond:

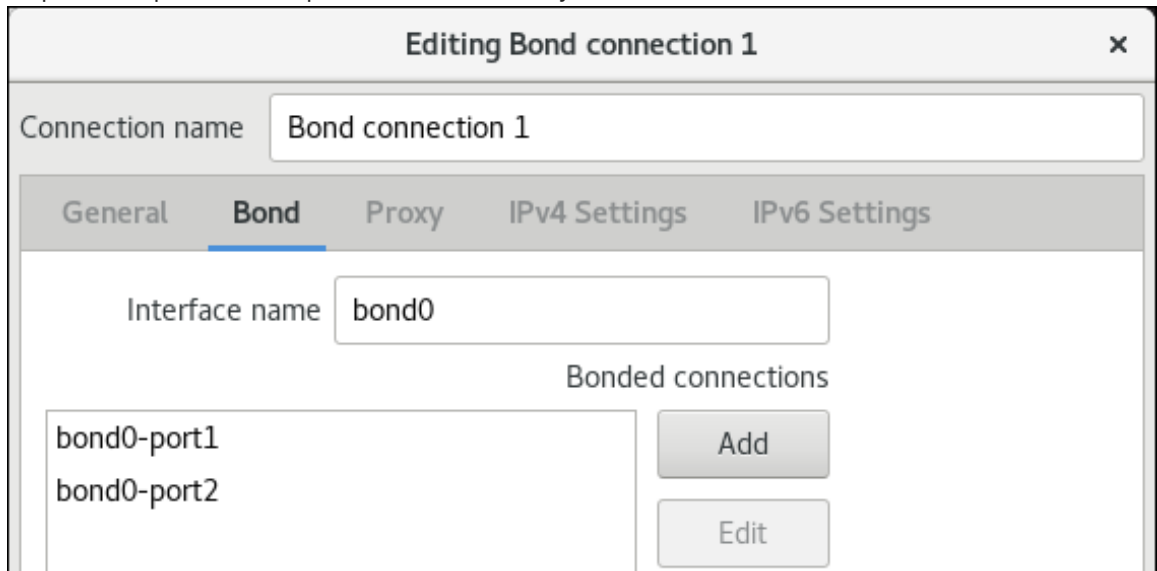

- d. Optional: Set other options, such as the Media Independent Interface (MII) monitoring interval.
5. Configure the IP address settings on both the **IPv4 Settings** and **IPv6 Settings** tabs:
- To use this bridge device as a port of other devices, set the **Method** field to **Disabled**.
 - To use DHCP, leave the **Method** field at its default, **Automatic (DHCP)**.
 - To use static IP settings, set the **Method** field to **Manual** and fill the fields accordingly:

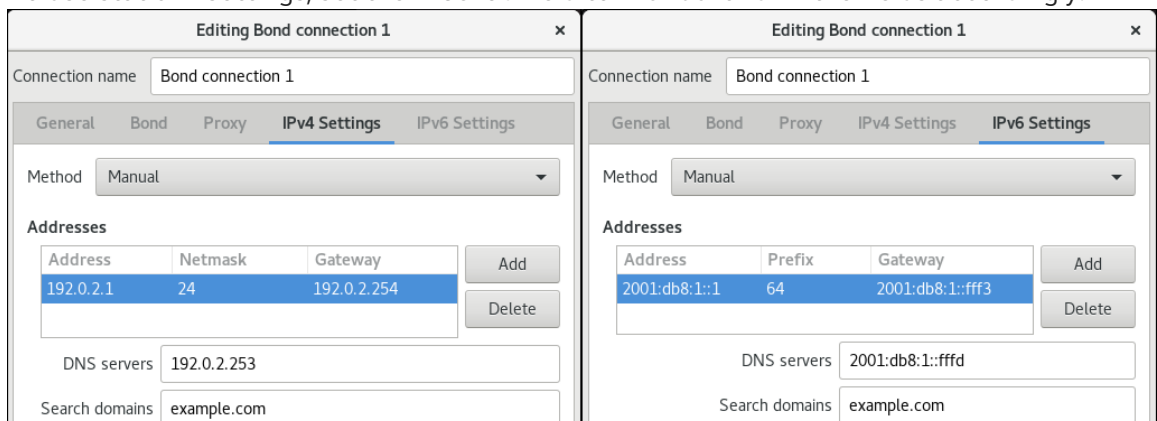

6. Click **Save**.
7. Close **nm-connection-editor**.

Verification

1. Temporarily remove the network cable from the host.

Note that there is no method to properly test link failure events using software utilities. Tools that deactivate connections, such as **nmcli**, show only the bonding driver's ability to handle port configuration changes and not actual link failure events.

2. Display the status of the bond:

```
# cat /proc/net/bonding/bond0
```

Additional resources

- [Configuring NetworkManager to avoid using a specific profile to provide a default gateway](#)
- [Configuring a network team by using nm-connection-editor](#)
- [Configuring a network bridge by using nm-connection-editor](#)
- [Configuring VLAN tagging by using nm-connection-editor](#)

3.7. CONFIGURING A NETWORK BOND BY USING NMSTATECTL

Use the **nmstatectl** utility to configure a network bond through the Nmstate API. The Nmstate API ensures that, after setting the configuration, the result matches the configuration file. If anything fails, **nmstatectl** automatically rolls back the changes to avoid leaving the system in an incorrect state.

Depending on your environment, adjust the YAML file accordingly. For example, to use different devices than Ethernet adapters in the bond, adapt the **base-iface** attribute and **type** attributes of the ports you use in the bond.

Prerequisites

- Two or more physical or virtual network devices are installed on the server.
- To use Ethernet devices as ports in the bond, the physical or virtual Ethernet devices must be installed on the server.
- To use team, bridge, or VLAN devices as ports in the bond, set the interface name in the **port** list, and define the corresponding interfaces.
- The **nmstate** package is installed.

Procedure

1. Create a YAML file, for example **~/create-bond.yml**, with the following content:

```
---
interfaces:
- name: bond0
  type: bond
  state: up
  ipv4:
    enabled: true
    address:
    - ip: 192.0.2.1
      prefix-length: 24
    dhcp: false
```



```

ipv6:
  enabled: true
  address:
    - ip: 2001:db8:1::1
      prefix-length: 64
  autoconf: false
  dhcp: false
link-aggregation:
  mode: active-backup
  port:
    - enp1s0
    - enp7s0
- name: enp1s0
  type: ethernet
  state: up
- name: enp7s0
  type: ethernet
  state: up

routes:
  config:
    - destination: 0.0.0.0/0
      next-hop-address: 192.0.2.254
      next-hop-interface: bond0
    - destination: ::0
      next-hop-address: 2001:db8:1::fffe
      next-hop-interface: bond0

dns-resolver:
  config:
    search:
      - example.com
    server:
      - 192.0.2.200
      - 2001:db8:1::ffbb

```

These settings define a network bond with the following settings:

- Network interfaces in the bond: **enp1s0** and **enp7s0**
- Mode: **active-backup**
- Static IPv4 address: **192.0.2.1** with a **/24** subnet mask
- Static IPv6 address: **2001:db8:1::1** with a **/64** subnet mask
- IPv4 default gateway: **192.0.2.254**
- IPv6 default gateway: **2001:db8:1::fffe**
- IPv4 DNS server: **192.0.2.200**
- IPv6 DNS server: **2001:db8:1::ffbb**
- DNS search domain: **example.com**

2. Apply the settings to the system:

```
# nmstatectl apply ~/create-bond.yml
```

Verification

1. Display the status of the devices and connections:

```
# nmcli device status
DEVICE  TYPE  STATE  CONNECTION
bond0   bond  connected bond0
```

2. Display all settings of the connection profile:

```
# nmcli connection show bond0
connection.id:      bond0
connection.uuid:    79cbc3bd-302e-4b1f-ad89-f12533b818ee
connection.stable-id:  --
connection.type:    bond
connection.interface-name: bond0
...
```

3. Display the connection settings in YAML format:

```
# nmstatectl show bond0
```

Additional resources

- [nmstatectl\(8\)](#) man page
- [/usr/share/doc/nmstate/examples/](#) directory

3.8. CONFIGURING A NETWORK BOND BY USING THE NETWORK RHEL SYSTEM ROLE

You can remotely configure a network bond by using the **network** RHEL system role.

Prerequisites

- [You have prepared the control node and the managed nodes](#)
- You are logged in to the control node as a user who can run playbooks on the managed nodes.
- The account you use to connect to the managed nodes has **sudo** permissions on them.
- Two or more physical or virtual network devices are installed on the server.

Procedure

1. Create a playbook file, for example `~/playbook.yml`, with the following content:

```
---
- name: Configure the network
  hosts: managed-node-01.example.com
```

```

tasks:
- name: Configure a network bond that uses two Ethernet ports
  ansible.builtin.include_role:
    name: rhel-system-roles.network
  vars:
    network_connections:
      # Define the bond profile
      - name: bond0
        type: bond
        interface_name: bond0
        ip:
          address:
            - "192.0.2.1/24"
            - "2001:db8:1::1/64"
          gateway4: 192.0.2.254
          gateway6: 2001:db8:1::ffe
          dns:
            - 192.0.2.200
            - 2001:db8:1::ffbb
          dns_search:
            - example.com
        bond:
          mode: active-backup
          state: up

      # Add an Ethernet profile to the bond
      - name: bond0-port1
        interface_name: enp7s0
        type: ethernet
        controller: bond0
        state: up

      # Add a second Ethernet profile to the bond
      - name: bond0-port2
        interface_name: enp8s0
        type: ethernet
        controller: bond0
        state: up

```

These settings define a network bond with the following settings:

- A static IPv4 address - **192.0.2.1** with a **/24** subnet mask
- A static IPv6 address - **2001:db8:1::1** with a **/64** subnet mask
- An IPv4 default gateway - **192.0.2.254**
- An IPv6 default gateway - **2001:db8:1::ffe**
- An IPv4 DNS server - **192.0.2.200**
- An IPv6 DNS server - **2001:db8:1::ffbb**
- A DNS search domain - **example.com**
- Ports of the bond - **enp7s0** and **enp8s0**

- Bond mode - **active-backup**

**NOTE**

Set the IP configuration on the bond and not on the ports of the Linux bond.

2. Validate the playbook syntax:

```
$ ansible-playbook --syntax-check ~/playbook.yml
```

Note that this command only validates the syntax and does not protect against a wrong but valid configuration.

3. Run the playbook:

```
$ ansible-playbook ~/playbook.yml
```

Additional resources

- `/usr/share/ansible/roles/rhel-system-roles.network/README.md` file
- `/usr/share/doc/rhel-system-roles/network/` directory

3.9. CREATING A NETWORK BOND TO ENABLE SWITCHING BETWEEN AN ETHERNET AND WIRELESS CONNECTION WITHOUT INTERRUPTING THE VPN

RHEL users who connect their workstation to their company's network typically use a VPN to access remote resources. However, if the workstation switches between an Ethernet and Wi-Fi connection, for example, if you release a laptop from a docking station with an Ethernet connection, the VPN connection is interrupted. To avoid this problem, you can create a network bond that uses the Ethernet and Wi-Fi connection in **active-backup** mode.

Prerequisites

- The host contains an Ethernet and a Wi-Fi device.
- An Ethernet and Wi-Fi NetworkManager connection profile has been created and both connections work independently.

This procedure uses the following connection profiles to create a network bond named **bond0**:

- **Docking_station** associated with the **enp11s0u1** Ethernet device
- **Wi-Fi** associated with the **wlp1s0** Wi-Fi device

Procedure

1. Create a bond interface in **active-backup** mode:

```
# nmcli connection add type bond con-name bond0 ifname bond0 bond.options "mode=active-backup"
```

This command names both the interface and connection profile **bond0**.

2. Configure the IPv4 settings of the bond:

- If a DHCP server in your network assigns IPv4 addresses to hosts, no action is required.
- If your local network requires static IPv4 addresses, set the address, network mask, default gateway, DNS server, and DNS search domain to the **bond0** connection:

```
# nmcli connection modify bond0 ipv4.addresses '192.0.2.1/24'
# nmcli connection modify bond0 ipv4.gateway '192.0.2.254'
# nmcli connection modify bond0 ipv4.dns '192.0.2.253'
# nmcli connection modify bond0 ipv4.dns-search 'example.com'
# nmcli connection modify bond0 ipv4.method manual
```

3. Configure the IPv6 settings of the bond:

- If your router or a DHCP server in your network assigns IPv6 addresses to hosts, no action is required.
- If your local network requires static IPv6 addresses, set the address, network mask, default gateway, DNS server, and DNS search domain to the **bond0** connection:

```
# nmcli connection modify bond0 ipv6.addresses '2001:db8:1::1/64'
# nmcli connection modify bond0 ipv6.gateway '2001:db8:1::ffff'
# nmcli connection modify bond0 ipv6.dns '2001:db8:1::fffd'
# nmcli connection modify bond0 ipv6.dns-search 'example.com'
# nmcli connection modify bond0 ipv6.method manual
```

4. Display the connection profiles:

```
# nmcli connection show
NAME          UUID                                  TYPE  DEVICE
Docking_station 256dd073-fecc-339d-91ae-9834a00407f9 ethernet enp11s0u1
Wi-Fi         1f1531c7-8737-4c60-91af-2d21164417e8 wifi    wlp1s0
...
```

You require the names of the connection profiles and the Ethernet device name in the next steps.

5. Assign the connection profile of the Ethernet connection to the bond:

```
# nmcli connection modify Docking_station master bond0
```

6. Assign the connection profile of the Wi-Fi connection to the bond:

```
# nmcli connection modify Wi-Fi master bond0
```

7. If your Wi-Fi network uses MAC filtering to allow only MAC addresses on a allow list to access the network, configure that NetworkManager dynamically assigns the MAC address of the active port to the bond:

```
# nmcli connection modify bond0 +bond.options fail_over_mac=1
```

With this setting, you must set only the MAC address of the Wi-Fi device to the allow list instead of the MAC address of both the Ethernet and Wi-Fi device.

- Set the device associated with the Ethernet connection as primary device of the bond:

```
# nmcli con modify bond0 +bond.options "primary=enp11s0u1"
```

With this setting, the bond always uses the Ethernet connection if it is available.

- Configure that NetworkManager automatically activates ports when the **bond0** device is activated:

```
# nmcli connection modify bond0 connection.autoconnect-slaves 1
```

- Activate the **bond0** connection:

```
# nmcli connection up bond0
```

Verification

- Display the currently active device, the status of the bond and its ports:

```
# cat /proc/net/bonding/bond0
Ethernet Channel Bonding Driver: v3.7.1 (April 27, 2011)

Bonding Mode: fault-tolerance (active-backup) (fail_over_mac active)
Primary Slave: enp11s0u1 (primary_reselect always)
Currently Active Slave: enp11s0u1
MII Status: up
MII Polling Interval (ms): 1
Up Delay (ms): 0
Down Delay (ms): 0
Peer Notification Delay (ms): 0

Slave Interface: enp11s0u1
MII Status: up
Speed: 1000 Mbps
Duplex: full
Link Failure Count: 0
Permanent HW addr: 00:53:00:59:da:b7
Slave queue ID: 0

Slave Interface: wlp1s0
MII Status: up
Speed: Unknown
Duplex: Unknown
Link Failure Count: 2
Permanent HW addr: 00:53:00:b3:22:ba
Slave queue ID: 0
```

Additional resources

- [Configuring an Ethernet connection](#)
- [Managing Wi-Fi connections](#)
- [Configuring network bonding](#)

3.10. THE DIFFERENT NETWORK BONDING MODES

The Linux bonding driver provides link aggregation. Bonding is the process of aggregating multiple network interfaces in parallel to provide a single logical bonded interface. The actions of a bonded interface depend on the bonding policy that is also known as mode. The different modes provide either load-balancing or hot standby services.

The following modes exist:

Balance-rr (Mode 0)

Balance-rr uses the round-robin algorithm that sequentially transmits packets from the first available port to the last one. This mode provides load balancing and fault tolerance.

This mode requires switch configuration of a port aggregation group, also called EtherChannel or similar port grouping. An EtherChannel is a port link aggregation technology to group multiple physical Ethernet links to one logical Ethernet link.

The drawback of this mode is that it is not suitable for heavy workloads and if TCP throughput or ordered packet delivery is essential.

Active-backup (Mode 1)

Active-backup uses the policy that determines that only one port is active in the bond. This mode provides fault tolerance and does not require any switch configuration.

If the active port fails, an alternate port becomes active. The bond sends a gratuitous address resolution protocol (ARP) response to the network. The gratuitous ARP forces the receiver of the ARP frame to update their forwarding table. The **Active-backup** mode transmits a gratuitous ARP to announce the new path to maintain connectivity for the host.

The **primary** option defines the preferred port of the bonding interface.

Balance-xor (Mode 2)

Balance-xor uses the selected transmit hash policy to send the packets. This mode provides load balancing, fault tolerance, and requires switch configuration to set up an Etherchannel or similar port grouping.

To alter packet transmission and balance transmit, this mode uses the **xmit_hash_policy** option. Depending on the source or destination of traffic on the interface, the interface requires an additional load-balancing configuration. See description [xmit_hash_policy bonding parameter](#).

Broadcast (Mode 3)

Broadcast uses a policy that transmits every packet on all interfaces. This mode provides fault tolerance and requires a switch configuration to set up an EtherChannel or similar port grouping.

The drawback of this mode is that it is not suitable for heavy workloads and if TCP throughput or ordered packet delivery is essential.

802.3ad (Mode 4)

802.3ad uses the same-named IEEE standard dynamic link aggregation policy. This mode provides fault tolerance. This mode requires switch configuration to set up a Link Aggregation Control Protocol (LACP) port grouping.

This mode creates aggregation groups that share the same speed and duplex settings and utilizes all ports in the active aggregator. Depending on the source or destination of traffic on the interface, this mode requires an additional load-balancing configuration.

By default, the port selection for outgoing traffic depends on the transmit hash policy. Use the **xmit_hash_policy** option of the transmit hash policy to change the port selection and balance transmit.

The difference between the **802.3ad** and the **Balance-xor** is compliance. The **802.3ad** policy negotiates LACP between the port aggregation groups. See description [xmit_hash_policy bonding parameter](#)

Balance-tlb (Mode 5)

Balance-tlb uses the transmit load balancing policy. This mode provides fault tolerance, load balancing, and establishes channel bonding that does not require any switch support.

The active port receives the incoming traffic. In case of failure of the active port, another one takes over the MAC address of the failed port. To decide which interface processes the outgoing traffic, use one of the following modes:

- Value **0**: Uses the hash distribution policy to distribute traffic without load balancing
- Value **1**: Distributes traffic to each port by using load balancing
With the bonding option **tlb_dynamic_lb=0**, this bonding mode uses the **xmit_hash_policy** bonding option to balance transmit. The **primary** option defines the preferred port of the bonding interface.

See description [xmit_hash_policy bonding parameter](#).

Balance-alb (Mode 6)

Balance-alb uses an adaptive load balancing policy. This mode provides fault tolerance, load balancing, and does not require any special switch support.

This mode includes balance-transmit load balancing (**balance-tlb**) and receive-load balancing for IPv4 and IPv6 traffic. The bonding intercepts ARP replies sent by the local system and overwrites the source hardware address of one of the ports in the bond. ARP negotiation manages the receive-load balancing. Therefore, different ports use different hardware addresses for the server.

The **primary** option defines the preferred port of the bonding interface. With the bonding option **tlb_dynamic_lb=0**, this bonding mode uses the **xmit_hash_policy** bonding option to balance transmit. See description [xmit_hash_policy bonding parameter](#).

Additional resources

- [/usr/share/doc/kernel-doc-<version>/Documentation/networking/bonding.rst](#) provided by the **kernel-doc** package
- [/usr/share/doc/kernel-doc-<version>/Documentation/networking/bonding.txt](#) provided by the **kernel-doc** package
- [Which bonding modes work when used with a bridge that virtual machine guests or containers connect to?](#)
- [How are the values for different policies in "xmit_hash_policy" bonding parameter calculated?](#)

3.11. THE XMIT_HASH_POLICY BONDING PARAMETER

The **xmit_hash_policy** load balancing parameter selects the transmit hash policy for a node selection in the **balance-xor**, **802.3ad**, **balance-alb**, and **balance-tlb** modes. It is only applicable to mode 5 and 6 if the **tlb_dynamic_lb** parameter is **0**. The possible values of this parameter are **layer2**, **layer2+3**,

layer3+4, encap2+3, encap3+4, and vlan+srcmac.

Refer the table for details:

Policy or Network layers	Layer2	Layer2+3	Layer3+4	encap2+3	encap3+4	VLAN+src mac
Uses	XOR of source and destination MAC addresses and Ethernet protocol type	XOR of source and destination MAC addresses and IP addresses	XOR of source and destination ports and IP addresses	XOR of source and destination MAC addresses and IP addresses inside a supported tunnel, for example, Virtual Extensible LAN (VXLAN). This mode relies on skb_flow_dissect() function to obtain the header fields	XOR of source and destination ports and IP addresses inside a supported tunnel, for example, VXLAN. This mode relies on skb_flow_dissect() function to obtain the header fields	XOR of VLAN ID and source MAC vendor and source MAC device
Placement of traffic	All traffic to a particular network peer on the same underlying network interface	All traffic to a particular IP address on the same underlying network interface	All traffic to a particular IP address and port on the same underlying network interface			

Primary choice	If network traffic is between this system and multiple other systems in the same broadcast domain	If network traffic between this system and multiple other systems goes through a default gateway	If network traffic between this system and another system uses the same IP addresses but goes through multiple ports	The encapsulated traffic is between the source system and multiple other systems using multiple IP addresses	The encapsulated traffic is between the source system and other systems using multiple port numbers	If the bond carries network traffic, from multiple containers or virtual machines (VM), that expose their MAC address directly to the external network such as the bridge network, and you can not configure a switch for Mode 2 or Mode 4
Secondary choice	If network traffic is mostly between this system and multiple other systems behind a default gateway	If network traffic is mostly between this system and another system				
Compliant	802.3ad	802.3ad	Not 802.3ad			
Default policy	This is the default policy if no configuration is provided	For non-IP traffic, the formula is the same as for the layer2 transmit policy	For non-IP traffic, the formula is the same as for the layer2 transmit policy			

CHAPTER 4. CONFIGURING NETWORK TEAMING

A network team is a method to combine or aggregate physical and virtual network interfaces to provide a logical interface with higher throughput or redundancy. Network teaming uses a small kernel module to implement fast handling of packet flows and a user-space service for other tasks. This way, network teaming is an easily extensible and scalable solution for load-balancing and redundancy requirements.

Red Hat Enterprise Linux provides administrators different options to configure team devices. For example:

- Use **nmcli** to configure teams connections using the command line.
- Use the RHEL web console to configure team connections using a web browser.
- Use the **nm-connection-editor** application to configure team connections in a graphical interface.

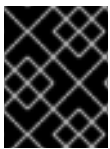

IMPORTANT

Network teaming is deprecated in Red Hat Enterprise Linux 9. Consider using the network bonding driver as an alternative. For details, see [Configuring network bonding](#).

4.1. MIGRATING A NETWORK TEAM CONFIGURATION TO NETWORK BOND

Network teaming is deprecated in Red Hat Enterprise Linux 9. If you already have a working network team configured, for example because you upgraded from an earlier RHEL version, you can migrate the configuration to a network bond that is managed by NetworkManager.



IMPORTANT

The **team2bond** utility only converts the network team configuration to a bond. Afterwards, you must manually configure further settings of the bond, such as IP addresses and DNS configuration.

Prerequisites

- The **team-team0** NetworkManager connection profile is configured and manages the **team0** device.
- The **teamd** package is installed.

Procedure

1. Optional: Display the IP configuration of the **team-team0** NetworkManager connection:

```
# nmcli connection show team-team0 | egrep "^ip"
...
ipv4.method:                manual
ipv4.dns:                    192.0.2.253
ipv4.dns-search:             example.com
ipv4.addresses:              192.0.2.1/24
ipv4.gateway:                192.0.2.254
...
```

```

ipv6.method:                manual
ipv6.dns:                   2001:db8:1::fffd
ipv6.dns-search:           example.com
ipv6.addresses:            2001:db8:1::1/64
ipv6.gateway:              2001:db8:1::fffe
...

```

- Export the configuration of the **team0** device to a JSON file:

```
# teamdctl team0 config dump actual > /tmp/team0.json
```

- Remove the network team. For example, if you configured the team in NetworkManager, remove the **team-team0** connection profile and the profiles of associated ports:

```
# nmcli connection delete team-team0
# nmcli connection delete team-team0-port1
# nmcli connection delete team-team0-port2
```

- Run the **team2bond** utility in dry-run mode to display **nmcli** commands that set up a network bond with similar settings as the team device:

```
# team2bond --config=/tmp/team0.json --rename=bond0
nmcli con add type bond ifname bond0 bond.options "mode=active-
backup,num_grat_arp=1,num_unsol_na=1,resent_igmp=1,miimon=100,miimon=100"
nmcli con add type ethernet ifname enp7s0 master bond0
nmcli con add type ethernet ifname enp8s0 master bond0
```

The first command contains two **miimon** options because the team configuration file contained two **link_watch** entries. Note that this does not affect the creation of the bond.

If you bound services to the device name of the team and want to avoid updating or breaking these services, omit the **--rename=bond0** option. In this case, **team2bond** uses the same interface name for the bond as for the team.

- Verify that the options for the bond the **team2bond** utility suggested are correct.
- Create the bond. You can execute the suggested **nmcli** commands or re-run the **team2bond** command with the **--exec-cmd** option:

```
# team2bond --config=/tmp/team0.json --rename=bond0 --exec-cmd
Connection 'bond-bond0' (0241a531-0c72-4202-80df-73eadfc126b5) successfully added.
Connection 'bond-slave-enp7s0' (38489729-b624-4606-a784-1ccf01e2f6d6) successfully
added.
Connection 'bond-slave-enp8s0' (de97ec06-7daa-4298-9a71-9d4c7909daa1) successfully
added.
```

You require the name of the bond connection profile (**bond-bond0**) in the next steps.

- Set the IPv4 settings that were previously configured on **team-team0** to the **bond-bond0** connection:

```
# nmcli connection modify bond-bond0 ipv4.addresses '192.0.2.1/24'
# nmcli connection modify bond-bond0 ipv4.gateway '192.0.2.254'
# nmcli connection modify bond-bond0 ipv4.dns '192.0.2.253'
```

```
# nmcli connection modify bond-bond0 ipv4.dns-search 'example.com'
# nmcli connection modify bond-bond0 ipv4.method manual
```

- Set the IPv6 settings that were previously configured on **team-team0** to the **bond-bond0** connection:

```
# nmcli connection modify bond-bond0 ipv6.addresses '2001:db8:1::1/64'
# nmcli connection modify bond-bond0 ipv6.gateway '2001:db8:1::fffe'
# nmcli connection modify bond-bond0 ipv6.dns '2001:db8:1::fffd'
# nmcli connection modify bond-bond0 ipv6.dns-search 'example.com'
# nmcli connection modify bond-bond0 ipv6.method manual
```

- Activate the connection:

```
# nmcli connection up bond-bond0
```

Verification

- Display the IP configuration of the **bond-bond0** NetworkManager connection:

```
# nmcli connection show bond-bond0 | egrep "^ip"
...
ipv4.method:                manual
ipv4.dns:                   192.0.2.253
ipv4.dns-search:            example.com
ipv4.addresses:             192.0.2.1/24
ipv4.gateway:               192.0.2.254
...
ipv6.method:                manual
ipv6.dns:                   2001:db8:1::fffd
ipv6.dns-search:            example.com
ipv6.addresses:             2001:db8:1::1/64
ipv6.gateway:               2001:db8:1::fffe
...
```

- Display the status of the bond:

```
# cat /proc/net/bonding/bond0
Ethernet Channel Bonding Driver: v5.13.0-0.rc7.51.el9.x86_64

Bonding Mode: fault-tolerance (active-backup)
Primary Slave: None
Currently Active Slave: enp7s0
MII Status: up
MII Polling Interval (ms): 100
Up Delay (ms): 0
Down Delay (ms): 0
Peer Notification Delay (ms): 0

Slave Interface: enp7s0
MII Status: up
Speed: Unknown
Duplex: Unknown
Link Failure Count: 0
```

```

Permanent HW addr: 52:54:00:bf:b1:a9
Slave queue ID: 0

Slave Interface: enp8s0
MII Status: up
Speed: Unknown
Duplex: Unknown
Link Failure Count: 0
Permanent HW addr: 52:54:00:04:36:0f
Slave queue ID: 0

```

In this example, both ports are up.

3. To verify that bonding failover works:
 - a. Temporarily remove the network cable from the host. Note that there is no method to properly test link failure events using the command line.
 - b. Display the status of the bond:

```
# cat /proc/net/bonding/bond0
```

4.2. UNDERSTANDING THE DEFAULT BEHAVIOR OF CONTROLLER AND PORT INTERFACES

Consider the following default behavior when managing or troubleshooting team or bond port interfaces using the **NetworkManager** service:

- Starting the controller interface does not automatically start the port interfaces.
- Starting a port interface always starts the controller interface.
- Stopping the controller interface also stops the port interface.
- A controller without ports can start static IP connections.
- A controller without ports waits for ports when starting DHCP connections.
- A controller with a DHCP connection waiting for ports completes when you add a port with a carrier.
- A controller with a DHCP connection waiting for ports continues waiting when you add a port without carrier.

4.3. UNDERSTANDING THE TEAMD SERVICE, RUNNERS, AND LINK-WATCHERS

The team service, **teamd**, controls one instance of the team driver. This instance of the driver adds instances of a hardware device driver to form a team of network interfaces. The team driver presents a network interface, for example **team0**, to the kernel.

The **teamd** service implements the common logic to all methods of teaming. Those functions are unique to the different load sharing and backup methods, such as round-robin, and implemented by separate units of code referred to as **runners**. Administrators specify runners in JavaScript Object Notation

(JSON) format, and the JSON code is compiled into an instance of **teamd** when the instance is created. Alternatively, when using **NetworkManager**, you can set the runner in the **team.runner** parameter, and **NetworkManager** auto-creates the corresponding JSON code.

The following runners are available:

- **broadcast**: Transmits data over all ports.
- **roundrobin**: Transmits data over all ports in turn.
- **activebackup**: Transmits data over one port while the others are kept as a backup.
- **loadbalance**: Transmits data over all ports with active Tx load balancing and Berkeley Packet Filter (BPF)-based Tx port selectors.
- **random**: Transmits data on a randomly selected port.
- **lacp**: Implements the 802.3ad Link Aggregation Control Protocol (LACP).

The **teamd** services uses a link watcher to monitor the state of subordinate devices. The following link-watchers are available:

- **ethtool**: The **libteam** library uses the **ethtool** utility to watch for link state changes. This is the default link-watcher.
- **arp_ping**: The **libteam** library uses the **arp_ping** utility to monitor the presence of a far-end hardware address using Address Resolution Protocol (ARP).
- **nsna_ping**: On IPv6 connections, the **libteam** library uses the Neighbor Advertisement and Neighbor Solicitation features from the IPv6 Neighbor Discovery protocol to monitor the presence of a neighbor's interface.

Each runner can use any link watcher, with the exception of **lacp**. This runner can only use the **ethtool** link watcher.

4.4. CONFIGURING A NETWORK TEAM BY USING NMCLI

To configure a network team on the command line, use the **nmcli** utility.

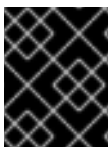

IMPORTANT

Network teaming is deprecated in Red Hat Enterprise Linux 9. Consider using the network bonding driver as an alternative. For details, see [Configuring network bonding](#).

Prerequisites

- The **teamd** and **NetworkManager-team** packages are installed.
- Two or more physical or virtual network devices are installed on the server.
- To use Ethernet devices as ports of the team, the physical or virtual Ethernet devices must be installed on the server and connected to a switch.
- To use bond, bridge, or VLAN devices as ports of the team, you can either create these devices while you create the team or you can create them in advance as described in:

- [Configuring a network bond by using nmcli](#)
- [Configuring a network bridge by using nmcli](#)
- [Configuring VLAN tagging by using nmcli](#)

Procedure

1. Create a team interface:

```
# nmcli connection add type team con-name team0 ifname team0 team.runner
activebackup
```

This command creates a network team named **team0** that uses the **activebackup** runner.

2. Optionally, set a link watcher. For example, to set the **ethtool** link watcher in the **team0** connection profile:

```
# nmcli connection modify team0 team.link-watchers "name=ethtool"
```

Link watchers support different parameters. To set parameters for a link watcher, specify them space-separated in the **name** property. Note that the name property must be surrounded by quotation marks. For example, to use the **ethtool** link watcher and set its **delay-up** parameter to **2500** milliseconds (2.5 seconds):

```
# nmcli connection modify team0 team.link-watchers "name=ethtool delay-up=2500"
```

To set multiple link watchers and each of them with specific parameters, the link watchers must be separated by a comma. The following example sets the **ethtool** link watcher with the **delay-up** parameter and the **arp_ping** link watcher with the **source-host** and **target-host** parameter:

```
# nmcli connection modify team0 team.link-watchers "name=ethtool delay-up=2,
name=arp_ping source-host=192.0.2.1 target-host=192.0.2.2"
```

3. Display the network interfaces, and note the names of the interfaces you want to add to the team:

```
# nmcli device status
DEVICE TYPE    STATE    CONNECTION
enp7s0 ethernet disconnected --
enp8s0 ethernet disconnected --
bond0  bond     connected bond0
bond1  bond     connected bond1
...
```

In this example:

- **enp7s0** and **enp8s0** are not configured. To use these devices as ports, add connection profiles in the next step. Note that you can only use Ethernet interfaces in a team that are not assigned to any connection.
- **bond0** and **bond1** have existing connection profiles. To use these devices as ports, modify their profiles in the next step.

4. Assign the port interfaces to the team:

- a. If the interfaces you want to assign to the team are not configured, create new connection profiles for them:

```
# nmcli connection add type ethernet slave-type team con-name team0-port1
ifname enp7s0 master team0
# nmcli connection add type ethernet slave-type team con-name team0-port2
ifname enp8s0 master team0
```

These commands create profiles for **enp7s0** and **enp8s0**, and add them to the **team0** connection.

- b. To assign an existing connection profile to the team:

- i. Set the **master** parameter of these connections to **team0**:

```
# nmcli connection modify bond0 master team0
# nmcli connection modify bond1 master team0
```

These commands assign the existing connection profiles named **bond0** and **bond1** to the **team0** connection.

- ii. Reactivate the connections:

```
# nmcli connection up bond0
# nmcli connection up bond1
```

5. Configure the IPv4 settings:

- To use this team device as a port of other devices, enter:

```
# nmcli connection modify team0 ipv4.method disabled
```

- To use DHCP, no action is required.
- To set a static IPv4 address, network mask, default gateway, and DNS server to the **team0** connection, enter:

```
# nmcli connection modify team0 ipv4.addresses '192.0.2.1/24' ipv4.gateway
'192.0.2.254' ipv4.dns '192.0.2.253' ipv4.dns-search 'example.com' ipv4.method
manual
```

6. Configure the IPv6 settings:

- To use this team device as a port of other devices, enter:

```
# nmcli connection modify team0 ipv6.method disabled
```

- To use stateless address autoconfiguration (SLAAC), no action is required.
- To set a static IPv6 address, network mask, default gateway, and DNS server to the **team0** connection, enter:

```
# nmcli connection modify team0 ipv6.addresses '2001:db8:1::1/64' ipv6.gateway  
'2001:db8:1::ffff' ipv6.dns '2001:db8:1::ffff' ipv6.dns-search 'example.com'  
ipv6.method manual
```

7. Activate the connection:

```
# nmcli connection up team0
```

Verification

- Display the status of the team:

```
# teamdctl team0 state  
setup:  
  runner: activebackup  
ports:  
  enp7s0  
    link watches:  
      link summary: up  
      instance[link_watch_0]:  
        name: ethtool  
        link: up  
        down count: 0  
  enp8s0  
    link watches:  
      link summary: up  
      instance[link_watch_0]:  
        name: ethtool  
        link: up  
        down count: 0  
runner:  
  active port: enp7s0
```

In this example, both ports are up.

Additional resources

- [Configuring NetworkManager to avoid using a specific profile to provide a default gateway](#)
- [Understanding the teamd service, runners, and link-watchers](#)
- **nm-settings(5)** man page
- **teamd.conf(5)** man page

4.5. CONFIGURING A NETWORK TEAM BY USING THE RHEL WEB CONSOLE

Use the RHEL web console to configure a network team if you prefer to manage network settings using a web browser-based interface.



IMPORTANT

Network teaming is deprecated in Red Hat Enterprise Linux 9. Consider using the network bonding driver as an alternative. For details, see [Configuring network bonding](#).

Prerequisites

- The **teamd** and **NetworkManager-team** packages are installed.
- Two or more physical or virtual network devices are installed on the server.
- To use Ethernet devices as ports of the team, the physical or virtual Ethernet devices must be installed on the server and connected to a switch.
- To use bond, bridge, or VLAN devices as ports of the team, create them in advance as described in:
 - [Configuring a network bond by using the RHEL web console](#)
 - [Configuring a network bridge by using the RHEL web console](#)
 - [Configuring VLAN tagging by using the RHEL web console](#)

Procedure

1. Select the **Networking** tab in the navigation on the left side of the screen.
2. Click **Add team** in the **Interfaces** section.
3. Enter the name of the team device you want to create.
4. Select the interfaces that should be ports of the team.
5. Select the runner of the team.
If you select **Load balancing** or **802.3ad LACP**, the web console shows the additional field **Balancer**.
6. Set the link watcher:
 - If you select **Ethtool**, additionally, set a link up and link down delay.
 - If you set **ARP ping** or **NSNA ping**, additionally, set a ping interval and ping target.

Team settings ✕

Name

Ports enp7s0
 enp8s0

Runner

Link watch

Link up delay

Link down delay

7. Click **Apply**.
8. By default, the team uses a dynamic IP address. If you want to set a static IP address:
 - a. Click the name of the team in the **Interfaces** section.
 - b. Click **Edit** next to the protocol you want to configure.
 - c. Select **Manual** next to **Addresses**, and enter the IP address, prefix, and default gateway.
 - d. In the **DNS** section, click the **+** button, and enter the IP address of the DNS server. Repeat this step to set multiple DNS servers.
 - e. In the **DNS search domains** section, click the **+** button, and enter the search domain.
 - f. If the interface requires static routes, configure them in the **Routes** section.

IPv4 settings ✕

Addresses Manual ▾ +

Address	Prefix length or netmask	Gateway	
<input style="width: 100%;" type="text" value="192.0.2.1"/>	<input style="width: 100%;" type="text" value="24"/>	<input style="width: 100%;" type="text" value="192.0.2.254"/>	-

DNS Automatic +

Server -

DNS search domains Automatic +

Search domain -

Routes Automatic +

Apply Cancel

g. Click **Apply**

Verification

1. Select the **Networking** tab in the navigation on the left side of the screen, and check if there is incoming and outgoing traffic on the interface.

Interfaces Add bond Add team Add bridge Add VLAN 				
Name	IP address	Sending	Receiving	
team0	192.0.2.1/24	1.11 Mbps	61.2 Mbps	

2. Display the status of the team:

```
# teamdctl team0 state
setup:
runner: activebackup
ports:
enp7s0
link watches:
link summary: up
instance[link_watch_0]:
name: ethtool
link: up
```

```

    down count: 0
  enp8s0
    link watches:
    link summary: up
    instance[link_watch_0]:
      name: ethtool
      link: up
      down count: 0
  runner:
    active port: enp7s0

```

In this example, both ports are up.

Additional resources

- [Network team runners](#)

4.6. CONFIGURING A NETWORK TEAM BY USING NM-CONNECTION-EDITOR

If you use Red Hat Enterprise Linux with a graphical interface, you can configure network teams using the **nm-connection-editor** application.

Note that **nm-connection-editor** can add only new ports to a team. To use an existing connection profile as a port, create the team using the **nmcli** utility as described in [Configuring a network team by using nmcli](#).

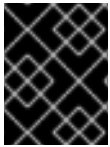

IMPORTANT

Network teaming is deprecated in Red Hat Enterprise Linux 9. Consider using the network bonding driver as an alternative. For details, see [Configuring network bonding](#).

Prerequisites

- The **teamd** and **NetworkManager-team** packages are installed.
- Two or more physical or virtual network devices are installed on the server.
- To use Ethernet devices as ports of the team, the physical or virtual Ethernet devices must be installed on the server.
- To use team, bond, or VLAN devices as ports of the team, ensure that these devices are not already configured.

Procedure

1. Open a terminal, and enter **nm-connection-editor**:

```
$ nm-connection-editor
```

2. Click the **+** button to add a new connection.
3. Select the **Team** connection type, and click **Create**.

4. On the **Team** tab:
 - a. Optional: Set the name of the team interface in the **Interface name** field.
 - b. Click the **Add** button to add a new connection profile for a network interface and adding the profile as a port to the team.
 - i. Select the connection type of the interface. For example, select **Ethernet** for a wired connection.
 - ii. Optional: Set a connection name for the port.
 - iii. If you create a connection profile for an Ethernet device, open the **Ethernet** tab, and select in the **Device** field the network interface you want to add as a port to the team. If you selected a different device type, configure it accordingly. Note that you can only use Ethernet interfaces in a team that are not assigned to any connection.
 - iv. Click **Save**.
 - c. Repeat the previous step for each interface you want to add to the team.

The screenshot shows a dialog box titled "Editing Team connection 1" with a close button (X) in the top right corner. The dialog is divided into several sections:

- Connection name:** A text field containing "Team connection 1".
- Navigation tabs:** "General", "Team" (selected), "Proxy", "IPv4 Settings", and "IPv6 Settings".
- Interface name:** A text field containing "team0".
- MTU:** A text field containing "automatic", followed by a minus sign button, a plus sign button, and the word "bytes".
- Teamed connections:** A list box containing "team0-port1" and "team0-port2".
- Buttons:** "Add" and "Edit" buttons are located to the right of the "Teamed connections" list.

- d. Click the **Advanced** button to set advanced options to the team connection.
 - i. On the **Runner** tab, select the runner.
 - ii. On the **Link Watcher** tab, set the link watcher and its optional settings.
 - iii. Click **OK**.
5. Configure the IP address settings on both the **IPv4 Settings** and **IPv6 Settings** tabs:
 - To use this bridge device as a port of other devices, set the **Method** field to **Disabled**.
 - To use DHCP, leave the **Method** field at its default, **Automatic (DHCP)**.
 - To use static IP settings, set the **Method** field to **Manual** and fill the fields accordingly:

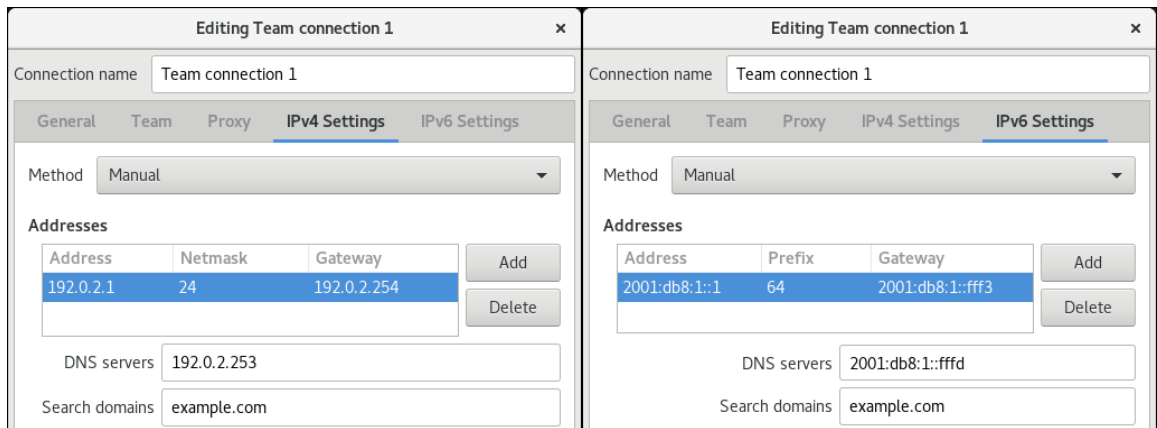

6. Click **Save**.
7. Close **nm-connection-editor**.

Verification

- Display the status of the team:

```
# teamdctl team0 state
setup:
  runner: activebackup
ports:
  enp7s0
    link watches:
      link summary: up
      instance[link_watch_0]:
        name: ethtool
        link: up
        down count: 0
  enp8s0
    link watches:
      link summary: up
      instance[link_watch_0]:
        name: ethtool
        link: up
        down count: 0
runner:
  active port: enp7s0
```

Additional resources

- [Configuring a network bond by using nm-connection-editor](#)
- [Configuring a network team by using nm-connection-editor](#)
- [Configuring VLAN tagging by using nm-connection-editor](#)
- [Configuring NetworkManager to avoid using a specific profile to provide a default gateway](#)
- [Understanding the teamd service, runners, and link-watchers](#)
- [NetworkManager duplicates a connection after restart of NetworkManager service](#)

CHAPTER 5. CONFIGURING VLAN TAGGING

A Virtual Local Area Network (VLAN) is a logical network within a physical network. The VLAN interface tags packets with the VLAN ID as they pass through the interface, and removes tags of returning packets. You create VLAN interfaces on top of another interface, such as Ethernet, bond, team, or bridge devices. These interfaces are called the **parent interface**.

Red Hat Enterprise Linux provides administrators different options to configure VLAN devices. For example:

- Use **nmcli** to configure VLAN tagging using the command line.
- Use the RHEL web console to configure VLAN tagging using a web browser.
- Use **nmtui** to configure VLAN tagging in a text-based user interface.
- Use the **nm-connection-editor** application to configure connections in a graphical interface.
- Use **nmstatectl** to configure connections through the Nmstate API.
- Use RHEL system roles to automate the VLAN configuration on one or multiple hosts.

5.1. CONFIGURING VLAN TAGGING BY USING NMCLI

You can configure Virtual Local Area Network (VLAN) tagging on the command line using the **nmcli** utility.

Prerequisites

- The interface you plan to use as a parent to the virtual VLAN interface supports VLAN tags.
- If you configure the VLAN on top of a bond interface:
 - The ports of the bond are up.
 - The bond is not configured with the **fail_over_mac=follow** option. A VLAN virtual device cannot change its MAC address to match the parent's new MAC address. In such a case, the traffic would still be sent with the incorrect source MAC address.
 - The bond is usually not expected to get IP addresses from a DHCP server or IPv6 auto-configuration. Ensure it by setting the **ipv4.method=disable** and **ipv6.method=ignore** options while creating the bond. Otherwise, if DHCP or IPv6 auto-configuration fails after some time, the interface might be brought down.
- The switch, the host is connected to, is configured to support VLAN tags. For details, see the documentation of your switch.

Procedure

1. Display the network interfaces:

```
# nmcli device status
DEVICE TYPE   STATE      CONNECTION
enp1s0  ethernet  disconnected enp1s0
```

```
bridge0 bridge connected bridge0
bond0 bond connected bond0
...
```

2. Create the VLAN interface. For example, to create a VLAN interface named **vlan10** that uses **enp1s0** as its parent interface and that tags packets with VLAN ID **10**, enter:

```
# nmcli connection add type vlan con-name vlan10 ifname vlan10 vlan.parent enp1s0
vlan.id 10
```

Note that the VLAN must be within the range from **0** to **4094**.

3. By default, the VLAN connection inherits the maximum transmission unit (MTU) from the parent interface. Optionally, set a different MTU value:

```
# nmcli connection modify vlan10 ethernet.mtu 2000
```

4. Configure the IPv4 settings:

- To use this VLAN device as a port of other devices, enter:

```
# nmcli connection modify vlan10 ipv4.method disabled
```

- To use DHCP, no action is required.
- To set a static IPv4 address, network mask, default gateway, and DNS server to the **vlan10** connection, enter:

```
# nmcli connection modify vlan10 ipv4.addresses '192.0.2.1/24' ipv4.gateway
'192.0.2.254' ipv4.dns '192.0.2.253' ipv4.method manual
```

5. Configure the IPv6 settings:

- To use this VLAN device as a port of other devices, enter:

```
# nmcli connection modify vlan10 ipv6.method disabled
```

- To use stateless address autoconfiguration (SLAAC), no action is required.
- To set a static IPv6 address, network mask, default gateway, and DNS server to the **vlan10** connection, enter:

```
# nmcli connection modify vlan10 ipv6.addresses '2001:db8:1::1/32' ipv6.gateway
'2001:db8:1::fffe' ipv6.dns '2001:db8:1::fffd' ipv6.method manual
```

6. Activate the connection:

```
# nmcli connection up vlan10
```

Verification

- Verify the settings:

ip -d addr show vlan10

```

4: vlan10@enp1s0: <BROADCAST,MULTICAST,UP,LOWER_UP> mtu 1500 qdisc noqueue
state UP group default qlen 1000
    link/ether 52:54:00:72:2f:6e brd ff:ff:ff:ff:ff:ff promiscuity 0
    vlan protocol 802.1Q id 10 <REORDER_HDR> numtxqueues 1 numrxqueues 1
gso_max_size 65536 gso_max_segs 65535
    inet 192.0.2.1/24 brd 192.0.2.255 scope global noprefixroute vlan10
        valid_lft forever preferred_lft forever
    inet6 2001:db8:1::1/32 scope global noprefixroute
        valid_lft forever preferred_lft forever
    inet6 fe80::8dd7:9030:6f8e:89e6/64 scope link noprefixroute
        valid_lft forever preferred_lft forever

```

Additional resources

- [Configuring NetworkManager to avoid using a specific profile to provide a default gateway](#)
- **nm-settings(5)** man page

5.2. CONFIGURING NESTED VLANS BY USING NMCLI

802.1ad is a protocol used for Virtual Local Area Network (VLAN) tagging. It is also known as Q-in-Q tagging. You can use this technology to create multiple VLAN tags within a single Ethernet frame to achieve the following benefits:

- Increased network scalability by creating multiple isolated network segments within a VLAN. This enables you to segment and organize large networks into smaller, manageable units.
- Improved traffic management by isolating and controlling different types of network traffic. This can improve the network performance and reduce network congestion.
- Efficient resource utilization by enabling the creation of smaller, more targeted network segments.
- Enhanced security by isolating network traffic and reducing the risk of unauthorized access to sensitive data.

Prerequisites

- The interface you plan to use as a parent to the virtual VLAN interface supports VLAN tags.
- If you configure the VLAN on top of a bond interface:
 - The ports of the bond are up.
 - The bond is not configured with the **fail_over_mac=follow** option. A VLAN virtual device cannot change its MAC address to match the parent's new MAC address. In such a case, the traffic would still be sent with the incorrect source MAC address.
 - The bond is usually not expected to get IP addresses from a DHCP server or IPv6 auto-configuration. Ensure it by setting the **ipv4.method=disable** and **ipv6.method=ignore** options while creating the bond. Otherwise, if DHCP or IPv6 auto-configuration fails after some time, the interface might be brought down.

- The switch, the host is connected to, is configured to support VLAN tags. For details, see the documentation of your switch.

Procedure

1. Display the physical network devices:

```
# nmcli device status
DEVICE TYPE STATE CONNECTION
enp1s0 ethernet connected enp1s0
...
```

2. Create the base VLAN interface. For example, to create a base VLAN interface named **vlan10** that uses **enp1s0** as its parent interface and that tags packets with VLAN ID **10**, enter:

```
# nmcli connection add type vlan con-name vlan10 dev enp1s0 vlan.id 10
```

Note that the VLAN must be within the range from **0** to **4094**.

3. By default, the VLAN connection inherits the maximum transmission unit (MTU) from the parent interface. Optionally, set a different MTU value:

```
# nmcli connection modify vlan10 ethernet.mtu 2000
```

4. Create the nested VLAN interface on top of the base VLAN interface:

```
# nmcli connection add type vlan con-name vlan10.20 dev enp1s0.10 id 20
vlan.protocol 802.1ad
```

This command creates a new VLAN connection with a name of **vlan10.20** and a VLAN ID of **20** on the parent VLAN connection **vlan10**. The **dev** option specifies the parent network device. In this case it is **enp1s0.10**. The **vlan.protocol** option specifies the VLAN encapsulation protocol. In this case it is **802.1ad** (Q-in-Q).

5. Configure the IPv4 settings of the nested VLAN interface:

- To use DHCP, no action is required.
- To set a static IPv4 address, network mask, default gateway, and DNS server to the **vlan10.20** connection, enter:

```
# nmcli connection modify vlan10.20 ipv4.method manual ipv4.addresses
192.0.2.1/24 ipv4.gateway 192.0.2.254 ipv4.dns 192.0.2.200
```

6. Configure the IPv6 settings of the nested VLAN interface:

- To use stateless address autoconfiguration (SLAAC), no action is required.
- To set a static IPv4 address, network mask, default gateway, and DNS server to the **vlan10** connection, enter:

```
# nmcli connection modify vlan10 ipv4.addresses '192.0.2.1/24' ipv4.gateway
'192.0.2.254' ipv4.dns '192.0.2.253' ipv4.method manual
```

7. Activate the profile:

```
# nmcli connection up vlan10.20
```

Verification

1. Verify the configuration of the nested VLAN interface:

```
# ip -d addr show enp1s0.10.20
10: enp1s0.10.20@enp1s0.10: <BROADCAST,MULTICAST,UP,LOWER_UP> mtu 1500
qdisc noqueue state UP group default qlen 1000
    link/ether 52:54:00:d2:74:3e brd ff:ff:ff:ff:ff:ff promiscuity 0 minmtu 0 maxmtu 65535
    vlan protocol 802.1ad id 20 <REORDER_HDR> numtxqueues 1 numrxqueues 1
    gso_max_size 65536 gso_max_segs 65535 tso_max_size 65536 tso_max_segs 65535
    gro_max_size 65536
    inet 192.0.2.1/24 brd 192.0.2.255 scope global noprefixroute enp1s0.10.20
        valid_lft forever preferred_lft forever
    inet6 2001:db8:1::1/32 scope global noprefixroute
        valid_lft forever preferred_lft forever
    inet6 fe80::ce3b:84c5:9ef8:d0e6/64 scope link noprefixroute
        valid_lft forever preferred_lft forever
```

Additional resources

- **nm-settings(5)** man page

5.3. CONFIGURING VLAN TAGGING BY USING THE RHEL WEB CONSOLE

Use the RHEL web console to configure VLAN tagging if you prefer to manage network settings using a web browser-based interface.

Prerequisites

- The interface you plan to use as a parent to the virtual VLAN interface supports VLAN tags.
- If you configure the VLAN on top of a bond interface:
 - The ports of the bond are up.
 - The bond is not configured with the **fail_over_mac=follow** option. A VLAN virtual device cannot change its MAC address to match the parent's new MAC address. In such a case, the traffic would still be sent with the incorrect source MAC address.
 - The bond is usually not expected to get IP addresses from a DHCP server or IPv6 auto-configuration. Ensure it by disabling the IPv4 and IPv6 protocol creating the bond. Otherwise, if DHCP or IPv6 auto-configuration fails after some time, the interface might be brought down.
- The switch, the host is connected to, is configured to support VLAN tags. For details, see the documentation of your switch.

Procedure

1. Select the **Networking** tab in the navigation on the left side of the screen.
2. Click **Add VLAN** in the **Interfaces** section.
3. Select the parent device.
4. Enter the VLAN ID.
5. Enter the name of the VLAN device or keep the automatically-generated name.

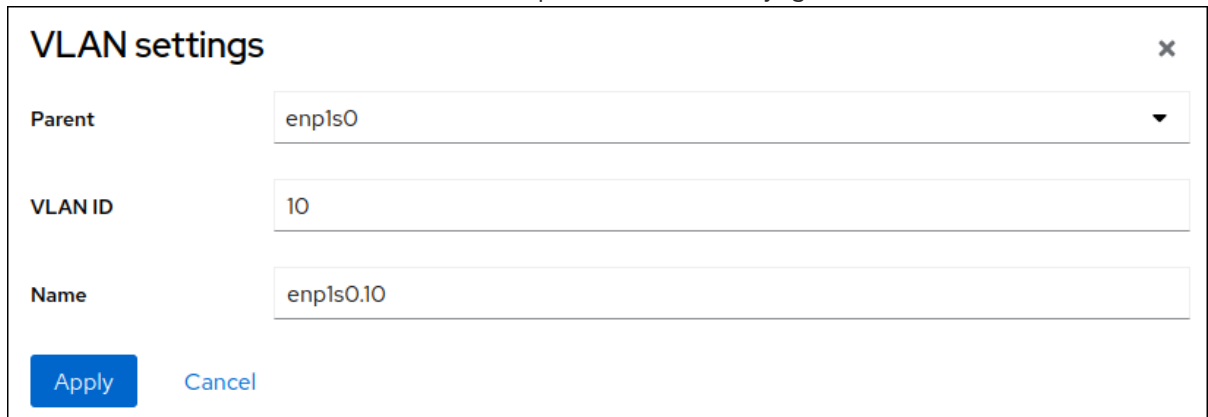

VLAN settings x

Parent

VLAN ID

Name

6. Click **Apply**.
7. By default, the VLAN device uses a dynamic IP address. If you want to set a static IP address:
 - a. Click the name of the VLAN device in the **Interfaces** section.
 - b. Click **Edit** next to the protocol you want to configure.
 - c. Select **Manual** next to **Addresses**, and enter the IP address, prefix, and default gateway.
 - d. In the **DNS** section, click the **+** button, and enter the IP address of the DNS server. Repeat this step to set multiple DNS servers.
 - e. In the **DNS search domains** section, click the **+** button, and enter the search domain.
 - f. If the interface requires static routes, configure them in the **Routes** section.

IPv4 settings ✕

Addresses Manual ▾ +

Address	Prefix length or netmask	Gateway	
<input type="text" value="192.0.2.1"/>	<input type="text" value="24"/>	<input type="text" value="192.0.2.254"/>	-

DNS Automatic +

Server -

DNS search domains Automatic +

Search domain -

Routes Automatic +

Apply Cancel

g. Click **Apply**

Verification

- Select the **Networking** tab in the navigation on the left side of the screen, and check if there is incoming and outgoing traffic on the interface:

Interfaces Add bond Add team Add bridge Add VLAN 				
Name	IP address	Sending	Receiving	
enp1s0.10	192.0.2.1/24	1.11 Mbps	61.2 Mbps	

5.4. CONFIGURING VLAN TAGGING BY USING NMTUI

The **nmtui** application provides a text-based user interface for NetworkManager. You can use **nmtui** to configure VLAN tagging on a host without a graphical interface.



NOTE

In **nmtui**:

- Navigate by using the cursor keys.
- Press a button by selecting it and hitting **Enter**.
- Select and deselect checkboxes by using **Space**.

Prerequisites

- The interface you plan to use as a parent to the virtual VLAN interface supports VLAN tags.
- If you configure the VLAN on top of a bond interface:
 - The ports of the bond are up.
 - The bond is not configured with the **fail_over_mac=follow** option. A VLAN virtual device cannot change its MAC address to match the parent's new MAC address. In such a case, the traffic would still be sent with the then incorrect source MAC address.
 - The bond is usually not expected to get IP addresses from a DHCP server or IPv6 auto-configuration. Ensure it by setting the **ipv4.method=disable** and **ipv6.method=ignore** options while creating the bond. Otherwise, if DHCP or IPv6 auto-configuration fails after some time, the interface might be brought down.
- The switch the host is connected to is configured to support VLAN tags. For details, see the documentation of your switch.

Procedure

1. If you do not know the network device name on which you want configure VLAN tagging, display the available devices:

```
# nmcli device status
DEVICE  TYPE    STATE      CONNECTION
enp1s0  ethernet unavailable --
...
```

2. Start **nmtui**:

```
# nmtui
```

3. Select **Edit a connection**, and press **Enter**.
4. Press the **Add** button.
5. Select **VLAN** from the list of network types, and press **Enter**.
6. Optional: Enter a name for the NetworkManager profile to be created.
On hosts with multiple profiles, a meaningful name makes it easier to identify the purpose of a profile.
7. Enter the VLAN device name to be created into the **Device** field.

8. Enter the name of the device on which you want to configure VLAN tagging into the **Parent** field.
9. Enter the VLAN ID. The ID must be within the range from **0** to **4094**.
10. Depending on your environment, configure the IP address settings in the **IPv4 configuration** and **IPv6 configuration** areas accordingly. For this, press the button next to these areas, and select:
 - **Disabled**, if this VLAN device does not require an IP address or you want to use it as a port of other devices.
 - **Automatic**, if a DHCP server or stateless address autoconfiguration (SLAAC) dynamically assigns an IP address to the VLAN device.
 - **Manual**, if the network requires static IP address settings. In this case, you must fill further fields:
 - i. Press the **Show** button next to the protocol you want to configure to display additional fields.
 - ii. Press the **Add** button next to **Addresses**, and enter the IP address and the subnet mask in Classless Inter-Domain Routing (CIDR) format.
If you do not specify a subnet mask, NetworkManager sets a **/32** subnet mask for IPv4 addresses and **/64** for IPv6 addresses.
 - iii. Enter the address of the default gateway.
 - iv. Press the **Add** button next to **DNS servers**, and enter the DNS server address.
 - v. Press the **Add** button next to **Search domains**, and enter the DNS search domain.

Figure 5.1. Example of a VLAN connection with static IP address settings

The screenshot shows the 'Edit Connection' window for a connection named 'vlan10'. The window is divided into several sections:

- Profile name:** vlan10
- Device:** vlan10
- VLAN:**
 - Parent: enp1s0
 - VLAN id: 10
 - Cloned MAC address: (empty)
 - MTU: (default)
- IPv4 CONFIGURATION <Manual>**
 - Addresses: 192.0.2.1/24 (with <Remove> and <Add...> buttons)
 - Gateway: 192.0.2.254
 - DNS servers: 192.0.2.253 (with <Remove> and <Add...> buttons)
 - Search domains: <Add...>
 - Routing (No custom routes) <Edit...>
 - Never use this network for default route
 - Ignore automatically obtained routes
 - Ignore automatically obtained DNS parameters
 - Require IPv4 addressing for this connection
- IPv6 CONFIGURATION <Manual>**
 - Addresses: 2001:db8:1::1/32 (with <Remove> and <Add...> buttons)
 - Gateway: 2001:db8:1::fffe
 - DNS servers: 2001:db8:1::fffd (with <Remove> and <Add...> buttons)
 - Search domains: <Add...>
 - Routing (No custom routes) <Edit...>
 - Never use this network for default route
 - Ignore automatically obtained routes
 - Ignore automatically obtained DNS parameters
 - Require IPv6 addressing for this connection
- Automatically connect
- Available to all users

At the bottom right, there are buttons for '<Cancel>' and '<OK>'.

11. Press the **OK** button to create and automatically activate the new connection.
12. Press the **Back** button to return to the main menu.
13. Select **Quit**, and press **Enter** to close the **nmtui** application.

Verification

- Verify the settings:

```
# ip -d addr show vlan10
4: vlan10@enp1s0: <BROADCAST,MULTICAST,UP,LOWER_UP> mtu 1500 qdisc noqueue
state UP group default qlen 1000
    link/ether 52:54:00:72:2f:6e brd ff:ff:ff:ff:ff:ff promiscuity 0
    vlan protocol 802.1Q id 10 <REORDER_HDR> numtxqueues 1 numrxqueues 1
gso_max_size 65536 gso_max_segs 65535
    inet 192.0.2.1/24 brd 192.0.2.255 scope global noprefixroute vlan10
        valid_lft forever preferred_lft forever
    inet6 2001:db8:1::1/32 scope global noprefixroute
        valid_lft forever preferred_lft forever
    inet6 fe80::8dd7:9030:6f8e:89e6/64 scope link noprefixroute
        valid_lft forever preferred_lft forever
```

5.5. CONFIGURING VLAN TAGGING BY USING NM-CONNECTION-EDITOR

You can configure Virtual Local Area Network (VLAN) tagging in a graphical interface using the **nm-connection-editor** application.

Prerequisites

- The interface you plan to use as a parent to the virtual VLAN interface supports VLAN tags.
- If you configure the VLAN on top of a bond interface:
 - The ports of the bond are up.
 - The bond is not configured with the **fail_over_mac=follow** option. A VLAN virtual device cannot change its MAC address to match the parent's new MAC address. In such a case, the traffic would still be sent with the incorrect source MAC address.
- The switch, the host is connected, to is configured to support VLAN tags. For details, see the documentation of your switch.

Procedure

1. Open a terminal, and enter **nm-connection-editor**:

```
$ nm-connection-editor
```

2. Click the **+** button to add a new connection.
3. Select the **VLAN** connection type, and click **Create**.
4. On the **VLAN** tab:
 - a. Select the parent interface.
 - b. Select the VLAN id. Note that the VLAN must be within the range from **0** to **4094**.
 - c. By default, the VLAN connection inherits the maximum transmission unit (MTU) from the parent interface. Optionally, set a different MTU value.
 - d. Optionally, set the name of the VLAN interface and further VLAN-specific options.

Editing VLAN connection 1

Connection name: VLAN connection 1

General **VLAN** Proxy IPv4 Settings IPv6 Settings

Parent interface: enp1s0 (52:54:00:72:2F:6E)

VLAN id: 10

VLAN interface name: vlan10

Cloned MAC address:

MTU: automatic bytes

Flags: Reorder headers GVRP Loose binding MVRP

5. Configure the IP address settings on both the **IPv4 Settings** and **IPv6 Settings** tabs:

- To use this bridge device as a port of other devices, set the **Method** field to **Disabled**.
- To use DHCP, leave the **Method** field at its default, **Automatic (DHCP)**.
- To use static IP settings, set the **Method** field to **Manual** and fill the fields accordingly:

Editing VLAN connection 1

Connection name: VLAN connection 1

General VLAN Proxy **IPv4 Settings** IPv6 Settings

Method: Manual

Addresses

Address	Netmask	Gateway
192.0.2.1	24	192.0.2.254

DNS servers: 192.0.2.253

Editing VLAN connection 1

Connection name: VLAN connection 1

General VLAN Proxy IPv4 Settings **IPv6 Settings**

Method: Manual

Addresses

Address	Prefix	Gateway
2001:db8:1::1	64	2001:db8:1::fff3

DNS servers: 2001:db8:1::fffd

6. Click **Save**.

7. Close **nm-connection-editor**.

Verification

1. Verify the settings:

```
# ip -d addr show vlan10
4: vlan10@enp1s0: <BROADCAST,MULTICAST,UP,LOWER_UP> mtu 1500 qdisc noqueue
state UP group default qlen 1000
    link/ether 52:54:00:d5:e0:fb brd ff:ff:ff:ff:ff:ff promiscuity 0
    vlan protocol 802.1Q id 10 <REORDER_HDR> numtxqueues 1 numrxqueues 1
gso_max_size 65536 gso_max_segs 65535
    inet 192.0.2.1/24 brd 192.0.2.255 scope global noprefixroute vlan10
        valid_lft forever preferred_lft forever
    inet6 2001:db8:1::1/32 scope global noprefixroute
        valid_lft forever preferred_lft forever
    inet6 fe80::8dd7:9030:6f8e:89e6/64 scope link noprefixroute
        valid_lft forever preferred_lft forever
```

-

Additional resources

- [Configuring NetworkManager to avoid using a specific profile to provide a default gateway](#)

5.6. CONFIGURING VLAN TAGGING BY USING NMSTATECTL

Use the **nmstatectl** utility to configure Virtual Local Area Network VLAN through the Nmstate API. The Nmstate API ensures that, after setting the configuration, the result matches the configuration file. If anything fails, **nmstatectl** automatically rolls back the changes to avoid leaving the system in an incorrect state.

Depending on your environment, adjust the YAML file accordingly. For example, to use different devices than Ethernet adapters in the VLAN, adapt the **base-iface** attribute and **type** attributes of the ports you use in the VLAN.

Prerequisites

- To use Ethernet devices as ports in the VLAN, the physical or virtual Ethernet devices must be installed on the server.
- The **nmstate** package is installed.

Procedure

1. Create a YAML file, for example **~/create-vlan.yml**, with the following content:

```
---
interfaces:
- name: vlan10
  type: vlan
  state: up
  ipv4:
    enabled: true
    address:
    - ip: 192.0.2.1
      prefix-length: 24
    dhcp: false
  ipv6:
    enabled: true
    address:
    - ip: 2001:db8:1::1
      prefix-length: 64
    autoconf: false
    dhcp: false
  vlan:
    base-iface: enp1s0
    id: 10
- name: enp1s0
  type: ethernet
  state: up

routes:
  config:
  - destination: 0.0.0.0/0
```

```

next-hop-address: 192.0.2.254
next-hop-interface: vlan10
- destination: ::0
next-hop-address: 2001:db8:1::fffe
next-hop-interface: vlan10

```

```

dns-resolver:
config:
search:
- example.com
server:
- 192.0.2.200
- 2001:db8:1::ffbb

```

These settings define a VLAN with ID 10 that uses the **enp1s0** device. As the child device, the VLAN connection has the following settings:

- A static IPv4 address - **192.0.2.1** with the **/24** subnet mask
- A static IPv6 address - **2001:db8:1::1** with the **/64** subnet mask
- An IPv4 default gateway - **192.0.2.254**
- An IPv6 default gateway - **2001:db8:1::fffe**
- An IPv4 DNS server - **192.0.2.200**
- An IPv6 DNS server - **2001:db8:1::ffbb**
- A DNS search domain - **example.com**

2. Apply the settings to the system:

```
# nmstatectl apply ~/create-vlan.yml
```

Verification

1. Display the status of the devices and connections:

```
# nmcli device status
DEVICE  TYPE  STATE  CONNECTION
vlan10  vlan  connected  vlan10
```

2. Display all settings of the connection profile:

```
# nmcli connection show vlan10
connection.id:      vlan10
connection.uuid:    1722970f-788e-4f81-bd7d-a86bf21c9df5
connection.stable-id:  --
connection.type:    vlan
connection.interface-name:  vlan10
...
```

3. Display the connection settings in YAML format:

```
# nmstatectl show vlan0
```

Additional resources

- **nmstatectl(8)** man page
- `/usr/share/doc/nmstate/examples/` directory

5.7. CONFIGURING VLAN TAGGING BY USING THE NETWORK RHEL SYSTEM ROLE

You can use the **network** RHEL system role to configure VLAN tagging. This example adds an Ethernet connection and a VLAN with ID **10** on top of this Ethernet connection. As the child device, the VLAN connection contains the IP, default gateway, and DNS configurations.

Depending on your environment, adjust the play accordingly. For example:

- To use the VLAN as a port in other connections, such as a bond, omit the **ip** attribute, and set the IP configuration in the child configuration.
- To use team, bridge, or bond devices in the VLAN, adapt the **interface_name** and **type** attributes of the ports you use in the VLAN.

Prerequisites

- [You have prepared the control node and the managed nodes](#)
- You are logged in to the control node as a user who can run playbooks on the managed nodes.
- The account you use to connect to the managed nodes has **sudo** permissions on them.

Procedure

1. Create a playbook file, for example `~/playbook.yml`, with the following content:

```
---
- name: Configure the network
  hosts: managed-node-01.example.com
  tasks:
    - name: Configure a VLAN that uses an Ethernet connection
      ansible.builtin.include_role:
        name: rhel-system-roles.network
      vars:
        network_connections:
          # Add an Ethernet profile for the underlying device of the VLAN
          - name: enp1s0
            type: ethernet
            interface_name: enp1s0
            autoconnect: yes
            state: up
            ip:
              dhcp4: no
              auto6: no
```

```
# Define the VLAN profile
- name: enp1s0.10
  type: vlan
  ip:
    address:
      - "192.0.2.1/24"
      - "2001:db8:1::1/64"
    gateway4: 192.0.2.254
    gateway6: 2001:db8:1::fffe
  dns:
    - 192.0.2.200
    - 2001:db8:1::ffbb
  dns_search:
    - example.com
  vlan_id: 10
  parent: enp1s0
  state: up
```

These settings define a VLAN to operate on top of the **enp1s0** device. The VLAN interface has the following settings:

- A static IPv4 address – **192.0.2.1** with a **/24** subnet mask
- A static IPv6 address – **2001:db8:1::1** with a **/64** subnet mask
- An IPv4 default gateway – **192.0.2.254**
- An IPv6 default gateway – **2001:db8:1::fffe**
- An IPv4 DNS server – **192.0.2.200**
- An IPv6 DNS server – **2001:db8:1::ffbb**
- A DNS search domain – **example.com**
- VLAN ID – **10**

The **parent** attribute in the VLAN profile configures the VLAN to operate on top of the **enp1s0** device. As the child device, the VLAN connection contains the IP, default gateway, and DNS configurations.

2. Validate the playbook syntax:

```
$ ansible-playbook --syntax-check ~/playbook.yml
```

Note that this command only validates the syntax and does not protect against a wrong but valid configuration.

3. Run the playbook:

```
$ ansible-playbook ~/playbook.yml
```

Additional resources

- `/usr/share/ansible/roles/rhel-system-roles.network/README.md` file
- `/usr/share/doc/rhel-system-roles/network/` directory

5.8. ADDITIONAL RESOURCES

- [VLANs for sysadmins: The basics](#)

CHAPTER 6. CONFIGURING A NETWORK BRIDGE

A network bridge is a link-layer device which forwards traffic between networks based on a table of MAC addresses. The bridge builds the MAC addresses table by listening to network traffic and thereby learning what hosts are connected to each network. For example, you can use a software bridge on a Red Hat Enterprise Linux host to emulate a hardware bridge or in virtualization environments, to integrate virtual machines (VM) to the same network as the host.

A bridge requires a network device in each network the bridge should connect. When you configure a bridge, the bridge is called **controller** and the devices it uses **ports**.

You can create bridges on different types of devices, such as:

- Physical and virtual Ethernet devices
- Network bonds
- Network teams
- VLAN devices

Due to the IEEE 802.11 standard which specifies the use of 3-address frames in Wi-Fi for the efficient use of airtime, you cannot configure a bridge over Wi-Fi networks operating in Ad-Hoc or Infrastructure modes.

6.1. CONFIGURING A NETWORK BRIDGE BY USING NMCLI

To configure a network bridge on the command line, use the **nmcli** utility.

Prerequisites

- Two or more physical or virtual network devices are installed on the server.
- To use Ethernet devices as ports of the bridge, the physical or virtual Ethernet devices must be installed on the server.
- To use team, bond, or VLAN devices as ports of the bridge, you can either create these devices while you create the bridge or you can create them in advance as described in:
 - [Configuring a network team by using nmcli](#)
 - [Configuring a network bond by using nmcli](#)
 - [Configuring VLAN tagging by using nmcli](#)

Procedure

1. Create a bridge interface:

```
# nmcli connection add type bridge con-name bridge0 ifname bridge0
```

This command creates a bridge named **bridge0**, enter:

2. Display the network interfaces, and note the names of the interfaces you want to add to the bridge:

■

```
# nmcli device status
DEVICE TYPE STATE CONNECTION
enp7s0 ethernet disconnected --
enp8s0 ethernet disconnected --
bond0 bond connected bond0
bond1 bond connected bond1
...
```

In this example:

- **enp7s0** and **enp8s0** are not configured. To use these devices as ports, add connection profiles in the next step.
- **bond0** and **bond1** have existing connection profiles. To use these devices as ports, modify their profiles in the next step.

3. Assign the interfaces to the bridge.

- If the interfaces you want to assign to the bridge are not configured, create new connection profiles for them:

```
# nmcli connection add type ethernet slave-type bridge con-name bridge0-port1
ifname enp7s0 master bridge0
# nmcli connection add type ethernet slave-type bridge con-name bridge0-port2
ifname enp8s0 master bridge0
```

These commands create profiles for **enp7s0** and **enp8s0**, and add them to the **bridge0** connection.

- If you want to assign an existing connection profile to the bridge:
 - Set the **master** parameter of these connections to **bridge0**:

```
# nmcli connection modify bond0 master bridge0
# nmcli connection modify bond1 master bridge0
```

These commands assign the existing connection profiles named **bond0** and **bond1** to the **bridge0** connection.

- Reactivate the connections:

```
# nmcli connection up bond0
# nmcli connection up bond1
```

4. Configure the IPv4 settings:

- To use this bridge device as a port of other devices, enter:

```
# nmcli connection modify bridge0 ipv4.method disabled
```

- To use DHCP, no action is required.
- To set a static IPv4 address, network mask, default gateway, and DNS server to the **bridge0** connection, enter:

```
# nmcli connection modify bridge0 ipv4.addresses '192.0.2.1/24' ipv4.gateway
'192.0.2.254' ipv4.dns '192.0.2.253' ipv4.dns-search 'example.com' ipv4.method
manual
```

5. Configure the IPv6 settings:

- To use this bridge device as a port of other devices, enter:

```
# nmcli connection modify bridge0 ipv6.method disabled
```

- To use stateless address autoconfiguration (SLAAC), no action is required.
- To set a static IPv6 address, network mask, default gateway, and DNS server to the **bridge0** connection, enter:

```
# nmcli connection modify bridge0 ipv6.addresses '2001:db8:1::1/64' ipv6.gateway
'2001:db8:1::ffe' ipv6.dns '2001:db8:1::fffd' ipv6.dns-search 'example.com'
ipv6.method manual
```

6. Optional: Configure further properties of the bridge. For example, to set the Spanning Tree Protocol (STP) priority of **bridge0** to **16384**, enter:

```
# nmcli connection modify bridge0 bridge.priority '16384'
```

By default, STP is enabled.

7. Activate the connection:

```
# nmcli connection up bridge0
```

8. Verify that the ports are connected, and the **CONNECTION** column displays the port's connection name:

```
# nmcli device
DEVICE TYPE STATE CONNECTION
...
enp7s0 ethernet connected bridge0-port1
enp8s0 ethernet connected bridge0-port2
```

When you activate any port of the connection, NetworkManager also activates the bridge, but not the other ports of it. You can configure that Red Hat Enterprise Linux enables all ports automatically when the bridge is enabled:

- Enable the **connection.autoconnect-slaves** parameter of the bridge connection:

```
# nmcli connection modify bridge0 connection.autoconnect-slaves 1
```

- Reactivate the bridge:

```
# nmcli connection up bridge0
```

Verification

- Use the **ip** utility to display the link status of Ethernet devices that are ports of a specific bridge:

```
# ip link show master bridge0
```

```
3: enp7s0: <BROADCAST,MULTICAST,UP,LOWER_UP> mtu 1500 qdisc fq_codel master
bridge0 state UP mode DEFAULT group default qlen 1000
    link/ether 52:54:00:62:61:0e brd ff:ff:ff:ff:ff:ff
4: enp8s0: <BROADCAST,MULTICAST,UP,LOWER_UP> mtu 1500 qdisc fq_codel master
bridge0 state UP mode DEFAULT group default qlen 1000
    link/ether 52:54:00:9e:f1:ce brd ff:ff:ff:ff:ff:ff
```

- Use the **bridge** utility to display the status of Ethernet devices that are ports of any bridge device:

```
# bridge link show
```

```
3: enp7s0: <BROADCAST,MULTICAST,UP,LOWER_UP> mtu 1500 master bridge0 state
forwarding priority 32 cost 100
4: enp8s0: <BROADCAST,MULTICAST,UP,LOWER_UP> mtu 1500 master bridge0 state
listening priority 32 cost 100
5: enp9s0: <BROADCAST,MULTICAST,UP,LOWER_UP> mtu 1500 master bridge1 state
forwarding priority 32 cost 100
6: enp11s0: <BROADCAST,MULTICAST,UP,LOWER_UP> mtu 1500 master bridge1 state
blocking priority 32 cost 100
...
```

To display the status for a specific Ethernet device, use the **bridge link show dev *ethernet_device_name*** command.

Additional resources

- [Configuring NetworkManager to avoid using a specific profile to provide a default gateway](#)
- **nm-settings(5)** man page
- **bridge(8)** man page
- [NetworkManager duplicates a connection after restart of NetworkManager service](#)
- [How to configure a bridge with VLAN information?](#)

6.2. CONFIGURING A NETWORK BRIDGE BY USING THE RHEL WEB CONSOLE

Use the RHEL web console to configure a network bridge if you prefer to manage network settings using a web browser-based interface.

Prerequisites

- Two or more physical or virtual network devices are installed on the server.
- To use Ethernet devices as ports of the bridge, the physical or virtual Ethernet devices must be installed on the server.
- To use team, bond, or VLAN devices as ports of the bridge, you can either create these devices while you create the bridge or you can create them in advance as described in:

- [Configuring a network team using the RHEL web console](#)
- [Configuring a network bond by using the RHEL web console](#)
- [Configuring VLAN tagging by using the RHEL web console](#)

Procedure

1. Select the **Networking** tab in the navigation on the left side of the screen.
2. Click **Add bridge** in the **Interfaces** section.
3. Enter the name of the bridge device you want to create.
4. Select the interfaces that should be ports of the bridge.
5. Optional: Enable the **Spanning tree protocol (STP)** feature to avoid bridge loops and broadcast radiation.

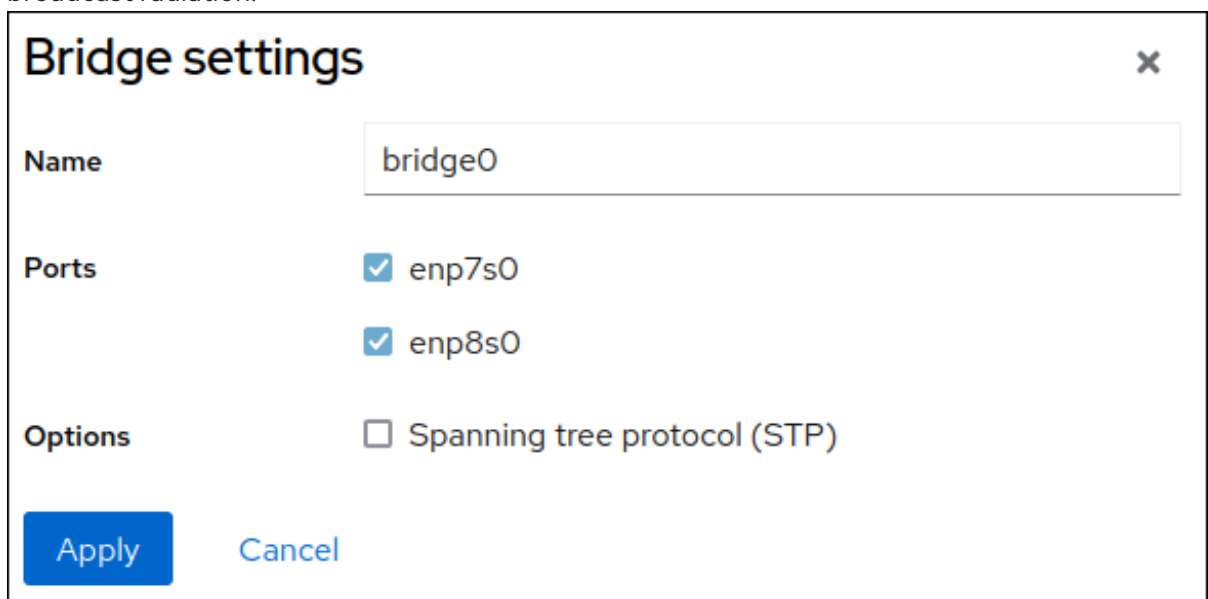

Bridge settings x

Name

Ports

- enp7s0
- enp8s0

Options

- Spanning tree protocol (STP)

Apply **Cancel**

6. Click **Apply**.
7. By default, the bridge uses a dynamic IP address. If you want to set a static IP address:
 - a. Click the name of the bridge in the **Interfaces** section.
 - b. Click **Edit** next to the protocol you want to configure.
 - c. Select **Manual** next to **Addresses**, and enter the IP address, prefix, and default gateway.
 - d. In the **DNS** section, click the **+** button, and enter the IP address of the DNS server. Repeat this step to set multiple DNS servers.
 - e. In the **DNS search domains** section, click the **+** button, and enter the search domain.
 - f. If the interface requires static routes, configure them in the **Routes** section.

IPv4 settings ✕

Addresses Manual ▾ +

Address	Prefix length or netmask	Gateway	
192.0.2.1	24	192.0.2.254	-

DNS Automatic +

Server 192.0.2.253 -

DNS search domains Automatic +

Search domain example.com -

Routes Automatic +

Apply Cancel

g. Click **Apply**

Verification

1. Select the **Networking** tab in the navigation on the left side of the screen, and check if there is incoming and outgoing traffic on the interface:

Interfaces Add bond Add team Add bridge Add VLAN 				
Name	IP address	Sending	Receiving	
bridge0	192.0.2.1/24	1.11 Mbps	61.2 Mbps	

6.3. CONFIGURING A NETWORK BRIDGE BY USING NMTUI

The **nmtui** application provides a text-based user interface for NetworkManager. You can use **nmtui** to configure a network bridge on a host without a graphical interface.

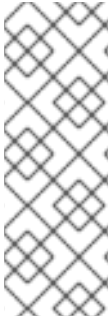

NOTE

In **nmtui**:

- Navigate by using the cursor keys.
- Press a button by selecting it and hitting **Enter**.
- Select and deselect checkboxes by using **Space**.

Prerequisites

- Two or more physical or virtual network devices are installed on the server.
- To use Ethernet devices as ports of the bridge, the physical or virtual Ethernet devices must be installed on the server.

Procedure

1. If you do not know the network device names on which you want configure a network bridge, display the available devices:

```
# nmcli device status
DEVICE  TYPE    STATE      CONNECTION
enp7s0  ethernet unavailable --
enp8s0  ethernet unavailable --
...
```

2. Start **nmtui**:

```
# nmtui
```

3. Select **Edit a connection**, and press **Enter**.
4. Press the **Add** button.
5. Select **Bridge** from the list of network types, and press **Enter**.
6. Optional: Enter a name for the NetworkManager profile to be created.
On hosts with multiple profiles, a meaningful name makes it easier to identify the purpose of a profile.
7. Enter the bridge device name to be created into the **Device** field.
8. Add ports to the bridge to be created:
 - a. Press the **Add** button next to the **Slaves** list.
 - b. Select the type of the interface you want to add as port to the bridge, for example, **Ethernet**.
 - c. Optional: Enter a name for the NetworkManager profile to be created for this bridge port.
 - d. Enter the port's device name into the **Device** field.
 - e. Press the **OK** button to return to the window with the bridge settings.

Figure 6.1. Adding an Ethernet device as port to a bridge

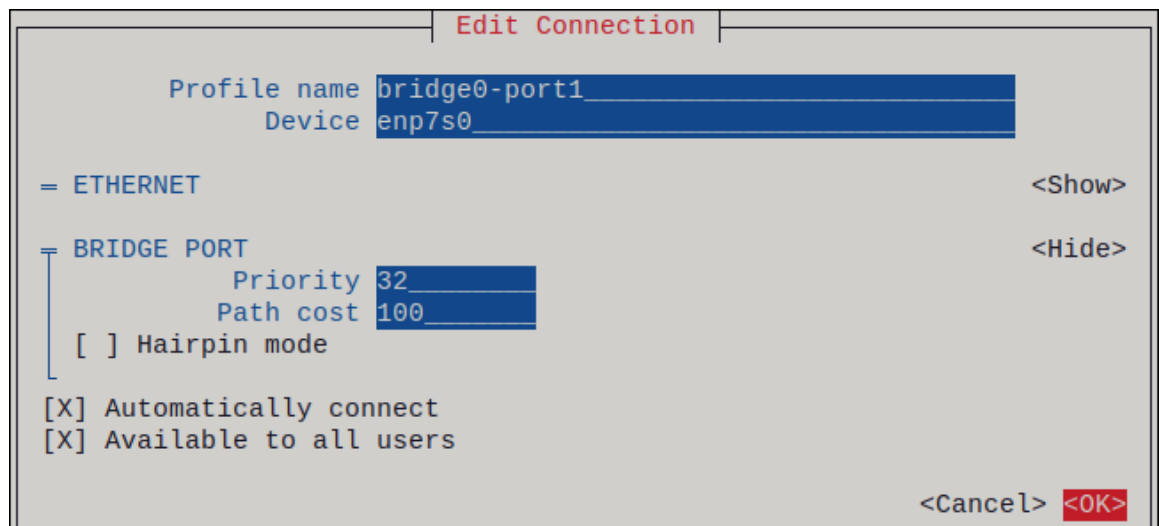

- f. Repeat these steps to add more ports to the bridge.
9. Depending on your environment, configure the IP address settings in the **IPv4 configuration** and **IPv6 configuration** areas accordingly. For this, press the button next to these areas, and select:
 - **Disabled**, if the bridge does not require an IP address.
 - **Automatic**, if a DHCP server or stateless address autoconfiguration (SLAAC) dynamically assigns an IP address to the bridge.
 - **Manual**, if the network requires static IP address settings. In this case, you must fill further fields:
 - i. Press the **Show** button next to the protocol you want to configure to display additional fields.
 - ii. Press the **Add** button next to **Addresses**, and enter the IP address and the subnet mask in Classless Inter-Domain Routing (CIDR) format.
If you do not specify a subnet mask, NetworkManager sets a **/32** subnet mask for IPv4 addresses and **/64** for IPv6 addresses.
 - iii. Enter the address of the default gateway.
 - iv. Press the **Add** button next to **DNS servers**, and enter the DNS server address.
 - v. Press the **Add** button next to **Search domains**, and enter the DNS search domain.

Figure 6.2. Example of a bridge connection without IP address settings

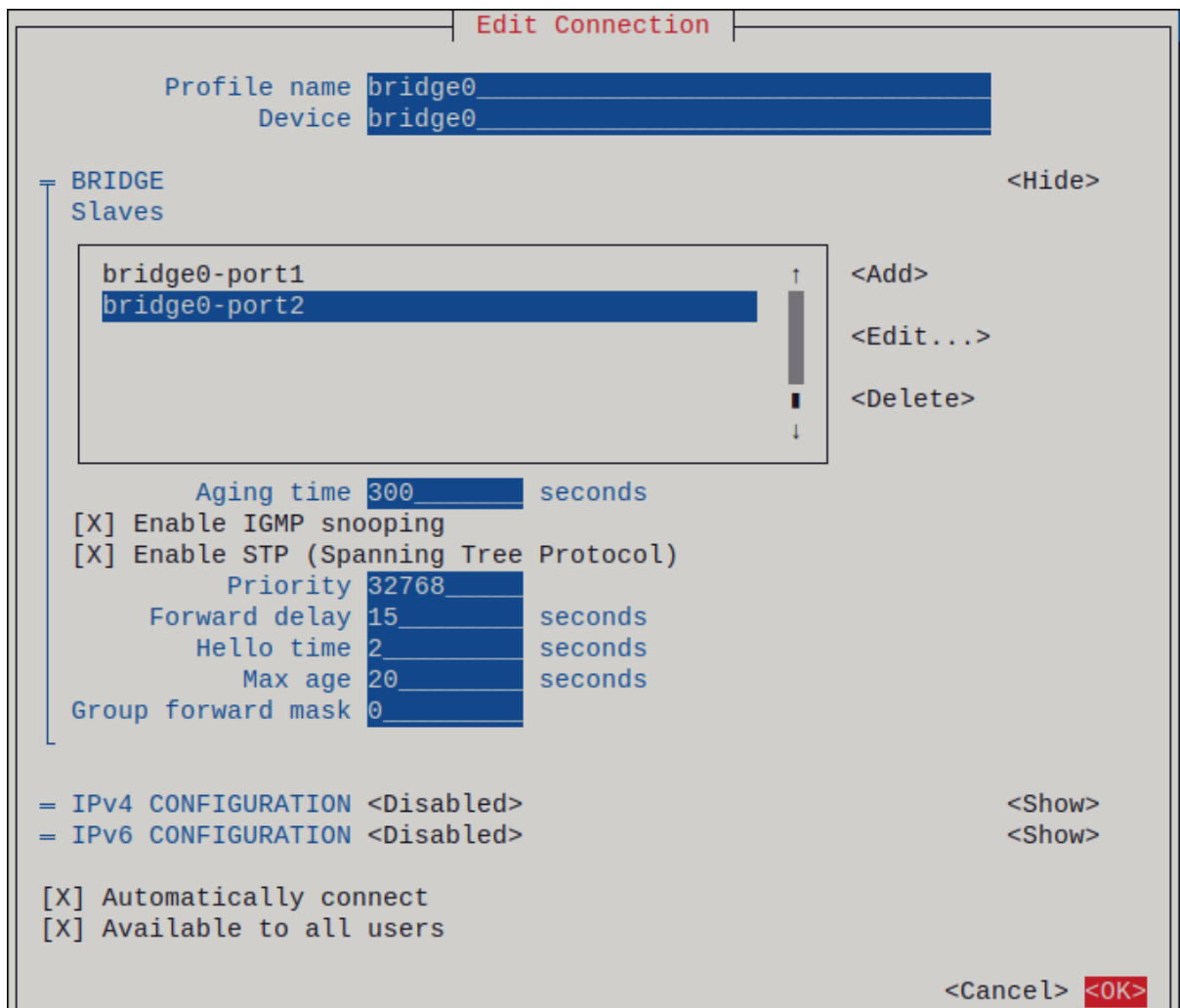

10. Press the **OK** button to create and automatically activate the new connection.
11. Press the **Back** button to return to the main menu.
12. Select **Quit**, and press **Enter** to close the **nmtui** application.

Verification

1. Use the **ip** utility to display the link status of Ethernet devices that are ports of a specific bridge:

```
# ip link show master bridge0
```

```
3: enp7s0: <BROADCAST,MULTICAST,UP,LOWER_UP> mtu 1500 qdisc fq_codel master
bridge0 state UP mode DEFAULT group default qlen 1000
    link/ether 52:54:00:62:61:0e brd ff:ff:ff:ff:ff:ff
4: enp8s0: <BROADCAST,MULTICAST,UP,LOWER_UP> mtu 1500 qdisc fq_codel master
bridge0 state UP mode DEFAULT group default qlen 1000
    link/ether 52:54:00:9e:f1:ce brd ff:ff:ff:ff:ff:ff
```

2. Use the **bridge** utility to display the status of Ethernet devices that are ports of any bridge device:

```
# bridge link show
```

```
3: enp7s0: <BROADCAST,MULTICAST,UP,LOWER_UP> mtu 1500 master bridge0 state
forwarding priority 32 cost 100
```

```
4: enp8s0: <BROADCAST,MULTICAST,UP,LOWER_UP> mtu 1500 master bridge0 state
listening priority 32 cost 100
...
```

To display the status for a specific Ethernet device, use the **bridge link show dev *ethernet_device_name*** command.

6.4. CONFIGURING A NETWORK BRIDGE BY USING NM-CONNECTION-EDITOR

If you use Red Hat Enterprise Linux with a graphical interface, you can configure network bridges using the **nm-connection-editor** application.

Note that **nm-connection-editor** can add only new ports to a bridge. To use an existing connection profile as a port, create the bridge using the **nmcli** utility as described in [Configuring a network bridge by using nmcli](#).

Prerequisites

- Two or more physical or virtual network devices are installed on the server.
- To use Ethernet devices as ports of the bridge, the physical or virtual Ethernet devices must be installed on the server.
- To use team, bond, or VLAN devices as ports of the bridge, ensure that these devices are not already configured.

Procedure

1. Open a terminal, and enter **nm-connection-editor**:

```
$ nm-connection-editor
```

2. Click the **+** button to add a new connection.
3. Select the **Bridge** connection type, and click **Create**.
4. On the **Bridge** tab:
 - a. Optional: Set the name of the bridge interface in the **Interface name** field.
 - b. Click the **Add** button to create a new connection profile for a network interface and adding the profile as a port to the bridge.
 - i. Select the connection type of the interface. For example, select **Ethernet** for a wired connection.
 - ii. Optionally, set a connection name for the port device.
 - iii. If you create a connection profile for an Ethernet device, open the **Ethernet** tab, and select in the **Device** field the network interface you want to add as a port to the bridge. If you selected a different device type, configure it accordingly.
 - iv. Click **Save**.

- c. Repeat the previous step for each interface you want to add to the bridge.

Editing Bridge connection 1

Connection name: Bridge connection 1

General **Bridge** Proxy IPv4 Settings IPv6 Settings

Interface name: bridge0

Bridged connections

bridge0-port1	Add
bridge0-port2	

Edit

5. Optional: Configure further bridge settings, such as Spanning Tree Protocol (STP) options.
6. Configure the IP address settings on both the **IPv4 Settings** and **IPv6 Settings** tabs:
- To use this bridge device as a port of other devices, set the **Method** field to **Disabled**.
 - To use DHCP, leave the **Method** field at its default, **Automatic (DHCP)**.
 - To use static IP settings, set the **Method** field to **Manual** and fill the fields accordingly:

Editing Bridge connection 1 (IPv4 Settings)

Connection name: Bridge connection 1

General Bridge Proxy **IPv4 Settings** IPv6 Settings

Method: Manual

Address	Netmask	Gateway
192.0.2.1	24	192.0.2.254

DNS servers: 192.0.2.1
Search domains: example.com

Editing Bridge connection 1 (IPv6 Settings)

Connection name: Bridge connection 1

General Bridge Proxy IPv4 Settings **IPv6 Settings**

Method: Manual

Address	Prefix	Gateway
2001:db8:1::1	64	2001:db8:1::fff3

DNS servers: 2001:db8:1::ffff
Search domains: example.com

7. Click **Save**.
8. Close **nm-connection-editor**.

Verification

- Use the **ip** utility to display the link status of Ethernet devices that are ports of a specific bridge.

```
# ip link show master bridge0
```

```
3: enp7s0: <BROADCAST,MULTICAST,UP,LOWER_UP> mtu 1500 qdisc fq_codel master bridge0 state UP mode DEFAULT group default qlen 1000
```

```
link/ether 52:54:00:62:61:0e brd ff:ff:ff:ff:ff:ff
```

```
4: enp8s0: <BROADCAST,MULTICAST,UP,LOWER_UP> mtu 1500 qdisc fq_codel master bridge0 state UP mode DEFAULT group default qlen 1000
```

```
link/ether 52:54:00:9e:f1:ce brd ff:ff:ff:ff:ff:ff
```

- Use the **bridge** utility to display the status of Ethernet devices that are ports in any bridge device:

```
# bridge link show
```

```
3: enp7s0: <BROADCAST,MULTICAST,UP,LOWER_UP> mtu 1500 master bridge0 state
forwarding priority 32 cost 100
4: enp8s0: <BROADCAST,MULTICAST,UP,LOWER_UP> mtu 1500 master bridge0 state
listening priority 32 cost 100
5: enp9s0: <BROADCAST,MULTICAST,UP,LOWER_UP> mtu 1500 master bridge1 state
forwarding priority 32 cost 100
6: enp11s0: <BROADCAST,MULTICAST,UP,LOWER_UP> mtu 1500 master bridge1 state
blocking priority 32 cost 100
...
```

To display the status for a specific Ethernet device, use the **bridge link show dev *ethernet_device_name*** command.

Additional resources

- [Configuring a network bond by using nm-connection-editor](#)
- [Configuring a network team by using nm-connection-editor](#)
- [Configuring VLAN tagging by using nm-connection-editor](#)
- [Configuring NetworkManager to avoid using a specific profile to provide a default gateway](#)
- [How to configure a bridge with VLAN information?](#)

6.5. CONFIGURING A NETWORK BRIDGE BY USING NMSTATECTL

Use the **nmstatectl** utility to configure a network bridge through the Nmstate API. The Nmstate API ensures that, after setting the configuration, the result matches the configuration file. If anything fails, **nmstatectl** automatically rolls back the changes to avoid leaving the system in an incorrect state.

Depending on your environment, adjust the YAML file accordingly. For example, to use different devices than Ethernet adapters in the bridge, adapt the **base-iface** attribute and **type** attributes of the ports you use in the bridge.

Prerequisites

- Two or more physical or virtual network devices are installed on the server.
- To use Ethernet devices as ports in the bridge, the physical or virtual Ethernet devices must be installed on the server.
- To use team, bond, or VLAN devices as ports in the bridge, set the interface name in the **port** list, and define the corresponding interfaces.
- The **nmstate** package is installed.

Procedure

1. Create a YAML file, for example **~/create-bridge.yml**, with the following content:

```
---
interfaces:
- name: bridge0
  type: linux-bridge
  state: up
  ipv4:
    enabled: true
    address:
    - ip: 192.0.2.1
      prefix-length: 24
    dhcp: false
  ipv6:
    enabled: true
    address:
    - ip: 2001:db8:1::1
      prefix-length: 64
    autoconf: false
    dhcp: false
  bridge:
    options:
    stp:
      enabled: true
    port:
    - name: enp1s0
    - name: enp7s0
- name: enp1s0
  type: ethernet
  state: up
- name: enp7s0
  type: ethernet
  state: up

routes:
  config:
  - destination: 0.0.0.0/0
    next-hop-address: 192.0.2.254
    next-hop-interface: bridge0
  - destination: ::/0
    next-hop-address: 2001:db8:1::fffe
    next-hop-interface: bridge0

dns-resolver:
  config:
  search:
  - example.com
  server:
  - 192.0.2.200
  - 2001:db8:1::ffbb
```

These settings define a network bridge with the following settings:

- Network interfaces in the bridge: **enp1s0** and **enp7s0**
- Spanning Tree Protocol (STP): Enabled
- Static IPv4 address: **192.0.2.1** with the **/24** subnet mask

- Static IPv6 address: **2001:db8:1::1** with the **/64** subnet mask
 - IPv4 default gateway: **192.0.2.254**
 - IPv6 default gateway: **2001:db8:1::ffe**
 - IPv4 DNS server: **192.0.2.200**
 - IPv6 DNS server: **2001:db8:1::ffbb**
 - DNS search domain: **example.com**
2. Apply the settings to the system:

```
# nmstatectl apply ~/create-bridge.yml
```

Verification

1. Display the status of the devices and connections:

```
# nmcli device status
DEVICE  TYPE  STATE  CONNECTION
bridge0 bridge connected bridge0
```

2. Display all settings of the connection profile:

```
# nmcli connection show bridge0
connection.id:      bridge0
connection.uuid:    e2cc9206-75a2-4622-89cf-1252926060a9
connection.stable-id:  --
connection.type:    bridge
connection.interface-name: bridge0
...
```

3. Display the connection settings in YAML format:

```
# nmstatectl show bridge0
```

Additional resources

- **nmstatectl(8)** man page
- **/usr/share/doc/nmstate/examples/** directory
- [How to configure a bridge with VLAN information?](#)

6.6. CONFIGURING A NETWORK BRIDGE BY USING THE NETWORK RHEL SYSTEM ROLE

You can remotely configure a network bridge by using the **network** RHEL system role.

Prerequisites

- You have prepared the control node and the managed nodes
- You are logged in to the control node as a user who can run playbooks on the managed nodes.
- The account you use to connect to the managed nodes has **sudo** permissions on them.
- Two or more physical or virtual network devices are installed on the server.

Procedure

1. Create a playbook file, for example `~/playbook.yml`, with the following content:

```
---
- name: Configure the network
  hosts: managed-node-01.example.com
  tasks:
    - name: Configure a network bridge that uses two Ethernet ports
      ansible.builtin.include_role:
        name: rhel-system-roles.network
      vars:
        network_connections:
          # Define the bridge profile
          - name: bridge0
            type: bridge
            interface_name: bridge0
            ip:
              address:
                - "192.0.2.1/24"
                - "2001:db8:1::1/64"
              gateway4: 192.0.2.254
              gateway6: 2001:db8:1::fffe
            dns:
              - 192.0.2.200
              - 2001:db8:1::ffbb
            dns_search:
              - example.com
            state: up

          # Add an Ethernet profile to the bridge
          - name: bridge0-port1
            interface_name: enp7s0
            type: ethernet
            controller: bridge0
            port_type: bridge
            state: up

          # Add a second Ethernet profile to the bridge
          - name: bridge0-port2
            interface_name: enp8s0
            type: ethernet
            controller: bridge0
            port_type: bridge
            state: up
```

These settings define a network bridge with the following settings:

- A static IPv4 address - **192.0.2.1** with a **/24** subnet mask
- A static IPv6 address - **2001:db8:1::1** with a **/64** subnet mask
- An IPv4 default gateway - **192.0.2.254**
- An IPv6 default gateway - **2001:db8:1::ffe**
- An IPv4 DNS server - **192.0.2.200**
- An IPv6 DNS server - **2001:db8:1::ffbb**
- A DNS search domain - **example.com**
- Ports of the bridge - **enp7s0** and **enp8s0**

**NOTE**

Set the IP configuration on the bridge and not on the ports of the Linux bridge.

2. Validate the playbook syntax:

```
$ ansible-playbook --syntax-check ~/playbook.yml
```

Note that this command only validates the syntax and does not protect against a wrong but valid configuration.

3. Run the playbook:

```
$ ansible-playbook ~/playbook.yml
```

Additional resources

- **/usr/share/ansible/roles/rhel-system-roles.network/README.md** file
- **/usr/share/doc/rhel-system-roles/network/** directory

CHAPTER 7. SETTING UP AN IPSEC VPN

A virtual private network (VPN) is a way of connecting to a local network over the internet. **IPsec** provided by **Libreswan** is the preferred method for creating a VPN. **Libreswan** is a user-space **IPsec** implementation for VPN. A VPN enables the communication between your LAN, and another, remote LAN by setting up a tunnel across an intermediate network such as the internet. For security reasons, a VPN tunnel always uses authentication and encryption. For cryptographic operations, **Libreswan** uses the **NSS** library.

7.1. CONFIGURING A VPN CONNECTION WITH CONTROL-CENTER

If you use Red Hat Enterprise Linux with a graphical interface, you can configure a VPN connection in the GNOME **control-center**.

Prerequisites

- The **NetworkManager-libreswan-gnome** package is installed.

Procedure

1. Press the **Super** key, type **Settings**, and press **Enter** to open the **control-center** application.
2. Select the **Network** entry on the left.
3. Click the **+** icon.
4. Select **VPN**.
5. Select the **Identity** menu entry to see the basic configuration options:

General

Gateway – The name or **IP** address of the remote VPN gateway.

Authentication

Type

- **IKEv2 (Certificate)**- client is authenticated by certificate. It is more secure (default).
- **IKEv1 (XAUTH)** - client is authenticated by user name and password, or a pre-shared key (PSK).

The following configuration settings are available under the **Advanced** section:

Figure 7.1. Advanced options of a VPN connection

IPsec Advanced Options ✕

Identification

Domain:

Security

Phase1 Algorithms:

Phase2 Algorithms:

Disable PFS

Phase1 Lifetime:

Phase2 Lifetime:

Disable rekeying

Connectivity

Remote Network:

narrowing

Enable fragmentation ▼

Enable MOBIKE ▼



WARNING

When configuring an IPsec-based VPN connection using the **gnome-control-center** application, the **Advanced** dialog displays the configuration, but it does not allow any changes. As a consequence, users cannot change any advanced IPsec options. Use the **nm-connection-editor** or **nmcli** tools instead to perform configuration of the advanced properties.

Identification

- **Domain** – If required, enter the Domain Name.

Security

- **Phase1 Algorithms** – corresponds to the **ike** Libreswan parameter – enter the algorithms to be used to authenticate and set up an encrypted channel.
- **Phase2 Algorithms** – corresponds to the **esp** Libreswan parameter – enter the algorithms to be used for the **IPsec** negotiations.
Check the **Disable PFS** field to turn off Perfect Forward Secrecy (PFS) to ensure compatibility with old servers that do not support PFS.
- **Phase1 Lifetime** – corresponds to the **ikelifetime** Libreswan parameter – how long the key used to encrypt the traffic will be valid.
- **Phase2 Lifetime** – corresponds to the **salifetime** Libreswan parameter – how long a particular instance of a connection should last before expiring.
Note that the encryption key should be changed from time to time for security reasons.
- **Remote network** – corresponds to the **rightsubnet** Libreswan parameter – the destination private remote network that should be reached through the VPN.
Check the **narrowing** field to enable narrowing. Note that it is only effective in IKEv2 negotiation.
- **Enable fragmentation** – corresponds to the **fragmentation** Libreswan parameter – whether or not to allow IKE fragmentation. Valid values are **yes** (default) or **no**.
- **Enable Mobike** – corresponds to the **mobike** Libreswan parameter – whether to allow Mobility and Multihoming Protocol (MOBIKE, RFC 4555) to enable a connection to migrate its endpoint without needing to restart the connection from scratch. This is used on mobile devices that switch between wired, wireless, or mobile data connections. The values are **no** (default) or **yes**.

6. Select the **IPv4** menu entry:

IPv4 Method

- **Automatic (DHCP)** – Choose this option if the network you are connecting to uses a **DHCP** server to assign dynamic **IP** addresses.
- **Link-Local Only** – Choose this option if the network you are connecting to does not have a **DHCP** server and you do not want to assign **IP** addresses manually. Random addresses will be assigned as per [RFC 3927](#) with prefix **169.254/16**.

- **Manual** – Choose this option if you want to assign **IP** addresses manually.
- **Disable** – **IPv4** is disabled for this connection.
DNS

In the **DNS** section, when **Automatic** is **ON**, switch it to **OFF** to enter the IP address of a DNS server you want to use separating the IPs by comma.

Routes

Note that in the **Routes** section, when **Automatic** is **ON**, routes from DHCP are used, but you can also add additional static routes. When **OFF**, only static routes are used.

- **Address** – Enter the **IP** address of a remote network or host.
- **Netmask** – The netmask or prefix length of the **IP** address entered above.
- **Gateway** – The **IP** address of the gateway leading to the remote network or host entered above.
- **Metric** – A network cost, a preference value to give to this route. Lower values will be preferred over higher values.

Use this connection only for resources on its network

Select this check box to prevent the connection from becoming the default route. Selecting this option means that only traffic specifically destined for routes learned automatically over the connection or entered here manually is routed over the connection.

7. To configure **IPv6** settings in a **VPN** connection, select the **IPv6** menu entry:

IPv6 Method

- **Automatic** – Choose this option to use **IPv6** Stateless Address AutoConfiguration (SLAAC) to create an automatic, stateless configuration based on the hardware address and Router Advertisements (RA).
- **Automatic, DHCP only** – Choose this option to not use RA, but request information from **DHCPv6** directly to create a stateful configuration.
- **Link-Local Only** – Choose this option if the network you are connecting to does not have a **DHCP** server and you do not want to assign **IP** addresses manually. Random addresses will be assigned as per [RFC 4862](#) with prefix **FE80::0**.
- **Manual** – Choose this option if you want to assign **IP** addresses manually.
- **Disable** – **IPv6** is disabled for this connection.

Note that **DNS**, **Routes**, **Use this connection only for resources on its network** are common to **IPv4** settings.

8. Once you have finished editing the **VPN** connection, click the **Add** button to customize the configuration or the **Apply** button to save it for the existing one.
9. Switch the profile to **ON** to active the **VPN** connection.

Additional resources

- **nm-settings-libreswan(5)**

7.2. CONFIGURING A VPN CONNECTION USING NM-CONNECTION-EDITOR

If you use Red Hat Enterprise Linux with a graphical interface, you can configure a VPN connection in the **nm-connection-editor** application.

Prerequisites

- The **NetworkManager-libreswan-gnome** package is installed.
- If you configure an Internet Key Exchange version 2 (IKEv2) connection:
 - The certificate is imported into the IPsec network security services (NSS) database.
 - The nickname of the certificate in the NSS database is known.

Procedure

1. Open a terminal, and enter:

```
$ nm-connection-editor
```

2. Click the **+** button to add a new connection.
3. Select the **IPsec based VPN** connection type, and click **Create**.
4. On the **VPN** tab:
 - a. Enter the host name or IP address of the VPN gateway into the **Gateway** field, and select an authentication type. Based on the authentication type, you must enter different additional information:
 - **IKEv2 (Certificate)** authenticates the client by using a certificate, which is more secure. This setting requires the nickname of the certificate in the IPsec NSS database
 - **IKEv1 (XAUTH)** authenticates the user by using a user name and password (pre-shared key). This setting requires that you enter the following values:
 - User name
 - Password
 - Group name
 - Secret
 - b. If the remote server specifies a local identifier for the IKE exchange, enter the exact string in the **Remote ID** field. In the remote server runs Libreswan, this value is set in the server's **leftid** parameter.

The screenshot shows a window titled "Editing VPN connection 1" with a close button (X) in the top right corner. Below the title bar, there is a text field for "Connection name:" containing "VPN connection 1". A tabbed interface below has four tabs: "General", "VPN" (which is selected and underlined), "Proxy", and "IPv4 Settings". Under the "VPN" tab, there are several settings:

- General**
 - Gateway: vpn.example.com
- Authentication**
 - Type: IKEv2 (Certificate) (dropdown menu)
 - Certificate name: cert_name_in_IPSec_DB
 - Remote ID: (empty text field)

At the bottom right of the dialog, there is a button labeled "Advanced..." with a gear icon.

- c. Optionally, configure additional settings by clicking the **Advanced** button. You can configure the following settings:
- Identification
 - **Domain** – If required, enter the domain name.
 - Security
 - **Phase1 Algorithms** corresponds to the **ike** Libreswan parameter. Enter the algorithms to be used to authenticate and set up an encrypted channel.
 - **Phase2 Algorithms** corresponds to the **esp** Libreswan parameter. Enter the algorithms to be used for the **IPsec** negotiations. Check the **Disable PFS** field to turn off Perfect Forward Secrecy (PFS) to ensure compatibility with old servers that do not support PFS.
 - **Phase1 Lifetime** corresponds to the **ikelifetime** Libreswan parameter. This parameter defines how long the key used to encrypt the traffic is valid.
 - **Phase2 Lifetime** corresponds to the **salifetime** Libreswan parameter. This parameter defines how long a security association is valid.
 - Connectivity

- **Remote network** corresponds to the **rightsubnet** Libreswan parameter and defines the destination private remote network that should be reached through the VPN.
Check the **narrowing** field to enable narrowing. Note that it is only effective in the IKEv2 negotiation.
 - **Enable fragmentation** corresponds to the **fragmentation** Libreswan parameter and defines whether or not to allow IKE fragmentation. Valid values are **yes** (default) or **no**.
 - **Enable Mobike** corresponds to the **mobike** Libreswan parameter. The parameter defines whether to allow Mobility and Multihoming Protocol (MOBIKE) (RFC 4555) to enable a connection to migrate its endpoint without needing to restart the connection from scratch. This is used on mobile devices that switch between wired, wireless or mobile data connections. The values are **no** (default) or **yes**.
5. On the **IPv4 Settings** tab, select the IP assignment method and, optionally, set additional static addresses, DNS servers, search domains, and routes.

The screenshot shows a window titled "Editing VPN connection 1" with a close button (X) in the top right corner. The "Connection name:" field contains "VPN connection 1". Below this are four tabs: "General", "VPN", "Proxy", and "IPv4 Settings", with "IPv4 Settings" being the active tab. Under "Method:", a dropdown menu shows "Automatic (VPN)". Below that is a section titled "Additional static addresses" containing a table with three columns: "Address", "Netmask", and "Gateway". To the right of the table are "Add" and "Delete" buttons. Below the table are two input fields: "Additional DNS servers:" and "Additional search domains:". At the bottom right is a "Routes..." button.

6. Save the connection.
7. Close **nm-connection-editor**.



NOTE

When you add a new connection by clicking the **+** button, **NetworkManager** creates a new configuration file for that connection and then opens the same dialog that is used for editing an existing connection. The difference between these dialogs is that an existing connection profile has a **Details** menu entry.

Additional resources

- **nm-settings-libreswan(5)** man page

7.3. CONFIGURING AUTOMATIC DETECTION AND USAGE OF ESP HARDWARE OFFLOAD TO ACCELERATE AN IPSEC CONNECTION

Offloading Encapsulating Security Payload (ESP) to the hardware accelerates IPsec connections over Ethernet. By default, Libreswan detects if hardware supports this feature and, as a result, enables ESP hardware offload. In case that the feature was disabled or explicitly enabled, you can switch back to automatic detection.

Prerequisites

- The network card supports ESP hardware offload.
- The network driver supports ESP hardware offload.
- The IPsec connection is configured and works.

Procedure

1. Edit the Libreswan configuration file in the `/etc/ipsec.d/` directory of the connection that should use automatic detection of ESP hardware offload support.
2. Ensure the `nic-offload` parameter is not set in the connection's settings.
3. If you removed `nic-offload`, restart the `ipsec` service:

```
# systemctl restart ipsec
```

Verification

If the network card supports ESP hardware offload support, following these steps to verify the result:

1. Display the `tx_ipsec` and `rx_ipsec` counters of the Ethernet device the IPsec connection uses:

```
# ethtool -S enp1s0 | egrep "_ipsec"
tx_ipsec: 10
rx_ipsec: 10
```

2. Send traffic through the IPsec tunnel. For example, ping a remote IP address:

```
# ping -c 5 remote_ip_address
```

3. Display the `tx_ipsec` and `rx_ipsec` counters of the Ethernet device again:

```
# ethtool -S enp1s0 | egrep "_ipsec"
tx_ipsec: 15
rx_ipsec: 15
```

If the counter values have increased, ESP hardware offload works.

Additional resources

- [Configuring a VPN with IPsec](#)

7.4. CONFIGURING ESP HARDWARE OFFLOAD ON A BOND TO ACCELERATE AN IPSEC CONNECTION

Offloading Encapsulating Security Payload (ESP) to the hardware accelerates IPsec connections. If you use a network bond for fail-over reasons, the requirements and the procedure to configure ESP hardware offload are different from those using a regular Ethernet device. For example, in this scenario, you enable the offload support on the bond, and the kernel applies the settings to the ports of the bond.

Prerequisites

- All network cards in the bond support ESP hardware offload.
- The network driver supports ESP hardware offload on a bond device. In RHEL, only the **ixgbe** driver supports this feature.
- The bond is configured and works.
- The bond uses the **active-backup** mode. The bonding driver does not support any other modes for this feature.
- The IPsec connection is configured and works.

Procedure

1. Enable ESP hardware offload support on the network bond:

```
# nmcli connection modify bond0 ethtool.feature-esp-hw-offload on
```

This command enables ESP hardware offload support on the **bond0** connection.

2. Reactivate the **bond0** connection:

```
# nmcli connection up bond0
```

3. Edit the Libreswan configuration file in the **/etc/ipsec.d/** directory of the connection that should use ESP hardware offload, and append the **nic-offload=yes** statement to the connection entry:

```
conn example
...
nic-offload=yes
```

4. Restart the **ipsec** service:

```
# systemctl restart ipsec
```

Verification

1. Display the active port of the bond:

```
# grep "Currently Active Slave" /proc/net/bonding/bond0
Currently Active Slave: enp1s0
```

2. Display the **tx_ipsec** and **rx_ipsec** counters of the active port:

-

```
# ethtool -S enp1s0 | egrep "_ipsec"  
tx_ipsec: 10  
rx_ipsec: 10
```

3. Send traffic through the IPsec tunnel. For example, ping a remote IP address:

```
# ping -c 5 remote_ip_address
```

4. Display the **tx_ipsec** and **rx_ipsec** counters of the active port again:

```
# ethtool -S enp1s0 | egrep "_ipsec"  
tx_ipsec: 15  
rx_ipsec: 15
```

If the counter values have increased, ESP hardware offload works.

Additional resources

- [Configuring network bonding](#)
- [Configuring a VPN with IPsec](#) section in the Securing networks document

CHAPTER 8. SETTING UP A WIREGUARD VPN

WireGuard is a high-performance VPN solution that runs in the Linux kernel. It uses modern cryptography and is easier to configure than many other VPN solutions. Additionally, WireGuard's small codebase reduces the surface for attacks and, therefore, improves security. For authentication and encryption, WireGuard uses keys similar to SSH.

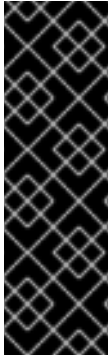

IMPORTANT

WireGuard is provided as a Technology Preview only. Technology Preview features are not supported with Red Hat production Service Level Agreements (SLAs), might not be functionally complete, and Red Hat does not recommend using them for production. These previews provide early access to upcoming product features, enabling customers to test functionality and provide feedback during the development process.

See [Technology Preview Features Support Scope](#) on the Red Hat Customer Portal for information about the support scope for Technology Preview features.

Note that all hosts that participate in a WireGuard VPN are peers. This documentation uses the terms **client** to describe hosts that establish a connection and **server** to describe the host with the fixed hostname or IP address that the clients connect to and optionally route all traffic through this server.

To set up a WireGuard VPN, you must complete the following steps. You can perform most steps by using different options:

1. [Create public and private keys for every host in the VPN](#) .
2. Configure the WireGuard server by using [nmcli](#), [nmtui](#), [nm-connection-editor](#), or the [wg-quick](#) service.
3. Configure firewalld on the WireGuard server by using the [command line](#) or [graphical interface](#).
4. Configure the WireGuard client by using [nmcli](#), [nm-connection-editor](#), or the [wg-quick](#) service.

WireGuard operates on the network layer (layer 3). Therefore, you cannot use DHCP and must assign static IP addresses or IPv6 link-local addresses to the tunnel devices on both the server and clients.



IMPORTANT

You can use WireGuard only if the Federal Information Processing Standard (FIPS) mode in RHEL is disabled.

8.1. PROTOCOLS AND PRIMITIVES USED BY WIREGUARD

WireGuard uses the following protocols and primitives:

- ChaCha20 for symmetric encryption, authenticated with Poly1305, using Authenticated Encryption with Associated Data (AEAD) construction as described in [RFC7539](#)
- Curve25519 for Elliptic-curve Diffie-Hellman (ECDH) key exchange
- BLAKE2s for hashing and keyed hashing, as described in [RFC7693](#)
- SipHash24 for hash table keys

- HKDF for key derivation, as described in [RFC5869](#)

8.2. HOW WIREGUARD USES TUNNEL IP ADDRESSES, PUBLIC KEYS, AND REMOTE ENDPOINTS

When WireGuard sends a network packet to a peer:

1. WireGuard reads the destination IP from the packet and compares it to the list of allowed IP addresses in the local configuration. If the peer is not found, WireGuard drops the packet.
2. If the peer is valid, WireGuard encrypts the packet using the peer's public key.
3. The sending host looks up the most recent Internet IP address of the host and sends the encrypted packet to it.

When WireGuard receives a packet:

1. WireGuard decrypts the packet using the private key of the remote host.
2. WireGuard reads the internal source address from the packet and looks up whether the IP is configured in the list of allowed IP addresses in the settings for the peer on the local host. If the source IP is on the allowlist, WireGuard accepts the packet. If the IP address is not on the list, WireGuard drops the packet.

The association of public keys and allowed IP addresses is called **Cryptokey Routing Table**. This means that the list of IP addresses behaves similar to a routing table when sending packets, and as a kind of access control list when receiving packets.

8.3. USING A WIREGUARD CLIENT BEHIND NAT AND FIREWALLS

WireGuard uses the UDP protocol and transmits data only when a peer sends packets. Stateful firewalls and network address translation (NAT) on routers track connections to enable a peer behind NAT or a firewall to receive packets.

To keep the connection active, WireGuard supports **persistent keepalives**. This means you can set an interval at which WireGuard sends keepalive packets. By default, the persistent keep-alive feature is disabled to reduce network traffic. Enable this feature on the client if you use the client in a network with NAT or if a firewall closes the connection after some time of inactivity.

8.4. CREATING PRIVATE AND PUBLIC KEYS TO BE USED IN WIREGUARD CONNECTIONS

WireGuard uses base64-encoded private and public keys to authenticate hosts to each other. Therefore, you must create the keys on each host that participates in the WireGuard VPN.



IMPORTANT

For secure connections, create different keys for each host, and ensure that you only share the public key with the remote WireGuard host. Do not use the example keys used in this documentation.

Procedure

1. Install the **wireguard-tools** package:

```
# dnf install wireguard-tools
```

2. Create a private key and a corresponding public key for the host:

```
# wg genkey | tee /etc/wireguard/$HOSTNAME.private.key | wg pubkey >
/etc/wireguard/$HOSTNAME.public.key
```

You will need the content of the key files, but not the files themselves. However, Red Hat recommends keeping the files in case that you need to remember the keys in future.

3. Set secure permissions on the key files:

```
# chmod 600 /etc/wireguard/$HOSTNAME.private.key
/etc/wireguard/$HOSTNAME.public.key
```

4. Display the private key:

```
# cat /etc/wireguard/$HOSTNAME.private.key
YFAnE0psgldiAF7XR4abxiwVRnlMfeltxu10s/c4JXg=
```

You will need the private key to configure the WireGuard connection on the local host. Do not share the private key.

5. Display the public key:

```
# cat /etc/wireguard/$HOSTNAME.public.key
UtjqCJ57DeAscYKRfp7cFGiQqdONRn69u249Fa4O6BE=
```

You will need the public key to configure the WireGuard connection on the remote host.

Additional resources

- The **wg(8)** man page

8.5. CONFIGURING A WIREGUARD SERVER BY USING NMCLI

You can configure the WireGuard server by creating a connection profile in NetworkManager. Use this method to let NetworkManager manage the WireGuard connection.

This procedure assumes the following settings:

- Server:
 - Private key: **YFAnE0psgldiAF7XR4abxiwVRnlMfeltxu10s/c4JXg=**
 - Tunnel IPv4 address: **192.0.2.1/24**
 - Tunnel IPv6 address: **2001:db8:1::1/32**
- Client:
 - Public key: **bnwfQcC8/g2i4vvEqcRUM2e6Hi3Nskk6G9t4r26nFVM=**
 - Tunnel IPv4 address: **192.0.2.2/24**

- Tunnel IPv6 address: **2001:db8:1::2/32**

Prerequisites

- You have generated the public and private key for both the server and client.
- You know the following information:
 - The private key of the server
 - The static tunnel IP addresses and subnet masks of the client
 - The public key of the client
 - The static tunnel IP addresses and subnet masks of the server

Procedure

1. Add a NetworkManager WireGuard connection profile:

```
# nmcli connection add type wireguard con-name server-wg0 ifname wg0 autoconnect no
```

This command creates a profile named **server-wg0** and assigns the virtual interface **wg0** to it. To prevent the connection from starting automatically after you add it without finalizing the configuration, disable the **autoconnect** parameter.

2. Set the tunnel IPv4 address and subnet mask of the server:

```
# nmcli connection modify server-wg0 ipv4.method manual ipv4.addresses 192.0.2.1/24
```

3. Set the tunnel IPv6 address and subnet mask of the server:

```
# nmcli connection modify server-wg0 ipv6.method manual ipv6.addresses 2001:db8:1::1/32
```

4. Add the server's private key to the connection profile:

```
# nmcli connection modify server-wg0 wireguard.private-key "YFAnE0psgldiAF7XR4abxiwVRnlMfeltxu10s/c4JXg="
```

5. Set the port for incoming WireGuard connections:

```
# nmcli connection modify server-wg0 wireguard.listen-port 51820
```

Always set a fixed port number on hosts that receive incoming WireGuard connections. If you do not set a port, WireGuard uses a random free port each time you activate the **wg0** interface.

6. Add peer configurations for each client that you want to allow to communicate with this server. You must add these settings manually, because the **nmcli** utility does not support setting the corresponding connection properties.
 - a. Edit the **/etc/NetworkManager/system-connections/server-wg0.nmconnection** file, and append:

```
[wireguard-peer.bnwfQcC8/g2i4vvEqcRUM2e6Hi3Nskk6G9t4r26nFVM=]
allowed-ips=192.0.2.2;2001:db8:1::2;
```

- The `[wireguard-peer.<public_key_of_the_client>]` entry defines the peer section of the client, and the section name contains the public key of the client.
- The `allowed-ips` parameter sets the tunnel IP addresses of the client that are allowed to send data to this server.
Add a section for each client.

- Reload the `server-wg0` connection profile:

```
# nmcli connection load /etc/NetworkManager/system-connections/server-
wg0.nmconnection
```

- Optional: Configure the connection to start automatically, enter:

```
# nmcli connection modify server-wg0 autoconnect yes
```

- Reactivate the `server-wg0` connection:

```
# nmcli connection up server-wg0
```

Next steps

- [Configure the firewalld service on the WireGuard server.](#)

Verification

- Display the interface configuration of the `wg0` device:

```
# wg show wg0
interface: wg0
public key: UtjqCJ57DeAscYKRfp7cFGiQqdONRn69u249Fa4O6BE=
private key: (hidden)
listening port: 51820

peer: bnwfQcC8/g2i4vvEqcRUM2e6Hi3Nskk6G9t4r26nFVM=
allowed ips: 192.0.2.2/32, 2001:db8:1::2/128
```

To display the private key in the output, use the `WG_HIDE_KEYS=never wg show wg0` command.

- Display the IP configuration of the `wg0` device:

```
# ip address show wg0
20: wg0: <POINTOPOINT,NOARP,UP,LOWER_UP> mtu 1420 qdisc noqueue state
UNKNOWN group default qlen 1000
link/none
inet 192.0.2.1/24 brd 192.0.2.255 scope global noprefixroute wg0
valid_lft forever preferred_lft forever
inet6 2001:db8:1::1/32 scope global noprefixroute
```



```
valid_lft forever preferred_lft forever
inet6 fe80::3ef:8863:1ce2:844/64 scope link noprefixroute
valid_lft forever preferred_lft forever
```

Additional resources

- The **wg(8)** man page
- The **WireGuard setting** section in the **nm-settings(5)** man page

8.6. CONFIGURING A WIREGUARD SERVER BY USING NMTUI

You can configure the WireGuard server by creating a connection profile in NetworkManager. Use this method to let NetworkManager manage the WireGuard connection.

This procedure assumes the following settings:

- Server:
 - Private key: **YFAnE0psgldiAF7XR4abxiwVRnlMfeltxu10s/c4JXg=**
 - Tunnel IPv4 address: **192.0.2.1/24**
 - Tunnel IPv6 address: **2001:db8:1::1/32**
- Client:
 - Public key: **bnwfQcC8/g2i4vvEqcRUM2e6Hi3Nskk6G9t4r26nFVM=**
 - Tunnel IPv4 address: **192.0.2.2/24**
 - Tunnel IPv6 address: **2001:db8:1::2/32**

Prerequisites

- You have generated the public and private key for both the server and client.
- You know the following information:
 - The private key of the server
 - The static tunnel IP addresses and subnet masks of the client
 - The public key of the client
 - The static tunnel IP addresses and subnet masks of the server
- You installed the **NetworkManager-tui** package.

Procedure

1. Start the **nmtui** application:

```
# nmtui
```

2. Select **Edit a connection**, and press **Enter**.

3. Select **Add**, and press **Enter**.
4. Select the **WireGuard** connection type in the list, and press **Enter**.
5. In the **Edit connection** window:
 - a. Enter the name of the connection and the virtual interface, such as **wg0**, that NetworkManager should assign to the connection.
 - b. Enter the private key of the server.
 - c. Set the listen port number, such as **51820**, for incoming WireGuard connections. Always set a fixed port number on hosts that receive incoming WireGuard connections. If you do not set a port, WireGuard uses a random free port each time you activate the interface.

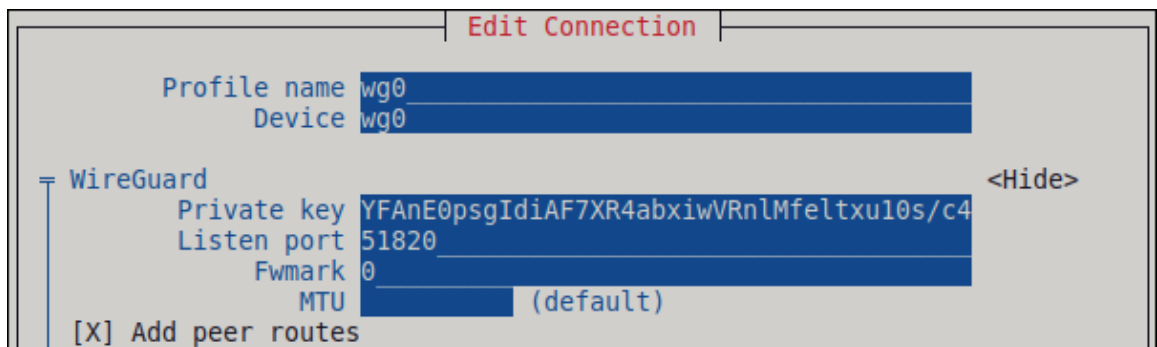

- d. Click **Add** next to the **Peers** pane:
 - i. Enter the public key of the client.
 - ii. Set the **Allowed IPs** field to the tunnel IP addresses of the client that are allowed to send data to this server.
 - iii. Select **OK**, and press **Enter**.

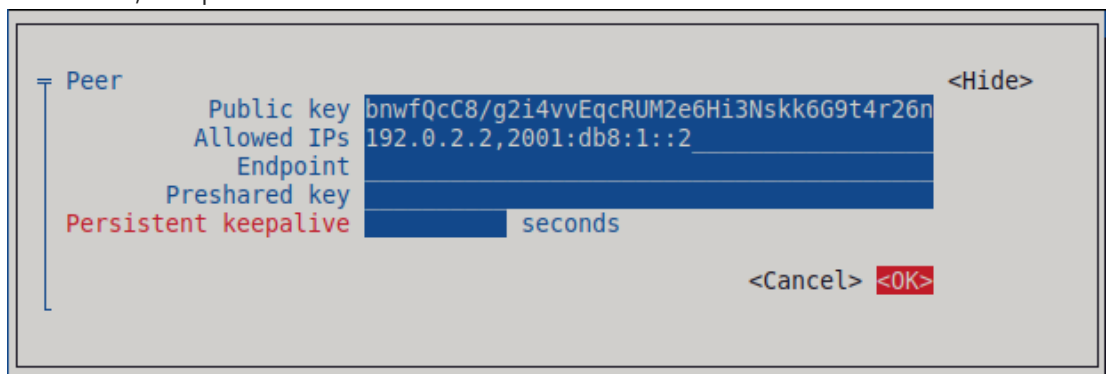

- e. Select **Show** next to **IPv4 Configuration**, and press **Enter**.
 - i. Select the IPv4 configuration method **Manual**.
 - ii. Enter the tunnel IPv4 address and the subnet mask. Leave the **Gateway** field empty.
- f. Select **Show** next to **IPv6 Configuration**, and press **Enter**.
 - i. Select the IPv6 configuration method **Manual**.
 - ii. Enter the tunnel IPv6 address and the subnet mask. Leave the **Gateway** field empty.

- g. Select **OK**, and press **Enter**

```

IPv4 CONFIGURATION <Manual> <Hide>
  Addresses 192.0.2.1/24 <Remove>
             <Add...>
  Gateway
  DNS servers <Add...>
  Search domains <Add...>

  Routing (No custom routes) <Edit...>
  [ ] Never use this network for default route
  [ ] Ignore automatically obtained routes
  [ ] Ignore automatically obtained DNS parameters

  [ ] Require IPv4 addressing for this connection

IPv6 CONFIGURATION <Manual> <Hide>
  Addresses 2001:db8:1::1/32 <Remove>
             <Add...>
  Gateway
  DNS servers <Add...>
  Search domains <Add...>
  Routing (No custom routes) <Edit...>
  [ ] Never use this network for default route
  [ ] Ignore automatically obtained routes
  [ ] Ignore automatically obtained DNS parameters

  [ ] Require IPv6 addressing for this connection

[X] Automatically connect
[X] Available to all users

<Cancel> <OK>

```

- In the window with the list of connections, select **Back**, and press **Enter**.
- In the **NetworkManager TUI** main window, select **Quit**, and press **Enter**.

Next steps

- [Configure the firewalld service on the WireGuard server.](#)

Verification

- Display the interface configuration of the **wg0** device:

```

# wg show wg0
interface: wg0
  public key: UtjqCJ57DeAscYKRfp7cFGiQqdONRn69u249Fa4O6BE=
  private key: (hidden)
  listening port: 51820

peer: bnwfQcC8/g2i4vvEqcRUM2e6Hi3Nskk6G9t4r26nFVM=
  allowed ips: 192.0.2.2/32, 2001:db8:1::2/128

```

To display the private key in the output, use the **WG_HIDE_KEYS=never wg show wg0** command.

- Display the IP configuration of the **wg0** device:

```
# ip address show wg0
20: wg0: <POINTOPOINT,NOARP,UP,LOWER_UP> mtu 1420 qdisc noqueue state
UNKNOWN group default qlen 1000
    link/none
    inet 192.0.2.1/24 brd 192.0.2.255 scope global noprefixroute wg0
        valid_lft forever preferred_lft forever
    inet6 2001:db8:1::1/32 scope global noprefixroute
        valid_lft forever preferred_lft forever
    inet6 fe80::3ef:8863:1ce2:844/64 scope link noprefixroute
        valid_lft forever preferred_lft forever
```

Additional resources

- The **wg(8)** man page

8.7. CONFIGURING A WIREGUARD SERVER BY USING NM-CONNECTION-EDITOR

You can configure the WireGuard server by creating a connection profile in NetworkManager. Use this method to let NetworkManager manage the WireGuard connection.

Prerequisites

- You have generated the public and private key for both the server and client.
- You know the following information:
 - The private key of the server
 - The static tunnel IP addresses and subnet masks of the client
 - The public key of the client
 - The static tunnel IP addresses and subnet masks of the server

Procedure

1. Open a terminal, and enter:

```
# nm-connection-editor
```

2. Add a new connection by clicking the **+** button.
3. Select the **WireGuard** connection type, and click **Create**.
4. Optional: Update the connection name.
5. On the **General** tab, select **Connect automatically with priority**. Optionally, set a priority value.
6. On the **WireGuard** tab:
 - a. Enter the name of the virtual interface, such as **wg0**, that NetworkManager should assign to the connection.
 - b. Enter the private key of the server.

- c. Set the listen port number, such as **51820**, for incoming WireGuard connections. Always set a fixed port number on hosts that receive incoming WireGuard connections. If you do not set a port, WireGuard uses a random free port each time you activate the interface.
 - d. Click **Add** to add peers:
 - i. Enter the public key of the client.
 - ii. Set the **Allowed IPs** field to the tunnel IP addresses of the client that are allowed to send data to this server.
 - iii. Click **Apply**.
7. On the **IPv4 Settings** tab:
 - a. Select **Manual** in the **Method** list.
 - b. Click **Add** to enter the tunnel IPv4 address and the subnet mask. Leave the **Gateway** field empty.
 8. On the **IPv6 Settings** tab:
 - a. Select **Manual** in the **Method** list.
 - b. Click **Add** to enter the tunnel IPv6 address and the subnet mask. Leave the **Gateway** field empty.
 9. Click **Save** to store the connection profile.

Next steps

- [Configure the firewalld service on the WireGuard server.](#)

Verification

1. Display the interface configuration of the **wg0** device:

```
# wg show wg0
interface: wg0
  public key: UtjqCJ57DeAscYKRfp7cFGiQqdONRn69u249Fa4O6BE=
  private key: (hidden)
  listening port: 51820

peer: bnwfQcC8/g2i4vvEqcRUM2e6Hi3Nskk6G9t4r26nFVM=
  allowed ips: 192.0.2.2/32, 2001:db8:1::2/128
```

To display the private key in the output, use the **WG_HIDE_KEYS=never wg show wg0** command.

2. Display the IP configuration of the **wg0** device:

```
# ip address show wg0
20: wg0: <POINTOPOINT,NOARP,UP,LOWER_UP> mtu 1420 qdisc noqueue state
UNKNOWN group default qlen 1000
  link/none
```

```

inet 192.0.2.1/24 brd 192.0.2.255 scope global noprefixroute wg0
    valid_lft forever preferred_lft forever
inet6 2001:db8:1::1/32 scope global noprefixroute
    valid_lft forever preferred_lft forever
inet6 fe80::3ef:8863:1ce2:844/64 scope link noprefixroute
    valid_lft forever preferred_lft forever

```

Additional resources

- The **wg(8)** man page

8.8. CONFIGURING A WIREGUARD SERVER BY USING THE WG-QUICK SERVICE

You can configure the WireGuard server by creating a configuration file in the `/etc/wireguard/` directory. Use this method to configure the service independently from NetworkManager.

This procedure assumes the following settings:

- Server:
 - Private key: **YFAnE0psglDiAF7XR4abxiwVRnIMfeltxu10s/c4JXg=**
 - Tunnel IPv4 address: **192.0.2.1/24**
 - Tunnel IPv6 address: **2001:db8:1::1/32**
- Client:
 - Public key: **bnwfQcC8/g2i4vvEqcRUM2e6Hi3Nskk6G9t4r26nFVM=**
 - Tunnel IPv4 address: **192.0.2.2/24**
 - Tunnel IPv6 address: **2001:db8:1::2/32**

Prerequisites

- You have generated the public and private key for both the server and client.
- You know the following information:
 - The private key of the server
 - The static tunnel IP addresses and subnet masks of the client
 - The public key of the client
 - The static tunnel IP addresses and subnet masks of the server

Procedure

1. Install the **wireguard-tools** package:

```
# dnf install wireguard-tools
```

2. Create the `/etc/wireguard/wg0.conf` file with the following content:

```
[Interface]
Address = 192.0.2.1/24, 2001:db8:1::1/32
ListenPort = 51820
PrivateKey = YFAnE0psgldiAF7XR4abxiwVRnIMfeltxu10s/c4JXg=

[Peer]
PublicKey = bnwfQcC8/g2i4vvEqcRUM2e6Hi3Nskk6G9t4r26nFVM=
AllowedIPs = 192.0.2.2, 2001:db8:1::2
```

- The **[Interface]** section describes the WireGuard settings of the interface on the server:
 - **Address:** A comma-separated list of the server's tunnel IP addresses.
 - **PrivateKey:** The private key of the server.
 - **ListenPort:** The port on which WireGuard listens for incoming UDP connections. Always set a fixed port number on hosts that receive incoming WireGuard connections. If you do not set a port, WireGuard uses a random free port each time you activate the **wg0** interface.
 - Each **[Peer]** section describes the settings of one client:
 - **PublicKey:** The public key of the client.
 - **AllowedIPs:** The tunnel IP addresses of the client that are allowed to send data to this server.
3. Enable and start the WireGuard connection:

```
# systemctl enable --now wg-quick@wg0
```

The `systemd` instance name must match the name of the configuration file in the `/etc/wireguard/` directory without the `.conf` suffix. The service also uses this name for the virtual network interface.

Next steps

- [Configure the `firewalld` service on the WireGuard server.](#)

Verification

1. Display the interface configuration of the **wg0** device:

```
# wg show wg0
interface: wg0
  public key: UtjqCJ57DeAscYKRfp7cFGiQqdONRn69u249Fa4O6BE=
  private key: (hidden)
  listening port: 51820

peer: bnwfQcC8/g2i4vvEqcRUM2e6Hi3Nskk6G9t4r26nFVM=
  allowed ips: 192.0.2.2/32, 2001:db8:1::2/128
```

To display the private key in the output, use the `WG_HIDE_KEYS=never wg show wg0` command.

2. Display the IP configuration of the **wg0** device:

```
# ip address show wg0
20: wg0: <POINTOPOINT,NOARP,UP,LOWER_UP> mtu 1420 qdisc noqueue state
UNKNOWN group default qlen 1000
    link/none
    inet 192.0.2.1/24 scope global wg0
        valid_lft forever preferred_lft forever
    inet6 2001:db8:1::1/32 scope global
        valid_lft forever preferred_lft forever
```

Additional resources

- The **wg(8)** man page
- The **wg-quick(8)** man page

8.9. CONFIGURING FIREWALLD ON A WIREGUARD SERVER BY USING THE COMMAND LINE

You must configure the **firewalld** service on the WireGuard server to allow incoming connections from clients. Additionally, if clients should be able to use the WireGuard server as the default gateway and route all traffic through the tunnel, you must enable masquerading.

Procedure

1. Open the WireGuard port for incoming connections in the **firewalld** service:

```
# firewall-cmd --permanent --add-port=51820/udp --zone=public
```

2. If clients should route all traffic through the tunnel and use the WireGuard server as the default gateway, enable masquerading for the **public** zone:

```
# firewall-cmd --permanent --zone=public --add-masquerade
```

3. Reload the **firewalld** rules.

```
# firewall-cmd --reload
```

Verification

- Display the configuration of the **public** zone:

```
# firewall-cmd --list-all
public (active)
...
ports: 51820/udp
masquerade: yes
...
```

Additional resources

- The **firewall-cmd(1)** man page

8.10. CONFIGURING FIREWALLD ON A WIREGUARD SERVER BY USING THE GRAPHICAL INTERFACE

You must configure the **firewalld** service on the WireGuard server to allow incoming connections from clients. Additionally, if clients should be able to use the WireGuard server as the default gateway and route all traffic through the tunnel, you must enable masquerading.

Procedure

1. Press the **Super** key, enter **firewall**, and select the **Firewall** application from the results.
2. Select **Permanent** in the **Configuration** list.
3. Select the **public** zone.
4. Allow incoming connections to the WireGuard port:
 - a. On the **Ports** tab, click **Add**.
 - b. Enter the port number you set for incoming WireGuard connections:
 - c. Select **udp** from the **Protocol** list.
 - d. Click **OK**.
5. If clients should route all traffic through the tunnel and use the WireGuard server as the default gateway:
 - a. Navigate to the **Masquerading** tab of the **public** zone.
 - b. Select **Masquerade zone**.
6. Select **Options** → **Reload Firewalld**.

Verification

- Display the configuration of the **public** zone:

```
# firewall-cmd --list-all
public (active)
...
ports: 51820/udp
masquerade: yes
...
```

8.11. CONFIGURING A WIREGUARD CLIENT BY USING NMCLI

You can configure a WireGuard client by creating a connection profile in NetworkManager. Use this method to let NetworkManager manage the WireGuard connection.

This procedure assumes the following settings:

- Client:

- Private key: **aPUcp5vHz8yMLrzk8SsDyYnV33lhE/k20e52iKJFV0A=**
- Tunnel IPv4 address: **192.0.2.2/24**
- Tunnel IPv6 address: **2001:db8:1::2/32**
- Server:
 - Public key: **UtjqCJ57DeAscYKRfp7cFGiQqdONRn69u249Fa4O6BE=**
 - Tunnel IPv4 address: **192.0.2.1/24**
 - Tunnel IPv6 address: **2001:db8:1::1/32**

Prerequisites

- You have generated the public and private key for both the server and client.
- You know the following information:
 - The private key of the client
 - The static tunnel IP addresses and subnet masks of the client
 - The public key of the server
 - The static tunnel IP addresses and subnet masks of the server

Procedure

1. Add a NetworkManager WireGuard connection profile:

```
# nmcli connection add type wireguard con-name client-wg0 ifname wg0 autoconnect no
```

This command creates a profile named **client-wg0** and assigns the virtual interface **wg0** to it. To prevent the connection from starting automatically after you add it without finalizing the configuration, disable the **autoconnect** parameter.

2. Optional: Configure NetworkManager so that it does not automatically start the **client-wg** connection:

```
# nmcli connection modify client-wg0 autoconnect no
```

3. Set the tunnel IPv4 address and subnet mask of the client:

```
# nmcli connection modify client-wg0 ipv4.method manual ipv4.addresses 192.0.2.2/24
```

4. Set the tunnel IPv6 address and subnet mask of the client:

```
# nmcli connection modify client-wg0 ipv6.method manual ipv6.addresses 2001:db8:1::2/32
```

5. If you want to route all traffic through the tunnel, set the tunnel IP addresses of the server as the default gateway:

```
# nmcli connection modify client-wg0 ipv4.gateway 192.0.2.1 ipv6.gateway
2001:db8:1::1
```

Routing all traffic through the tunnel requires that you set, in a later step, the **allowed-ips** on the this client to **0.0.0.0/0:::0**.

Note that routing all traffic through the tunnel can impact the connectivity to other hosts based on the server routing and firewall configuration.

6. Add the client's private key to the connection profile:

```
# nmcli connection modify client-wg0 wireguard.private-key
"aPUcp5vHz8yMLrzk8SsDyYnV33lhE/k20e52iKJFV0A="
```

7. Add peer configurations for each server that you want to allow to communicate with this client. You must add these settings manually, because the **nmcli** utility does not support setting the corresponding connection properties.
 - a. Edit the `/etc/NetworkManager/system-connections/client-wg0.nmconnection` file, and append:

```
[wireguard-peer.UtjqCJ57DeAscYKRfp7cFGiQqdONRn69u249Fa4O6BE=]
endpoint=server.example.com:51820
allowed-ips=192.0.2.1;2001:db8:1::1;
persistent-keepalive=20
```

- The `[wireguard-peer.<public_key_of_the_server>]` entry defines the peer section of the server, and the section name has the public key of the server.
- The **endpoint** parameter sets the hostname or IP address and the port of the server. The client uses this information to establish the connection.
- The **allowed-ips** parameter sets a list of IP addresses that can send data to this client. For example, set the parameter to:
 - The tunnel IP addresses of the server to allow only the server to communicate with this client. The value in the example above configures this scenario.
 - **0.0.0.0/0:::0**; to allow any remote IPv4 and IPv6 address to communicate with this client. Use this setting to route all traffic through the tunnel and use the WireGuard server as default gateway.
- The optional **persistent-keepalive** parameter defines an interval in seconds in which WireGuard sends a keep alive packet to the server. Set this parameter if you use the client in a network with network address translation (NAT) or if a firewall closes the UDP connection after some time of inactivity.

- b. Reload the **client-wg0** connection profile:

```
# nmcli connection load /etc/NetworkManager/system-connections/client-wg0.nmconnection
```

8. Reactivate the **client-wg0** connection:

```
# nmcli connection up client-wg0
```

Verification

1. Ping the IP addresses of the server:

```
# ping 192.0.2.1
# ping6 2001:db8:1::1
```

2. Display the interface configuration of the **wg0** device:

```
# wg show wg0
interface: wg0
  public key: bnwfQcC8/g2i4vvEqcRUM2e6Hi3Nskk6G9t4r26nFVM=
  private key: (hidden)
  listening port: 51820

peer: UtjqCJ57DeAscYKRfp7cFGiQqdONRn69u249Fa4O6BE=
  endpoint: server.example.com:51820
  allowed ips: 192.0.2.1/32, 2001:db8:1::1/128
  latest handshake: 1 minute, 41 seconds ago
  transfer: 824 B received, 1.01 KiB sent
  persistent keepalive: every 20 seconds
```

To display the private key in the output, use the **WG_HIDE_KEYS=never wg show wg0** command.

Note that the output has only the **latest handshake** and **transfer** entries if you have already sent traffic through the VPN tunnel.

3. Display the IP configuration of the **wg0** device:

```
# ip address show wg0
10: wg0: <POINTOPOINT,NOARP,UP,LOWER_UP> mtu 1420 qdisc noqueue state
UNKNOWN group default qlen 1000
    link/none
    inet 192.0.2.2/24 brd 192.0.2.255 scope global noprefixroute wg0
        valid_lft forever preferred_lft forever
    inet6 2001:db8:1::2/32 scope global noprefixroute
        valid_lft forever preferred_lft forever
    inet6 fe80::73d9:6f51:ea6f:863e/64 scope link noprefixroute
        valid_lft forever preferred_lft forever
```

Additional resources

- The **wg(8)** man page
- The **WireGuard setting** section in the **nm-settings(5)** man page

8.12. CONFIGURING A WIREGUARD CLIENT BY USING NMTUI

You can configure a WireGuard client by creating a connection profile in NetworkManager. Use this method to let NetworkManager manage the WireGuard connection.

This procedure assumes the following settings:

- Client:

- Private key: **aPUcp5vHz8yMLrzk8SsDyYnV33lhE/k20e52iKJFV0A=**
- Tunnel IPv4 address: **192.0.2.2/24**
- Tunnel IPv6 address: **2001:db8:1::2/32**
- Server:
 - Public key: **UtjqCJ57DeAscYKRfp7cFGiQqdONRn69u249Fa4O6BE=**
 - Tunnel IPv4 address: **192.0.2.1/24**
 - Tunnel IPv6 address: **2001:db8:1::1/32**

Prerequisites

- You have generated the public and private key for both the server and client.
- You know the following information:
 - The private key of the client
 - The static tunnel IP addresses and subnet masks of the client
 - The public key of the server
 - The static tunnel IP addresses and subnet masks of the server
- You installed the **NetworkManager-tui** package

Procedure

1. Start the **nmtui** application:

```
█ # nmtui
```

2. Select **Edit a connection**, and press **Enter**.
3. Select **Add**, and press **Enter**.
4. Select the **WireGuard** connection type in the list, and press **Enter**.
5. In the **Edit connection** window:
 - a. Enter the name of the connection and the virtual interface, such as **wg0**, that NetworkManager should assign to the connection.
 - b. Enter the private key of the client.

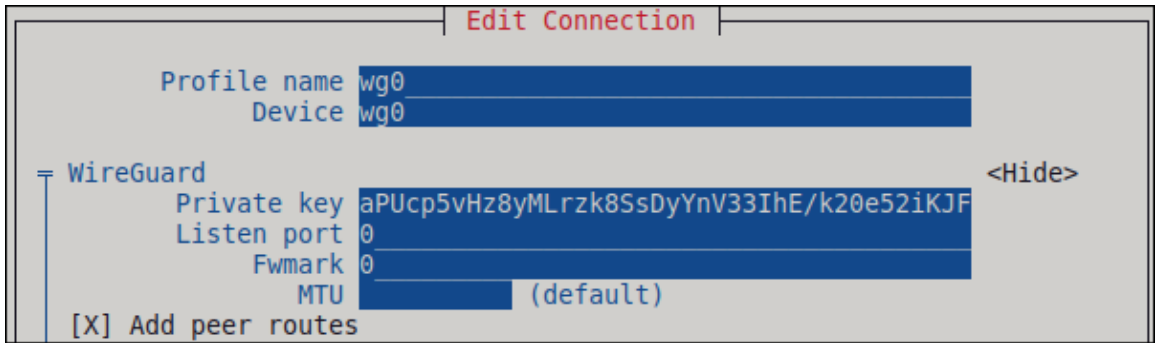

- c. Click **Add** next to the **Peers** pane:
 - i. Enter the public key of the server.
 - ii. Set the **Allowed IPs** field. For example, set it to:
 - The tunnel IP addresses of the server to allow only the server to communicate with this client.
 - **0.0.0.0/0,::/0** to allow any remote IPv4 and IPv6 address to communicate with this client. Use this setting to route all traffic through the tunnel and use the WireGuard server as default gateway.
 - iii. Enter the host name or IP address and port of the WireGuard server into the **Endpoint** field. Use the following format: **hostname_or_IP:port_number**
 - iv. Optional: If you use the client in a network with network address translation (NAT) or if a firewall closes the UDP connection after some time of inactivity, set a persistent keep alive interval in seconds. In this interval, the client sends a keepalive packet to the server.
 - v. Select **OK**, and press **Enter**.

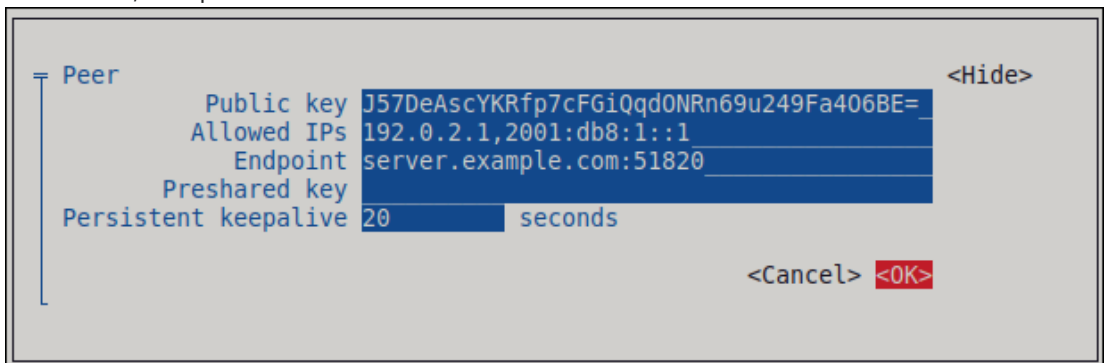

- d. Select **Show** next to **IPv4 Configuration**, and press **Enter**.
 - i. Select the IPv4 configuration method **Manual**.
 - ii. Enter the tunnel IPv4 address and the subnet mask. Leave the **Gateway** field empty.
- e. Select **Show** next to **IPv6 Configuration**, and press **Enter**.
 - i. Select the IPv6 configuration method **Manual**.
 - ii. Enter the tunnel IPv6 address and the subnet mask. Leave the **Gateway** field empty.
- f. Optional: Select **Automatically connect**.
- g. Select **OK**, and press **Enter**

```

= IPv4 CONFIGURATION <Manual> <Hide>
  Addresses 192.0.2.2/24 <Remove>
             <Add...>
  Gateway   [redacted]
  DNS servers <Add...>
  Search domains <Add...>

  Routing (No custom routes) <Edit...>
  [ ] Never use this network for default route
  [ ] Ignore automatically obtained routes
  [ ] Ignore automatically obtained DNS parameters

  [ ] Require IPv4 addressing for this connection

= IPv6 CONFIGURATION <Manual> <Hide>
  Addresses 2001:db8:1::2/32 <Remove>
             <Add...>
  Gateway   [redacted]
  DNS servers <Add...>
  Search domains <Add...>
  Routing (No custom routes) <Edit...>
  [ ] Never use this network for default route
  [ ] Ignore automatically obtained routes
  [ ] Ignore automatically obtained DNS parameters

  [ ] Require IPv6 addressing for this connection

[X] Automatically connect
[X] Available to all users

<Cancel> <OK>

```

6. In the window with the list of connections, select **Back**, and press **Enter**.
7. In the **NetworkManager TUI** main window, select **Quit**, and press **Enter**.

Verification

1. Ping the IP addresses of the server:

```
# ping 192.0.2.1
# ping6 2001:db8:1::1
```

2. Display the interface configuration of the **wg0** device:

```
# wg show wg0
interface: wg0
  public key: bnwfQcC8/g2i4vvEqcRUM2e6Hi3Nskk6G9t4r26nFVM=
  private key: (hidden)
  listening port: 51820

peer: UtjqCJ57DeAscYKRfp7cFGiQqdONRn69u249Fa4O6BE=
  endpoint: server.example.com:51820
  allowed ips: 192.0.2.1/32, 2001:db8:1::1/128
  latest handshake: 1 minute, 41 seconds ago
  transfer: 824 B received, 1.01 KiB sent
  persistent keepalive: every 20 seconds
```

To display the private key in the output, use the **WG_HIDE_KEYS=never wg show wg0** command.

Note that the output contains only the **latest handshake** and **transfer** entries if you have already sent traffic through the VPN tunnel.

3. Display the IP configuration of the **wg0** device:

```
# ip address show wg0
10: wg0: <POINTOPOINT,NOARP,UP,LOWER_UP> mtu 1420 qdisc noqueue state
UNKNOWN group default qlen 1000
    link/none
    inet 192.0.2.2/24 brd 192.0.2.255 scope global noprefixroute wg0
        valid_lft forever preferred_lft forever
    inet6 2001:db8:1::2/32 scope global noprefixroute
        valid_lft forever preferred_lft forever
    inet6 fe80::73d9:6f51:ea6f:863e/64 scope link noprefixroute
        valid_lft forever preferred_lft forever
```

Additional resources

- The **wg(8)** man page

8.13. CONFIGURING A WIREGUARD CLIENT BY USING NM-CONNECTION-EDITOR

You can configure a WireGuard client by creating a connection profile in NetworkManager. Use this method to let NetworkManager manage the WireGuard connection.

Prerequisites

- You have generated the public and private key for both the server and client.
- You know the following information:
 - The private key of the client
 - The static tunnel IP addresses and subnet masks of the client
 - The public key of the server
 - The static tunnel IP addresses and subnet masks of the server

Procedure

1. Open a terminal, and enter:

```
# nm-connection-editor
```

2. Add a new connection by clicking the **+** button.
3. Select the **WireGuard** connection type, and click **Create**.
4. Optional: Update the connection name.

5. Optional: On the **General** tab, select **Connect automatically with priority**.
6. On the **WireGuard** tab:
 - a. Enter the name of the virtual interface, such as **wg0**, that NetworkManager should assign to the connection.
 - b. Enter client's private key.
 - c. Click **Add** to add peers:
 - i. Enter the public key of the server.
 - ii. Set the **Allowed IPs** field. For example, set it to:
 - The tunnel IP addresses of the server to allow only the server to communicate with this client.
 - **0.0.0.0/0:::0**; to allow any remote IPv4 and IPv6 address to communicate with this client. Use this setting to route all traffic through the tunnel and use the WireGuard server as default gateway.
Note that routing all traffic through the tunnel can impact the connectivity to other hosts based on the server routing and firewall configuration.
 - iii. Enter the hostname or IP address and port of the WireGuard server into the **Endpoint** field. Use the following format: **hostname_or_IP:port_number**
 - iv. Optional: If you use the client in a network with network address translation (NAT) or if a firewall closes the UDP connection after some time of inactivity, set a persistent keep alive interval in seconds. In this interval, the client sends a keep alive packet to the server.
 - v. Click **Apply**.
7. On the **IPv4 Settings** tab:
 - a. Select **Manual** in the **Method** list.
 - b. Click **Add** to enter the tunnel IPv4 address and the subnet mask.
 - c. If you want to route all traffic through the tunnel, set the tunnel IPv4 address of the server in the **Gateway** field. Otherwise, leave the field empty.
Routing all IPv4 traffic through the tunnel requires that you included **0.0.0.0** in the **Allowed IPs** field on this client.
8. On the **IPv6 Settings** tab:
 - a. Select **Manual** in the **Method** list.
 - b. Click **Add** to enter the tunnel IPv6 address and the subnet mask.
 - c. If you want to route all traffic through the tunnel, set the tunnel IPv6 address of the server in the **Gateway** field. Otherwise, leave the field empty.
Routing all IPv4 traffic through the tunnel requires that you included **::0** in the **Allowed IPs** field on this client.
9. Click **Save** to store the connection profile.

Verification

1. Ping the IP addresses of the server:

```
# ping 192.0.2.1
# ping6 2001:db8:1::1
```

2. Display the interface configuration of the **wg0** device:

```
# wg show wg0
interface: wg0
  public key: bnwfQcC8/g2i4vvEqcRUM2e6Hi3Nskk6G9t4r26nFVM=
  private key: (hidden)
  listening port: 51820

peer: UtjqCJ57DeAscYKRfp7cFGiQqdONRn69u249Fa4O6BE=
  endpoint: server.example.com:51820
  allowed ips: 192.0.2.1/32, 2001:db8:1::1/128
  latest handshake: 1 minute, 41 seconds ago
  transfer: 824 B received, 1.01 KiB sent
  persistent keepalive: every 20 seconds
```

To display the private key in the output, use the **WG_HIDE_KEYS=never wg show wg0** command.

Note that the output only has the **latest handshake** and **transfer** entries if you have already sent traffic through the VPN tunnel.

3. Display the IP configuration of the **wg0** device:

```
# ip address show wg0
10: wg0: <POINTOPOINT,NOARP,UP,LOWER_UP> mtu 1420 qdisc noqueue state
UNKNOWN group default qlen 1000
  link/none
  inet 192.0.2.2/24 brd 192.0.2.255 scope global noprefixroute wg0
    valid_lft forever preferred_lft forever
  inet6 2001:db8:1::2/32 scope global noprefixroute
    valid_lft forever preferred_lft forever
  inet6 fe80::73d9:6f51:ea6f:863e/64 scope link noprefixroute
    valid_lft forever preferred_lft forever
```

Additional resources

- The **wg(8)** man page

8.14. CONFIGURING A WIREGUARD CLIENT BY USING THE WG-QUICK SERVICE

You can configure a WireGuard client by creating a configuration file in the **/etc/wireguard/** directory. Use this method to configure the service independently from NetworkManager.

This procedure assumes the following settings:

- Client:

- Private key: **aPUcp5vHz8yMLrzk8SsDyYnV33lhE/k20e52iKJFV0A=**
- Tunnel IPv4 address: **192.0.2.2/24**
- Tunnel IPv6 address: **2001:db8:1::2/32**
- Server:
 - Public key: **UtjqCJ57DeAscYKRfp7cFGiQqdONRn69u249Fa4O6BE=**
 - Tunnel IPv4 address: **192.0.2.1/24**
 - Tunnel IPv6 address: **2001:db8:1::1/32**

Prerequisites

- You have generated the public and private key for both the server and client.
- You know the following information:
 - The private key of the client
 - The static tunnel IP addresses and subnet masks of the client
 - The public key of the server
 - The static tunnel IP addresses and subnet masks of the server

Procedure

1. Install the **wireguard-tools** package:

```
# dnf install wireguard-tools
```

2. Create the **/etc/wireguard/wg0.conf** file with the following content:

```
[Interface]
Address = 192.0.2.2/24, 2001:db8:1::2/32
PrivateKey = aPUcp5vHz8yMLrzk8SsDyYnV33lhE/k20e52iKJFV0A=

[Peer]
PublicKey = UtjqCJ57DeAscYKRfp7cFGiQqdONRn69u249Fa4O6BE=
AllowedIPs = 192.0.2.1, 2001:db8:1::1
Endpoint = server.example.com:51820
PersistentKeepalive = 20
```

- The **[Interface]** section describes the WireGuard settings of the interface on the client:
 - **Address**: A comma-separated list of the client's tunnel IP addresses.
 - **PrivateKey**: The private key of the client.
- The **[Peer]** section describes the settings of the server:
 - **PublicKey**: The public key of the server.

- **AllowedIPs:** The IP addresses that are allowed to send data to this client. For example, set the parameter to:
 - The tunnel IP addresses of the server to allow only the server to communicate with this client. The value in the example above configures this scenario.
 - **0.0.0.0/0, ::/0** to allow any remote IPv4 and IPv6 address to communicate with this client. Use this setting to route all traffic through the tunnel and use the WireGuard server as default gateway.
 - **Endpoint:** Sets the hostname or IP address and the port of the server. The client uses this information to establish the connection.
 - The optional **persistent-keepalive** parameter defines an interval in seconds in which WireGuard sends a keepalive packet to the server. Set this parameter if you use the client in a network with network address translation (NAT) or if a firewall closes the UDP connection after some time of inactivity.
3. Enable and start the WireGuard connection:

```
# systemctl enable --now wg-quick@wg0
```

The systemd instance name must match the name of the configuration file in the `/etc/wireguard/` directory without the `.conf` suffix. The service also uses this name for the virtual network interface.

Verification

1. Ping the IP addresses of the server:

```
# ping 192.0.2.1
# ping6 2001:db8:1::1
```

2. Display the interface configuration of the `wg0` device:

```
# wg show wg0
interface: wg0
  public key: bnwfQcC8/g2i4vvEqcRUM2e6Hi3Nskk6G9t4r26nFVM=
  private key: (hidden)
  listening port: 51820

peer: UtjqCJ57DeAscYKRfp7cFGiQqdONRn69u249Fa4O6BE=
  endpoint: server.example.com:51820
  allowed ips: 192.0.2.1/32, 2001:db8:1::1/128
  latest handshake: 1 minute, 41 seconds ago
  transfer: 824 B received, 1.01 KiB sent
  persistent keepalive: every 20 seconds
```

To display the private key in the output, use the `WG_HIDE_KEYS=never wg show wg0` command.

Note that the output contains only the **latest handshake** and **transfer** entries if you have already sent traffic through the VPN tunnel.

3. Display the IP configuration of the `wg0` device:

ip address show wg0

```
10: wg0: <POINTOPOINT,NOARP,UP,LOWER_UP> mtu 1420 qdisc noqueue state
UNKNOWN group default qlen 1000
    link/none
    inet 192.0.2.2/24 scope global wg0
        valid_lft forever preferred_lft forever
    inet6 2001:db8:1::2/32__ scope global
        valid_lft forever preferred_lft forever
```

Additional resources

- The **wg(8)** man page
- The **wg-quick(8)** man page

CHAPTER 9. CONFIGURING IP TUNNELS

Similar to a VPN, an IP tunnel directly connects two networks over a third network, such as the internet. However, not all tunnel protocols support encryption.

The routers in both networks that establish the tunnel requires at least two interfaces:

- One interface that is connected to the local network
- One interface that is connected to the network through which the tunnel is established.

To establish the tunnel, you create a virtual interface on both routers with an IP address from the remote subnet.

NetworkManager supports the following IP tunnels:

- Generic Routing Encapsulation (GRE)
- Generic Routing Encapsulation over IPv6 (IP6GRE)
- Generic Routing Encapsulation Terminal Access Point (GRETAP)
- Generic Routing Encapsulation Terminal Access Point over IPv6 (IP6GRETAP)
- IPv4 over IPv4 (IPIP)
- IPv4 over IPv6 (IPIP6)
- IPv6 over IPv6 (IP6IP6)
- Simple Internet Transition (SIT)

Depending on the type, these tunnels act either on layer 2 or 3 of the Open Systems Interconnection (OSI) model.

9.1. CONFIGURING AN IPIP TUNNEL USING NMCLI TO ENCAPSULATE IPV4 TRAFFIC IN IPV4 PACKETS

An IP over IP (IPIP) tunnel operates on OSI layer 3 and encapsulates IPv4 traffic in IPv4 packets as described in [RFC 2003](#).

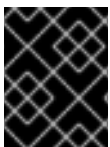

IMPORTANT

Data sent through an IPIP tunnel is not encrypted. For security reasons, use the tunnel only for data that is already encrypted, for example, by other protocols, such as HTTPS.

Note that IPIP tunnels support only unicast packets. If you require an IPv4 tunnel that supports multicast, see [Configuring a GRE tunnel using nmcli to encapsulate layer-3 traffic in IPv4 packets](#).

For example, you can create an IPIP tunnel between two RHEL routers to connect two internal subnets over the internet as shown in the following diagram:

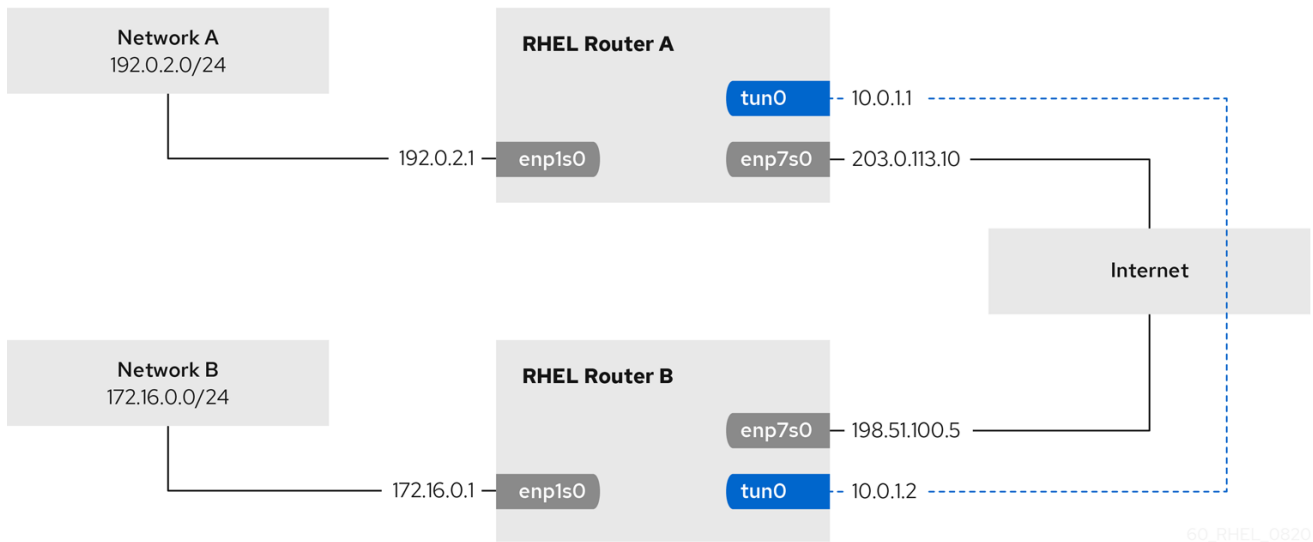

60_RHEL_0820

Prerequisites

- Each RHEL router has a network interface that is connected to its local subnet.
- Each RHEL router has a network interface that is connected to the internet.
- The traffic you want to send through the tunnel is IPv4 unicast.

Procedure

1. On the RHEL router in network A:
 - a. Create an IPIP tunnel interface named **tun0**:

```
# nmcli connection add type ip-tunnel ip-tunnel.mode ipip con-name tun0 ifname
tun0 remote 198.51.100.5 local 203.0.113.10
```

The **remote** and **local** parameters set the public IP addresses of the remote and the local routers.

- b. Set the IPv4 address to the **tun0** device:

```
# nmcli connection modify tun0 ipv4.addresses '10.0.1.1/30'
```

Note that a **/30** subnet with two usable IP addresses is sufficient for the tunnel.

- c. Configure the **tun0** connection to use a manual IPv4 configuration:

```
# nmcli connection modify tun0 ipv4.method manual
```

- d. Add a static route that routes traffic to the **172.16.0.0/24** network to the tunnel IP on router B:

```
# nmcli connection modify tun0 +ipv4.routes "172.16.0.0/24 10.0.1.2"
```

- e. Enable the **tun0** connection.

```
# nmcli connection up tun0
```

- f. Enable packet forwarding:

```
# echo "net.ipv4.ip_forward=1" > /etc/sysctl.d/95-IPv4-forwarding.conf
# sysctl -p /etc/sysctl.d/95-IPv4-forwarding.conf
```

2. On the RHEL router in network B:

- a. Create an IPIP tunnel interface named **tun0**:

```
# nmcli connection add type ip-tunnel ip-tunnel.mode ipip con-name tun0 ifname
tun0 remote 203.0.113.10 local 198.51.100.5
```

The **remote** and **local** parameters set the public IP addresses of the remote and local routers.

- b. Set the IPv4 address to the **tun0** device:

```
# nmcli connection modify tun0 ipv4.addresses '10.0.1.2/30'
```

- c. Configure the **tun0** connection to use a manual IPv4 configuration:

```
# nmcli connection modify tun0 ipv4.method manual
```

- d. Add a static route that routes traffic to the **192.0.2.0/24** network to the tunnel IP on router A:

```
# nmcli connection modify tun0 +ipv4.routes "192.0.2.0/24 10.0.1.1"
```

- e. Enable the **tun0** connection.

```
# nmcli connection up tun0
```

- f. Enable packet forwarding:

```
# echo "net.ipv4.ip_forward=1" > /etc/sysctl.d/95-IPv4-forwarding.conf
# sysctl -p /etc/sysctl.d/95-IPv4-forwarding.conf
```

Verification

- From each RHEL router, ping the IP address of the internal interface of the other router:

- a. On Router A, ping **172.16.0.1**:

```
# ping 172.16.0.1
```

- b. On Router B, ping **192.0.2.1**:

```
# ping 192.0.2.1
```

Additional resources

- `nmcli(1)` man page
- `nm-settings(5)` man page

9.2. CONFIGURING A GRE TUNNEL USING NMCLI TO ENCAPSULATE LAYER-3 TRAFFIC IN IPV4 PACKETS

A Generic Routing Encapsulation (GRE) tunnel encapsulates layer-3 traffic in IPv4 packets as described in [RFC 2784](#). A GRE tunnel can encapsulate any layer 3 protocol with a valid Ethernet type.



IMPORTANT

Data sent through a GRE tunnel is not encrypted. For security reasons, use the tunnel only for data that is already encrypted, for example, by other protocols, such as HTTPS.

For example, you can create a GRE tunnel between two RHEL routers to connect two internal subnets over the internet as shown in the following diagram:

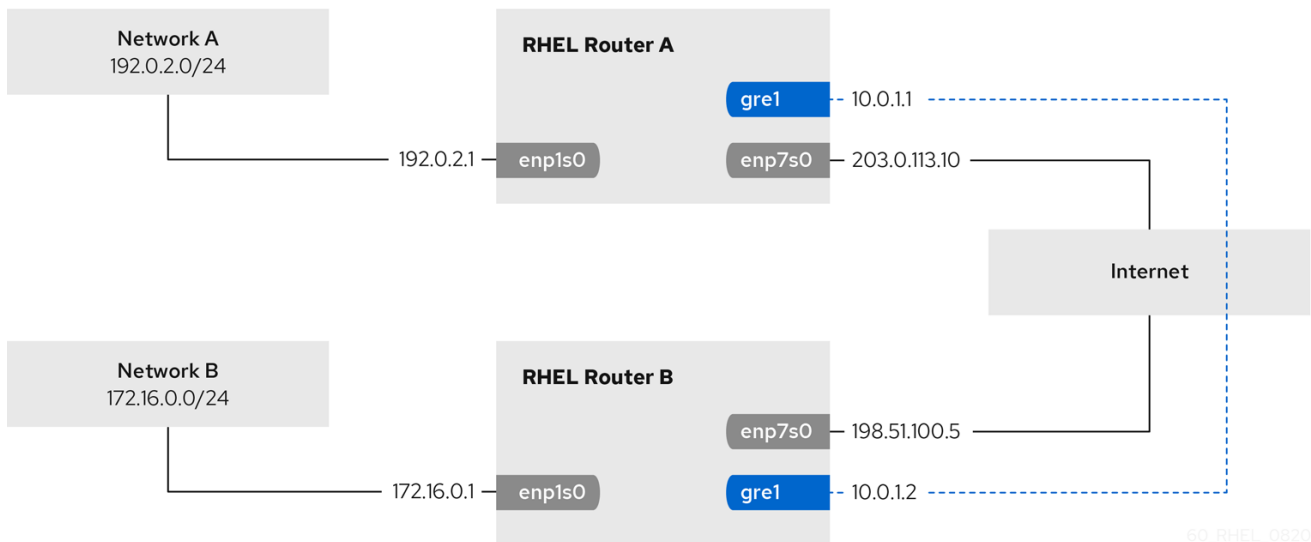

NOTE

The `gre0` device name is reserved. Use `gre1` or a different name for the device.

Prerequisites

- Each RHEL router has a network interface that is connected to its local subnet.
- Each RHEL router has a network interface that is connected to the internet.

Procedure

1. On the RHEL router in network A:
 - a. Create a GRE tunnel interface named `gre1`:

```
# nmcli connection add type ip-tunnel ip-tunnel.mode gre con-name gre1 ifname gre1 remote 198.51.100.5 local 203.0.113.10
```

The **remote** and **local** parameters set the public IP addresses of the remote and the local routers.

- b. Set the IPv4 address to the **gre1** device:

```
# nmcli connection modify gre1 ipv4.addresses '10.0.1.1/30'
```

Note that a /30 subnet with two usable IP addresses is sufficient for the tunnel.

- c. Configure the **gre1** connection to use a manual IPv4 configuration:

```
# nmcli connection modify gre1 ipv4.method manual
```

- d. Add a static route that routes traffic to the **172.16.0.0/24** network to the tunnel IP on router B:

```
# nmcli connection modify gre1 +ipv4.routes "172.16.0.0/24 10.0.1.2"
```

- e. Enable the **gre1** connection.

```
# nmcli connection up gre1
```

- f. Enable packet forwarding:

```
# echo "net.ipv4.ip_forward=1" > /etc/sysctl.d/95-IPv4-forwarding.conf
# sysctl -p /etc/sysctl.d/95-IPv4-forwarding.conf
```

2. On the RHEL router in network B:

- a. Create a GRE tunnel interface named **gre1**:

```
# nmcli connection add type ip-tunnel ip-tunnel.mode gre con-name gre1 ifname
gre1 remote 203.0.113.10 local 198.51.100.5
```

The **remote** and **local** parameters set the public IP addresses of the remote and the local routers.

- b. Set the IPv4 address to the **gre1** device:

```
# nmcli connection modify gre1 ipv4.addresses '10.0.1.2/30'
```

- c. Configure the **gre1** connection to use a manual IPv4 configuration:

```
# nmcli connection modify gre1 ipv4.method manual
```

- d. Add a static route that routes traffic to the **192.0.2.0/24** network to the tunnel IP on router A:

```
# nmcli connection modify gre1 +ipv4.routes "192.0.2.0/24 10.0.1.1"
```

- e. Enable the **gre1** connection.

```
# nmcli connection up gre1
```

- f. Enable packet forwarding:

```
# echo "net.ipv4.ip_forward=1" > /etc/sysctl.d/95-IPv4-forwarding.conf
# sysctl -p /etc/sysctl.d/95-IPv4-forwarding.conf
```

Verification

1. From each RHEL router, ping the IP address of the internal interface of the other router:
 - a. On Router A, ping **172.16.0.1**:

```
# ping 172.16.0.1
```

- b. On Router B, ping **192.0.2.1**:

```
# ping 192.0.2.1
```

Additional resources

- **nmcli(1)** man page
- **nm-settings(5)** man page

9.3. CONFIGURING A GRE TAP TUNNEL TO TRANSFER ETHERNET FRAMES OVER IPV4

A Generic Routing Encapsulation Terminal Access Point (GRE TAP) tunnel operates on OSI level 2 and encapsulates Ethernet traffic in IPv4 packets as described in [RFC 2784](#).

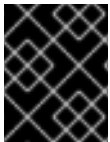

IMPORTANT

Data sent through a GRE TAP tunnel is not encrypted. For security reasons, establish the tunnel over a VPN or a different encrypted connection.

For example, you can create a GRE TAP tunnel between two RHEL routers to connect two networks using a bridge as shown in the following diagram:

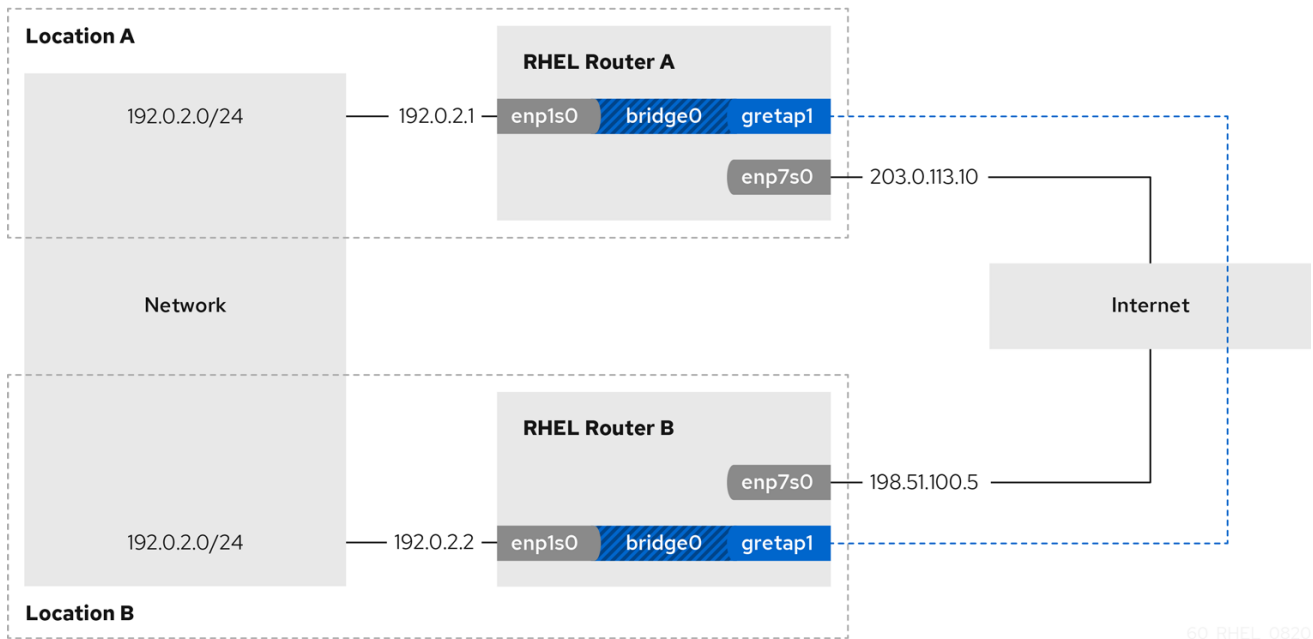

NOTE

The **gretap0** device name is reserved. Use **gretap1** or a different name for the device.

Prerequisites

- Each RHEL router has a network interface that is connected to its local network, and the interface has no IP configuration assigned.
- Each RHEL router has a network interface that is connected to the internet.

Procedure

1. On the RHEL router in network A:

a. Create a bridge interface named **bridge0**:

```
# nmcli connection add type bridge con-name bridge0 ifname bridge0
```

b. Configure the IP settings of the bridge:

```
# nmcli connection modify bridge0 ipv4.addresses '192.0.2.1/24'
# nmcli connection modify bridge0 ipv4.method manual
```

c. Add a new connection profile for the interface that is connected to local network to the bridge:

```
# nmcli connection add type ethernet slave-type bridge con-name bridge0-port1
ifname enp1s0 master bridge0
```

d. Add a new connection profile for the GRETAP tunnel interface to the bridge:

```
# nmcli connection add type ip-tunnel ip-tunnel.mode gretap slave-type bridge
con-name bridge0-port2 ifname gretap1 remote 198.51.100.5 local 203.0.113.10
master bridge0
```

The **remote** and **local** parameters set the public IP addresses of the remote and the local routers.

- e. Optional: Disable the Spanning Tree Protocol (STP) if you do not need it:

```
# nmcli connection modify bridge0 bridge.stp no
```

By default, STP is enabled and causes a delay before you can use the connection.

- f. Configure that activating the **bridge0** connection automatically activates the ports of the bridge:

```
# nmcli connection modify bridge0 connection.autoconnect-slaves 1
```

- g. Active the **bridge0** connection:

```
# nmcli connection up bridge0
```

2. On the RHEL router in network B:

- a. Create a bridge interface named **bridge0**:

```
# nmcli connection add type bridge con-name bridge0 ifname bridge0
```

- b. Configure the IP settings of the bridge:

```
# nmcli connection modify bridge0 ipv4.addresses '192.0.2.2/24'
# nmcli connection modify bridge0 ipv4.method manual
```

- c. Add a new connection profile for the interface that is connected to local network to the bridge:

```
# nmcli connection add type ethernet slave-type bridge con-name bridge0-port1
ifname enp1s0 master bridge0
```

- d. Add a new connection profile for the GRE-TAP tunnel interface to the bridge:

```
# nmcli connection add type ip-tunnel ip-tunnel.mode gretap slave-type bridge
con-name bridge0-port2 ifname gretap1 remote 203.0.113.10 local 198.51.100.5
master bridge0
```

The **remote** and **local** parameters set the public IP addresses of the remote and the local routers.

- e. Optional: Disable the Spanning Tree Protocol (STP) if you do not need it:

```
# nmcli connection modify bridge0 bridge.stp no
```

- f. Configure that activating the **bridge0** connection automatically activates the ports of the bridge:

```
# nmcli connection modify bridge0 connection.autoconnect-slaves 1
```

- g. Active the **bridge0** connection:

```
# nmcli connection up bridge0
```

Verification

1. On both routers, verify that the **enp1s0** and **gretap1** connections are connected and that the **CONNECTION** column displays the connection name of the port:

```
# nmcli device
nmcli device
DEVICE TYPE STATE CONNECTION
...
bridge0 bridge connected bridge0
enp1s0 ethernet connected bridge0-port1
gretap1 iptunnel connected bridge0-port2
```

2. From each RHEL router, ping the IP address of the internal interface of the other router:
 - a. On Router A, ping **192.0.2.2**:

```
# ping 192.0.2.2
```

- b. On Router B, ping **192.0.2.1**:

```
# ping 192.0.2.1
```

Additional resources

- [nmcli\(1\)](#) man page
- [nm-settings\(5\)](#) man page

9.4. ADDITIONAL RESOURCES

- [ip-link\(8\)](#) man page

CHAPTER 10. USING A VXLAN TO CREATE A VIRTUAL LAYER-2 DOMAIN FOR VMs

A virtual extensible LAN (VXLAN) is a networking protocol that tunnels layer-2 traffic over an IP network using the UDP protocol. For example, certain virtual machines (VMs), that are running on different hosts can communicate over a VXLAN tunnel. The hosts can be in different subnets or even in different data centers around the world. From the perspective of the VMs, other VMs in the same VXLAN are within the same layer-2 domain:

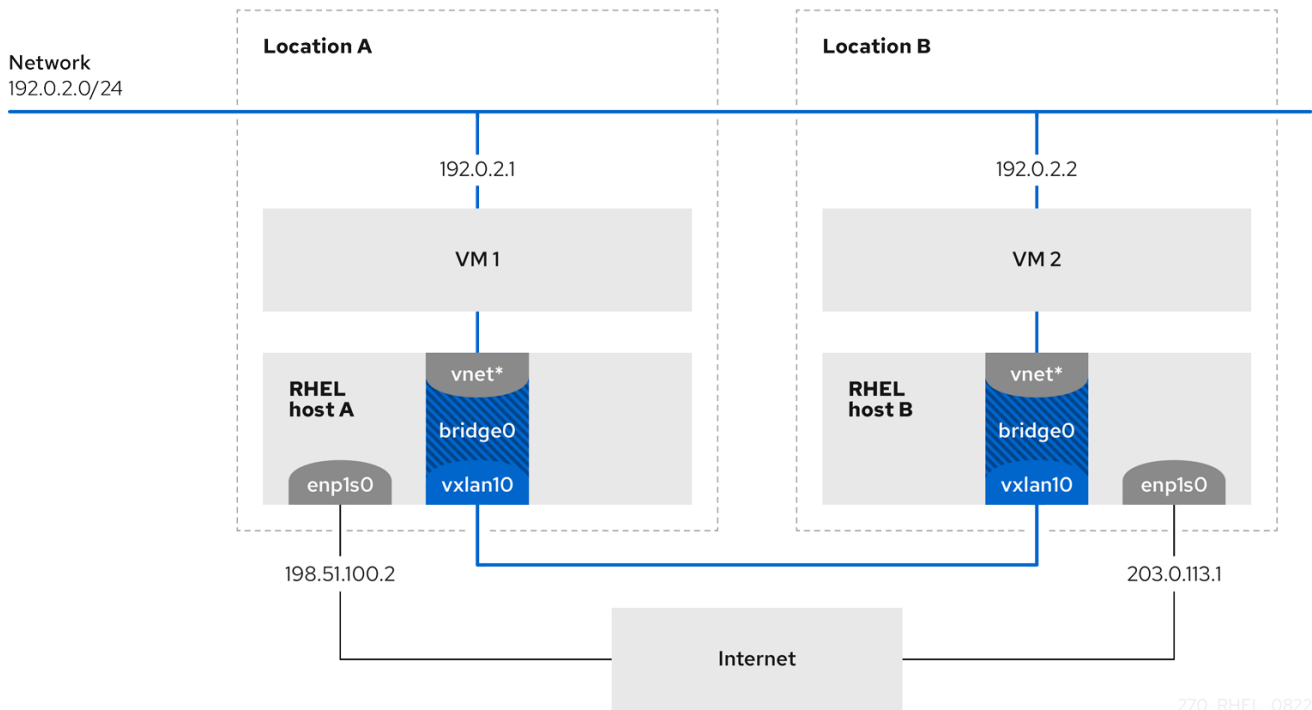

In this example, RHEL-host-A and RHEL-host-B use a bridge, **br0**, to connect the virtual network of a VM on each host with a VXLAN named **vxlan10**. Due to this configuration, the VXLAN is invisible to the VMs, and the VMs do not require any special configuration. If you later connect more VMs to the same virtual network, the VMs are automatically members of the same virtual layer-2 domain.

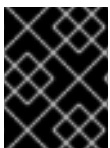

IMPORTANT

Just as normal layer-2 traffic, data in a VXLAN is not encrypted. For security reasons, use a VXLAN over a VPN or other types of encrypted connections.

10.1. BENEFITS OF VXLANs

A virtual extensible LAN (VXLAN) provides the following major benefits:

- VXLANs use a 24-bit ID. Therefore, you can create up to 16,777,216 isolated networks. For example, a virtual LAN (VLAN), supports only 4,096 isolated networks.
- VXLANs use the IP protocol. This enables you to route the traffic and virtually run systems in different networks and locations within the same layer-2 domain.
- Unlike most tunnel protocols, a VXLAN is not only a point-to-point network. A VXLAN can learn the IP addresses of the other endpoints either dynamically or use statically-configured forwarding entries.

- Certain network cards support UDP tunnel-related offload features.

Additional resources

- `/usr/share/doc/kernel-doc-<kernel_version>/Documentation/networking/vxlan.rst` provided by the `kernel-doc` package

10.2. CONFIGURING THE ETHERNET INTERFACE ON THE HOSTS

To connect a RHEL VM host to the Ethernet, create a network connection profile, configure the IP settings, and activate the profile.

Run this procedure on both RHEL hosts, and adjust the IP address configuration accordingly.

Prerequisites

- The host is connected to the Ethernet.

Procedure

1. Add a new Ethernet connection profile to NetworkManager:

```
# nmcli connection add con-name Example ifname enp1s0 type ethernet
```

2. Configure the IPv4 settings:

```
# nmcli connection modify Example ipv4.addresses 198.51.100.2/24 ipv4.method manual ipv4.gateway 198.51.100.254 ipv4.dns 198.51.100.200 ipv4.dns-search example.com
```

Skip this step if the network uses DHCP.

3. Activate the **Example** connection:

```
# nmcli connection up Example
```

Verification

1. Display the status of the devices and connections:

```
# nmcli device status
DEVICE  TYPE    STATE    CONNECTION
enp1s0  ethernet connected Example
```

2. Ping a host in a remote network to verify the IP settings:

```
# ping RHEL-host-B.example.com
```

Note that you cannot ping the other VM host before you have configured the network on that host as well.

Additional resources

- **nm-settings(5)** man page

10.3. CREATING A NETWORK BRIDGE WITH A VXLAN ATTACHED

To make a virtual extensible LAN (VXLAN) invisible to virtual machines (VMs), create a bridge on a host, and attach the VXLAN to the bridge. Use NetworkManager to create both the bridge and the VXLAN. You do not add any traffic access point (TAP) devices of the VMs, typically named **vnet*** on the host, to the bridge. The **libvirt** service adds them dynamically when the VMs start.

Run this procedure on both RHEL hosts, and adjust the IP addresses accordingly.

Procedure

1. Create the bridge **br0**:

```
# nmcli connection add type bridge con-name br0 ifname br0 ipv4.method disabled
ipv6.method disabled
```

This command sets no IPv4 and IPv6 addresses on the bridge device, because this bridge works on layer 2.

2. Create the VXLAN interface and attach it to **br0**:

```
# nmcli connection add type vxlan slave-type bridge con-name br0-vxlan10 ifname
vxlan10 id 10 local 198.51.100.2 remote 203.0.113.1 master br0
```

This command uses the following settings:

- **id 10**: Sets the VXLAN identifier.
- **local 198.51.100.2**: Sets the source IP address of outgoing packets.
- **remote 203.0.113.1**: Sets the unicast or multicast IP address to use in outgoing packets when the destination link layer address is not known in the VXLAN device forwarding database.
- **master br0**: Sets this VXLAN connection to be created as a port in the **br0** connection.
- **ipv4.method disabled** and **ipv6.method disabled**: Disables IPv4 and IPv6 on the bridge.

By default, NetworkManager uses **8472** as the destination port. If the destination port is different, additionally, pass the **destination-port <port_number>** option to the command.

3. Activate the **br0** connection profile:

```
# nmcli connection up br0
```

4. Open port **8472** for incoming UDP connections in the local firewall:

```
# firewall-cmd --permanent --add-port=8472/udp
# firewall-cmd --reload
```

Verification

- Display the forwarding table:

```
# bridge fdb show dev vxlan10
2a:53:bd:d5:b3:0a master br0 permanent
00:00:00:00:00:00 dst 203.0.113.1 self permanent
...
```

Additional resources

- **nm-settings(5)** man page

10.4. CREATING A VIRTUAL NETWORK IN LIBVIRT WITH AN EXISTING BRIDGE

To enable virtual machines (VM) to use the **br0** bridge with the attached virtual extensible LAN (VXLAN), first add a virtual network to the **libvirtd** service that uses this bridge.

Prerequisites

- You installed the **libvirt** package.
- You started and enabled the **libvirtd** service.
- You configured the **br0** device with the VXLAN on RHEL.

Procedure

1. Create the `~/vxlan10-bridge.xml` file with the following content:

```
<network>
  <name>vxlan10-bridge</name>
  <forward mode="bridge" />
  <bridge name="br0" />
</network>
```

2. Use the `~/vxlan10-bridge.xml` file to create a new virtual network in **libvirt**:

```
# virsh net-define ~/vxlan10-bridge.xml
```

3. Remove the `~/vxlan10-bridge.xml` file:

```
# rm ~/vxlan10-bridge.xml
```

4. Start the **vxlan10-bridge** virtual network:

```
# virsh net-start vxlan10-bridge
```

5. Configure the **vxlan10-bridge** virtual network to start automatically when the **libvirtd** service starts:

```
# virsh net-autostart vxlan10-bridge
```

Verification

- Display the list of virtual networks:

```
# virsh net-list
Name          State  Autostart Persistent
-----
vxlan10-bridge active yes      yes
...
```

Additional resources

- **virsh(1)** man page

10.5. CONFIGURING VIRTUAL MACHINES TO USE VXLAN

To configure a VM to use a bridge device with an attached virtual extensible LAN (VXLAN) on the host, create a new VM that uses the **vxlan10-bridge** virtual network or update the settings of existing VMs to use this network.

Perform this procedure on the RHEL hosts.

Prerequisites

- You configured the **vxlan10-bridge** virtual network in **libvirt**.

Procedure

- To create a new VM and configure it to use the **vxlan10-bridge** network, pass the **--network network:vxlan10-bridge** option to the **virt-install** command when you create the VM:

```
# virt-install ... --network network:vxlan10-bridge
```

- To change the network settings of an existing VM:
 - a. Connect the VM's network interface to the **vxlan10-bridge** virtual network:

```
# virt-xml VM_name --edit --network network=vxlan10-bridge
```

- b. Shut down the VM, and start it again:

```
# virsh shutdown VM_name
# virsh start VM_name
```

Verification

1. Display the virtual network interfaces of the VM on the host:

```
# virsh domiflist VM_name
Interface Type  Source          Model  MAC
-----
vnet1     bridge vxlan10-bridge virtio 52:54:00:c5:98:1c
```

2. Display the interfaces attached to the **vxlan10-bridge** bridge:

```
# ip link show master vxlan10-bridge
18: vxlan10: <BROADCAST,MULTICAST,UP,LOWER_UP> mtu 1500 qdisc noqueue master
br0 state UNKNOWN mode DEFAULT group default qlen 1000
    link/ether 2a:53:bd:d5:b3:0a brd ff:ff:ff:ff:ff:ff
19: vnet1: <BROADCAST,MULTICAST,UP,LOWER_UP> mtu 1500 qdisc noqueue master
br0 state UNKNOWN mode DEFAULT group default qlen 1000
    link/ether 52:54:00:c5:98:1c brd ff:ff:ff:ff:ff:ff
```

Note that the **libvirtd** service dynamically updates the bridge's configuration. When you start a VM which uses the **vxlan10-bridge** network, the corresponding **vnet*** device on the host appears as a port of the bridge.

3. Use address resolution protocol (ARP) requests to verify whether VMs are in the same VXLAN:
 - a. Start two or more VMs in the same VXLAN.
 - b. Send an ARP request from one VM to the other one:

```
# arping -c 1 192.0.2.2
ARPING 192.0.2.2 from 192.0.2.1 enp1s0
Unicast reply from 192.0.2.2 [52:54:00:c5:98:1c] 1.450ms
Sent 1 probe(s) (0 broadcast(s))
Received 1 response(s) (0 request(s), 0 broadcast(s))
```

If the command shows a reply, the VM is in the same layer-2 domain and, in this case in the same VXLAN.

Install the **iputils** package to use the **arping** utility.

Additional resources

- **virt-install(1)** man page
- **virt-xml(1)** man page
- **virsh(1)** man page
- **arping(8)** man page

CHAPTER 11. MANAGING WIFI CONNECTIONS

RHEL provides multiple utilities and applications to configure and connect to wifi networks, for example:

- Use the **nmcli** utility to configure connections by using the command line.
- Use the **nmtui** application to configure connections in a text-based user interface.
- Use the GNOME system menu to quickly connect to wifi networks that do not require any configuration.
- Use the **GNOME Settings** application to configure connections by using the GNOME application.
- Use the **nm-connection-editor** application to configure connections in a graphical user interface.
- Use the **network** RHEL system role to automate the configuration of connections on one or multiple hosts.

11.1. SUPPORTED WIFI SECURITY TYPES

Depending on the security type a wifi network supports, you can transmitted data more or less securely.



WARNING

Do not connect to wifi networks that do not use encryption or which support only the insecure WEP or WPA standards.

Red Hat Enterprise Linux 9 supports the following wifi security types:

- **None:** Encryption is disabled, and data is transferred in plain text over the network.
- **Enhanced Open:** With opportunistic wireless encryption (OWE), devices negotiate unique pairwise master keys (PMK) to encrypt connections in wireless networks without authentication.
- **LEAP:** The Lightweight Extensible Authentication Protocol, which was developed by Cisco, is a proprietary version of the extensible authentication protocol (EAP).
- **WPA & WPA2 Personal:** In personal mode, the Wi-Fi Protected Access (WPA) and Wi-Fi Protected Access 2 (WPA2) authentication methods use a pre-shared key.
- **WPA & WPA2 Enterprise:** In enterprise mode, WPA and WPA2 use the EAP framework and authenticate users to a remote authentication dial-in user service (RADIUS) server.
- **WPA3 Personal:** Wi-Fi Protected Access 3 (WPA3) Personal uses simultaneous authentication of equals (SAE) instead of pre-shared keys (PSK) to prevent dictionary attacks. WPA3 uses perfect forward secrecy (PFS).

11.2. CONNECTING TO A WIFI NETWORK BY USING NMCLI

You can use the **nmcli** utility to connect to a wifi network. When you attempt to connect to a network for the first time, the utility automatically creates a NetworkManager connection profile for it. If the network requires additional settings, such as static IP addresses, you can then modify the profile after it has been automatically created.

Prerequisites

- A wifi device is installed on the host.
- The wifi device is enabled, if it has a hardware switch.

Procedure

1. If the wifi radio has been disabled in NetworkManager, enable this feature:

```
# nmcli radio wifi on
```

2. Optional: Display the available wifi networks:

```
# nmcli device wifi list
IN-USE BSSID      SSID      MODE CHAN RATE  SIGNAL BARS SECURITY
      00:53:00:2F:3B:08 Office    Infra 44  270 Mbit/s 57  ████████ WPA2 WPA3
      00:53:00:15:03:BF --        Infra 1   130 Mbit/s 48  ████████ WPA2 WPA3
```

The service set identifier (**SSID**) column contains the names of the networks. If the column shows **--**, the access point of this network does not broadcast an SSID.

3. Connect to the wifi network:

```
# nmcli device wifi connect Office --ask
Password: wifi-password
```

If you prefer to set the password in the command instead of entering it interactively, use the **password *wifi-password*** option in the command instead of **--ask**:

```
# nmcli device wifi connect Office wifi-password
```

Note that, if the network requires static IP addresses, NetworkManager fails to activate the connection at this point. You can configure the IP addresses in later steps.

4. If the network requires static IP addresses:
 - a. Configure the IPv4 address settings, for example:

```
# nmcli connection modify Office ipv4.method manual ipv4.addresses 192.0.2.1/24
ipv4.gateway 192.0.2.254 ipv4.dns 192.0.2.200 ipv4.dns-search example.com
```

- b. Configure the IPv6 address settings, for example:

```
# nmcli connection modify Office ipv6.method manual ipv6.addresses
2001:db8:1::1/64 ipv6.gateway 2001:db8:1::ffe ipv6.dns 2001:db8:1::ffbb ipv6.dns-
search example.com
```

5. Re-activate the connection:

```
# nmcli connection up Office
```

Verification

1. Display the active connections:

```
# nmcli connection show --active
NAME ID TYPE DEVICE
Office 2501eb7e-7b16-4dc6-97ef-7cc460139a58 wifi wlp0s20f3
```

If the output lists the wifi connection you have created, the connection is active.

2. Ping a hostname or IP address:

```
# ping -c 3 example.com
```

Additional resources

- [nm-settings-nmcli\(5\)](#) man page

11.3. CONNECTING TO A WIFI NETWORK BY USING THE GNOME SYSTEM MENU

You can use the GNOME system menu to connect to a wifi network. When you connect to a network for the first time, GNOME creates a NetworkManager connection profile for it. If you configure the connection profile to not automatically connect, you can also use the GNOME system menu to manually connect to a wifi network with an existing NetworkManager connection profile.

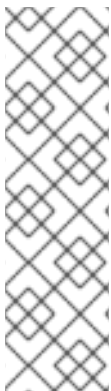

NOTE

Using the GNOME system menu to establish a connection to a wifi network for the first time has certain limitations. For example, you can not configure IP address settings. In this case first configure the connections:

- In the [GNOME settings](#) application
- In the [nm-connection-editor](#) application
- Using [nmcli](#) commands

Prerequisites

- A wifi device is installed on the host.
- The wifi device is enabled, if it has a hardware switch.

Procedure

1. Open the system menu on the right side of the top bar.
2. Expand the **Wi-Fi Not Connected** entry.
3. Click **Select Network:**

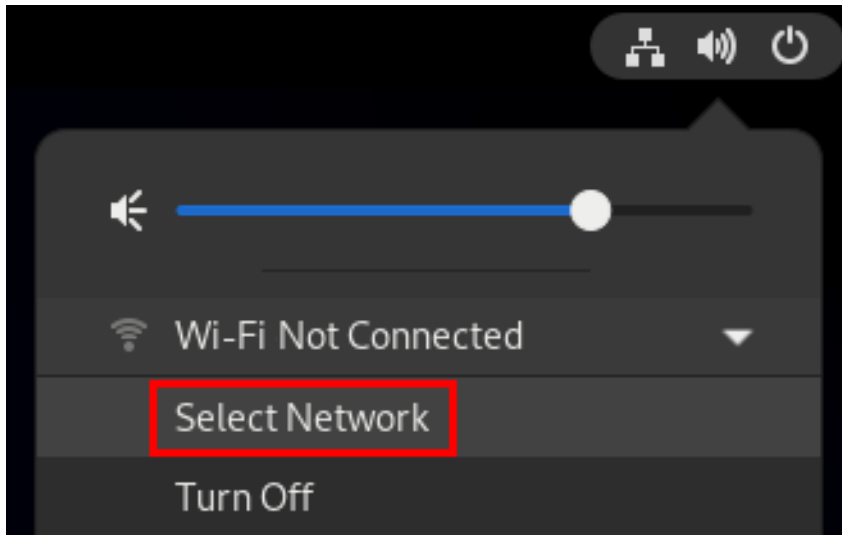

4. Select the wifi network you want to connect to.
5. Click **Connect**.
6. If this is the first time you connect to this network, enter the password for the network, and click **Connect**.

Verification

1. Open the system menu on the right side of the top bar, and verify that the wifi network is connected:

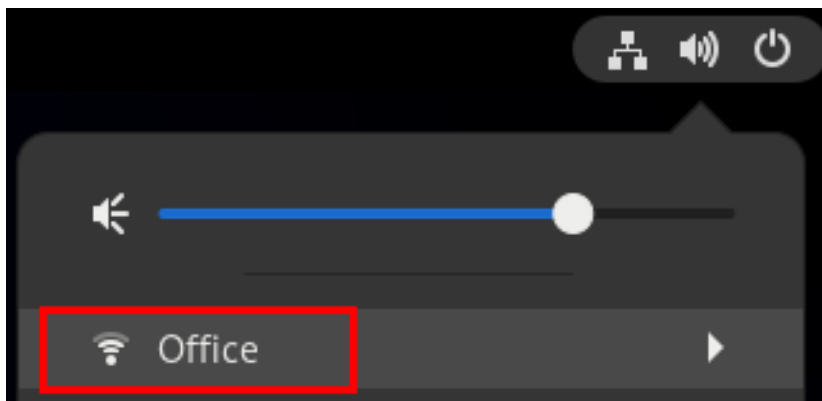

If the network appears in the list, it is connected.

2. Ping a hostname or IP address:

```
# ping -c 3 example.com
```

11.4. CONNECTING TO A WIFI NETWORK BY USING THE GNOME SETTINGS APPLICATION

You can use the **GNOME settings** application, also named **gnome-control-center**, to connect to a wifi network and configure the connection. When you connect to the network for the first time, GNOME creates a NetworkManager connection profile for it.

In **GNOME settings**, you can configure wifi connections for all wifi network security types that RHEL supports.

Prerequisites

- A wifi device is installed on the host.
- The wifi device is enabled, if it has a hardware switch.

Procedure

1. Press the **Super** key, type **Wi-Fi**, and press **Enter**.
2. Click on the name of the wifi network you want to connect to.
3. Enter the password for the network, and click **Connect**.
4. If the network requires additional settings, such as static IP addresses or a security type other than WPA2 Personal:
 - a. Click the gear icon next to the network's name.
 - b. Optional: Configure the network profile on the **Details** tab to not automatically connect. If you deactivate this feature, you must always manually connect to the network, for example, by using **GNOME settings** or the GNOME system menu.
 - c. Configure IPv4 settings on the **IPv4** tab, and IPv6 settings on the **IPv6** tab.
 - d. On the **Security** tab, select the authentication of the network, such as **WPA3 Personal**, and enter the password. Depending on the selected security, the application shows additional fields. Fill them accordingly. For details, ask the administrator of the wifi network.
 - e. Click **Apply**.

Verification

1. Open the system menu on the right side of the top bar, and verify that the wifi network is connected:

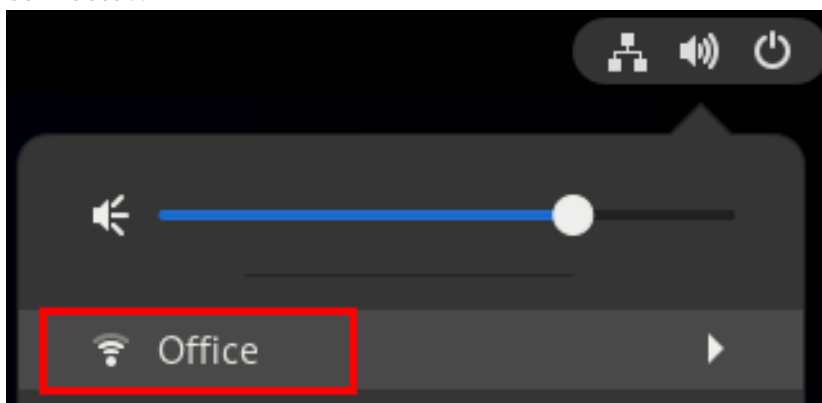

If the network appears in the list, it is connected.

2. Ping a hostname or IP address:

```
# ping -c 3 example.com
```

11.5. CONFIGURING A WIFI CONNECTION BY USING NMTUI

The **nmcli** application provides a text-based user interface for NetworkManager. You can use **nmcli** to connect to a wifi network.



NOTE

In **nmcli**:

- Navigate by using the cursor keys.
- Press a button by selecting it and hitting **Enter**.
- Select and deselect checkboxes by using **Space**.

Procedure

1. If you do not know the network device name you want to use in the connection, display the available devices:

```
# nmcli device status
DEVICE  TYPE   STATE      CONNECTION
wlp2s0  wifi   unavailable --
...
```

2. Start **nmcli**:

```
# nmcli
```

3. Select **Edit a connection**, and press **Enter**.
4. Press the **Add** button.
5. Select **Wi-Fi** from the list of network types, and press **Enter**.
6. Optional: Enter a name for the NetworkManager profile to be created.
On hosts with multiple profiles, a meaningful name makes it easier to identify the purpose of a profile.
7. Enter the network device name into the **Device** field.
8. Enter the name of the Wi-Fi network, the Service Set Identifier (SSID), into the **SSID** field.
9. Leave the **Mode** field set to its default, **Client**.
10. Select the **Security** field, press **Enter**, and set the authentication type of the network from the list.
Depending on the authentication type you have selected, **nmcli** displays different fields.
11. Fill the authentication type-related fields.
12. If the Wi-Fi network requires static IP addresses:
 - a. Press the **Automatic** button next to the protocol, and select **Manual** from the displayed list.
 - b. Press the **Show** button next to the protocol you want to configure to display additional fields, and fill them.

- Press the **OK** button to create and automatically activate the new connection.

Edit Connection

Profile name
 Device

WI-FI <Hide>

SSID
 Mode

Security
 Password
 Show password

BSSID
 Cloned MAC address
 MTU

= IPv4 CONFIGURATION <Show>
 = IPv6 CONFIGURATION <Show>

Automatically connect
 Available to all users

<Cancel>

- Press the **Back** button to return to the main menu.
- Select **Quit**, and press **Enter** to close the **nmtui** application.

Verification

- Display the active connections:

```
# nmcli connection show --active
NAME ID TYPE DEVICE
Office 2501eb7e-7b16-4dc6-97ef-7cc460139a58 wifi wlp0s20f3
```

If the output lists the wifi connection you have created, the connection is active.

- Ping a hostname or IP address:

```
# ping -c 3 example.com
```

11.6. CONFIGURING A WIFI CONNECTION BY USING NM-CONNECTION-EDITOR

You can use the **nm-connection-editor** application to create a connection profile for a wireless network. In this application you can configure all wifi network authentication types that RHEL supports.

By default, NetworkManager enables the auto-connect feature for connection profiles and automatically connects to a saved network if it is available.

Prerequisites

- A wifi device is installed on the host.
- The wifi device is enabled, if it has a hardware switch.

Procedure

1. Open a terminal and enter:

```
# nm-connection-editor
```

2. Click the **+** button to add a new connection.
3. Select the **Wi-Fi** connection type, and click **Create**.
4. Optional: Set a name for the connection profile.
5. Optional: Configure the network profile on the **General** tab to not automatically connect. If you deactivate this feature, you must always manually connect to the network, for example, by using **GNOME settings** or the GNOME system menu.
6. On the **Wi-Fi** tab, enter the service set identifier (SSID) in the **SSID** field.
7. On the **Wi-Fi Security** tab, select the authentication type for the network, such as **WPA3 Personal**, and enter the password. Depending on the selected security, the application shows additional fields. Fill them accordingly. For details, ask the administrator of the wifi network.
8. Configure IPv4 settings on the **IPv4** tab, and IPv6 settings on the **IPv6** tab.
9. Click **Save**.
10. Close the **Network Connections** window.

Verification

1. Open the system menu on the right side of the top bar, and verify that the wifi network is connected:

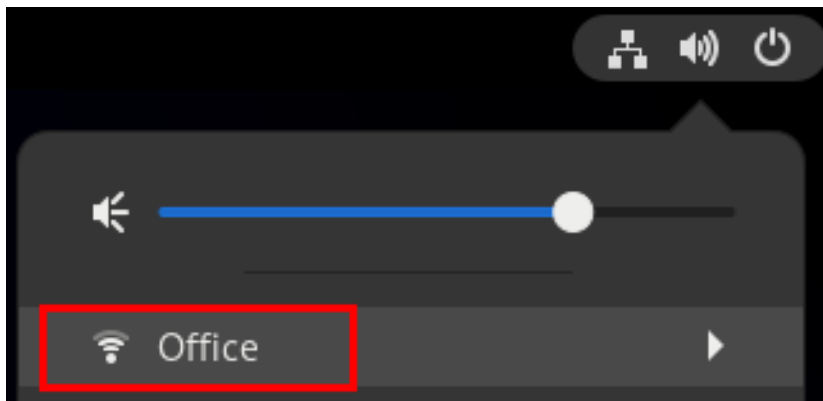

If the network appears in the list, it is connected.

2. Ping a hostname or IP address:

```
# ping -c 3 example.com
```

11.7. CONFIGURING A WIFI CONNECTION WITH 802.1X NETWORK AUTHENTICATION BY USING THE NETWORK RHEL SYSTEM ROLE

Using RHEL system role, you can automate the creation of a wifi connection. For example, you can remotely add a wireless connection profile for the **wlp1s0** interface using an Ansible Playbook. The created profile uses the 802.1X standard to authenticate the client to a wifi network. The playbook configures the connection profile to use DHCP. To configure static IP settings, adapt the parameters in the **ip** dictionary accordingly.

Prerequisites

- [You have prepared the control node and the managed nodes](#)
- You are logged in to the control node as a user who can run playbooks on the managed nodes.
- The account you use to connect to the managed nodes has **sudo** permissions on them.
- The network supports 802.1X network authentication.
- You installed the **wpa_supplicant** package on the managed node.
- DHCP is available in the network of the managed node.
- The following files required for TLS authentication exist on the control node:
 - The client key is stored in the **/srv/data/client.key** file.
 - The client certificate is stored in the **/srv/data/client.crt** file.
 - The CA certificate is stored in the **/srv/data/ca.crt** file.

Procedure

1. Create a playbook file, for example **~/playbook.yml**, with the following content:

```
---
- name: Configure a wifi connection with 802.1X authentication
  hosts: managed-node-01.example.com
  tasks:
    - name: Copy client key for 802.1X authentication
      ansible.builtin.copy:
        src: "/srv/data/client.key"
        dest: "/etc/pki/tls/private/client.key"
        mode: 0400

    - name: Copy client certificate for 802.1X authentication
      ansible.builtin.copy:
        src: "/srv/data/client.crt"
        dest: "/etc/pki/tls/certs/client.crt"

    - name: Copy CA certificate for 802.1X authentication
      ansible.builtin.copy:
        src: "/srv/data/ca.crt"
        dest: "/etc/pki/ca-trust/source/anchors/ca.crt"

    - block:
```

```

- ansible.builtin.import_role:
  name: rhel-system-roles.network
vars:
  network_connections:
  - name: Configure the Example-wifi profile
    interface_name: wlp1s0
    state: up
    type: wireless
    autoconnect: yes
    ip:
      dhcp4: true
      auto6: true
    wireless:
      ssid: "Example-wifi"
      key_mgmt: "wpa-eap"
    ieee802_1x:
      identity: "user_name"
      eap: tls
      private_key: "/etc/pki/tls/client.key"
      private_key_password: "password"
      private_key_password_flags: none
      client_cert: "/etc/pki/tls/client.pem"
      ca_cert: "/etc/pki/tls/cacert.pem"
      domain_suffix_match: "example.com"

```

These settings define a wifi connection profile for the **wlp1s0** interface. The profile uses 802.1X standard to authenticate the client to the wifi network. The connection retrieves IPv4 addresses, IPv6 addresses, default gateway, routes, DNS servers, and search domains from a DHCP server and IPv6 stateless address autoconfiguration (SLAAC).

2. Validate the playbook syntax:

```
$ ansible-playbook --syntax-check ~/playbook.yml
```

Note that this command only validates the syntax and does not protect against a wrong but valid configuration.

3. Run the playbook:

```
$ ansible-playbook ~/playbook.yml
```

Additional resources

- `/usr/share/ansible/roles/rhel-system-roles.network/README.md` file
- `/usr/share/doc/rhel-system-roles/network/` directory

11.8. CONFIGURING A WIFI CONNECTION WITH 802.1X NETWORK AUTHENTICATION IN AN EXISTING PROFILE BY USING NMCLI

Using the **nmcli** utility, you can configure the client to authenticate itself to the network. For example, you can configure Protected Extensible Authentication Protocol (PEAP) authentication with the Microsoft Challenge-Handshake Authentication Protocol version 2 (MSCHAPv2) in an existing NetworkManager wifi connection profile named **wlp1s0**.

Prerequisites

- The network must have 802.1X network authentication.
- The wifi connection profile exists in NetworkManager and has a valid IP configuration.
- If the client is required to verify the certificate of the authenticator, the Certificate Authority (CA) certificate must be stored in the `/etc/pki/ca-trust/source/anchors/` directory.
- The `wpa_supplicant` package is installed.

Procedure

1. Set the wifi security mode to `wpa-eap`, the Extensible Authentication Protocol (EAP) to `peap`, the inner authentication protocol to `mschapv2`, and the user name:

```
# nmcli connection modify wlp1s0 wireless-security.key-mgmt wpa-eap 802-1x.eap
peap 802-1x.phase2-auth mschapv2 802-1x.identity user_name
```

Note that you must set the `wireless-security.key-mgmt`, `802-1x.eap`, `802-1x.phase2-auth`, and `802-1x.identity` parameters in a single command.

2. Optionally, store the password in the configuration:

```
# nmcli connection modify wlp1s0 802-1x.password password
```

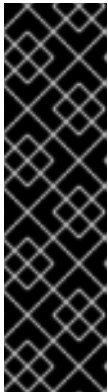

IMPORTANT

By default, NetworkManager stores the password in plain text in the `/etc/sysconfig/network-scripts/keys-connection_name` file, which is readable only by the `root` user. However, plain text passwords in a configuration file can be a security risk.

To increase the security, set the `802-1x.password-flags` parameter to `0x1`. With this setting, on servers with the GNOME desktop environment or the `nm-applet` running, NetworkManager retrieves the password from these services. In other cases, NetworkManager prompts for the password.

3. If the client needs to verify the certificate of the authenticator, set the `802-1x.ca-cert` parameter in the connection profile to the path of the CA certificate:

```
# nmcli connection modify wlp1s0 802-1x.ca-cert /etc/pki/ca-
trust/source/anchors/ca.crt
```



NOTE

For security reasons, Red Hat recommends the certificate of the authenticator to enable clients to validate the identity of the authenticator.

4. Activate the connection profile:

```
# nmcli connection up wlp1s0
```

Verification

- Access resources on the network that require network authentication.

Additional resources

- [Managing wifi connections](#)
- **nm-settings(5)** man page
- **nmcli(1)** man page

11.9. MANUALLY SETTING THE WIRELESS REGULATORY DOMAIN

On RHEL, a **udev** rule executes the **setregdomain** utility to set the wireless regulatory domain. The utility then provides this information to the kernel.

By default, **setregdomain** attempts to determine the country code automatically. If this fails, the wireless regulatory domain setting might be wrong. To work around this problem, you can manually set the country code.

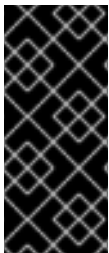

IMPORTANT

Manually setting the regulatory domain disables the automatic detection. Therefore, if you later use the computer in a different country, the previously configured setting might no longer be correct. In this case, remove the **/etc/sysconfig/regdomain** file to switch back to automatic detection or use this procedure to manually update the regulatory domain setting again.

Procedure

1. Optional: Display the current regulatory domain settings:

```
# iw reg get
global
country US: DFS-FCC
...
```

2. Create the **/etc/sysconfig/regdomain** file with the following content:

```
COUNTRY=<country_code>
```

Set the **COUNTRY** variable to an ISO 3166-1 alpha2 country code, such as **DE** for Germany or **US** for the United States of America.

3. Set the regulatory domain:

```
# setregdomain
```

Verification

- Display the regulatory domain settings:

```
# iw reg get
```

global
country *DE: DFS-ETSI*
...

Additional resources

- **setregdomain(1)** man page
- **iw(8)** man page
- **regulatory.bin(5)** man page
- [ISO 3166 Country Codes](#)

CHAPTER 12. CONFIGURING RHEL AS A WPA2 OR WPA3 PERSONAL ACCESS POINT

On a host with a wifi device, you can use NetworkManager to configure this host as an access point. Wi-Fi Protected Access 2 (WPA2) and Wi-Fi Protected Access 3 (WPA3) Personal provide secure authentication methods, and wireless clients can use a pre-shared key (PSK) to connect to the access point and use services on the RHEL host and in the network.

When you configure an access point, NetworkManager automatically:

- Configures the **dnsmasq** service to provide DHCP and DNS services for clients
- Enables IP forwarding
- Adds **nftables** firewall rules to masquerade traffic from the wifi device and configures IP forwarding

Prerequisites

- The wifi device supports running in access point mode.
- The wifi device is not in use.
- The host has internet access.

Procedure

1. List the wifi devices to identify the one that should provide the access point:

```
# nmcli device status | grep wifi
wlp0s20f3 wifi disconnected --
```

2. Verify that the device supports the access point mode:

```
# nmcli -f WIFI-PROPERTIES.AP device show wlp0s20f3
WIFI-PROPERTIES.AP: yes
```

To use a wifi device as an access point, the device must support this feature.

3. Install the **dnsmasq** and **NetworkManager-wifi** packages:

```
# dnf install dnsmasq NetworkManager-wifi
```

NetworkManager uses the **dnsmasq** service to provide DHCP and DNS services to clients of the access point.

4. Create the initial access point configuration:

```
# nmcli device wifi hotspot ifname wlp0s20f3 con-name Example-Hotspot ssid
Example-Hotspot password "password"
```

This command creates a connection profile for an access point on the **wlp0s20f3** device that provides WPA2 and WPA3 Personal authentication. The name of the wireless network, the Service Set Identifier (SSID), is **Example-Hotspot** and uses the pre-shared key **password**.

- Optional: Configure the access point to support only WPA3:

```
# nmcli connection modify Example-Hotspot 802-11-wireless-security.key-mgmt sae
```

- By default, NetworkManager uses the IP address **10.42.0.1** for the wifi device and assigns IP addresses from the remaining **10.42.0.0/24** subnet to clients. To configure a different subnet and IP address, enter:

```
# nmcli connection modify Example-Hotspot ipv4.addresses 192.0.2.254/24
```

The IP address you set, in this case **192.0.2.254**, is the one that NetworkManager assigns to the wifi device. Clients will use this IP address as default gateway and DNS server.

- Activate the connection profile:

```
# nmcli connection up Example-Hotspot
```

Verification

- On the server:
 - Verify that NetworkManager started the **dnsmasq** service and that the service listens on port 67 (DHCP) and 53 (DNS):

```
# ss -tulpn | egrep ":53|:67"
udp UNCONN 0 0 10.42.0.1:53 0.0.0.0:* users:(("dnsmasq",pid=55905,fd=6))
udp UNCONN 0 0 0.0.0.0:67 0.0.0.0:* users:(("dnsmasq",pid=55905,fd=4))
tcp LISTEN 0 32 10.42.0.1:53 0.0.0.0:* users:(("dnsmasq",pid=55905,fd=7))
```

- Display the **nftables** rule set to ensure that NetworkManager enabled forwarding and masquerading for traffic from the **10.42.0.0/24** subnet:

```
# nft list ruleset
table ip nm-shared-wlp0s20f3 {
  chain nat_postrouting {
    type nat hook postrouting priority srcnat; policy accept;
    ip saddr 10.42.0.0/24 ip daddr != 10.42.0.0/24 masquerade
  }

  chain filter_forward {
    type filter hook forward priority filter; policy accept;
    ip daddr 10.42.0.0/24 oifname "wlp0s20f3" ct state { established, related } accept
    ip saddr 10.42.0.0/24 iifname "wlp0s20f3" accept
    iifname "wlp0s20f3" oifname "wlp0s20f3" accept
    iifname "wlp0s20f3" reject
    oifname "wlp0s20f3" reject
  }
}
```

- On a client with a wifi adapter:
 - Display the list of available networks:

```
# nmcli device wifi
```

```
IN-USE BSSID      SSID      MODE CHAN RATE  SIGNAL BARS
SECURITY
    00:53:00:88:29:04 Example-Hotspot Infra 11 130 Mbit/s 62  WPA3
...
```

- b. Connect to the **Example-Hotspot** wireless network. See [Managing Wi-Fi connections](#).
- c. Ping a host on the remote network or the internet to verify that the connection works:

```
# ping -c 3 www.redhat.com
```

Additional resources

- **nm-settings(5)** man page

CHAPTER 13. USING MACSEC TO ENCRYPT LAYER-2 TRAFFIC IN THE SAME PHYSICAL NETWORK

You can use MACsec to secure the communication between two devices (point-to-point). For example, your branch office is connected over a Metro-Ethernet connection with the central office, you can configure MACsec on the two hosts that connect the offices to increase the security.

Media Access Control security (MACsec) is a layer 2 protocol that secures different traffic types over the Ethernet links including:

- dynamic host configuration protocol (DHCP)
- address resolution protocol (ARP)
- Internet Protocol version 4 / 6 (**IPv4 / IPv6**) and
- any traffic over IP such as TCP or UDP

MACsec encrypts and authenticates all traffic in LANs, by default with the GCM-AES-128 algorithm, and uses a pre-shared key to establish the connection between the participant hosts. If you want to change the pre-shared key, you need to update the NM configuration on all hosts in the network that uses MACsec.

A MACsec connection uses an Ethernet device, such as an Ethernet network card, VLAN, or tunnel device, as parent. You can either set an IP configuration only on the MACsec device to communicate with other hosts only using the encrypted connection, or you can also set an IP configuration on the parent device. In the latter case, you can use the parent device to communicate with other hosts using an unencrypted connection and the MACsec device for encrypted connections.

MACsec does not require any special hardware. For example, you can use any switch, except if you want to encrypt traffic only between a host and a switch. In this scenario, the switch must also support MACsec.

In other words, there are 2 common methods to configure MACsec;

- host to host and
- host to switch then switch to other host(s)



IMPORTANT

You can use MACsec only between hosts that are in the same (physical or virtual) LAN.

13.1. CONFIGURING A MACSEC CONNECTION USING NMCLI

You can configure Ethernet interfaces to use MACsec using the **nmcli** utility. For example, you can create a MACsec connection between two hosts that are connected over Ethernet.

Procedure

1. On the first host on which you configure MACsec:
 - Create the connectivity association key (CAK) and connectivity-association key name (CKN) for the pre-shared key:

- a. Create a 16-byte hexadecimal CAK:

```
# dd if=/dev/urandom count=16 bs=1 2> /dev/null | hexdump -e '1/2 "%04x"'
50b71a8ef0bd5751ea76de6d6c98c03a
```

- b. Create a 32-byte hexadecimal CKN:

```
# dd if=/dev/urandom count=32 bs=1 2> /dev/null | hexdump -e '1/2 "%04x"'
f2b4297d39da7330910a74abc0449feb45b5c0b9fc23df1430e1898fcf1c4550
```

2. On both hosts you want to connect over a MACsec connection:
3. Create the MACsec connection:

```
# nmcli connection add type macsec con-name macsec0 ifname macsec0
connection.autoconnect yes macsec.parent enp1s0 macsec.mode psk macsec.mka-
cak 50b71a8ef0bd5751ea76de6d6c98c03a macsec.mka-ckn
f2b4297d39da7330910a74abc0449feb45b5c0b9fc23df1430e1898fcf1c4550
```

Use the CAK and CKN generated in the previous step in the **macsec.mka-cak** and **macsec.mka-ckn** parameters. The values must be the same on every host in the MACsec-protected network.

4. Configure the IP settings on the MACsec connection.
 - a. Configure the **IPv4** settings. For example, to set a static **IPv4** address, network mask, default gateway, and DNS server to the **macsec0** connection, enter:

```
# nmcli connection modify macsec0 ipv4.method manual ipv4.addresses
'192.0.2.1/24' ipv4.gateway '192.0.2.254' ipv4.dns '192.0.2.253'
```

- b. Configure the **IPv6** settings. For example, to set a static **IPv6** address, network mask, default gateway, and DNS server to the **macsec0** connection, enter:

```
# nmcli connection modify macsec0 ipv6.method manual ipv6.addresses
'2001:db8:1::1/32' ipv6.gateway '2001:db8:1::fffe' ipv6.dns '2001:db8:1::fffd'
```

5. Activate the connection:

```
# nmcli connection up macsec0
```

Verification

1. Verify that the traffic is encrypted:

```
# tcpdump -nn -i enp1s0
```

2. Optional: Display the unencrypted traffic:

```
# tcpdump -nn -i macsec0
```

3. Display MACsec statistics:

```
# ip macsec show
```

4. Display individual counters for each type of protection: integrity-only (encrypt off) and encryption (encrypt on)

```
# ip -s macsec show
```

13.2. CONFIGURING A MACSEC CONNECTION USING NMSTATECTL

You can configure Ethernet interfaces to use MACsec through the **nmstatectl** utility in a declarative way. For example, in a YAML file, you describe the desired state of your network, which is supposed to have a MACsec connection between two hosts connected over Ethernet. The **nmstatectl** utility interprets the YAML file and deploys persistent and consistent network configuration across the hosts.

Using the MACsec security standard for securing communication at the link layer, also known as layer 2 of the Open Systems Interconnection (OSI) model provides the following notable benefits:

- Encryption at layer 2 eliminates the need for encrypting individual services at layer 7. This reduces the overhead associated with managing a large number of certificates for each endpoint on each host.
- Point-to-point security between directly connected network devices such as routers and switches.
- No changes needed for applications and higher-layer protocols.

Prerequisites

- A physical or virtual Ethernet Network Interface Controller (NIC) exists in the server configuration.
- The **nmstate** package is installed.

Procedure

1. On the first host on which you configure MACsec, create the connectivity association key (CAK) and connectivity-association key name (CKN) for the pre-shared key:

- a. Create a 16-byte hexadecimal CAK:

```
# dd if=/dev/urandom count=16 bs=1 2> /dev/null | hexdump -e '1/2 "%04x"'
50b71a8ef0bd5751ea76de6d6c98c03a
```

- b. Create a 32-byte hexadecimal CKN:

```
# dd if=/dev/urandom count=32 bs=1 2> /dev/null | hexdump -e '1/2 "%04x"'
f2b4297d39da7330910a74abc0449feb45b5c0b9fc23df1430e1898fcf1c4550
```

2. On both hosts that you want to connect over a MACsec connection, complete the following steps:
 - a. Create a YAML file, for example **create-macsec-connection.yml**, with the following settings:

```

---
routes:
  config:
    - destination: 0.0.0.0/0
      next-hop-interface: macsec0
      next-hop-address: 192.0.2.2
      table-id: 254
    - destination: 192.0.2.2/32
      next-hop-interface: macsec0
      next-hop-address: 0.0.0.0
      table-id: 254
  dns-resolver:
    config:
      search:
        - example.com
      server:
        - 192.0.2.200
        - 2001:db8:1::ffbb
  interfaces:
    - name: macsec0
      type: macsec
      state: up
      ipv4:
        enabled: true
        address:
          - ip: 192.0.2.1
            prefix-length: 32
      ipv6:
        enabled: true
        address:
          - ip: 2001:db8:1::1
            prefix-length: 64
      macsec:
        encrypt: true
        base-iface: enp0s1
        mka-cak: 50b71a8ef0bd5751ea76de6d6c98c03a
        mka-ckn: f2b4297d39da7330910a74abc0449feb45b5c0b9fc23df1430e1898fcf1c4550
        port: 0
        validation: strict
        send-sci: true

```

- b. Use the CAK and CKN generated in the previous step in the **mka-cak** and **mka-ckn** parameters. The values must be the same on every host in the MACsec-protected network.
- c. Optional: In the same YAML configuration file, you can also configure the following settings:
 - A static IPv4 address - **192.0.2.1** with the **/32** subnet mask
 - A static IPv6 address - **2001:db8:1::1** with the **/64** subnet mask
 - An IPv4 default gateway - **192.0.2.2**
 - An IPv4 DNS server - **192.0.2.200**
 - An IPv6 DNS server - **2001:db8:1::ffbb**

- A DNS search domain - **example.com**
3. Apply the settings to the system:

```
# nmstatectl apply create-macsec-connection.yml
```

Verification

1. Display the current state in YAML format:

```
# nmstatectl show macsec0
```

2. Verify that the traffic is encrypted:

```
# tcpdump -nn -i enp0s1
```

3. Optional: Display the unencrypted traffic:

```
# tcpdump -nn -i macsec0
```

4. Display MACsec statistics:

```
# ip macsec show
```

5. Display individual counters for each type of protection: integrity-only (encrypt off) and encryption (encrypt on)

```
# ip -s macsec show
```

Additional resources

- [MACsec: a different solution to encrypt network traffic](#)

13.3. ADDITIONAL RESOURCES

- [MACsec: a different solution to encrypt network traffic](#) blog.

CHAPTER 14. GETTING STARTED WITH IPVLAN

IPVLAN is a driver for a virtual network device that can be used in container environment to access the host network. IPVLAN exposes a single MAC address to the external network regardless the number of IPVLAN device created inside the host network. This means that a user can have multiple IPVLAN devices in multiple containers and the corresponding switch reads a single MAC address. IPVLAN driver is useful when the local switch imposes constraints on the total number of MAC addresses that it can manage.

14.1. IPVLAN MODES

The following modes are available for IPVLAN:

- L2 mode**
 In IPVLAN **L2 mode**, virtual devices receive and respond to address resolution protocol (ARP) requests. The **netfilter** framework runs only inside the container that owns the virtual device. No **netfilter** chains are executed in the default namespace on the containerized traffic. Using **L2 mode** provides good performance, but less control on the network traffic.
- L3 mode**
 In **L3 mode**, virtual devices process only **L3** traffic and above. Virtual devices do not respond to ARP request and users must configure the neighbour entries for the IPVLAN IP addresses on the relevant peers manually. The egress traffic of a relevant container is landed on the **netfilter** POSTROUTING and OUTPUT chains in the default namespace while the ingress traffic is threaded in the same way as **L2 mode**. Using **L3 mode** provides good control but decreases the network traffic performance.
- L3S mode**
 In **L3S mode**, virtual devices process the same way as in **L3 mode**, except that both egress and ingress traffics of a relevant container are landed on **netfilter** chain in the default namespace. **L3S mode** behaves in a similar way to **L3 mode** but provides greater control of the network.



NOTE

The IPVLAN virtual device does not receive broadcast and multicast traffic in case of **L3** and **L3S** modes.

14.2. COMPARISON OF IPVLAN AND MACVLAN

The following table shows the major differences between MACVLAN and IPVLAN:

MACVLAN	IPVLAN
<p>Uses MAC address for each MACVLAN device.</p> <p>Note that, if a switch reaches the maximum number of MAC addresses it can store in its MAC table, connectivity can be lost.</p>	<p>Uses single MAC address which does not limit the number of IPVLAN devices.</p>
<p>Netfilter rules for a global namespace cannot affect traffic to or from a MACVLAN device in a child namespace.</p>	<p>It is possible to control traffic to or from a IPVLAN device in L3 mode and L3S mode.</p>

Both IPVLAN and MACVLAN do not require any level of encapsulation.

14.3. CREATING AND CONFIGURING THE IPVLAN DEVICE USING IPROUTE2

This procedure shows how to set up the IPVLAN device using **iproute2**.

Procedure

1. To create an IPVLAN device, enter the following command:

```
# ip link add link real_NIC_device name IPVLAN_device type ipvlan mode I2
```

Note that network interface controller (NIC) is a hardware component which connects a computer to a network.

Example 14.1. Creating an IPVLAN device

```
# ip link add link enp0s31f6 name my_ipvlan type ipvlan mode I2
# ip link
47: my_ipvlan@enp0s31f6: <BROADCAST,MULTICAST> mtu 1500 qdisc noop state
DOWN mode DEFAULT group default qlen 1000 link/ether e8:6a:6e:8a:a2:44 brd
ff:ff:ff:ff:ff:ff
```

2. To assign an **IPv4** or **IPv6** address to the interface, enter the following command:

```
# ip addr add dev IPVLAN_device IP_address/subnet_mask_prefix
```

3. In case of configuring an IPVLAN device in **L3 mode** or **L3S mode**, make the following setups:

- a. Configure the neighbor setup for the remote peer on the remote host:

```
# ip neigh add dev peer_device IPVLAN_device_IP_address lladdr MAC_address
```

where *MAC_address* is the MAC address of the real NIC on which an IPVLAN device is based on.

- b. Configure an IPVLAN device for **L3 mode** with the following command:

```
# ip route add dev <real_NIC_device> <peer_IP_address/32>
```

For **L3S mode**:

```
# ip route add dev real_NIC_device peer_IP_address/32
```

where IP-address represents the address of the remote peer.

4. To set an IPVLAN device active, enter the following command:

```
# ip link set dev IPVLAN_device up
```

5. To check if the IPVLAN device is active, execute the following command on the remote host:

```
# ping IP_address
```

where the *IP_address* uses the IP address of the IPVLAN device.

CHAPTER 15. CONFIGURING NETWORKMANAGER TO IGNORE CERTAIN DEVICES

By default, NetworkManager manages all devices. To ignore certain devices, you can configure NetworkManager by setting as **unmanaged**.

15.1. CONFIGURING THE LOOPBACK INTERFACE BY USING NMCLI

By default, NetworkManager does not manage the loopback (**lo**) interface. After creating a connection profile for the **lo** interface, you can configure this device by using NetworkManager. Some of the examples are as follows:

- Assign additional IP addresses to the **lo** interface
- Define DNS addresses
- Change the Maximum Transmission Unit (MTU) size of the **lo** interface

Procedure

1. Create a new connection of type **loopback**:

```
# nmcli connection add con-name example-loopback type loopback
```

2. Configure custom connection settings, for example:

- a. To assign an additional IP address to the interface, enter:

```
# nmcli connection modify example-loopback +ipv4.addresses 192.0.2.1/24
```



NOTE

NetworkManager manages the **lo** interface by always assigning the IP addresses **127.0.0.1** and **::1** that are persistent across the reboots. You can not override **127.0.0.1** and **::1**. However, you can assign additional IP addresses to the interface.

- b. To set a custom Maximum Transmission Unit (MTU), enter:

```
# nmcli con mod example-loopback loopback.mtu 16384
```

- c. To set an IP address to your DNS server, enter:

```
# nmcli connection modify example-loopback ipv4.dns 192.0.2.0
```

If you set a DNS server in the loopback connection profile, this entry is always available in the **/etc/resolv.conf** file. The DNS server entry remains independent of whether or not the host roams between different networks.

3. Activate the connection:

```
# nmcli connection up example-loopback
```

Verification

1. Display the settings of the **lo** interface:

```
# ip address show lo
```

```
1: lo: <LOOPBACK,UP,LOWER_UP> mtu 16384 qdisc noqueue state UNKNOWN group
default qlen 1000
```

```
link/loopback 00:00:00:00:00:00 brd 00:00:00:00:00:00 inet 127.0.0.1/8 scope host lo valid_lft
forever preferred_lft forever inet 192.0.2.1/24 brd 192.0.2.255 scope global lo valid_lft forever
preferred_lft forever
```

```
inet6 ::1/128 scope host
valid_lft forever preferred_lft forever
```

2. Verify the DNS address:

```
# cat /etc/resolv.conf
```

```
...
```

```
nameserver 192.0.2.0
```

```
...
```

15.2. PERMANENTLY CONFIGURING A DEVICE AS UNMANAGED IN NETWORKMANAGER

You can permanently configure devices as **unmanaged** based on several criteria, such as the interface name, MAC address, or device type.

To temporarily configure network devices as **unmanaged**, see [Temporarily configuring a device as unmanaged in NetworkManager](#).

Procedure

1. Optional: Display the list of devices to identify the device or MAC address you want to set as **unmanaged**:

```
# ip link show
```

```
...
```

```
2: enp1s0: <BROADCAST,MULTICAST,UP,LOWER_UP> mtu 1500 qdisc fq_codel state UP
mode DEFAULT group default qlen 1000
```

```
link/ether 52:54:00:74:79:56 brd ff:ff:ff:ff:ff:ff
```

```
...
```

2. Create the `/etc/NetworkManager/conf.d/99-unmanaged-devices.conf` file with the following content:

- To configure a specific interface as unmanaged, add:

```
[keyfile]
```

```
unmanaged-devices=interface-name:enp1s0
```

- To configure a device with a specific MAC address as unmanaged, add:

```
[keyfile]
unmanaged-devices=mac:52:54:00:74:79:56
```

- To configure all devices of a specific type as unmanaged, add:

```
[keyfile]
unmanaged-devices=type:ethernet
```

- To set multiple devices as unmanaged, separate the entries in the **unmanaged-devices** parameter with a semicolon, for example:

```
[keyfile]
unmanaged-devices=interface-name:enp1s0;interface-name:enp7s0
```

3. Reload the **NetworkManager** service:

```
# systemctl reload NetworkManager
```

Verification

- Display the list of devices:

```
# nmcli device status
DEVICE TYPE STATE CONNECTION
enp1s0 ethernet unmanaged --
...
```

The **unmanaged** state next to the **enp1s0** device indicates that NetworkManager does not manage this device.

Troubleshooting

- If the device is not shown as **unmanaged**, display the NetworkManager configuration:

```
# NetworkManager --print-config
...
[keyfile]
unmanaged-devices=interface-name:enp1s0
...
```

If the output does not match the settings that you configured, ensure that no configuration file with a higher priority overrides your settings. For details about how NetworkManager merges multiple configuration files, see the **NetworkManager.conf(5)** man page.

15.3. TEMPORARILY CONFIGURING A DEVICE AS UNMANAGED IN NETWORKMANAGER

You can temporarily configure devices as **unmanaged**.

Use this method, for example, for testing purposes. To permanently configure network devices as **unmanaged**, see [Permanently configuring a device as unmanaged in NetworkManager](#) .

Procedure

Procedure

1. Optional: Display the list of devices to identify the device you want to set as **unmanaged**:

```
# nmcli device status
DEVICE TYPE   STATE   CONNECTION
enp1s0 ethernet disconnected --
...
```

2. Set the **enp1s0** device to the **unmanaged** state:

```
# nmcli device set enp1s0 managed no
```

Verification

- Display the list of devices:

```
# nmcli device status
DEVICE TYPE   STATE   CONNECTION
enp1s0 ethernet unmanaged --
...
```

The **unmanaged** state next to the **enp1s0** device indicates that NetworkManager does not manage this device.

Additional resources

- **NetworkManager.conf(5)** man page

CHAPTER 16. CREATING A DUMMY INTERFACE

As a Red Hat Enterprise Linux user, you can create and use dummy network interfaces for debugging and testing purposes. A dummy interface provides a device to route packets without actually transmitting them. It enables you to create additional loopback-like devices managed by NetworkManager and makes an inactive SLIP (Serial Line Internet Protocol) address look like a real address for local programs.

16.1. CREATING A DUMMY INTERFACE WITH BOTH AN IPV4 AND IPV6 ADDRESS USING NMCLI

You can create a dummy interface with various settings, such as IPv4 and IPv6 addresses. After creating the interface, NetworkManager automatically assigns it to the default **public firewalld** zone.

Procedure

- Create a dummy interface named **dummy0** with static IPv4 and IPv6 addresses:

```
# nmcli connection add type dummy ifname dummy0 ipv4.method manual
  ipv4.addresses 192.0.2.1/24 ipv6.method manual ipv6.addresses 2001:db8:2::1/64
```



NOTE

To configure a dummy interface without IPv4 and IPv6 addresses, set both the **ipv4.method** and **ipv6.method** parameters to **disabled**. Otherwise, IP auto-configuration fails, and NetworkManager deactivates the connection and removes the device.

Verification

- List the connection profiles:

```
# nmcli connection show
NAME          UUID                                  TYPE  DEVICE
dummy-dummy0  aaf6eb56-73e5-4746-9037-eed42caa8a65  dummy  dummy0
```

Additional resources

- **nm-settings(5)** man page

CHAPTER 17. USING NETWORKMANAGER TO DISABLE IPV6 FOR A SPECIFIC CONNECTION

On a system that uses NetworkManager to manage network interfaces, you can disable the IPv6 protocol if the network only uses IPv4. If you disable **IPv6**, NetworkManager automatically sets the corresponding **sysctl** values in the Kernel.

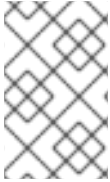

NOTE

If disabling IPv6 using kernel tunables or kernel boot parameters, additional consideration must be given to system configuration. For more information, see the [How do I disable or enable the IPv6 protocol in RHEL?](#) article.

17.1. DISABLING IPV6 ON A CONNECTION USING NMCLI

You can use the **nmcli** utility to disable the **IPv6** protocol on the command line.

Prerequisites

- The system uses NetworkManager to manage network interfaces.

Procedure

1. Optionally, display the list of network connections:

```
# nmcli connection show
NAME UUID TYPE DEVICE
Example 7a7e0151-9c18-4e6f-89ee-65bb2d64d365 ethernet enp1s0
...
```

2. Set the **ipv6.method** parameter of the connection to **disabled**:

```
# nmcli connection modify Example ipv6.method "disabled"
```

3. Restart the network connection:

```
# nmcli connection up Example
```

Verification

1. Display the IP settings of the device:

```
# ip address show enp1s0
2: enp1s0: <BROADCAST,MULTICAST,UP,LOWER_UP> mtu 1500 qdisc fq_codel state UP
group default qlen 1000
link/ether 52:54:00:6b:74:be brd ff:ff:ff:ff:ff:ff
inet 192.0.2.1/24 brd 192.10.2.255 scope global noprefixroute enp1s0
valid_lft forever preferred_lft forever
```

If no **inet6** entry is displayed, **IPv6** is disabled on the device.

2. Verify that the `/proc/sys/net/ipv6/conf/enp1s0/disable_ipv6` file now contains the value **1**:

```
# cat /proc/sys/net/ipv6/conf/enp1s0/disable_ipv6  
1
```

The value **1** means that **IPv6** is disabled for the device.

CHAPTER 18. CHANGING A HOSTNAME

The hostname of a system is the name on the system itself. You can set the name when you install RHEL, and you can change it afterwards.

18.1. CHANGING A HOSTNAME USING NMCLI

You can use the **nmcli** utility to update the system hostname. Note that other utilities might use a different term, such as static or persistent hostname.

Procedure

1. Optional: Display the current hostname setting:

```
# nmcli general hostname  
old-hostname.example.com
```

2. Set the new hostname:

```
# nmcli general hostname new-hostname.example.com
```

3. NetworkManager automatically restarts the **systemd-hostnamed** to activate the new name. For the changes to take effect, reboot the host:

```
# reboot
```

Alternatively, if you know which services use the hostname:

- a. Restart all services that only read the hostname when the service starts:

```
# systemctl restart <service_name>
```

- b. Active shell users must re-login for the changes to take effect.

Verification

- Display the hostname:

```
# nmcli general hostname  
new-hostname.example.com
```

18.2. CHANGING A HOSTNAME USING HOSTNAMECTL

You can use the **hostnamectl** utility to update the hostname. By default, this utility sets the following hostname types:

- Static hostname: Stored in the **/etc/hostname** file. Typically, services use this name as the hostname.
- Pretty hostname: A descriptive name, such as **Proxy server in data center A**.
- Transient hostname: A fall-back value that is typically received from the network configuration.

Procedure

1. Optional: Display the current hostname setting:

```
# hostnamectl status --static  
old-hostname.example.com
```

2. Set the new hostname:

```
# hostnamectl set-hostname new-hostname.example.com
```

This command sets the static, pretty, and transient hostname to the new value. To set only a specific type, pass the **--static**, **--pretty**, or **--transient** option to the command.

3. The **hostnamectl** utility automatically restarts the **systemd-hostnamed** to activate the new name. For the changes to take effect, reboot the host:

```
# reboot
```

Alternatively, if you know which services use the hostname:

- a. Restart all services that only read the hostname when the service starts:

```
# systemctl restart <service_name>
```

- b. Active shell users must re-login for the changes to take effect.

Verification

- Display the hostname:

```
# hostnamectl status --static  
new-hostname.example.com
```

Additional resources

- **hostnamectl(1)**
- **systemd-hostnamed.service(8)**

CHAPTER 19. CONFIGURING NETWORKMANAGER DHCP SETTINGS

NetworkManager provides different configuration options related to DHCP. For example, you can configure NetworkManager to use the build-in DHCP client (default) or an external client, and you can influence DHCP settings of individual profiles.

19.1. CHANGING THE DHCP CLIENT OF NETWORKMANAGER

By default, NetworkManager uses its internal DHCP client. However, if you require a DHCP client with features that the built-in client does not provide, you can alternatively configure NetworkManager to use **dhclient**.

Note that RHEL does not provide **dhcpcd** and, therefore, NetworkManager can not use this client.

Procedure

1. Create the `/etc/NetworkManager/conf.d/dhcp-client.conf` file with the following content:

```
[main]
dhcp=dhclient
```

You can set the **dhcp** parameter to **internal** (default) or **dhclient**.

2. If you set the **dhcp** parameter to **dhclient**, install the **dhcp-client** package:

```
# dnf install dhcp-client
```

3. Restart NetworkManager:

```
# systemctl restart NetworkManager
```

Note that the restart temporarily interrupts all network connections.

Verification

- Search in the `/var/log/messages` log file for an entry similar to the following:

```
Apr 26 09:54:19 server NetworkManager[27748]: <info> [1650959659.8483] dhcp-init: Using DHCP client 'dhclient'
```

This log entry confirms that NetworkManager uses **dhclient** as DHCP client.

Additional resources

- **NetworkManager.conf(5)** man page

19.2. CONFIGURING THE DHCP BEHAVIOR OF A NETWORKMANAGER CONNECTION

A Dynamic Host Configuration Protocol (DHCP) client requests the dynamic IP address and corresponding configuration information from a DHCP server each time a client connects to the network.

When you configured a connection to retrieve an IP address from a DHCP server, the NetworkManager requests an IP address from a DHCP server. By default, the client waits 45 seconds for this request to be completed. When a **DHCP** connection is started, a dhcp client requests an IP address from a **DHCP** server.

Prerequisites

- A connection that uses DHCP is configured on the host.

Procedure

1. Set the **ipv4.dhcp-timeout** and **ipv6.dhcp-timeout** properties. For example, to set both options to **30** seconds, enter:

```
# nmcli connection modify connection_name ipv4.dhcp-timeout 30 ipv6.dhcp-timeout 30
```

Alternatively, set the parameters to **infinity** to configure that NetworkManager does not stop trying to request and renew an IP address until it is successful.

2. Optional: Configure the behavior if NetworkManager does not receive an IPv4 address before the timeout:

```
# nmcli connection modify connection_name ipv4.may-fail value
```

If you set the **ipv4.may-fail** option to:

- **yes**, the status of the connection depends on the IPv6 configuration:
 - If the IPv6 configuration is enabled and successful, NetworkManager activates the IPv6 connection and no longer tries to activate the IPv4 connection.
 - If the IPv6 configuration is disabled or not configured, the connection fails.
 - **no**, the connection is deactivated. In this case:
 - If the **autoconnect** property of the connection is enabled, NetworkManager retries to activate the connection as many times as set in the **autoconnect-retries** property. The default is **4**.
 - If the connection still cannot acquire a DHCP address, auto-activation fails. Note that after 5 minutes, the auto-connection process starts again to acquire an IP address from the DHCP server.
3. Optional: Configure the behavior if NetworkManager does not receive an IPv6 address before the timeout:

```
# nmcli connection modify connection_name ipv6.may-fail value
```

Additional resources

- **nm-settings(5)** man page

CHAPTER 20. RUNNING DHCLIENT EXIT HOOKS USING NETWORKMANAGER A DISPATCHER SCRIPT

You can use a NetworkManager dispatcher script to execute **dhclient** exit hooks.

20.1. THE CONCEPT OF NETWORKMANAGER DISPATCHER SCRIPTS

The **NetworkManager-dispatcher** service executes user-provided scripts in alphabetical order when network events happen. These scripts are typically shell scripts, but can be any executable script or application. You can use dispatcher scripts, for example, to adjust network-related settings that you cannot manage with NetworkManager.

You can store dispatcher scripts in the following directories:

- **/etc/NetworkManager/dispatcher.d/**: The general location for dispatcher scripts the **root** user can edit.
- **/usr/lib/NetworkManager/dispatcher.d/**: For pre-deployed immutable dispatcher scripts.

For security reasons, the **NetworkManager-dispatcher** service executes scripts only if the following conditions met:

- The script is owned by the **root** user.
- The script is only readable and writable by **root**.
- The **setuid** bit is not set on the script.

The **NetworkManager-dispatcher** service runs each script with two arguments:

1. The interface name of the device the operation happened on.
2. The action, such as **up**, when the interface has been activated.

The **Dispatcher scripts** section in the **NetworkManager(8)** man page provides an overview of actions and environment variables you can use in scripts.

The **NetworkManager-dispatcher** service runs one script at a time, but asynchronously from the main NetworkManager process. Note that, if a script is queued, the service will always run it, even if a later event makes it obsolete. However, the **NetworkManager-dispatcher** service runs scripts that are symbolic links referring to files in **/etc/NetworkManager/dispatcher.d/no-wait.d/** immediately, without waiting for the termination of previous scripts, and in parallel.

Additional resources

- **NetworkManager(8)** man page

20.2. CREATING A NETWORKMANAGER DISPATCHER SCRIPT THAT RUNS DHCLIENT EXIT HOOKS

When a DHCP server assigns or updates an IPv4 address, NetworkManager can run a dispatcher script stored in the **/etc/dhcp/dhclient-exit-hooks.d/** directory. This dispatcher script can then, for example, run **dhclient** exit hooks.

Prerequisites

Prerequisites

- The **dhclient** exit hooks are stored in the `/etc/dhcp/dhclient-exit-hooks.d/` directory.

Procedure

1. Create the `/etc/NetworkManager/dispatcher.d/12-dhclient-down` file with the following content:

```
#!/bin/bash
# Run dhclient.exit-hooks.d scripts

if [ -n "$DHCP4_DHCP_LEASE_TIME" ]; then
  if [ "$2" = "dhcp4-change" ] || [ "$2" = "up" ]; then
    if [ -d /etc/dhcp/dhclient-exit-hooks.d ]; then
      for f in /etc/dhcp/dhclient-exit-hooks.d/*.sh ; do
        if [ -x "$f" ]; then
          . "$f"
        fi
      done
    fi
  fi
fi
```

2. Set the **root** user as owner of the file:

```
# chown root:root /etc/NetworkManager/dispatcher.d/12-dhclient-down
```

3. Set the permissions so that only the root user can execute it:

```
# chmod 0700 /etc/NetworkManager/dispatcher.d/12-dhclient-down
```

4. Restore the SELinux context:

```
# restorecon /etc/NetworkManager/dispatcher.d/12-dhclient-down
```

Additional resources

- **NetworkManager(8)** man page

CHAPTER 21. MANUALLY CONFIGURING THE /ETC/RESOLV.CONF FILE

By default, NetworkManager dynamically updates the `/etc/resolv.conf` file with the DNS settings from active NetworkManager connection profiles. However, you can disable this behavior and manually configure DNS settings in `/etc/resolv.conf`.



NOTE

Alternatively, if you require a specific order of DNS servers in `/etc/resolv.conf`, see [Configuring the order of DNS servers](#).

21.1. DISABLING DNS PROCESSING IN THE NETWORKMANAGER CONFIGURATION

By default, NetworkManager manages DNS settings in the `/etc/resolv.conf` file, and you can configure the order of DNS servers. Alternatively, you can disable DNS processing in NetworkManager if you prefer to manually configure DNS settings in `/etc/resolv.conf`.

Procedure

1. As the root user, create the `/etc/NetworkManager/conf.d/90-dns-none.conf` file with the following content by using a text editor:

```
[main]
dns=none
```

2. Reload the **NetworkManager** service:

```
# systemctl reload NetworkManager
```

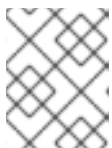

NOTE

After you reload the service, NetworkManager no longer updates the `/etc/resolv.conf` file. However, the last contents of the file are preserved.

3. Optionally, remove the **Generated by NetworkManager** comment from `/etc/resolv.conf` to avoid confusion.

Verification

1. Edit the `/etc/resolv.conf` file and manually update the configuration.
2. Reload the **NetworkManager** service:

```
# systemctl reload NetworkManager
```

3. Display the `/etc/resolv.conf` file:

```
# cat /etc/resolv.conf
```

If you successfully disabled DNS processing, NetworkManager did not override the manually configured settings.

Troubleshooting

- Display the NetworkManager configuration to ensure that no other configuration file with a higher priority overrode the setting:

```
# NetworkManager --print-config
...
dns=none
...
```

Additional resources

- **NetworkManager.conf(5)** man page
- [Configuring the order of DNS servers using NetworkManager](#)

21.2. REPLACING /ETC/RESOLV.CONF WITH A SYMBOLIC LINK TO MANUALLY CONFIGURE DNS SETTINGS

By default, NetworkManager manages DNS settings in the `/etc/resolv.conf` file, and you can configure the order of DNS servers. Alternatively, you can disable DNS processing in NetworkManager if you prefer to manually configure DNS settings in `/etc/resolv.conf`. For example, NetworkManager does not automatically update the DNS configuration if `/etc/resolv.conf` is a symbolic link.

Prerequisites

- The NetworkManager **rc-manager** configuration option is not set to **file**. To verify, use the **NetworkManager --print-config** command.

Procedure

1. Create a file, such as `/etc/resolv.conf.manually-configured`, and add the DNS configuration for your environment to it. Use the same parameters and syntax as in the original `/etc/resolv.conf`.
2. Remove the `/etc/resolv.conf` file:

```
# rm /etc/resolv.conf
```

3. Create a symbolic link named `/etc/resolv.conf` that refers to `/etc/resolv.conf.manually-configured`:

```
# ln -s /etc/resolv.conf.manually-configured /etc/resolv.conf
```

Additional resources

- **resolv.conf(5)** man page
- **NetworkManager.conf(5)** man page
- [Configuring the order of DNS servers using NetworkManager](#)

CHAPTER 22. CONFIGURING THE ORDER OF DNS SERVERS

Most applications use the `getaddrinfo()` function of the `glibc` library to resolve DNS requests. By default, `glibc` sends all DNS requests to the first DNS server specified in the `/etc/resolv.conf` file. If this server does not reply, RHEL uses the next server in this file. NetworkManager enables you to influence the order of DNS servers in `etc/resolv.conf`.

22.1. HOW NETWORKMANAGER ORDERS DNS SERVERS IN /ETC/RESOLV.CONF

NetworkManager orders DNS servers in the `/etc/resolv.conf` file based on the following rules:

- If only one connection profile exists, NetworkManager uses the order of IPv4 and IPv6 DNS server specified in that connection.
- If multiple connection profiles are activated, NetworkManager orders DNS servers based on a DNS priority value. If you set DNS priorities, the behavior of NetworkManager depends on the value set in the `dns` parameter. You can set this parameter in the `[main]` section in the `/etc/NetworkManager/NetworkManager.conf` file:

- **dns=default** or if the `dns` parameter is not set:
NetworkManager orders the DNS servers from different connections based on the `ipv4.dns-priority` and `ipv6.dns-priority` parameter in each connection.

If you set no value or you set `ipv4.dns-priority` and `ipv6.dns-priority` to `0`, NetworkManager uses the global default value. See [Default values of DNS priority parameters](#).

- **dns=dnsmasq** or **dns=systemd-resolved**:
When you use one of these settings, NetworkManager sets either `127.0.0.1` for `dnsmasq` or `127.0.0.53` as `nameserver` entry in the `/etc/resolv.conf` file.

Both the `dnsmasq` and `systemd-resolved` services forward queries for the search domain set in a NetworkManager connection to the DNS server specified in that connection, and forwards queries to other domains to the connection with the default route. When multiple connections have the same search domain set, `dnsmasq` and `systemd-resolved` forward queries for this domain to the DNS server set in the connection with the lowest priority value.

Default values of DNS priority parameters

NetworkManager uses the following default values for connections:

- **50** for VPN connections
- **100** for other connections

Valid DNS priority values:

You can set both the global default and connection-specific `ipv4.dns-priority` and `ipv6.dns-priority` parameters to a value between `-2147483647` and `2147483647`.

- A lower value has a higher priority.
- Negative values have the special effect of excluding other configurations with a greater value. For example, if at least one connection with a negative priority value exists, NetworkManager uses only the DNS servers specified in the connection profile with the lowest priority.

- If multiple connections have the same DNS priority, NetworkManager prioritizes the DNS in the following order:
 - a. VPN connections
 - b. Connection with an active default route. The active default route is the default route with the lowest metric.

Additional resources

- **nm-settings(5)** man page
- [Using different DNS servers for different domains](#)

22.2. SETTING A NETWORKMANAGER-WIDE DEFAULT DNS SERVER PRIORITY VALUE

NetworkManager uses the following DNS priority default values for connections:

- **50** for VPN connections
- **100** for other connections

You can override these system-wide defaults with a custom default value for IPv4 and IPv6 connections.

Procedure

1. Edit the `/etc/NetworkManager/NetworkManager.conf` file:
 - a. Add the **[connection]** section, if it does not exist:

```
[connection]
```

- b. Add the custom default values to the **[connection]** section. For example, to set the new default for both IPv4 and IPv6 to **200**, add:

```
ipv4.dns-priority=200
ipv6.dns-priority=200
```

You can set the parameters to a value between **-2147483647** and **2147483647**. Note that setting the parameters to **0** enables the built-in defaults (**50** for VPN connections and **100** for other connections).

2. Reload the **NetworkManager** service:

```
# systemctl reload NetworkManager
```

Additional resources

- **NetworkManager.conf(5)** man page

22.3. SETTING THE DNS PRIORITY OF A NETWORKMANAGER CONNECTION

If you require a specific order of DNS servers you can set priority values in connection profiles. NetworkManager uses these values to order the servers when the service creates or updates the `/etc/resolv.conf` file.

Note that setting DNS priorities makes only sense if you have multiple connections with different DNS servers configured. If you have only one connection with multiple DNS servers configured, manually set the DNS servers in the preferred order in the connection profile.

Prerequisites

- The system has multiple NetworkManager connections configured.
- The system either has no `dns` parameter set in the `/etc/NetworkManager/NetworkManager.conf` file or the parameter is set to `default`.

Procedure

1. Optionally, display the available connections:

```
# nmcli connection show
NAME      UUID                                  TYPE  DEVICE
Example_con_1 d17ee488-4665-4de2-b28a-48befab0cd43 ethernet enp1s0
Example_con_2 916e4f67-7145-3ffa-9f7b-e7cada8f6bf7 ethernet enp7s0
...
```

2. Set the `ipv4.dns-priority` and `ipv6.dns-priority` parameters. For example, to set both parameters to `10` for the `Example_con_1` connection:

```
# nmcli connection modify Example_con_1 ipv4.dns-priority 10 ipv6.dns-priority 10
```

3. Optionally, repeat the previous step for other connections.
4. Re-activate the connection you updated:

```
# nmcli connection up Example_con_1
```

Verification

- Display the contents of the `/etc/resolv.conf` file to verify that the DNS server order is correct:

```
# cat /etc/resolv.conf
```

CHAPTER 23. USING DIFFERENT DNS SERVERS FOR DIFFERENT DOMAINS

By default, Red Hat Enterprise Linux (RHEL) sends all DNS requests to the first DNS server specified in the **/etc/resolv.conf** file. If this server does not reply, RHEL uses the next server in this file. In environments where one DNS server cannot resolve all domains, administrators can configure RHEL to send DNS requests for a specific domain to a selected DNS server.

For example, you connect a server to a Virtual Private Network (VPN), and hosts in the VPN use the **example.com** domain. In this case, you can configure RHEL to process DNS queries in the following way:

- Send only DNS requests for **example.com** to the DNS server in the VPN network.
- Send all other requests to the DNS server that is configured in the connection profile with the default gateway.

23.1. USING DNSMASQ IN NETWORKMANAGER TO SEND DNS REQUESTS FOR A SPECIFIC DOMAIN TO A SELECTED DNS SERVER

You can configure NetworkManager to start an instance of **dnsmasq**. This DNS caching server then listens on port **53** on the **loopback** device. Consequently, this service is only reachable from the local system and not from the network.

With this configuration, NetworkManager adds the **nameserver 127.0.0.1** entry to the **/etc/resolv.conf** file, and **dnsmasq** dynamically routes DNS requests to the corresponding DNS servers specified in the NetworkManager connection profiles.

Prerequisites

- The system has multiple NetworkManager connections configured.
- A DNS server and search domain are configured in the NetworkManager connection profile that is responsible for resolving a specific domain.
For example, to ensure that the DNS server specified in a VPN connection resolves queries for the **example.com** domain, the VPN connection profile must contain the following settings:
 - A DNS server that can resolve **example.com**
 - A search domain set to **example.com** in the **ipv4.dns-search** and **ipv6.dns-search** parameters
- The **dnsmasq** service is not running or configured to listen on a different interface than **localhost**.

Procedure

1. Install the **dnsmasq** package:

```
# dnf install dnsmasq
```

2. Edit the **/etc/NetworkManager/NetworkManager.conf** file, and set the following entry in the **[main]** section:

```
dns=dnsmasq
```

3. Reload the **NetworkManager** service:

```
# systemctl reload NetworkManager
```

Verification

1. Search in the **systemd** journal of the **NetworkManager** unit for which domains the service uses a different DNS server:

```
# journalctl -xeu NetworkManager
...
Jun 02 13:30:17 client_hostname dnsmasq[5298]: using nameserver 198.51.100.7#53 for
domain example.com
...
```

2. Use the **tcpdump** packet sniffer to verify the correct route of DNS requests:

- a. Install the **tcpdump** package:

```
# dnf install tcpdump
```

- b. On one terminal, start **tcpdump** to capture DNS traffic on all interfaces:

```
# tcpdump -i any port 53
```

- c. On a different terminal, resolve host names for a domain for which an exception exists and another domain, for example:

```
# host -t A www.example.com
# host -t A www.redhat.com
```

- d. Verify in the **tcpdump** output that Red Hat Enterprise Linux sends only DNS queries for the **example.com** domain to the designated DNS server and through the corresponding interface:

```
...
13:52:42.234533 tun0 Out IP server.43534 > 198.51.100.7.domain: 50121+ A?
www.example.com. (33)
...
13:52:57.753235 enp1s0 Out IP server.40864 > 192.0.2.1.domain: 6906+ A?
www.redhat.com. (33)
...
```

Red Hat Enterprise Linux sends the DNS query for **www.example.com** to the DNS server on **198.51.100.7** and the query for **www.redhat.com** to **192.0.2.1**.

Troubleshooting

1. Verify that the **nameserver** entry in the **/etc/resolv.conf** file refers to **127.0.0.1**:

```
# cat /etc/resolv.conf
nameserver 127.0.0.1
```

If the entry is missing, check the **dns** parameter in the **/etc/NetworkManager/NetworkManager.conf** file.

2. Verify that the **dnsmasq** service listens on port **53** on the **loopback** device:

```
# ss -tulpn | grep "127.0.0.1:53"
udp UNCONN 0 0 127.0.0.1:53 0.0.0.0:* users:(("dnsmasq",pid=7340,fd=18))
tcp LISTEN 0 32 127.0.0.1:53 0.0.0.0:* users:(("dnsmasq",pid=7340,fd=19))
```

If the service does not listen on **127.0.0.1:53**, check the journal entries of the **NetworkManager** unit:

```
# journalctl -u NetworkManager
```

23.2. USING SYSTEMD-RESOLVED IN NETWORKMANAGER TO SEND DNS REQUESTS FOR A SPECIFIC DOMAIN TO A SELECTED DNS SERVER

You can configure NetworkManager to start an instance of **systemd-resolved**. This DNS stub resolver then listens on port **53** on IP address **127.0.0.53**. Consequently, this stub resolver is only reachable from the local system and not from the network.

With this configuration, NetworkManager adds the **nameserver 127.0.0.53** entry to the **/etc/resolv.conf** file, and **systemd-resolved** dynamically routes DNS requests to the corresponding DNS servers specified in the NetworkManager connection profiles.

IMPORTANT

The **systemd-resolved** service is provided as a Technology Preview only. Technology Preview features are not supported with Red Hat production Service Level Agreements (SLAs), might not be functionally complete, and Red Hat does not recommend using them for production. These previews provide early access to upcoming product features, enabling customers to test functionality and provide feedback during the development process.

See [Technology Preview Features Support Scope](#) on the Red Hat Customer Portal for information about the support scope for Technology Preview features.

For a supported solution, see [Using dnsmasq in NetworkManager to send DNS requests for a specific domain to a selected DNS server](#).

Prerequisites

- The system has multiple NetworkManager connections configured.
- A DNS server and search domain are configured in the NetworkManager connection profile that is responsible for resolving a specific domain.
For example, to ensure that the DNS server specified in a VPN connection resolves queries for the **example.com** domain, the VPN connection profile must contain the following settings:

- A DNS server that can resolve **example.com**
- A search domain set to **example.com** in the **ipv4.dns-search** and **ipv6.dns-search** parameters

Procedure

1. Enable and start the **systemd-resolved** service:

```
# systemctl --now enable systemd-resolved
```

2. Edit the **/etc/NetworkManager/NetworkManager.conf** file, and set the following entry in the **[main]** section:

```
dns=systemd-resolved
```

3. Reload the **NetworkManager** service:

```
# systemctl reload NetworkManager
```

Verification

1. Display the DNS servers **systemd-resolved** uses and for which domains the service uses a different DNS server:

```
# resolvectl
...
Link 2 (enp1s0)
  Current Scopes: DNS
  Protocols: +DefaultRoute ...
  Current DNS Server: 192.0.2.1
  DNS Servers: 192.0.2.1

Link 3 (tun0)
  Current Scopes: DNS
  Protocols: -DefaultRoute ...
  Current DNS Server: 198.51.100.7
  DNS Servers: 198.51.100.7 203.0.113.19
  DNS Domain: example.com
```

The output confirms that **systemd-resolved** uses different DNS servers for the **example.com** domain.

2. Use the **tcpdump** packet sniffer to verify the correct route of DNS requests:
 - a. Install the **tcpdump** package:

```
# dnf install tcpdump
```

- b. On one terminal, start **tcpdump** to capture DNS traffic on all interfaces:

```
# tcpdump -i any port 53
```

- c. On a different terminal, resolve host names for a domain for which an exception exists and another domain, for example:

```
# host -t A www.example.com
# host -t A www.redhat.com
```

- d. Verify in the **tcpdump** output that Red Hat Enterprise Linux sends only DNS queries for the **example.com** domain to the designated DNS server and through the corresponding interface:

```
...
13:52:42.234533 tun0 Out IP server.43534 > 198.51.100.7.domain: 50121+ A?
www.example.com. (33)
...
13:52:57.753235 enp1s0 Out IP server.40864 > 192.0.2.1.domain: 6906+ A?
www.redhat.com. (33)
...
```

Red Hat Enterprise Linux sends the DNS query for **www.example.com** to the DNS server on **198.51.100.7** and the query for **www.redhat.com** to **192.0.2.1**.

Troubleshooting

1. Verify that the **nameserver** entry in the **/etc/resolv.conf** file refers to **127.0.0.53**:

```
# cat /etc/resolv.conf
nameserver 127.0.0.53
```

If the entry is missing, check the **dns** parameter in the **/etc/NetworkManager/NetworkManager.conf** file.

2. Verify that the **systemd-resolved** service listens on port **53** on the local IP address **127.0.0.53**:

```
# ss -tulpn | grep "127.0.0.53"
udp UNCONN 0 0 127.0.0.53%lo:53 0.0.0.0:* users:(("systemd-
resolve",pid=1050,fd=12))
tcp LISTEN 0 4096 127.0.0.53%lo:53 0.0.0.0:* users:(("systemd-
resolve",pid=1050,fd=13))
```

If the service does not listen on **127.0.0.53:53**, check if the **systemd-resolved** service is running.

CHAPTER 24. MANAGING THE DEFAULT GATEWAY SETTING

The default gateway is a router that forwards network packets when no other route matches the destination of a packet. In a local network, the default gateway is typically the host that is one hop closer to the internet.

24.1. SETTING THE DEFAULT GATEWAY ON AN EXISTING CONNECTION BY USING NMCLI

In most situations, administrators set the default gateway when they create a connection as explained in, for example, [Configuring an Ethernet connection by using nmcli](#).

In most situations, administrators set the default gateway when they create a connection. However, you can also set or update the default gateway setting on a previously created connection using the **nmcli** utility.

Prerequisites

- At least one static IP address must be configured on the connection on which the default gateway will be set.
- If the user is logged in on a physical console, user permissions are sufficient. Otherwise, user must have **root** permissions.

Procedure

1. Set the IP address of the default gateway.

For example, to set the IPv4 address of the default gateway on the **example** connection to **192.0.2.1**:

```
# nmcli connection modify example ipv4.gateway "192.0.2.1"
```

For example, to set the IPv6 address of the default gateway on the **example** connection to **2001:db8:1::1**:

```
# nmcli connection modify example ipv6.gateway "2001:db8:1::1"
```

2. Restart the network connection for changes to take effect. For example, to restart the **example** connection using the command line:

```
# nmcli connection up example
```



WARNING

All connections currently using this network connection are temporarily interrupted during the restart.

3. Optionally, verify that the route is active.

To display the IPv4 default gateway:

```
# ip -4 route
default via 192.0.2.1 dev example proto static metric 100
```

To display the IPv6 default gateway:

```
# ip -6 route
default via 2001:db8:1::1 dev example proto static metric 100 pref medium
```

24.2. SETTING THE DEFAULT GATEWAY ON AN EXISTING CONNECTION BY USING THE NMCLI INTERACTIVE MODE

In most situations, administrators set the default gateway when they create a connection as explained in, for example, [Configuring an Ethernet connection by using the nmcli interactive editor](#)

In most situations, administrators set the default gateway when they create a connection. However, you can also set or update the default gateway setting on a previously created connection using the interactive mode of the **nmcli** utility.

Prerequisites

- At least one static IP address must be configured on the connection on which the default gateway will be set.
- If the user is logged in on a physical console, user permissions are sufficient. Otherwise, the user must have **root** permissions.

Procedure

1. Open the **nmcli** interactive mode for the required connection. For example, to open the **nmcli** interactive mode for the *example* connection:

```
# nmcli connection edit example
```

2. Set the default gateway.
For example, to set the IPv4 address of the default gateway on the *example* connection to **192.0.2.1**:

```
nmcli> set ipv4.gateway 192.0.2.1
```

For example, to set the IPv6 address of the default gateway on the *example* connection to **2001:db8:1::1**:

```
nmcli> set ipv6.gateway 2001:db8:1::1
```

3. Optionally, verify that the default gateway was set correctly:

```
nmcli> print
...
ipv4.gateway:          192.0.2.1
```

```
...
ipv6.gateway:          2001:db8:1::1
...
```

4. Save the configuration:

```
nmcli> save persistent
```

5. Restart the network connection for changes to take effect:

```
nmcli> activate example
```



WARNING

All connections currently using this network connection are temporarily interrupted during the restart.

6. Leave the **nmcli** interactive mode:

```
nmcli> quit
```

7. Optionally, verify that the route is active.

To display the IPv4 default gateway:

```
# ip -4 route
default via 192.0.2.1 dev example proto static metric 100
```

To display the IPv6 default gateway:

```
# ip -6 route
default via 2001:db8:1::1 dev example proto static metric 100 pref medium
```

Additional resources

- [Configuring an Ethernet connection by using the nmcli interactive editor](#)

24.3. SETTING THE DEFAULT GATEWAY ON AN EXISTING CONNECTION BY USING NM-CONNECTION-EDITOR

In most situations, administrators set the default gateway when they create a connection. However, you can also set or update the default gateway setting on a previously created connection using the **nm-connection-editor** application.

Prerequisites

- At least one static IP address must be configured on the connection on which the default gateway will be set.

Procedure

1. Open a terminal, and enter **nm-connection-editor**:

```
# nm-connection-editor
```

2. Select the connection to modify, and click the gear wheel icon to edit the existing connection.
3. Set the IPv4 default gateway. For example, to set the IPv4 address of the default gateway on the connection to **192.0.2.1**:
 - a. Open the **IPv4 Settings** tab.
 - b. Enter the address in the **gateway** field next to the IP range the gateway's address is within:

Addresses		
Address	Netmask	Gateway
192.0.2.123	24	192.0.2.1

4. Set the IPv6 default gateway. For example, to set the IPv6 address of the default gateway on the connection to **2001:db8:1::1**:
 - a. Open the **IPv6** tab.
 - b. Enter the address in the **gateway** field next to the IP range the gateway's address is within:

Addresses		
Address	Prefix	Gateway
2001:db8:1::5	64	2001:db8:1::1

5. Click **OK**.
6. Click **Save**.
7. Restart the network connection for changes to take effect. For example, to restart the **example** connection using the command line:

```
# nmcli connection up example
```



WARNING

All connections currently using this network connection are temporarily interrupted during the restart.

8. Optionally, verify that the route is active.
To display the IPv4 default gateway:

ip -4 route

```
default via 192.0.2.1 dev example proto static metric 100
```

To display the IPv6 default gateway:

ip -6 route

```
default via 2001:db8:1::1 dev example proto static metric 100 pref medium
```

Additional resources

- [Configuring an Ethernet connection by using nm-connection-editor](#)

24.4. SETTING THE DEFAULT GATEWAY ON AN EXISTING CONNECTION BY USING CONTROL-CENTER

In most situations, administrators set the default gateway when they create a connection. However, you can also set or update the default gateway setting on a previously created connection using the **control-center** application.

Prerequisites

- At least one static IP address must be configured on the connection on which the default gateway will be set.
- The network configuration of the connection is open in the **control-center** application.

Procedure

1. Set the IPv4 default gateway. For example, to set the IPv4 address of the default gateway on the connection to **192.0.2.1**:
 - a. Open the **IPv4** tab.
 - b. Enter the address in the **gateway** field next to the IP range the gateway's address is within:

Addresses		
Address	Netmask	Gateway
192.0.2.123	255.255.255.0	192.0.2.1

2. Set the IPv6 default gateway. For example, to set the IPv6 address of the default gateway on the connection to **2001:db8:1::1**:
 - a. Open the **IPv6** tab.
 - b. Enter the address in the **gateway** field next to the IP range the gateway's address is within:

Addresses		
Address	Prefix	Gateway
2001:db8:1::5	64	2001:db8:1::1

3. Click **Apply**.

- Back in the **Network** window, disable and re-enable the connection by switching the button for the connection to **Off** and back to **On** for changes to take effect.

**WARNING**

All connections currently using this network connection are temporarily interrupted during the restart.

- Optionally, verify that the route is active.
To display the IPv4 default gateway:

```
$ ip -4 route
default via 192.0.2.1 dev example proto static metric 100
```

To display the IPv6 default gateway:

```
$ ip -6 route
default via 2001:db8:1::1 dev example proto static metric 100 pref medium
```

Additional resources

- [Configuring an Ethernet connection by using control-center](#)

24.5. SETTING THE DEFAULT GATEWAY ON AN EXISTING CONNECTION BY USING NMSTATECTL

Use the **nmstatectl** utility to set the default gateway through the Nmstate API. The Nmstate API ensures that, after setting the configuration, the result matches the configuration file. If anything fails, **nmstatectl** automatically rolls back the changes to avoid leaving the system in an incorrect state.

Prerequisites

- At least one static IP address must be configured on the connection on which the default gateway will be set.
- The **enp1s0** interface is configured, and the IP address of the default gateway is within the subnet of the IP configuration of this interface.
- The **nmstate** package is installed.

Procedure

- Create a YAML file, for example `~/set-default-gateway.yml`, with the following content:

```
---
routes:
  config:
```

```
- destination: 0.0.0.0/0
  next-hop-address: 192.0.2.1
  next-hop-interface: enp1s0
```

These settings define **192.0.2.1** as the default gateway, and the default gateway is reachable through the **enp1s0** interface.

2. Apply the settings to the system:

```
# nmstatectl apply ~/set-default-gateway.yml
```

Additional resources

- **nmstatectl(8)** man page
- `/usr/share/doc/nmstate/examples/` directory

24.6. SETTING THE DEFAULT GATEWAY ON AN EXISTING CONNECTION BY USING THE NETWORK RHEL SYSTEM ROLE

You can use the **network** RHEL system role to set the default gateway.

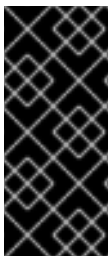

IMPORTANT

When you run a play that uses the **network** RHEL system role and if the setting values do not match the values specified in the play, the role overrides the existing connection profile with the same name. To prevent resetting these values to their defaults, always specify the whole configuration of the network connection profile in the play, even if the configuration, for example the IP configuration, already exists.

Depending on whether it already exists, the procedure creates or updates the **enp1s0** connection profile with the following settings:

- A static IPv4 address - **198.51.100.20** with a **/24** subnet mask
- A static IPv6 address - **2001:db8:1::1** with a **/64** subnet mask
- An IPv4 default gateway - **198.51.100.254**
- An IPv6 default gateway - **2001:db8:1::fffe**
- An IPv4 DNS server - **198.51.100.200**
- An IPv6 DNS server - **2001:db8:1::ffbb**
- A DNS search domain - **example.com**

Prerequisites

- [You have prepared the control node and the managed nodes](#)
- You are logged in to the control node as a user who can run playbooks on the managed nodes.
- The account you use to connect to the managed nodes has **sudo** permissions on them.

Procedure

1. Create a playbook file, for example `~/playbook.yml`, with the following content:

```
---
- name: Configure the network
  hosts: managed-node-01.example.com
  tasks:
    - name: Configure an Ethernet connection with static IP and default gateway
      ansible.builtin.include_role:
        name: rhel-system-roles.network
      vars:
        network_connections:
          - name: enp1s0
            type: ethernet
            autoconnect: yes
            ip:
              address:
                - 198.51.100.20/24
                - 2001:db8:1::1/64
              gateway4: 198.51.100.254
              gateway6: 2001:db8:1::fffe
            dns:
              - 198.51.100.200
              - 2001:db8:1::ffbb
            dns_search:
              - example.com
            state: up
```

2. Validate the playbook syntax:

```
$ ansible-playbook --syntax-check ~/playbook.yml
```

Note that this command only validates the syntax and does not protect against a wrong but valid configuration.

3. Run the playbook:

```
$ ansible-playbook ~/playbook.yml
```

Additional resources

- `/usr/share/ansible/roles/rhel-system-roles.network/README.md` file
- `/usr/share/doc/rhel-system-roles/network/` directory

24.7. HOW NETWORKMANAGER MANAGES MULTIPLE DEFAULT GATEWAYS

In certain situations, for example for fallback reasons, you set multiple default gateways on a host. However, to avoid asynchronous routing issues, each default gateway of the same protocol requires a separate metric value. Note that RHEL only uses the connection to the default gateway that has the lowest metric set.

You can set the metric for both the IPv4 and IPv6 gateway of a connection using the following command:

```
# nmcli connection modify connection-name ipv4.route-metric value ipv6.route-metric value
```



IMPORTANT

Do not set the same metric value for the same protocol in multiple connection profiles to avoid routing issues.

If you set a default gateway without a metric value, NetworkManager automatically sets the metric value based on the interface type. For that, NetworkManager assigns the default value of this network type to the first connection that is activated, and sets an incremented value to each other connection of the same type in the order they are activated. For example, if two Ethernet connections with a default gateway exist, NetworkManager sets a metric of **100** on the route to the default gateway of the connection that you activate first. For the second connection, NetworkManager sets **101**.

The following is an overview of frequently-used network types and their default metrics:

Connection type	Default metric value
VPN	50
Ethernet	100
MACsec	125
InfiniBand	150
Bond	300
Team	350
VLAN	400
Bridge	425
TUN	450
Wi-Fi	600
IP tunnel	675

Additional resources

- [Configuring policy-based routing to define alternative routes](#)
- [Getting started with Multipath TCP](#)

24.8. CONFIGURING NETWORKMANAGER TO AVOID USING A SPECIFIC PROFILE TO PROVIDE A DEFAULT GATEWAY

You can configure that NetworkManager never uses a specific profile to provide the default gateway. Follow this procedure for connection profiles that are not connected to the default gateway.

Prerequisites

- The NetworkManager connection profile for the connection that is not connected to the default gateway exists.

Procedure

1. If the connection uses a dynamic IP configuration, configure that NetworkManager does not use the connection as the default route for IPv4 and IPv6 connections:

```
# nmcli connection modify connection_name ipv4.never-default yes ipv6.never-default yes
```

Note that setting **ipv4.never-default** and **ipv6.never-default** to **yes**, automatically removes the default gateway's IP address for the corresponding protocol from the connection profile.

2. Activate the connection:

```
# nmcli connection up connection_name
```

Verification

- Use the **ip -4 route** and **ip -6 route** commands to verify that RHEL does not use the network interface for the default route for the IPv4 and IPv6 protocol.

24.9. FIXING UNEXPECTED ROUTING BEHAVIOR DUE TO MULTIPLE DEFAULT GATEWAYS

There are only a few scenarios, such as when using multipath TCP, in which you require multiple default gateways on a host. In most cases, you configure only a single default gateway to avoid unexpected routing behavior or asynchronous routing issues.



NOTE

To route traffic to different internet providers, use policy-based routing instead of multiple default gateways.

Prerequisites

- The host uses NetworkManager to manage network connections, which is the default.
- The host has multiple network interfaces.
- The host has multiple default gateways configured.

Procedure

1. Display the routing table:

- For IPv4, enter:

```
# ip -4 route
default via 192.0.2.1 dev enp1s0 proto static metric 101
default via 198.51.100.1 dev enp7s0 proto static metric 102
...
```

- For IPv6, enter:

```
# ip -6 route
default via 2001:db8:1::1 dev enp1s0 proto static metric 101 pref medium
default via 2001:db8:2::1 dev enp7s0 proto static metric 102 pref medium
...
```

Entries starting with **default** indicate a default route. Note the interface names of these entries displayed next to **dev**.

2. Use the following commands to display the NetworkManager connections that use the interfaces you identified in the previous step:

```
# nmcli -f GENERAL.CONNECTION,IP4.GATEWAY,IP6.GATEWAY device show enp1s0
GENERAL.CONNECTION: Corporate-LAN
IP4.GATEWAY: 192.0.2.1
IP6.GATEWAY: 2001:db8:1::1

# nmcli -f GENERAL.CONNECTION,IP4.GATEWAY,IP6.GATEWAY device show enp7s0
GENERAL.CONNECTION: Internet-Provider
IP4.GATEWAY: 198.51.100.1
IP6.GATEWAY: 2001:db8:2::1
```

In these examples, the profiles named **Corporate-LAN** and **Internet-Provider** have the default gateways set. Because, in a local network, the default gateway is typically the host that is one hop closer to the internet, the rest of this procedure assumes that the default gateways in the **Corporate-LAN** are incorrect.

3. Configure that NetworkManager does not use the **Corporate-LAN** connection as the default route for IPv4 and IPv6 connections:

```
# nmcli connection modify Corporate-LAN ipv4.never-default yes ipv6.never-default yes
```

Note that setting **ipv4.never-default** and **ipv6.never-default** to **yes**, automatically removes the default gateway's IP address for the corresponding protocol from the connection profile.

4. Activate the **Corporate-LAN** connection:

```
# nmcli connection up Corporate-LAN
```

Verification

- Display the IPv4 and IPv6 routing tables and verify that only one default gateway is available for each protocol:

- For IPv4, enter:

```
# ip -4 route  
default via 192.0.2.1 dev enp1s0 proto static metric 101  
...
```

- For IPv6, enter:

```
# ip -6 route  
default via 2001:db8:1::1 dev enp1s0 proto static metric 101 pref medium  
...
```

Additional resources

- [Configuring policy-based routing to define alternative routes](#)
- [Getting started with Multipath TCP](#)

CHAPTER 25. CONFIGURING STATIC ROUTES

Routing ensures that you can send and receive traffic between mutually-connected networks. In larger environments, administrators typically configure services so that routers can dynamically learn about other routers. In smaller environments, administrators often configure static routes to ensure that traffic can reach from one network to the next.

You need static routes to achieve a functioning communication among multiple networks if all of these conditions apply:

- The traffic has to pass multiple networks.
- The exclusive traffic flow through the default gateways is not sufficient.

Section 25.1, “Example of a network that requires static routes” describes scenarios and how the traffic flows between different networks when you do not configure static routes.

25.1. EXAMPLE OF A NETWORK THAT REQUIRES STATIC ROUTES

You require static routes in this example because not all IP networks are directly connected through one router. Without the static routes, some networks cannot communicate with each other. Additionally, traffic from some networks flows only in one direction.



NOTE

The network topology in this example is artificial and only used to explain the concept of static routing. It is not a recommended topology in production environments.

For a functioning communication among all networks in this example, configure a static route to Raleigh (**198.51.100.0/24**) with next the hop Router 2 (**203.0.113.10**). The IP address of the next hop is the one of Router 2 in the data center network (**203.0.113.0/24**).

You can configure the static route as follows:

- For a simplified configuration, set this static route only on Router 1. However, this increases the traffic on Router 1 because hosts from the data center (**203.0.113.0/24**) send traffic to Raleigh (**198.51.100.0/24**) always through Router 1 to Router 2.
- For a more complex configuration, configure this static route on all hosts in the data center (**203.0.113.0/24**). All hosts in this subnet then send traffic directly to Router 2 (**203.0.113.10**) that is closer to Raleigh (**198.51.100.0/24**).

For more details between which networks traffic flows or not, see the explanations below the diagram.



270_RHEL_0822

In case that the required static routes are not configured, the following are the situations in which the communication works and when it does not:

- Hosts in the Berlin network (**192.0.2.0/24**):
 - Can communicate with other hosts in the same subnet because they are directly connected.
 - Can communicate with the internet because Router 1 is in the Berlin network (**192.0.2.0/24**) and has a default gateway, which leads to the internet.
 - Can communicate with the data center network (**203.0.113.0/24**) because Router 1 has interfaces in both the Berlin (**192.0.2.0/24**) and the data center (**203.0.113.0/24**) networks.
 - Cannot communicate with the Raleigh network (**198.51.100.0/24**) because Router 1 has no interface in this network. Therefore, Router 1 sends the traffic to its own default gateway (internet).
- Hosts in the data center network (**203.0.113.0/24**):
 - Can communicate with other hosts in the same subnet because they are directly connected.
 - Can communicate with the internet because they have their default gateway set to Router 1, and Router 1 has interfaces in both networks, the data center (**203.0.113.0/24**) and to the internet.

- Can communicate with the Berlin network (**192.0.2.0/24**) because they have their default gateway set to Router 1, and Router 1 has interfaces in both the data center (**203.0.113.0/24**) and the Berlin (**192.0.2.0/24**) networks.
- Cannot communicate with the Raleigh network (**198.51.100.0/24**) because the data center network has no interface in this network. Therefore, hosts in the data center (**203.0.113.0/24**) send traffic to their default gateway (Router 1). Router 1 also has no interface in the Raleigh network (**198.51.100.0/24**) and, as a result, Router 1 sends this traffic to its own default gateway (internet).
- Hosts in the Raleigh network (**198.51.100.0/24**):
 - Can communicate with other hosts in the same subnet because they are directly connected.
 - Cannot communicate with hosts on the internet. Router 2 sends the traffic to Router 1 because of the default gateway settings. The actual behavior of Router 1 depends on the reverse path filter (**rp_filter**) system control (**sysctl**) setting. By default on RHEL, Router 1 drops the outgoing traffic instead of routing it to the internet. However, regardless of the configured behavior, communication is not possible without the static route.
 - Cannot communicate with the data center network (**203.0.113.0/24**). The outgoing traffic reaches the destination through Router 2 because of the default gateway setting. However, replies to packets do not reach the sender because hosts in the data center network (**203.0.113.0/24**) send replies to their default gateway (Router 1). Router 1 then sends the traffic to the internet.
 - Cannot communicate with the Berlin network (**192.0.2.0/24**). Router 2 sends the traffic to Router 1 because of the default gateway settings. The actual behavior of Router 1 depends on the **rp_filter sysctl** setting. By default on RHEL, Router 1 drops the outgoing traffic instead of sending it to the Berlin network (**192.0.2.0/24**). However, regardless of the configured behavior, communication is not possible without the static route.



NOTE

In addition to configuring the static routes, you must enable IP forwarding on both routers.

Additional resources

- [Why cannot a server be pinged if net.ipv4.conf.all.rp_filter is set on the server?](#)
- [Enabling IP forwarding](#)

25.2. HOW TO USE THE NMCLI COMMAND TO CONFIGURE A STATIC ROUTE

To configure a static route, use the **nmcli** utility with the following syntax:

```
$ nmcli connection modify connection_name ipv4.routes "ip[/prefix] [next_hop] [metric] [attribute=value] [attribute=value] ..."
```

The command supports the following route attributes:

- **cwnd=*n***: Sets the congestion window (CWND) size, defined in number of packets.

- **lock-cwnd=true|false**: Defines whether or not the kernel can update the CWND value.
- **lock-mtu=true|false**: Defines whether or not the kernel can update the MTU to path MTU discovery.
- **lock-window=true|false**: Defines whether or not the kernel can update the maximum window size for TCP packets.
- **mtu=*n***: Sets the maximum transfer unit (MTU) to use along the path to the destination.
- **onlink=true|false**: Defines whether the next hop is directly attached to this link even if it does not match any interface prefix.
- **scope=*n***: For an IPv4 route, this attribute sets the scope of the destinations covered by the route prefix. Set the value as an integer (0-255).
- **src=*address***: Sets the source address to prefer when sending traffic to the destinations covered by the route prefix.
- **table=*table_id***: Sets the ID of the table the route should be added to. If you omit this parameter, NetworkManager uses the **main** table.
- **tos=*n***: Sets the type of service (TOS) key. Set the value as an integer (0-255).
- **type=*value***: Sets the route type. NetworkManager supports the **unicast**, **local**, **blackhole**, **unreachable**, **prohibit**, and **throw** route types. The default is **unicast**.
- **window=*n***: Sets the maximal window size for TCP to advertise to these destinations, measured in bytes.

If you use the **ipv4.routes** sub-command, **nmcli** overrides all current settings of this parameter.

To add a route:

```
$ nmcli connection modify connection_name +ipv4.routes "<route>"
```

Similarly, to remove a specific route:

```
$ nmcli connection modify connection_name -ipv4.routes "<route>"
```

25.3. CONFIGURING A STATIC ROUTE BY USING NMCLI

You can add a static route to an existing NetworkManager connection profile using the **nmcli connection modify** command.

The procedure below configures the following routes:

- An IPv4 route to the remote **198.51.100.0/24** network. The corresponding gateway with the IP address **192.0.2.10** is reachable through the **example** connection.
- An IPv6 route to the remote **2001:db8:2::/64** network. The corresponding gateway with the IP address **2001:db8:1::10** is reachable through the **example** connection.

Prerequisites

- The **example** connection profile exists and it configures this host to be in the same IP subnet as the gateways.

Procedure

1. Add the static IPv4 route to the **example** connection profile:

```
# nmcli connection modify example +ipv4.routes "198.51.100.0/24 192.0.2.10"
```

To set multiple routes in one step, pass the individual routes comma-separated to the command. For example, to add a route to the **198.51.100.0/24** and **203.0.113.0/24** networks, both routed through the **192.0.2.10** gateway, enter:

```
# nmcli connection modify example +ipv4.routes "198.51.100.0/24 192.0.2.10,  
203.0.113.0/24 192.0.2.10"
```

2. Add the static IPv6 route to the **example** connection profile:

```
# nmcli connection modify example +ipv6.routes "2001:db8:2::/64 2001:db8:1::10"
```

3. Re-activate the connection:

```
# nmcli connection up example
```

Verification

1. Display the IPv4 routes:

```
# ip -4 route  
...  
198.51.100.0/24 via 192.0.2.10 dev enp1s0
```

2. Display the IPv6 routes:

```
# ip -6 route  
...  
2001:db8:2::/64 via 2001:db8:1::10 dev enp1s0 metric 1024 pref medium
```

Additional resources

- **nmcli(1)** man page
- **nm-settings-nmcli(5)** man page

25.4. CONFIGURING A STATIC ROUTE BY USING NMTUI

The **nmtui** application provides a text-based user interface for NetworkManager. You can use **nmtui** to configure static routes on a host without a graphical interface.

For example, the procedure below adds a route to the **192.0.2.0/24** network that uses the gateway running on **198.51.100.1**, which is reachable through an existing connection profile.



NOTE

In **nmtui**:

- Navigate by using the cursor keys.
- Press a button by selecting it and hitting **Enter**.
- Select and deselect checkboxes by using **Space**.

Prerequisites

- The network is configured.
- The gateway for the static route must be directly reachable on the interface.
- If the user is logged in on a physical console, user permissions are sufficient. Otherwise, the command requires root permissions.

Procedure

1. Start **nmtui**:

```
# nmtui
```

2. Select **Edit a connection**, and press **Enter**.
3. Select the connection profile through which you can reach the next hop to the destination network, and press **Enter**.
4. Depending on whether it is an IPv4 or IPv6 route, press the **Show** button next to the protocol's configuration area.
5. Press the **Edit** button next to **Routing**. This opens a new window where you configure static routes:
 - a. Press the **Add** button and fill in:
 - The destination network, including the prefix in Classless Inter-Domain Routing (CIDR) format
 - The IP address of the next hop
 - A metric value, if you add multiple routes to the same network and want to prioritize the routes by efficiency
 - b. Repeat the previous step for every route you want to add and that is reachable through this connection profile.
 - c. Press the **OK** button to return to the window with the connection settings.

Figure 25.1. Example of a static route without metric

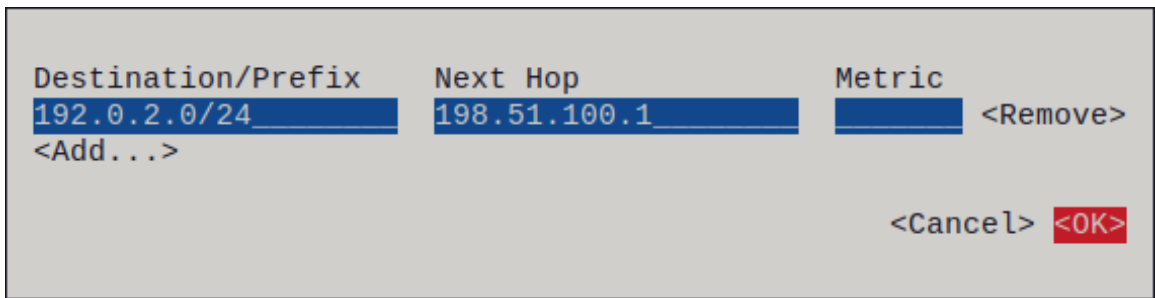

6. Press the **OK** button to return to the **nmtui** main menu.
7. Select **Activate a connection** and press **Enter**.
8. Select the connection profile that you edited, and press **Enter** twice to deactivate and activate it again.

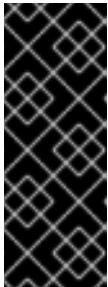

IMPORTANT

Skip this step if you run **nmtui** over a remote connection, such as SSH, that uses the connection profile you want to reactivate. In this case, if you would deactivate it in **nmtui**, the connection is terminated and, consequently, you cannot activate it again. To avoid this problem, use the **nmcli connection *connection_profile_name* up** command to reactivate the connection in the mentioned scenario.

9. Press the **Back** button to return to the main menu.
10. Select **Quit**, and press **Enter** to close the **nmtui** application.

Verification

- Verify that the route is active:

```
$ ip route
...
192.0.2.0/24 via 198.51.100.1 dev example proto static metric 100
```

25.5. CONFIGURING A STATIC ROUTE BY USING CONTROL-CENTER

You can use **control-center** in GNOME to add a static route to the configuration of a network connection.

The procedure below configures the following routes:

- An IPv4 route to the remote **198.51.100.0/24** network. The corresponding gateway has the IP address **192.0.2.10**.
- An IPv6 route to the remote **2001:db8:2::/64** network. The corresponding gateway has the IP address **2001:db8:1::10**.

Prerequisites

- The network is configured.

- This host is in the same IP subnet as the gateways.
- The network configuration of the connection is opened in the **control-center** application. See [Configuring an Ethernet connection by using nm-connection-editor](#).

Procedure

1. On the **IPv4** tab:
 - a. Optional: Disable automatic routes by clicking the **On** button in the **Routes** section of the **IPv4** tab to use only static routes. If automatic routes are enabled, Red Hat Enterprise Linux uses static routes and routes received from a DHCP server.
 - b. Enter the address, netmask, gateway, and optionally a metric value of the IPv4 route:

Routes				Automatic <input checked="" type="checkbox"/>
Address	Netmask	Gateway	Metric	
198.51.100.0	24	192.0.2.10		<input type="checkbox"/>

2. On the **IPv6** tab:
 - a. Optional: Disable automatic routes by clicking the **On** button in the **Routes** section of the **IPv4** tab to use only static routes.
 - b. Enter the address, netmask, gateway, and optionally a metric value of the IPv6 route:

Routes				Automatic <input checked="" type="checkbox"/>
Address	Prefix	Gateway	Metric	
2001:db8:2::	64	2001:db8:1::10		<input type="checkbox"/>

3. Click **Apply**.
4. Back in the **Network** window, disable and re-enable the connection by switching the button for the connection to **Off** and back to **On** for changes to take effect.



WARNING

Restarting the connection briefly disrupts connectivity on that interface.

Verification

1. Display the IPv4 routes:

```
# ip -4 route
...
198.51.100.0/24 via 192.0.2.10 dev enp1s0
```

2. Display the IPv6 routes:

```
# ip -6 route
```

```
...
2001:db8:2::/64 via 2001:db8:1::10 dev enp1s0 metric 1024 pref medium
```

25.6. CONFIGURING A STATIC ROUTE BY USING NM-CONNECTION-EDITOR

You can use the **nm-connection-editor** application to add a static route to the configuration of a network connection.

The procedure below configures the following routes:

- An IPv4 route to the remote **198.51.100.0/24** network. The corresponding gateway with the IP address **192.0.2.10** is reachable through the **example** connection.
- An IPv6 route to the remote **2001:db8:2::/64** network. The corresponding gateway with the IP address **2001:db8:1::10** is reachable through the **example** connection.

Prerequisites

- The network is configured.
- This host is in the same IP subnet as the gateways.

Procedure

1. Open a terminal, and enter **nm-connection-editor**:

```
$ nm-connection-editor
```

2. Select the **example** connection profile, and click the gear wheel icon to edit the existing connection.
3. On the **IPv4 Settings** tab:
 - a. Click the **Routes** button.
 - b. Click the **Add** button and enter the address, netmask, gateway, and optionally a metric value.

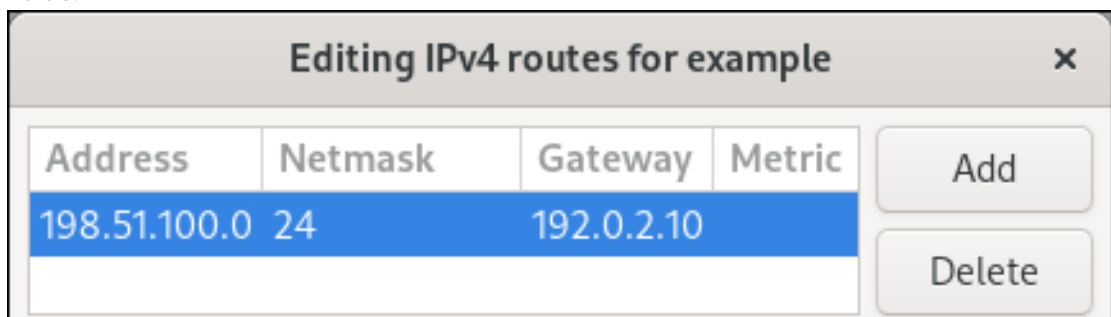

- c. Click **OK**.
4. On the **IPv6 Settings** tab:
 - a. Click the **Routes** button.

- b. Click the **Add** button and enter the address, netmask, gateway, and optionally a metric value.

Address	Prefix	Gateway	Metric
2001:db8:2::	64	2001:db8:1::10	

- c. Click **OK**.
5. Click **Save**.
6. Restart the network connection for changes to take effect. For example, to restart the **example** connection using the command line:

```
# nmcli connection up example
```

Verification

1. Display the IPv4 routes:

```
# ip -4 route
...
198.51.100.0/24 via 192.0.2.10 dev enp1s0
```

2. Display the IPv6 routes:

```
# ip -6 route
...
2001:db8:2::/64 via 2001:db8:1::10 dev enp1s0 metric 1024 pref medium
```

25.7. CONFIGURING A STATIC ROUTE BY USING THE NMCLI INTERACTIVE MODE

You can use the interactive mode of the **nmcli** utility to add a static route to the configuration of a network connection.

The procedure below configures the following routes:

- An IPv4 route to the remote **198.51.100.0/24** network. The corresponding gateway with the IP address **192.0.2.10** is reachable through the **example** connection.
- An IPv6 route to the remote **2001:db8:2::/64** network. The corresponding gateway with the IP address **2001:db8:1::10** is reachable through the **example** connection.

Prerequisites

- The **example** connection profile exists and it configures this host to be in the same IP subnet as the gateways.

Procedure

1. Open the **nmcli** interactive mode for the **example** connection:

```
# nmcli connection edit example
```

2. Add the static IPv4 route:

```
nmcli> set ipv4.routes 198.51.100.0/24 192.0.2.10
```

3. Add the static IPv6 route:

```
nmcli> set ipv6.routes 2001:db8:2::/64 2001:db8:1::10
```

4. Optionally, verify that the routes were added correctly to the configuration:

```
nmcli> print
...
ipv4.routes: { ip = 198.51.100.0/24, nh = 192.0.2.10 }
...
ipv6.routes: { ip = 2001:db8:2::/64, nh = 2001:db8:1::10 }
...
```

The **ip** attribute displays the network to route and the **nh** attribute the gateway (next hop).

5. Save the configuration:

```
nmcli> save persistent
```

6. Restart the network connection:

```
nmcli> activate example
```

7. Leave the **nmcli** interactive mode:

```
nmcli> quit
```

Verification

1. Display the IPv4 routes:

```
# ip -4 route
...
198.51.100.0/24 via 192.0.2.10 dev enp1s0
```

2. Display the IPv6 routes:

```
# ip -6 route
...
2001:db8:2::/64 via 2001:db8:1::10 dev enp1s0 metric 1024 pref medium
```

Additional resources

- **nmcli(1)** man page
- **nm-settings-nmcli(5)** man page

25.8. CONFIGURING A STATIC ROUTE BY USING NMSTATECTL

Use the **nmstatectl** utility to configure a static route through the Nmstate API. The Nmstate API ensures that, after setting the configuration, the result matches the configuration file. If anything fails, **nmstatectl** automatically rolls back the changes to avoid leaving the system in an incorrect state.

Prerequisites

- The **enp1s0** network interface is configured and is in the same IP subnet as the gateways.
- The **nmstate** package is installed.

Procedure

1. Create a YAML file, for example **~/add-static-route-to-enp1s0.yml**, with the following content:

```
---
routes:
  config:
    - destination: 198.51.100.0/24
      next-hop-address: 192.0.2.10
      next-hop-interface: enp1s0
    - destination: 2001:db8:2::/64
      next-hop-address: 2001:db8:1::10
      next-hop-interface: enp1s0
```

These settings define the following static routes:

- An IPv4 route to the remote **198.51.100.0/24** network. The corresponding gateway with the IP address **192.0.2.10** is reachable through the **enp1s0** interface.
 - An IPv6 route to the remote **2001:db8:2::/64** network. The corresponding gateway with the IP address **2001:db8:1::10** is reachable through the **enp1s0** interface.
2. Apply the settings to the system:

```
# nmstatectl apply ~/add-static-route-to-enp1s0.yml
```

Verification

1. Display the IPv4 routes:

```
# ip -4 route
...
198.51.100.0/24 via 192.0.2.10 dev enp1s0
```

2. Display the IPv6 routes:

```
# ip -6 route
```

```
...
2001:db8:2::/64 via 2001:db8:1::10 dev enp1s0 metric 1024 pref medium
```

Additional resources

- [nmstatectl\(8\)](#) man page
- [/usr/share/doc/nmstate/examples/](#) directory

25.9. CONFIGURING A STATIC ROUTE BY USING THE NETWORK RHEL SYSTEM ROLE

You can use the **network** RHEL system role to configure static routes.

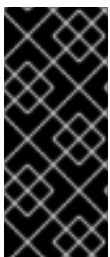

IMPORTANT

When you run a play that uses the **network** RHEL system role and if the setting values do not match the values specified in the play, the role overrides the existing connection profile with the same name. To prevent resetting these values to their defaults, always specify the whole configuration of the network connection profile in the play, even if the configuration, for example the IP configuration, already exists.

Prerequisites

- [You have prepared the control node and the managed nodes](#)
- You are logged in to the control node as a user who can run playbooks on the managed nodes.
- The account you use to connect to the managed nodes has **sudo** permissions on them.

Procedure

1. Create a playbook file, for example `~/playbook.yml`, with the following content:

```
---
- name: Configure the network
  hosts: managed-node-01.example.com
  tasks:
    - name: Configure an Ethernet connection with static IP and additional routes
      ansible.builtin.include_role:
        name: rhel-system-roles.network
      vars:
        network_connections:
          - name: enp7s0
            type: ethernet
            autoconnect: yes
            ip:
              address:
                - 192.0.2.1/24
                - 2001:db8:1::1/64
              gateway4: 192.0.2.254
              gateway6: 2001:db8:1::ffe
            dns:
```

```

- 192.0.2.200
- 2001:db8:1::ffbb
dns_search:
- example.com
route:
- network: 198.51.100.0
  prefix: 24
  gateway: 192.0.2.10
- network: 2001:db8:2::
  prefix: 64
  gateway: 2001:db8:1::10
state: up

```

Depending on whether it already exists, the procedure creates or updates the **enp7s0** connection profile with the following settings:

- A static IPv4 address - **192.0.2.1** with a **/24** subnet mask
- A static IPv6 address - **2001:db8:1::1** with a **/64** subnet mask
- An IPv4 default gateway - **192.0.2.254**
- An IPv6 default gateway - **2001:db8:1::ffe**
- An IPv4 DNS server - **192.0.2.200**
- An IPv6 DNS server - **2001:db8:1::ffbb**
- A DNS search domain - **example.com**
- Static routes:
 - **198.51.100.0/24** with gateway **192.0.2.10**
 - **2001:db8:2::/64** with gateway **2001:db8:1::10**

2. Validate the playbook syntax:

```
$ ansible-playbook --syntax-check ~/playbook.yml
```

Note that this command only validates the syntax and does not protect against a wrong but valid configuration.

3. Run the playbook:

```
$ ansible-playbook ~/playbook.yml
```

Verification

1. On the managed nodes:

a. Display the IPv4 routes:

```

# ip -4 route
...
198.51.100.0/24 via 192.0.2.10 dev enp7s0

```

b. Display the IPv6 routes:

```
# ip -6 route
...
2001:db8:2::/64 via 2001:db8:1::10 dev enp7s0 metric 1024 pref medium
```

Additional resources

- [/usr/share/ansible/roles/rhel-system-roles.network/README.md](#) file
- [/usr/share/doc/rhel-system-roles/network/](#) directory

CHAPTER 26. CONFIGURING POLICY-BASED ROUTING TO DEFINE ALTERNATIVE ROUTES

By default, the kernel in RHEL decides where to forward network packets based on the destination address using a routing table. Policy-based routing enables you to configure complex routing scenarios. For example, you can route packets based on various criteria, such as the source address, packet metadata, or protocol.



NOTE

On systems that use NetworkManager, only the **nmcli** utility supports setting routing rules and assigning routes to specific tables.

26.1. ROUTING TRAFFIC FROM A SPECIFIC SUBNET TO A DIFFERENT DEFAULT GATEWAY BY USING NMCLI

You can use policy-based routing to configure a different default gateway for traffic from certain subnets. For example, you can configure RHEL as a router that, by default, routes all traffic to internet provider A using the default route. However, traffic received from the internal workstations subnet is routed to provider B.

The procedure assumes the following network topology:

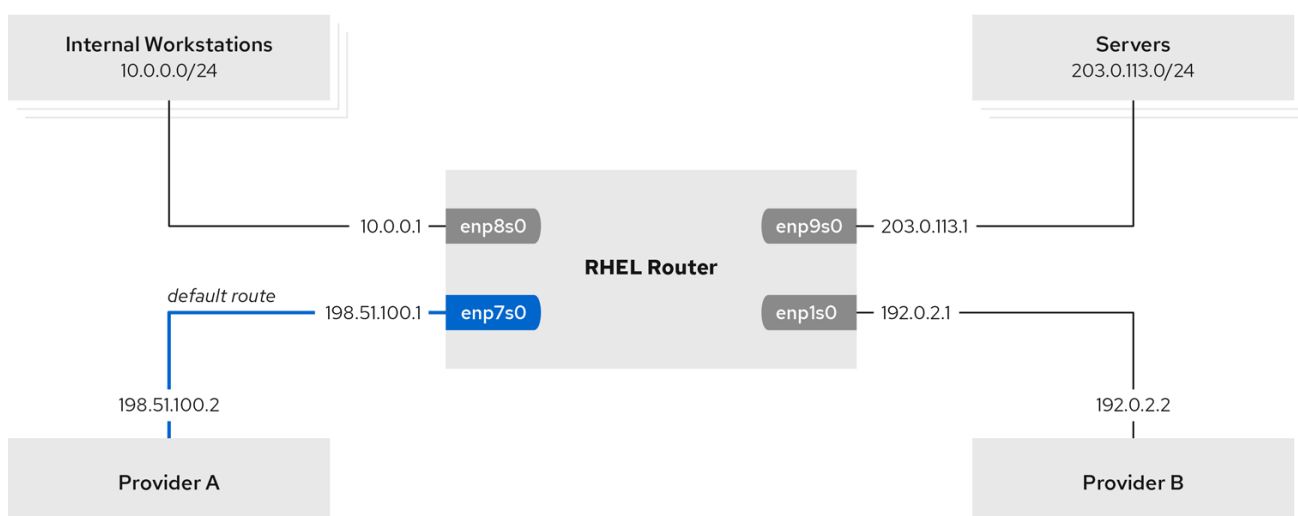

60_RHEL_0120

Prerequisites

- The system uses **NetworkManager** to configure the network, which is the default.
- The RHEL router you want to set up in the procedure has four network interfaces:
 - The **enp7s0** interface is connected to the network of provider A. The gateway IP in the provider's network is **198.51.100.2**, and the network uses a **/30** network mask.
 - The **enp1s0** interface is connected to the network of provider B. The gateway IP in the provider's network is **192.0.2.2**, and the network uses a **/30** network mask.
 - The **enp8s0** interface is connected to the **10.0.0.0/24** subnet with internal workstations.

- The **enp9s0** interface is connected to the **203.0.113.0/24** subnet with the company's servers.
- Hosts in the internal workstations subnet use **10.0.0.1** as the default gateway. In the procedure, you assign this IP address to the **enp8s0** network interface of the router.
- Hosts in the server subnet use **203.0.113.1** as the default gateway. In the procedure, you assign this IP address to the **enp9s0** network interface of the router.
- The **firewalld** service is enabled and active.

Procedure

1. Configure the network interface to provider A:

```
# nmcli connection add type ethernet con-name Provider-A ifname enp7s0
ipv4.method manual ipv4.addresses 198.51.100.1/30 ipv4.gateway 198.51.100.2
ipv4.dns 198.51.100.200 connection.zone external
```

The **nmcli connection add** command creates a NetworkManager connection profile. The command uses the following options:

- **type ethernet**: Defines that the connection type is Ethernet.
 - **con-name *connection_name***: Sets the name of the profile. Use a meaningful name to avoid confusion.
 - **ifname *network_device***: Sets the network interface.
 - **ipv4.method manual**: Enables to configure a static IP address.
 - **ipv4.addresses *IP_address/subnet_mask***: Sets the IPv4 addresses and subnet mask.
 - **ipv4.gateway *IP_address***: Sets the default gateway address.
 - **ipv4.dns *IP_of_DNS_server***: Sets the IPv4 address of the DNS server.
 - **connection.zone *firewalld_zone***: Assigns the network interface to the defined **firewalld** zone. Note that **firewalld** automatically enables masquerading for interfaces assigned to the **external** zone.
2. Configure the network interface to provider B:

```
# nmcli connection add type ethernet con-name Provider-B ifname enp1s0
ipv4.method manual ipv4.addresses 192.0.2.1/30 ipv4.routes "0.0.0.0/0 192.0.2.2
table=5000" connection.zone external
```

This command uses the **ipv4.routes** parameter instead of **ipv4.gateway** to set the default gateway. This is required to assign the default gateway for this connection to a different routing table (**5000**) than the default. NetworkManager automatically creates this new routing table when the connection is activated.

3. Configure the network interface to the internal workstations subnet:

```
# nmcli connection add type ethernet con-name Internal-Workstations ifname enp8s0
ipv4.method manual ipv4.addresses 10.0.0.1/24 ipv4.routes "10.0.0.0/24 table=5000"
ipv4.routing-rules "priority 5 from 10.0.0.0/24 table 5000" connection.zone trusted
```

This command uses the **ipv4.routes** parameter to add a static route to the routing table with ID **5000**. This static route for the **10.0.0.0/24** subnet uses the IP of the local network interface to provider B (**192.0.2.1**) as next hop.

Additionally, the command uses the **ipv4.routing-rules** parameter to add a routing rule with priority **5** that routes traffic from the **10.0.0.0/24** subnet to table **5000**. Low values have a high priority.

Note that the syntax in the **ipv4.routing-rules** parameter is the same as in an **ip rule add** command, except that **ipv4.routing-rules** always requires specifying a priority.

4. Configure the network interface to the server subnet:

```
# nmcli connection add type ethernet con-name Servers ifname enp9s0 ipv4.method
manual ipv4.addresses 203.0.113.1/24 connection.zone trusted
```

Verification

1. On a RHEL host in the internal workstation subnet:
 - a. Install the **traceroute** package:

```
# dnf install traceroute
```

- b. Use the **traceroute** utility to display the route to a host on the internet:

```
# traceroute redhat.com
traceroute to redhat.com (209.132.183.105), 30 hops max, 60 byte packets
 1 10.0.0.1 (10.0.0.1)  0.337 ms 0.260 ms 0.223 ms
 2 192.0.2.1 (192.0.2.1) 0.884 ms 1.066 ms 1.248 ms
 ...
```

The output of the command displays that the router sends packets over **192.0.2.1**, which is the network of provider B.

2. On a RHEL host in the server subnet:
 - a. Install the **traceroute** package:

```
# dnf install traceroute
```

- b. Use the **traceroute** utility to display the route to a host on the internet:

```
# traceroute redhat.com
traceroute to redhat.com (209.132.183.105), 30 hops max, 60 byte packets
 1 203.0.113.1 (203.0.113.1) 2.179 ms 2.073 ms 1.944 ms
 2 198.51.100.2 (198.51.100.2) 1.868 ms 1.798 ms 1.549 ms
 ...
```

The output of the command displays that the router sends packets over **198.51.100.2**, which is the network of provider A.

Troubleshooting steps

On the RHEL router:

1. Display the rule list:

```
# ip rule list
0: from all lookup local
5: from 10.0.0.0/24 lookup 5000
32766: from all lookup main
32767: from all lookup default
```

By default, RHEL contains rules for the tables **local**, **main**, and **default**.

2. Display the routes in table **5000**:

```
# ip route list table 5000
0.0.0.0/0 via 192.0.2.2 dev enp1s0 proto static metric 100
10.0.0.0/24 dev enp8s0 proto static scope link src 192.0.2.1 metric 102
```

3. Display the interfaces and firewall zones:

```
# firewall-cmd --get-active-zones
external
  interfaces: enp1s0 enp7s0
trusted
  interfaces: enp8s0 enp9s0
```

4. Verify that the **external** zone has masquerading enabled:

```
# firewall-cmd --info-zone=external
external (active)
target: default
icmp-block-inversion: no
interfaces: enp1s0 enp7s0
sources:
services: ssh
ports:
protocols:
masquerade: yes
...
```

Additional resources

- **nm-settings(5)** man page
- **nmcli(1)** man page
- [Is it possible to set up Policy Based Routing with NetworkManager in RHEL?](#)

26.2. ROUTING TRAFFIC FROM A SPECIFIC SUBNET TO A DIFFERENT DEFAULT GATEWAY BY USING THE NETWORK RHEL SYSTEM ROLE

You can use policy-based routing to configure a different default gateway for traffic from certain subnets. For example, you can configure RHEL as a router that, by default, routes all traffic to internet provider A using the default route. However, traffic received from the internal workstations subnet is routed to provider B.

To configure policy-based routing remotely and on multiple nodes, you can use the **network** RHEL system role.

This procedure assumes the following network topology:

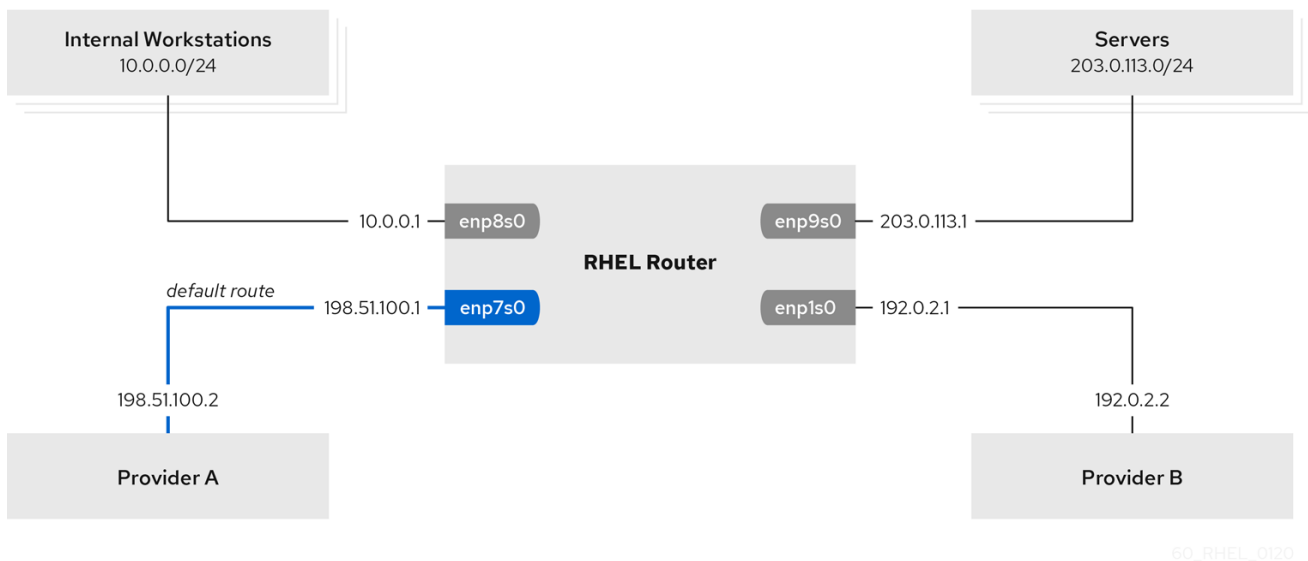

Prerequisites

- [You have prepared the control node and the managed nodes](#)
- You are logged in to the control node as a user who can run playbooks on the managed nodes.
- The account you use to connect to the managed nodes has **sudo** permissions on them.
- The managed nodes uses the **NetworkManager** and **firewalld** services.
- The managed nodes you want to configure has four network interfaces:
 - The **enp7s0** interface is connected to the network of provider A. The gateway IP in the provider's network is **198.51.100.2**, and the network uses a **/30** network mask.
 - The **enp1s0** interface is connected to the network of provider B. The gateway IP in the provider's network is **192.0.2.2**, and the network uses a **/30** network mask.
 - The **enp8s0** interface is connected to the **10.0.0.0/24** subnet with internal workstations.
 - The **enp9s0** interface is connected to the **203.0.113.0/24** subnet with the company's servers.
- Hosts in the internal workstations subnet use **10.0.0.1** as the default gateway. In the procedure, you assign this IP address to the **enp8s0** network interface of the router.

- Hosts in the server subnet use **203.0.113.1** as the default gateway. In the procedure, you assign this IP address to the **enp9s0** network interface of the router.

Procedure

1. Create a playbook file, for example `~/playbook.yml`, with the following content:

```
---
- name: Configuring policy-based routing
  hosts: managed-node-01.example.com
  tasks:
    - name: Routing traffic from a specific subnet to a different default gateway
      ansible.builtin.include_role:
        name: rhel-system-roles.network
      vars:
        network_connections:
          - name: Provider-A
            interface_name: enp7s0
            type: ethernet
            autoconnect: True
            ip:
              address:
                - 198.51.100.1/30
              gateway4: 198.51.100.2
              dns:
                - 198.51.100.200
            state: up
            zone: external

          - name: Provider-B
            interface_name: enp1s0
            type: ethernet
            autoconnect: True
            ip:
              address:
                - 192.0.2.1/30
              route:
                - network: 0.0.0.0
                  prefix: 0
                  gateway: 192.0.2.2
                  table: 5000
            state: up
            zone: external

          - name: Internal-Workstations
            interface_name: enp8s0
            type: ethernet
            autoconnect: True
            ip:
              address:
                - 10.0.0.1/24
              route:
                - network: 10.0.0.0
                  prefix: 24
                  table: 5000
            routing_rule:
```

```

- priority: 5
  from: 10.0.0.0/24
  table: 5000
state: up
zone: trusted

- name: Servers
  interface_name: enp9s0
  type: ethernet
  autoconnect: True
  ip:
    address:
      - 203.0.113.1/24
    state: up
    zone: trusted

```

2. Validate the playbook syntax:

```
$ ansible-playbook --syntax-check ~/playbook.yml
```

Note that this command only validates the syntax and does not protect against a wrong but valid configuration.

3. Run the playbook:

```
$ ansible-playbook ~/playbook.yml
```

Verification

1. On a RHEL host in the internal workstation subnet:

- a. Install the **traceroute** package:

```
# dnf install traceroute
```

- b. Use the **traceroute** utility to display the route to a host on the internet:

```

# traceroute redhat.com
traceroute to redhat.com (209.132.183.105), 30 hops max, 60 byte packets
 1 10.0.0.1 (10.0.0.1)  0.337 ms  0.260 ms  0.223 ms
 2 192.0.2.1 (192.0.2.1) 0.884 ms  1.066 ms  1.248 ms
 ...

```

The output of the command displays that the router sends packets over **192.0.2.1**, which is the network of provider B.

2. On a RHEL host in the server subnet:

- a. Install the **traceroute** package:

```
# dnf install traceroute
```

- b. Use the **traceroute** utility to display the route to a host on the internet:

traceroute redhat.com

```
traceroute to redhat.com (209.132.183.105), 30 hops max, 60 byte packets
 1 203.0.113.1 (203.0.113.1)  2.179 ms  2.073 ms  1.944 ms
 2 198.51.100.2 (198.51.100.2) 1.868 ms  1.798 ms  1.549 ms
 ...
```

The output of the command displays that the router sends packets over **198.51.100.2**, which is the network of provider A.

3. On the RHEL router that you configured using the RHEL system role:
 - a. Display the rule list:

ip rule list

```
0:    from all lookup local
5:    from 10.0.0.0/24 lookup 5000
32766: from all lookup main
32767: from all lookup default
```

By default, RHEL contains rules for the tables **local**, **main**, and **default**.

- b. Display the routes in table **5000**:

ip route list table 5000

```
0.0.0.0/0 via 192.0.2.2 dev enp1s0 proto static metric 100
10.0.0.0/24 dev enp8s0 proto static scope link src 192.0.2.1 metric 102
```

- c. Display the interfaces and firewall zones:

firewall-cmd --get-active-zones

```
external
  interfaces: enp1s0 enp7s0
trusted
  interfaces: enp8s0 enp9s0
```

- d. Verify that the **external** zone has masquerading enabled:

firewall-cmd --info-zone=external

```
external (active)
target: default
icmp-block-inversion: no
interfaces: enp1s0 enp7s0
sources:
services: ssh
ports:
protocols:
masquerade: yes
...
```

Additional resources

- `/usr/share/ansible/roles/rhel-system-roles.network/README.md` file
- `/usr/share/doc/rhel-system-roles/network/` directory

CHAPTER 27. REUSING THE SAME IP ADDRESS ON DIFFERENT INTERFACES

With Virtual routing and forwarding (VRF), administrators can use multiple routing tables simultaneously on the same host. For that, VRF partitions a network at layer 3. This enables the administrator to isolate traffic using separate and independent route tables per VRF domain. This technique is similar to virtual LANs (VLAN), which partitions a network at layer 2, where the operating system uses different VLAN tags to isolate traffic sharing the same physical medium.

One benefit of VRF over partitioning on layer 2 is that routing scales better considering the number of peers involved.

Red Hat Enterprise Linux uses a virtual **vrt** device for each VRF domain and adds routes to a VRF domain by adding existing network devices to a VRF device. Addresses and routes previously attached to the original device will be moved inside the VRF domain.

Note that each VRF domain is isolated from each other.

27.1. PERMANENTLY REUSING THE SAME IP ADDRESS ON DIFFERENT INTERFACES

You can use the virtual routing and forwarding (VRF) feature to permanently use the same IP address on different interfaces in one server.



IMPORTANT

To enable remote peers to contact both VRF interfaces while reusing the same IP address, the network interfaces must belong to different broadcasting domains. A broadcast domain in a network is a set of nodes, which receive broadcast traffic sent by any of them. In most configurations, all nodes connected to the same switch belong to the same broadcasting domain.

Prerequisites

- You are logged in as the **root** user.
- The network interfaces are not configured.

Procedure

1. Create and configure the first VRF device:
 - a. Create a connection for the VRF device and assign it to a routing table. For example, to create a VRF device named **vrf0** that is assigned to the **1001** routing table:

```
# nmcli connection add type vrf ifname vrf0 con-name vrf0 table 1001 ipv4.method disabled ipv6.method disabled
```

- b. Enable the **vrf0** device:

```
# nmcli connection up vrf0
```

- c. Assign a network device to the VRF just created. For example, to add the **enp1s0** Ethernet device to the **vrf0** VRF device and assign an IP address and the subnet mask to **enp1s0**, enter:

```
# nmcli connection add type ethernet con-name vrf.enp1s0 ifname enp1s0 master
vrf0 ipv4.method manual ipv4.address 192.0.2.1/24
```

- d. Activate the **vrf.enp1s0** connection:

```
# nmcli connection up vrf.enp1s0
```

2. Create and configure the next VRF device:

- a. Create the VRF device and assign it to a routing table. For example, to create a VRF device named **vrf1** that is assigned to the **1002** routing table, enter:

```
# nmcli connection add type vrf ifname vrf1 con-name vrf1 table 1002 ipv4.method
disabled ipv6.method disabled
```

- b. Activate the **vrf1** device:

```
# nmcli connection up vrf1
```

- c. Assign a network device to the VRF just created. For example, to add the **enp7s0** Ethernet device to the **vrf1** VRF device and assign an IP address and the subnet mask to **enp7s0**, enter:

```
# nmcli connection add type ethernet con-name vrf.enp7s0 ifname enp7s0 master
vrf1 ipv4.method manual ipv4.address 192.0.2.1/24
```

- d. Activate the **vrf.enp7s0** device:

```
# nmcli connection up vrf.enp7s0
```

27.2. TEMPORARILY REUSING THE SAME IP ADDRESS ON DIFFERENT INTERFACES

You can use the virtual routing and forwarding (VRF) feature to temporarily use the same IP address on different interfaces in one server. Use this procedure only for testing purposes, because the configuration is temporary and lost after you reboot the system.



IMPORTANT

To enable remote peers to contact both VRF interfaces while reusing the same IP address, the network interfaces must belong to different broadcasting domains. A broadcast domain in a network is a set of nodes which receive broadcast traffic sent by any of them. In most configurations, all nodes connected to the same switch belong to the same broadcasting domain.

Prerequisites

- You are logged in as the **root** user.

- The network interfaces are not configured.

Procedure

1. Create and configure the first VRF device:

- a. Create the VRF device and assign it to a routing table. For example, to create a VRF device named **blue** that is assigned to the **1001** routing table:

```
# ip link add dev blue type vrf table 1001
```

- b. Enable the **blue** device:

```
# ip link set dev blue up
```

- c. Assign a network device to the VRF device. For example, to add the **enp1s0** Ethernet device to the **blue** VRF device:

```
# ip link set dev enp1s0 master blue
```

- d. Enable the **enp1s0** device:

```
# ip link set dev enp1s0 up
```

- e. Assign an IP address and subnet mask to the **enp1s0** device. For example, to set it to **192.0.2.1/24**:

```
# ip addr add dev enp1s0 192.0.2.1/24
```

2. Create and configure the next VRF device:

- a. Create the VRF device and assign it to a routing table. For example, to create a VRF device named **red** that is assigned to the **1002** routing table:

```
# ip link add dev red type vrf table 1002
```

- b. Enable the **red** device:

```
# ip link set dev red up
```

- c. Assign a network device to the VRF device. For example, to add the **enp7s0** Ethernet device to the **red** VRF device:

```
# ip link set dev enp7s0 master red
```

- d. Enable the **enp7s0** device:

```
# ip link set dev enp7s0 up
```

- e. Assign the same IP address and subnet mask to the **enp7s0** device as you used for **enp1s0** in the **blue** VRF domain:

```
# ip addr add dev enp7s0 192.0.2.1/24
```

3. Optionally, create further VRF devices as described above.

27.3. ADDITIONAL RESOURCES

- `/usr/share/doc/kernel-doc-<kernel_version>/Documentation/networking/vrf.txt` from the `kernel-doc` package

CHAPTER 28. STARTING A SERVICE WITHIN AN ISOLATED VRF NETWORK

With virtual routing and forwarding (VRF), you can create isolated networks with a routing table that is different to the main routing table of the operating system. You can then start services and applications so that they have only access to the network defined in that routing table.

28.1. CONFIGURING A VRF DEVICE

To use virtual routing and forwarding (VRF), you create a VRF device and attach a physical or virtual network interface and routing information to it.



WARNING

To prevent that you lock out yourself out remotely, perform this procedure on the local console or remotely over a network interface that you do not want to assign to the VRF device.

Prerequisites

- You are logged in locally or using a network interface that is different to the one you want to assign to the VRF device.

Procedure

- Create the **vrf0** connection with a same-named virtual device, and attach it to routing table **1000**:

```
# nmcli connection add type vrf ifname vrf0 con-name vrf0 table 1000 ipv4.method disabled ipv6.method disabled
```

- Add the **enp1s0** device to the **vrf0** connection, and configure the IP settings:

```
# nmcli connection add type ethernet con-name enp1s0 ifname enp1s0 master vrf0 ipv4.method manual ipv4.address 192.0.2.1/24 ipv4.gateway 192.0.2.254
```

This command creates the **enp1s0** connection as a port of the **vrf0** connection. Due to this configuration, the routing information are automatically assigned to the routing table **1000** that is associated with the **vrf0** device.

- If you require static routes in the isolated network:

- Add the static routes:

```
# nmcli connection modify enp1s0 +ipv4.routes "198.51.100.0/24 192.0.2.2"
```

This adds a route to the **198.51.100.0/24** network that uses **192.0.2.2** as the router.

- Activate the connection:

```
# nmcli connection up enp1s0
```

Verification

1. Display the IP settings of the device that is associated with **vrf0**:

```
# ip -br addr show vrf vrf0
enp1s0 UP 192.0.2.1/24
```

2. Display the VRF devices and their associated routing table:

```
# ip vrf show
Name          Table
-----
vrf0         1000
```

3. Display the main routing table:

```
# ip route show
default via 203.0.113.0/24 dev enp7s0 proto static metric 100
```

The main routing table does not mention any routes associated with the device **enp1s0** device or the **192.0.2.1/24** subnet.

4. Display the routing table **1000**:

```
# ip route show table 1000
default via 192.0.2.254 dev enp1s0 proto static metric 101
broadcast 192.0.2.0 dev enp1s0 proto kernel scope link src 192.0.2.1
192.0.2.0/24 dev enp1s0 proto kernel scope link src 192.0.2.1 metric 101
local 192.0.2.1 dev enp1s0 proto kernel scope host src 192.0.2.1
broadcast 192.0.2.255 dev enp1s0 proto kernel scope link src 192.0.2.1
198.51.100.0/24 via 192.0.2.2 dev enp1s0 proto static metric 101
```

The **default** entry indicates that services that use this routing table, use **192.0.2.254** as their default gateway and not the default gateway in the main routing table.

5. Execute the **traceroute** utility in the network associated with **vrf0** to verify that the utility uses the route from table **1000**:

```
# ip vrf exec vrf0 traceroute 203.0.113.1
traceroute to 203.0.113.1 (203.0.113.1), 30 hops max, 60 byte packets
 1 192.0.2.254 (192.0.2.254) 0.516 ms 0.459 ms 0.430 ms
 ...
```

The first hop is the default gateway that is assigned to the routing table **1000** and not the default gateway from the system's main routing table.

Additional resources

- **ip-vrf(8)** man page

28.2. STARTING A SERVICE WITHIN AN ISOLATED VRF NETWORK

You can configure a service, such as the Apache HTTP Server, to start within an isolated virtual routing and forwarding (VRF) network.



IMPORTANT

Services can only bind to local IP addresses that are in the same VRF network.

Prerequisites

- You configured the **vrf0** device.
- You configured Apache HTTP Server to listen only on the IP address that is assigned to the interface associated with the **vrf0** device.

Procedure

1. Display the content of the **httpd** systemd service:

```
# systemctl cat httpd
...
[Service]
ExecStart=/usr/sbin/httpd $OPTIONS -DFOREGROUND
...
```

You require the content of the **ExecStart** parameter in a later step to run the same command within the isolated VRF network.

2. Create the **/etc/systemd/system/httpd.service.d/** directory:

```
# mkdir /etc/systemd/system/httpd.service.d/
```

3. Create the **/etc/systemd/system/httpd.service.d/override.conf** file with the following content:

```
[Service]
ExecStart=
ExecStart=/usr/sbin/ip vrf exec vrf0 /usr/sbin/httpd $OPTIONS -DFOREGROUND
```

To override the **ExecStart** parameter, you first need to unset it and then set it to the new value as shown.

4. Reload systemd.

```
# systemctl daemon-reload
```

5. Restart the **httpd** service.

```
# systemctl restart httpd
```

Verification

1. Display the process IDs (PID) of **httpd** processes:

```
# pidof -c httpd
1904 ...
```

2. Display the VRF association for the PIDs, for example:

```
# ip vrf identify 1904
vrf0
```

3. Display all PIDs associated with the **vrf0** device:

```
# ip vrf pids vrf0
1904 httpd
...
```

Additional resources

- [ip-vrf\(8\)](#) man page

CHAPTER 29. CONFIGURING ETHTOOL SETTINGS IN NETWORKMANAGER CONNECTION PROFILES

NetworkManager can configure certain network driver and hardware settings persistently. Compared to using the **ethtool** utility to manage these settings, this has the benefit of not losing the settings after a reboot.

You can set the following **ethtool** settings in NetworkManager connection profiles:

Offload features

Network interface controllers can use the TCP offload engine (TOE) to offload processing certain operations to the network controller. This improves the network throughput.

Interrupt coalesce settings

By using interrupt coalescing, the system collects network packets and generates a single interrupt for multiple packets. This increases the amount of data sent to the kernel with one hardware interrupt, which reduces the interrupt load, and maximizes the throughput.

Ring buffers

These buffers store incoming and outgoing network packets. You can increase the ring buffer sizes to reduce a high packet drop rate.

29.1. CONFIGURING AN ETHTOOL OFFLOAD FEATURE BY USING NMCLI

You can use NetworkManager to enable and disable **ethtool** offload features in a connection profile.

Procedure

1. For example, to enable the RX offload feature and disable TX offload in the **enp1s0** connection profile, enter:

```
# nmcli con modify enp1s0 ethtool.feature-rx on ethtool.feature-tx off
```

This command explicitly enables RX offload and disables TX offload.

2. To remove the setting of an offload feature that you previously enabled or disabled, set the feature's parameter to a null value. For example, to remove the configuration for TX offload, enter:

```
# nmcli con modify enp1s0 ethtool.feature-tx ""
```

3. Reactivate the network profile:

```
# nmcli connection up enp1s0
```

Verification

- Use the **ethtool -k** command to display the current offload features of a network device:

```
# ethtool -k network_device
```

Additional resources

- [nm-settings-nmcli\(5\)](#) man page

29.2. CONFIGURING AN ETHTOOL OFFLOAD FEATURE BY USING THE NETWORK RHEL SYSTEM ROLE

You can use the **network** RHEL system role to configure **ethtool** features of a NetworkManager connection.



IMPORTANT

When you run a play that uses the **network** RHEL system role and if the setting values do not match the values specified in the play, the role overrides the existing connection profile with the same name. To prevent resetting these values to their defaults, always specify the whole configuration of the network connection profile in the play, even if the configuration, for example the IP configuration, already exists.

Prerequisites

- [You have prepared the control node and the managed nodes](#)
- You are logged in to the control node as a user who can run playbooks on the managed nodes.
- The account you use to connect to the managed nodes has **sudo** permissions on them.

Procedure

1. Create a playbook file, for example `~/playbook.yml`, with the following content:

```
---
- name: Configure the network
  hosts: managed-node-01.example.com
  tasks:
    - name: Configure an Ethernet connection with ethtool features
      ansible.builtin.include_role:
        name: rhel-system-roles.network
      vars:
        network_connections:
          - name: enp1s0
            type: ethernet
            autoconnect: yes
            ip:
              address:
                - 198.51.100.20/24
                - 2001:db8:1::1/64
              gateway4: 198.51.100.254
              gateway6: 2001:db8:1::ffe
            dns:
              - 198.51.100.200
              - 2001:db8:1::ffbb
            dns_search:
              - example.com
        ethtool:
          features:
```



```

gro: "no"
gso: "yes"
tx_sctp_segmentation: "no"
state: up

```

This playbook creates the **enp1s0** connection profile with the following settings, or updates it if the profile already exists:

- A static **IPv4** address - **198.51.100.20** with a **/24** subnet mask
- A static **IPv6** address - **2001:db8:1::1** with a **/64** subnet mask
- An **IPv4** default gateway - **198.51.100.254**
- An **IPv6** default gateway - **2001:db8:1::fffe**
- An **IPv4** DNS server - **198.51.100.200**
- An **IPv6** DNS server - **2001:db8:1::ffbb**
- A DNS search domain - **example.com**
- **ethtool** features:
 - Generic receive offload (GRO): disabled
 - Generic segmentation offload (GSO): enabled
 - TX stream control transmission protocol (SCTP) segmentation: disabled

2. Validate the playbook syntax:

```
$ ansible-playbook --syntax-check ~/playbook.yml
```

Note that this command only validates the syntax and does not protect against a wrong but valid configuration.

3. Run the playbook:

```
$ ansible-playbook ~/playbook.yml
```

Additional resources

- `/usr/share/ansible/roles/rhel-system-roles.network/README.md` file
- `/usr/share/doc/rhel-system-roles/network/` directory

29.3. CONFIGURING AN ETHTOOL COALESCE SETTINGS BY USING NMCLI

You can use NetworkManager to set **ethtool** coalesce settings in connection profiles.

Procedure

1. For example, to set the maximum number of received packets to delay to **128** in the **enp1s0** connection profile, enter:

```
# nmcli connection modify enp1s0 ethtool.coalesce-rx-frames 128
```

2. To remove a coalesce setting, set it to a null value. For example, to remove the **ethtool.coalesce-rx-frames** setting, enter:

```
# nmcli connection modify enp1s0 ethtool.coalesce-rx-frames ""
```

3. To reactivate the network profile:

```
# nmcli connection up enp1s0
```

Verification

1. Use the **ethtool -c** command to display the current offload features of a network device:

```
# ethtool -c network_device
```

Additional resources

- [nm-settings-nmcli\(5\)](#) man page

29.4. CONFIGURING AN ETHTOOL COALESCE SETTINGS BY USING THE NETWORK RHEL SYSTEM ROLE

You can use the **network** RHEL system role to configure **ethtool** coalesce settings of a NetworkManager connection.



IMPORTANT

When you run a play that uses the **network** RHEL system role and if the setting values do not match the values specified in the play, the role overrides the existing connection profile with the same name. To prevent resetting these values to their defaults, always specify the whole configuration of the network connection profile in the play, even if the configuration, for example the IP configuration, already exists.

Prerequisites

- [You have prepared the control node and the managed nodes](#)
- You are logged in to the control node as a user who can run playbooks on the managed nodes.
- The account you use to connect to the managed nodes has **sudo** permissions on them.

Procedure

1. Create a playbook file, for example `~/playbook.yml`, with the following content:

```
---
- name: Configure the network
```

```

hosts: managed-node-01.example.com
tasks:
  - name: Configure an Ethernet connection with ethtool coalesce settings
    ansible.builtin.include_role:
      name: rhel-system-roles.network
    vars:
      network_connections:
        - name: enp1s0
          type: ethernet
          autoconnect: yes
          ip:
            address:
              - 198.51.100.20/24
              - 2001:db8:1::1/64
            gateway4: 198.51.100.254
            gateway6: 2001:db8:1::ffe
            dns:
              - 198.51.100.200
              - 2001:db8:1::ffbb
            dns_search:
              - example.com
          ethtool:
            coalesce:
              rx_frames: 128
              tx_frames: 128
          state: up

```

This playbook creates the **enp1s0** connection profile with the following settings, or updates it if the profile already exists:

- A static IPv4 address - **198.51.100.20** with a **/24** subnet mask
- A static IPv6 address - **2001:db8:1::1** with a **/64** subnet mask
- An IPv4 default gateway - **198.51.100.254**
- An IPv6 default gateway - **2001:db8:1::ffe**
- An IPv4 DNS server - **198.51.100.200**
- An IPv6 DNS server - **2001:db8:1::ffbb**
- A DNS search domain - **example.com**
- **ethtool** coalesce settings:
 - RX frames: **128**
 - TX frames: **128**

2. Validate the playbook syntax:

```
$ ansible-playbook --syntax-check ~/playbook.yml
```

Note that this command only validates the syntax and does not protect against a wrong but valid configuration.

3. Run the playbook:

```
$ ansible-playbook ~/playbook.yml
```

Additional resources

- `/usr/share/ansible/roles/rhel-system-roles.network/README.md` file
- `/usr/share/doc/rhel-system-roles/network/` directory

29.5. INCREASING THE RING BUFFER SIZE TO REDUCE A HIGH PACKET DROP RATE BY USING NMCLI

Increase the size of an Ethernet device's ring buffers if the packet drop rate causes applications to report a loss of data, timeouts, or other issues.

Receive ring buffers are shared between the device driver and network interface controller (NIC). The card assigns a transmit (TX) and receive (RX) ring buffer. As the name implies, the ring buffer is a circular buffer where an overflow overwrites existing data. There are two ways to move data from the NIC to the kernel, hardware interrupts and software interrupts, also called SoftIRQs.

The kernel uses the RX ring buffer to store incoming packets until the device driver can process them. The device driver drains the RX ring, typically by using SoftIRQs, which puts the incoming packets into a kernel data structure called an **sk_buff** or **skb** to begin its journey through the kernel and up to the application that owns the relevant socket.

The kernel uses the TX ring buffer to hold outgoing packets which should be sent to the network. These ring buffers reside at the bottom of the stack and are a crucial point at which packet drop can occur, which in turn will adversely affect network performance.

Procedure

1. Display the packet drop statistics of the interface:

```
# ethtool -S enp1s0
...
rx_queue_0_drops: 97326
rx_queue_1_drops: 63783
...
```

Note that the output of the command depends on the network card and the driver.

High values in **discard** or **drop** counters indicate that the available buffer fills up faster than the kernel can process the packets. Increasing the ring buffers can help to avoid such loss.

2. Display the maximum ring buffer sizes:

```
# ethtool -g enp1s0
Ring parameters for enp1s0:
Pre-set maximums:
RX:          4096
RX Mini:     0
RX Jumbo:    16320
TX:          4096
```

Current hardware settings:

```
RX:      255
RX Mini:  0
RX Jumbo: 0
TX:      255
```

If the values in the **Pre-set maximums** section are higher than in the **Current hardware settings** section, you can change the settings in the next steps.

- Identify the NetworkManager connection profile that uses the interface:

```
# nmcli connection show
NAME                UUID                                TYPE    DEVICE
Example-Connection a5eb6490-cc20-3668-81f8-0314a27f3f75 ethernet enp1s0
```

- Update the connection profile, and increase the ring buffers:

- To increase the RX ring buffer, enter:

```
# nmcli connection modify Example-Connection ethtool.ring-rx 4096
```

- To increase the TX ring buffer, enter:

```
# nmcli connection modify Example-Connection ethtool.ring-tx 4096
```

- Reload the NetworkManager connection:

```
# nmcli connection up Example-Connection
```

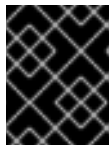

IMPORTANT

Depending on the driver your NIC uses, changing in the ring buffer can shortly interrupt the network connection.

Additional resources

- [ifconfig and ip commands report packet drops](#)
- [Should I be concerned about a 0.05% packet drop rate?](#)
- ethtool(8)** man page

29.6. INCREASING THE RING BUFFER SIZE TO REDUCE A HIGH PACKET DROP RATE BY USING THE NETWORK RHEL SYSTEM ROLE

Increase the size of an Ethernet device's ring buffers if the packet drop rate causes applications to report a loss of data, timeouts, or other issues.

Ring buffers are circular buffers where an overflow overwrites existing data. The network card assigns a transmit (TX) and receive (RX) ring buffer. Receive ring buffers are shared between the device driver and the network interface controller (NIC). Data can move from NIC to the kernel through either hardware interrupts or software interrupts, also called SoftIRQs.

The kernel uses the RX ring buffer to store incoming packets until the device driver can process them. The device driver drains the RX ring, typically by using SoftIRQs, which puts the incoming packets into a kernel data structure called an **sk_buff** or **skb** to begin its journey through the kernel and up to the application that owns the relevant socket.

The kernel uses the TX ring buffer to hold outgoing packets which should be sent to the network. These ring buffers reside at the bottom of the stack and are a crucial point at which packet drop can occur, which in turn will adversely affect network performance.

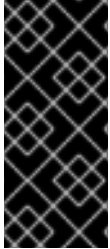

IMPORTANT

When you run a play that uses the **network** RHEL system role and if the setting values do not match the values specified in the play, the role overrides the existing connection profile with the same name. To prevent resetting these values to their defaults, always specify the whole configuration of the network connection profile in the play, even if the configuration, for example the IP configuration, already exists.

Prerequisites

- [You have prepared the control node and the managed nodes](#)
- You are logged in to the control node as a user who can run playbooks on the managed nodes.
- The account you use to connect to the managed nodes has **sudo** permissions on them.
- You know the maximum ring buffer sizes that the device supports.

Procedure

1. Create a playbook file, for example `~/playbook.yml`, with the following content:

```
---
- name: Configure the network
  hosts: managed-node-01.example.com
  tasks:
    - name: Configure an Ethernet connection with increased ring buffer sizes
      ansible.builtin.include_role:
        name: rhel-system-roles.network
      vars:
        network_connections:
          - name: enp1s0
            type: ethernet
            autoconnect: yes
            ip:
              address:
                - 198.51.100.20/24
                - 2001:db8:1::1/64
              gateway4: 198.51.100.254
              gateway6: 2001:db8:1::fffe
            dns:
              - 198.51.100.200
              - 2001:db8:1::ffbb
            dns_search:
              - example.com
            ethtool:
              ring:
```

```
rx: 4096
tx: 4096
state: up
```

This playbook creates the **enp1s0** connection profile with the following settings, or updates it if the profile already exists:

- A static **IPv4** address - **198.51.100.20** with a **/24** subnet mask
- A static **IPv6** address - **2001:db8:1::1** with a **/64** subnet mask
- An **IPv4** default gateway - **198.51.100.254**
- An **IPv6** default gateway - **2001:db8:1::fffe**
- An **IPv4** DNS server - **198.51.100.200**
- An **IPv6** DNS server - **2001:db8:1::ffbb**
- A DNS search domain - **example.com**
- Maximum number of ring buffer entries:
 - Receive (RX): 4096
 - Transmit (TX): 4096

2. Validate the playbook syntax:

```
$ ansible-playbook --syntax-check ~/playbook.yml
```

Note that this command only validates the syntax and does not protect against a wrong but valid configuration.

3. Run the playbook:

```
$ ansible-playbook ~/playbook.yml
```

Additional resources

- `/usr/share/ansible/roles/rhel-system-roles.network/README.md` file
- `/usr/share/doc/rhel-system-roles/network/` directory

CHAPTER 30. INTRODUCTION TO NETWORKMANAGER DEBUGGING

Increasing the log levels for all or certain domains helps to log more details of the operations that NetworkManager performs. You can use this information to troubleshoot problems. NetworkManager provides different levels and domains to produce logging information. The `/etc/NetworkManager/NetworkManager.conf` file is the main configuration file for NetworkManager. The logs are stored in the journal.

30.1. INTRODUCTION TO NETWORKMANAGER REAPPLY METHOD

The **NetworkManager** service uses a profile to manage the connection settings of a device. Desktop Bus (D-Bus) API can create, modify, and delete these connection settings. For any changes in a profile, D-Bus API clones the existing settings to the modified settings of a connection. Despite cloning, changes do not apply to the modified settings. To make it effective, reactivate the existing settings of a connection or use the **reapply()** method.

The **reapply()** method has the following features:

1. Updating modified connection settings without deactivation or restart of a network interface.
2. Removing pending changes from the modified connection settings. As **NetworkManager** does not revert the manual changes, you can reconfigure the device and revert external or manual parameters.
3. Creating different modified connection settings than that of the existing connection settings.

Also, **reapply()** method supports the following attributes:

- **bridge.ageing-time**
- **bridge.forward-delay**
- **bridge.group-address**
- **bridge.group-forward-mask**
- **bridge.hello-time**
- **bridge.max-age**
- **bridge.multicast-hash-max**
- **bridge.multicast-last-member-count**
- **bridge.multicast-last-member-interval**
- **bridge.multicast-membership-interval**
- **bridge.multicast-querier**
- **bridge.multicast-querier-interval**
- **bridge.multicast-query-interval**
- **bridge.multicast-query-response-interval**

- **bridge.multicast-query-use-ifaddr**
- **bridge.multicast-router**
- **bridge.multicast-snooping**
- **bridge.multicast-startup-query-count**
- **bridge.multicast-startup-query-interval**
- **bridge.priority**
- **bridge.stp**
- **bridge.VLAN-filtering**
- **bridge.VLAN-protocol**
- **bridge.VLANs**
- **802-3-ethernet.accept-all-mac-addresses**
- **802-3-ethernet.cloned-mac-address**
- **IPv4.addresses**
- **IPv4.dhcp-client-id**
- **IPv4.dhcp-iaid**
- **IPv4.dhcp-timeout**
- **IPv4.DNS**
- **IPv4.DNS-priority**
- **IPv4.DNS-search**
- **IPv4.gateway**
- **IPv4.ignore-auto-DNS**
- **IPv4.ignore-auto-routes**
- **IPv4.may-fail**
- **IPv4.method**
- **IPv4.never-default**
- **IPv4.route-table**
- **IPv4.routes**
- **IPv4.routing-rules**
- **IPv6.addr-gen-mode**

- **IPv6.addresses**
- **IPv6.dhcp-duid**
- **IPv6.dhcp-iaid**
- **IPv6.dhcp-timeout**
- **IPv6.DNS**
- **IPv6.DNS-priority**
- **IPv6.DNS-search**
- **IPv6.gateway**
- **IPv6.ignore-auto-DNS**
- **IPv6.may-fail**
- **IPv6.method**
- **IPv6.never-default**
- **IPv6.ra-timeout**
- **IPv6.route-metric**
- **IPv6.route-table**
- **IPv6.routes**
- **IPv6.routing-rules**

Additional resources

- **nm-settings-nmcli(5)** man page

30.2. SETTING THE NETWORKMANAGER LOG LEVEL

By default, all the log domains are set to record the **INFO** log level. Disable rate-limiting before collecting debug logs. With rate-limiting, **systemd-journald** drops messages if there are too many of them in a short time. This can occur when the log level is **TRACE**.

This procedure disables rate-limiting and enables recording debug logs for the all (ALL) domains.

Procedure

1. To disable rate-limiting, edit the **/etc/systemd/journald.conf** file, uncomment the **RateLimitBurst** parameter in the **[Journal]** section, and set its value as **0**:

```
RateLimitBurst=0
```

2. Restart the **systemd-journald** service.

```
# systemctl restart systemd-journald
```

3. Create the `/etc/NetworkManager/conf.d/95-nm-debug.conf` file with the following content:

```
[logging]
domains=ALL:TRACE
```

The **domains** parameter can contain multiple comma-separated **domain:level** pairs.

4. Restart the NetworkManager service.

```
# systemctl restart NetworkManager
```

Verification

- Query the **systemd** journal to display the journal entries of the **NetworkManager** unit:

```
# journalctl -u NetworkManager
...
Jun 30 15:24:32 server NetworkManager[164187]: <debug> [1656595472.4939] active-
connection[0x5565143c80a0]: update activation type from assume to managed
Jun 30 15:24:32 server NetworkManager[164187]: <trace> [1656595472.4939]
device[55b33c3bdb72840c] (enp1s0): sys-iface-state: assume -> managed
Jun 30 15:24:32 server NetworkManager[164187]: <trace> [1656595472.4939]
l3cfg[4281fdf43e356454,ifindex=3]: commit type register (type "update", source "device",
existing a369f23014b9ede3) -> a369f23014b9ede3
Jun 30 15:24:32 server NetworkManager[164187]: <info> [1656595472.4940] manager:
NetworkManager state is now CONNECTED_SITE
...
```

30.3. TEMPORARILY SETTING LOG LEVELS AT RUN TIME USING NMCLI

You can change the log level at run time using **nmcli**. However, Red Hat recommends to enable debugging using configuration files and restart NetworkManager. Updating debugging **levels** and **domains** using the **.conf** file helps to debug boot issues and captures all the logs from the initial state.

Procedure

1. Optional: Display the current logging settings:

```
# nmcli general logging
LEVEL DOMAINS
INFO
PLATFORM,RFKILL,ETHER,WIFI,BT,MB,DHCP4,DHCP6,PPP,WIFI_SCAN,IP4,IP6,A
UTOIP4,DNS,VPN,SHARING,SUPPLICANT,AGENTS,SETTINGS,SUSPEND,CORE,DEVIC
E,OLPC,
WIMAX,INFINIBAND,FIREWALL,ADSL,BOND,VLAN,BRIDGE,DBUS_PROPS,TEAM,CONC
HECK,DC
B,DISPATCH
```

2. To modify the logging level and domains, use the following options:

- To set the log level for all domains to the same **LEVEL**, enter:

-

```
# nmcli general logging level LEVEL domains ALL
```

- To change the level for specific domains, enter:

```
# nmcli general logging level LEVEL domains DOMAINS
```

Note that updating the logging level using this command disables logging for all the other domains.

- To change the level of specific domains and preserve the level of all other domains, enter:

```
# nmcli general logging level KEEP domains DOMAIN:LEVEL,DOMAIN:LEVEL
```

30.4. VIEWING NETWORKMANAGER LOGS

You can view the NetworkManager logs for troubleshooting.

Procedure

- To view the logs, enter:

```
# journalctl -u NetworkManager -b
```

Additional resources

- [NetworkManager.conf\(5\)](#) man page
- [journalctl\(1\)](#) man page

30.5. DEBUGGING LEVELS AND DOMAINS

You can use the **levels** and **domains** parameters to manage the debugging for NetworkManager. The level defines the verbosity level, whereas the domains define the category of the messages to record the logs with given severity (**level**).

Log levels	Description
OFF	Does not log any messages about NetworkManager
ERR	Logs only critical errors
WARN	Logs warnings that can reflect the operation
INFO	Logs various informational messages that are useful for tracking state and operations
DEBUG	Enables verbose logging for debugging purposes
TRACE	Enables more verbose logging than the DEBUG level

Note that subsequent levels log all messages from earlier levels. For example, setting the log level to **INFO** also logs messages contained in the **ERR** and **WARN** log level.

Additional resources

- **NetworkManager.conf(5)** man page

CHAPTER 31. USING LLDP TO DEBUG NETWORK CONFIGURATION PROBLEMS

You can use the Link Layer Discovery Protocol (LLDP) to debug network configuration problems in the topology. This means that, LLDP can report configuration inconsistencies with other hosts or routers and switches.

31.1. DEBUGGING AN INCORRECT VLAN CONFIGURATION USING LLDP INFORMATION

If you configured a switch port to use a certain VLAN and a host does not receive these VLAN packets, you can use the Link Layer Discovery Protocol (LLDP) to debug the problem. Perform this procedure on the host that does not receive the packets.

Prerequisites

- The **nmstate** package is installed.
- The switch supports LLDP.
- LLDP is enabled on neighbor devices.

Procedure

1. Create the `~/enable-LLDP-enp1s0.yml` file with the following content:

```
interfaces:  
  - name: enp1s0  
    type: ethernet  
    lldp:  
      enabled: true
```

2. Use the `~/enable-LLDP-enp1s0.yml` file to enable LLDP on interface **enp1s0**:

```
# nmstatectl apply ~/enable-LLDP-enp1s0.yml
```

3. Display the LLDP information:

```
# nmstatectl show enp1s0  
- name: enp1s0  
  type: ethernet  
  state: up  
  ipv4:  
    enabled: false  
    dhcp: false  
  ipv6:  
    enabled: false  
    autoconf: false  
    dhcp: false  
  lldp:  
    enabled: true  
  neighbors:  
    - - type: 5
```

```

system-name: Summit300-48
- type: 6
system-description: Summit300-48 - Version 7.4e.1 (Build 5)
  05/27/05 04:53:11
- type: 7
system-capabilities:
- MAC Bridge component
- Router
- type: 1
  _description: MAC address
  chassis-id: 00:01:30:F9:AD:A0
  chassis-id-type: 4
- type: 2
  _description: Interface name
  port-id: 1/1
  port-id-type: 5
- type: 127
ieee-802-1-vlans:
- name: v2-0488-03-0505
  vid: 488
  oui: 00:80:c2
  subtype: 3
- type: 127
ieee-802-3-mac-phy-conf:
  autoneg: true
  operational-mau-type: 16
  pmd-autoneg-cap: 27648
  oui: 00:12:0f
  subtype: 1
- type: 127
ieee-802-1-ppvids:
- 0
  oui: 00:80:c2
  subtype: 2
- type: 8
management-addresses:
- address: 00:01:30:F9:AD:A0
  address-subtype: MAC
  interface-number: 1001
  interface-number-subtype: 2
- type: 127
ieee-802-3-max-frame-size: 1522
  oui: 00:12:0f
  subtype: 4
mac-address: 82:75:BE:6F:8C:7A
mtu: 1500

```

- Verify the output to ensure that the settings match your expected configuration. For example, the LLDP information of the interface connected to the switch shows that the switch port this host is connected to uses VLAN ID **448**:

```

- type: 127
ieee-802-1-vlans:
- name: v2-0488-03-0505
  vid: 488

```

If the network configuration of the **enp1s0** interface uses a different VLAN ID, change it accordingly.

Additional resources

[Configuring VLAN tagging](#)

CHAPTER 32. LINUX TRAFFIC CONTROL

Linux offers tools for managing and manipulating the transmission of packets. The Linux Traffic Control (TC) subsystem helps in policing, classifying, shaping, and scheduling network traffic. TC also mangles the packet content during classification by using filters and actions. The TC subsystem achieves this by using queuing disciplines (**qdisc**), a fundamental element of the TC architecture.

The scheduling mechanism arranges or rearranges the packets before they enter or exit different queues. The most common scheduler is the First-In-First-Out (FIFO) scheduler. You can do the **qdiscs** operations temporarily using the **tc** utility or permanently using NetworkManager.

In Red Hat Enterprise Linux, you can configure default queuing disciplines in various ways to manage the traffic on a network interface.

32.1. OVERVIEW OF QUEUING DISCIPLINES

Queuing disciplines (**qdiscs**) help with queuing up and, later, scheduling of traffic transmission by a network interface. A **qdisc** has two operations;

- enqueue requests so that a packet can be queued up for later transmission and
- dequeue requests so that one of the queued-up packets can be chosen for immediate transmission.

Every **qdisc** has a 16-bit hexadecimal identification number called a **handle**, with an attached colon, such as **1:** or **abcd:**. This number is called the **qdisc** major number. If a **qdisc** has classes, then the identifiers are formed as a pair of two numbers with the major number before the minor, **<major>:<minor>**, for example **abcd:1**. The numbering scheme for the minor numbers depends on the **qdisc** type. Sometimes the numbering is systematic, where the first-class has the ID **<major>:1**, the second one **<major>:2**, and so on. Some **qdiscs** allow the user to set class minor numbers arbitrarily when creating the class.

Classful **qdiscs**

Different types of **qdiscs** exist and help in the transfer of packets to and from a networking interface. You can configure **qdiscs** with root, parent, or child classes. The point where children can be attached are called classes. Classes in **qdisc** are flexible and can always contain either multiple children classes or a single child, **qdisc**. There is no prohibition against a class containing a classful **qdisc** itself, this facilitates complex traffic control scenarios.

Classful **qdiscs** do not store any packets themselves. Instead, they enqueue and dequeue requests down to one of their children according to criteria specific to the **qdisc**. Eventually, this recursive packet passing ends up where the packets are stored (or picked up from in the case of dequeuing).

Classless **qdiscs**

Some **qdiscs** contain no child classes and they are called classless **qdiscs**. Classless **qdiscs** require less customization compared to classful **qdiscs**. It is usually enough to attach them to an interface.

Additional resources

- **tc(8)** man page
- **tc-actions(8)** man page

32.2. INTRODUCTION TO CONNECTION TRACKING

At a firewall, the **Netfilter** framework filters packets from an external network. After a packet arrives,

Netfilter assigns a connection tracking entry. Connection tracking is a Linux kernel networking feature for logical networks that tracks connections and identifies packet flow in those connections. This feature filters and analyzes every packet, sets up the connection tracking table to store connection status, and updates the connection status based on identified packets. For example, in the case of FTP connection, **Netfilter** assigns a connection tracking entry to ensure all packets of FTP connection work in the same manner. The connection tracking entry stores a **Netfilter** mark and tracks the connection state information in the memory table in which a new packet tuple maps with an existing entry. If the packet tuple does not map with an existing entry, the packet adds a new connection tracking entry that groups packets of the same connection.

You can control and analyze traffic on the network interface. The **tc** traffic controller utility uses the **qdisc** discipline to configure the packet scheduler in the network. The **qdisc** kernel-configured queuing discipline enqueues packets to the interface. By using **qdisc**, Kernel catches all the traffic before a network interface transmits it. Also, to limit the bandwidth rate of packets belonging to the same connection, use the **tc qdisc** command.

To retrieve data from connection tracking marks into various fields, use the **tc** utility with the **ctinfo** module and the **connmark** functionality. For storing packet mark information, the **ctinfo** module copies the **Netfilter** mark and the connection state information into a socket buffer (**skb**) mark metadata field.

Transmitting a packet over a physical medium removes all the metadata of a packet. Before the packet loses its metadata, the **ctinfo** module maps and copies the **Netfilter** mark value to a specific value of the Diffserv code point (DSCP) in the packet's **IP** field.

Additional resources

- **tc(8)** and **tc-ctinfo(8)** man pages

32.3. INSPECTING QDISCS OF A NETWORK INTERFACE USING THE TC UTILITY

By default, Red Hat Enterprise Linux systems use **fq_codel qdisc**. You can inspect the **qdisc** counters using the **tc** utility.

Procedure

1. Optional: View your current **qdisc**:

```
# tc qdisc show dev enp0s1
```

2. Inspect the current **qdisc** counters:

```
# tc -s qdisc show dev enp0s1
qdisc fq_codel 0: root refcnt 2 limit 10240p flows 1024 quantum 1514 target 5.0ms interval
100.0ms memory_limit 32Mb ecn
Sent 1008193 bytes 5559 pkt (dropped 233, overlimits 55 requeues 77)
backlog 0b 0p requeues 0
```

- **dropped** - the number of times a packet is dropped because all queues are full
- **overlimits** - the number of times the configured link capacity is filled
- **sent** - the number of dequeues

32.4. UPDATING THE DEFAULT QDISC

If you observe networking packet losses with the current **qdisc**, you can change the **qdisc** based on your network-requirements.

Procedure

1. View the current default **qdisc**:

```
# sysctl -a | grep qdisc
net.core.default_qdisc = fq_codel
```

2. View the **qdisc** of current Ethernet connection:

```
# tc -s qdisc show dev enp0s1
qdisc fq_codel 0: root refcnt 2 limit 10240p flows 1024 quantum 1514 target 5.0ms interval
100.0ms memory_limit 32Mb ecn
Sent 0 bytes 0 pkt (dropped 0, overlimits 0 requeues 0)
backlog 0b 0p requeues 0
maxpacket 0 drop_overlimit 0 new_flow_count 0 ecn_mark 0
new_flows_len 0 old_flows_len 0
```

3. Update the existing **qdisc**:

```
# sysctl -w net.core.default_qdisc=pfifo_fast
```

4. To apply the changes, reload the network driver:

```
# modprobe -r NETWORKDRIVERNAME
# modprobe NETWORKDRIVERNAME
```

5. Start the network interface:

```
# ip link set enp0s1 up
```

Verification

- View the **qdisc** of the Ethernet connection:

```
# tc -s qdisc show dev enp0s1
qdisc pfifo_fast 0: root refcnt 2 bands 3 priomap 1 2 2 2 1 2 0 0 1 1 1 1 1 1 1 1
Sent 373186 bytes 5333 pkt (dropped 0, overlimits 0 requeues 0)
backlog 0b 0p requeues 0
....
```

Additional resources

- [How to set **sysctl** variables on Red Hat Enterprise Linux](#)

32.5. TEMPORARILY SETTING THE CURRENT QDISC OF A NETWORK INTERFACE USING THE TC UTILITY

You can update the current **qdisc** without changing the default one.

Procedure

1. Optional: View the current **qdisc**:

```
# tc -s qdisc show dev enp0s1
```

2. Update the current **qdisc**:

```
# tc qdisc replace dev enp0s1 root htb
```

Verification

- View the updated current **qdisc**:

```
# tc -s qdisc show dev enp0s1
qdisc htb 8001: root refcnt 2 r2q 10 default 0 direct_packets_stat 0 direct_qlen 1000
Sent 0 bytes 0 pkt (dropped 0, overlimits 0 requeues 0)
backlog 0b 0p requeues 0
```

32.6. PERMANENTLY SETTING THE CURRENT QDISC OF A NETWORK INTERFACE USING NETWORKMANAGER

You can update the current **qdisc** value of a NetworkManager connection.

Procedure

1. Optional: View the current **qdisc**:

```
# tc qdisc show dev enp0s1
qdisc fq_codel 0: root refcnt 2
```

2. Update the current **qdisc**:

```
# nmcli connection modify enp0s1 tc.qdiscs 'root pfifo_fast'
```

3. Optional: To add another **qdisc** over the existing **qdisc**, use the **+tc.qdisc** option:

```
# nmcli connection modify enp0s1 +tc.qdisc 'ingress handle ffff'
```

4. Activate the changes:

```
# nmcli connection up enp0s1
```

Verification

- View current **qdisc** the network interface:

```
# tc qdisc show dev enp0s1
```

```
qdisc pfifo_fast 8001: root refcnt 2 bands 3 priomap  1 2 2 2 1 2 0 0 1 1 1 1 1 1 1 1
qdisc ingress ffff: parent ffff:fff1 -----
```

Additional resources

- **nm-settings(5)** man page

32.7. CONFIGURING THE RATE LIMITING OF PACKETS BY USING THE TC-CTINFO UTILITY

You can limit network traffic and prevent the exhaustion of resources in the network by using rate limiting. With rate limiting, you can also reduce the load on servers by limiting repetitive packet requests in a specific time frame. In addition, you can manage bandwidth rate by configuring traffic control in the kernel with the **tc-ctinfo** utility.

The connection tracking entry stores the **Netfilter** mark and connection information. When a router forwards a packet from the firewall, the router either removes or modifies the connection tracking entry from the packet. The connection tracking information (**ctinfo**) module retrieves data from connection tracking marks into various fields. This kernel module preserves the **Netfilter** mark by copying it into socket buffer (**skb**) mark metadata field.

Prerequisites

- The **iperf3** utility is installed on a server and a client.

Procedure

1. Perform the following steps on the server:
 - a. Add a virtual link to the network interface:

```
# ip link add name ifb4eth0 numtxqueues 48 numrxqueues 48 type ifb
```

This command has the following parameters:

name ifb4eth0

Sets new virtual device interface.

numtxqueues 48

Sets the number of transmit queues.

numrxqueues 48

Sets the number of receive queues.

type ifb

Sets the type of the new device.

- b. Change the state of the interface:

```
# ip link set dev ifb4eth0 up
```

- c. Add the **qdisc** attribute on the physical network interface and apply it to the incoming traffic:

```
# tc qdisc add dev enp1s0 handle ffff: ingress
```

In the **handle ffff:** option, the **handle** parameter assigns the major number **ffff:** as a default value to a classful **qdisc** on the **enp1s0** physical network interface, where **qdisc** is a queueing discipline parameter to analyze traffic control.

- d. Add a filter on the physical interface of the **ip** protocol to classify packets:

```
# tc filter add dev enp1s0 parent ffff: protocol ip u32 match u32 0 0 action ctinfo
cpmark 100 action mirrored egress redirect dev ifb4eth0
```

This command has the following attributes:

parent ffff:

Sets major number **ffff:** for the parent **qdisc**.

u32 match u32 0 0

Sets the **u32** filter to **match** the IP headers of **u32** pattern. The first **0** represents the second byte of IP header while the other **0** is for the mask match telling the filter which bits to match.

action ctinfo

Sets action to retrieve data from the connection tracking mark into various fields.

cpmark 100

Copies the connection tracking mark (connmark) **100** into the packet IP header field.

action mirrored egress redirect dev ifb4eth0

Sets **action mirrored** to redirect the received packets to the **ifb4eth0** destination interface.

- e. Add a classful **qdisc** to the interface:

```
# tc qdisc add dev ifb4eth0 root handle 1: htb default 1000
```

This command sets the major number **1** to root **qdisc** and uses the **htb** hierarchy token bucket with classful **qdisc** of minor-id **1000**.

- f. Limit the traffic on the interface to 1 Mbit/s with an upper limit of 2 Mbit/s:

```
# tc class add dev ifb4eth0 parent 1:1 classid 1:100 htb ceil 2mbit rate 1mbit prio
100
```

This command has the following parameters:

parent 1:1

Sets **parent** with **classid** as **1** and **root** as **1**.

classid 1:100

Sets **classid** as **1:100** where **1** is the number of parent **qdisc** and **100** is the number of classes of the parent **qdisc**.

htb ceil 2mbit

The **htb** classful **qdisc** allows upper limit bandwidth of **2 Mbit/s** as the **ceil** rate limit.

- g. Apply the Stochastic Fairness Queuing (**sfq**) of classless **qdisc** to interface with a time interval of **60** seconds to reduce queue algorithm perturbation:

```
# tc qdisc add dev ifb4eth0 parent 1:100 sfq perturb 60
```

- h. Add the firewall mark (**fw**) filter to the interface:

```
# tc filter add dev ifb4eth0 parent 1:0 protocol ip prio 100 handle 100 fw classid 1:100
```

- i. Restore the packet meta mark from the connection mark (**CONNMARK**):

```
# nft add rule ip mangle PREROUTING counter meta mark set ct mark
```

In this command, the **nft** utility has a **mangle** table with the **PREROUTING** chain rule specification that alters incoming packets before routing to replace the packet mark with **CONNMARK**.

- j. If no **nft** table and chain exist, create a table and add a chain rule:

```
# nft add table ip mangle
# nft add chain ip mangle PREROUTING {type filter hook prerouting priority mangle \;}
```

- k. Set the meta mark on **tcp** packets that are received on the specified destination address **192.0.2.3**:

```
# nft add rule ip mangle PREROUTING ip daddr 192.0.2.3 counter meta mark set 0x64
```

- l. Save the packet mark into the connection mark:

```
# nft add rule ip mangle PREROUTING counter ct mark set mark
```

- m. Run the **iperf3** utility as the server on a system by using the **-s** parameter and the server then waits for the response of the client connection:

```
# iperf3 -s
```

2. On the client, run **iperf3** as a client and connect to the server that listens on IP address **192.0.2.3** for periodic HTTP request-response timestamp:

```
# iperf3 -c 192.0.2.3 -t TCP_STREAM | tee rate
```

192.0.2.3 is the IP address of the server while **192.0.2.4** is the IP address of the client.

3. Terminate the **iperf3** utility on the server by pressing **Ctrl+C**:

```
Accepted connection from 192.0.2.4, port 52128
[5] local 192.0.2.3 port 5201 connected to 192.0.2.4 port 52130
[ID] Interval      Transfer Bitrate
[5] 0.00-1.00 sec  119 KBytes 973 Kbits/sec
[5] 1.00-2.00 sec  116 KBytes 950 Kbits/sec
```

```
...
[ID] Interval      Transfer Bitrate
[5] 0.00-14.81 sec 1.51 MBytes 853 Kbits/sec receiver

iperf3: interrupt - the server has terminated
```

4. Terminate the **iperf3** utility on the client by pressing **Ctrl+C**:

```
Connecting to host 192.0.2.3, port 5201
[5] local 192.0.2.4 port 52130 connected to 192.0.2.3 port 5201
[ID] Interval      Transfer Bitrate   Retr Cwnd
[5] 0.00-1.00 sec  481 KBytes 3.94 Mb/s 0 76.4 KBytes
[5] 1.00-2.00 sec  223 KBytes 1.83 Mb/s 0 82.0 KBytes
...
[ID] Interval      Transfer Bitrate   Retr
[5] 0.00-14.00 sec  3.92 MBytes 2.35 Mb/s 32 sender
[5] 0.00-14.00 sec  0.00 Bytes 0.00 b/s receiver

iperf3: error - the server has terminated
```

Verification

1. Display the statistics about packet counts of the **htb** and **sfq** classes on the interface:

```
# tc -s qdisc show dev ifb4eth0

qdisc htb 1: root
...
Sent 26611455 bytes 3054 pkt (dropped 76, overlimits 4887 requeues 0)
...
qdisc sfq 8001: parent
...
Sent 26535030 bytes 2296 pkt (dropped 76, overlimits 0 requeues 0)
...
...
```

2. Display the statistics of packet counts for the **mirred** and **ctinfo** actions:

```
# tc -s filter show dev enp1s0 ingress
filter parent ffff: protocol ip pref 49152 u32 chain 0
filter parent ffff: protocol ip pref 49152 u32 chain 0 fh 800: ht divisor 1
filter parent ffff: protocol ip pref 49152 u32 chain 0 fh 800::800 order 2048 key ht 800 bkt 0
terminal flowid not_in_hw (rule hit 8075 success 8075)
  match 00000000/00000000 at 0 (success 8075 )
    action order 1: ctinfo zone 0 pipe
      index 1 ref 1 bind 1 cpmark 0x00000064 installed 3105 sec firstused 3105 sec DSCP set
0 error 0
  CPMARK set 7712
  Action statistics:
  Sent 25891504 bytes 3137 pkt (dropped 0, overlimits 0 requeues 0)
  backlog 0b 0p requeues 0

  action order 2: mirred (Egress Redirect to device ifb4eth0) stolen
    index 1 ref 1 bind 1 installed 3105 sec firstused 3105 sec
```

Action statistics:

```
Sent 25891504 bytes 3137 pkt (dropped 0, overlimits 61 requeues 0)
backlog 0b 0p requeues 0
```

3. Display the statistics of the **htb** rate-limiter and its configuration:

```
# tc -s class show dev ifb4eth0
class htb 1:100 root leaf 8001: prio 7 rate 1Mbit ceil 2Mbit burst 1600b cburst 1600b
Sent 26541716 bytes 2373 pkt (dropped 61, overlimits 4887 requeues 0)
backlog 0b 0p requeues 0
lended: 7248 borrowed: 0 giants: 0
tokens: 187250 ctokens: 93625
```

Additional resources

- **tc(8)** and **tc-ctinfo(8)** man page
- **nft(8)** man page

32.8. AVAILABLE QDISCS IN RHEL

Each **qdisc** addresses unique networking-related issues. The following is the list of **qdiscs** available in RHEL. You can use any of the following **qdisc** to shape network traffic based on your networking requirements.

Table 32.1. Available schedulers in RHEL

qdisc name	Included in	Offload support
Asynchronous Transfer Mode (ATM)	kernel-modules-extra	
Class-Based Queueing	kernel-modules-extra	
Credit-Based Shaper	kernel-modules-extra	Yes
CHOOSE and Keep for responsive flows, CHOOSE and Kill for unresponsive flows (CHOKe)	kernel-modules-extra	
Controlled Delay (CoDel)	kernel-core	
Deficit Round Robin (DRR)	kernel-modules-extra	
Differentiated Services marker (DSMARK)	kernel-modules-extra	
Enhanced Transmission Selection (ETS)	kernel-modules-extra	Yes
Fair Queue (FQ)	kernel-core	

qdisc name	Included in	Offload support
Fair Queuing Controlled Delay (FQ_CODEL)	kernel-core	
Generalized Random Early Detection (GRED)	kernel-modules-extra	
Hierarchical Fair Service Curve (HSFC)	kernel-core	
Heavy-Hitter Filter (HHF)	kernel-core	
Hierarchy Token Bucket (HTB)	kernel-core	
INGRESS	kernel-core	Yes
Multi Queue Priority (MQPRIO)	kernel-modules-extra	Yes
Multiqueue (MULTIQ)	kernel-modules-extra	Yes
Network Emulator (NETEM)	kernel-modules-extra	
Proportional Integral-controller Enhanced (PIE)	kernel-core	
PLUG	kernel-core	
Quick Fair Queueing (QFQ)	kernel-modules-extra	
Random Early Detection (RED)	kernel-modules-extra	Yes
Stochastic Fair Blue (SFB)	kernel-modules-extra	
Stochastic Fairness Queueing (SFQ)	kernel-core	
Token Bucket Filter (TBF)	kernel-core	Yes
Trivial Link Equalizer (TEQL)	kernel-modules-extra	

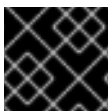

IMPORTANT

The **qdisc** offload requires hardware and driver support on NIC.

Additional resources

- **tc(8)** man page

CHAPTER 33. AUTHENTICATING A RHEL CLIENT TO THE NETWORK BY USING THE 802.1X STANDARD WITH A CERTIFICATE STORED ON THE FILE SYSTEM

Administrators frequently use port-based Network Access Control (NAC) based on the IEEE 802.1X standard to protect a network from unauthorized LAN and Wi-Fi clients. To enable a client to connect to such networks, you must configure 802.1X authentication on this clients.

33.1. CONFIGURING 802.1X NETWORK AUTHENTICATION ON AN EXISTING ETHERNET CONNECTION BY USING NMCLI

You can use the **nmcli** utility to configure an Ethernet connection with 802.1X network authentication on the command line.

Prerequisites

- The network supports 802.1X network authentication.
- The Ethernet connection profile exists in NetworkManager and has a valid IP configuration.
- The following files required for TLS authentication exist on the client:
 - The client key stored is in the **/etc/pki/tls/private/client.key** file, and the file is owned and only readable by the **root** user.
 - The client certificate is stored in the **/etc/pki/tls/certs/client.crt** file.
 - The Certificate Authority (CA) certificate is stored in the **/etc/pki/tls/certs/ca.crt** file.
- The **wpa_supplicant** package is installed.

Procedure

1. Set the Extensible Authentication Protocol (EAP) to **tls** and the paths to the client certificate and key file:

```
# nmcli connection modify enp1s0 802-1x.eap tls 802-1x.client-cert  
/etc/pki/tls/certs/client.crt 802-1x.private-key /etc/pki/tls/certs/certs/client.key
```

Note that you must set the **802-1x.eap**, **802-1x.client-cert**, and **802-1x.private-key** parameters in a single command.

2. Set the path to the CA certificate:

```
# nmcli connection modify enp1s0 802-1x.ca-cert /etc/pki/tls/certs/ca.crt
```

3. Set the identity of the user used in the certificate:

```
# nmcli connection modify enp1s0 802-1x.identity user@example.com
```

4. Optionally, store the password in the configuration:

```
# nmcli connection modify enp1s0 802-1x.private-key-password password
```

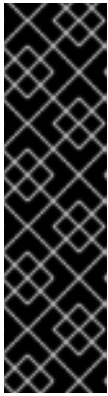

IMPORTANT

By default, NetworkManager stores the password in clear text in the `/etc/sysconfig/network-scripts/keys-connection_name` file, that is readable only by the **root** user. However, clear text passwords in a configuration file can be a security risk.

To increase the security, set the **802-1x.password-flags** parameter to **0x1**. With this setting, on servers with the GNOME desktop environment or the **nm-applet** running, NetworkManager retrieves the password from these services. In other cases, NetworkManager prompts for the password.

5. Activate the connection profile:

```
# nmcli connection up enp1s0
```

Verification

- Access resources on the network that require network authentication.

Additional resources

- [Configuring an Ethernet connection](#)
- **nm-settings(5)** man page
- **nmcli(1)** man page

33.2. CONFIGURING A STATIC ETHERNET CONNECTION WITH 802.1X NETWORK AUTHENTICATION BY USING NMSTATECTL

Use the **nmstatectl** utility to configure an Ethernet connection with 802.1X network authentication through the Nmstate API. The Nmstate API ensures that, after setting the configuration, the result matches the configuration file. If anything fails, **nmstatectl** automatically rolls back the changes to avoid leaving the system in an incorrect state.



NOTE

The **nmstate** library only supports the **TLS** Extensible Authentication Protocol (EAP) method.

Prerequisites

- The network supports 802.1X network authentication.
- The managed node uses NetworkManager.
- The following files required for TLS authentication exist on the client:
 - The client key stored is in the `/etc/pki/tls/private/client.key` file, and the file is owned and only readable by the **root** user.

- The client certificate is stored in the `/etc/pki/tls/certs/client.crt` file.
- The Certificate Authority (CA) certificate is stored in the `/etc/pki/tls/certs/ca.crt` file.

Procedure

1. Create a YAML file, for example `~/create-ethernet-profile.yml`, with the following content:

```
---
interfaces:
- name: enp1s0
  type: ethernet
  state: up
  ipv4:
    enabled: true
    address:
      - ip: 192.0.2.1
        prefix-length: 24
    dhcp: false
  ipv6:
    enabled: true
    address:
      - ip: 2001:db8:1::1
        prefix-length: 64
    autoconf: false
    dhcp: false
  802.1x:
    ca-cert: /etc/pki/tls/certs/ca.crt
    client-cert: /etc/pki/tls/certs/client.crt
    eap-methods:
      - tls
    identity: client.example.org
    private-key: /etc/pki/tls/private/client.key
    private-key-password: password
  routes:
    config:
      - destination: 0.0.0.0/0
        next-hop-address: 192.0.2.254
        next-hop-interface: enp1s0
      - destination: ::0
        next-hop-address: 2001:db8:1::fffe
        next-hop-interface: enp1s0
  dns-resolver:
    config:
      search:
        - example.com
      server:
        - 192.0.2.200
        - 2001:db8:1::ffbb
```

These settings define an Ethernet connection profile for the **enp1s0** device with the following settings:

- A static IPv4 address – **192.0.2.1** with a **/24** subnet mask
- A static IPv6 address – **2001:db8:1::1** with a **/64** subnet mask

- An IPv4 default gateway - **192.0.2.254**
 - An IPv6 default gateway - **2001:db8:1::fffe**
 - An IPv4 DNS server - **192.0.2.200**
 - An IPv6 DNS server - **2001:db8:1::ffbb**
 - A DNS search domain - **example.com**
 - 802.1X network authentication using the **TLS** EAP protocol
2. Apply the settings to the system:

```
# nmstatectl apply ~/create-ethernet-profile.yml
```

Verification

- Access resources on the network that require network authentication.

33.3. CONFIGURING A STATIC ETHERNET CONNECTION WITH 802.1X NETWORK AUTHENTICATION BY USING THE NETWORK RHEL SYSTEM ROLE

You can remotely configure an Ethernet connection with 802.1X network authentication by using the **network** RHEL system role.

Prerequisites

- [You have prepared the control node and the managed nodes](#)
- You are logged in to the control node as a user who can run playbooks on the managed nodes.
- The account you use to connect to the managed nodes has **sudo** permissions on them.
- The network supports 802.1X network authentication.
- The managed nodes uses NetworkManager.
- The following files required for TLS authentication exist on the control node:
 - The client key is stored in the **/srv/data/client.key** file.
 - The client certificate is stored in the **/srv/data/client.crt** file.
 - The Certificate Authority (CA) certificate is stored in the **/srv/data/ca.crt** file.

Procedure

1. Create a playbook file, for example **~/playbook.yml**, with the following content:

```
---  
- name: Configure an Ethernet connection with 802.1X authentication  
  hosts: managed-node-01.example.com  
  tasks:
```

```

- name: Copy client key for 802.1X authentication
  ansible.builtin.copy:
    src: "/srv/data/client.key"
    dest: "/etc/pki/tls/private/client.key"
    mode: 0600

- name: Copy client certificate for 802.1X authentication
  ansible.builtin.copy:
    src: "/srv/data/client.crt"
    dest: "/etc/pki/tls/certs/client.crt"

- name: Copy CA certificate for 802.1X authentication
  ansible.builtin.copy:
    src: "/srv/data/ca.crt"
    dest: "/etc/pki/ca-trust/source/anchors/ca.crt"

- name: Configure connection
  ansible.builtin.include_role:
    name: rhel-system-roles.network
  vars:
    network_connections:
      - name: enp1s0
        type: ethernet
        autoconnect: yes
        ip:
          address:
            - 192.0.2.1/24
            - 2001:db8:1::1/64
          gateway4: 192.0.2.254
          gateway6: 2001:db8:1::fffe
        dns:
          - 192.0.2.200
          - 2001:db8:1::ffbb
        dns_search:
          - example.com
    ieee802_1x:
      identity: user_name
      eap: tls
      private_key: "/etc/pki/tls/private/client.key"
      private_key_password: "password"
      client_cert: "/etc/pki/tls/certs/client.crt"
      ca_cert: "/etc/pki/ca-trust/source/anchors/ca.crt"
      domain_suffix_match: example.com
    state: up

```

These settings define an Ethernet connection profile for the **enp1s0** device with the following settings:

- A static IPv4 address - **192.0.2.1** with a **/24** subnet mask
- A static IPv6 address - **2001:db8:1::1** with a **/64** subnet mask
- An IPv4 default gateway - **192.0.2.254**
- An IPv6 default gateway - **2001:db8:1::fffe**

- An IPv4 DNS server - **192.0.2.200**
 - An IPv6 DNS server - **2001:db8:1::ffbb**
 - A DNS search domain - **example.com**
 - 802.1X network authentication using the **TLS** Extensible Authentication Protocol (EAP)
2. Validate the playbook syntax:

```
$ ansible-playbook --syntax-check ~/playbook.yml
```

Note that this command only validates the syntax and does not protect against a wrong but valid configuration.

3. Run the playbook:

```
$ ansible-playbook ~/playbook.yml
```

Additional resources

- `/usr/share/ansible/roles/rhel-system-roles.network/README.md` file
- `/usr/share/doc/rhel-system-roles/network/` directory

33.4. CONFIGURING A WIFI CONNECTION WITH 802.1X NETWORK AUTHENTICATION BY USING THE NETWORK RHEL SYSTEM ROLE

Using RHEL system role, you can automate the creation of a wifi connection. For example, you can remotely add a wireless connection profile for the **wlp1s0** interface using an Ansible Playbook. The created profile uses the 802.1X standard to authenticate the client to a wifi network. The playbook configures the connection profile to use DHCP. To configure static IP settings, adapt the parameters in the **ip** dictionary accordingly.

Prerequisites

- [You have prepared the control node and the managed nodes](#)
- You are logged in to the control node as a user who can run playbooks on the managed nodes.
- The account you use to connect to the managed nodes has **sudo** permissions on them.
- The network supports 802.1X network authentication.
- You installed the **wpa_supplicant** package on the managed node.
- DHCP is available in the network of the managed node.
- The following files required for TLS authentication exist on the control node:
 - The client key is stored in the `/srv/data/client.key` file.
 - The client certificate is stored in the `/srv/data/client.crt` file.
 - The CA certificate is stored in the `/srv/data/ca.crt` file.

Procedure

1. Create a playbook file, for example `~/playbook.yml`, with the following content:

```

---
- name: Configure a wifi connection with 802.1X authentication
  hosts: managed-node-01.example.com
  tasks:
    - name: Copy client key for 802.1X authentication
      ansible.builtin.copy:
        src: "/srv/data/client.key"
        dest: "/etc/pki/tls/private/client.key"
        mode: 0400

    - name: Copy client certificate for 802.1X authentication
      ansible.builtin.copy:
        src: "/srv/data/client.crt"
        dest: "/etc/pki/tls/certs/client.crt"

    - name: Copy CA certificate for 802.1X authentication
      ansible.builtin.copy:
        src: "/srv/data/ca.crt"
        dest: "/etc/pki/ca-trust/source/anchors/ca.crt"

    - block:
      - ansible.builtin.import_role:
          name: rhel-system-roles.network
        vars:
          network_connections:
            - name: Configure the Example-wifi profile
              interface_name: wlp1s0
              state: up
              type: wireless
              autoconnect: yes
              ip:
                dhcp4: true
                auto6: true
              wireless:
                ssid: "Example-wifi"
                key_mgmt: "wpa-eap"
              ieee802_1x:
                identity: "user_name"
                eap: tls
                private_key: "/etc/pki/tls/client.key"
                private_key_password: "password"
                private_key_password_flags: none
                client_cert: "/etc/pki/tls/client.pem"
                ca_cert: "/etc/pki/tls/cacert.pem"
                domain_suffix_match: "example.com"
  
```

These settings define a wifi connection profile for the **wlp1s0** interface. The profile uses 802.1X standard to authenticate the client to the wifi network. The connection retrieves IPv4 addresses, IPv6 addresses, default gateway, routes, DNS servers, and search domains from a DHCP server and IPv6 stateless address autoconfiguration (SLAAC).

2. Validate the playbook syntax:

```
$ ansible-playbook --syntax-check ~/playbook.yml
```

Note that this command only validates the syntax and does not protect against a wrong but valid configuration.

3. Run the playbook:

```
$ ansible-playbook ~/playbook.yml
```

Additional resources

- [/usr/share/ansible/roles/rhel-system-roles.network/README.md](#) file
- [/usr/share/doc/rhel-system-roles/network/](#) directory

CHAPTER 34. SETTING UP AN 802.1X NETWORK AUTHENTICATION SERVICE FOR LAN CLIENTS BY USING HOSTAPD WITH FREERADIUS BACKEND

The IEEE 802.1X standard defines secure authentication and authorization methods to protect networks from unauthorized clients. By using the **hostapd** service and FreeRADIUS, you can provide network access control (NAC) in your network.

In this documentation, the RHEL host acts as a bridge to connect different clients with an existing network. However, the RHEL host grants only authenticated clients access to the network.

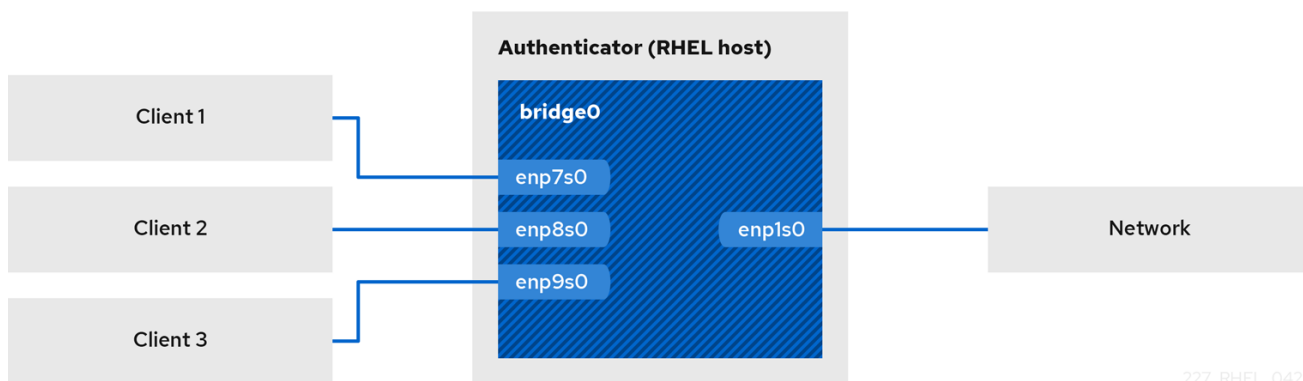

227_RHEL_0422

34.1. PREREQUISITES

- A clean installation of FreeRADIUS.
If the **freeradius** package is already installed, remove the **/etc/raddb/** directory, uninstall and then install the package again. Do not reinstall the package by using the **dnf reinstall** command, because the permissions and symbolic links in the **/etc/raddb/** directory are then different.

34.2. SETTING UP THE BRIDGE ON THE AUTHENTICATOR

A network bridge is a link-layer device which forwards traffic between hosts and networks based on a table of MAC addresses. If you set up RHEL as an 802.1X authenticator, add both the interfaces on which to perform authentication and the LAN interface to the bridge.

Prerequisites

- The server has multiple Ethernet interfaces.

Procedure

1. Create the bridge interface:

```
# nmcli connection add type bridge con-name br0 ifname br0
```

2. Assign the Ethernet interfaces to the bridge:

```
# nmcli connection add type ethernet slave-type bridge con-name br0-port1 ifname enp1s0 master br0
# nmcli connection add type ethernet slave-type bridge con-name br0-port2 ifname
```

```
enp7s0 master br0
# nmcli connection add type ethernet slave-type bridge con-name br0-port3 ifname
enp8s0 master br0
# nmcli connection add type ethernet slave-type bridge con-name br0-port4 ifname
enp9s0 master br0
```

3. Enable the bridge to forward extensible authentication protocol over LAN (EAPOL) packets:

```
# nmcli connection modify br0 group-forward-mask 8
```

4. Configure the connection to automatically activate the ports:

```
# nmcli connection modify br0 connection.autoconnect-slaves 1
```

5. Activate the connection:

```
# nmcli connection up br0
```

Verification

1. Display the link status of Ethernet devices that are ports of a specific bridge:

```
# ip link show master br0
3: enp1s0: <BROADCAST,MULTICAST,UP,LOWER_UP> mtu 1500 qdisc fq_codel master
br0 state UP mode DEFAULT group default qlen 1000
    link/ether 52:54:00:62:61:0e brd ff:ff:ff:ff:ff:ff
...
```

2. Verify if forwarding of EAPOL packets is enabled on the **br0** device:

```
# cat /sys/class/net/br0/bridge/group_fwd_mask
0x8
```

If the command returns **0x8**, forwarding is enabled.

Additional resources

- [nm-settings\(5\) man page](#)

34.3. CERTIFICATE REQUIREMENTS BY FREERADIUS

For a secure FreeRADIUS service, you require TLS certificates for different purposes:

- A TLS server certificate for encrypted connections to the server. Use a trusted certificate authority (CA) to issue the certificate. The server certificate requires the extended key usage (EKU) field set to **TLS Web Server Authentication**.
- Client certificates issued by the same CA for extended authentication protocol transport layer security (EAP-TLS). EAP-TLS provides certificate-based authentication and is enabled by default. The client certificates require their EKU field set to **TLS Web Client Authentication**.



WARNING

To secure connection, use your company's CA or create your own CA to issue certificates for FreeRADIUS. If you use a public CA, you allow it to authenticate users and issue client certificates for EAP-TLS.

34.4. CREATING A SET OF CERTIFICATES ON A FREERADIUS SERVER FOR TESTING PURPOSES

For testing purposes, the **freeradius** package installs scripts and configuration files in the **/etc/raddb/certs/** directory to create your own certificate authority (CA) and issue certificates.



IMPORTANT

If you use the default configuration, certificates generated by these scripts expire after 60 days and keys use an insecure password ("whatever"). However, you can customize the CA, server, and client configuration.

After you perform the procedure, the following files, which you require later in this documentation, are created:

- **/etc/raddb/certs/ca.pem**: CA certificate
- **/etc/raddb/certs/server.key**: Private key of the server certificate
- **/etc/raddb/certs/server.pem**: Server certificate
- **/etc/raddb/certs/client.key**: Private key of the client certificate
- **/etc/raddb/certs/client.pem**: Client certificate

Prerequisites

- You installed the **freeradius** package.

Procedure

1. Change into the **/etc/raddb/certs/** directory:

```
# cd /etc/raddb/certs/
```

2. Optional: Customize the CA configuration in the **/etc/raddb/certs/ca.cnf** file:

```
...
[ req ]
default_bits      = 2048
input_password    = ca_password
output_password   = ca_password
...
```

```
[certificate_authority]
countryName          = US
stateOrProvinceName = North Carolina
localityName         = Raleigh
organizationName     = Example Inc.
emailAddress         = admin@example.org
commonName           = "Example Certificate Authority"
...
```

- Optional: Customize the server configuration in the `/etc/raddb/certs/server.cnf` file::

```
...
[ CA_default ]
default_days        = 730
...
[ req ]
distinguished_name = server
default_bits       = 2048
input_password     = key_password
output_password    = key_password
...
[server]
countryName        = US
stateOrProvinceName = North Carolina
localityName       = Raleigh
organizationName   = Example Inc.
emailAddress       = admin@example.org
commonName         = "Example Server Certificate"
...
```

- Optional: Customize the client configuration in the `/etc/raddb/certs/client.cnf` file::

```
...
[ CA_default ]
default_days        = 365
...
[ req ]
distinguished_name = client
default_bits       = 2048
input_password     = password_on_private_key
output_password    = password_on_private_key
...
[client]
countryName        = US
stateOrProvinceName = North Carolina
localityName       = Raleigh
organizationName   = Example Inc.
emailAddress       = user@example.org
commonName         = user@example.org
...
```

- Create the certificates:

```
# make all
```

- Change the group on the `/etc/raddb/certs/server.pem` file to **radiusd**:

```
# chgrp radiusd /etc/raddb/certs/server.pem
```

Additional resources

- `/etc/raddb/certs/README.md`

34.5. CONFIGURING FREERADIUS TO AUTHENTICATE NETWORK CLIENTS SECURELY BY USING EAP

FreeRADIUS supports different methods of the Extensible authentication protocol (EAP). However, for a secure network, configure FreeRADIUS to support only the following secure EAP authentication methods:

- EAP-TLS (transport layer security) uses a secure TLS connection to authenticate clients by using certificates. To use EAP-TLS, you need TLS client certificates for each network client and a server certificate for the server. Note that the same certificate authority (CA) must have issued the certificates. Always use your own CA to create certificates, because all client certificates issued by the CA you use can authenticate to your FreeRADIUS server.
- EAP-TTLS (tunneled transport layer security) uses a secure TLS connection and authenticates clients by using mechanisms, such as password authentication protocol (PAP) or challenge handshake authentication protocol (CHAP). To use EAP-TTLS, you need a TLS server certificate.
- EAP-PEAP (protected extensible authentication protocol) uses a secure TLS connection as the outer authentication protocol to set up the tunnel. The authenticator authenticates the certificate of the RADIUS server. Afterwards, the supplicant authenticates through the encrypted tunnel by using Microsoft challenge handshake authentication protocol version 2 (MS-CHAPv2) or other methods.



NOTE

The default FreeRADIUS configuration files serve as documentation and describe all parameters and directives. If you want to disable certain features, comment them out instead of removing the corresponding parts in the configuration files. This enables you to preserve the structure of the configuration files and the included documentation.

Prerequisites

- You installed the **freeradius** package.
- The configuration files in the `/etc/raddb/` directory are unchanged and as provided by the **freeradius** package.
- The following files exist on the server:
 - TLS private key of the FreeRADIUS host: `/etc/raddb/certs/server.key`
 - TLS server certificate of the FreeRADIUS host: `/etc/raddb/certs/server.pem`
 - TLS CA certificate: `/etc/raddb/certs/ca.pem`

If you store the files in a different location or if they have different names, set the **private_key_file**, **certificate_file**, and **ca_file** parameters in the **/etc/raddb/mods-available/eap** file accordingly.

Procedure

1. If the **/etc/raddb/certs/dh** with Diffie-Hellman (DH) parameters does not exist, create one. For example, to create a DH file with a 2048 bits prime, enter:

```
# openssl dhparam -out /etc/raddb/certs/dh 2048
```

For security reasons, do not use a DH file with less than a 2048 bits prime. Depending on the number of bits, the creation of the file can take several minutes.

2. Set secure permissions on the TLS private key, server certificate, CA certificate, and the file with DH parameters:

```
# chmod 640 /etc/raddb/certs/server.key /etc/raddb/certs/server.pem
/etc/raddb/certs/ca.pem /etc/raddb/certs/dh
# chown root:radiusd /etc/raddb/certs/server.key /etc/raddb/certs/server.pem
/etc/raddb/certs/ca.pem /etc/raddb/certs/dh
```

3. Edit the **/etc/raddb/mods-available/eap** file:

- a. Set the password of the private key in the **private_key_password** parameter:

```
eap {
  ...
  tls-config tls-common {
    ...
    private_key_password = key_password
    ...
  }
}
```

- b. Depending on your environment, set the **default_eap_type** parameter in the **eap** directive to your primary EAP type you use:

```
eap {
  ...
  default_eap_type = ttls
  ...
}
```

For a secure environment, use only **ttls**, **tls**, or **peap**.

- c. Comment out the **md5** directives to disable the insecure EAP-MD5 authentication method:

```
eap {
  ...
  # md5 {
  # }
  ...
}
```

Note that, in the default configuration file, other insecure EAP authentication methods are commented out by default.

4. Edit the `/etc/raddb/sites-available/default` file, and comment out all authentication methods other than **eap**:

```
authenticate {
    ...
    # Auth-Type PAP {
    #   pap
    # }

    # Auth-Type CHAP {
    #   chap
    # }

    # Auth-Type MS-CHAP {
    #   mschap
    # }

    # mschap

    # digest
    ...
}
```

This leaves only EAP enabled and disables plain-text authentication methods.

5. Edit the `/etc/raddb/clients.conf` file:
 - a. Set a secure password in the **localhost** and **localhost_ipv6** client directives:

```
client localhost {
    ipaddr = 127.0.0.1
    ...
    secret = client_password
    ...
}

client localhost_ipv6 {
    ipv6addr = ::1
    secret = client_password
}
```

- b. If RADIUS clients, such as network authenticators, on remote hosts should be able to access the FreeRADIUS service, add corresponding client directives for them:

```
client hostapd.example.org {
    ipaddr = 192.0.2.2/32
    secret = client_password
}
```

The **ipaddr** parameter accepts IPv4 and IPv6 addresses, and you can use the optional classless inter-domain routing (CIDR) notation to specify ranges. However, you can set only one value in this parameter. For example, to grant access to an IPv4 and IPv6 address, add two client directives.

Use a descriptive name for the client directive, such as a hostname or a word that describes where the IP range is used.

6. If you want to use EAP-TTLS or EAP-PEAP, add the users to the `/etc/raddb/users` file:

```
example_user    Cleartext-Password := "user_password"
```

For users who should use certificate-based authentication (EAP-TLS), do not add any entry.

7. Verify the configuration files:

```
# radiusd -XC
...
Configuration appears to be OK
```

8. Enable and start the `radiusd` service:

```
# systemctl enable --now radiusd
```

Verification

- [Testing EAP-TTLS authentication against a FreeRADIUS server or authenticator](#)
- [Testing EAP-TLS authentication against a FreeRADIUS server or authenticator](#)

Troubleshooting

1. Stop the `radiusd` service:

```
# systemctl stop radiusd
```

2. Start the service in debug mode:

```
# radiusd -X
...
Ready to process requests
```

3. Perform authentication tests on the FreeRADIUS host, as referenced in the **Verification** section.

Next steps

- Disable no longer required authentication methods and other features you do not use.

34.6. CONFIGURING HOSTAPD AS AN AUTHENTICATOR IN A WIRED NETWORK

The host access point daemon (`hostapd`) service can act as an authenticator in a wired network to provide 802.1X authentication. For this, the `hostapd` service requires a RADIUS server that authenticates the clients.

The **hostapd** service provides an integrated RADIUS server. However, use the integrated RADIUS server only for testing purposes. For production environments, use FreeRADIUS server, which supports additional features, such as different authentication methods and access control.



IMPORTANT

The **hostapd** service does not interact with the traffic plane. The service acts only as an authenticator. For example, use a script or service that uses the **hostapd** control interface to allow or deny traffic based on the result of authentication events.

Prerequisites

- You installed the **hostapd** package.
- The FreeRADIUS server has been configured, and it is ready to authenticate clients.

Procedure

1. Create the **/etc/hostapd/hostapd.conf** file with the following content:

```
# General settings of hostapd
# =====

# Control interface settings
ctrl_interface=/var/run/hostapd
ctrl_interface_group=wheel

# Enable logging for all modules
logger_syslog=-1
logger_stdout=-1

# Log level
logger_syslog_level=2
logger_stdout_level=2

# Wired 802.1X authentication
# =====

# Driver interface type
driver=wired

# Enable IEEE 802.1X authorization
ieee8021x=1

# Use port access entry (PAE) group address
# (01:80:c2:00:00:03) when sending EAPOL frames
use_pae_group_addr=1

# Network interface for authentication requests
interface=br0

# RADIUS client configuration
```

```
# =====  
  
# Local IP address used as NAS-IP-Address  
own_ip_addr=192.0.2.2  
  
# Unique NAS-Identifier within scope of RADIUS server  
nas_identifier=hostapd.example.org  
  
# RADIUS authentication server  
auth_server_addr=192.0.2.1  
auth_server_port=1812  
auth_server_shared_secret=client_password  
  
# RADIUS accounting server  
acct_server_addr=192.0.2.1  
acct_server_port=1813  
acct_server_shared_secret=client_password
```

For further details about the parameters used in this configuration, see their descriptions in the [/usr/share/doc/hostapd/hostapd.conf](#) example configuration file.

2. Enable and start the **hostapd** service:

```
# systemctl enable --now hostapd
```

Verification

- See:
 - [Testing EAP-TTLS authentication against a FreeRADIUS server or authenticator](#)
 - [Testing EAP-TLS authentication against a FreeRADIUS server or authenticator](#)

Troubleshooting

1. Stop the **hostapd** service:

```
# systemctl stop hostapd
```

2. Start the service in debug mode:

```
# hostapd -d /etc/hostapd/hostapd.conf
```

3. Perform authentication tests on the FreeRADIUS host, as referenced in the **Verification** section.

Additional resources

- **hostapd.conf(5)** man page
- [/usr/share/doc/hostapd/hostapd.conf](#) file

34.7. TESTING EAP-TTLS AUTHENTICATION AGAINST A FREERADIUS SERVER OR AUTHENTICATOR

To test if authentication by using extensible authentication protocol (EAP) over tunneled transport layer security (EAP-TTLS) works as expected, run this procedure:

- After you set up the FreeRADIUS server
- After you set up the **hostapd** service as an authenticator for 802.1X network authentication.

The output of the test utilities used in this procedure provide additional information about the EAP communication and help you to debug problems.

Prerequisites

- When you want to authenticate to:
 - A FreeRADIUS server:
 - The **eapol_test** utility, provided by the **hostapd** package, is installed.
 - The client, on which you run this procedure, has been authorized in the FreeRADIUS server's client databases.
 - An authenticator, the **wpa_supplicant** utility, provided by the same-named package, is installed.
- You stored the certificate authority (CA) certificate in the **/etc/pki/tls/certs/ca.pem** file.

Procedure

1. Create the **/etc/wpa_supplicant/wpa_supplicant-TTLS.conf** file with the following content:

```
ap_scan=0

network={
    eap=TTLS
    eapol_flags=0
    key_mgmt=IEEE8021X

    # Anonymous identity (sent in unencrypted phase 1)
    # Can be any string
    anonymous_identity="anonymous"

    # Inner authentication (sent in TLS-encrypted phase 2)
    phase2="auth=PAP"
    identity="example_user"
    password="user_password"

    # CA certificate to validate the RADIUS server's identity
    ca_cert="/etc/pki/tls/certs/ca.pem"
}
```

2. To authenticate to:
 - A FreeRADIUS server, enter:

```
# eapol_test -c /etc/wpa_supplicant/wpa_supplicant-TTLS.conf -a 192.0.2.1 -s
client_password
...
EAP: Status notification: remote certificate verification (param=success)
...
CTRL-EVENT-EAP-SUCCESS EAP authentication completed successfully
...
SUCCESS
```

The **-a** option defines the IP address of the FreeRADIUS server, and the **-s** option specifies the password for the host on which you run the command in the FreeRADIUS server's client configuration.

- An authenticator, enter:

```
# wpa_supplicant -c /etc/wpa_supplicant/wpa_supplicant-TTLS.conf -D wired -i
enp0s31f6
...
enp0s31f6: CTRL-EVENT-EAP-SUCCESS EAP authentication completed successfully
...
```

The **-i** option specifies the network interface name on which **wpa_supplicant** sends out extended authentication protocol over LAN (EAPOL) packets.

For more debugging information, pass the **-d** option to the command.

Additional resources

- `/usr/share/doc/wpa_supplicant/wpa_supplicant.conf` file

34.8. TESTING EAP-TLS AUTHENTICATION AGAINST A FREERADIUS SERVER OR AUTHENTICATOR

To test if authentication by using extensible authentication protocol (EAP) transport layer security (EAP-TLS) works as expected, run this procedure:

- After you set up the FreeRADIUS server
- After you set up the **hostapd** service as an authenticator for 802.1X network authentication.

The output of the test utilities used in this procedure provide additional information about the EAP communication and help you to debug problems.

Prerequisites

- When you want to authenticate to:
 - A FreeRADIUS server:
 - The **eapol_test** utility, provided by the **hostapd** package, is installed.
 - The client, on which you run this procedure, has been authorized in the FreeRADIUS server's client databases.

- An authenticator, the **wpa_supplicant** utility, provided by the same-named package, is installed.
- You stored the certificate authority (CA) certificate in the **/etc/pki/tls/certs/ca.pem** file.
- The CA that issued the client certificate is the same that issued the server certificate of the FreeRADIUS server.
- You stored the client certificate in the **/etc/pki/tls/certs/client.pem** file.
- You stored the private key of the client in the **/etc/pki/tls/private/client.key**

Procedure

1. Create the **/etc/wpa_supplicant/wpa_supplicant-TLS.conf** file with the following content:

```
ap_scan=0

network={
    eap=TLS
    eapol_flags=0
    key_mgmt=IEEE8021X

    identity="user@example.org"
    client_cert="/etc/pki/tls/certs/client.pem"
    private_key="/etc/pki/tls/private/client.key"
    private_key_passwd="password_on_private_key"

    # CA certificate to validate the RADIUS server's identity
    ca_cert="/etc/pki/tls/certs/ca.pem"
}
```

2. To authenticate to:

- A FreeRADIUS server, enter:

```
# eapol_test -c /etc/wpa_supplicant/wpa_supplicant-TLS.conf -a 192.0.2.1 -s
client_password
...
EAP: Status notification: remote certificate verification (param=success)
...
CTRL-EVENT-EAP-SUCCESS EAP authentication completed successfully
...
SUCCESS
```

The **-a** option defines the IP address of the FreeRADIUS server, and the **-s** option specifies the password for the host on which you run the command in the FreeRADIUS server's client configuration.

- An authenticator, enter:

```
# wpa_supplicant -c /etc/wpa_supplicant/wpa_supplicant-TLS.conf -D wired -i
enp0s31f6
...
enp0s31f6: CTRL-EVENT-EAP-SUCCESS EAP authentication completed successfully
...
```

The **-i** option specifies the network interface name on which **wpa_supplicant** sends out extended authentication protocol over LAN (EAPOL) packets.

For more debugging information, pass the **-d** option to the command.

Additional resources

- `/usr/share/doc/wpa_supplicant/wpa_supplicant.conf` file

34.9. BLOCKING AND ALLOWING TRAFFIC BASED ON HOSTAPD AUTHENTICATION EVENTS

The **hostapd** service does not interact with the traffic plane. The service acts only as an authenticator. However, you can write a script to allow and deny traffic based on the result of authentication events.

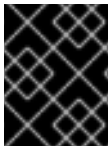

IMPORTANT

This procedure is not supported and is no enterprise-ready solution. It only demonstrates how to block or allow traffic by evaluating events retrieved by **hostapd_cli**.

When the **802-1x-tr-mgmt** systemd service starts, RHEL blocks all traffic on the listen port of **hostapd** except extensible authentication protocol over LAN (EAPOL) packets and uses the **hostapd_cli** utility to connect to the **hostapd** control interface. The `/usr/local/bin/802-1x-tr-mgmt` script then evaluates events. Depending on the different events received by **hostapd_cli**, the script allows or blocks traffic for MAC addresses. Note that, when the **802-1x-tr-mgmt** service stops, all traffic is automatically allowed again.

Perform this procedure on the **hostapd** server.

Prerequisites

- The **hostapd** service has been configured, and the service is ready to authenticate clients.

Procedure

1. Create the `/usr/local/bin/802-1x-tr-mgmt` file with the following content:

```
#!/bin/sh

if [ "$1" == "xblock_all" ]
then

    nft delete table bridge tr-mgmt-br0 2>/dev/null || true
    nft -f - << EOF
table bridge tr-mgmt-br0 {
    set allowed_macs {
        type ether_addr
    }

    chain accesscontrol {
        ether saddr @allowed_macs accept
        ether daddr @allowed_macs accept
        drop
    }
}
```



```

        chain forward {
            type filter hook forward priority 0; policy accept;
            meta ibrname "br0" jump accesscontrol
        }
    }
EOF
    echo "802-1x-tr-mgmt Blocking all traffic through br0. Traffic for given host will be allowed
after 802.1x authentication"

elif [ "x$1" == "xallow_all" ]
then

    nft delete table bridge tr-mgmt-br0
    echo "802-1x-tr-mgmt Allowed all forwarding again"

fi

case ${2:-NOTANEVENT} in

    AP-STA-CONNECTED | CTRL-EVENT-EAP-SUCCESS | CTRL-EVENT-EAP-
SUCCESS2)
        nft add element bridge tr-mgmt-br0 allowed_macs { $3 }
        echo "$1: Allowed traffic from $3"
        ;;

    AP-STA-DISCONNECTED | CTRL-EVENT-EAP-FAILURE)
        nft delete element bridge tr-mgmt-br0 allowed_macs { $3 }
        echo "802-1x-tr-mgmt $1: Denied traffic from $3"
        ;;

esac

```

2. Create the `/etc/systemd/system/802-1x-tr-mgmt@.service` systemd service file with the following content:

```

[Unit]
Description=Example 802.1x traffic management for hostapd
After=hostapd.service
After=sys-devices-virtual-net-%i.device

[Service]
Type=simple
ExecStartPre=-/bin/sh -c '/usr/sbin/tc qdisc del dev %i ingress > /dev/null 2>&1'
ExecStartPre=-/bin/sh -c '/usr/sbin/tc qdisc del dev %i clsact > /dev/null 2>&1'
ExecStartPre=/usr/sbin/tc qdisc add dev %i clsact
ExecStartPre=/usr/sbin/tc filter add dev %i ingress pref 10000 protocol 0x888e matchall
action ok index 100
ExecStartPre=/usr/sbin/tc filter add dev %i ingress pref 10001 protocol all matchall action
drop index 101
ExecStart=/usr/sbin/hostapd_cli -i %i -a /usr/local/bin/802-1x-tr-mgmt
ExecStopPost=-/usr/sbin/tc qdisc del dev %i clsact

[Install]
WantedBy=multi-user.target

```

3. Reload systemd:

```
# systemctl daemon-reload
```

4. Enable and start the **802-1x-tr-mgmt** service with the interface name **hostapd** is listening on:

```
# systemctl enable --now 802-1x-tr-mgmt@br0.service
```

Verification

- Authenticate with a client to the network. See:
 - [Testing EAP-TTLS authentication against a FreeRADIUS server or authenticator](#)
 - [Testing EAP-TLS authentication against a FreeRADIUS server or authenticator](#)

Additional resources

- **systemd.service(5)** man page

CHAPTER 35. GETTING STARTED WITH MULTIPATH TCP

Transmission Control Protocol (TCP) ensures reliable delivery of the data through the internet and automatically adjusts its bandwidth in response to network load. Multipath TCP (MPTCP) is an extension to the original TCP protocol (single-path). MPTCP enables a transport connection to operate across multiple paths simultaneously, and brings network connection redundancy to user endpoint devices.

35.1. UNDERSTANDING MPTCP

The Multipath TCP (MPTCP) protocol allows for simultaneous usage of multiple paths between connection endpoints. The protocol design improves connection stability and also brings other benefits compared to the single-path TCP.



NOTE

In MPTCP terminology, links are considered as paths.

The following are some of the advantages of using MPTCP:

- It allows a connection to simultaneously use multiple network interfaces.
- In case a connection is bound to a link speed, the usage of multiple links can increase the connection throughput. Note, that in case of the connection is bound to a CPU, the usage of multiple links causes the connection slowdown.
- It increases the resilience to link failures.

For more details about MPTCP, we highly recommend you review the *Additional resources*.

Additional resources

- [Understanding Multipath TCP: High availability for endpoints and the networking highway of the future](#)
- [RFC8684: TCP Extensions for Multipath Operation with Multiple Addresses](#)

35.2. PREPARING RHEL TO ENABLE MPTCP SUPPORT

By default the MPTCP support is disabled in RHEL. Enable MPTCP so that applications that support this feature can use it. Additionally, you have to configure user space applications to force use MPTCP sockets if those applications have TCP sockets by default.

Prerequisites

The following packages are installed:

- **iperf3**
- **mptcpd**
- **systemtap**

Procedure

1. Enable MPTCP sockets in the kernel:

```
# echo "net.mptcp.enabled=1" > /etc/sysctl.d/90-enable-MPTCP.conf
# sysctl -p /etc/sysctl.d/90-enable-MPTCP.conf
```

2. Start the **iperf3** server, and force it to create MPTCP sockets instead of TCP sockets:

```
# mptcpize run iperf3 -s

Server listening on 5201
```

3. Connect the client to the server, and force it to create MPTCP sockets instead of TCP sockets:

```
# mptcpize iperf3 -c 127.0.0.1 -t 3
```

4. After the connection is established, verify the **ss** output to see the subflow-specific status:

```
# ss -nti '( dport :5201 )'

State Recv-Q Send-Q Local Address:Port Peer Address:Port Process
ESTAB 0 0 127.0.0.1:41842 127.0.0.1:5201
cubic wscale:7,7 rto:205 rtt:4.455/8.878 ato:40 mss:21888 pmtu:65535 rcvmss:536
advms:65483 cwnd:10 bytes_sent:141 bytes_acked:142 bytes_received:4 segs_out:8
segs_in:7 data_segs_out:3 data_segs_in:3 send 393050505bps lastsnd:2813 lastrcv:2772
lastack:2772 pacing_rate 785946640bps delivery_rate 10944000000bps delivered:4
busy:41ms rcv_space:43690 rcv_ssthresh:43690 minrtt:0.008 tcp-ulp-mptcp flags:Mmec
token:0000(id:0)/2ff053ec(id:0) seq:3e2cbea12d7673d4 sfseq:3 ssnoff:ad3d00f4 maplen:2
```

5. Verify MPTCP counters:

```
# nstat MPTcp*

#kernel
MPTcpExtMPCapableSYNRX      2      0.0
MPTcpExtMPCapableSYNTAX    2      0.0
MPTcpExtMPCapableSYNACKRX  2      0.0
MPTcpExtMPCapableACKRX     2      0.0
```

Additional resources

- [tcp\(7\)](#) man page
- [mptcpize\(8\)](#) man page

35.3. USING IPROUTE2 TO TEMPORARILY CONFIGURE AND ENABLE MULTIPLE PATHS FOR MPTCP APPLICATIONS

Each MPTCP connection uses a single subflow similar to plain TCP. To get the MPTCP benefits, specify a higher limit for maximum number of subflows for each MPTCP connection. Then configure additional endpoints to create those subflows.



IMPORTANT

The configuration in this procedure will not persist after rebooting your machine.

Note that MPTCP does not yet support mixed IPv6 and IPv4 endpoints for the same socket. Use endpoints belonging to the same address family.

Prerequisites

- The **mptcpd** package is installed
- The **iperf3** package is installed
- Server network interface settings:
 - enp4s0: **192.0.2.1/24**
 - enp1s0: **198.51.100.1/24**
- Client network interface settings:
 - enp4s0f0: **192.0.2.2/24**
 - enp4s0f1: **198.51.100.2/24**

Procedure

1. Configure the client to accept up to 1 additional remote address, as provided by the server:

```
# ip mptcp limits set add_addr_accepted 1
```

2. Add IP address **198.51.100.1** as a new MPTCP endpoint on the server:

```
# ip mptcp endpoint add 198.51.100.1 dev enp1s0 signal
```

The **signal** option ensures that the **ADD_ADDR** packet is sent after the three-way-handshake.

3. Start the **iperf3** server, and force it to create MPTCP sockets instead of TCP sockets:

```
# mptcpize run iperf3 -s
```

```
Server listening on 5201
```

4. Connect the client to the server, and force it to create MPTCP sockets instead of TCP sockets:

```
# mptcpize iperf3 -c 192.0.2.1 -t 3
```

Verification

1. Verify the connection is established:

```
# ss -nti '( sport :5201 )'
```

2. Verify the connection and IP address limit:

ip mptcp limit show

3. Verify the newly added endpoint:

ip mptcp endpoint show

4. Verify MPTCP counters by using the **nstat MPTcp*** command on a server:

```
# nstat MPTcp*

#kernel
MPTcpExtMPCapableSYNRX      2          0.0
MPTcpExtMPCapableACKRX      2          0.0
MPTcpExtMPJoinSynRx         2          0.0
MPTcpExtMPJoinAckRx         2          0.0
MPTcpExtEchoAdd             2          0.0
```

Additional resources

- **ip-mptcp(8)** man page
- **mptcpize(8)** man page

35.4. PERMANENTLY CONFIGURING MULTIPLE PATHS FOR MPTCP APPLICATIONS

You can configure MultiPath TCP (MPTCP) using the **nmcli** command to permanently establish multiple subflows between a source and destination system. The subflows can use different resources, different routes to the destination, and even different networks. Such as Ethernet, cellular, wifi, and so on. As a result, you achieve combined connections, which increase network resilience and throughput.

The server uses the following network interfaces in our example:

- enp4s0: **192.0.2.1/24**
- enp1s0: **198.51.100.1/24**
- enp7s0: **192.0.2.3/24**

The client uses the following network interfaces in our example:

- enp4s0f0: **192.0.2.2/24**
- enp4s0f1: **198.51.100.2/24**
- enp6s0: **192.0.2.5/24**

Prerequisites

- You configured the default gateway on the relevant interfaces.

Procedure

1. Enable MPTCP sockets in the kernel:

```
# echo "net.mptcp.enabled=1" > /etc/sysctl.d/90-enable-MPTCP.conf
# sysctl -p /etc/sysctl.d/90-enable-MPTCP.conf
```

2. Optional: The RHEL kernel default for subflow limit is 2. If you require more:

a. Create the `/etc/systemd/system/set_mptcp_limit.service` file with the following content:

```
[Unit]
Description=Set MPTCP subflow limit to 3
After=network.target

[Service]
ExecStart=ip mptcp limits set subflows 3
Type=oneshot

[Install]
WantedBy=multi-user.target
```

The **oneshot** unit executes the **ip mptcp limits set subflows 3** command after your network (**network.target**) is operational during every boot process.

The **ip mptcp limits set subflows 3** command sets the maximum number of *additional* subflows for each connection, so 4 in total. It is possible to add maximally 3 additional subflows.

b. Enable the **set_mptcp_limit** service:

```
# systemctl enable --now set_mptcp_limit
```

3. Enable MPTCP on all connection profiles that you want to use for connection aggregation:

```
# nmcli connection modify <profile_name> connection.mptcp-flags
signal,subflow,also-without-default-route
```

The **connection.mptcp-flags** parameter configures MPTCP endpoints and the IP address flags. If MPTCP is enabled in a NetworkManager connection profile, the setting will configure the IP addresses of the relevant network interface as MPTCP endpoints.

By default, NetworkManager does not add MPTCP flags to IP addresses if there is no default gateway. If you want to bypass that check, you need to use also the **also-without-default-route** flag.

Verification

1. Verify that you enabled the MPTCP kernel parameter:

```
# sysctl net.mptcp.enabled
net.mptcp.enabled = 1
```

2. Verify that you set the subflow limit correctly, in case the default was not enough:

```
# ip mptcp limit show
add_addr_accepted 2 subflows 3
```

3. Verify that you configured the per-address MPTCP setting correctly:

```
# ip mptcp endpoint show
192.0.2.1 id 1 subflow dev enp4s0
198.51.100.1 id 2 subflow dev enp1s0
192.0.2.3 id 3 subflow dev enp7s0
192.0.2.4 id 4 subflow dev enp3s0
...
```

Additional resources

- [nm-settings-nmcli\(5\)](#)
- [ip-mptcp\(8\)](#)
- [Section 35.1, “Understanding MPTCP”](#)
- [Understanding Multipath TCP: High availability for endpoints and the networking highway of the future](#)
- [RFC8684: TCP Extensions for Multipath Operation with Multiple Addresses](#)
- [Using Multipath TCP to better survive outages and increase bandwidth](#)

35.5. MONITORING MPTCP SUB-FLOWS

The life cycle of a multipath TCP (MPTCP) socket can be complex: The main MPTCP socket is created, the MPTCP path is validated, one or more sub-flows are created and eventually removed. Finally, the MPTCP socket is terminated.

The MPTCP protocol allows monitoring MPTCP-specific events related to socket and sub-flow creation and deletion, using the **ip** utility provided by the **iproute** package. This utility uses the **netlink** interface to monitor MPTCP events.

This procedure demonstrates how to monitor MPTCP events. For that, it simulates a MPTCP server application, and a client connects to this service. The involved clients in this example use the following interfaces and IP addresses:

- Server: **192.0.2.1**
- Client (Ethernet connection): **192.0.2.2**
- Client (WiFi connection): **192.0.2.3**

To simplify this example, all interfaces are within the same subnet. This is not a requirement. However, it is important that routing has been configured correctly, and the client can reach the server via both interfaces.

Prerequisites

- A RHEL client with two network interfaces, such as a laptop with Ethernet and WiFi
- The client can connect to the server via both interfaces
- A RHEL server

- Both the client and the server run RHEL 9.0 or later
- You installed the **mptcpd** package on both the client and the server

Procedure

1. Set the per connection additional subflow limits to **1** on both client and server:

```
# ip mptcp limits set add_addr_accepted 0 subflows 1
```

2. On the server, to simulate a MPTCP server application, start **netcat (nc)** in listen mode with enforced MPTCP sockets instead of TCP sockets:

```
# mptcpize run nc -l -k -p 12345
```

The **-k** option causes that **nc** does not close the listener after the first accepted connection. This is required to demonstrate the monitoring of sub-flows.

3. On the client:
 - a. Identify the interface with the lowest metric:

```
# ip -4 route
192.0.2.0/24 dev enp1s0 proto kernel scope link src 192.0.2.2 metric 100
192.0.2.0/24 dev wlp1s0 proto kernel scope link src 192.0.2.3 metric 600
```

The **enp1s0** interface has a lower metric than **wlp1s0**. Therefore, RHEL uses **enp1s0** by default.

- b. On the first terminal, start the monitoring:

```
# ip mptcp monitor
```

- c. On the second terminal, start a MPTCP connection to the server:

```
# mptcpize run nc 192.0.2.1 12345
```

RHEL uses the **enp1s0** interface and its associated IP address as a source for this connection.

On the monitoring terminal, the **ip mptcp monitor** command now logs:

```
[   CREATED] token=63c070d2 remid=0 locid=0 saddr4=192.0.2.2 daddr4=192.0.2.1
sport=36444 dport=12345
```

The token identifies the MPTCP socket as an unique ID, and later it enables you to correlate MPTCP events on the same socket.

- d. On the terminal with the running **nc** connection to the server, press **Enter**. This first data packet fully establishes the connection. Note that, as long as no data has been sent, the connection is not established.

On the monitoring terminal, **ip mptcp monitor** now logs:

```
[ ESTABLISHED] token=63c070d2 remid=0 locid=0 saddr4=192.0.2.2
daddr4=192.0.2.1 sport=36444 dport=12345
```

- e. Optional: Display the connections to port **12345** on the server:

```
# ss -taunp | grep ":12345"
tcp ESTAB 0 0      192.0.2.2:36444 192.0.2.1:12345
```

At this point, only one connection to the server has been established.

- f. On a third terminal, create another endpoint:

```
# ip mptcp endpoint add dev wlp1s0 192.0.2.3 subflow
```

This command sets the name and IP address of the WiFi interface of the client in this command.

On the monitoring terminal, **ip mptcp monitor** now logs:

```
[SF_ESTABLISHED] token=63c070d2 remid=0 locid=2 saddr4=192.0.2.3
daddr4=192.0.2.1 sport=53345 dport=12345 backup=0 ifindex=3
```

The **locid** field displays the local address ID of the new sub-flow and identifies this sub-flow even if the connection uses network address translation (NAT). The **saddr4** field matches the endpoint's IP address from the **ip mptcp endpoint add** command.

- g. Optional: Display the connections to port **12345** on the server:

```
# ss -taunp | grep ":12345"
tcp ESTAB 0 0      192.0.2.2:36444 192.0.2.1:12345
tcp ESTAB 0 0 192.0.2.3%wlp1s0:53345 192.0.2.1:12345
```

The command now displays two connections:

- The connection with source address **192.0.2.2** corresponds to the first MPTCP sub-flow that you established previously.
- The connection from the sub-flow over the **wlp1s0** interface with source address **192.0.2.3**.

- h. On the third terminal, delete the endpoint:

```
# ip mptcp endpoint delete id 2
```

Use the ID from the **locid** field from the **ip mptcp monitor** output, or retrieve the endpoint ID using the **ip mptcp endpoint show** command.

On the monitoring terminal, **ip mptcp monitor** now logs:

```
[ SF_CLOSED] token=63c070d2 remid=0 locid=2 saddr4=192.0.2.3 daddr4=192.0.2.1
sport=53345 dport=12345 backup=0 ifindex=3
```

- i. On the first terminal with the **nc** client, press **Ctrl+C** to terminate the session.
On the monitoring terminal, **ip mptcp monitor** now logs:

```
| [ CLOSED] token=63c070d2
```

Additional resources

- **ip-mptcp(1)** man page
- [How NetworkManager manages multiple default gateways](#)

35.6. DISABLING MULTIPATH TCP IN THE KERNEL

You can explicitly disable the MPTCP option in the kernel.

Procedure

- Disable the **mptcp.enabled** option.

```
| # echo "net.mptcp.enabled=0" > /etc/sysctl.d/90-enable-MPTCP.conf  
| # sysctl -p /etc/sysctl.d/90-enable-MPTCP.conf
```

Verification

- Verify whether the **mptcp.enabled** is disabled in the kernel.

```
| # sysctl -a | grep mptcp.enabled  
| net.mptcp.enabled = 0
```

CHAPTER 36. MANAGING THE MPTCPD SERVICE

This section describes the basic management of the **mptcpd** service. The **mptcpd** package provides the **mptcpize** tool, which switches on the **mptcp** protocol in the **TCP** environment.

36.1. CONFIGURING MPTCPD

The **mptcpd** service is a component of the **mptcp** protocol which provides an instrument to configure **mptcp** endpoints. The **mptcpd** service creates a subflow endpoint for each address by default. The endpoint list is updated dynamically according to IP addresses modification on the running host. The **mptcpd** service creates the list of endpoints automatically. It enables multiple paths as an alternative to using the **ip** utility.

Prerequisites

- The **mptcpd** package installed

Procedure

1. Enable **mptcp.enabled** option in the kernel with the following command:

```
# echo "net.mptcp.enabled=1" > /etc/sysctl.d/90-enable-MPTCP.conf
# sysctl -p /etc/sysctl.d/90-enable-MPTCP.conf
```

2. Start the **mptcpd** service:

```
# systemctl start mptcp.service
```

3. Verify endpoint creation:

```
# ip mptcp endpoint
```

4. To stop the **mptcpd** service, use the following command:

```
# systemctl stop mptcp.service
```

5. To configure **mptcpd** service manually, modify the **/etc/mptcpd/mptcpd.conf** configuration file.

Note, that the endpoint, which mptcpd service creates, lasts till the host shutdown.

Additional resources

- **mptcpd(8)** man page.

36.2. MANAGING APPLICATIONS WITH MPTCPIZE TOOL

Using the **mptcpize** tool manage applications and services.

The instruction below shows how to use the **mptcpize** tool to manage applications in the **TCP** environment.

Assuming, you need to run the **iperf3** utility with the enabled **MPTCP** socket. You can achieve this goal by following the procedure below.

Prerequisites

- The **mptcpd** package is installed
- The **iperf3** package is installed

Procedure

- Start **iperf3** utility with **MPTCP** sockets enabled:

```
# mptcpize run iperf3 -s &
```

36.3. ENABLING MPTCP SOCKETS FOR A SERVICES USING THE MPTCPIZE UTILITY

The following set of commands instruct you how to manage services using the **mptcpize** tool. You can enable or disable the **mptcp** socket for a service.

Assuming, you need to manage **mptcp** socket for the **nginx** service. You can achieve this goal by following the procedure below.

Prerequisites

- The **mptcpd** package is installed
- The **nginx** package is installed

Procedure

1. Enable **MPTCP** sockets for a service:

```
# mptcpize enable nginx
```

2. Disable the **MPTCP** sockets for a service:

```
# mptcpize disable nginx
```

3. Restart the service to make the changes to take effect:

```
# systemctl restart nginx
```

CHAPTER 37. NETWORKMANAGER CONNECTION PROFILES IN KEYFILE FORMAT

By default, NetworkManager in Red Hat Enterprise Linux 9 and later stores connection profiles in keyfile format. Unlike the deprecated **ifcfg** format, the keyfile format supports all connection settings that NetworkManager provides.

37.1. THE KEYFILE FORMAT OF NETWORKMANAGER PROFILES

The keyfile format is similar to the INI format. For example, the following is an Ethernet connection profile in keyfile format:

```
[connection]
id=example_connection
uuid=82c6272d-1ff7-4d56-9c7c-0eb27c300029
type=ethernet
autoconnect=true

[ipv4]
method=auto

[ipv6]
method=auto

[ethernet]
mac-address=00:53:00:8f:fa:66
```

Each section corresponds to a NetworkManager setting name as described in the **nm-settings(5)** and **nm-settings-keyfile(5)** man pages. Each key-value-pair in a section is one of the properties listed in the settings specification of the man page.

Most variables in NetworkManager keyfiles have a one-to-one mapping. This means that a NetworkManager property is stored in the keyfile as a variable of the same name and in the same format. However, there are exceptions, mainly to make the keyfile syntax easier to read. For a list of these exceptions, see the **nm-settings-keyfile(5)** man page.

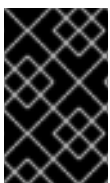

IMPORTANT

For security reasons, because connection profiles can contain sensitive information, such as private keys and passphrases, NetworkManager uses only configuration files owned by the **root** user and that are only readable and writable by **root**.

Depending on the purpose of the connection profile, save it in one of the following directories:

- **/etc/NetworkManager/system-connections/**: The location of persistent profiles. If you modify a persistent profile by using the NetworkManager API, NetworkManager writes and overwrites files in this directory.
- **/run/NetworkManager/system-connections/**: For temporary profiles that are automatically removed when you reboot the system.
- **/usr/lib/NetworkManager/system-connections/**: For pre-deployed immutable profiles. When you edit such a profile using the NetworkManager API, NetworkManager copies this profile to either the persistent or temporary storage.

NetworkManager does not automatically reload profiles from disk. When you create or update a connection profile in keyfile format, use the **nmcli connection reload** command to inform NetworkManager about the changes.

37.2. USING NMCLI TO CREATE KEYFILE CONNECTION PROFILES IN OFFLINE MODE

Red Hat recommends using NetworkManager utilities, such as **nmcli**, the **network** RHEL system role, or the **nmstate** API to manage NetworkManager connections, to create and update configuration files. However, you can also create various connection profiles in the keyfile format in offline mode using the **nmcli --offline connection add** command.

The offline mode ensures that **nmcli** operates without the **NetworkManager** service to produce keyfile connection profiles through standard output. This feature can be useful if:

- You want to create your connection profiles that need to be pre-deployed somewhere. For example in a container image, or as an RPM package.
- You want to create your connection profiles in an environment where the **NetworkManager** service is not available. For example when you want to use the **chroot** utility. Alternatively, when you want to create or modify the network configuration of the RHEL system to be installed through the Kickstart **%post** script.

You can create the following connection profile types:

- static Ethernet connection
- dynamic Ethernet connection
- network bond
- network bridge
- VLAN or any kind of supported connections

Procedure

1. Create a new connection profile in the keyfile format. For example, for a connection profile of an Ethernet device that does not use DHCP, run a similar **nmcli** command:

```
# nmcli --offline connection add type ethernet con-name Example-Connection
ipv4.addresses 192.0.2.1/24 ipv4.dns 192.0.2.200 ipv4.method manual >
/etc/NetworkManager/system-connections/output.nmconnection
```



NOTE

The connection name you specified with the **con-name** key is saved into the **id** variable of the generated profile. When you use the **nmcli** command to manage this connection later, specify the connection as follows:

- When the **id** variable is not omitted, use the connection name, for example **Example-Connection**.
- When the **id** variable is omitted, use the file name without the **.nmconnection** suffix, for example **output**.

- Set permissions to the configuration file so that only the **root** user can read and update it:

```
# chmod 600 /etc/NetworkManager/system-connections/output.nmconnection
# chown root:root /etc/NetworkManager/system-connections/output.nmconnection
```

- Start the **NetworkManager** service:

```
# systemctl start NetworkManager.service
```

- If you set the **autoconnect** variable in the profile to **false**, activate the connection:

```
# nmcli connection up Example-Connection
```

Verification

- Verify that the **NetworkManager** service is running:

```
# systemctl status NetworkManager.service
• NetworkManager.service - Network Manager
  Loaded: loaded (/usr/lib/systemd/system/NetworkManager.service; enabled; vendor preset:
  enabled)
  Active: active (running) since Wed 2022-08-03 13:08:32 CEST; 1 min 40s ago
  ...
```

- Verify that NetworkManager can read the profile from the configuration file:

```
# nmcli -f TYPE,FILENAME,NAME connection
TYPE      FILENAME                                     NAME
ethernet  /etc/NetworkManager/system-connections/output.nmconnection Example-
Connection
ethernet  /etc/sysconfig/network-scripts/ifcfg-enp1s0  enp1s0
...
```

If the output does not show the newly created connection, verify that the keyfile permissions and the syntax you used are correct.

- Display the connection profile:

```
# nmcli connection show Example-Connection
connection.id:           Example-Connection
connection.uuid:         232290ce-5225-422a-9228-cb83b22056b4
connection.stable-id:    --
connection.type:         802-3-ethernet
connection.interface-name: --
connection.autoconnect:  yes
...
```

Additional resources

- [nmcli\(1\)](#)
- [nm-settings-keyfile\(5\)](#)

- [The keyfile format of NetworkManager profiles](#)
- [Configuring an Ethernet connection by using nmcli](#)
- [Configuring VLAN tagging by using nmcli](#)
- [Configuring a network bridge by using nmcli](#)
- [Configuring a network bond by using nmcli](#)

37.3. MANUALLY CREATING A NETWORKMANAGER PROFILE IN KEYFILE FORMAT

You can manually create a NetworkManager connection profile in keyfile format.



NOTE

Manually creating or updating the configuration files can result in an unexpected or non-functional network configuration. As an alternative, you can use **nmcli** in offline mode. See [Using nmcli to create keyfile connection profiles in offline mode](#)

Procedure

1. If you create a profile for a hardware interface, such as Ethernet, display the MAC address of this interface:

```
# ip address show enp1s0
2: enp1s0: <BROADCAST,MULTICAST,UP,LOWER_UP> mtu 1500 qdisc fq_codel state UP
group default qlen 1000
link/ether 00:53:00:8f:fa:66 brd ff:ff:ff:ff:ff:ff
```

2. Create a connection profile. For example, for a connection profile of an Ethernet device that uses DHCP, create the `/etc/NetworkManager/system-connections/example.nmconnection` file with the following content:

```
[connection]
id=example_connection
type=ethernet
autoconnect=true

[ipv4]
method=auto

[ipv6]
method=auto

[ethernet]
mac-address=00:53:00:8f:fa:66
```

**NOTE**

You can use any file name with a **.nmconnection** suffix. However, when you later use **nmcli** commands to manage the connection, you must use the connection name set in the **id** variable when you refer to this connection. When you omit the **id** variable, use the file name without the **.nmconnection** to refer to this connection.

3. Set permissions on the configuration file so that only the **root** user can read and update it:

```
# chown root:root /etc/NetworkManager/system-connections/example.nmconnection
# chmod 600 /etc/NetworkManager/system-connections/example.nmconnection
```

4. Reload the connection profiles:

```
# nmcli connection reload
```

5. Verify that NetworkManager read the profile from the configuration file:

```
# nmcli -f NAME,UUID,FILENAME connection
NAME          UUID          FILENAME
example-connection 86da2486-068d-4d05-9ac7-957ec118afba
/etc/NetworkManager/system-connections/example.nmconnection
...
```

If the command does not show the newly added connection, verify that the file permissions and the syntax you used in the file are correct.

6. If you set the **autoconnect** variable in the profile to **false**, activate the connection:

```
# nmcli connection up example_connection
```

Verification

1. Display the connection profile:

```
# nmcli connection show example_connection
```

Additional resources

- [nm-settings-keyfile \(5\)](#)

37.4. THE DIFFERENCES IN INTERFACE RENAMING WITH PROFILES IN IFCFG AND KEYFILE FORMAT

You can define custom network interface names, such as **provider** or **lan** to make interface names more descriptive. In this case, the **udev** service renames the interfaces. The renaming process works differently depending on whether you use connection profiles in **ifcfg** or keyfile format.

The interface renaming process when using a profile in ifcfg format

1. The `/usr/lib/udev/rules.d/60-net.rules` **udev** rule calls the `/lib/udev/rename_device` helper utility.

2. The helper utility searches for the **HWADDR** parameter in **/etc/sysconfig/network-scripts/ifcfg-*** files.
3. If the value set in the variable matches the MAC address of an interface, the helper utility renames the interface to the name set in the **DEVICE** parameter of the file.

The interface renaming process when using a profile in keyfile format

1. Create a [systemd link file](#) or a [udev rule](#) to rename an interface.
2. Use the custom interface name in the **interface-name** property of a NetworkManager connection profile.

Additional resources

- [How the udev device manager renames network interfaces](#)
- [Configuring user-defined network interface names by using udev rules](#)
- [Configuring user-defined network interface names by using systemd link files](#)

37.5. MIGRATING NETWORKMANAGER PROFILES FROM IFCFG TO KEYFILE FORMAT

If you still use connection profiles in the deprecated **ifcfg** format, you can convert them to the keyfile format.



NOTE

If an **ifcfg** file contains the **NM_CONTROLLED=no** setting, NetworkManager does not control this profile and, consequently the migration process ignores it.

Prerequisites

- You have connection profiles in **ifcfg** format in the **/etc/sysconfig/network-scripts/** directory.
- If the connection profiles contain a **DEVICE** variable that is set to a custom device name, such as **provider** or **lan**, you created a [systemd link file](#) or a [udev rule](#) for each of the custom device names.

Procedure

- Migrate the connection profiles:

```
# nmcli connection migrate
Connection 'enp1s0' (43ed18ab-f0c4-4934-af3d-2b3333948e45) successfully migrated.
Connection 'enp2s0' (883333e8-1b87-4947-8ceb-1f8812a80a9b) successfully migrated.
...
```

Verification

- Optionally, you can verify that you successfully migrated all your connection profiles:

```
# nmcli -f TYPE,FILENAME,NAME connection
TYPE    FILENAME                                     NAME
ethernet /etc/NetworkManager/system-connections/enp1s0.nmconnection  enp1s0
ethernet /etc/NetworkManager/system-connections/enp2s0.nmconnection  enp2s0
...
```

Additional resources

- [nm-settings-keyfile\(5\)](#)
- [nm-settings-ifcfg-rh\(5\)](#)
- [How the udev device manager renames network interfaces](#)

CHAPTER 38. SYSTEMD NETWORK TARGETS AND SERVICES

NetworkManager configures the network during the system boot process. However, when booting with a remote root (/), such as if the root directory is stored on an iSCSI device, the network settings are applied in the initial RAM disk (**initrd**) before RHEL is started. For example, if the network configuration is specified on the kernel command line using **rd.neednet=1** or a configuration is specified to mount remote file systems, then the network settings are applied on **initrd**.

RHEL uses the **network** and **network-online** targets and the **NetworkManager-wait-online** service while applying network settings. Also, you can configure **systemd** services to start after the network is fully available if these services cannot dynamically reload.

38.1. DIFFERENCES BETWEEN THE NETWORK AND NETWORK-ONLINE SYSTEMD TARGET

Systemd maintains the **network** and **network-online** target units. The special units such as **NetworkManager-wait-online.service**, have **WantedBy=network-online.target** and **Before=network-online.target** parameters. If enabled, these units get started with **network-online.target** and delay the target to be reached until some form of network connectivity is established. They delay the **network-online** target until the network is connected.

The **network-online** target starts a service, which adds substantial delays to further execution. Systemd automatically adds dependencies with **Wants** and **After** parameters for this target unit to all the System V (SysV) **init** script service units with a Linux Standard Base (LSB) header referring to the **\$network** facility. The LSB header is metadata for **init** scripts. You can use it to specify dependencies. This is similar to the **systemd** target.

The **network** target does not significantly delay the execution of the boot process. Reaching the **network** target means that the service that is responsible for setting up the network has started. However, it does not mean that a network device was configured. This target is important during the shutdown of the system. For example, if you have a service that was ordered after the **network** target during bootup, then this dependency is reversed during the shutdown. The network does not get disconnected until your service has been stopped. All mount units for remote network file systems automatically start the **network-online** target unit and order themselves after it.



NOTE

The **network-online** target unit is only useful during the system starts. After the system has completed booting up, this target does not track the online state of the network. Therefore, you cannot use **network-online** to monitor the network connection. This target provides a one-time system startup concept.

38.2. OVERVIEW OF NETWORKMANAGER-WAIT-ONLINE

The **NetworkManager-wait-online** service waits with a timeout for the network to be configured. This network configuration involves plugging-in an Ethernet device, scanning for a Wi-Fi device, and so forth. NetworkManager automatically activates suitable profiles that are configured to start automatically. The failure of the automatic activation process due to a DHCP timeout or similar event might keep NetworkManager busy for an extended period of time. Depending on the configuration, NetworkManager retries activating the same profile or a different profile.

When the startup completes, either all profiles are in a disconnected state or are successfully activated. You can configure profiles to auto-connect. The following are a few examples of parameters that set timeouts or define when the connection is considered active:

- **connection.wait-device-timeout** - sets the timeout for the driver to detect the device
- **ipv4.may-fail** and **ipv6.may-fail** - sets activation with one IP address family ready, or whether a particular address family must have completed configuration.
- **ipv4.gateway-ping-timeout** - delays activation.

Additional resources

- **nm-settings(5)** man page

38.3. CONFIGURING A SYSTEMD SERVICE TO START AFTER THE NETWORK HAS BEEN STARTED

Red Hat Enterprise Linux installs **systemd** service files in the `/usr/lib/systemd/system/` directory. This procedure creates a drop-in snippet for a service file in `/etc/systemd/system/service_name.service.d/` that is used together with the service file in `/usr/lib/systemd/system/` to start a particular *service* after the network is online. It has a higher priority if settings in the drop-in snippet overlap with the ones in the service file in `/usr/lib/systemd/system/`.

Procedure

1. To open the service file in the editor, enter:

```
# systemctl edit service_name
```

2. Enter the following, and save the changes:

```
[Unit]
After=network-online.target
```

3. Reload the **systemd** service.

```
# systemctl daemon-reload
```

CHAPTER 39. INTRODUCTION TO NMSTATE

Nmstate is a declarative network manager API. The **nmstate** package provides the **libnmstate** Python library and a command-line utility, **nmstatectl**, to manage NetworkManager on RHEL. When you use Nmstate, you describe the expected networking state using YAML or JSON-formatted instructions.

Nmstate has many benefits. For example, it:

- Provides a stable and extensible interface to manage RHEL network capabilities
- Supports atomic and transactional operations at the host and cluster level
- Supports partial editing of most properties and preserves existing settings that are not specified in the instructions
- Provides plug-in support to enable administrators to use their own plug-ins

39.1. USING THE LIBNMSTATE LIBRARY IN A PYTHON APPLICATION

The **libnmstate** Python library enables developers to use Nmstate in their own application

To use the library, import it in your source code:

```
import libnmstate
```

Note that you must install the **nmstate** package to use this library.

Example 39.1. Querying the network state using the libnmstate library

The following Python code imports the **libnmstate** library and displays the available network interfaces and their state:

```
import json
import libnmstate
from libnmstate.schema import Interface

net_state = libnmstate.show()
for iface_state in net_state[Interface.KEY]:
    print(iface_state[Interface.NAME] + ": "
          + iface_state[Interface.STATE])
```

39.2. UPDATING THE CURRENT NETWORK CONFIGURATION USING NMSTATECTL

You can use the **nmstatectl** utility to store the current network configuration of one or all interfaces in a file. You can then use this file to:

- Modify the configuration and apply it to the same system.
- Copy the file to a different host and configure the host with the same or modified settings.

For example, you can export the settings of the **enp1s0** interface to a file, modify the configuration, and apply the settings to the host.

Prerequisites

- The **nmstate** package is installed.

Procedure

1. Export the settings of the **enp1s0** interface to the `~/network-config.yml` file:

```
# nmstatectl show enp1s0 > ~/network-config.yml
```

This command stores the configuration of **enp1s0** in YAML format. To store the output in JSON format, pass the **--json** option to the command.

If you do not specify an interface name, **nmstatectl** exports the configuration of all interfaces.

2. Modify the `~/network-config.yml` file using a text editor to update the configuration.
3. Apply the settings from the `~/network-config.yml` file:

```
# nmstatectl apply ~/network-config.yml
```

If you exported the settings in JSON format, pass the **--json** option to the command.

39.3. THE NMSTATE SYSTEMD SERVICE

You can automatically apply new network settings when the Red Hat Enterprise Linux system boots by configuring the **nmstate systemd** service.

With the **nmstate** package installed, you can store ***.yml** files with Nmstate instructions in the `/etc/nmstate/` directory. The **nmstate** service then automatically applies the files on the next reboot or when you manually restart the service. After Nmstate successfully applies a file, it renames the file's **.yml** suffix to **.applied** to prevent the service from processing the same file again.

The **nmstate** service is a **oneshot systemd** service. Consequently, **systemd** executes it only when the system boots and when you manually restart the service.



NOTE

By default, the **nmstate** service is disabled. Use the **systemctl enable nmstate** command to enable it. Afterwards, **systemd** executes this service each time when the system starts.

39.4. NETWORK STATES FOR THE NETWORK RHEL SYSTEM ROLE

The **network** RHEL system role supports state configurations in playbooks to configure the devices. For this, use the **network_state** variable followed by the state configurations.

Benefits of using the **network_state** variable in a playbook:

- Using the declarative method with the state configurations, you can configure interfaces, and the NetworkManager creates a profile for these interfaces in the background.

- With the **network_state** variable, you can specify the options that you require to change, and all the other options will remain the same as they are. However, with the **network_connections** variable, you must specify all settings to change the network connection profile.

For example, to create an Ethernet connection with dynamic IP address settings, use the following **vars** block in your playbook:

Playbook with state configurations	Regular playbook
<pre>vars: network_state: interfaces: - name: enp7s0 type: ethernet state: up ipv4: enabled: true auto-dns: true auto-gateway: true auto-routes: true dhcp: true ipv6: enabled: true auto-dns: true auto-gateway: true auto-routes: true autoconf: true dhcp: true</pre>	<pre>vars: network_connections: - name: enp7s0 interface_name: enp7s0 type: ethernet autoconnect: yes ip: dhcp4: yes auto6: yes state: up</pre>

For example, to only change the connection status of dynamic IP address settings that you created as above, use the following **vars** block in your playbook:

Playbook with state configurations	Regular playbook
<pre>vars: network_state: interfaces: - name: enp7s0 type: ethernet state: down</pre>	<pre>vars: network_connections: - name: enp7s0 interface_name: enp7s0 type: ethernet autoconnect: yes ip: dhcp4: yes auto6: yes state: down</pre>

Additional resources

- `/usr/share/ansible/roles/rhel-system-roles.network/README.md` file

- `/usr/share/doc/rhel-system-roles/network/` directory

39.5. ADDITIONAL RESOURCES

- `/usr/share/doc/nmstate/README.md`
- `/usr/share/doc/nmstate/examples/`

CHAPTER 40. CAPTURING NETWORK PACKETS

To debug network issues and communications, you can capture network packets. The following sections provide instructions and additional information about capturing network packets.

40.1. USING XDPDUMP TO CAPTURE NETWORK PACKETS INCLUDING PACKETS DROPPED BY XDP PROGRAMS

The **xdpdump** utility captures network packets. Unlike the **tcpdump** utility, **xdpdump** uses an extended Berkeley Packet Filter (eBPF) program for this task. This enables **xdpdump** to also capture packets dropped by Express Data Path (XDP) programs. User-space utilities, such as **tcpdump**, are not able to capture these dropped packages, as well as original packets modified by an XDP program.

You can use **xdpdump** to debug XDP programs that are already attached to an interface. Therefore, the utility can capture packets before an XDP program is started and after it has finished. In the latter case, **xdpdump** also captures the XDP action. By default, **xdpdump** captures incoming packets at the entry of the XDP program.

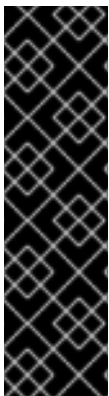

IMPORTANT

On other architectures than AMD and Intel 64-bit, the **xdpdump** utility is provided as a Technology Preview only. Technology Preview features are not supported with Red Hat production Service Level Agreements (SLAs), might not be functionally complete, and Red Hat does not recommend using them for production. These previews provide early access to upcoming product features, enabling customers to test functionality and provide feedback during the development process.

See [Technology Preview Features Support Scope](#) on the Red Hat Customer Portal for information about the support scope for Technology Preview features.

Note that **xdpdump** has no packet filter or decode capabilities. However, you can use it in combination with **tcpdump** for packet decoding.

Prerequisites

- A network driver that supports XDP programs.
- An XDP program is loaded to the **enp1s0** interface. If no program is loaded, **xdpdump** captures packets in a similar way **tcpdump** does, for backward compatibility.

Procedure

1. To capture packets on the **enp1s0** interface and write them to the **/root/capture.pcap** file, enter:

```
# xdpdump -i enp1s0 -w /root/capture.pcap
```

2. To stop capturing packets, press **Ctrl+C**.

Additional resources

- **xdpdump(8)** man page

- If you are a developer and you are interested in the source code of **xdpdump**, download and install the corresponding source RPM (SRPM) from the Red Hat Customer Portal.

40.2. ADDITIONAL RESOURCES

- [How to capture network packets with tcpdump?](#)

CHAPTER 41. UNDERSTANDING THE EBPF NETWORKING FEATURES IN RHEL 9

The extended Berkeley Packet Filter (eBPF) is an in-kernel virtual machine that allows code execution in the kernel space. This code runs in a restricted sandbox environment with access only to a limited set of functions.

In networking, you can use eBPF to complement or replace kernel packet processing. Depending on the hook you use, eBPF programs have, for example:

- Read and write access to packet data and metadata
- Can look up sockets and routes
- Can set socket options
- Can redirect packets

41.1. OVERVIEW OF NETWORKING EBPF FEATURES IN RHEL 9

You can attach extended Berkeley Packet Filter (eBPF) networking programs to the following hooks in RHEL:

- **eXpress Data Path (XDP)**: Provides early access to received packets before the kernel networking stack processes them.
- **tc** eBPF classifier with direct-action flag: Provides powerful packet processing on ingress and egress.
- **Control Groups version 2 (cgroup v2)**: Enables filtering and overriding socket-based operations performed by programs in a control group.
- **Socket filtering**: Enables filtering of packets received from sockets. This feature was also available in the classic Berkeley Packet Filter (cBPF), but has been extended to support eBPF programs.
- **Stream parser**: Enables splitting up streams to individual messages, filtering, and redirecting them to sockets.
- **SO_REUSEPORT** socket selection: Provides a programmable selection of a receiving socket from a **reuseport** socket group.
- **Flow dissector**: Enables overriding the way the kernel parses packet headers in certain situations.
- **TCP congestion control callbacks**: Enables implementing a custom TCP congestion control algorithm.
- **Routes with encapsulation**: Enables creating custom tunnel encapsulation.

XDP

You can attach programs of the **BPF_PROG_TYPE_XDP** type to a network interface. The kernel then executes the program on received packets before the kernel network stack starts processing them. This allows fast packet forwarding in certain situations, such as fast packet dropping to prevent distributed denial of service (DDoS) attacks and fast packet redirects for load balancing scenarios.

You can also use XDP for different forms of packet monitoring and sampling. The kernel allows XDP programs to modify packets and to pass them for further processing to the kernel network stack.

The following XDP modes are available:

- **Native (driver) XDP:** The kernel executes the program from the earliest possible point during packet reception. At this moment, the kernel did not parse the packet and, therefore, no metadata provided by the kernel is available. This mode requires that the network interface driver supports XDP but not all drivers support this native mode.
- **Generic XDP:** The kernel network stack executes the XDP program early in the processing. At that time, kernel data structures have been allocated, and the packet has been pre-processed. If a packet should be dropped or redirected, it requires a significant overhead compared to the native mode. However, the generic mode does not require network interface driver support and works with all network interfaces.
- **Offloaded XDP:** The kernel executes the XDP program on the network interface instead of on the host CPU. Note that this requires specific hardware, and only certain eBPF features are available in this mode.

On RHEL, load all XDP programs using the **libxdp** library. This library enables system-controlled usage of XDP.



NOTE

Currently, there are some system configuration limitations for XDP programs. For example, you must disable certain hardware offload features on the receiving interface. Additionally, not all features are available with all drivers that support the native mode.

In RHEL 9, Red Hat supports the XDP features only if you use the **libxdp** library to load the program into the kernel.

AF_XDP

Using an XDP program that filters and redirects packets to a given **AF_XDP** socket, you can use one or more sockets from the **AF_XDP** protocol family to quickly copy packets from the kernel to the user space.

Traffic Control

The Traffic Control (**tc**) subsystem offers the following types of eBPF programs:

- **BPF_PROG_TYPE_SCHED_CLS**
- **BPF_PROG_TYPE_SCHED_ACT**

These types enable you to write custom **tc** classifiers and **tc** actions in eBPF. Together with the parts of the **tc** ecosystem, this provides the ability for powerful packet processing and is the core part of several container networking orchestration solutions.

In most cases, only the classifier is used, as with the direct-action flag, the eBPF classifier can execute actions directly from the same eBPF program. The **clsact** Queueing Discipline (**qdisc**) has been designed to enable this on the ingress side.

Note that using a flow dissector eBPF program can influence operation of some other **qdiscs** and **tc** classifiers, such as **flower**.

Socket filter

Several utilities use or have used the classic Berkeley Packet Filter (cBPF) for filtering packets received on a socket. For example, the **tcpdump** utility enables the user to specify expressions, which **tcpdump** then translates into cBPF code.

As an alternative to cBPF, the kernel allows eBPF programs of the **BPF_PROG_TYPE_SOCKET_FILTER** type for the same purpose.

Control Groups

In RHEL, you can use multiple types of eBPF programs that you can attach to a cgroup. The kernel executes these programs when a program in the given cgroup performs an operation. Note that you can use only cgroups version 2.

The following networking-related cgroup eBPF programs are available in RHEL:

- **BPF_PROG_TYPE SOCK_OPS**: The kernel calls this program on various TCP events. The program can adjust the behavior of the kernel TCP stack, including custom TCP header options, and so on.
- **BPF_PROG_TYPE CGROUP SOCK_ADDR**: The kernel calls this program during **connect**, **bind**, **sendto**, **recvmsg**, **getpeername**, and **getsockname** operations. This program allows changing IP addresses and ports. This is useful when you implement socket-based network address translation (NAT) in eBPF.
- **BPF_PROG_TYPE CGROUP SOCKOPT**: The kernel calls this program during **setsockopt** and **getsockopt** operations and allows changing the options.
- **BPF_PROG_TYPE CGROUP SOCK**: The kernel calls this program during socket creation, socket releasing, and binding to addresses. You can use these programs to allow or deny the operation, or only to inspect socket creation for statistics.
- **BPF_PROG_TYPE CGROUP SKB**: This program filters individual packets on ingress and egress, and can accept or reject packets.
- **BPF_PROG_TYPE CGROUP SYSCTL**: This program allows filtering of access to system controls (**sysctl**).

Stream Parser

A stream parser operates on a group of sockets that are added to a special eBPF map. The eBPF program then processes packets that the kernel receives or sends on those sockets.

The following stream parser eBPF programs are available in RHEL:

- **BPF_PROG_TYPE SK_SKB**: An eBPF program parses packets received from the socket into individual messages, and instructs the kernel to drop those messages or send them to another socket in the group.
- **BPF_PROG_TYPE SK_MSG**: This program filters egress messages. An eBPF program parses the packets into individual messages and either approves or rejects them.

SO_REUSEPORT socket selection

Using this socket option, you can bind multiple sockets to the same IP address and port. Without eBPF, the kernel selects the receiving socket based on a connection hash. With the **BPF_PROG_TYPE_SK_REUSEPORT** program, the selection of the receiving socket is fully programmable.

Flow dissector

When the kernel needs to process packet headers without going through the full protocol decode, they

are **dissected**. For example, this happens in the **tc** subsystem, in multipath routing, in bonding, or when calculating a packet hash. In this situation the kernel parses the packet headers and fills internal structures with the information from the packet headers. You can replace this internal parsing using the **BPF_PROG_TYPE_FLOW_DISSECTOR** program. Note that you can only dissect TCP and UDP over IPv4 and IPv6 in eBPF in RHEL.

TCP Congestion Control

You can write a custom TCP congestion control algorithm using a group of **BPF_PROG_TYPE_STRUCT_OPS** programs that implement **struct tcp_congestion_ops** callbacks. An algorithm that is implemented this way is available to the system alongside the built-in kernel algorithms.

Routes with encapsulation

You can attach one of the following eBPF program types to routes in the routing table as a tunnel encapsulation attribute:

- **BPF_PROG_TYPE_LWT_IN**
- **BPF_PROG_TYPE_LWT_OUT**
- **BPF_PROG_TYPE_LWT_XMIT**

The functionality of such an eBPF program is limited to specific tunnel configurations and does not allow creating a generic encapsulation or decapsulation solution.

Socket lookup

To bypass limitations of the **bind** system call, use an eBPF program of the **BPF_PROG_TYPE_SK_LOOKUP** type. Such programs can select a listening socket for new incoming TCP connections or an unconnected socket for UDP packets.

41.2. OVERVIEW OF XDP FEATURES IN RHEL 9 BY NETWORK CARDS

The following is an overview of XDP-enabled network cards and the XDP features you can use with them:

Network card	Driver	Basic	Redirect	Target	HW offload	Zero-copy	Large MTU
Amazon Elastic Network Adapter	ena	yes	yes	yes [a]	no	no	no
aQuantia AQtion Ethernet card	atlantic	yes	yes	no	no	no	no
Broadcom NetXtreme-C/E 10/25/40/50 gigabit Ethernet	bnxt_en	yes	yes	yes [a]	no	no	yes
Cavium Thunder Virtual function	nicvf	yes	no	no	no	no	no
Google Virtual NIC (gVNIC) support	gve	yes	yes	yes	no	yes	no

Network card	Driver	Basic	Redirect	Target	HW offload	Zero-copy	Large MTU
Intel® 10GbE PCI Express Virtual Function Ethernet	ixgbevf	yes	no	no	no	no	no
Intel® 10GbE PCI Express adapters	ixgbe	yes	yes	yes [a]	no	yes	yes [b]
Intel® Ethernet Connection E800 Series	ice	yes	yes	yes [a]	no	yes	yes
Intel® Ethernet Controller I225-LM/I225-V family	igc	yes	yes	yes	no	yes	yes [b]
Intel® PCI Express Gigabit adapters	igb	yes	yes	yes [a]	no	no	yes [b]
Intel® Ethernet Controller XL710 Family	i40e	yes	yes	yes [a] [c]	no	yes	no
Marvell OcteonTX2	rvu_nicpf	yes	yes	yes [a] [c]	no	no	no
Mellanox 5th generation network adapters (ConnectX series)	mlx5_core	yes	yes	yes [c]	no	yes	yes
Mellanox Technologies 1/10/40Gbit Ethernet	mlx4_en	yes	yes	no	no	no	no
Microsoft Azure Network Adapter	mana	yes	yes	yes	no	no	no
Microsoft Hyper-V virtual network	hv_netvsc	yes	yes	yes	no	no	no
Netronome® NFP4000/NFP6000 NIC [d]	nfp	yes	no	no	yes	yes	no
QEMU Virtio network	virtio_net	yes	yes	yes [a]	no	no	yes
QLogic QED 25/40/100Gb Ethernet NIC	qede	yes	yes	yes	no	no	no
STMicroelectronics Multi-Gigabit Ethernet	stmmac	yes	yes	yes	no	yes	no

Network card	Driver	Basic	Redirect	Target	HW offload	Zero-copy	Large MTU
Solarflare SFC9000/SFC9100/EF100-family	sfc	yes	yes	yes [c]	no	no	no
Universal TUN/TAP device	tun	yes	yes	yes	no	no	no
Virtual Ethernet pair device	veth	yes	yes	yes	no	no	yes
VMware VMXNET3 ethernet driver	vmxnet3	yes	yes	yes [a] [c]	no	no	no
Xen paravirtual network device	xen-netfront	yes	yes	yes	no	no	no

[a] Only if an XDP program is loaded on the interface.

[b] Transmitting side only. Cannot receive large packets through XDP.

[c] Requires several XDP TX queues allocated that is larger or equal to the largest CPU index.

[d] Some of the listed features are not available for the Netronome® NFP3800 NIC.

Legend:

- Basic: Supports basic return codes: **DROP**, **PASS**, **ABORTED**, and **TX**.
- Redirect: Supports the **XDP_REDIRECT** return code.
- Target: Can be a target of a **XDP_REDIRECT** return code.
- HW offload: Supports XDP hardware offload.
- Zero-copy: Supports the zero-copy mode for the **AF_XDP** protocol family.
- Large MTU: Supports packets larger than page size.

CHAPTER 42. NETWORK TRACING USING THE BPF COMPILER COLLECTION

BPF Compiler Collection (BCC) is a library, which facilitates the creation of the extended Berkeley Packet Filter (eBPF) programs. The main utility of eBPF programs is analyzing the operating system performance and network performance without experiencing overhead or security issues.

BCC removes the need for users to know deep technical details of eBPF, and provides many out-of-the-box starting points, such as the **bcc-tools** package with pre-created eBPF programs.



NOTE

The eBPF programs are triggered on events, such as disk I/O, TCP connections, and process creations. It is unlikely that the programs should cause the kernel to crash, loop or become unresponsive because they run in a safe virtual machine in the kernel.

42.1. INSTALLING THE BCC-TOOLS PACKAGE

Install the **bcc-tools** package, which also installs the BPF Compiler Collection (BCC) library as a dependency.

Procedure

1. Install **bcc-tools**.

```
# dnf install bcc-tools
```

The BCC tools are installed in the **/usr/share/bcc/tools/** directory.

2. Optionally, inspect the tools:

```
# ll /usr/share/bcc/tools/
...
-rwxr-xr-x. 1 root root 4198 Dec 14 17:53 dcsnoop
-rwxr-xr-x. 1 root root 3931 Dec 14 17:53 dcstat
-rwxr-xr-x. 1 root root 20040 Dec 14 17:53 deadlock_detector
-rw-r--r--. 1 root root 7105 Dec 14 17:53 deadlock_detector.c
drwxr-xr-x. 3 root root 8192 Mar 11 10:28 doc
-rwxr-xr-x. 1 root root 7588 Dec 14 17:53 execsnoop
-rwxr-xr-x. 1 root root 6373 Dec 14 17:53 ext4dist
-rwxr-xr-x. 1 root root 10401 Dec 14 17:53 ext4slower
...
```

The **doc** directory in the listing above contains documentation for each tool.

42.2. DISPLAYING TCP CONNECTIONS ADDED TO THE KERNEL'S ACCEPT QUEUE

After the kernel receives the **ACK** packet in a TCP 3-way handshake, the kernel moves the connection from the **SYN** queue to the **accept** queue after the connection's state changes to **ESTABLISHED**. Therefore, only successful TCP connections are visible in this queue.

The **tcpaccept** utility uses eBPF features to display all connections the kernel adds to the **accept**

queue. The utility is lightweight because it traces the **accept()** function of the kernel instead of capturing packets and filtering them. For example, use **tcpaccept** for general troubleshooting to display new connections the server has accepted.

Procedure

1. Enter the following command to start the tracing the kernel **accept** queue:

```
# /usr/share/bcc/tools/tcpaccept
PID COMM  IP RADDR  RPORT LADDR  LPORT
843  sshd   4 192.0.2.17 50598 192.0.2.1 22
1107 ns-slappd 4 198.51.100.6 38772 192.0.2.1 389
1107 ns-slappd 4 203.0.113.85 38774 192.0.2.1 389
...
```

Each time the kernel accepts a connection, **tcpaccept** displays the details of the connections.

2. Press **Ctrl+C** to stop the tracing process.

Additional resources

- **tcpaccept(8)** man page
- `/usr/share/bcc/tools/doc/tcpaccept_example.txt` file

42.3. TRACING OUTGOING TCP CONNECTION ATTEMPTS

The **tcpconnect** utility uses eBPF features to trace outgoing TCP connection attempts. The output of the utility also includes connections that failed.

The **tcpconnect** utility is lightweight because it traces, for example, the **connect()** function of the kernel instead of capturing packets and filtering them.

Procedure

1. Enter the following command to start the tracing process that displays all outgoing connections:

```
# /usr/share/bcc/tools/tcpconnect
PID COMM  IP SADDR  DADDR  DPORT
31346 curl   4 192.0.2.1 198.51.100.16 80
31348 telnet  4 192.0.2.1 203.0.113.231 23
31361 isc-worker00 4 192.0.2.1 192.0.2.254 53
...
```

Each time the kernel processes an outgoing connection, **tcpconnect** displays the details of the connections.

2. Press **Ctrl+C** to stop the tracing process.

Additional resources

- **tcpconnect(8)** man page
- `/usr/share/bcc/tools/doc/tcpconnect_example.txt` file

42.4. MEASURING THE LATENCY OF OUTGOING TCP CONNECTIONS

The TCP connection latency is the time taken to establish a connection. This typically involves the kernel TCP/IP processing and network round trip time, and not the application runtime.

The **tcpconnl** utility uses eBPF features to measure the time between a sent **SYN** packet and the received response packet.

Procedure

1. Start measuring the latency of outgoing connections:

```
# /usr/share/bcc/tools/tcpconnl
PID COMM      IP SADDR  DADDR      DPORT LAT(ms)
32151 isc-worker00 4 192.0.2.1 192.0.2.254 53 0.60
32155 ssh        4 192.0.2.1 203.0.113.190 22 26.34
32319 curl       4 192.0.2.1 198.51.100.59 443 188.96
...
```

Each time the kernel processes an outgoing connection, **tcpconnl** displays the details of the connection after the kernel receives the response packet.

2. Press **Ctrl+C** to stop the tracing process.

Additional resources

- **tcpconnl(8)** man page
- `/usr/share/bcc/tools/doc/tcpconnl_example.txt` file

42.5. DISPLAYING DETAILS ABOUT TCP PACKETS AND SEGMENTS THAT WERE DROPPED BY THE KERNEL

The **tcpdrop** utility enables administrators to display details about TCP packets and segments that were dropped by the kernel. Use this utility to debug high rates of dropped packets that can cause the remote system to send timer-based retransmits. High rates of dropped packets and segments can impact the performance of a server.

Instead of capturing and filtering packets, which is resource-intensive, the **tcpdrop** utility uses eBPF features to retrieve the information directly from the kernel.

Procedure

1. Enter the following command to start displaying details about dropped TCP packets and segments:

```
# /usr/share/bcc/tools/tcpdrop
TIME PID IP SADDR:SPORT > DADDR:DPORT STATE (FLAGS)
13:28:39 32253 4 192.0.2.85:51616 > 192.0.2.1:22 CLOSE_WAIT (FIN|ACK)
b'tcp_drop+0x1'
b'tcp_data_queue+0x2b9'
...

13:28:39 1 4 192.0.2.85:51616 > 192.0.2.1:22 CLOSE (ACK)
```

```
b'tcp_drop+0x1'
b'tcp_rcv_state_process+0xe2'
...
```

Each time the kernel drops TCP packets and segments, **tcpdrop** displays the details of the connection, including the kernel stack trace that led to the dropped package.

2. Press **Ctrl+C** to stop the tracing process.

Additional resources

- **tcpdrop(8)** man page
- `/usr/share/bcc/tools/doc/tcpdrop_example.txt` file

42.6. TRACING TCP SESSIONS

The **tcplife** utility uses eBPF to trace TCP sessions that open and close, and prints a line of output to summarize each one. Administrators can use **tcplife** to identify connections and the amount of transferred traffic.

For example, you can display connections to port **22** (SSH) to retrieve the following information:

- The local process ID (PID)
- The local process name
- The local IP address and port number
- The remote IP address and port number
- The amount of received and transmitted traffic in KB.
- The time in milliseconds the connection was active

Procedure

1. Enter the following command to start the tracing of connections to the local port **22**:

```
/usr/share/bcc/tools/tcplife -L 22
PID COMM  LADDR  LPORT RADDR  RPORT TX_KB RX_KB  MS
19392 sshd  192.0.2.1 22 192.0.2.17 43892 53 52 6681.95
19431 sshd  192.0.2.1 22 192.0.2.245 43902 81 249381 7585.09
19487 sshd  192.0.2.1 22 192.0.2.121 43970 6998 7 16740.35
...
```

Each time a connection is closed, **tcplife** displays the details of the connections.

2. Press **Ctrl+C** to stop the tracing process.

Additional resources

- **tcplife(8)** man page
- `/usr/share/bcc/tools/doc/tcplife_example.txt` file

42.7. TRACING TCP RETRANSMISSIONS

The **tcpretrans** utility displays details about TCP retransmissions, such as the local and remote IP address and port number, as well as the TCP state at the time of the retransmissions.

The utility uses eBPF features and, therefore, has a very low overhead.

Procedure

1. Use the following command to start displaying TCP retransmission details:

```
# /usr/share/bcc/tools/tcpretrans
TIME   PID IP LADDR:LPORT  T> RADDR:RPORT   STATE
00:23:02 0  4 192.0.2.1:22  R> 198.51.100.0:26788 ESTABLISHED
00:23:02 0  4 192.0.2.1:22  R> 198.51.100.0:26788 ESTABLISHED
00:45:43 0  4 192.0.2.1:22  R> 198.51.100.0:17634 ESTABLISHED
...
```

Each time the kernel calls the TCP retransmit function, **tcpretrans** displays the details of the connection.

2. Press **Ctrl+C** to stop the tracing process.

Additional resources

- **tcpretrans(8)** man page
- `/usr/share/bcc/tools/doc/tcpretrans_example.txt` file

42.8. DISPLAYING TCP STATE CHANGE INFORMATION

During a TCP session, the TCP state changes. The **tcpstates** utility uses eBPF functions to trace these state changes, and prints details including the duration in each state. For example, use **tcpstates** to identify if connections spend too much time in the initialization state.

Procedure

1. Use the following command to start tracing TCP state changes:

```
# /usr/share/bcc/tools/tcpstates
SKADDR      C-PID C-COMM  LADDR  LPORT RADDR  RPORT OLDSTATE  ->
NEWSTATE  MS
ffff9cd377b3af80 0  swapper/1 0.0.0.0 22  0.0.0.0 0  LISTEN  -> SYN_RECV
0.000
ffff9cd377b3af80 0  swapper/1 192.0.2.1 22  192.0.2.45 53152 SYN_RECV  ->
ESTABLISHED 0.067
ffff9cd377b3af80 818  sssd_nss 192.0.2.1 22  192.0.2.45 53152 ESTABLISHED ->
CLOSE_WAIT 65636.773
ffff9cd377b3af80 1432  sshd 192.0.2.1 22  192.0.2.45 53152 CLOSE_WAIT ->
LAST_ACK 24.409
ffff9cd377b3af80 1267  pulseaudio 192.0.2.1 22  192.0.2.45 53152 LAST_ACK ->
CLOSE 0.376
...
```

Each time a connection changes its state, **tcpstates** displays a new line with updated connection details.

If multiple connections change their state at the same time, use the socket address in the first column (**SKADDR**) to determine which entries belong to the same connection.

2. Press **Ctrl+C** to stop the tracing process.

Additional resources

- **tcpstates(8)** man page
- `/usr/share/bcc/tools/doc/tcpstates_example.txt` file

42.9. SUMMARIZING AND AGGREGATING TCP TRAFFIC SENT TO SPECIFIC SUBNETS

The **tcpsubnet** utility summarizes and aggregates IPv4 TCP traffic that the local host sends to subnets and displays the output on a fixed interval. The utility uses eBPF features to collect and summarize the data to reduce the overhead.

By default, **tcpsubnet** summarizes traffic for the following subnets:

- **127.0.0.1/32**
- **10.0.0.0/8**
- **172.16.0.0/12**
- **192.0.2.0/24/16**
- **0.0.0.0/0**

Note that the last subnet (**0.0.0.0/0**) is a catch-all option. The **tcpsubnet** utility counts all traffic for subnets different than the first four in this catch-all entry.

Follow the procedure to count the traffic for the **192.0.2.0/24** and **198.51.100.0/24** subnets. Traffic to other subnets will be tracked in the **0.0.0.0/0** catch-all subnet entry.

Procedure

1. Start monitoring the amount of traffic send to the **192.0.2.0/24**, **198.51.100.0/24**, and other subnets:

```
# /usr/share/bcc/tools/tcpsubnet 192.0.2.0/24,198.51.100.0/24,0.0.0.0/0
Tracing... Output every 1 secs. Hit Ctrl-C to end
[02/21/20 10:04:50]
192.0.2.0/24      856
198.51.100.0/24  7467
[02/21/20 10:04:51]
192.0.2.0/24      1200
198.51.100.0/24  8763
0.0.0.0/0         673
...
```

This command displays the traffic in bytes for the specified subnets once per second.

2. Press **Ctrl+C** to stop the tracing process.

Additional resources

- **tcpsubnet(8)** man page
- `/usr/share/bcc/tools/doc/tcpsubnet.txt` file

42.10. DISPLAYING THE NETWORK THROUGHPUT BY IP ADDRESS AND PORT

The **tcptop** utility displays TCP traffic the host sends and receives in kilobytes. The report automatically refreshes and contains only active TCP connections. The utility uses eBPF features and, therefore, has only a very low overhead.

Procedure

1. To monitor the sent and received traffic, enter:

```
# /usr/share/bcc/tools/tcptop
13:46:29 loadavg: 0.10 0.03 0.01 1/215 3875

PID  COMM      LADDR      RADDR      RX_KB  TX_KB
3853 3853      192.0.2.1:22 192.0.2.165:41838 32    102626
1285 sshd      192.0.2.1:22 192.0.2.45:39240 0      0
...
```

The output of the command includes only active TCP connections. If the local or remote system closes a connection, the connection is no longer visible in the output.

2. Press **Ctrl+C** to stop the tracing process.

Additional resources

- **tcptop(8)** man page
- `/usr/share/bcc/tools/doc/tcptop.txt` file

42.11. TRACING ESTABLISHED TCP CONNECTIONS

The **tcptracer** utility traces the kernel functions that connect, accept, and close TCP connections. The utility uses eBPF features and, therefore, has a very low overhead.

Procedure

1. Use the following command to start the tracing process:

```
# /usr/share/bcc/tools/tcptracer
Tracing TCP established connections. Ctrl-C to end.
T PID  COMM      IP SADDR      DADDR      SPORT  DPORT
A 1088 ns-slapd  4 192.0.2.153 192.0.2.1  0     65535
```

```
A 845  sshd      4 192.0.2.1 192.0.2.67 22 42302
X 4502  sshd      4 192.0.2.1 192.0.2.67 22 42302
...
```

Each time the kernel connects, accepts, or closes a connection, **tcptracer** displays the details of the connections.

2. Press **Ctrl+C** to stop the tracing process.

Additional resources

- **tcptracer(8)** man page
- `/usr/share/bcc/tools/doc/tcptracer_example.txt` file

42.12. TRACING IPV4 AND IPV6 LISTEN ATTEMPTS

The **solisten** utility traces all IPv4 and IPv6 listen attempts. It traces the listen attempts including that ultimately fail or the listening program that does not accept the connection. The utility traces function that the kernel calls when a program wants to listen for TCP connections.

Procedure

1. Enter the following command to start the tracing process that displays all listen TCP attempts:

```
# /usr/share/bcc/tools/solisten
PID COMM      PROTO  BACKLOG  PORT  ADDR
3643 nc         TCPv4   1        4242  0.0.0.0
3659 nc         TCPv6   1        4242  2001:db8:1::1
4221 redis-server TCPv6   128     6379  ::
4221 redis-server TCPv4   128     6379  0.0.0.0
....
```

2. Press **Ctrl+C** to stop the tracing process.

Additional resources

- **solisten(9)** man page
- `/usr/share/bcc/tools/doc/solisten_example.txt` file

42.13. SUMMARIZING THE SERVICE TIME OF SOFT INTERRUPTS

The **softirqs** utility summarizes the time spent servicing soft interrupts (soft IRQs) and shows this time as either totals or histogram distributions. This utility uses the **irq:softirq_enter** and **irq:softirq_exit** kernel tracepoints, which is a stable tracing mechanism.

Procedure

1. Enter the following command to start the tracing **soft irq** event time:

```
# /usr/share/bcc/tools/softirqs
Tracing soft irq event time... Hit Ctrl-C to end.
^C
```

SOFTIRQ	TOTAL_usecs
tasklet	166
block	9152
net_rx	12829
rcu	53140
sched	182360
timer	306256

2. Press **Ctrl+C** to stop the tracing process.

Additional resources

- **softirqs(8)** man page
- **/usr/share/bcc/tools/doc/softirqs_example.txt** file
- **mpstat(1)** man page

42.14. SUMMARIZING PACKETS SIZE AND COUNT ON A NETWORK INTERFACE

The **netqtop** utility displays statistics about the attributes of received (RX) and transmitted (TX) packets on each network queue of a particular network interface. The statistics include:

- Bytes per second (BPS)
- Packets per second (PPS)
- The average packet size
- Total number of packets

To generate these statistics, **netqtop** traces the kernel functions that perform events of transmitted packets **net_dev_start_xmit** and received packets **netif_receive_skb**.

Procedure

1. Display the number of packets within the range of bytes size of the time interval of **2** seconds:

```
# /usr/share/bcc/tools/netqtop -n enp1s0 -i 2

Fri Jan 31 18:08:55 2023
TX
QueueID avg_size [0, 64) [64, 512) [512, 2K) [2K, 16K) [16K, 64K)
0 0 0 0 0 0 0
Total 0 0 0 0 0 0

RX
QueueID avg_size [0, 64) [64, 512) [512, 2K) [2K, 16K) [16K, 64K)
0 38.0 1 0 0 0 0
Total 38.0 1 0 0 0 0

-----
Fri Jan 31 18:08:57 2023
TX
QueueID avg_size [0, 64) [64, 512) [512, 2K) [2K, 16K) [16K, 64K)
```

```
0 0 0 0 0 0 0
Total 0 0 0 0 0 0

RX
QueueID avg_size [0, 64) [64, 512) [512, 2K) [2K, 16K) [16K, 64K)
0 38.0 1 0 0 0 0
Total 38.0 1 0 0 0 0
-----
```

2. Press **Ctrl+C** to stop **netqtop**.

Additional resources

- **netqtop(8)** man page
- `/usr/share/bcc/tools/doc/netqtop_example.txt`

42.15. ADDITIONAL RESOURCES

- `/usr/share/doc/bcc/README.md`

CHAPTER 43. CONFIGURING NETWORK DEVICES TO ACCEPT TRAFFIC FROM ALL MAC ADDRESSES

Network devices usually intercept and read packets that their controller is programmed to receive. You can configure the network devices to accept traffic from all MAC addresses in a virtual switch or at the port group level.

You can use this network mode to:

- Diagnose network connectivity issues
- Monitor network activity for security reasons
- Intercept private data-in-transit or intrusion in the network

You can enable this mode for any kind of network device, except **InfiniBand**.

43.1. TEMPORARILY CONFIGURING A DEVICE TO ACCEPT ALL TRAFFIC

You can use the **ip** utility to temporary configure a network device to accept all traffic regardless of the MAC addresses.

Procedure

1. Optional: Display the network interfaces to identify the one for which you want to receive all traffic:

```
# ip address show
1: enp1s0: <NO-CARRIER,BROADCAST,MULTICAST,UP> mtu 1500 qdisc fq_codel state
DOWN group default qlen 1000
    link/ether 98:fa:9b:a4:34:09 brd ff:ff:ff:ff:ff:ff
...
```

2. Modify the device to enable or disable this property:

- To enable the **accept-all-mac-addresses** mode for **enp1s0**:

```
# ip link set enp1s0 promisc on
```

- To disable the **accept-all-mac-addresses** mode for **enp1s0**:

```
# ip link set enp1s0 promisc off
```

Verification

- Verify that the **accept-all-mac-addresses** mode is enabled:

```
# ip link show enp1s0
1: enp1s0: <NO-CARRIER,BROADCAST,MULTICAST,PROMISC,UP> mtu 1500 qdisc
fq_codel state DOWN mode DEFAULT group default qlen 1000
    link/ether 98:fa:9b:a4:34:09 brd ff:ff:ff:ff:ff:ff
```

The **PROMISC** flag in the device description indicates that the mode is enabled.

43.2. PERMANENTLY CONFIGURING A NETWORK DEVICE TO ACCEPT ALL TRAFFIC USING NMCLI

You can use the **nmcli** utility to permanently configure a network device to accept all traffic regardless of the MAC addresses.

Procedure

1. Optional: Display the network interfaces to identify the one for which you want to receive all traffic:

```
# ip address show
1: enp1s0: <NO-CARRIER,BROADCAST,MULTICAST,UP> mtu 1500 qdisc fq_codel state
DOWN group default qlen 1000
    link/ether 98:fa:9b:a4:34:09 brd ff:ff:ff:ff:ff:ff
    ...
```

You can create a new connection, if you do not have any.

2. Modify the network device to enable or disable this property.
 - To enable the **ethernet.accept-all-mac-addresses** mode for **enp1s0**:

```
# nmcli connection modify enp1s0 ethernet.accept-all-mac-addresses yes
```

- To disable the **accept-all-mac-addresses** mode for **enp1s0**:

```
# nmcli connection modify enp1s0 ethernet.accept-all-mac-addresses no
```

3. Apply the changes, reactivate the connection:

```
# nmcli connection up enp1s0
```

Verification

- Verify that the **ethernet.accept-all-mac-addresses** mode is enabled:

```
# nmcli connection show enp1s0
...
802-3-ethernet.accept-all-mac-addresses:1 (true)
```

The **802-3-ethernet.accept-all-mac-addresses: true** indicates that the mode is enabled.

43.3. PERMANENTLY CONFIGURING A NETWORK DEVICE TO ACCEPT ALL TRAFFIC USING NMSTATECTL

Use the **nmstatectl** utility to configure a device to accept all traffic regardless of the MAC addresses through the Nmstate API. The Nmstate API ensures that, after setting the configuration, the result matches the configuration file. If anything fails, **nmstatectl** automatically rolls back the changes to avoid leaving the system in an incorrect state.

Prerequisites

- The **nmstate** package is installed.
- The **enp1s0.yml** file that you used to configure the device is available.

Procedure

1. Edit the existing **enp1s0.yml** file for the **enp1s0** connection and add the following content to it:

```
---
interfaces:
  - name: enp1s0
    type: ethernet
    state: up
    accept-all-mac-address: true
```

These settings configure the **enp1s0** device to accept all traffic.

2. Apply the network settings:

```
# nmstatectl apply ~/enp1s0.yml
```

Verification

- Verify that the **802-3-ethernet.accept-all-mac-addresses** mode is enabled:

```
# nmstatectl show enp1s0
interfaces:
  - name: enp1s0
    type: ethernet
    state: up
    accept-all-mac-addresses: true
  ...
```

The **802-3-ethernet.accept-all-mac-addresses: true** indicates that the mode is enabled.

Additional resources

- **nmstatectl(8)** man page
- **/usr/share/doc/nmstate/examples/** directory

CHAPTER 44. MIRRORING A NETWORK INTERFACE BY USING NMCLI

Network administrators can use port mirroring to replicate inbound and outbound network traffic being communicated from one network device to another. Mirroring traffic of an interface can be helpful in the following situations:

- To debug networking issues and tune the network flow
- To inspect and analyze the network traffic
- To detect an intrusion

Prerequisites

- A network interface to mirror the network traffic to.

Procedure

1. Add a network connection profile that you want to mirror the network traffic from:

```
# nmcli connection add type ethernet ifname enp1s0 con-name enp1s0 autoconnect
no
```

2. Attach a **prio qdisc** to **enp1s0** for the egress (outgoing) traffic with the **10:** handle:

```
# nmcli connection modify enp1s0 +tc.qdisc "root prio handle 10:"
```

The **prio qdisc** attached without children allows attaching filters.

3. Add a **qdisc** for the ingress traffic, with the **ffff:** handle:

```
# nmcli connection modify enp1s0 +tc.qdisc "ingress handle ffff:"
```

4. Add the following filters to match packets on the ingress and egress **qdiscs**, and to mirror them to **enp7s0**:

```
# nmcli connection modify enp1s0 +tc.tfilter "parent ffff: matchall action mirrored egress
mirror dev enp7s0"
```

```
# nmcli connection modify enp1s0 +tc.tfilter "parent 10: matchall action mirrored egress
mirror dev enp7s0"
```

The **matchall** filter matches all packets, and the **mirrored** action redirects packets to destination.

5. Activate the connection:

```
# nmcli connection up enp1s0
```

Verification

1. Install the **tcpdump** utility:

```
# dnf install tcpdump
```

2. Display the traffic mirrored on the target device (**enp7s0**):

```
# tcpdump -i enp7s0
```

Additional resources

- [How to capture network packets using tcpdump](#)

CHAPTER 45. USING NMSTATE-AUTOCONF TO AUTOMATICALLY CONFIGURE THE NETWORK STATE USING LLDP

Network devices can use the Link Layer Discovery Protocol (LLDP) to advertise their identity, capabilities, and neighbors in a LAN. The **nmstate-autoconf** utility can use this information to automatically configure local network interfaces.



IMPORTANT

The **nmstate-autoconf** utility is provided as a Technology Preview only. Technology Preview features are not supported with Red Hat production Service Level Agreements (SLAs), might not be functionally complete, and Red Hat does not recommend using them for production. These previews provide early access to upcoming product features, enabling customers to test functionality and provide feedback during the development process.

See [Technology Preview Features Support Scope](#) on the Red Hat Customer Portal for information about the support scope for Technology Preview features.

45.1. USING NMSTATE-AUTOCONF TO AUTOMATICALLY CONFIGURE NETWORK INTERFACES

The **nmstate-autoconf** utility uses LLDP to identify the VLAN settings of interfaces connected to a switch to configure local devices.

This procedure assumes the following scenario and that the switch broadcasts the VLAN settings using LLDP:

- The **enp1s0** and **enp2s0** interfaces of the RHEL server are connected to switch ports that are configured with VLAN ID **100** and VLAN name **prod-net**.
- The **enp3s0** interface of the RHEL server is connected to a switch port that is configured with VLAN ID **200** and VLAN name **mgmt-net**.

The **nmstate-autoconf** utility then uses this information to create the following interfaces on the server:

- **bond100** - A bond interface with **enp1s0** and **enp2s0** as ports.
- **prod-net** - A VLAN interface on top of **bond100** with VLAN ID **100**.
- **mgmt-net** - A VLAN interface on top of **enp3s0** with VLAN ID **200**

If you connect multiple network interfaces to different switch ports for which LLDP broadcasts the same VLAN ID, **nmstate-autoconf** creates a bond with these interfaces and, additionally, configures the common VLAN ID on top of it.

Prerequisites

- The **nmstate** package is installed.
- LLDP is enabled on the network switch.
- The Ethernet interfaces are up.

Procedure

1. Enable LLDP on the Ethernet interfaces:
 - a. Create a YAML file, for example `~/enable-lldp.yml`, with the following content:

```

interfaces:
  - name: enp1s0
    type: ethernet
    lldp:
      enabled: true
  - name: enp2s0
    type: ethernet
    lldp:
      enabled: true
  - name: enp3s0
    type: ethernet
    lldp:
      enabled: true
    
```

- b. Apply the settings to the system:

```
# nmstatectl apply ~/enable-lldp.yml
```

2. Configure the network interfaces using LLDP:
 - a. Optional, start a dry-run to display and verify the YAML configuration that **nmstate-autoconf** generates:

```

# nmstate-autoconf -d enp1s0,enp2s0,enp3s0
---
interfaces:
  - name: prod-net
    type: vlan
    state: up
    vlan:
      base-iface: bond100
      id: 100
  - name: mgmt-net
    type: vlan
    state: up
    vlan:
      base-iface: enp3s0
      id: 200
  - name: bond100
    type: bond
    state: up
    link-aggregation:
      mode: balance-rr
    port:
      - enp1s0
      - enp2s0
    
```

- b. Use **nmstate-autoconf** to generate the configuration based on information received from LLDP, and apply the settings to the system:

■

```
# nmstate-autoconf enp1s0,enp2s0,enp3s0
```

Next steps

- If there is no DHCP server in your network that provides the IP settings to the interfaces, configure them manual. For details, see:
 - [Configuring an Ethernet connection](#)
 - [Configuring network bonding](#)

Verification

1. Display the settings of the individual interfaces:

```
# nmstatectl show <interface_name>
```

Additional resources

- [nmstate-autoconf\(8\)](#) man page

CHAPTER 46. CONFIGURING 802.3 LINK SETTINGS

Auto-negotiation is a feature of the IEEE 802.3u Fast Ethernet protocol. It targets the device ports to provide an optimal performance of speed, duplex mode, and flow control for information exchange over a link. Using the auto-negotiation protocol, you have optimal performance of data transfer over the Ethernet.



NOTE

To utilize maximum performance of auto-negotiation, use the same configuration on both sides of a link.

46.1. CONFIGURING 802.3 LINK SETTINGS USING THE NMCLI UTILITY

To configure the 802.3 link settings of an Ethernet connection, modify the following configuration parameters:

- **802-3-ethernet.auto-negotiate**
- **802-3-ethernet.speed**
- **802-3-ethernet.duplex**

Procedure

1. Display the current settings of the connection:

```
# nmcli connection show Example-connection
...
802-3-ethernet.speed: 0
802-3-ethernet.duplex: --
802-3-ethernet.auto-negotiate: no
...
```

You can use these values if you need to reset the parameters in case of any problems.

2. Set the speed and duplex link settings:

```
# nmcli connection modify Example-connection 802-3-ethernet.auto-negotiate yes 802-3-ethernet.speed 10000 802-3-ethernet.duplex full
```

This command enables auto-negotiation and sets the speed of the connection to **10000** Mbit full duplex.

3. Reactivate the connection:

```
# nmcli connection up Example-connection
```

Verification

- Use the **ethtool** utility to verify the values of Ethernet interface **enp1s0**:

```
# ethtool enp1s0
```

Settings for enp1s0:

...

Speed: 10000 Mb/s

Duplex: Full

Auto-negotiation: on

...

Link detected: yes

Additional resources

- **nm-settings(5)** man page

CHAPTER 47. GETTING STARTED WITH DPDK

The data plane development kit (DPDK) provides libraries and network drivers to accelerate packet processing in user space.

Administrators use DPDK, for example, in virtual machines to use Single Root I/O Virtualization (SR-IOV) to reduce latencies and increase I/O throughput.



NOTE

Red Hat does not support experimental DPDK APIs.

47.1. INSTALLING THE DPDK PACKAGE

To use DPDK, install the **dpdk** package.

Procedure

- Use the **dnf** utility to install the **dpdk** package:

```
# dnf install dpdk
```

47.2. ADDITIONAL RESOURCES

- [Network Adapter Fast Datapath Feature Support Matrix](#)

CHAPTER 48. GETTING STARTED WITH TIPC

Transparent Inter-process Communication (TIPC), which is also known as **Cluster Domain Sockets**, is an Inter-process Communication (IPC) service for cluster-wide operation.

Applications that are running in a high-available and dynamic cluster environment have special needs. The number of nodes in a cluster can vary, routers can fail, and, due to load balancing considerations, functionality can be moved to different nodes in the cluster. TIPC minimizes the effort by application developers to deal with such situations, and maximizes the chance that they are handled in a correct and optimal way. Additionally, TIPC provides a more efficient and fault-tolerant communication than general protocols, such as TCP.

48.1. THE ARCHITECTURE OF TIPC

TIPC is a layer between applications using TIPC and a packet transport service (**bearer**), and spans the level of transport, network, and signaling link layers. However, TIPC can use a different transport protocol as bearer, so that, for example, a TCP connection can serve as a bearer for a TIPC signaling link.

TIPC supports the following bearers:

- Ethernet
- InfiniBand
- UDP protocol

TIPC provides a reliable transfer of messages between TIPC ports, that are the endpoints of all TIPC communication.

The following is a diagram of the TIPC architecture:

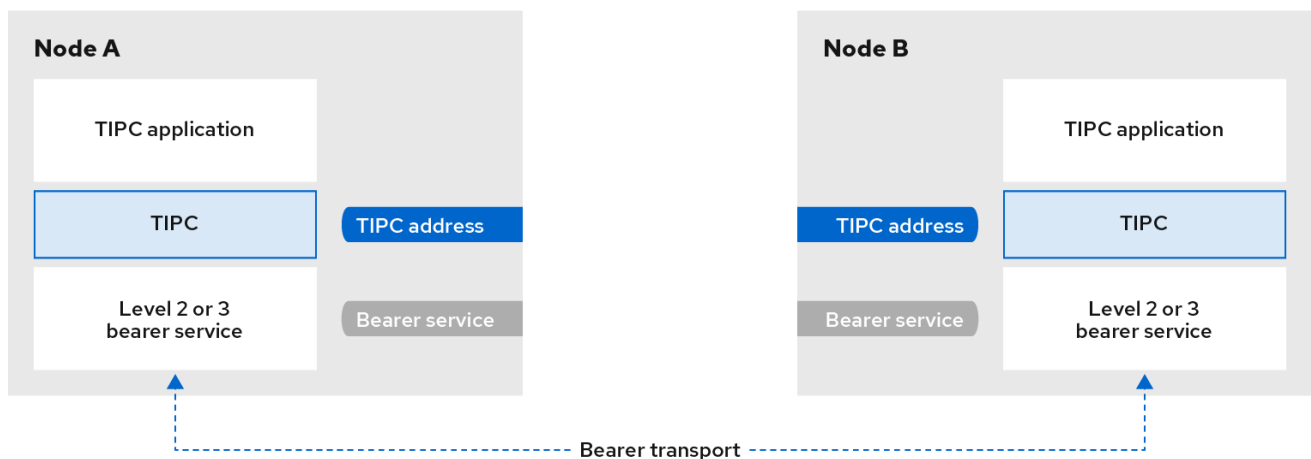

126_RHEL_1020

48.2. LOADING THE TIPC MODULE WHEN THE SYSTEM BOOTS

Before you can use the TIPC protocol, you must load the **tipc** kernel module. You can configure Red Hat Enterprise Linux to automatically load this kernel module automatically when the system boots.

Procedure

1. Create the `/etc/modules-load.d/tipc.conf` file with the following content:

```
tipc
```

- Restart the **systemd-modules-load** service to load the module without rebooting the system:

```
# systemctl start systemd-modules-load
```

Verification

- Use the following command to verify that RHEL loaded the **tipc** module:

```
# lsmod | grep tipc
tipc 311296 0
```

If the command shows no entry for the **tipc** module, RHEL failed to load it.

Additional resources

- **modules-load.d(5)** man page

48.3. CREATING A TIPC NETWORK

To create a TIPC network, perform this procedure on each host that should join the TIPC network.

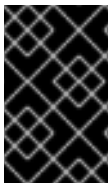

IMPORTANT

The commands configure the TIPC network only temporarily. To permanently configure TIPC on a node, use the commands of this procedure in a script, and configure RHEL to execute that script when the system boots.

Prerequisites

- The **tipc** module has been loaded. For details, see [Loading the tipc module when the system boots](#)

Procedure

- Optional: Set a unique node identity, such as a UUID or the node's host name:

```
# tipc node set identity host_name
```

The identity can be any unique string consisting of a maximum 16 letters and numbers.

You cannot set or change an identity after this step.

- Add a bearer. For example, to use Ethernet as media and **enp0s1** device as physical bearer device, enter:

```
# tipc bearer enable media eth device enp1s0
```

- Optional: For redundancy and better performance, attach further bearers using the command from the previous step. You can configure up to three bearers, but not more than two on the same media.

- Repeat all previous steps on each node that should join the TIPC network.

Verification

- Display the link status for cluster members:

```
# tipc link list
broadcast-link: up
5254006b74be:enp1s0-525400df55d1:enp1s0: up
```

This output indicates that the link between bearer **enp1s0** on node **5254006b74be** and bearer **enp1s0** on node **525400df55d1** is **up**.

- Display the TIPC publishing table:

```
# tipc nametable show
Type   Lower   Upper   Scope  Port   Node
0      1795222054 1795222054 cluster 0      5254006b74be
0      3741353223 3741353223 cluster 0      525400df55d1
1      1         1       node   2399405586 5254006b74be
2      3741353223 3741353223 node   0       5254006b74be
```

- The two entries with service type **0** indicate that two nodes are members of this cluster.
- The entry with service type **1** represents the built-in topology service tracking service.
- The entry with service type **2** displays the link as seen from the issuing node. The range limit **3741353223** represents the peer endpoint's address (a unique 32-bit hash value based on the node identity) in decimal format.

Additional resources

- tipc-bearer(8)** man page
- tipc-namespace(8)** man page

48.4. ADDITIONAL RESOURCES

- Red Hat recommends to use other bearer level protocols to encrypt the communication between nodes based on the transport media. For example:
 - MACSec: See [Using MACsec to encrypt layer 2 traffic](#)
 - IPsec: See [Configuring a VPN with IPsec](#)
- For examples of how to use TIPC, clone the upstream GIT repository using the **git clone git://git.code.sf.net/p/tipc/tipcutils** command. This repository contains the source code of demos and test programs that use TIPC features. Note that this repository is not provided by Red Hat.
- /usr/share/doc/kernel-doc-*<kernel_version>*/Documentation/output/networking/tipc.html** provided by the **kernel-doc** package.

CHAPTER 49. AUTOMATICALLY CONFIGURING NETWORK INTERFACES IN PUBLIC CLOUDS USING NM-CLOUD-SETUP

Usually, a virtual machine (VM) has only one interface that is configurable by DHCP. However, DHCP cannot configure VMs with multiple network entities, such as interfaces, IP subnets, and IP addresses. Additionally, you cannot apply settings when the VM instance is running. To solve this runtime configuration issue, the **nm-cloud-setup** utility automatically retrieves configuration information from the metadata server of the cloud service provider and updates the network configuration of the host. The utility automatically picks up multiple network interfaces, multiple IP addresses, or IP subnets on one interface and helps to reconfigure the network of the running VM instance.

49.1. CONFIGURING AND PRE-DEPLOYING NM-CLOUD-SETUP

To enable and configure network interfaces in public clouds, run **nm-cloud-setup** as a timer and service.



NOTE

On Red Hat Enterprise Linux On Demand and AWS golden images, **nm-cloud-setup** is already enabled and no action is required.

Prerequisite

- A network connection exists.
- The connection uses DHCP.
By default, NetworkManager creates a connection profile which uses DHCP. If no profile was created because you set the **no-auto-default** parameter in **/etc/NetworkManager/NetworkManager.conf**, create this initial connection manually.

Procedure

1. Install the **nm-cloud-setup** package:

```
# dnf install NetworkManager-cloud-setup
```

2. Create and run the snap-in file for the **nm-cloud-setup** service:

- a. Use the following command to start editing the snap-in file:

```
# systemctl edit nm-cloud-setup.service
```

It is important to either start the service explicitly or reboot the system to make configuration settings effective.

- b. Use the **systemd** snap-in file to configure the cloud provider in **nm-cloud-setup**. For example, to use Amazon EC2, enter:

```
[Service]
Environment=NM_CLOUD_SETUP_EC2=yes
```

You can set the following environment variables to enable the cloud provide you use:

- **NM_CLOUD_SETUP_AZURE** for Microsoft Azure

- **NM_CLOUD_SETUP_EC2** for Amazon EC2 (AWS)
- **NM_CLOUD_SETUP_GCP** for Google Cloud Platform(GCP)
- **NM_CLOUD_SETUP_ALIYUN** for Alibaba Cloud (Aliyun)

c. Save the file and quit the editor.

3. Reload the **systemd** configuration:

```
# systemctl daemon-reload
```

4. Enable and start the **nm-cloud-setup** service:

```
# systemctl enable --now nm-cloud-setup.service
```

5. Enable and start the **nm-cloud-setup** timer:

```
# systemctl enable --now nm-cloud-setup.timer
```

Additional resources

- **nm-cloud-setup(8)** man page
- [Configuring an Ethernet connection](#)

49.2. UNDERSTANDING THE ROLE OF IMDSV2 AND NM-CLOUD-SETUP IN THE RHEL EC2 INSTANCE

The instance metadata service (IMDS) in Amazon EC2 allows you to manage permissions to access instance metadata of a running Red Hat Enterprise Linux (RHEL) EC2 instance. The RHEL EC2 instance uses IMDS version 2 (IMDSv2), a session-oriented method. By using the **nm-cloud-setup** utility, administrators can reconfigure the network and automatically update the configuration of running RHEL EC2 instances. The **nm-cloud-setup** utility handles IMDSv2 API calls by using IMDSv2 tokens without any user intervention.

- IMDS runs on a link-local address **169.254.169.254** for providing access to native applications on a RHEL EC2 instance.
- After you have specified and configured IMDSv2 for each RHEL EC2 instance for applications and users, you can no longer access IMDSv1.
- By using IMDSv2, the RHEL EC2 instance maintains metadata without using the IAM role while remaining accessible through the IAM role.
- When the RHEL EC2 instance boots, the **nm-cloud-setup** utility automatically runs to fetch the EC2 instance API access token for using the RHEL EC2 instance API.



NOTE

Use the IMDSv2 token as an HTTP header to check the details of the EC2 environment.

Additional resources

- **nm-cloud-setup(8)** man page