



OpenShift Container Platform 4.15

Networking

Configuring and managing cluster networking

OpenShift Container Platform 4.15 Networking

Configuring and managing cluster networking

Legal Notice

Copyright © 2024 Red Hat, Inc.

The text of and illustrations in this document are licensed by Red Hat under a Creative Commons Attribution–Share Alike 3.0 Unported license ("CC-BY-SA"). An explanation of CC-BY-SA is available at

<http://creativecommons.org/licenses/by-sa/3.0/>

. In accordance with CC-BY-SA, if you distribute this document or an adaptation of it, you must provide the URL for the original version.

Red Hat, as the licensor of this document, waives the right to enforce, and agrees not to assert, Section 4d of CC-BY-SA to the fullest extent permitted by applicable law.

Red Hat, Red Hat Enterprise Linux, the Shadowman logo, the Red Hat logo, JBoss, OpenShift, Fedora, the Infinity logo, and RHCE are trademarks of Red Hat, Inc., registered in the United States and other countries.

Linux[®] is the registered trademark of Linus Torvalds in the United States and other countries.

Java[®] is a registered trademark of Oracle and/or its affiliates.

XFS[®] is a trademark of Silicon Graphics International Corp. or its subsidiaries in the United States and/or other countries.

MySQL[®] is a registered trademark of MySQL AB in the United States, the European Union and other countries.

Node.js[®] is an official trademark of Joyent. Red Hat is not formally related to or endorsed by the official Joyent Node.js open source or commercial project.

The OpenStack[®] Word Mark and OpenStack logo are either registered trademarks/service marks or trademarks/service marks of the OpenStack Foundation, in the United States and other countries and are used with the OpenStack Foundation's permission. We are not affiliated with, endorsed or sponsored by the OpenStack Foundation, or the OpenStack community.

All other trademarks are the property of their respective owners.

Abstract

This document provides instructions for configuring and managing your OpenShift Container Platform cluster network, including DNS, ingress, and the Pod network.

Table of Contents

CHAPTER 1. ABOUT NETWORKING	22
CHAPTER 2. UNDERSTANDING NETWORKING	23
2.1. OPENSIFT CONTAINER PLATFORM DNS	23
2.2. OPENSIFT CONTAINER PLATFORM INGRESS OPERATOR	23
2.2.1. Comparing routes and Ingress	24
2.3. GLOSSARY OF COMMON TERMS FOR OPENSIFT CONTAINER PLATFORM NETWORKING	24
CHAPTER 3. ZERO TRUST NETWORKING	27
3.1. ROOT OF TRUST	27
3.2. TRAFFIC AUTHENTICATION AND ENCRYPTION	27
3.3. IDENTIFICATION AND AUTHENTICATION	28
3.4. INTER-SERVICE AUTHORIZATION	28
3.5. TRANSACTION-LEVEL VERIFICATION	28
3.6. RISK ASSESSMENT	28
3.7. SITE-WIDE POLICY ENFORCEMENT AND DISTRIBUTION	29
3.8. OBSERVABILITY FOR CONSTANT, AND RETROSPECTIVE, EVALUATION	29
3.9. ENDPOINT SECURITY	29
3.10. EXTENDING TRUST OUTSIDE OF THE CLUSTER	30
CHAPTER 4. ACCESSING HOSTS	31
4.1. ACCESSING HOSTS ON AMAZON WEB SERVICES IN AN INSTALLER-PROVISIONED INFRASTRUCTURE CLUSTER	31
CHAPTER 5. NETWORKING OPERATORS OVERVIEW	32
5.1. CLUSTER NETWORK OPERATOR	32
5.2. DNS OPERATOR	32
5.3. INGRESS OPERATOR	32
5.4. EXTERNAL DNS OPERATOR	32
5.5. INGRESS NODE FIREWALL OPERATOR	32
5.6. NETWORK OBSERVABILITY OPERATOR	32
CHAPTER 6. NETWORKING DASHBOARDS	33
6.1. NETWORK OBSERVABILITY OPERATOR	33
6.2. NETWORKING AND OVN-KUBERNETES DASHBOARD	33
6.3. INGRESS OPERATOR DASHBOARD	33
CHAPTER 7. CLUSTER NETWORK OPERATOR IN OPENSIFT CONTAINER PLATFORM	34
7.1. CLUSTER NETWORK OPERATOR	34
7.2. VIEWING THE CLUSTER NETWORK CONFIGURATION	34
7.3. VIEWING CLUSTER NETWORK OPERATOR STATUS	35
7.4. VIEWING CLUSTER NETWORK OPERATOR LOGS	35
7.5. CLUSTER NETWORK OPERATOR CONFIGURATION	35
7.5.1. Cluster Network Operator configuration object	36
defaultNetwork object configuration	37
Configuration for the OpenShift SDN network plugin	37
Configuration for the OVN-Kubernetes network plugin	38
kubeProxyConfig object configuration (OpenShiftSDN container network interface only)	42
7.5.2. Cluster Network Operator example configuration	43
7.6. ADDITIONAL RESOURCES	44
CHAPTER 8. DNS OPERATOR IN OPENSIFT CONTAINER PLATFORM	45
8.1. DNS OPERATOR	45

8.2. CHANGING THE DNS OPERATOR MANAGEMENTSTATE	45
8.3. CONTROLLING DNS POD PLACEMENT	46
8.4. VIEW THE DEFAULT DNS	47
8.5. USING DNS FORWARDING	47
8.6. DNS OPERATOR STATUS	51
8.7. DNS OPERATOR LOGS	52
8.8. SETTING THE COREDNS LOG LEVEL	52
8.9. SETTING THE COREDNS OPERATOR LOG LEVEL	52
8.10. TUNING THE COREDNS CACHE	53
CHAPTER 9. INGRESS OPERATOR IN OPENSIFT CONTAINER PLATFORM	55
9.1. OPENSIFT CONTAINER PLATFORM INGRESS OPERATOR	55
9.2. THE INGRESS CONFIGURATION ASSET	55
9.3. INGRESS CONTROLLER CONFIGURATION PARAMETERS	55
9.3.1. Ingress Controller TLS security profiles	66
9.3.1.1. Understanding TLS security profiles	66
9.3.1.2. Configuring the TLS security profile for the Ingress Controller	67
9.3.1.3. Configuring mutual TLS authentication	69
9.4. VIEW THE DEFAULT INGRESS CONTROLLER	71
9.5. VIEW INGRESS OPERATOR STATUS	71
9.6. VIEW INGRESS CONTROLLER LOGS	71
9.7. VIEW INGRESS CONTROLLER STATUS	71
9.8. CONFIGURING THE INGRESS CONTROLLER	71
9.8.1. Setting a custom default certificate	72
9.8.2. Removing a custom default certificate	73
9.8.3. Autoscaling an Ingress Controller	74
9.8.4. Scaling an Ingress Controller	78
9.8.5. Configuring Ingress access logging	79
9.8.6. Setting Ingress Controller thread count	82
9.8.7. Configuring an Ingress Controller to use an internal load balancer	82
9.8.8. Configuring global access for an Ingress Controller on GCP	84
9.8.9. Setting the Ingress Controller health check interval	85
9.8.10. Configuring the default Ingress Controller for your cluster to be internal	86
9.8.11. Configuring the route admission policy	87
9.8.12. Using wildcard routes	88
9.8.13. HTTP header configuration	88
9.8.13.1. Order of precedence	88
9.8.13.2. Special case headers	90
9.8.14. Setting or deleting HTTP request and response headers in an Ingress Controller	91
9.8.15. Using X-Forwarded headers	93
Example use cases	93
9.8.16. Enabling HTTP/2 Ingress connectivity	94
9.8.17. Configuring the PROXY protocol for an Ingress Controller	95
9.8.18. Specifying an alternative cluster domain using the appsDomain option	96
9.8.19. Converting HTTP header case	97
9.8.20. Using router compression	99
9.8.21. Exposing router metrics	99
9.8.22. Customizing HAProxy error code response pages	101
9.8.23. Setting the Ingress Controller maximum connections	103
9.9. ADDITIONAL RESOURCES	104
CHAPTER 10. INGRESS SHARDING IN OPENSIFT CONTAINER PLATFORM	105
10.1. INGRESS CONTROLLER SHARDING	105

10.1.1. Traditional sharding example	106
10.1.2. Overlapped sharding example	107
10.1.3. Sharding the default Ingress Controller	107
10.1.4. Ingress sharding and DNS	108
10.1.5. Configuring Ingress Controller sharding by using route labels	108
10.1.6. Configuring Ingress Controller sharding by using namespace labels	110
10.2. CREATING A ROUTE FOR INGRESS CONTROLLER SHARDING	111
Additional Resources	113
CHAPTER 11. INGRESS NODE FIREWALL OPERATOR IN OPENSIFT CONTAINER PLATFORM	114
11.1. INGRESS NODE FIREWALL OPERATOR	114
11.2. INSTALLING THE INGRESS NODE FIREWALL OPERATOR	114
11.2.1. Installing the Ingress Node Firewall Operator using the CLI	114
11.2.2. Installing the Ingress Node Firewall Operator using the web console	116
11.3. DEPLOYING INGRESS NODE FIREWALL OPERATOR	117
11.3.1. Ingress Node Firewall configuration object	117
Ingress Node Firewall Operator example configuration	118
11.3.2. Ingress Node Firewall rules object	118
Ingress object configuration	119
Ingress Node Firewall rules object example	120
Zero trust Ingress Node Firewall rules object example	121
11.4. VIEWING INGRESS NODE FIREWALL OPERATOR RULES	122
11.5. TROUBLESHOOTING THE INGRESS NODE FIREWALL OPERATOR	122
CHAPTER 12. CONFIGURING AN INGRESS CONTROLLER FOR MANUAL DNS MANAGEMENT	124
12.1. MANAGED DNS MANAGEMENT POLICY	124
12.2. UNMANAGED DNS MANAGEMENT POLICY	124
12.3. CREATING A CUSTOM INGRESS CONTROLLER WITH THE UNMANAGED DNS MANAGEMENT POLICY	124
12.4. MODIFYING AN EXISTING INGRESS CONTROLLER	125
12.5. ADDITIONAL RESOURCES	126
CHAPTER 13. CONFIGURING THE INGRESS CONTROLLER ENDPOINT PUBLISHING STRATEGY	127
13.1. INGRESS CONTROLLER ENDPOINT PUBLISHING STRATEGY	127
13.1.1. Configuring the Ingress Controller endpoint publishing scope to Internal	128
13.1.2. Configuring the Ingress Controller endpoint publishing scope to External	129
13.2. ADDITIONAL RESOURCES	129
CHAPTER 14. VERIFYING CONNECTIVITY TO AN ENDPOINT	130
14.1. CONNECTION HEALTH CHECKS PERFORMED	130
14.2. IMPLEMENTATION OF CONNECTION HEALTH CHECKS	130
14.3. PODNETWORKCONNECTIVITYCHECK OBJECT FIELDS	130
Connection log fields	132
14.4. VERIFYING NETWORK CONNECTIVITY FOR AN ENDPOINT	133
CHAPTER 15. CHANGING THE MTU FOR THE CLUSTER NETWORK	138
15.1. ABOUT THE CLUSTER MTU	138
15.1.1. Service interruption considerations	138
15.1.2. MTU value selection	138
15.1.3. How the migration process works	138
15.2. CHANGING THE CLUSTER NETWORK MTU	140
15.3. ADDITIONAL RESOURCES	146
CHAPTER 16. CONFIGURING THE NODE PORT SERVICE RANGE	147
16.1. PREREQUISITES	147

16.2. EXPANDING THE NODE PORT RANGE	147
16.3. ADDITIONAL RESOURCES	148
CHAPTER 17. CONFIGURING THE CLUSTER NETWORK RANGE	149
17.1. EXPANDING THE CLUSTER NETWORK IP ADDRESS RANGE	149
17.2. ADDITIONAL RESOURCES	150
CHAPTER 18. CONFIGURING IP FAILOVER	151
18.1. IP FAILOVER ENVIRONMENT VARIABLES	152
18.2. CONFIGURING IP FAILOVER IN YOUR CLUSTER	153
18.3. CONFIGURING CHECK AND NOTIFY SCRIPTS	156
18.4. CONFIGURING VRRP PREEMPTION	158
18.5. DEPLOYING MULTIPLE IP FAILOVER INSTANCES	159
18.6. CONFIGURING IP FAILOVER FOR MORE THAN 254 ADDRESSES	159
18.7. HIGH AVAILABILITY FOR EXTERNAL IP	160
18.8. REMOVING IP FAILOVER	160
CHAPTER 19. CONFIGURING SYSTEM CONTROLS AND INTERFACE ATTRIBUTES USING THE TUNING PLUGIN	163
19.1. CONFIGURING SYSTEM CONTROLS BY USING THE TUNING CNI	163
19.2. ENABLING ALL-MULTICAST MODE BY USING THE TUNING CNI	166
19.3. ADDITIONAL RESOURCES	169
CHAPTER 20. USING THE STREAM CONTROL TRANSMISSION PROTOCOL (SCTP) ON A BARE METAL CLUSTER	170
20.1. SUPPORT FOR STREAM CONTROL TRANSMISSION PROTOCOL (SCTP) ON OPENSIFT CONTAINER PLATFORM	170
20.1.1. Example configurations using SCTP protocol	170
20.2. ENABLING STREAM CONTROL TRANSMISSION PROTOCOL (SCTP)	171
20.3. VERIFYING STREAM CONTROL TRANSMISSION PROTOCOL (SCTP) IS ENABLED	172
CHAPTER 21. USING PTP HARDWARE	175
21.1. ABOUT PTP IN OPENSIFT CONTAINER PLATFORM CLUSTER NODES	175
21.1.1. Elements of a PTP domain	175
Advantages of PTP over NTP	176
21.1.2. Using dual Intel E810 NIC hardware with PTP	177
21.1.3. Overview of linuxptp and gpsd in OpenShift Container Platform nodes	178
21.1.4. Overview of GNSS timing for PTP grandmaster clocks	179
21.2. CONFIGURING PTP DEVICES	181
21.2.1. Installing the PTP Operator using the CLI	181
21.2.2. Installing the PTP Operator by using the web console	182
21.2.3. Discovering PTP capable network devices in your cluster	183
21.2.4. Using hardware-specific NIC features with the PTP Operator	184
21.2.5. Configuring linuxptp services as a grandmaster clock	184
21.2.6. Configuring linuxptp services as a grandmaster clock for dual E810 Westport Channel NICs	193
21.2.6.1. Grandmaster clock PtpConfig configuration reference	199
21.2.6.2. Grandmaster clock class sync state reference	201
21.2.6.3. Intel Westport Channel E810 hardware configuration reference	202
21.2.6.4. Dual E810 Westport Channel NIC configuration reference	204
21.2.7. Configuring linuxptp services as a boundary clock	204
21.2.7.1. Configuring linuxptp services as boundary clocks for dual NIC hardware	210
21.2.8. Configuring linuxptp services as an ordinary clock	212
21.2.8.1. Intel Columbiaville E800 series NIC as PTP ordinary clock reference	217
21.2.9. Configuring FIFO priority scheduling for PTP hardware	218
21.2.10. Configuring log filtering for linuxptp services	219

21.2.11. Troubleshooting common PTP Operator issues	220
21.2.12. Collecting PTP Operator data	223
21.3. USING THE PTP HARDWARE FAST EVENT NOTIFICATIONS FRAMEWORK	224
21.3.1. About PTP and clock synchronization error events	224
21.3.2. About the PTP fast event notifications framework	224
21.3.3. Configuring the PTP fast event notifications publisher	226
21.3.4. Migrating consumer applications to use HTTP transport for PTP or bare-metal events	227
21.3.5. Installing the AMQ messaging bus	229
21.3.6. Subscribing DU applications to PTP events with the REST API	230
21.3.6.1. PTP events REST API reference	230
21.3.6.1.1. api/ocloudNotifications/v1/subscriptions	230
HTTP method	230
Description	231
HTTP method	231
Description	231
21.3.6.1.2. api/ocloudNotifications/v1/subscriptions/<subscription_id>	231
HTTP method	231
Description	231
21.3.6.1.3. api/ocloudNotifications/v1/health	232
HTTP method	232
Description	232
21.3.6.1.4. api/ocloudNotifications/v1/publishers	232
HTTP method	232
Description	232
21.3.6.1.5. api/ocloudNotifications/v1/<resource_address>/CurrentState	235
HTTP method	235
Description	235
21.3.7. Monitoring PTP fast event metrics	237
21.3.8. PTP fast event metrics reference	238
21.4. DEVELOPING PTP EVENTS CONSUMER APPLICATIONS	240
21.4.1. PTP events consumer application reference	241
21.4.2. Reference cloud-event-proxy deployment and service CRs	242
21.4.3. PTP events available from the cloud-event-proxy sidecar REST API	245
21.4.4. Subscribing the consumer application to PTP events	245
21.4.4.1. Subscribing to PTP lock-state events	245
21.4.4.2. Subscribing to PTP os-clock-sync-state events	246
21.4.4.3. Subscribing to PTP ptp-clock-class-change events	246
21.4.5. Getting the current PTP clock status	247
21.4.6. Verifying that the PTP events consumer application is receiving events	247
CHAPTER 22. EXTERNAL DNS OPERATOR	250
22.1. EXTERNAL DNS OPERATOR RELEASE NOTES	250
22.1.1. External DNS Operator 1.2.0	250
22.1.1.1. New features	250
22.1.1.2. Bug fixes	250
22.1.2. External DNS Operator 1.1.1	250
22.1.3. External DNS Operator 1.1.0	250
22.1.3.1. Bug fixes	250
22.1.4. External DNS Operator 1.0.1	250
22.1.5. External DNS Operator 1.0.0	250
22.1.5.1. Bug fixes	251
22.2. EXTERNAL DNS OPERATOR IN OPENSIFT CONTAINER PLATFORM	251
22.2.1. External DNS Operator	251

22.2.2. External DNS Operator logs	252
22.2.2.1. External DNS Operator domain name limitations	252
22.3. INSTALLING EXTERNAL DNS OPERATOR ON CLOUD PROVIDERS	252
22.3.1. Installing the External DNS Operator	253
22.4. EXTERNAL DNS OPERATOR CONFIGURATION PARAMETERS	253
22.4.1. External DNS Operator configuration parameters	253
22.5. CREATING DNS RECORDS ON AWS	256
22.5.1. Creating DNS records on a public hosted zone for AWS by using Red Hat External DNS Operator	256
22.5.2. Creating DNS records in a different AWS Account using a shared VPC	257
22.6. CREATING DNS RECORDS ON AZURE	259
22.6.1. Creating DNS records on an Azure public DNS zone	259
22.7. CREATING DNS RECORDS ON GCP	261
22.7.1. Creating DNS records on a public managed zone for GCP	261
22.8. CREATING DNS RECORDS ON INFOBLOX	263
22.8.1. Creating DNS records on a public DNS zone on Infoblox	263
22.9. CONFIGURING THE CLUSTER-WIDE PROXY ON THE EXTERNAL DNS OPERATOR	264
22.9.1. Trusting the certificate authority of the cluster-wide proxy	264
CHAPTER 23. NETWORK POLICY	266
23.1. ABOUT NETWORK POLICY	266
23.1.1. About network policy	266
23.1.1.1. Using the allow-from-router network policy	268
23.1.1.2. Using the allow-from-hostnetwork network policy	268
23.1.2. Optimizations for network policy with OpenShift SDN	269
23.1.3. Optimizations for network policy with OVN-Kubernetes network plugin	269
23.1.4. Next steps	271
23.1.5. Additional resources	271
23.2. CREATING A NETWORK POLICY	271
23.2.1. Example NetworkPolicy object	271
23.2.2. Creating a network policy using the CLI	272
23.2.3. Creating a default deny all network policy	274
23.2.4. Creating a network policy to allow traffic from external clients	275
23.2.5. Creating a network policy allowing traffic to an application from all namespaces	276
23.2.6. Creating a network policy allowing traffic to an application from a namespace	278
23.2.7. Additional resources	281
23.3. VIEWING A NETWORK POLICY	281
23.3.1. Example NetworkPolicy object	281
23.3.2. Viewing network policies using the CLI	282
23.4. EDITING A NETWORK POLICY	283
23.4.1. Editing a network policy	283
23.4.2. Example NetworkPolicy object	284
23.4.3. Additional resources	285
23.5. DELETING A NETWORK POLICY	285
23.5.1. Deleting a network policy using the CLI	285
23.6. DEFINING A DEFAULT NETWORK POLICY FOR PROJECTS	286
23.6.1. Modifying the template for new projects	286
23.6.2. Adding network policies to the new project template	287
23.7. CONFIGURING MULTITENANT ISOLATION WITH NETWORK POLICY	289
23.7.1. Configuring multitenant isolation by using network policy	289
23.7.2. Next steps	292
23.7.3. Additional resources	292
CHAPTER 24. CIDR RANGE DEFINITIONS	293

24.1. MACHINE CIDR	293
24.2. SERVICE CIDR	293
24.3. POD CIDR	293
24.4. HOST PREFIX	293
CHAPTER 25. AWS LOAD BALANCER OPERATOR	294
25.1. AWS LOAD BALANCER OPERATOR RELEASE NOTES	294
25.1.1. AWS Load Balancer Operator 1.1.1	294
25.1.2. AWS Load Balancer Operator 1.1.0	294
25.1.2.1. Notable changes	294
25.1.2.2. New features	294
25.1.2.3. Bug fixes	294
25.1.3. AWS Load Balancer Operator 1.0.1	295
25.1.4. AWS Load Balancer Operator 1.0.0	295
25.1.4.1. Notable changes	295
25.1.4.2. Bug fixes	295
25.1.5. Earlier versions	295
25.2. AWS LOAD BALANCER OPERATOR IN OPENSIFT CONTAINER PLATFORM	295
25.2.1. AWS Load Balancer Operator considerations	296
25.2.2. AWS Load Balancer Operator	296
25.2.3. Using the AWS Load Balancer Operator in an AWS VPC cluster extended into an Outpost	297
25.2.4. AWS Load Balancer Operator logs	298
25.3. INSTALLING THE AWS LOAD BALANCER OPERATOR	298
25.3.1. Installing the AWS Load Balancer Operator by using the web console	298
25.3.2. Installing the AWS Load Balancer Operator by using the CLI	299
25.4. PREPARING FOR THE AWS LOAD BALANCER OPERATOR ON A CLUSTER USING THE AWS SECURITY TOKEN SERVICE	300
25.4.1. Creating an IAM role for the AWS Load Balancer Operator	301
25.4.1.1. Creating an AWS IAM role by using the Cloud Credential Operator utility	301
25.4.1.2. Creating an AWS IAM role by using the AWS CLI	302
25.4.2. Configuring the ARN role for the AWS Load Balancer Operator	303
25.4.3. Creating an IAM role for the AWS Load Balancer Controller	304
25.4.3.1. Creating an AWS IAM role for the controller by using the Cloud Credential Operator utility	304
25.4.3.2. Creating an AWS IAM role for the controller by using the AWS CLI	305
25.4.4. Additional resources	307
25.5. CREATING AN INSTANCE OF THE AWS LOAD BALANCER CONTROLLER	307
25.5.1. Creating the AWS Load Balancer Controller	307
25.6. SERVING MULTIPLE INGRESS RESOURCES THROUGH A SINGLE AWS LOAD BALANCER	310
25.6.1. Creating multiple ingress resources through a single AWS Load Balancer	310
25.7. ADDING TLS TERMINATION	313
25.7.1. Adding TLS termination on the AWS Load Balancer	313
25.8. CONFIGURING CLUSTER-WIDE PROXY	315
25.8.1. Trusting the certificate authority of the cluster-wide proxy	315
25.8.2. Additional resources	316
CHAPTER 26. MULTIPLE NETWORKS	317
26.1. UNDERSTANDING MULTIPLE NETWORKS	317
26.1.1. Usage scenarios for an additional network	317
26.1.2. Additional networks in OpenShift Container Platform	317
26.2. CONFIGURING AN ADDITIONAL NETWORK	318
26.2.1. Approaches to managing an additional network	318
26.2.2. Configuration for an additional network attachment	319
26.2.2.1. Configuration of an additional network through the Cluster Network Operator	319

26.2.2.2. Configuration of an additional network from a YAML manifest	320
26.2.3. Configurations for additional network types	320
26.2.3.1. Configuration for a bridge additional network	320
26.2.3.1.1. bridge configuration example	322
26.2.3.2. Configuration for a host device additional network	322
26.2.3.2.1. host-device configuration example	323
26.2.3.3. Configuration for an VLAN additional network	323
26.2.3.3.1. vlan configuration example	324
26.2.3.4. Configuration for an IPVLAN additional network	324
26.2.3.4.1. ipvlan configuration example	325
26.2.3.5. Configuration for a MACVLAN additional network	326
26.2.3.5.1. macvlan configuration example	327
26.2.3.6. Configuration for a TAP additional network	327
26.2.3.6.1. Tap configuration example	328
26.2.3.6.2. Setting SELinux boolean for the TAP CNI plugin	328
26.2.3.7. Configuration for an OVN-Kubernetes additional network	329
26.2.3.7.1. Supported platforms for OVN-Kubernetes additional network	330
26.2.3.7.2. OVN-Kubernetes network plugin JSON configuration table	330
26.2.3.7.3. Compatibility with multi-network policy	331
26.2.3.7.4. Configuration for a layer 2 switched topology	333
26.2.3.7.5. Configuration for a localnet topology	333
26.2.3.7.5.1. Prerequisites for configuring OVN-Kubernetes additional network	333
26.2.3.7.5.2. Configuration for an OVN-Kubernetes additional network mapping	333
26.2.3.7.6. Configuring pods for additional networks	335
26.2.3.7.7. Configuring pods with a static IP address	336
26.2.4. Configuration of IP address assignment for an additional network	337
26.2.4.1. Static IP address assignment configuration	337
26.2.4.2. Dynamic IP address (DHCP) assignment configuration	338
26.2.4.3. Dynamic IP address assignment configuration with Whereabouts	339
26.2.4.4. Creating a whereabouts-reconciler daemon set	340
26.2.4.5. Configuring the Whereabouts IP reconciler schedule	341
26.2.4.6. Creating a configuration for assignment of dual-stack IP addresses dynamically	343
26.2.5. Creating an additional network attachment with the Cluster Network Operator	344
26.2.6. Creating an additional network attachment by applying a YAML manifest	345
26.2.7. About configuring the master interface in the container network namespace	346
26.2.7.1. Creating multiple VLANs on SR-IOV VFs	346
26.2.7.2. Creating a subinterface based on a bridge master interface in a container namespace	351
26.3. ABOUT VIRTUAL ROUTING AND FORWARDING	354
26.3.1. About virtual routing and forwarding	354
26.3.1.1. Benefits of secondary networks for pods for telecommunications operators	354
26.4. CONFIGURING MULTI-NETWORK POLICY	355
26.4.1. Differences between multi-network policy and network policy	355
26.4.2. Enabling multi-network policy for the cluster	355
26.4.3. Supporting multi-network policies in IPv6 networks	356
26.4.4. Working with multi-network policy	357
26.4.4.1. Prerequisites	357
26.4.4.2. Creating a multi-network policy using the CLI	357
26.4.4.3. Editing a multi-network policy	360
26.4.4.4. Viewing multi-network policies using the CLI	361
26.4.4.5. Deleting a multi-network policy using the CLI	362
26.4.4.6. Creating a default deny all multi-network policy	363
26.4.4.7. Creating a multi-network policy to allow traffic from external clients	364
26.4.4.8. Creating a multi-network policy allowing traffic to an application from all namespaces	366

26.4.4.9. Creating a multi-network policy allowing traffic to an application from a namespace	368
26.4.5. Additional resources	370
26.5. ATTACHING A POD TO AN ADDITIONAL NETWORK	370
26.5.1. Adding a pod to an additional network	370
26.5.1.1. Specifying pod-specific addressing and routing options	372
26.6. REMOVING A POD FROM AN ADDITIONAL NETWORK	376
26.6.1. Removing a pod from an additional network	376
26.7. EDITING AN ADDITIONAL NETWORK	376
26.7.1. Modifying an additional network attachment definition	376
26.8. REMOVING AN ADDITIONAL NETWORK	377
26.8.1. Removing an additional network attachment definition	377
26.9. ASSIGNING A SECONDARY NETWORK TO A VRF	378
26.9.1. Creating an additional network attachment with the CNI VRF plugin	379
CHAPTER 27. HARDWARE NETWORKS	382
27.1. ABOUT SINGLE ROOT I/O VIRTUALIZATION (SR-IOV) HARDWARE NETWORKS	382
27.1.1. Components that manage SR-IOV network devices	382
27.1.1.1. Supported platforms	383
27.1.1.2. Supported devices	383
27.1.1.3. Automated discovery of SR-IOV network devices	385
27.1.1.3.1. Example SriovNetworkNodeState object	385
27.1.1.4. Example use of a virtual function in a pod	386
27.1.1.5. DPDK library for use with container applications	388
27.1.1.6. Huge pages resource injection for Downward API	388
27.1.2. Additional resources	389
27.1.3. Next steps	389
27.2. INSTALLING THE SR-IOV NETWORK OPERATOR	389
27.2.1. Installing the SR-IOV Network Operator	389
27.2.1.1. CLI: Installing the SR-IOV Network Operator	389
27.2.1.2. Web console: Installing the SR-IOV Network Operator	390
27.2.2. Next steps	392
27.3. CONFIGURING THE SR-IOV NETWORK OPERATOR	392
27.3.1. Configuring the SR-IOV Network Operator	392
27.3.1.1. SR-IOV Network Operator config custom resource	392
27.3.1.2. About the Network Resources Injector	393
27.3.1.3. About the SR-IOV Network Operator admission controller webhook	393
27.3.1.4. About custom node selectors	394
27.3.1.5. Disabling or enabling the Network Resources Injector	394
27.3.1.6. Disabling or enabling the SR-IOV Network Operator admission controller webhook	395
27.3.1.7. Configuring a custom NodeSelector for the SR-IOV Network Config daemon	395
27.3.1.8. Configuring the SR-IOV Network Operator for single node installations	396
27.3.1.9. Deploying the SR-IOV Operator for hosted control planes	397
27.3.2. Next steps	399
27.4. CONFIGURING AN SR-IOV NETWORK DEVICE	399
27.4.1. SR-IOV network node configuration object	399
27.4.1.1. SR-IOV network node configuration examples	401
27.4.1.2. Virtual function (VF) partitioning for SR-IOV devices	402
27.4.2. Configuring SR-IOV network devices	404
27.4.3. Troubleshooting SR-IOV configuration	405
27.4.4. Assigning an SR-IOV network to a VRF	405
27.4.4.1. Creating an additional SR-IOV network attachment with the CNI VRF plugin	406
27.4.5. Exclude the SR-IOV network topology for NUMA-aware scheduling	408
27.4.5.1. Excluding the SR-IOV network topology for NUMA-aware scheduling	408

27.4.6. Next steps	412
27.5. CONFIGURING AN SR-IOV ETHERNET NETWORK ATTACHMENT	412
27.5.1. Ethernet device configuration object	412
27.5.1.1. Configuration of IP address assignment for an additional network	413
27.5.1.1.1. Static IP address assignment configuration	414
27.5.1.1.2. Dynamic IP address (DHCP) assignment configuration	415
27.5.1.1.3. Dynamic IP address assignment configuration with Whereabouts	416
27.5.1.2. Creating a configuration for assignment of dual-stack IP addresses dynamically	417
27.5.2. Configuring SR-IOV additional network	418
27.5.3. Next steps	419
27.5.4. Additional resources	419
27.6. CONFIGURING AN SR-IOV INFINIBAND NETWORK ATTACHMENT	419
27.6.1. InfiniBand device configuration object	419
27.6.1.1. Configuration of IP address assignment for an additional network	420
27.6.1.1.1. Static IP address assignment configuration	420
27.6.1.1.2. Dynamic IP address (DHCP) assignment configuration	422
27.6.1.1.3. Dynamic IP address assignment configuration with Whereabouts	423
27.6.1.2. Creating a configuration for assignment of dual-stack IP addresses dynamically	423
27.6.2. Configuring SR-IOV additional network	424
27.6.3. Next steps	425
27.6.4. Additional resources	425
27.7. ADDING A POD TO AN SR-IOV ADDITIONAL NETWORK	425
27.7.1. Runtime configuration for a network attachment	425
27.7.1.1. Runtime configuration for an Ethernet-based SR-IOV attachment	425
27.7.1.2. Runtime configuration for an InfiniBand-based SR-IOV attachment	426
27.7.2. Adding a pod to an additional network	427
27.7.3. Creating a non-uniform memory access (NUMA) aligned SR-IOV pod	430
27.7.4. A test pod template for clusters that use SR-IOV on OpenStack	431
27.7.5. Additional resources	432
27.8. CONFIGURING INTERFACE-LEVEL NETWORK SYSCTL SETTINGS AND ALL-MULTICAST MODE FOR SR-IOV NETWORKS	432
27.8.1. Labeling nodes with an SR-IOV enabled NIC	432
27.8.2. Setting one sysctl flag	432
27.8.2.1. Setting one sysctl flag on nodes with SR-IOV network devices	433
27.8.2.2. Configuring sysctl on a SR-IOV network	434
27.8.3. Configuring sysctl settings for pods associated with bonded SR-IOV interface flag	438
27.8.3.1. Setting all sysctl flag on nodes with bonded SR-IOV network devices	438
27.8.3.2. Configuring sysctl on a bonded SR-IOV network	440
27.8.4. About all-multicast mode	444
27.8.4.1. Enabling the all-multicast mode on an SR-IOV network	444
27.9. USING HIGH PERFORMANCE MULTICAST	449
27.9.1. High performance multicast	449
27.9.2. Configuring an SR-IOV interface for multicast	449
27.10. USING DPDK AND RDMA	451
27.10.1. Using a virtual function in DPDK mode with an Intel NIC	451
27.10.2. Using a virtual function in DPDK mode with a Mellanox NIC	454
27.10.3. Using the TAP CNI to run a rootless DPDK workload with kernel access	457
27.10.4. Overview of achieving a specific DPDK line rate	462
27.10.5. Using SR-IOV and the Node Tuning Operator to achieve a DPDK line rate	463
27.10.5.1. Example SR-IOV Network Operator for virtual functions	464
27.10.5.2. Example SR-IOV network operator	466
27.10.5.3. Example DPDK base workload	467
27.10.5.4. Example testpmd script	468

27.10.6. Using a virtual function in RDMA mode with a Mellanox NIC	468
27.10.7. A test pod template for clusters that use OVS-DPDK on OpenStack	472
27.10.8. A test pod template for clusters that use OVS hardware offloading on OpenStack	473
27.10.9. Additional resources	473
27.11. USING POD-LEVEL BONDING	474
27.11.1. Configuring a bond interface from two SR-IOV interfaces	474
27.11.1.1. Creating a bond network attachment definition	474
27.11.1.2. Creating a pod using a bond interface	476
27.12. CONFIGURING HARDWARE OFFLOADING	477
27.12.1. About hardware offloading	477
27.12.2. Supported devices	478
27.12.3. Prerequisites	478
27.12.4. Configuring a machine config pool for hardware offloading	478
27.12.5. Configuring the SR-IOV network node policy	480
27.12.5.1. An example SR-IOV network node policy for OpenStack	481
27.12.6. Improving network traffic performance using a virtual function	481
27.12.7. Creating a network attachment definition	483
27.12.8. Adding the network attachment definition to your pods	484
27.13. SWITCHING BLUEFIELD-2 FROM DPU TO NIC	485
27.13.1. Switching Bluefield-2 from DPU mode to NIC mode	485
27.14. UNINSTALLING THE SR-IOV NETWORK OPERATOR	487
27.14.1. Uninstalling the SR-IOV Network Operator	487
CHAPTER 28. OVN-KUBERNETES NETWORK PLUGIN	489
28.1. ABOUT THE OVN-KUBERNETES NETWORK PLUGIN	489
28.1.1. OVN-Kubernetes purpose	489
28.1.2. Supported network plugin feature matrix	490
28.1.3. OVN-Kubernetes IPv6 and dual-stack limitations	490
28.1.4. Session affinity	491
Stickiness timeout for session affinity	491
28.2. OVN-KUBERNETES ARCHITECTURE	492
28.2.1. Introduction to OVN-Kubernetes architecture	492
28.2.2. Listing all resources in the OVN-Kubernetes project	494
28.2.3. Listing the OVN-Kubernetes northbound database contents	496
28.2.4. Command line arguments for ovn-nbctl to examine northbound database contents	500
28.2.5. Listing the OVN-Kubernetes southbound database contents	501
28.2.6. Command line arguments for ovn-sbctl to examine southbound database contents	503
28.2.7. OVN-Kubernetes logical architecture	504
28.2.7.1. Installing network-tools on local host	505
28.2.7.2. Running network-tools	505
28.2.8. Additional resources	509
28.3. TROUBLESHOOTING OVN-KUBERNETES	509
28.3.1. Monitoring OVN-Kubernetes health by using readiness probes	509
28.3.2. Viewing OVN-Kubernetes alerts in the console	510
28.3.3. Viewing OVN-Kubernetes alerts in the CLI	510
28.3.4. Viewing the OVN-Kubernetes logs using the CLI	511
28.3.5. Viewing the OVN-Kubernetes logs using the web console	512
28.3.5.1. Changing the OVN-Kubernetes log levels	512
28.3.6. Checking the OVN-Kubernetes pod network connectivity	516
28.3.7. Additional resources	517
28.4. OVN-KUBERNETES NETWORK POLICY	517
28.4.1. AdminNetworkPolicy	518
AdminNetworkPolicy example	518

28.4.1.1. AdminNetworkPolicy actions for rules	520
AdminNetworkPolicy Allow example	520
AdminNetworkPolicy Deny example	520
AdminNetworkPolicy Pass example	521
28.4.2. BaselineAdminNetworkPolicy	522
BaselineAdminNetworkPolicy example	522
BaselineAdminNetworkPolicy Deny example	523
28.5. TRACING OPENFLOW WITH OVNKUBE-TRACE	524
28.5.1. Installing the ovnkube-trace on local host	524
28.5.2. Running ovnkube-trace	526
28.5.3. Additional resources	531
28.6. MIGRATING FROM THE OPENSIFT SDN NETWORK PLUGIN	531
28.6.1. Migration to the OVN-Kubernetes network plugin	532
28.6.1.1. Considerations for migrating to the OVN-Kubernetes network plugin	532
Namespace isolation	533
Egress IP addresses	533
Egress network policies	533
Egress router pods	534
Multicast	534
Network policies	534
28.6.1.2. How the migration process works	534
28.6.2. Migrating to the OVN-Kubernetes network plugin	536
28.6.3. Additional resources	543
28.7. ROLLING BACK TO THE OPENSIFT SDN NETWORK PROVIDER	543
28.7.1. Migrating to the OpenShift SDN network plugin	543
28.8. CONVERTING TO IPV4/IPV6 DUAL-STACK NETWORKING	549
28.8.1. Converting to a dual-stack cluster network	549
28.8.2. Converting to a single-stack cluster network	550
28.9. LOGGING FOR EGRESS FIREWALL AND NETWORK POLICY RULES	551
28.9.1. Audit logging	551
28.9.2. Audit configuration	552
28.9.3. Configuring egress firewall and network policy auditing for a cluster	553
28.9.4. Enabling egress firewall and network policy audit logging for a namespace	557
28.9.5. Disabling egress firewall and network policy audit logging for a namespace	558
28.9.6. Additional resources	559
28.10. CONFIGURING IPSEC ENCRYPTION	559
28.10.1. Modes of operation	560
28.10.2. Prerequisites	560
28.10.3. Network connectivity requirements when IPsec is enabled	561
28.10.4. IPsec encryption for pod-to-pod traffic	561
28.10.4.1. Types of network traffic flows encrypted by pod-to-pod IPsec	561
28.10.4.2. Encryption protocol and IPsec mode	562
28.10.4.3. Security certificate generation and rotation	562
28.10.5. IPsec encryption for external traffic	562
28.10.5.1. Supported platforms	562
28.10.5.2. Limitations	563
28.10.6. Enabling IPsec encryption	563
28.10.7. Configuring IPsec encryption for external traffic	564
28.10.8. Disabling IPsec encryption for an external IPsec endpoint	569
28.10.9. Disabling IPsec encryption	570
28.10.10. Additional resources	570
28.11. CONFIGURE AN EXTERNAL GATEWAY ON THE DEFAULT NETWORK	571
28.11.1. Prerequisites	571

28.11.2. How OpenShift Container Platform determines the external gateway IP address	571
28.11.3. AdminPolicyBasedExternalRoute object configuration	572
28.11.3.1. Example secondary external gateway configurations	573
28.11.4. Configure a secondary external gateway	575
28.11.5. Additional resources	575
28.12. CONFIGURING AN EGRESS FIREWALL FOR A PROJECT	576
28.12.1. How an egress firewall works in a project	576
28.12.1.1. Limitations of an egress firewall	577
28.12.1.2. Matching order for egress firewall policy rules	578
28.12.1.3. How Domain Name Server (DNS) resolution works	578
28.12.2. EgressFirewall custom resource (CR) object	578
28.12.2.1. EgressFirewall rules	579
28.12.2.2. Example EgressFirewall CR objects	580
28.12.2.3. Example nodeSelector for EgressFirewall	580
28.12.3. Creating an egress firewall policy object	581
28.13. VIEWING AN EGRESS FIREWALL FOR A PROJECT	581
28.13.1. Viewing an EgressFirewall object	582
28.14. EDITING AN EGRESS FIREWALL FOR A PROJECT	582
28.14.1. Editing an EgressFirewall object	582
28.15. REMOVING AN EGRESS FIREWALL FROM A PROJECT	583
28.15.1. Removing an EgressFirewall object	583
28.16. CONFIGURING AN EGRESS IP ADDRESS	584
28.16.1. Egress IP address architectural design and implementation	584
28.16.1.1. Platform support	584
28.16.1.2. Public cloud platform considerations	585
28.16.1.2.1. Amazon Web Services (AWS) IP address capacity limits	586
28.16.1.2.2. Google Cloud Platform (GCP) IP address capacity limits	587
28.16.1.2.3. Microsoft Azure IP address capacity limits	587
28.16.1.3. Considerations for using an egress IP on additional network interfaces	587
Requirements for assigning an egress IP to a network interface that is not the primary network interface	588
28.16.1.4. Assignment of egress IPs to pods	588
28.16.1.5. Assignment of egress IPs to nodes	589
28.16.1.6. Architectural diagram of an egress IP address configuration	589
28.16.2. EgressIP object	590
28.16.3. EgressIPconfig object	592
28.16.4. Labeling a node to host egress IP addresses	593
28.16.5. Next steps	593
28.16.6. Additional resources	593
28.17. ASSIGNING AN EGRESS IP ADDRESS	594
28.17.1. Assigning an egress IP address to a namespace	594
28.17.2. Additional resources	595
28.18. CONFIGURING AN EGRESS SERVICE	595
28.18.1. Egress service custom resource	595
28.18.2. Deploying an egress service	596
28.19. CONSIDERATIONS FOR THE USE OF AN EGRESS ROUTER POD	599
28.19.1. About an egress router pod	599
28.19.1.1. Egress router modes	599
28.19.1.2. Egress router pod implementation	600
28.19.1.3. Deployment considerations	600
28.19.1.4. Failover configuration	601
28.19.2. Additional resources	601
28.20. DEPLOYING AN EGRESS ROUTER POD IN REDIRECT MODE	601

28.20.1. Egress router custom resource	601
28.20.2. Deploying an egress router in redirect mode	603
28.21. ENABLING MULTICAST FOR A PROJECT	606
28.21.1. About multicast	606
28.21.2. Enabling multicast between pods	607
28.22. DISABLING MULTICAST FOR A PROJECT	609
28.22.1. Disabling multicast between pods	609
28.23. TRACKING NETWORK FLOWS	609
28.23.1. Network object configuration for tracking network flows	610
28.23.2. Adding destinations for network flows collectors	611
28.23.3. Deleting all destinations for network flows collectors	612
28.23.4. Additional resources	613
28.24. CONFIGURING HYBRID NETWORKING	613
28.24.1. Configuring hybrid networking with OVN-Kubernetes	613
28.24.2. Additional resources	614
CHAPTER 29. OPENSIFT SDN NETWORK PLUGIN	615
29.1. ABOUT THE OPENSIFT SDN NETWORK PLUGIN	615
29.1.1. OpenShift SDN network isolation modes	615
29.1.2. Supported network plugin feature matrix	615
29.2. CONFIGURING EGRESS IPS FOR A PROJECT	616
29.2.1. Egress IP address architectural design and implementation	616
29.2.1.1. Platform support	617
29.2.1.2. Public cloud platform considerations	618
29.2.1.2.1. Amazon Web Services (AWS) IP address capacity limits	619
29.2.1.2.2. Google Cloud Platform (GCP) IP address capacity limits	619
29.2.1.2.3. Microsoft Azure IP address capacity limits	619
29.2.1.3. Considerations for using an egress IP on additional network interfaces	619
Requirements for assigning an egress IP to a network interface that is not the primary network interface	620
29.2.1.4. IP address assignment approaches	621
29.2.1.4.1. Considerations when using automatically assigned egress IP addresses	621
29.2.1.4.2. Considerations when using manually assigned egress IP addresses	622
29.2.2. Configuring automatically assigned egress IP addresses for a namespace	622
29.2.3. Configuring manually assigned egress IP addresses for a namespace	624
29.2.4. Additional resources	625
29.3. CONFIGURING AN EGRESS FIREWALL FOR A PROJECT	625
29.3.1. How an egress firewall works in a project	625
29.3.1.1. Limitations of an egress firewall	627
29.3.1.2. Matching order for egress firewall policy rules	628
29.3.1.3. How Domain Name Server (DNS) resolution works	628
29.3.2. EgressNetworkPolicy custom resource (CR) object	629
29.3.2.1. EgressNetworkPolicy rules	629
29.3.2.2. Example EgressNetworkPolicy CR objects	630
29.3.3. Creating an egress firewall policy object	630
29.4. EDITING AN EGRESS FIREWALL FOR A PROJECT	631
29.4.1. Viewing an EgressNetworkPolicy object	631
29.5. EDITING AN EGRESS FIREWALL FOR A PROJECT	631
29.5.1. Editing an EgressNetworkPolicy object	632
29.6. REMOVING AN EGRESS FIREWALL FROM A PROJECT	632
29.6.1. Removing an EgressNetworkPolicy object	633
29.7. CONSIDERATIONS FOR THE USE OF AN EGRESS ROUTER POD	633
29.7.1. About an egress router pod	633

29.7.1.1. Egress router modes	634
29.7.1.2. Egress router pod implementation	634
29.7.1.3. Deployment considerations	634
29.7.1.4. Failover configuration	635
29.7.2. Additional resources	636
29.8. DEPLOYING AN EGRESS ROUTER POD IN REDIRECT MODE	636
29.8.1. Egress router pod specification for redirect mode	636
29.8.2. Egress destination configuration format	637
29.8.3. Deploying an egress router pod in redirect mode	638
29.8.4. Additional resources	639
29.9. DEPLOYING AN EGRESS ROUTER POD IN HTTP PROXY MODE	639
29.9.1. Egress router pod specification for HTTP mode	639
29.9.2. Egress destination configuration format	640
29.9.3. Deploying an egress router pod in HTTP proxy mode	640
29.9.4. Additional resources	641
29.10. DEPLOYING AN EGRESS ROUTER POD IN DNS PROXY MODE	641
29.10.1. Egress router pod specification for DNS mode	641
29.10.2. Egress destination configuration format	643
29.10.3. Deploying an egress router pod in DNS proxy mode	643
29.10.4. Additional resources	644
29.11. CONFIGURING AN EGRESS ROUTER POD DESTINATION LIST FROM A CONFIG MAP	644
29.11.1. Configuring an egress router destination mappings with a config map	644
29.11.2. Additional resources	646
29.12. ENABLING MULTICAST FOR A PROJECT	646
29.12.1. About multicast	646
29.12.2. Enabling multicast between pods	647
29.13. DISABLING MULTICAST FOR A PROJECT	649
29.13.1. Disabling multicast between pods	649
29.14. CONFIGURING NETWORK ISOLATION USING OPENSIFT SDN	649
29.14.1. Prerequisites	650
29.14.2. Joining projects	650
29.14.3. Isolating a project	650
29.14.4. Disabling network isolation for a project	651
29.15. CONFIGURING KUBE-PROXY	651
29.15.1. About iptables rules synchronization	651
29.15.2. kube-proxy configuration parameters	652
29.15.3. Modifying the kube-proxy configuration	652
CHAPTER 30. CONFIGURING ROUTES	654
30.1. ROUTE CONFIGURATION	654
30.1.1. Creating an HTTP-based route	654
30.1.2. Creating a route for Ingress Controller sharding	655
30.1.3. Configuring route timeouts	657
30.1.4. HTTP Strict Transport Security	658
30.1.4.1. Enabling HTTP Strict Transport Security per-route	658
30.1.4.2. Disabling HTTP Strict Transport Security per-route	659
30.1.4.3. Enforcing HTTP Strict Transport Security per-domain	660
30.1.5. Throughput issue troubleshooting methods	663
30.1.6. Using cookies to keep route statefulness	664
30.1.6.1. Annotating a route with a cookie	664
30.1.7. Path-based routes	665
30.1.8. HTTP header configuration	666
30.1.8.1. Order of precedence	666

30.1.8.2. Special case headers	667
30.1.9. Setting or deleting HTTP request and response headers in a route	669
30.1.10. Route-specific annotations	670
30.1.11. Configuring the route admission policy	677
30.1.12. Creating a route through an Ingress object	678
30.1.13. Creating a route using the default certificate through an Ingress object	681
30.1.14. Creating a route using the destination CA certificate in the Ingress annotation	682
30.1.15. Configuring the OpenShift Container Platform Ingress Controller for dual-stack networking	683
30.2. SECURED ROUTES	684
30.2.1. Creating a re-encrypt route with a custom certificate	685
30.2.2. Creating an edge route with a custom certificate	686
30.2.3. Creating a passthrough route	687
CHAPTER 31. CONFIGURING INGRESS CLUSTER TRAFFIC	689
31.1. CONFIGURING INGRESS CLUSTER TRAFFIC OVERVIEW	689
31.1.1. Comparison: Fault tolerant access to external IP addresses	689
31.2. CONFIGURING EXTERNALIPS FOR SERVICES	690
31.2.1. Prerequisites	690
31.2.2. About ExternalIP	690
31.2.2.1. Configuration for ExternalIP	691
31.2.2.2. Restrictions on the assignment of an external IP address	692
31.2.2.3. Example policy objects	693
31.2.3. ExternalIP address block configuration	694
Example external IP configurations	694
31.2.4. Configure external IP address blocks for your cluster	695
31.2.5. Next steps	696
31.3. CONFIGURING INGRESS CLUSTER TRAFFIC USING AN INGRESS CONTROLLER	696
31.3.1. Using Ingress Controllers and routes	696
31.3.2. Prerequisites	697
31.3.3. Creating a project and service	697
31.3.4. Exposing the service by creating a route	698
31.3.5. Configuring Ingress Controller sharding by using route labels	698
31.3.6. Configuring Ingress Controller sharding by using namespace labels	700
31.3.7. Creating a route for Ingress Controller sharding	701
31.3.8. Additional resources	703
31.4. CONFIGURING INGRESS CLUSTER TRAFFIC USING A LOAD BALANCER	703
31.4.1. Using a load balancer to get traffic into the cluster	704
31.4.2. Prerequisites	704
31.4.3. Creating a project and service	704
31.4.4. Exposing the service by creating a route	705
31.4.5. Creating a load balancer service	706
31.5. CONFIGURING INGRESS CLUSTER TRAFFIC ON AWS	708
31.5.1. Configuring Classic Load Balancer timeouts on AWS	708
31.5.1.1. Configuring route timeouts	708
31.5.1.2. Configuring Classic Load Balancer timeouts	709
31.5.2. Configuring ingress cluster traffic on AWS using a Network Load Balancer	709
31.5.2.1. Switching the Ingress Controller from using a Classic Load Balancer to a Network Load Balancer	709
31.5.2.2. Switching the Ingress Controller from using a Network Load Balancer to a Classic Load Balancer	711
31.5.2.3. Replacing Ingress Controller Classic Load Balancer with Network Load Balancer	712
31.5.2.4. Configuring an Ingress Controller Network Load Balancer on an existing AWS cluster	713
31.5.2.5. Configuring an Ingress Controller Network Load Balancer on a new AWS cluster	714
31.5.3. Additional resources	715

31.6. CONFIGURING INGRESS CLUSTER TRAFFIC FOR A SERVICE EXTERNAL IP	715
31.6.1. Prerequisites	715
31.6.2. Attaching an ExternalIP to a service	716
31.6.3. Additional resources	717
31.7. CONFIGURING INGRESS CLUSTER TRAFFIC USING A NODEPORT	717
31.7.1. Using a NodePort to get traffic into the cluster	717
31.7.2. Prerequisites	717
31.7.3. Creating a project and service	717
31.7.4. Exposing the service by creating a route	718
31.7.5. Additional resources	719
31.8. CONFIGURING INGRESS CLUSTER TRAFFIC USING LOAD BALANCER ALLOWED SOURCE RANGES	719
31.8.1. Configuring load balancer allowed source ranges	720
31.8.2. Migrating to load balancer allowed source ranges	720
31.8.3. Additional resources	721
CHAPTER 32. KUBERNETES NMSTATE	722
32.1. ABOUT THE KUBERNETES NMSTATE OPERATOR	722
32.1.1. Installing the Kubernetes NMState Operator	722
32.1.1.1. Installing the Kubernetes NMState Operator by using the web console	722
32.1.1.2. Installing the Kubernetes NMState Operator using the CLI	723
32.2. OBSERVING AND UPDATING THE NODE NETWORK STATE AND CONFIGURATION	725
32.2.1. Viewing the network state of a node by using the CLI	725
32.2.2. Viewing the network state of a node from the web console	726
32.2.3. Managing policy from the web console	726
32.2.3.1. Monitoring the policy status	726
32.2.3.2. Creating a policy	727
32.2.3.3. Updating the policy	728
32.2.3.3.1. Updating the policy by using form	728
32.2.3.3.2. Updating the policy by using YAML	729
32.2.3.4. Deleting the policy	729
32.2.4. Managing policy by using the CLI	729
32.2.4.1. Creating an interface on nodes	729
Additional resources	730
32.2.4.2. Confirming node network policy updates on nodes	730
32.2.4.3. Removing an interface from nodes	731
32.2.5. Example policy configurations for different interfaces	732
32.2.5.1. Example: Linux bridge interface node network configuration policy	733
32.2.5.2. Example: VLAN interface node network configuration policy	734
32.2.5.3. Example: Node network configuration policy for virtual functions (Technology Preview)	735
32.2.5.4. Example: Bond interface node network configuration policy	738
32.2.5.5. Example: Ethernet interface node network configuration policy	739
32.2.5.6. Example: Multiple interfaces in the same node network configuration policy	740
32.2.5.7. Example: Network interface with a VRF instance node network configuration policy	741
32.2.6. Capturing the static IP of a NIC attached to a bridge	742
32.2.6.1. Example: Linux bridge interface node network configuration policy to inherit static IP address from the NIC attached to the bridge	743
32.2.7. Examples: IP management	744
32.2.7.1. Static	744
32.2.7.2. No IP address	744
32.2.7.3. Dynamic host configuration	745
32.2.7.4. DNS	745
32.2.7.5. Static routing	747

32.3. TROUBLESHOOTING NODE NETWORK CONFIGURATION	748
32.3.1. Troubleshooting an incorrect node network configuration policy configuration	748
CHAPTER 33. CONFIGURING THE CLUSTER-WIDE PROXY	753
33.1. PREREQUISITES	753
33.2. ENABLING THE CLUSTER-WIDE PROXY	753
33.3. REMOVING THE CLUSTER-WIDE PROXY	755
Additional resources	756
CHAPTER 34. CONFIGURING A CUSTOM PKI	757
34.1. CONFIGURING THE CLUSTER-WIDE PROXY DURING INSTALLATION	757
34.2. ENABLING THE CLUSTER-WIDE PROXY	759
34.3. CERTIFICATE INJECTION USING OPERATORS	761
CHAPTER 35. LOAD BALANCING ON RHOSP	763
35.1. LIMITATIONS OF LOAD BALANCER SERVICES	763
35.1.1. Local external traffic policies	763
35.2. SCALING CLUSTERS FOR APPLICATION TRAFFIC BY USING OCTAVIA	763
35.2.1. Scaling clusters by using Octavia	763
35.3. SERVICES FOR AN EXTERNAL LOAD BALANCER	764
35.3.1. Configuring an external load balancer	767
CHAPTER 36. LOAD BALANCING WITH METALLB	774
36.1. ABOUT METALLB AND THE METALLB OPERATOR	774
36.1.1. When to use MetalLB	774
36.1.2. MetalLB Operator custom resources	774
36.1.3. MetalLB software components	775
36.1.4. MetalLB and external traffic policy	776
36.1.5. MetalLB concepts for layer 2 mode	777
36.1.6. MetalLB concepts for BGP mode	779
36.1.7. Limitations and restrictions	780
36.1.7.1. Infrastructure considerations for MetalLB	780
36.1.7.2. Limitations for layer 2 mode	781
36.1.7.2.1. Single-node bottleneck	781
36.1.7.2.2. Slow failover performance	781
36.1.7.2.3. Additional Network and MetalLB cannot use same network	781
36.1.7.3. Limitations for BGP mode	782
36.1.7.3.1. Node failure can break all active connections	782
36.1.7.3.2. Support for a single ASN and a single router ID only	782
36.1.8. Additional resources	782
36.2. INSTALLING THE METALLB OPERATOR	782
36.2.1. Installing the MetalLB Operator from the OperatorHub using the web console	782
36.2.2. Installing from OperatorHub using the CLI	783
36.2.3. Starting MetalLB on your cluster	785
36.2.4. Deployment specifications for MetalLB	786
36.2.4.1. Limit speaker pods to specific nodes	786
36.2.4.2. Configuring a container runtime class in a MetalLB deployment	787
36.2.4.3. Configuring pod priority and pod affinity in a MetalLB deployment	788
36.2.4.4. Configuring pod CPU limits in a MetalLB deployment	790
36.2.5. Additional resources	791
36.2.6. Next steps	791
36.3. UPGRADING THE METALLB	791
36.3.1. Deleting the MetalLB Operator from a cluster using the web console	792
36.3.2. Deleting MetalLB Operator from a cluster using the CLI	792

36.3.3. Editing the MetalLB Operator Operator group	793
36.3.4. Upgrading the MetalLB Operator	795
36.3.5. Additional resources	796
36.4. CONFIGURING METALLB ADDRESS POOLS	796
36.4.1. About the IPAddressPool custom resource	796
36.4.2. Configuring an address pool	797
36.4.3. Example address pool configurations	799
36.4.3.1. Example: IPv4 and CIDR ranges	799
36.4.3.2. Example: Reserve IP addresses	799
36.4.3.3. Example: IPv4 and IPv6 addresses	799
36.4.3.4. Example: Assign IP address pools to services or namespaces	800
36.4.4. Additional resources	800
36.4.5. Next steps	800
36.5. ABOUT ADVERTISING FOR THE IP ADDRESS POOLS	801
36.5.1. About the BGPAdvertisement custom resource	801
36.5.2. Configuring MetalLB with a BGP advertisement and a basic use case	802
36.5.2.1. Example: Advertise a basic address pool configuration with BGP	802
36.5.3. Configuring MetalLB with a BGP advertisement and an advanced use case	803
36.5.3.1. Example: Advertise an advanced address pool configuration with BGP	804
36.5.4. Advertising an IP address pool from a subset of nodes	805
36.5.5. About the L2Advertisement custom resource	806
36.5.6. Configuring MetalLB with an L2 advertisement	807
36.5.7. Configuring MetalLB with a L2 advertisement and label	808
36.5.8. Configuring MetalLB with an L2 advertisement for selected interfaces	809
36.5.9. Additional resources	810
36.6. CONFIGURING METALLB BGP PEERS	810
36.6.1. About the BGP peer custom resource	810
36.6.2. Configuring a BGP peer	812
36.6.3. Configure a specific set of BGP peers for a given address pool	812
36.6.4. Exposing a service through a network VRF	815
36.6.5. Example BGP peer configurations	819
36.6.5.1. Example: Limit which nodes connect to a BGP peer	819
36.6.5.2. Example: Specify a BFD profile for a BGP peer	820
36.6.5.3. Example: Specify BGP peers for dual-stack networking	820
36.6.6. Next steps	820
36.7. CONFIGURING COMMUNITY ALIAS	821
36.7.1. About the community custom resource	821
36.7.2. Configuring MetalLB with a BGP advertisement and community alias	821
36.8. CONFIGURING METALLB BFD PROFILES	823
36.8.1. About the BFD profile custom resource	823
36.8.2. Configuring a BFD profile	825
36.8.3. Next steps	825
36.9. CONFIGURING SERVICES TO USE METALLB	825
36.9.1. Request a specific IP address	825
36.9.2. Request an IP address from a specific pool	826
36.9.3. Accept any IP address	827
36.9.4. Share a specific IP address	827
36.9.5. Configuring a service with MetalLB	828
36.10. MANAGING SYMMETRIC ROUTING WITH METALLB	830
36.10.1. Challenges of managing symmetric routing with MetalLB	830
36.10.2. Overview of managing symmetric routing by using VRFs with MetalLB	830
36.10.3. Configuring symmetric routing by using VRFs with MetalLB	831
36.11. METALLB LOGGING, TROUBLESHOOTING, AND SUPPORT	836

36.11.1. Setting the MetalLB logging levels	836
36.11.1.1. FRRouting (FRR) log levels	839
36.11.2. Troubleshooting BGP issues	840
36.11.3. Troubleshooting BFD issues	843
36.11.4. MetalLB metrics for BGP and BFD	844
36.11.5. About collecting MetalLB data	845
CHAPTER 37. ASSOCIATING SECONDARY INTERFACES METRICS TO NETWORK ATTACHMENTS ...	847
37.1. EXTENDING SECONDARY NETWORK METRICS FOR MONITORING	847
37.1.1. Network Metrics Daemon	847
37.1.2. Metrics with network name	848

CHAPTER 1. ABOUT NETWORKING

Red Hat OpenShift Networking is an ecosystem of features, plugins and advanced networking capabilities that extend Kubernetes networking with the advanced networking-related features that your cluster needs to manage its network traffic for one or multiple hybrid clusters. This ecosystem of networking capabilities integrates ingress, egress, load balancing, high-performance throughput, security, inter- and intra-cluster traffic management and provides role-based observability tooling to reduce its natural complexities.



NOTE

OpenShift SDN CNI is deprecated as of OpenShift Container Platform 4.14. As of OpenShift Container Platform 4.15, the network plugin is not an option for new installations. In a subsequent future release, the OpenShift SDN network plugin is planned to be removed and no longer supported. Red Hat will provide bug fixes and support for this feature until it is removed, but this feature will no longer receive enhancements. As an alternative to OpenShift SDN CNI, you can use OVN Kubernetes CNI instead.

The following list highlights some of the most commonly used Red Hat OpenShift Networking features available on your cluster:

- Primary cluster network provided by either of the following Container Network Interface (CNI) plugins:
 - [OVN-Kubernetes network plugin](#), the default plugin
 - [OpenShift SDN network plugin](#)
- Certified 3rd-party alternative primary network plugins
- Cluster Network Operator for network plugin management
- Ingress Operator for TLS encrypted web traffic
- DNS Operator for name assignment
- MetalLB Operator for traffic load balancing on bare metal clusters
- IP failover support for high-availability
- Additional hardware network support through multiple CNI plugins, including for macvlan, ipvlan, and SR-IOV hardware networks
- IPv4, IPv6, and dual stack addressing
- Hybrid Linux-Windows host clusters for Windows-based workloads
- Red Hat OpenShift Service Mesh for discovery, load balancing, service-to-service authentication, failure recovery, metrics, and monitoring of services
- Single-node OpenShift
- Network Observability Operator for network debugging and insights
- [Submariner](#) and [Red Hat Application Interconnect](#) technologies for inter-cluster networking

CHAPTER 2. UNDERSTANDING NETWORKING

Cluster Administrators have several options for exposing applications that run inside a cluster to external traffic and securing network connections:

- Service types, such as node ports or load balancers
- API resources, such as **Ingress** and **Route**

By default, Kubernetes allocates each pod an internal IP address for applications running within the pod. Pods and their containers can network, but clients outside the cluster do not have networking access. When you expose your application to external traffic, giving each pod its own IP address means that pods can be treated like physical hosts or virtual machines in terms of port allocation, networking, naming, service discovery, load balancing, application configuration, and migration.



NOTE

Some cloud platforms offer metadata APIs that listen on the 169.254.169.254 IP address, a link-local IP address in the IPv4 **169.254.0.0/16** CIDR block.

This CIDR block is not reachable from the pod network. Pods that need access to these IP addresses must be given host network access by setting the **spec.hostNetwork** field in the pod spec to **true**.

If you allow a pod host network access, you grant the pod privileged access to the underlying network infrastructure.

2.1. OPENSIFT CONTAINER PLATFORM DNS

If you are running multiple services, such as front-end and back-end services for use with multiple pods, environment variables are created for user names, service IPs, and more so the front-end pods can communicate with the back-end services. If the service is deleted and recreated, a new IP address can be assigned to the service, and requires the front-end pods to be recreated to pick up the updated values for the service IP environment variable. Additionally, the back-end service must be created before any of the front-end pods to ensure that the service IP is generated properly, and that it can be provided to the front-end pods as an environment variable.

For this reason, OpenShift Container Platform has a built-in DNS so that the services can be reached by the service DNS as well as the service IP/port.

2.2. OPENSIFT CONTAINER PLATFORM INGRESS OPERATOR

When you create your OpenShift Container Platform cluster, pods and services running on the cluster are each allocated their own IP addresses. The IP addresses are accessible to other pods and services running nearby but are not accessible to outside clients. The Ingress Operator implements the **IngressController** API and is the component responsible for enabling external access to OpenShift Container Platform cluster services.

The Ingress Operator makes it possible for external clients to access your service by deploying and managing one or more HAProxy-based [Ingress Controllers](#) to handle routing. You can use the Ingress Operator to route traffic by specifying OpenShift Container Platform **Route** and Kubernetes **Ingress** resources. Configurations within the Ingress Controller, such as the ability to define **endpointPublishingStrategy** type and internal load balancing, provide ways to publish Ingress Controller endpoints.

2.2.1. Comparing routes and Ingress

The Kubernetes Ingress resource in OpenShift Container Platform implements the Ingress Controller with a shared router service that runs as a pod inside the cluster. The most common way to manage Ingress traffic is with the Ingress Controller. You can scale and replicate this pod like any other regular pod. This router service is based on [HAProxy](#), which is an open source load balancer solution.

The OpenShift Container Platform route provides Ingress traffic to services in the cluster. Routes provide advanced features that might not be supported by standard Kubernetes Ingress Controllers, such as TLS re-encryption, TLS passthrough, and split traffic for blue-green deployments.

Ingress traffic accesses services in the cluster through a route. Routes and Ingress are the main resources for handling Ingress traffic. Ingress provides features similar to a route, such as accepting external requests and delegating them based on the route. However, with Ingress you can only allow certain types of connections: HTTP/2, HTTPS and server name identification (SNI), and TLS with certificate. In OpenShift Container Platform, routes are generated to meet the conditions specified by the Ingress resource.

2.3. GLOSSARY OF COMMON TERMS FOR OPENSIFT CONTAINER PLATFORM NETWORKING

This glossary defines common terms that are used in the networking content.

authentication

To control access to an OpenShift Container Platform cluster, a cluster administrator can configure user authentication and ensure only approved users access the cluster. To interact with an OpenShift Container Platform cluster, you must authenticate to the OpenShift Container Platform API. You can authenticate by providing an OAuth access token or an X.509 client certificate in your requests to the OpenShift Container Platform API.

AWS Load Balancer Operator

The AWS Load Balancer (ALB) Operator deploys and manages an instance of the **aws-load-balancer-controller**.

Cluster Network Operator

The Cluster Network Operator (CNO) deploys and manages the cluster network components in an OpenShift Container Platform cluster. This includes deployment of the Container Network Interface (CNI) network plugin selected for the cluster during installation.

config map

A config map provides a way to inject configuration data into pods. You can reference the data stored in a config map in a volume of type **ConfigMap**. Applications running in a pod can use this data.

custom resource (CR)

A CR is extension of the Kubernetes API. You can create custom resources.

DNS

Cluster DNS is a DNS server which serves DNS records for Kubernetes services. Containers started by Kubernetes automatically include this DNS server in their DNS searches.

DNS Operator

The DNS Operator deploys and manages CoreDNS to provide a name resolution service to pods. This enables DNS-based Kubernetes Service discovery in OpenShift Container Platform.

deployment

A Kubernetes resource object that maintains the life cycle of an application.

domain

Domain is a DNS name serviced by the Ingress Controller.

egress

The process of data sharing externally through a network's outbound traffic from a pod.

External DNS Operator

The External DNS Operator deploys and manages ExternalDNS to provide the name resolution for services and routes from the external DNS provider to OpenShift Container Platform.

HTTP-based route

An HTTP-based route is an unsecured route that uses the basic HTTP routing protocol and exposes a service on an unsecured application port.

Ingress

The Kubernetes Ingress resource in OpenShift Container Platform implements the Ingress Controller with a shared router service that runs as a pod inside the cluster.

Ingress Controller

The Ingress Operator manages Ingress Controllers. Using an Ingress Controller is the most common way to allow external access to an OpenShift Container Platform cluster.

installer-provisioned infrastructure

The installation program deploys and configures the infrastructure that the cluster runs on.

kubelet

A primary node agent that runs on each node in the cluster to ensure that containers are running in a pod.

Kubernetes NMState Operator

The Kubernetes NMState Operator provides a Kubernetes API for performing state-driven network configuration across the OpenShift Container Platform cluster's nodes with NMState.

kube-proxy

Kube-proxy is a proxy service which runs on each node and helps in making services available to the external host. It helps in forwarding the request to correct containers and is capable of performing primitive load balancing.

load balancers

OpenShift Container Platform uses load balancers for communicating from outside the cluster with services running in the cluster.

MetalLB Operator

As a cluster administrator, you can add the MetalLB Operator to your cluster so that when a service of type **LoadBalancer** is added to the cluster, MetalLB can add an external IP address for the service.

multicast

With IP multicast, data is broadcast to many IP addresses simultaneously.

namespaces

A namespace isolates specific system resources that are visible to all processes. Inside a namespace, only processes that are members of that namespace can see those resources.

networking

Network information of a OpenShift Container Platform cluster.

node

A worker machine in the OpenShift Container Platform cluster. A node is either a virtual machine (VM) or a physical machine.

OpenShift Container Platform Ingress Operator

The Ingress Operator implements the **IngressController** API and is the component responsible for enabling external access to OpenShift Container Platform services.

pod

One or more containers with shared resources, such as volume and IP addresses, running in your OpenShift Container Platform cluster. A pod is the smallest compute unit defined, deployed, and managed.

PTP Operator

The PTP Operator creates and manages the **linuxptp** services.

route

The OpenShift Container Platform route provides Ingress traffic to services in the cluster. Routes provide advanced features that might not be supported by standard Kubernetes Ingress Controllers, such as TLS re-encryption, TLS passthrough, and split traffic for blue-green deployments.

scaling

Increasing or decreasing the resource capacity.

service

Exposes a running application on a set of pods.

Single Root I/O Virtualization (SR-IOV) Network Operator

The Single Root I/O Virtualization (SR-IOV) Network Operator manages the SR-IOV network devices and network attachments in your cluster.

software-defined networking (SDN)

OpenShift Container Platform uses a software-defined networking (SDN) approach to provide a unified cluster network that enables communication between pods across the OpenShift Container Platform cluster.



NOTE

OpenShift SDN CNI is deprecated as of OpenShift Container Platform 4.14. As of OpenShift Container Platform 4.15, the network plugin is not an option for new installations. In a subsequent future release, the OpenShift SDN network plugin is planned to be removed and no longer supported. Red Hat will provide bug fixes and support for this feature until it is removed, but this feature will no longer receive enhancements. As an alternative to OpenShift SDN CNI, you can use OVN Kubernetes CNI instead.

Stream Control Transmission Protocol (SCTP)

SCTP is a reliable message based protocol that runs on top of an IP network.

taint

Taints and tolerations ensure that pods are scheduled onto appropriate nodes. You can apply one or more taints on a node.

toleration

You can apply tolerations to pods. Tolerations allow the scheduler to schedule pods with matching taints.

web console

A user interface (UI) to manage OpenShift Container Platform.

CHAPTER 3. ZERO TRUST NETWORKING

Zero trust is an approach to designing security architectures based on the premise that every interaction begins in an untrusted state. This contrasts with traditional architectures, which might determine trustworthiness based on whether communication starts inside a firewall. More specifically, zero trust attempts to close gaps in security architectures that rely on implicit trust models and one-time authentication.

OpenShift Container Platform can add some zero trust networking capabilities to containers running on the platform without requiring changes to the containers or the software running in them. There are also several products that Red Hat offers that can further augment the zero trust networking capabilities of containers. If you have the ability to change the software running in the containers, then there are other projects that Red Hat supports that can add further capabilities.

Explore the following targeted capabilities of zero trust networking.

3.1. ROOT OF TRUST

Public certificates and private keys are critical to zero trust networking. These are used to identify components to one another, authenticate, and to secure traffic. The certificates are signed by other certificates, and there is a chain of trust to a root certificate authority (CA). Everything participating in the network needs to ultimately have the public key for a root CA so that it can validate the chain of trust. For public-facing things, these are usually the set of root CAs that are globally known, and whose keys are distributed with operating systems, web browsers, and so on. However, it is possible to run a private CA for a cluster or a corporation if the certificate of the private CA is distributed to all parties.

Leverage:

- OpenShift Container Platform: OpenShift creates a [cluster CA at installation](#) that is used to secure the cluster resources. However, OpenShift Container Platform can also create and sign [certificates for services](#) in the cluster, and can inject the cluster CA bundle into a pod if requested. [Service certificates](#) created and signed by OpenShift Container Platform have a 26-month time to live (TTL) and are rotated automatically at 13 months. They can also be rotated manually if necessary.
- [OpenShift cert-manager Operator](#): cert-manager allows you to request keys that are signed by an external root of trust. There are many configurable issuers to integrate with external issuers, along with ways to run with a delegated signing certificate. The cert-manager API can be used by other software in zero trust networking to request the necessary certificates (for example, Red Hat OpenShift Service Mesh), or can be used directly by customer software.

3.2. TRAFFIC AUTHENTICATION AND ENCRYPTION

Ensure that all traffic on the wire is encrypted and the endpoints are identifiable. An example of this is Mutual TLS, or mTLS, which is a method for mutual authentication.

Leverage:

- OpenShift Container Platform: With transparent [pod-to-pod IPsec](#), the source and destination of the traffic can be identified by the IP address. There is the capability for egress traffic to be [encrypted using IPsec](#). By using the [egress IP](#) feature, the source IP address of the traffic can be used to identify the source of the traffic inside the cluster.
- [Red Hat OpenShift Service Mesh](#): Provides powerful [mTLS capabilities](#) that can transparently augment traffic leaving a pod to provide authentication and encryption.

- [OpenShift cert-manager Operator](#): Use custom resource definitions (CRDs) to request certificates that can be mounted for your programs to use for SSL/TLS protocols.

3.3. IDENTIFICATION AND AUTHENTICATION

After you have the ability to mint certificates using a CA, you can use it to establish trust relationships by verification of the identity of the other end of a connection – either a user or a client machine. This also requires management of certificate lifecycles to limit use if compromised.

Leverage:

- OpenShift Container Platform: Cluster-signed [service certificates](#) to ensure that a client is talking to a trusted endpoint. This requires that the service uses SSL/TLS and that the client uses the [cluster CA](#). The client identity must be provided using some other means.
- [Red Hat Single Sign-On](#): Provides request authentication integration with enterprise user directories or third-party identity providers.
- [Red Hat OpenShift Service Mesh](#): [Transparent upgrade](#) of connections to mTLS, auto-rotation, custom certificate expiration, and request authentication with JSON web token (JWT).
- [OpenShift cert-manager Operator](#): Creation and management of certificates for use by your application. Certificates can be controlled by CRDs and mounted as secrets, or your application can be changed to interact directly with the cert-manager API.

3.4. INTER-SERVICE AUTHORIZATION

It is critical to be able to control access to services based on the identity of the requester. This is done by the platform and does not require each application to implement it. That allows better auditing and inspection of the policies.

Leverage:

- OpenShift Container Platform: Can enforce isolation in the networking layer of the platform using the Kubernetes [NetworkPolicy](#) and [AdminNetworkPolicy](#) objects.
- [Red Hat OpenShift Service Mesh](#): Sophisticated L4 and L7 [control of traffic](#) using standard Istio objects and using mTLS to identify the source and destination of traffic and then apply policies based on that information.

3.5. TRANSACTION-LEVEL VERIFICATION

In addition to the ability to identify and authenticate connections, it is also useful to control access to individual transactions. This can include rate-limiting by source, observability, and semantic validation that a transaction is well formed.

Leverage:

- [Red Hat OpenShift Service Mesh](#): Perform L7 inspection of requests, rejecting malformed HTTP requests, transaction-level [observability and reporting](#). Service Mesh can also provide [request-based authentication](#) using JWT.

3.6. RISK ASSESSMENT

As the number of security policies in a cluster increase, visualization of what the policies allow and deny becomes increasingly important. These tools make it easier to create, visualize, and manage cluster security policies.

Leverage:

- [Red Hat OpenShift Service Mesh](#): Create and visualize Kubernetes **NetworkPolicy** and **AdminNetworkPolicy**, and OpenShift Networking **EgressFirewall** objects using the [OpenShift web console](#).
- [Red Hat Advanced Cluster Security for Kubernetes](#): Advanced [visualization of objects](#).

3.7. SITE-WIDE POLICY ENFORCEMENT AND DISTRIBUTION

After deploying applications on a cluster, it becomes challenging to manage all of the objects that make up the security rules. It becomes critical to be able to apply site-wide policies and audit the deployed objects for compliance with the policies. This should allow for delegation of some permissions to users and cluster administrators within defined bounds, and should allow for exceptions to the policies if necessary.

Leverage:

- [Red Hat OpenShift Service Mesh](#): RBAC to [control policy objects](#) and delegate control.
- [Red Hat Advanced Cluster Security for Kubernetes](#): [Policy enforcement](#) engine.
- [Red Hat Advanced Cluster Management \(RHACM\) for Kubernetes](#): Centralized policy control.

3.8. OBSERVABILITY FOR CONSTANT, AND RETROSPECTIVE, EVALUATION

After you have a running cluster, you want to be able to observe the traffic and verify that the traffic comports with the defined rules. This is important for intrusion detection, forensics, and is helpful for operational load management.

Leverage:

- [Network Observability Operator](#): Allows for inspection, monitoring, and alerting on network connections to pods and nodes in the cluster.
- [Red Hat Advanced Cluster Management \(RHACM\) for Kubernetes](#): Monitors, collects, and evaluates system-level events such as process execution, network connections and flows, and privilege escalation. It can determine a baseline for a cluster, and then detect anomalous activity and alert you about it.
- [Red Hat OpenShift Service Mesh](#): Can [monitor traffic](#) entering and leaving a pod.
- [Red Hat OpenShift distributed tracing platform](#): For suitably instrumented applications, you can see all traffic associated with a particular action as it splits into sub-requests to microservices. This allows you to identify bottlenecks within a distributed application.

3.9. ENDPOINT SECURITY

It is important to be able to trust that the software running the services in your cluster has not been compromised. For example, you might need to ensure that certified images are run on trusted hardware, and have policies to only allow connections to or from an endpoint based on endpoint characteristics.

Leverage:

- [OpenShift Container Platform: Secureboot](#) can ensure that the nodes in the cluster are running trusted software, so the platform itself (including the container runtime) have not been tampered with. You can configure OpenShift Container Platform to only run images that have been [signed by certain signatures](#).
- [Red Hat Trusted Artifact Signer](#): This can be used in a trusted build chain and produce signed container images.

3.10. EXTENDING TRUST OUTSIDE OF THE CLUSTER

You might want to extend trust outside of the cluster by allowing a cluster to mint CAs for a subdomain. Alternatively, you might want to attest to workload identity in the cluster to a remote endpoint.

Leverage:

- [OpenShift cert-manager Operator](#): You can use cert-manager to manage delegated CAs so that you can distribute trust across different clusters, or through your organization.
- [Red Hat OpenShift Service Mesh](#): Can use SPIFFE to provide remote attestation of workloads to endpoints running in remote or local clusters.

CHAPTER 4. ACCESSING HOSTS

Learn how to create a bastion host to access OpenShift Container Platform instances and access the control plane nodes with secure shell (SSH) access.

4.1. ACCESSING HOSTS ON AMAZON WEB SERVICES IN AN INSTALLER-PROVISIONED INFRASTRUCTURE CLUSTER

The OpenShift Container Platform installer does not create any public IP addresses for any of the Amazon Elastic Compute Cloud (Amazon EC2) instances that it provisions for your OpenShift Container Platform cluster. To be able to SSH to your OpenShift Container Platform hosts, you must follow this procedure.

Procedure

1. Create a security group that allows SSH access into the virtual private cloud (VPC) created by the **openshift-install** command.
2. Create an Amazon EC2 instance on one of the public subnets the installer created.
3. Associate a public IP address with the Amazon EC2 instance that you created.
Unlike with the OpenShift Container Platform installation, you should associate the Amazon EC2 instance you created with an SSH keypair. It does not matter what operating system you choose for this instance, as it will simply serve as an SSH bastion to bridge the internet into your OpenShift Container Platform cluster's VPC. The Amazon Machine Image (AMI) you use does matter. With Red Hat Enterprise Linux CoreOS (RHCOS), for example, you can provide keys via Ignition, like the installer does.
4. After you provisioned your Amazon EC2 instance and can SSH into it, you must add the SSH key that you associated with your OpenShift Container Platform installation. This key can be different from the key for the bastion instance, but does not have to be.



NOTE

Direct SSH access is only recommended for disaster recovery. When the Kubernetes API is responsive, run privileged pods instead.

5. Run **oc get nodes**, inspect the output, and choose one of the nodes that is a master. The hostname looks similar to **ip-10-0-1-163.ec2.internal**.
6. From the bastion SSH host you manually deployed into Amazon EC2, SSH into that control plane host. Ensure that you use the same SSH key you specified during the installation:

```
$ ssh -i <ssh-key-path> core@<master-hostname>
```

CHAPTER 5. NETWORKING OPERATORS OVERVIEW

OpenShift Container Platform supports multiple types of networking Operators. You can manage the cluster networking using these networking Operators.

5.1. CLUSTER NETWORK OPERATOR

The Cluster Network Operator (CNO) deploys and manages the cluster network components in an OpenShift Container Platform cluster. This includes deployment of the Container Network Interface (CNI) network plugin selected for the cluster during installation. For more information, see [Cluster Network Operator in OpenShift Container Platform](#).

5.2. DNS OPERATOR

The DNS Operator deploys and manages CoreDNS to provide a name resolution service to pods. This enables DNS-based Kubernetes Service discovery in OpenShift Container Platform. For more information, see [DNS Operator in OpenShift Container Platform](#).

5.3. INGRESS OPERATOR

When you create your OpenShift Container Platform cluster, pods and services running on the cluster are each allocated IP addresses. The IP addresses are accessible to other pods and services running nearby but are not accessible to external clients. The Ingress Operator implements the Ingress Controller API and is responsible for enabling external access to OpenShift Container Platform cluster services. For more information, see [Ingress Operator in OpenShift Container Platform](#).

5.4. EXTERNAL DNS OPERATOR

The External DNS Operator deploys and manages ExternalDNS to provide the name resolution for services and routes from the external DNS provider to OpenShift Container Platform. For more information, see [Understanding the External DNS Operator](#).

5.5. INGRESS NODE FIREWALL OPERATOR

The Ingress Node Firewall Operator uses an extended Berkley Packet Filter (eBPF) and eXpress Data Path (XDP) plugin to process node firewall rules, update statistics and generate events for dropped traffic. The operator manages ingress node firewall resources, verifies firewall configuration, does not allow incorrectly configured rules that can prevent cluster access, and loads ingress node firewall XDP programs to the selected interfaces in the rule's object(s). For more information, see [Understanding the Ingress Node Firewall Operator](#)

5.6. NETWORK OBSERVABILITY OPERATOR

The Network Observability Operator is an optional Operator that allows cluster administrators to observe the network traffic for OpenShift Container Platform clusters. The Network Observability Operator uses the eBPF technology to create network flows. The network flows are then enriched with OpenShift Container Platform information and stored in Loki. You can view and analyze the stored network flows information in the OpenShift Container Platform console for further insight and troubleshooting. For more information, see [About Network Observability Operator](#).

CHAPTER 6. NETWORKING DASHBOARDS

Networking metrics are viewable in dashboards within the OpenShift Container Platform web console, under **Observe** → **Dashboards**.

6.1. NETWORK OBSERVABILITY OPERATOR

If you have the Network Observability Operator installed, you can view network traffic metrics dashboards by selecting the **Netobserv** dashboard from the **Dashboards** drop-down list. For more information about metrics available in this **Dashboard**, see [Network Observability metrics dashboards](#).

6.2. NETWORKING AND OVN-KUBERNETES DASHBOARD

You can view both general networking metrics as well as OVN-Kubernetes metrics from the dashboard.

To view general networking metrics, select **Networking/Linux Subsystem Stats** from the **Dashboards** drop-down list. You can view the following networking metrics from the dashboard: **Network Utilisation**, **Network Saturation**, and **Network Errors**.

To view OVN-Kubernetes metrics select **Networking/Infrastructure** from the **Dashboards** drop-down list. You can view the following OVN-Kubernetes metrics: **Networking Configuration**, **TCP Latency Probes**, **Control Plane Resources**, and **Worker Resources**.

6.3. INGRESS OPERATOR DASHBOARD

You can view networking metrics handled by the Ingress Operator from the dashboard. This includes metrics like the following:

- Incoming and outgoing bandwidth
- HTTP error rates
- HTTP server response latency

To view these Ingress metrics, select **Networking/Ingress** from the **Dashboards** drop-down list. You can view Ingress metrics for the following categories: **Top 10 Per Route**, **Top 10 Per Namespace**, and **Top 10 Per Shard**

CHAPTER 7. CLUSTER NETWORK OPERATOR IN OPENSIFT CONTAINER PLATFORM

The Cluster Network Operator (CNO) deploys and manages the cluster network components on an OpenShift Container Platform cluster, including the Container Network Interface (CNI) network plugin selected for the cluster during installation.

7.1. CLUSTER NETWORK OPERATOR

The Cluster Network Operator implements the **network** API from the **operator.openshift.io** API group. The Operator deploys the OVN-Kubernetes network plugin, or the network provider plugin that you selected during cluster installation, by using a daemon set.

Procedure

The Cluster Network Operator is deployed during installation as a Kubernetes **Deployment**.

1. Run the following command to view the Deployment status:

```
$ oc get -n openshift-network-operator deployment/network-operator
```

Example output

```
NAME          READY  UP-TO-DATE  AVAILABLE  AGE
network-operator  1/1    1           1          56m
```

2. Run the following command to view the state of the Cluster Network Operator:

```
$ oc get clusteroperator/network
```

Example output

```
NAME    VERSION  AVAILABLE  PROGRESSING  DEGRADED  SINCE
network 4.5.4    True       False        False     50m
```

The following fields provide information about the status of the operator: **AVAILABLE**, **PROGRESSING**, and **DEGRADED**. The **AVAILABLE** field is **True** when the Cluster Network Operator reports an available status condition.

7.2. VIEWING THE CLUSTER NETWORK CONFIGURATION

Every new OpenShift Container Platform installation has a **network.config** object named **cluster**.

Procedure

- Use the **oc describe** command to view the cluster network configuration:

```
$ oc describe network.config/cluster
```

Example output

```

Name:      cluster
Namespace:
Labels:    <none>
Annotations: <none>
API Version: config.openshift.io/v1
Kind:      Network
Metadata:
  Self Link:      /apis/config.openshift.io/v1/networks/cluster
Spec: ❶
  Cluster Network:
    Cidr:      10.128.0.0/14
    Host Prefix: 23
    Network Type: OpenShiftSDN
  Service Network:
    172.30.0.0/16
Status: ❷
  Cluster Network:
    Cidr:      10.128.0.0/14
    Host Prefix: 23
  Cluster Network MTU: 8951
  Network Type:      OpenShiftSDN
  Service Network:
    172.30.0.0/16
Events: <none>

```

- ❶ The **Spec** field displays the configured state of the cluster network.
- ❷ The **Status** field displays the current state of the cluster network configuration.

7.3. VIEWING CLUSTER NETWORK OPERATOR STATUS

You can inspect the status and view the details of the Cluster Network Operator using the **oc describe** command.

Procedure

- Run the following command to view the status of the Cluster Network Operator:

```
$ oc describe clusteroperators/network
```

7.4. VIEWING CLUSTER NETWORK OPERATOR LOGS

You can view Cluster Network Operator logs by using the **oc logs** command.

Procedure

- Run the following command to view the logs of the Cluster Network Operator:

```
$ oc logs --namespace=openshift-network-operator deployment/network-operator
```

7.5. CLUSTER NETWORK OPERATOR CONFIGURATION

The configuration for the cluster network is specified as part of the Cluster Network Operator (CNO) configuration and stored in a custom resource (CR) object that is named **cluster**. The CR specifies the fields for the **Network** API in the **operator.openshift.io** API group.

The CNO configuration inherits the following fields during cluster installation from the **Network** API in the **Network.config.openshift.io** API group:

clusterNetwork

IP address pools from which pod IP addresses are allocated.

serviceNetwork

IP address pool for services.

defaultNetwork.type

Cluster network plugin. **OVNKubernetes** is the only supported plugin during installation.

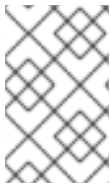

NOTE

After cluster installation, you can only modify the **clusterNetwork** IP address range. The default network type can only be changed from OpenShift SDN to OVN-Kubernetes through migration.

You can specify the cluster network plugin configuration for your cluster by setting the fields for the **defaultNetwork** object in the CNO object named **cluster**.

7.5.1. Cluster Network Operator configuration object

The fields for the Cluster Network Operator (CNO) are described in the following table:

Table 7.1. Cluster Network Operator configuration object

Field	Type	Description
metadata.name	string	The name of the CNO object. This name is always cluster .
spec.clusterNetwork	array	A list specifying the blocks of IP addresses from which pod IP addresses are allocated and the subnet prefix length assigned to each individual node in the cluster. For example: <pre>spec: clusterNetwork: - cidr: 10.128.0.0/19 hostPrefix: 23 - cidr: 10.128.32.0/19 hostPrefix: 23</pre>

Field	Type	Description
spec.serviceNetwork	array	<p>A block of IP addresses for services. The OpenShift SDN and OVN-Kubernetes network plugins support only a single IP address block for the service network. For example:</p> <pre>spec: serviceNetwork: - 172.30.0.0/14</pre> <p>This value is read-only and inherited from the Network.config.openshift.io object named cluster during cluster installation.</p>
spec.defaultNetwork	object	Configures the network plugin for the cluster network.
spec.kubeProxyConfig	object	The fields for this object specify the kube-proxy configuration. If you are using the OVN-Kubernetes cluster network plugin, the kube-proxy configuration has no effect.

defaultNetwork object configuration

The values for the **defaultNetwork** object are defined in the following table:

Table 7.2. **defaultNetwork** object

Field	Type	Description
type	string	<p>OVNKubernetes. The Red Hat OpenShift Networking network plugin is selected during installation. This value cannot be changed after cluster installation.</p> <div style="display: flex; align-items: flex-start;"> <div style="flex: 1;">  </div> <div style="flex: 1; padding-left: 10px;"> <p>NOTE</p> <p>OpenShift Container Platform uses the OVN-Kubernetes network plugin by default. OpenShift SDN is no longer available as an installation choice for new clusters.</p> </div> </div>
ovnKubernetesConfig	object	This object is only valid for the OVN-Kubernetes network plugin.

Configuration for the OpenShift SDN network plugin

The following table describes the configuration fields for the OpenShift SDN network plugin:

Table 7.3. **openshiftSDNConfig** object

Field	Type	Description
mode	string	The network isolation mode for OpenShift SDN.
mtu	integer	The maximum transmission unit (MTU) for the VXLAN overlay network. This value is normally configured automatically.
vxlanPort	integer	The port to use for all VXLAN packets. The default value is 4789 .

Example OpenShift SDN configuration

```
defaultNetwork:
  type: OpenShiftSDN
  openshiftSDNConfig:
    mode: NetworkPolicy
    mtu: 1450
    vxlanPort: 4789
```

Configuration for the OVN-Kubernetes network plugin

The following table describes the configuration fields for the OVN-Kubernetes network plugin:

Table 7.4. `ovnKubernetesConfig` object

Field	Type	Description
mtu	integer	The maximum transmission unit (MTU) for the Geneve (Generic Network Virtualization Encapsulation) overlay network. This value is normally configured automatically.
genevePort	integer	The UDP port for the Geneve overlay network.
ipsecConfig	object	An object describing the IPsec mode for the cluster.
policyAuditConfig	object	Specify a configuration object for customizing network policy audit logging. If unset, the defaults audit log settings are used.
gatewayConfig	object	Optional: Specify a configuration object for customizing how egress traffic is sent to the node gateway.



NOTE

While migrating egress traffic, you can expect some disruption to workloads and service traffic until the Cluster Network Operator (CNO) successfully rolls out the changes.

Field	Type	Description
v4InternalSubnet	<p>If your existing network infrastructure overlaps with the 100.64.0.0/16 IPv4 subnet, you can specify a different IP address range for internal use by OVN-Kubernetes. You must ensure that the IP address range does not overlap with any other subnet used by your OpenShift Container Platform installation. The IP address range must be larger than the maximum number of nodes that can be added to the cluster. For example, if the clusterNetwork.cidr value is 10.128.0.0/14 and the clusterNetwork.hostPrefix value is /23, then the maximum number of nodes is $2^{(23-14)}=512$.</p> <p>This field cannot be changed after installation.</p>	The default value is 100.64.0.0/16 .

Field	Type	Description
v6InternalSubnet	<p>If your existing network infrastructure overlaps with the fd98::/48 IPv6 subnet, you can specify a different IP address range for internal use by OVN-Kubernetes. You must ensure that the IP address range does not overlap with any other subnet used by your OpenShift Container Platform installation. The IP address range must be larger than the maximum number of nodes that can be added to the cluster.</p> <p>This field cannot be changed after installation.</p>	The default value is fd98::/48 .

Table 7.5. `policyAuditConfig` object

Field	Type	Description
rateLimit	integer	The maximum number of messages to generate every second per node. The default value is 20 messages per second.
maxFileSize	integer	The maximum size for the audit log in bytes. The default value is 50000000 or 50 MB.
maxLogFiles	integer	The maximum number of log files that are retained.

Field	Type	Description
destination	string	<p>One of the following additional audit log targets:</p> <p>libc The libc syslog() function of the journald process on the host.</p> <p>udp:<host>:<port> A syslog server. Replace <host>:<port> with the host and port of the syslog server.</p> <p>unix:<file> A Unix Domain Socket file specified by <file>.</p> <p>null Do not send the audit logs to any additional target.</p>
syslogFacility	string	The syslog facility, such as kern , as defined by RFC5424. The default value is local0 .

Table 7.6. gatewayConfig object

Field	Type	Description
routingViaHost	boolean	<p>Set this field to true to send egress traffic from pods to the host networking stack. For highly-specialized installations and applications that rely on manually configured routes in the kernel routing table, you might want to route egress traffic to the host networking stack. By default, egress traffic is processed in OVN to exit the cluster and is not affected by specialized routes in the kernel routing table. The default value is false.</p> <p>This field has an interaction with the Open vSwitch hardware offloading feature. If you set this field to true, you do not receive the performance benefits of the offloading because egress traffic is processed by the host networking stack.</p>
ipForwarding	object	You can control IP forwarding for all traffic on OVN-Kubernetes managed interfaces by using the ipForwarding specification in the Network resource. Specify Restricted to only allow IP forwarding for Kubernetes related traffic. Specify Global to allow forwarding of all IP traffic. For new installations, the default is Restricted . For updates to OpenShift Container Platform 4.14 or later, the default is Global .

Table 7.7. ipsecConfig object

Field	Type	Description
-------	------	-------------

Field	Type	Description
mode	string	<p>Specifies the behavior of the IPsec implementation. Must be one of the following values:</p> <ul style="list-style-type: none"> ● Disabled: IPsec is not enabled on cluster nodes. ● External: IPsec is enabled for network traffic with external hosts. ● Full: IPsec is enabled for pod traffic and network traffic with external hosts.

**NOTE**

You can only change the configuration for your cluster network plugin during cluster installation, except for the **gatewayConfig** field that can be changed at runtime as a postinstallation activity.

Example OVN-Kubernetes configuration with IPsec enabled

```
defaultNetwork:
  type: OVNKubernetes
  ovnKubernetesConfig:
    mtu: 1400
    genevePort: 6081
    ipsecConfig:
      mode: Full
```

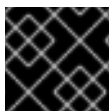
**IMPORTANT**

Using OVNKubernetes can lead to a stack exhaustion problem on IBM Power®.

kubeProxyConfig object configuration (OpenShiftSDN container network interface only)

The values for the **kubeProxyConfig** object are defined in the following table:

Table 7.8. kubeProxyConfig object

Field	Type	Description
-------	------	-------------

Field	Type	Description
iptablesSyncPeriod	string	<p>The refresh period for iptables rules. The default value is 30s. Valid suffixes include s, m, and h and are described in the Go time package documentation.</p> <div style="display: flex; align-items: flex-start;"> <div style="flex: 1;">  </div> <div style="flex: 2;"> <p>NOTE</p> <p>Because of performance improvements introduced in OpenShift Container Platform 4.3 and greater, adjusting the iptablesSyncPeriod parameter is no longer necessary.</p> </div> </div>
proxyArguments.iptables-min-sync-period	array	<p>The minimum duration before refreshing iptables rules. This field ensures that the refresh does not happen too frequently. Valid suffixes include s, m, and h and are described in the Go time package. The default value is:</p> <pre>kubeProxyConfig: proxyArguments: iptables-min-sync-period: - 0s</pre>

7.5.2. Cluster Network Operator example configuration

A complete CNO configuration is specified in the following example:

Example Cluster Network Operator object

```
apiVersion: operator.openshift.io/v1
kind: Network
metadata:
  name: cluster
spec:
  clusterNetwork:
    - cidr: 10.128.0.0/14
      hostPrefix: 23
  serviceNetwork:
    - 172.30.0.0/16
  networkType: OVNKubernetes
  clusterNetworkMTU: 8900
```

7.6. ADDITIONAL RESOURCES

- [Network API](#) in the [operator.openshift.io](#) API group
- [Modifying the clusterNetwork IP address range](#)
- [Migrating from the OpenShift SDN network plugin](#)

CHAPTER 8. DNS OPERATOR IN OPENSIFT CONTAINER PLATFORM

The DNS Operator deploys and manages CoreDNS to provide a name resolution service to pods, enabling DNS-based Kubernetes Service discovery in OpenShift Container Platform.

8.1. DNS OPERATOR

The DNS Operator implements the **dns** API from the **operator.openshift.io** API group. The Operator deploys CoreDNS using a daemon set, creates a service for the daemon set, and configures the kubelet to instruct pods to use the CoreDNS service IP address for name resolution.

Procedure

The DNS Operator is deployed during installation with a **Deployment** object.

1. Use the **oc get** command to view the deployment status:

```
$ oc get -n openshift-dns-operator deployment/dns-operator
```

Example output

```
NAME          READY   UP-TO-DATE   AVAILABLE   AGE
dns-operator  1/1     1             1           23h
```

2. Use the **oc get** command to view the state of the DNS Operator:

```
$ oc get clusteroperator/dns
```

Example output

```
NAME     VERSION   AVAILABLE   PROGRESSING   DEGRADED   SINCE
dns      4.1.0-0.11 True       False         False       92m
```

AVAILABLE, **PROGRESSING** and **DEGRADED** provide information about the status of the operator. **AVAILABLE** is **True** when at least 1 pod from the CoreDNS daemon set reports an **Available** status condition.

8.2. CHANGING THE DNS OPERATOR MANAGEMENTSTATE

DNS manages the CoreDNS component to provide a name resolution service for pods and services in the cluster. The **managementState** of the DNS Operator is set to **Managed** by default, which means that the DNS Operator is actively managing its resources. You can change it to **Unmanaged**, which means the DNS Operator is not managing its resources.

The following are use cases for changing the DNS Operator **managementState**:

- You are a developer and want to test a configuration change to see if it fixes an issue in CoreDNS. You can stop the DNS Operator from overwriting the fix by setting the **managementState** to **Unmanaged**.

- You are a cluster administrator and have reported an issue with CoreDNS, but need to apply a workaround until the issue is fixed. You can set the **managementState** field of the DNS Operator to **Unmanaged** to apply the workaround.

Procedure

- Change **managementState** DNS Operator:

```
oc patch dns.operator.openshift.io default --type merge --patch '{"spec": {"managementState": "Unmanaged"}}'
```

8.3. CONTROLLING DNS POD PLACEMENT

The DNS Operator has two daemon sets: one for CoreDNS and one for managing the **/etc/hosts** file. The daemon set for **/etc/hosts** must run on every node host to add an entry for the cluster image registry to support pulling images. Security policies can prohibit communication between pairs of nodes, which prevents the daemon set for CoreDNS from running on every node.

As a cluster administrator, you can use a custom node selector to configure the daemon set for CoreDNS to run or not run on certain nodes.

Prerequisites

- You installed the **oc** CLI.
- You are logged in to the cluster with a user with **cluster-admin** privileges.

Procedure

- To prevent communication between certain nodes, configure the **spec.nodePlacement.nodeSelector** API field:

- Modify the DNS Operator object named **default**:

```
$ oc edit dns.operator/default
```

- Specify a node selector that includes only control plane nodes in the **spec.nodePlacement.nodeSelector** API field:

```
spec:
  nodePlacement:
    nodeSelector:
      node-role.kubernetes.io/worker: ""
```

- To allow the daemon set for CoreDNS to run on nodes, configure a taint and toleration:

- Modify the DNS Operator object named **default**:

```
$ oc edit dns.operator/default
```

- Specify a taint key and a toleration for the taint:

```
spec:
  nodePlacement:
```

```

tolerations:
- effect: NoExecute
  key: "dns-only"
  operators: Equal
  value: abc
  tolerationSeconds: 3600 1

```

- 1** If the taint is **dns-only**, it can be tolerated indefinitely. You can omit **tolerationSeconds**.

8.4. VIEW THE DEFAULT DNS

Every new OpenShift Container Platform installation has a **dns.operator** named **default**.

Procedure

1. Use the **oc describe** command to view the default **dns**:

```
$ oc describe dns.operator/default
```

Example output

```

Name:      default
Namespace:
Labels:    <none>
Annotations: <none>
API Version: operator.openshift.io/v1
Kind:      DNS
...
Status:
  Cluster Domain: cluster.local 1
  Cluster IP:     172.30.0.10 2
...

```

- 1** The Cluster Domain field is the base DNS domain used to construct fully qualified pod and service domain names.
- 2** The Cluster IP is the address pods query for name resolution. The IP is defined as the 10th address in the service CIDR range.

2. To find the service CIDR of your cluster, use the **oc get** command:

```
$ oc get networks.config/cluster -o jsonpath='{$.status.serviceNetwork}'
```

Example output

```
[172.30.0.0/16]
```

8.5. USING DNS FORWARDING

You can use DNS forwarding to override the default forwarding configuration in the `/etc/resolv.conf` file in the following ways:

- Specify name servers for every zone. If the forwarded zone is the Ingress domain managed by OpenShift Container Platform, then the upstream name server must be authorized for the domain.
- Provide a list of upstream DNS servers.
- Change the default forwarding policy.



NOTE

A DNS forwarding configuration for the default domain can have both the default servers specified in the `/etc/resolv.conf` file and the upstream DNS servers.

Procedure

1. Modify the DNS Operator object named **default**:

```
$ oc edit dns.operator/default
```

After you issue the previous command, the Operator creates and updates the config map named **dns-default** with additional server configuration blocks based on **Server**. If none of the servers have a zone that matches the query, then name resolution falls back to the upstream DNS servers.

Configuring DNS forwarding

```
apiVersion: operator.openshift.io/v1
kind: DNS
metadata:
  name: default
spec:
  servers:
    - name: example-server 1
      zones: 2
      - example.com
    forwardPlugin:
      policy: Random 3
      upstreams: 4
      - 1.1.1.1
      - 2.2.2.2:5353
    upstreamResolvers: 5
      policy: Random 6
      upstreams: 7
      - type: SystemResolvConf 8
      - type: Network
        address: 1.2.3.4 9
        port: 53 10
```

- 1 Must comply with the **rfc6335** service name syntax.

- 2 Must conform to the definition of a subdomain in the **rfc1123** service name syntax. The cluster domain, **cluster.local**, is an invalid subdomain for the **zones** field.
 - 3 Defines the policy to select upstream resolvers. Default value is **Random**. You can also use the values **RoundRobin**, and **Sequential**.
 - 4 A maximum of 15 **upstreams** is allowed per **forwardPlugin**.
 - 5 Optional. You can use it to override the default policy and forward DNS resolution to the specified DNS resolvers (upstream resolvers) for the default domain. If you do not provide any upstream resolvers, the DNS name queries go to the servers in **/etc/resolv.conf**.
 - 6 Determines the order in which upstream servers are selected for querying. You can specify one of these values: **Random**, **RoundRobin**, or **Sequential**. The default value is **Sequential**.
 - 7 Optional. You can use it to provide upstream resolvers.
 - 8 You can specify two types of **upstreams** - **SystemResolvConf** and **Network**. **SystemResolvConf** configures the upstream to use **/etc/resolv.conf** and **Network** defines a **Networkresolver**. You can specify one or both.
 - 9 If the specified type is **Network**, you must provide an IP address. The **address** field must be a valid IPv4 or IPv6 address.
 - 10 If the specified type is **Network**, you can optionally provide a port. The **port** field must have a value between **1** and **65535**. If you do not specify a port for the upstream, by default port 853 is tried.
2. Optional: When working in a highly regulated environment, you might need the ability to secure DNS traffic when forwarding requests to upstream resolvers so that you can ensure additional DNS traffic and data privacy. Cluster administrators can configure transport layer security (TLS) for forwarded DNS queries.

Configuring DNS forwarding with TLS

```

apiVersion: operator.openshift.io/v1
kind: DNS
metadata:
  name: default
spec:
  servers:
  - name: example-server 1
  zones: 2
  - example.com
  forwardPlugin:
    transportConfig:
      transport: TLS 3
      tls:
        caBundle:
          name: mycacert
          serverName: dnstls.example.com 4
    policy: Random 5
  upstreams: 6
  - 1.1.1.1

```

```

- 2.2.2.2:5353
upstreamResolvers: 7
transportConfig:
  transport: TLS
  tls:
    caBundle:
      name: mycacert
      serverName: dnstls.example.com
upstreams:
- type: Network 8
  address: 1.2.3.4 9
  port: 53 10

```

- 1 Must comply with the **rfc6335** service name syntax.
- 2 Must conform to the definition of a subdomain in the **rfc1123** service name syntax. The cluster domain, **cluster.local**, is an invalid subdomain for the **zones** field. The cluster domain, **cluster.local**, is an invalid **subdomain** for **zones**.
- 3 When configuring TLS for forwarded DNS queries, set the **transport** field to have the value **TLS**. By default, CoreDNS caches forwarded connections for 10 seconds. CoreDNS will hold a TCP connection open for those 10 seconds if no request is issued. With large clusters, ensure that your DNS server is aware that it might get many new connections to hold open because you can initiate a connection per node. Set up your DNS hierarchy accordingly to avoid performance issues.
- 4 When configuring TLS for forwarded DNS queries, this is a mandatory server name used as part of the server name indication (SNI) to validate the upstream TLS server certificate.
- 5 Defines the policy to select upstream resolvers. Default value is **Random**. You can also use the values **RoundRobin**, and **Sequential**.
- 6 Required. You can use it to provide upstream resolvers. A maximum of 15 **upstreams** entries are allowed per **forwardPlugin** entry.
- 7 Optional. You can use it to override the default policy and forward DNS resolution to the specified DNS resolvers (upstream resolvers) for the default domain. If you do not provide any upstream resolvers, the DNS name queries go to the servers in **/etc/resolv.conf**.
- 8 **Network** type indicates that this upstream resolver should handle forwarded requests separately from the upstream resolvers listed in **/etc/resolv.conf**. Only the **Network** type is allowed when using TLS and you must provide an IP address.
- 9 The **address** field must be a valid IPv4 or IPv6 address.
- 10 You can optionally provide a port. The **port** must have a value between **1** and **65535**. If you do not specify a port for the upstream, by default port 853 is tried.

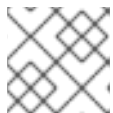

NOTE

If **servers** is undefined or invalid, the config map only contains the default server.

Verification

1. View the config map:

```
$ oc get configmap/dns-default -n openshift-dns -o yaml
```

Sample DNS ConfigMap based on previous sample DNS

```
apiVersion: v1
data:
  Corefile: |
    example.com:5353 {
      forward . 1.1.1.1 2.2.2.2:5353
    }
    bar.com:5353 example.com:5353 {
      forward . 3.3.3.3 4.4.4.4:5454 1
    }
    .:5353 {
      errors
      health
      kubernetes cluster.local in-addr.arpa ip6.arpa {
        pods insecure
        upstream
        fallthrough in-addr.arpa ip6.arpa
      }
      prometheus :9153
      forward . /etc/resolv.conf 1.2.3.4:53 {
        policy Random
      }
      cache 30
      reload
    }
kind: ConfigMap
metadata:
  labels:
    dns.operator.openshift.io/owning-dns: default
  name: dns-default
  namespace: openshift-dns
```

- 1** Changes to the **forwardPlugin** triggers a rolling update of the CoreDNS daemon set.

Additional resources

- For more information on DNS forwarding, see the [CoreDNS forward documentation](#).

8.6. DNS OPERATOR STATUS

You can inspect the status and view the details of the DNS Operator using the **oc describe** command.

Procedure

View the status of the DNS Operator:

```
$ oc describe clusteroperators/dns
```

8.7. DNS OPERATOR LOGS

You can view DNS Operator logs by using the **oc logs** command.

Procedure

View the logs of the DNS Operator:

```
$ oc logs -n openshift-dns-operator deployment/dns-operator -c dns-operator
```

8.8. SETTING THE COREDNS LOG LEVEL

You can configure the CoreDNS log level to determine the amount of detail in logged error messages. The valid values for CoreDNS log level are **Normal**, **Debug**, and **Trace**. The default **logLevel** is **Normal**.



NOTE

The errors plugin is always enabled. The following **logLevel** settings report different error responses:

- **logLevel: Normal** enables the "errors" class: **log . { class error }**.
- **logLevel: Debug** enables the "denial" class: **log . { class denial error }**.
- **logLevel: Trace** enables the "all" class: **log . { class all }**.

Procedure

- To set **logLevel** to **Debug**, enter the following command:

```
$ oc patch dnses.operator.openshift.io/default -p '{"spec":{"logLevel":"Debug"}}' --type=merge
```

- To set **logLevel** to **Trace**, enter the following command:

```
$ oc patch dnses.operator.openshift.io/default -p '{"spec":{"logLevel":"Trace"}}' --type=merge
```

Verification

- To ensure the desired log level was set, check the config map:

```
$ oc get configmap/dns-default -n openshift-dns -o yaml
```

8.9. SETTING THE COREDNS OPERATOR LOG LEVEL

Cluster administrators can configure the Operator log level to more quickly track down OpenShift DNS issues. The valid values for **operatorLogLevel** are **Normal**, **Debug**, and **Trace**. **Trace** has the most detailed information. The default **operatorLogLevel** is **Normal**. There are seven logging levels for issues: Trace, Debug, Info, Warning, Error, Fatal and Panic. After the logging level is set, log entries with that severity or anything above it will be logged.

- **operatorLogLevel: "Normal"** sets **logrus.SetLogLevel("Info")**.
- **operatorLogLevel: "Debug"** sets **logrus.SetLogLevel("Debug")**.

- **operatorLogLevel: "Trace"** sets `logrus.SetLogLevel("Trace")`.

Procedure

- To set **operatorLogLevel** to **Debug**, enter the following command:

```
$ oc patch dnses.operator.openshift.io/default -p '{"spec":{"operatorLogLevel":"Debug"}}' --type=merge
```

- To set **operatorLogLevel** to **Trace**, enter the following command:

```
$ oc patch dnses.operator.openshift.io/default -p '{"spec":{"operatorLogLevel":"Trace"}}' --type=merge
```

8.10. TUNING THE COREDNS CACHE

You can configure the maximum duration of both successful or unsuccessful caching, also known as positive or negative caching respectively, done by CoreDNS. Tuning the duration of caching of DNS query responses can reduce the load for any upstream DNS resolvers.

Procedure

1. Edit the DNS Operator object named **default** by running the following command:

```
$ oc edit dns.operator.openshift.io/default
```

2. Modify the time-to-live (TTL) caching values:

Configuring DNS caching

```
apiVersion: operator.openshift.io/v1
kind: DNS
metadata:
  name: default
spec:
  cache:
    positiveTTL: 1h 1
    negativeTTL: 0.5h10m 2
```

- 1** The string value **1h** is converted to its respective number of seconds by CoreDNS. If this field is omitted, the value is assumed to be **0s** and the cluster uses the internal default value of **900s** as a fallback.
- 2** The string value can be a combination of units such as **0.5h10m** and is converted to its respective number of seconds by CoreDNS. If this field is omitted, the value is assumed to be **0s** and the cluster uses the internal default value of **30s** as a fallback.



WARNING

Setting TTL fields to low values could lead to an increased load on the cluster, any upstream resolvers, or both.

CHAPTER 9. INGRESS OPERATOR IN OPENSIFT CONTAINER PLATFORM

9.1. OPENSIFT CONTAINER PLATFORM INGRESS OPERATOR

When you create your OpenShift Container Platform cluster, pods and services running on the cluster are each allocated their own IP addresses. The IP addresses are accessible to other pods and services running nearby but are not accessible to outside clients. The Ingress Operator implements the **IngressController** API and is the component responsible for enabling external access to OpenShift Container Platform cluster services.

The Ingress Operator makes it possible for external clients to access your service by deploying and managing one or more HAProxy-based [Ingress Controllers](#) to handle routing. You can use the Ingress Operator to route traffic by specifying OpenShift Container Platform **Route** and Kubernetes **Ingress** resources. Configurations within the Ingress Controller, such as the ability to define **endpointPublishingStrategy** type and internal load balancing, provide ways to publish Ingress Controller endpoints.

9.2. THE INGRESS CONFIGURATION ASSET

The installation program generates an asset with an **Ingress** resource in the **config.openshift.io** API group, **cluster-ingress-02-config.yml**.

YAML Definition of the **Ingress** resource

```
apiVersion: config.openshift.io/v1
kind: Ingress
metadata:
  name: cluster
spec:
  domain: apps.openshift demos.com
```

The installation program stores this asset in the **cluster-ingress-02-config.yml** file in the **manifests/** directory. This **Ingress** resource defines the cluster-wide configuration for Ingress. This Ingress configuration is used as follows:

- The Ingress Operator uses the domain from the cluster Ingress configuration as the domain for the default Ingress Controller.
- The OpenShift API Server Operator uses the domain from the cluster Ingress configuration. This domain is also used when generating a default host for a **Route** resource that does not specify an explicit host.

9.3. INGRESS CONTROLLER CONFIGURATION PARAMETERS



The **ingresscontrollers.operator.openshift.io** resource offers the following configuration parameters.

Parameter	Description
-----------	-------------

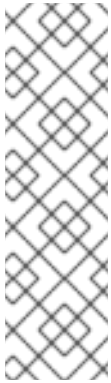
Parameter	Description
domain	<p>domain is a DNS name serviced by the Ingress Controller and is used to configure multiple features:</p> <ul style="list-style-type: none"> • For the LoadBalancerService endpoint publishing strategy, domain is used to configure DNS records. See endpointPublishingStrategy. • When using a generated default certificate, the certificate is valid for domain and its subdomains. See defaultCertificate. • The value is published to individual Route statuses so that users know where to target external DNS records. <p>The domain value must be unique among all Ingress Controllers and cannot be updated.</p> <p>If empty, the default value is ingress.config.openshift.io/cluster.spec.domain.</p>
replicas	<p>replicas is the desired number of Ingress Controller replicas. If not set, the default value is 2.</p>
endpointPublishingStrategy	<p>endpointPublishingStrategy is used to publish the Ingress Controller endpoints to other networks, enable load balancer integrations, and provide access to other systems.</p> <p>On GCP, AWS, and Azure you can configure the following endpointPublishingStrategy fields:</p> <ul style="list-style-type: none"> • loadBalancer.scope • loadBalancer.allowedSourceRanges <p>If not set, the default value is based on infrastructure.config.openshift.io/cluster.status.platform:</p> <ul style="list-style-type: none"> • Azure: LoadBalancerService (with External scope) • Google Cloud Platform (GCP): LoadBalancerService (with External scope) • Bare metal: NodePortService • Other: HostNetwork

Parameter	Description	NOTE
	 	<p>HostNetwork has a hostNetwork field with the following default values for the optional binding ports: httpPort: 80, httpsPort: 443, and statsPort: 1936. With the binding ports, you can deploy multiple Ingress Controllers on the same node for the HostNetwork strategy.</p> <p>Example</p> <pre> apiVersion: operator.openshift.io/v1 kind: IngressController metadata: name: internal namespace: openshift-ingress-operator spec: domain: example.com endpointPublishingStrategy: type: HostNetwork hostNetwork: httpPort: 80 httpsPort: 443 statsPort: 1936 </pre> <p>NOTE</p> <p>On Red Hat OpenStack Platform (RHOSP), the LoadBalancerService endpoint publishing strategy is only supported if a cloud provider is configured to create health monitors. For RHOSP 16.2, this strategy is only possible if you use the Amphora Octavia provider.</p> <p>For more information, see the "Setting cloud provider options" section of the RHOSP installation documentation.</p> <p>For most platforms, the endpointPublishingStrategy value can be updated. On GCP, you can configure the following endpointPublishingStrategy fields:</p> <ul style="list-style-type: none"> ● loadBalancer.scope ● loadbalancer.providerParameters.gcp.clientAccess ● hostNetwork.protocol ● nodePort.protocol

Parameter	Description
defaultCertificate	<p>The defaultCertificate value is a reference to a secret that contains the default certificate that is served by the Ingress Controller. When Routes do not specify their own certificate, defaultCertificate is used.</p> <p>The secret must contain the following keys and data: * tls.crt: certificate file contents * tls.key: key file contents</p> <p>If not set, a wildcard certificate is automatically generated and used. The certificate is valid for the Ingress Controller domain and subdomains, and the generated certificate's CA is automatically integrated with the cluster's trust store.</p> <p>The in-use certificate, whether generated or user-specified, is automatically integrated with OpenShift Container Platform built-in OAuth server.</p>
namespaceSelector	namespaceSelector is used to filter the set of namespaces serviced by the Ingress Controller. This is useful for implementing shards.
routeSelector	routeSelector is used to filter the set of Routes serviced by the Ingress Controller. This is useful for implementing shards.
nodePlacement	<p>nodePlacement enables explicit control over the scheduling of the Ingress Controller.</p> <p>If not set, the defaults values are used.</p> <div style="display: flex; align-items: flex-start;"> <div style="flex: 1;">  </div> <div style="flex: 2;"> <p>NOTE</p> <p>The nodePlacement parameter includes two parts, nodeSelector and tolerations. For example:</p> <pre>nodePlacement: nodeSelector: matchLabels: kubernetes.io/os: linux tolerations: - effect: NoSchedule operator: Exists</pre> </div> </div>

Parameter	Description
<p>tlsSecurityProfile</p>	<p>tlsSecurityProfile specifies settings for TLS connections for Ingress Controllers.</p> <p>If not set, the default value is based on the apiservers.config.openshift.io/cluster resource.</p> <p>When using the Old, Intermediate, and Modern profile types, the effective profile configuration is subject to change between releases. For example, given a specification to use the Intermediate profile deployed on release X.Y.Z, an upgrade to release X.Y.Z+1 may cause a new profile configuration to be applied to the Ingress Controller, resulting in a rollout.</p> <p>The minimum TLS version for Ingress Controllers is 1.1, and the maximum TLS version is 1.3.</p> <div data-bbox="518 748 625 882" style="display: inline-block; vertical-align: top; margin-bottom: 10px;">  </div> <p>NOTE</p> <p>Ciphers and the minimum TLS version of the configured security profile are reflected in the TLSProfile status.</p> <div data-bbox="518 931 625 1066" style="display: inline-block; vertical-align: top; margin-bottom: 10px;">  </div> <p>IMPORTANT</p> <p>The Ingress Operator converts the TLS 1.0 of an Old or Custom profile to 1.1.</p>
<p>clientTLS</p>	<p>clientTLS authenticates client access to the cluster and services; as a result, mutual TLS authentication is enabled. If not set, then client TLS is not enabled.</p> <p>clientTLS has the required subfields, spec.clientTLS.clientCertificatePolicy and spec.clientTLS.ClientCA.</p> <p>The ClientCertificatePolicy subfield accepts one of the two values: Required or Optional. The ClientCA subfield specifies a config map that is in the openshift-config namespace. The config map should contain a CA certificate bundle.</p> <p>The AllowedSubjectPatterns is an optional value that specifies a list of regular expressions, which are matched against the distinguished name on a valid client certificate to filter requests. The regular expressions must use PCRE syntax. At least one pattern must match a client certificate's distinguished name; otherwise, the Ingress Controller rejects the certificate and denies the connection. If not specified, the Ingress Controller does not reject certificates based on the distinguished name.</p>

Parameter	Description
routeAdmission	<p>routeAdmission defines a policy for handling new route claims, such as allowing or denying claims across namespaces.</p> <p>namespaceOwnership describes how hostname claims across namespaces should be handled. The default is Strict.</p> <ul style="list-style-type: none">● Strict: does not allow routes to claim the same hostname across namespaces.● InterNamespaceAllowed: allows routes to claim different paths of the same hostname across namespaces. <p>wildcardPolicy describes how routes with wildcard policies are handled by the Ingress Controller.</p> <ul style="list-style-type: none">● WildcardsAllowed: Indicates routes with any wildcard policy are admitted by the Ingress Controller.● WildcardsDisallowed: Indicates only routes with a wildcard policy of None are admitted by the Ingress Controller. Updating wildcardPolicy from WildcardsAllowed to WildcardsDisallowed causes admitted routes with a wildcard policy of Subdomain to stop working. These routes must be recreated to a wildcard policy of None to be readmitted by the Ingress Controller. WildcardsDisallowed is the default setting.

Parameter	Description
IngressControllerLogging	<p>logging defines parameters for what is logged where. If this field is empty, operational logs are enabled but access logs are disabled.</p> <ul style="list-style-type: none"> ● access describes how client requests are logged. If this field is empty, access logging is disabled. <ul style="list-style-type: none"> ○ destination describes a destination for log messages. <ul style="list-style-type: none"> ■ type is the type of destination for logs: <ul style="list-style-type: none"> ● Container specifies that logs should go to a sidecar container. The Ingress Operator configures the container, named logs, on the Ingress Controller pod and configures the Ingress Controller to write logs to the container. The expectation is that the administrator configures a custom logging solution that reads logs from this container. Using container logs means that logs may be dropped if the rate of logs exceeds the container runtime capacity or the custom logging solution capacity. ● Syslog specifies that logs are sent to a Syslog endpoint. The administrator must specify an endpoint that can receive Syslog messages. The expectation is that the administrator has configured a custom Syslog instance. ■ container describes parameters for the Container logging destination type. Currently there are no parameters for container logging, so this field must be empty. ■ syslog describes parameters for the Syslog logging destination type: <ul style="list-style-type: none"> ● address is the IP address of the syslog endpoint that receives log messages. ● port is the UDP port number of the syslog endpoint that receives log messages. ● maxLength is the maximum length of the syslog message. It must be between 480 and 4096 bytes. If this field is empty, the maximum length is set to the default value of 1024 bytes. ● facility specifies the syslog facility of log messages. If this field is empty, the facility is local1. Otherwise, it must specify a valid syslog facility: kern, user, mail, daemon, auth, syslog, lpr, news, uucp, cron, auth2, ftp, ntp, audit, alert, cron2, local0, local1, local2, local3, local4, local5, local6, or local7. ○ httpLogFormat specifies the format of the log message for an HTTP request. If this field is empty, log messages use the implementation's default HTTP log format. For HAProxy's default HTTP log format, see the HAProxy documentation.

Parameter	Description
httpHeaders	<p>httpHeaders defines the policy for HTTP headers.</p> <p>By setting the forwardedHeaderPolicy for the IngressControllerHTTPHeaders, you specify when and how the Ingress Controller sets the Forwarded, X-Forwarded-For, X-Forwarded-Host, X-Forwarded-Port, X-Forwarded-Proto, and X-Forwarded-Proto-Version HTTP headers.</p> <p>By default, the policy is set to Append.</p> <ul style="list-style-type: none"> ● Append specifies that the Ingress Controller appends the headers, preserving any existing headers. ● Replace specifies that the Ingress Controller sets the headers, removing any existing headers. ● IfNone specifies that the Ingress Controller sets the headers if they are not already set. ● Never specifies that the Ingress Controller never sets the headers, preserving any existing headers. <p>By setting headerNameCaseAdjustments, you can specify case adjustments that can be applied to HTTP header names. Each adjustment is specified as an HTTP header name with the desired capitalization. For example, specifying X-Forwarded-For indicates that the x-forwarded-for HTTP header should be adjusted to have the specified capitalization.</p> <p>These adjustments are only applied to cleartext, edge-terminated, and re-encrypt routes, and only when using HTTP/1.</p> <p>For request headers, these adjustments are applied only for routes that have the haproxy.router.openshift.io/h1-adjust-case=true annotation. For response headers, these adjustments are applied to all HTTP responses. If this field is empty, no request headers are adjusted.</p> <p>actions specifies options for performing certain actions on headers. Headers cannot be set or deleted for TLS passthrough connections. The actions field has additional subfields spec.httpHeader.actions.response and spec.httpHeader.actions.request:</p> <ul style="list-style-type: none"> ● The response subfield specifies a list of HTTP response headers to set or delete. ● The request subfield specifies a list of HTTP request headers to set or delete.

Parameter	Description
httpCompression	<p>httpCompression defines the policy for HTTP traffic compression.</p> <ul style="list-style-type: none"> ● mimeTypes defines a list of MIME types to which compression should be applied. For example, text/css; charset=utf-8, text/html, text/*, image/svg+xml, application/octet-stream, X-custom/customsub, using the format pattern, type/subtype; [;attribute=value]. The types are: application, image, message, multipart, text, video, or a custom type prefaced by X-; e.g. To see the full notation for MIME types and subtypes, see RFC1341
httpErrorCodePages	<p>httpErrorCodePages specifies custom HTTP error code response pages. By default, an IngressController uses error pages built into the IngressController image.</p>
httpCaptureCookies	<p>httpCaptureCookies specifies HTTP cookies that you want to capture in access logs. If the httpCaptureCookies field is empty, the access logs do not capture the cookies.</p> <p>For any cookie that you want to capture, the following parameters must be in your IngressController configuration:</p> <ul style="list-style-type: none"> ● name specifies the name of the cookie. ● maxLength specifies the maximum length of the cookie. ● matchType specifies if the field name of the cookie exactly matches the capture cookie setting or is a prefix of the capture cookie setting. The matchType field uses the Exact and Prefix parameters. <p>For example:</p> <pre> httpCaptureCookies: - matchType: Exact maxLength: 128 name: MYCOOKIE </pre>

Parameter	Description
httpCaptureHeaders	<p>httpCaptureHeaders specifies the HTTP headers that you want to capture in the access logs. If the httpCaptureHeaders field is empty, the access logs do not capture the headers.</p> <p>httpCaptureHeaders contains two lists of headers to capture in the access logs. The two lists of header fields are request and response. In both lists, the name field must specify the header name and the maxLength field must specify the maximum length of the header. For example:</p> <pre data-bbox="518 526 893 940"> httpCaptureHeaders: request: - maxLength: 256 name: Connection - maxLength: 128 name: User-Agent response: - maxLength: 256 name: Content-Type - maxLength: 256 name: Content-Length </pre>
tuningOptions	<p>tuningOptions specifies options for tuning the performance of Ingress Controller pods.</p> <ul data-bbox="582 1108 1428 2049" style="list-style-type: none"> ● clientFinTimeout specifies how long a connection is held open while waiting for the client response to the server closing the connection. The default timeout is 1s. ● clientTimeout specifies how long a connection is held open while waiting for a client response. The default timeout is 30s. ● headerBufferBytes specifies how much memory is reserved, in bytes, for Ingress Controller connection sessions. This value must be at least 16384 if HTTP/2 is enabled for the Ingress Controller. If not set, the default value is 32768 bytes. Setting this field not recommended because headerBufferBytes values that are too small can break the Ingress Controller, and headerBufferBytes values that are too large could cause the Ingress Controller to use significantly more memory than necessary. ● headerBufferMaxRewriteBytes specifies how much memory should be reserved, in bytes, from headerBufferBytes for HTTP header rewriting and appending for Ingress Controller connection sessions. The minimum value for headerBufferMaxRewriteBytes is 4096. headerBufferBytes must be greater than headerBufferMaxRewriteBytes for incoming HTTP requests. If not set, the default value is 8192 bytes. Setting this field not recommended because headerBufferMaxRewriteBytes values that are too small can break the Ingress Controller and headerBufferMaxRewriteBytes values that are too large could cause the Ingress Controller to use significantly more memory than necessary. ● healthCheckInterval specifies how long the router waits between health checks. The default is 5s.

Parameter	Description
	<ul style="list-style-type: none"> ● serverFinTimeout specifies how long a connection is held open while waiting for the server response to the client that is closing the connection. The default timeout is 1s. ● serverTimeout specifies how long a connection is held open while waiting for a server response. The default timeout is 30s. ● threadCount specifies the number of threads to create per HAProxy process. Creating more threads allows each Ingress Controller pod to handle more connections, at the cost of more system resources being used. HAProxy supports up to 64 threads. If this field is empty, the Ingress Controller uses the default value of 4 threads. The default value can change in future releases. Setting this field is not recommended because increasing the number of HAProxy threads allows Ingress Controller pods to use more CPU time under load, and prevent other pods from receiving the CPU resources they need to perform. Reducing the number of threads can cause the Ingress Controller to perform poorly. ● tlsInspectDelay specifies how long the router can hold data to find a matching route. Setting this value too short can cause the router to fall back to the default certificate for edge-terminated, reencrypted, or passthrough routes, even when using a better matched certificate. The default inspect delay is 5s. ● tunnelTimeout specifies how long a tunnel connection, including websockets, remains open while the tunnel is idle. The default timeout is 1h. ● maxConnections specifies the maximum number of simultaneous connections that can be established per HAProxy process. Increasing this value allows each ingress controller pod to handle more connections at the cost of additional system resources. Permitted values are 0, -1, any value within the range 2000 and 2000000, or the field can be left empty. <ul style="list-style-type: none"> ○ If this field is left empty or has the value 0, the Ingress Controller will use the default value of 50000. This value is subject to change in future releases. ○ If the field has the value of -1, then HAProxy will dynamically compute a maximum value based on the available ulimits in the running container. This process results in a large computed value that will incur significant memory usage compared to the current default value of 50000. ○ If the field has a value that is greater than the current operating system limit, the HAProxy process will not start. ○ If you choose a discrete value and the router pod is migrated to a new node, it is possible the new node does not have an identical ulimit configured. In such cases, the pod fails to start. ○ If you have nodes with different ulimits configured, and you choose a discrete value, it is recommended to use the value of -1 for this field so that the maximum number of connections is calculated at runtime.

Parameter	Description
logEmptyRequests	<p>logEmptyRequests specifies connections for which no request is received and logged. These empty requests come from load balancer health probes or web browser speculative connections (preconnect) and logging these requests can be undesirable. However, these requests can be caused by network errors, in which case logging empty requests can be useful for diagnosing the errors. These requests can be caused by port scans, and logging empty requests can aid in detecting intrusion attempts. Allowed values for this field are Log and Ignore. The default value is Log.</p> <p>The LoggingPolicy type accepts either one of two values:</p> <ul style="list-style-type: none"> ● Log: Setting this value to Log indicates that an event should be logged. ● Ignore: Setting this value to Ignore sets the dontlognull option in the HAproxy configuration.
HTTPEmptyRequestsPolicy	<p>HTTPEmptyRequestsPolicy describes how HTTP connections are handled if the connection times out before a request is received. Allowed values for this field are Respond and Ignore. The default value is Respond.</p> <p>The HTTPEmptyRequestsPolicy type accepts either one of two values:</p> <ul style="list-style-type: none"> ● Respond: If the field is set to Respond, the Ingress Controller sends an HTTP 400 or 408 response, logs the connection if access logging is enabled, and counts the connection in the appropriate metrics. ● Ignore: Setting this option to Ignore adds the http-ignore-probes parameter in the HAproxy configuration. If the field is set to Ignore, the Ingress Controller closes the connection without sending a response, then logs the connection, or incrementing metrics. <p>These connections come from load balancer health probes or web browser speculative connections (preconnect) and can be safely ignored. However, these requests can be caused by network errors, so setting this field to Ignore can impede detection and diagnosis of problems. These requests can be caused by port scans, in which case logging empty requests can aid in detecting intrusion attempts.</p>

**NOTE**

All parameters are optional.

9.3.1. Ingress Controller TLS security profiles



TLS security profiles provide a way for servers to regulate which ciphers a connecting client can use when connecting to the server.

9.3.1.1. Understanding TLS security profiles

You can use a TLS (Transport Layer Security) security profile to define which TLS ciphers are required by various OpenShift Container Platform components. The OpenShift Container Platform TLS security profiles are based on [Mozilla recommended configurations](#).

You can specify one of the following TLS security profiles for each component:

Table 9.1. TLS security profiles

Profile	Description
Old	<p>This profile is intended for use with legacy clients or libraries. The profile is based on the Old backward compatibility recommended configuration.</p> <p>The Old profile requires a minimum TLS version of 1.0.</p> <div style="display: flex; align-items: flex-start;">  <div> <p>NOTE</p> <p>For the Ingress Controller, the minimum TLS version is converted from 1.0 to 1.1.</p> </div> </div>
Intermediate	<p>This profile is the recommended configuration for the majority of clients. It is the default TLS security profile for the Ingress Controller, kubelet, and control plane. The profile is based on the Intermediate compatibility recommended configuration.</p> <p>The Intermediate profile requires a minimum TLS version of 1.2.</p>
Modern	<p>This profile is intended for use with modern clients that have no need for backwards compatibility. This profile is based on the Modern compatibility recommended configuration.</p> <p>The Modern profile requires a minimum TLS version of 1.3.</p>
Custom	<p>This profile allows you to define the TLS version and ciphers to use.</p> <div style="background-color: #fff9c4; padding: 10px; border: 1px solid #ccc;"> <div style="display: flex; align-items: flex-start;">  <div> <p>WARNING</p> <p>Use caution when using a Custom profile, because invalid configurations can cause problems.</p> </div> </div> </div>



NOTE

When using one of the predefined profile types, the effective profile configuration is subject to change between releases. For example, given a specification to use the Intermediate profile deployed on release X.Y.Z, an upgrade to release X.Y.Z+1 might cause a new profile configuration to be applied, resulting in a rollout.

9.3.1.2. Configuring the TLS security profile for the Ingress Controller

To configure a TLS security profile for an Ingress Controller, edit the **IngressController** custom resource (CR) to specify a predefined or custom TLS security profile. If a TLS security profile is not configured, the default value is based on the TLS security profile set for the API server.

Sample IngressController CR that configures the Old TLS security profile

```
apiVersion: operator.openshift.io/v1
kind: IngressController
...
spec:
  tlsSecurityProfile:
    old: {}
    type: Old
  ...
```

The TLS security profile defines the minimum TLS version and the TLS ciphers for TLS connections for Ingress Controllers.

You can see the ciphers and the minimum TLS version of the configured TLS security profile in the **IngressController** custom resource (CR) under **Status.Tls Profile** and the configured TLS security profile under **Spec.Tls Security Profile**. For the **Custom** TLS security profile, the specific ciphers and minimum TLS version are listed under both parameters.



NOTE

The HAProxy Ingress Controller image supports TLS **1.3** and the **Modern** profile.

The Ingress Operator also converts the TLS **1.0** of an **Old** or **Custom** profile to **1.1**.

Prerequisites

- You have access to the cluster as a user with the **cluster-admin** role.

Procedure

- Edit the **IngressController** CR in the **openshift-ingress-operator** project to configure the TLS security profile:

```
$ oc edit IngressController default -n openshift-ingress-operator
```

- Add the **spec.tlsSecurityProfile** field:

Sample IngressController CR for a Custom profile

```
apiVersion: operator.openshift.io/v1
kind: IngressController
...
spec:
  tlsSecurityProfile:
    type: Custom 1
    custom: 2
      ciphers: 3
        - ECDHE-ECDSA-CHACHA20-POLY1305
        - ECDHE-RSA-CHACHA20-POLY1305
```



```
- ECDHE-RSA-AES128-GCM-SHA256
- ECDHE-ECDSA-AES128-GCM-SHA256
minTLSVersion: VersionTLS11
```

...

- 1 Specify the TLS security profile type (**Old**, **Intermediate**, or **Custom**). The default is **Intermediate**.
- 2 Specify the appropriate field for the selected type:
 - **old:** {}
 - **intermediate:** {}
 - **custom:**
- 3 For the **custom** type, specify a list of TLS ciphers and minimum accepted TLS version.

3. Save the file to apply the changes.

Verification

- Verify that the profile is set in the **IngressController** CR:

```
$ oc describe IngressController default -n openshift-ingress-operator
```

Example output

```
Name:      default
Namespace: openshift-ingress-operator
Labels:    <none>
Annotations: <none>
API Version: operator.openshift.io/v1
Kind:      IngressController
...
Spec:
...
Tls Security Profile:
  Custom:
    Ciphers:
      ECDHE-ECDSA-CHACHA20-POLY1305
      ECDHE-RSA-CHACHA20-POLY1305
      ECDHE-RSA-AES128-GCM-SHA256
      ECDHE-ECDSA-AES128-GCM-SHA256
    Min TLS Version: VersionTLS11
  Type:      Custom
...

```

9.3.1.3. Configuring mutual TLS authentication

You can configure the Ingress Controller to enable mutual TLS (mTLS) authentication by setting a **spec.clientTLS** value. The **clientTLS** value configures the Ingress Controller to verify client certificates. This configuration includes setting a **clientCA** value, which is a reference to a config map. The config

map contains the PEM-encoded CA certificate bundle that is used to verify a client's certificate. Optionally, you can also configure a list of certificate subject filters.

If the **clientCA** value specifies an X509v3 certificate revocation list (CRL) distribution point, the Ingress Operator downloads and manages a CRL config map based on the HTTP URI X509v3 **CRL Distribution Point** specified in each provided certificate. The Ingress Controller uses this config map during mTLS/TLS negotiation. Requests that do not provide valid certificates are rejected.

Prerequisites

- You have access to the cluster as a user with the **cluster-admin** role.
- You have a PEM-encoded CA certificate bundle.
- If your CA bundle references a CRL distribution point, you must have also included the end-entity or leaf certificate to the client CA bundle. This certificate must have included an HTTP URI under **CRL Distribution Points**, as described in RFC 5280. For example:

```
Issuer: C=US, O=Example Inc, CN=Example Global G2 TLS RSA SHA256 2020 CA1
Subject: SOME SIGNED CERT          X509v3 CRL Distribution Points:
Full Name:
URI:http://crl.example.com/example.crl
```

Procedure

1. In the **openshift-config** namespace, create a config map from your CA bundle:

```
$ oc create configmap \
  router-ca-certs-default \
  --from-file=ca-bundle.pem=client-ca.crt \ 1
  -n openshift-config
```

- 1 The config map data key must be **ca-bundle.pem**, and the data value must be a CA certificate in PEM format.

2. Edit the **IngressController** resource in the **openshift-ingress-operator** project:

```
$ oc edit IngressController default -n openshift-ingress-operator
```

3. Add the **spec.clientTLS** field and subfields to configure mutual TLS:

Sample IngressController CR for a clientTLS profile that specifies filtering patterns

```
apiVersion: operator.openshift.io/v1
kind: IngressController
metadata:
  name: default
  namespace: openshift-ingress-operator
spec:
  clientTLS:
    clientCertificatePolicy: Required
    clientCA:
```

```

name: router-ca-certs-default
allowedSubjectPatterns:
- "^/CN=example.com/ST=NC/C=US/O=Security/OU=OpenShift$"

```

9.4. VIEW THE DEFAULT INGRESS CONTROLLER

The Ingress Operator is a core feature of OpenShift Container Platform and is enabled out of the box.

Every new OpenShift Container Platform installation has an **ingresscontroller** named default. It can be supplemented with additional Ingress Controllers. If the default **ingresscontroller** is deleted, the Ingress Operator will automatically recreate it within a minute.

Procedure

- View the default Ingress Controller:

```
$ oc describe --namespace=openshift-ingress-operator ingresscontroller/default
```

9.5. VIEW INGRESS OPERATOR STATUS

You can view and inspect the status of your Ingress Operator.

Procedure

- View your Ingress Operator status:

```
$ oc describe clusteroperators/ingress
```

9.6. VIEW INGRESS CONTROLLER LOGS

You can view your Ingress Controller logs.

Procedure

- View your Ingress Controller logs:

```
$ oc logs --namespace=openshift-ingress-operator deployments/ingress-operator -c
<container_name>
```

9.7. VIEW INGRESS CONTROLLER STATUS

Your can view the status of a particular Ingress Controller.

Procedure

- View the status of an Ingress Controller:

```
$ oc describe --namespace=openshift-ingress-operator ingresscontroller/<name>
```

9.8. CONFIGURING THE INGRESS CONTROLLER

9.8.1. Setting a custom default certificate

As an administrator, you can configure an Ingress Controller to use a custom certificate by creating a Secret resource and editing the **IngressController** custom resource (CR).

Prerequisites

- You must have a certificate/key pair in PEM-encoded files, where the certificate is signed by a trusted certificate authority or by a private trusted certificate authority that you configured in a custom PKI.
- Your certificate meets the following requirements:
 - The certificate is valid for the ingress domain.
 - The certificate uses the **subjectAltName** extension to specify a wildcard domain, such as ***.apps.ocp4.example.com**.
- You must have an **IngressController** CR. You may use the default one:

```
$ oc --namespace openshift-ingress-operator get ingresscontrollers
```

Example output

```
NAME    AGE
default 10m
```



NOTE

If you have intermediate certificates, they must be included in the **tls.crt** file of the secret containing a custom default certificate. Order matters when specifying a certificate; list your intermediate certificate(s) after any server certificate(s).

Procedure

The following assumes that the custom certificate and key pair are in the **tls.crt** and **tls.key** files in the current working directory. Substitute the actual path names for **tls.crt** and **tls.key**. You also may substitute another name for **custom-certs-default** when creating the Secret resource and referencing it in the IngressController CR.



NOTE

This action will cause the Ingress Controller to be redeployed, using a rolling deployment strategy.

1. Create a Secret resource containing the custom certificate in the **openshift-ingress** namespace using the **tls.crt** and **tls.key** files.

```
$ oc --namespace openshift-ingress create secret tls custom-certs-default --cert=tls.crt --key=tls.key
```

2. Update the IngressController CR to reference the new certificate secret:

```
$ oc patch --type=merge --namespace openshift-ingress-operator ingresscontrollers/default \
  --patch '{"spec":{"defaultCertificate":{"name":"custom-certs-default"}}}'
```

3. Verify the update was effective:

```
$ echo Q |\
  openssl s_client -connect console-openshift-console.apps.<domain>:443 -showcerts
2>/dev/null |\
  openssl x509 -noout -subject -issuer -enddate
```

where:

<domain>

Specifies the base domain name for your cluster.

Example output

```
subject=C = US, ST = NC, L = Raleigh, O = RH, OU = OCP4, CN = *.apps.example.com
issuer=C = US, ST = NC, L = Raleigh, O = RH, OU = OCP4, CN = example.com
notAfter=May 10 08:32:45 2022 GM
```

TIP

You can alternatively apply the following YAML to set a custom default certificate:

```
apiVersion: operator.openshift.io/v1
kind: IngressController
metadata:
  name: default
  namespace: openshift-ingress-operator
spec:
  defaultCertificate:
    name: custom-certs-default
```

The certificate secret name should match the value used to update the CR.

Once the IngressController CR has been modified, the Ingress Operator updates the Ingress Controller's deployment to use the custom certificate.

9.8.2. Removing a custom default certificate

As an administrator, you can remove a custom certificate that you configured an Ingress Controller to use.

Prerequisites

- You have access to the cluster as a user with the **cluster-admin** role.
- You have installed the OpenShift CLI (**oc**).
- You previously configured a custom default certificate for the Ingress Controller.

Procedure

- To remove the custom certificate and restore the certificate that ships with OpenShift Container Platform, enter the following command:

```
$ oc patch -n openshift-ingress-operator ingresscontrollers/default \
  --type json -p '$- op: remove\n path: /spec/defaultCertificate'
```

There can be a delay while the cluster reconciles the new certificate configuration.

Verification

- To confirm that the original cluster certificate is restored, enter the following command:

```
$ echo Q | \
  openssl s_client -connect console-openshift-console.apps.<domain>:443 -showcerts
2>/dev/null | \
  openssl x509 -noout -subject -issuer -enddate
```

where:

<domain>

Specifies the base domain name for your cluster.

Example output

```
subject=CN = *.apps.<domain>
issuer=CN = ingress-operator@1620633373
notAfter=May 10 10:44:36 2023 GMT
```

9.8.3. Autoscaling an Ingress Controller

Automatically scale an Ingress Controller to dynamically meet routing performance or availability requirements such as the requirement to increase throughput. The following procedure provides an example for scaling up the default **IngressController**.

Prerequisites

- You have the OpenShift CLI (**oc**) installed.
- You have access to an OpenShift Container Platform cluster as a user with the **cluster-admin** role.
- You have the Custom Metrics Autoscaler Operator installed.
- You are in the **openshift-ingress-operator** project namespace.

Procedure

- Create a service account to authenticate with Thanos by running the following command:

```
$ oc create serviceaccount thanos && oc describe serviceaccount thanos
```

Example output

```
Name:          thanos
Namespace:     openshift-ingress-operator
Labels:        <none>
Annotations:   <none>
Image pull secrets: thanos-dockercfg-b4l9s
Mountable secrets: thanos-dockercfg-b4l9s
Tokens:        thanos-token-c422q
Events:        <none>
```

2. Define a **TriggerAuthentication** object within the **openshift-ingress-operator** namespace using the service account's token.

- a. Define the variable **secret** that contains the secret by running the following command:

```
$ secret=$(oc get secret | grep thanos-token | head -n 1 | awk '{ print $1 }')
```

- b. Create the **TriggerAuthentication** object and pass the value of the **secret** variable to the **TOKEN** parameter:

```
$ oc process TOKEN="$secret" -f - <<EOF | oc apply -f -
apiVersion: template.openshift.io/v1
kind: Template
parameters:
- name: TOKEN
objects:
- apiVersion: keda.sh/v1alpha1
  kind: TriggerAuthentication
  metadata:
    name: keda-trigger-auth-prometheus
  spec:
    secretTargetRef:
      - parameter: bearerToken
        name: ${TOKEN}
        key: token
      - parameter: ca
        name: ${TOKEN}
        key: ca.crt
EOF
```

3. Create and apply a role for reading metrics from Thanos:

- a. Create a new role, **thanos-metrics-reader.yaml**, that reads metrics from pods and nodes:

thanos-metrics-reader.yaml

```
apiVersion: rbac.authorization.k8s.io/v1
kind: Role
metadata:
  name: thanos-metrics-reader
rules:
- apiGroups:
  - ""
  resources:
  - pods
  - nodes
```

```

verbs:
- get
- apiGroups:
- metrics.k8s.io
resources:
- pods
- nodes
verbs:
- get
- list
- watch
- apiGroups:
- ""
resources:
- namespaces
verbs:
- get

```

- b. Apply the new role by running the following command:

```
$ oc apply -f thanos-metrics-reader.yaml
```

4. Add the new role to the service account by entering the following commands:

```
$ oc adm policy add-role-to-user thanos-metrics-reader -z thanos --role-namespace=openshift-ingress-operator
```

```
$ oc adm policy -n openshift-ingress-operator add-cluster-role-to-user cluster-monitoring-view -z thanos
```



NOTE

The argument **add-cluster-role-to-user** is only required if you use cross-namespace queries. The following step uses a query from the **kube-metrics** namespace which requires this argument.

5. Create a new **ScaledObject** YAML file, **ingress-autoscaler.yaml**, that targets the default Ingress Controller deployment:

Example ScaledObject definition

```

apiVersion: keda.sh/v1alpha1
kind: ScaledObject
metadata:
  name: ingress-scaler
spec:
  scaleTargetRef: 1
    apiVersion: operator.openshift.io/v1
    kind: IngressController
    name: default
    envSourceContainerName: ingress-operator
  minReplicaCount: 1
  maxReplicaCount: 20 2

```



```

cooldownPeriod: 1
pollingInterval: 1
triggers:
- type: prometheus
  metricType: AverageValue
  metadata:
    serverAddress: https://thanos-querier.openshift-monitoring.svc.cluster.local:9091 3
    namespace: openshift-ingress-operator 4
    metricName: 'kube-node-role'
    threshold: '1'
    query: 'sum(kube_node_role{role="worker",service="kube-state-metrics"})' 5
    authModes: "bearer"
  authenticationRef:
    name: keda-trigger-auth-prometheus

```

- 1** The custom resource that you are targeting. In this case, the Ingress Controller.
- 2** Optional: The maximum number of replicas. If you omit this field, the default maximum is set to 100 replicas.
- 3** The Thanos service endpoint in the **openshift-monitoring** namespace.
- 4** The Ingress Operator namespace.
- 5** This expression evaluates to however many worker nodes are present in the deployed cluster.



IMPORTANT

If you are using cross-namespace queries, you must target port 9091 and not port 9092 in the **serverAddress** field. You also must have elevated privileges to read metrics from this port.

6. Apply the custom resource definition by running the following command:

```
$ oc apply -f ingress-autoscaler.yaml
```

Verification

- Verify that the default Ingress Controller is scaled out to match the value returned by the **kube-state-metrics** query by running the following commands:
 - Use the **grep** command to search the Ingress Controller YAML file for replicas:

```
$ oc get ingresscontroller/default -o yaml | grep replicas:
```

Example output

```
replicas: 3
```

- Get the pods in the **openshift-ingress** project:

```
$ oc get pods -n openshift-ingress
```

Example output

```
NAME                                READY STATUS RESTARTS AGE
router-default-7b5df44ff-l9pmm    2/2   Running 0      17h
router-default-7b5df44ff-s5sl5    2/2   Running 0      3d22h
router-default-7b5df44ff-wwsth    2/2   Running 0      66s
```

Additional resources

- [Enabling monitoring for user-defined projects](#)
- [Installing the custom metrics autoscaler](#)
- [Understanding custom metrics autoscaler trigger authentications](#)
- [Configuring the custom metrics autoscaler to use OpenShift Container Platform monitoring](#)
- [Understanding how to add custom metrics autoscalers](#)

9.8.4. Scaling an Ingress Controller

Manually scale an Ingress Controller to meeting routing performance or availability requirements such as the requirement to increase throughput. **oc** commands are used to scale the **IngressController** resource. The following procedure provides an example for scaling up the default **IngressController**.



NOTE

Scaling is not an immediate action, as it takes time to create the desired number of replicas.

Procedure

1. View the current number of available replicas for the default **IngressController**:

```
$ oc get -n openshift-ingress-operator ingresscontrollers/default -o
jsonpath='{$.status.availableReplicas}'
```

Example output

```
2
```

2. Scale the default **IngressController** to the desired number of replicas using the **oc patch** command. The following example scales the default **IngressController** to 3 replicas:

```
$ oc patch -n openshift-ingress-operator ingresscontroller/default --patch '{"spec":{"replicas":
3}}' --type=merge
```

Example output

```
ingresscontroller.operator.openshift.io/default patched
```

- Verify that the default **IngressController** scaled to the number of replicas that you specified:

```
$ oc get -n openshift-ingress-operator ingresscontrollers/default -o
jsonpath='{$.status.availableReplicas}'
```

Example output

```
3
```

TIP

You can alternatively apply the following YAML to scale an Ingress Controller to three replicas:

```
apiVersion: operator.openshift.io/v1
kind: IngressController
metadata:
  name: default
  namespace: openshift-ingress-operator
spec:
  replicas: 3
```

- If you need a different amount of replicas, change the **replicas** value.

9.8.5. Configuring Ingress access logging

You can configure the Ingress Controller to enable access logs. If you have clusters that do not receive much traffic, then you can log to a sidecar. If you have high traffic clusters, to avoid exceeding the capacity of the logging stack or to integrate with a logging infrastructure outside of OpenShift Container Platform, you can forward logs to a custom syslog endpoint. You can also specify the format for access logs.

Container logging is useful to enable access logs on low-traffic clusters when there is no existing Syslog logging infrastructure, or for short-term use while diagnosing problems with the Ingress Controller.

Syslog is needed for high-traffic clusters where access logs could exceed the OpenShift Logging stack's capacity, or for environments where any logging solution needs to integrate with an existing Syslog logging infrastructure. The Syslog use-cases can overlap.

Prerequisites

- Log in as a user with **cluster-admin** privileges.

Procedure

Configure Ingress access logging to a sidecar.

- To configure Ingress access logging, you must specify a destination using **spec.logging.access.destination**. To specify logging to a sidecar container, you must specify **Container spec.logging.access.destination.type**. The following example is an Ingress Controller definition that logs to a **Container** destination:

```
apiVersion: operator.openshift.io/v1
```

```

kind: IngressController
metadata:
  name: default
  namespace: openshift-ingress-operator
spec:
  replicas: 2
  logging:
    access:
      destination:
        type: Container

```

- When you configure the Ingress Controller to log to a sidecar, the operator creates a container named **logs** inside the Ingress Controller Pod:

```
$ oc -n openshift-ingress logs deployment.apps/router-default -c logs
```

Example output

```

2020-05-11T19:11:50.135710+00:00 router-default-57dfc6cd95-bpmk6 router-default-57dfc6cd95-bpmk6 haproxy[108]: 174.19.21.82:39654 [11/May/2020:19:11:50.133] public be_http:hello-openshift:hello-openshift/pod:hello-openshift:hello-openshift:10.128.2.12:8080 0/0/1/0/1 200 142 - - --NI 1/1/0/0/0 0/0 "GET / HTTP/1.1"

```

Configure Ingress access logging to a Syslog endpoint.

- To configure Ingress access logging, you must specify a destination using **spec.logging.access.destination**. To specify logging to a Syslog endpoint destination, you must specify **Syslog** for **spec.logging.access.destination.type**. If the destination type is **Syslog**, you must also specify a destination endpoint using **spec.logging.access.destination.syslog.endpoint** and you can specify a facility using **spec.logging.access.destination.syslog.facility**. The following example is an Ingress Controller definition that logs to a **Syslog** destination:

```

apiVersion: operator.openshift.io/v1
kind: IngressController
metadata:
  name: default
  namespace: openshift-ingress-operator
spec:
  replicas: 2
  logging:
    access:
      destination:
        type: Syslog
      syslog:
        address: 1.2.3.4
        port: 10514

```



NOTE

The **syslog** destination port must be UDP.

Configure Ingress access logging with a specific log format.

- You can specify **spec.logging.access.httpLogFormat** to customize the log format. The following example is an Ingress Controller definition that logs to a **syslog** endpoint with IP address 1.2.3.4 and port 10514:

```

apiVersion: operator.openshift.io/v1
kind: IngressController
metadata:
  name: default
  namespace: openshift-ingress-operator
spec:
  replicas: 2
  logging:
    access:
      destination:
        type: Syslog
        syslog:
          address: 1.2.3.4
          port: 10514
      httpLogFormat: '%ci:%cp [%t] %ft %b/%s %B %bq %HM %HU %HV'

```

Disable Ingress access logging.

- To disable Ingress access logging, leave **spec.logging** or **spec.logging.access** empty:

```

apiVersion: operator.openshift.io/v1
kind: IngressController
metadata:
  name: default
  namespace: openshift-ingress-operator
spec:
  replicas: 2
  logging:
    access: null

```

Allow the Ingress Controller to modify the HAProxy log length when using a sidecar.

- Use **spec.logging.access.destination.syslog.maxLength** if you are using **spec.logging.access.destination.type: Syslog**.

```

apiVersion: operator.openshift.io/v1
kind: IngressController
metadata:
  name: default
  namespace: openshift-ingress-operator
spec:
  replicas: 2
  logging:
    access:
      destination:
        type: Syslog
        syslog:
          address: 1.2.3.4
          maxLength: 4096
          port: 10514

```

- Use **spec.logging.access.destination.container.maxLength** if you are using **spec.logging.access.destination.type: Container**.

```

apiVersion: operator.openshift.io/v1
kind: IngressController
metadata:
  name: default
  namespace: openshift-ingress-operator
spec:
  replicas: 2
  logging:
    access:
      destination:
        type: Container
        container:
          maxLength: 8192

```

9.8.6. Setting Ingress Controller thread count

A cluster administrator can set the thread count to increase the amount of incoming connections a cluster can handle. You can patch an existing Ingress Controller to increase the amount of threads.

Prerequisites

- The following assumes that you already created an Ingress Controller.

Procedure

- Update the Ingress Controller to increase the number of threads:

```

$ oc -n openshift-ingress-operator patch ingresscontroller/default --type=merge -p '{"spec": {"tuningOptions": {"threadCount": 8}}}'

```

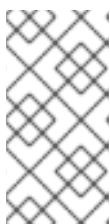

NOTE

If you have a node that is capable of running large amounts of resources, you can configure **spec.nodePlacement.nodeSelector** with labels that match the capacity of the intended node, and configure **spec.tuningOptions.threadCount** to an appropriately high value.

9.8.7. Configuring an Ingress Controller to use an internal load balancer

When creating an Ingress Controller on cloud platforms, the Ingress Controller is published by a public cloud load balancer by default. As an administrator, you can create an Ingress Controller that uses an internal cloud load balancer.

**WARNING**

If your cloud provider is Microsoft Azure, you must have at least one public load balancer that points to your nodes. If you do not, all of your nodes will lose egress connectivity to the internet.

**IMPORTANT**

If you want to change the **scope** for an **IngressController**, you can change the **.spec.endpointPublishingStrategy.loadBalancer.scope** parameter after the custom resource (CR) is created.

Figure 9.1. Diagram of LoadBalancer

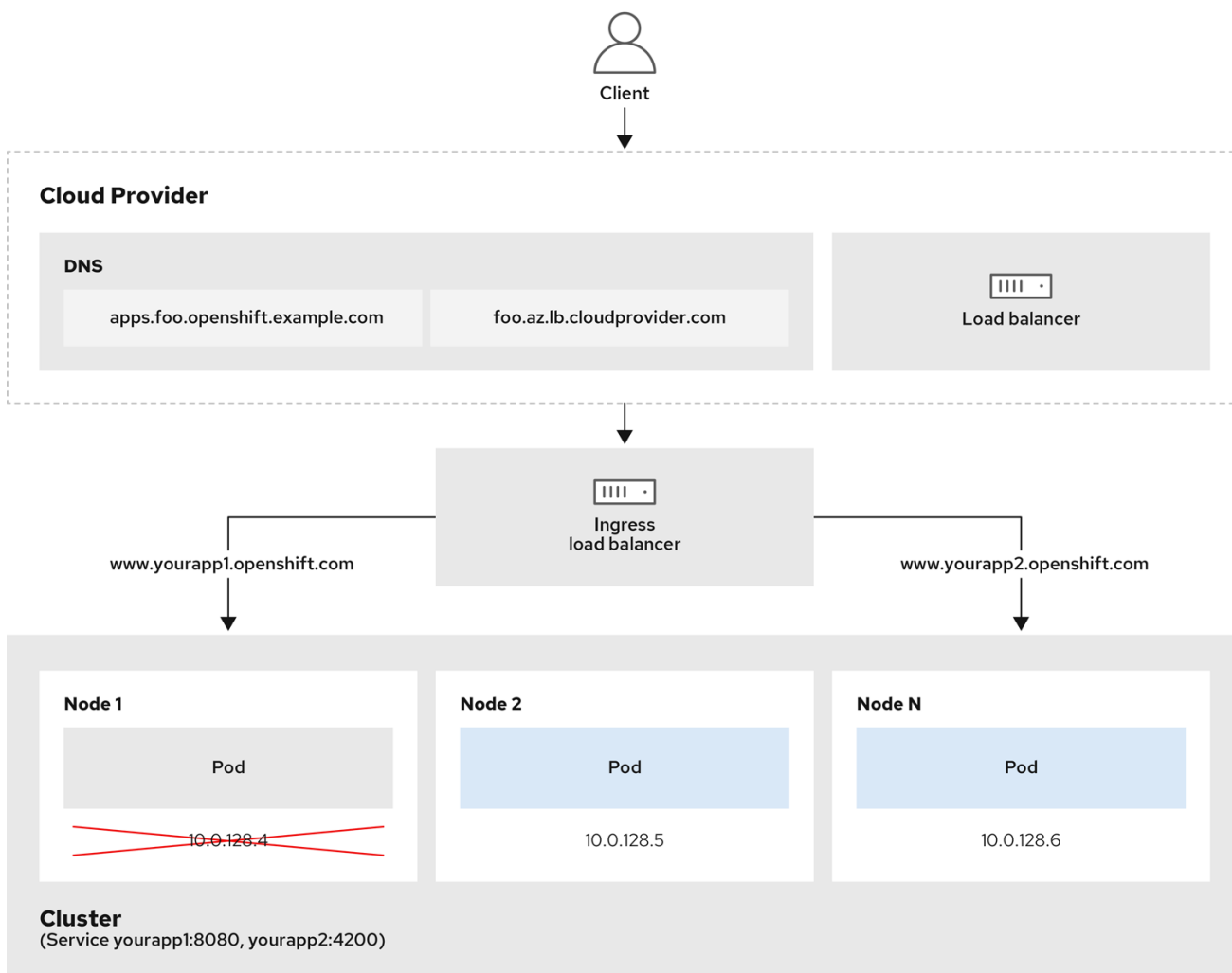

202_OpenShift_0222

The preceding graphic shows the following concepts pertaining to OpenShift Container Platform Ingress LoadBalancerService endpoint publishing strategy:

- You can load balance externally, using the cloud provider load balancer, or internally, using the OpenShift Ingress Controller Load Balancer.

- You can use the single IP address of the load balancer and more familiar ports, such as 8080 and 4200 as shown on the cluster depicted in the graphic.
- Traffic from the external load balancer is directed at the pods, and managed by the load balancer, as depicted in the instance of a down node. See the [Kubernetes Services documentation](#) for implementation details.

Prerequisites

- Install the OpenShift CLI (**oc**).
- Log in as a user with **cluster-admin** privileges.

Procedure

1. Create an **IngressController** custom resource (CR) in a file named **<name>-ingress-controller.yaml**, such as in the following example:

```
apiVersion: operator.openshift.io/v1
kind: IngressController
metadata:
  namespace: openshift-ingress-operator
  name: <name> 1
spec:
  domain: <domain> 2
  endpointPublishingStrategy:
    type: LoadBalancerService
  loadBalancer:
    scope: Internal 3
```

- 1 Replace **<name>** with a name for the **IngressController** object.
- 2 Specify the **domain** for the application published by the controller.
- 3 Specify a value of **Internal** to use an internal load balancer.

2. Create the Ingress Controller defined in the previous step by running the following command:

```
$ oc create -f <name>-ingress-controller.yaml 1
```

- 1 Replace **<name>** with the name of the **IngressController** object.

3. Optional: Confirm that the Ingress Controller was created by running the following command:

```
$ oc --all-namespaces=true get ingresscontrollers
```

9.8.8. Configuring global access for an Ingress Controller on GCP

An Ingress Controller created on GCP with an internal load balancer generates an internal IP address for the service. A cluster administrator can specify the global access option, which enables clients in any region within the same VPC network and compute region as the load balancer, to reach the workloads running on your cluster.

For more information, see the GCP documentation for [global access](#).

Prerequisites

- You deployed an OpenShift Container Platform cluster on GCP infrastructure.
- You configured an Ingress Controller to use an internal load balancer.
- You installed the OpenShift CLI (**oc**).

Procedure

1. Configure the Ingress Controller resource to allow global access.

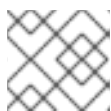

NOTE

You can also create an Ingress Controller and specify the global access option.

- a. Configure the Ingress Controller resource:

```
$ oc -n openshift-ingress-operator edit ingresscontroller/default
```

- b. Edit the YAML file:

Sample `clientAccess` configuration to Global

```
spec:
  endpointPublishingStrategy:
    loadBalancer:
      providerParameters:
        gcp:
          clientAccess: Global 1
          type: GCP
          scope: Internal
          type: LoadBalancerService
```

- 1** Set `gcp.clientAccess` to **Global**.

- c. Save the file to apply the changes.

2. Run the following command to verify that the service allows global access:

```
$ oc -n openshift-ingress edit svc/router-default -o yaml
```

The output shows that global access is enabled for GCP with the annotation, **networking.gke.io/internal-load-balancer-allow-global-access**.

9.8.9. Setting the Ingress Controller health check interval

A cluster administrator can set the health check interval to define how long the router waits between two consecutive health checks. This value is applied globally as a default for all routes. The default value is 5 seconds.

Prerequisites

- The following assumes that you already created an Ingress Controller.

Procedure

- Update the Ingress Controller to change the interval between back end health checks:

```
$ oc -n openshift-ingress-operator patch ingresscontroller/default --type=merge -p '{"spec": {"tuningOptions": {"healthCheckInterval": "8s"}}}'
```



NOTE

To override the **healthCheckInterval** for a single route, use the route annotation **router.openshift.io/haproxy.health.check.interval**

9.8.10. Configuring the default Ingress Controller for your cluster to be internal

You can configure the **default** Ingress Controller for your cluster to be internal by deleting and recreating it.



WARNING

If your cloud provider is Microsoft Azure, you must have at least one public load balancer that points to your nodes. If you do not, all of your nodes will lose egress connectivity to the internet.



IMPORTANT

If you want to change the **scope** for an **IngressController**, you can change the **.spec.endpointPublishingStrategy.loadBalancer.scope** parameter after the custom resource (CR) is created.

Prerequisites

- Install the OpenShift CLI (**oc**).
- Log in as a user with **cluster-admin** privileges.

Procedure

1. Configure the **default** Ingress Controller for your cluster to be internal by deleting and recreating it.

```
$ oc replace --force --wait --filename - <<EOF
apiVersion: operator.openshift.io/v1
kind: IngressController
metadata:
  namespace: openshift-ingress-operator
```

```

name: default
spec:
  endpointPublishingStrategy:
    type: LoadBalancerService
  loadBalancer:
    scope: Internal
EOF

```

9.8.11. Configuring the route admission policy

Administrators and application developers can run applications in multiple namespaces with the same domain name. This is for organizations where multiple teams develop microservices that are exposed on the same hostname.



WARNING

Allowing claims across namespaces should only be enabled for clusters with trust between namespaces, otherwise a malicious user could take over a hostname. For this reason, the default admission policy disallows hostname claims across namespaces.

Prerequisites

- Cluster administrator privileges.

Procedure

- Edit the **.spec.routeAdmission** field of the **ingresscontroller** resource variable using the following command:

```

$ oc -n openshift-ingress-operator patch ingresscontroller/default --patch '{"spec": {"routeAdmission":{"namespaceOwnership":"InterNamespaceAllowed"}}}' --type=merge

```

Sample Ingress Controller configuration

```

spec:
  routeAdmission:
    namespaceOwnership: InterNamespaceAllowed
  ...

```

TIP

You can alternatively apply the following YAML to configure the route admission policy:

```
apiVersion: operator.openshift.io/v1
kind: IngressController
metadata:
  name: default
  namespace: openshift-ingress-operator
spec:
  routeAdmission:
    namespaceOwnership: InterNamespaceAllowed
```

9.8.12. Using wildcard routes

The HAProxy Ingress Controller has support for wildcard routes. The Ingress Operator uses **wildcardPolicy** to configure the **ROUTER_ALLOW_WILDCARD_ROUTES** environment variable of the Ingress Controller.

The default behavior of the Ingress Controller is to admit routes with a wildcard policy of **None**, which is backwards compatible with existing **IngressController** resources.

Procedure

1. Configure the wildcard policy.
 - a. Use the following command to edit the **IngressController** resource:

```
$ oc edit IngressController
```

- b. Under **spec**, set the **wildcardPolicy** field to **WildcardsDisallowed** or **WildcardsAllowed**:

```
spec:
  routeAdmission:
    wildcardPolicy: WildcardsDisallowed # or WildcardsAllowed
```

9.8.13. HTTP header configuration

OpenShift Container Platform provides different methods for working with HTTP headers. When setting or deleting headers, you can use specific fields in the Ingress Controller or an individual route to modify request and response headers. You can also set certain headers by using route annotations. The various ways of configuring headers can present challenges when working together.

**NOTE**

You can only set or delete headers within an **IngressController** or **Route** CR, you cannot append them. If an HTTP header is set with a value, that value must be complete and not require appending in the future. In situations where it makes sense to append a header, such as the X-Forwarded-For header, use the **spec.httpHeaders.forwardedHeaderPolicy** field, instead of **spec.httpHeaders.actions**.

9.8.13.1. Order of precedence

When the same HTTP header is modified both in the Ingress Controller and in a route, HAProxy prioritizes the actions in certain ways depending on whether it is a request or response header.

- For HTTP response headers, actions specified in the Ingress Controller are executed after the actions specified in a route. This means that the actions specified in the Ingress Controller take precedence.
- For HTTP request headers, actions specified in a route are executed after the actions specified in the Ingress Controller. This means that the actions specified in the route take precedence.

For example, a cluster administrator sets the X-Frame-Options response header with the value **DENY** in the Ingress Controller using the following configuration:

Example IngressController spec

```
apiVersion: operator.openshift.io/v1
kind: IngressController
# ...
spec:
  httpHeaders:
    actions:
      response:
        - name: X-Frame-Options
          action:
            type: Set
            set:
              value: DENY
```

A route owner sets the same response header that the cluster administrator set in the Ingress Controller, but with the value **SAMEORIGIN** using the following configuration:

Example Route spec

```
apiVersion: route.openshift.io/v1
kind: Route
# ...
spec:
  httpHeaders:
    actions:
      response:
        - name: X-Frame-Options
          action:
            type: Set
            set:
              value: SAMEORIGIN
```

When both the **IngressController** spec and **Route** spec are configuring the X-Frame-Options header, then the value set for this header at the global level in the Ingress Controller will take precedence, even if a specific route allows frames.

This prioritization occurs because the **haproxy.config** file uses the following logic, where the Ingress Controller is considered the front end and individual routes are considered the back end. The header value **DENY** applied to the front end configurations overrides the same header with the value **SAMEORIGIN** that is set in the back end:

```

frontend public
  http-response set-header X-Frame-Options 'DENY'

frontend fe_sni
  http-response set-header X-Frame-Options 'DENY'

frontend fe_no_sni
  http-response set-header X-Frame-Options 'DENY'

backend be_secure:openshift-monitoring:alertmanager-main
  http-response set-header X-Frame-Options 'SAMEORIGIN'

```

Additionally, any actions defined in either the Ingress Controller or a route override values set using route annotations.

9.8.13.2. Special case headers

The following headers are either prevented entirely from being set or deleted, or allowed under specific circumstances:

Table 9.2. Special case header configuration options

Header name	Configurable using IngressController spec	Configurable using Route spec	Reason for disallowment	Configurable using another method
proxy	No	No	The proxy HTTP request header can be used to exploit vulnerable CGI applications by injecting the header value into the HTTP_PROXY environment variable. The proxy HTTP request header is also non-standard and prone to error during configuration.	No
host	No	Yes	When the host HTTP request header is set using the IngressController CR, HAProxy can fail when looking up the correct route.	No

Header name	Configurable using IngressController spec	Configurable using Route spec	Reason for disallowment	Configurable using another method
strict-transport-security	No	No	The strict-transport-security HTTP response header is already handled using route annotations and does not need a separate implementation.	Yes: the haproxy.router.openshift.io/https_header route annotation
cookie and set-cookie	No	No	The cookies that HAProxy sets are used for session tracking to map client connections to particular back-end servers. Allowing these headers to be set could interfere with HAProxy's session affinity and restrict HAProxy's ownership of a cookie.	Yes: <ul style="list-style-type: none"> the haproxy.router.openshift.io/disable_cookie route annotation the haproxy.router.openshift.io/cookie_name route annotation

9.8.14. Setting or deleting HTTP request and response headers in an Ingress Controller

You can set or delete certain HTTP request and response headers for compliance purposes or other reasons. You can set or delete these headers either for all routes served by an Ingress Controller or for specific routes.

For example, you might want to migrate an application running on your cluster to use mutual TLS, which requires that your application checks for an X-Forwarded-Client-Cert request header, but the OpenShift Container Platform default Ingress Controller provides an X-SSL-Client-Der request header.

The following procedure modifies the Ingress Controller to set the X-Forwarded-Client-Cert request header, and delete the X-SSL-Client-Der request header.

Prerequisites

- You have installed the OpenShift CLI (**oc**).
- You have access to an OpenShift Container Platform cluster as a user with the **cluster-admin** role.

Procedure

1. Edit the Ingress Controller resource:

```
$ oc -n openshift-ingress-operator edit ingresscontroller/default
```

2. Replace the X-SSL-Client-Der HTTP request header with the X-Forwarded-Client-Cert HTTP request header:

```
apiVersion: operator.openshift.io/v1
kind: IngressController
metadata:
  name: default
  namespace: openshift-ingress-operator
spec:
  httpHeaders:
    actions: 1
    request: 2
    - name: X-Forwarded-Client-Cert 3
      action:
        type: Set 4
        set:
          value: "%{+Q}[ssl_c_der,base64]" 5
    - name: X-SSL-Client-Der
      action:
        type: Delete
```

- 1 The list of actions you want to perform on the HTTP headers.
- 2 The type of header you want to change. In this case, a request header.
- 3 The name of the header you want to change. For a list of available headers you can set or delete, see *HTTP header configuration*.
- 4 The type of action being taken on the header. This field can have the value **Set** or **Delete**.
- 5 When setting HTTP headers, you must provide a **value**. The value can be a string from a list of available directives for that header, for example **DENY**, or it can be a dynamic value that will be interpreted using HAProxy's dynamic value syntax. In this case, a dynamic value is added.



NOTE

For setting dynamic header values for HTTP responses, allowed sample fetchers are **res.hdr** and **ssl_c_der**. For setting dynamic header values for HTTP requests, allowed sample fetchers are **req.hdr** and **ssl_c_der**. Both request and response dynamic values can use the **lower** and **base64** converters.

3. Save the file to apply the changes.

9.8.15. Using X-Forwarded headers

You configure the HAProxy Ingress Controller to specify a policy for how to handle HTTP headers including **Forwarded** and **X-Forwarded-For**. The Ingress Operator uses the **HTTPHeader**s field to configure the **ROUTER_SET_FORWARDED_HEADERS** environment variable of the Ingress Controller.

Procedure

1. Configure the **HTTPHeader**s field for the Ingress Controller.
 - a. Use the following command to edit the **IngressController** resource:

```
$ oc edit IngressController
```

- b. Under **spec**, set the **HTTPHeader**s policy field to **Append**, **Replace**, **IfNone**, or **Never**:

```
apiVersion: operator.openshift.io/v1
kind: IngressController
metadata:
  name: default
  namespace: openshift-ingress-operator
spec:
  httpHeaders:
    forwardedHeaderPolicy: Append
```

Example use cases

As a cluster administrator, you can:

- Configure an external proxy that injects the **X-Forwarded-For** header into each request before forwarding it to an Ingress Controller. To configure the Ingress Controller to pass the header through unmodified, you specify the **never** policy. The Ingress Controller then never sets the headers, and applications receive only the headers that the external proxy provides.
- Configure the Ingress Controller to pass the **X-Forwarded-For** header that your external proxy sets on external cluster requests through unmodified. To configure the Ingress Controller to set the **X-Forwarded-For** header on internal cluster requests, which do not go through the external proxy, specify the **if-none** policy. If an HTTP request already has the header set through the external proxy, then the Ingress Controller preserves it. If the header is absent because the request did not come through the proxy, then the Ingress Controller adds the header.

As an application developer, you can:

- Configure an application-specific external proxy that injects the **X-Forwarded-For** header. To configure an Ingress Controller to pass the header through unmodified for an application's Route, without affecting the policy for other Routes, add an annotation **haproxy.router.openshift.io/set-forwarded-headers: if-none** or **haproxy.router.openshift.io/set-forwarded-headers: never** on the Route for the application.

**NOTE**

You can set the **haproxy.router.openshift.io/set-forwarded-headers** annotation on a per route basis, independent from the globally set value for the Ingress Controller.

9.8.16. Enabling HTTP/2 Ingress connectivity

You can enable transparent end-to-end HTTP/2 connectivity in HAProxy. It allows application owners to make use of HTTP/2 protocol capabilities, including single connection, header compression, binary streams, and more.

You can enable HTTP/2 connectivity for an individual Ingress Controller or for the entire cluster.

To enable the use of HTTP/2 for the connection from the client to HAProxy, a route must specify a custom certificate. A route that uses the default certificate cannot use HTTP/2. This restriction is necessary to avoid problems from connection coalescing, where the client re-uses a connection for different routes that use the same certificate.

The connection from HAProxy to the application pod can use HTTP/2 only for re-encrypt routes and not for edge-terminated or insecure routes. This restriction is because HAProxy uses Application-Level Protocol Negotiation (ALPN), which is a TLS extension, to negotiate the use of HTTP/2 with the back-end. The implication is that end-to-end HTTP/2 is possible with passthrough and re-encrypt and not with insecure or edge-terminated routes.

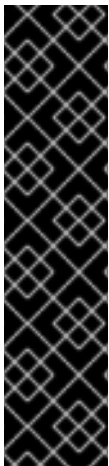
**IMPORTANT**

For non-passthrough routes, the Ingress Controller negotiates its connection to the application independently of the connection from the client. This means a client may connect to the Ingress Controller and negotiate HTTP/1.1, and the Ingress Controller may then connect to the application, negotiate HTTP/2, and forward the request from the client HTTP/1.1 connection using the HTTP/2 connection to the application. This poses a problem if the client subsequently tries to upgrade its connection from HTTP/1.1 to the WebSocket protocol, because the Ingress Controller cannot forward WebSocket to HTTP/2 and cannot upgrade its HTTP/2 connection to WebSocket. Consequently, if you have an application that is intended to accept WebSocket connections, it must not allow negotiating the HTTP/2 protocol or else clients will fail to upgrade to the WebSocket protocol.

Procedure

Enable HTTP/2 on a single Ingress Controller.

- To enable HTTP/2 on an Ingress Controller, enter the **oc annotate** command:

```
$ oc -n openshift-ingress-operator annotate ingresscontrollers/<ingresscontroller_name>
ingress.operator.openshift.io/default-enable-http2=true
```

Replace **<ingresscontroller_name>** with the name of the Ingress Controller to annotate.

Enable HTTP/2 on the entire cluster.

- To enable HTTP/2 for the entire cluster, enter the **oc annotate** command:

```
$ oc annotate ingresses.config/cluster ingress.operator.openshift.io/default-enable-http2=true
```

TIP

You can alternatively apply the following YAML to add the annotation:

```
apiVersion: config.openshift.io/v1
kind: Ingress
metadata:
  name: cluster
  annotations:
    ingress.operator.openshift.io/default-enable-http2: "true"
```

9.8.17. Configuring the PROXY protocol for an Ingress Controller

A cluster administrator can configure [the PROXY protocol](#) when an Ingress Controller uses either the **HostNetwork** or **NodePortService** endpoint publishing strategy types. The PROXY protocol enables the load balancer to preserve the original client addresses for connections that the Ingress Controller receives. The original client addresses are useful for logging, filtering, and injecting HTTP headers. In the default configuration, the connections that the Ingress Controller receives only contain the source address that is associated with the load balancer.

This feature is not supported in cloud deployments. This restriction is because when OpenShift Container Platform runs in a cloud platform, and an IngressController specifies that a service load balancer should be used, the Ingress Operator configures the load balancer service and enables the PROXY protocol based on the platform requirement for preserving source addresses.

**IMPORTANT**

You must configure both OpenShift Container Platform and the external load balancer to either use the PROXY protocol or to use TCP.

**WARNING**

The PROXY protocol is unsupported for the default Ingress Controller with installer-provisioned clusters on non-cloud platforms that use a Keepalived Ingress VIP.

Prerequisites

- You created an Ingress Controller.

Procedure

1. Edit the Ingress Controller resource:

```
$ oc -n openshift-ingress-operator edit ingresscontroller/default
```

2. Set the PROXY configuration:

- If your Ingress Controller uses the `hostNetwork` endpoint publishing strategy type, set the `spec.endpointPublishingStrategy.hostNetwork.protocol` subfield to **PROXY**:

Sample `hostNetwork` configuration to **PROXY**

```
spec:
  endpointPublishingStrategy:
    hostNetwork:
      protocol: PROXY
      type: HostNetwork
```

- If your Ingress Controller uses the `NodePortService` endpoint publishing strategy type, set the `spec.endpointPublishingStrategy.nodePort.protocol` subfield to **PROXY**:

Sample `nodePort` configuration to **PROXY**

```
spec:
  endpointPublishingStrategy:
    nodePort:
      protocol: PROXY
      type: NodePortService
```

9.8.18. Specifying an alternative cluster domain using the `appsDomain` option

As a cluster administrator, you can specify an alternative to the default cluster domain for user-created routes by configuring the `appsDomain` field. The `appsDomain` field is an optional domain for OpenShift Container Platform to use instead of the default, which is specified in the `domain` field. If you specify an alternative domain, it overrides the default cluster domain for the purpose of determining the default host for a new route.

For example, you can use the DNS domain for your company as the default domain for routes and ingresses for applications running on your cluster.

Prerequisites

- You deployed an OpenShift Container Platform cluster.
- You installed the **oc** command line interface.

Procedure

1. Configure the `appsDomain` field by specifying an alternative default domain for user-created routes.
 - a. Edit the ingress **cluster** resource:

```
$ oc edit ingresses.config/cluster -o yaml
```

- b. Edit the YAML file:

Sample `appsDomain` configuration to `test.example.com`

```
apiVersion: config.openshift.io/v1
kind: Ingress
```

```

metadata:
  name: cluster
spec:
  domain: apps.example.com
  appsDomain: <test.example.com>

```

- 1 Specifies the default domain. You cannot modify the default domain after installation.
- 2 Optional: Domain for OpenShift Container Platform infrastructure to use for application routes. Instead of the default prefix, **apps**, you can use an alternative prefix like **test**.

2. Verify that an existing route contains the domain name specified in the **appsDomain** field by exposing the route and verifying the route domain change:



NOTE

Wait for the **openshift-apiserver** finish rolling updates before exposing the route.

- a. Expose the route:

```

$ oc expose service hello-openshift
route.route.openshift.io/hello-openshift exposed

```

Example output:

```

$ oc get routes
NAME          HOST/PORT          PATH  SERVICES  PORT
TERMINATION  WILDCARD
hello-openshift  hello_openshift-<my_project>.test.example.com
hello-openshift  8080-tcp          None

```

9.8.19. Converting HTTP header case

HAProxy lowercases HTTP header names by default, for example, changing **Host: xyz.com** to **host: xyz.com**. If legacy applications are sensitive to the capitalization of HTTP header names, use the Ingress Controller **spec.httpHeaders.headerNameCaseAdjustments** API field for a solution to accommodate legacy applications until they can be fixed.



IMPORTANT

Because OpenShift Container Platform includes HAProxy 2.6, be sure to add the necessary configuration by using **spec.httpHeaders.headerNameCaseAdjustments** before upgrading.

Prerequisites

- You have installed the OpenShift CLI (**oc**).
- You have access to the cluster as a user with the **cluster-admin** role.

Procedure

As a cluster administrator, you can convert the HTTP header case by entering the **oc patch** command or by setting the **HeaderNameCaseAdjustments** field in the Ingress Controller YAML file.

- Specify an HTTP header to be capitalized by entering the **oc patch** command.

- Enter the **oc patch** command to change the HTTP **host** header to **Host**:

```
$ oc -n openshift-ingress-operator patch ingresscontrollers/default --type=merge --
patch='{"spec":{"httpHeaders":{"headerNameCaseAdjustments":["Host"]}}}'
```

- Annotate the route of the application:

```
$ oc annotate routes/my-application haproxy.router.openshift.io/h1-adjust-case=true
```

The Ingress Controller then adjusts the **host** request header as specified.

- Specify adjustments using the **HeaderNameCaseAdjustments** field by configuring the Ingress Controller YAML file.
 - The following example Ingress Controller YAML adjusts the **host** header to **Host** for HTTP/1 requests to appropriately annotated routes:

Example Ingress Controller YAML

```
apiVersion: operator.openshift.io/v1
kind: IngressController
metadata:
  name: default
  namespace: openshift-ingress-operator
spec:
  httpHeaders:
    headerNameCaseAdjustments:
      - Host
```

- The following example route enables HTTP response header name case adjustments using the **haproxy.router.openshift.io/h1-adjust-case** annotation:

Example route YAML

```
apiVersion: route.openshift.io/v1
kind: Route
metadata:
  annotations:
    haproxy.router.openshift.io/h1-adjust-case: true 1
  name: my-application
  namespace: my-application
spec:
  to:
    kind: Service
    name: my-application
```

- Set **haproxy.router.openshift.io/h1-adjust-case** to true.

9.8.20. Using router compression

You configure the HAProxy Ingress Controller to specify router compression globally for specific MIME types. You can use the **mimeTypes** variable to define the formats of MIME types to which compression is applied. The types are: application, image, message, multipart, text, video, or a custom type prefaced by "X-". To see the full notation for MIME types and subtypes, see [RFC1341](#).



NOTE

Memory allocated for compression can affect the max connections. Additionally, compression of large buffers can cause latency, like heavy regex or long lists of regex.

Not all MIME types benefit from compression, but HAProxy still uses resources to try to compress if instructed to. Generally, text formats, such as html, css, and js, formats benefit from compression, but formats that are already compressed, such as image, audio, and video, benefit little in exchange for the time and resources spent on compression.

Procedure

1. Configure the **httpCompression** field for the Ingress Controller.
 - a. Use the following command to edit the **IngressController** resource:

```
$ oc edit -n openshift-ingress-operator ingresscontrollers/default
```

- b. Under **spec**, set the **httpCompression** policy field to **mimeTypes** and specify a list of MIME types that should have compression applied:

```
apiVersion: operator.openshift.io/v1
kind: IngressController
metadata:
  name: default
  namespace: openshift-ingress-operator
spec:
  httpCompression:
    mimeTypes:
      - "text/html"
      - "text/css; charset=utf-8"
      - "application/json"
  ...
```

9.8.21. Exposing router metrics

You can expose the HAProxy router metrics by default in Prometheus format on the default stats port, 1936. The external metrics collection and aggregation systems such as Prometheus can access the HAProxy router metrics. You can view the HAProxy router metrics in a browser in the HTML and comma separated values (CSV) format.

Prerequisites

- You configured your firewall to access the default stats port, 1936.

Procedure

1. Get the router pod name by running the following command:

```
$ oc get pods -n openshift-ingress
```

Example output

```
NAME                READY STATUS RESTARTS AGE
router-default-76bfff66c-46qwp 1/1   Running 0      11h
```

2. Get the router's username and password, which the router pod stores in the `/var/lib/haproxy/conf/metrics-auth/statsUsername` and `/var/lib/haproxy/conf/metrics-auth/statsPassword` files:

- a. Get the username by running the following command:

```
$ oc rsh <router_pod_name> cat metrics-auth/statsUsername
```

- b. Get the password by running the following command:

```
$ oc rsh <router_pod_name> cat metrics-auth/statsPassword
```

3. Get the router IP and metrics certificates by running the following command:

```
$ oc describe pod <router_pod>
```

4. Get the raw statistics in Prometheus format by running the following command:

```
$ curl -u <user>:<password> http://<router_IP>:<stats_port>/metrics
```

5. Access the metrics securely by running the following command:

```
$ curl -u user:password https://<router_IP>:<stats_port>/metrics -k
```

6. Access the default stats port, 1936, by running the following command:

```
$ curl -u <user>:<password> http://<router_IP>:<stats_port>/metrics
```

Example 9.1. Example output

```
...
# HELP haproxy_backend_connections_total Total number of connections.
# TYPE haproxy_backend_connections_total gauge
haproxy_backend_connections_total{backend="http",namespace="default",route="hello-route"} 0
haproxy_backend_connections_total{backend="http",namespace="default",route="hello-route-alt"} 0
haproxy_backend_connections_total{backend="http",namespace="default",route="hello-route01"} 0
...
# HELP haproxy_exporter_server_threshold Number of servers tracked and the current threshold value.
# TYPE haproxy_exporter_server_threshold gauge
```



```

haproxy_exporter_server_threshold{type="current"} 11
haproxy_exporter_server_threshold{type="limit"} 500
...
# HELP haproxy_frontend_bytes_in_total Current total of incoming bytes.
# TYPE haproxy_frontend_bytes_in_total gauge
haproxy_frontend_bytes_in_total{frontend="fe_no_sni"} 0
haproxy_frontend_bytes_in_total{frontend="fe_sni"} 0
haproxy_frontend_bytes_in_total{frontend="public"} 119070
...
# HELP haproxy_server_bytes_in_total Current total of incoming bytes.
# TYPE haproxy_server_bytes_in_total gauge
haproxy_server_bytes_in_total{namespace="",pod="",route="",server="fe_no_sni",service=""} 0
haproxy_server_bytes_in_total{namespace="",pod="",route="",server="fe_sni",service=""} 0
haproxy_server_bytes_in_total{namespace="default",pod="docker-registry-5-nk5fz",route="docker-registry",server="10.130.0.89:5000",service="docker-registry"} 0
haproxy_server_bytes_in_total{namespace="default",pod="hello-rc-vkjqx",route="hello-route",server="10.130.0.90:8080",service="hello-svc-1"} 0
...

```

7. Launch the stats window by entering the following URL in a browser:

```
http://<user>:<password>@<router_IP>:<stats_port>
```

8. Optional: Get the stats in CSV format by entering the following URL in a browser:

```
http://<user>:<password>@<router_ip>:1936/metrics;csv
```

9.8.22. Customizing HAProxy error code response pages

As a cluster administrator, you can specify a custom error code response page for either 503, 404, or both error pages. The HAProxy router serves a 503 error page when the application pod is not running or a 404 error page when the requested URL does not exist. For example, if you customize the 503 error code response page, then the page is served when the application pod is not running, and the default 404 error code HTTP response page is served by the HAProxy router for an incorrect route or a non-existing route.

Custom error code response pages are specified in a config map then patched to the Ingress Controller. The config map keys have two available file names as follows: **error-page-503.http** and **error-page-404.http**.

Custom HTTP error code response pages must follow the [HAProxy HTTP error page configuration guidelines](#). Here is an example of the default OpenShift Container Platform HAProxy router [http 503 error code response page](#). You can use the default content as a template for creating your own custom page.

By default, the HAProxy router serves only a 503 error page when the application is not running or when the route is incorrect or non-existent. This default behavior is the same as the behavior on OpenShift Container Platform 4.8 and earlier. If a config map for the customization of an HTTP error code response is not provided, and you are using a custom HTTP error code response page, the router serves a default 404 or 503 error code response page.

**NOTE**

If you use the OpenShift Container Platform default 503 error code page as a template for your customizations, the headers in the file require an editor that can use CRLF line endings.

Procedure

1. Create a config map named **my-custom-error-code-pages** in the **openshift-config** namespace:

```
$ oc -n openshift-config create configmap my-custom-error-code-pages \
--from-file=error-page-503.http \
--from-file=error-page-404.http
```

**IMPORTANT**

If you do not specify the correct format for the custom error code response page, a router pod outage occurs. To resolve this outage, you must delete or correct the config map and delete the affected router pods so they can be recreated with the correct information.

2. Patch the Ingress Controller to reference the **my-custom-error-code-pages** config map by name:

```
$ oc patch -n openshift-ingress-operator ingresscontroller/default --patch '{"spec": {"httpErrorCodePages":{"name":"my-custom-error-code-pages"}}}' --type=merge
```

The Ingress Operator copies the **my-custom-error-code-pages** config map from the **openshift-config** namespace to the **openshift-ingress** namespace. The Operator names the config map according to the pattern, **<your_ingresscontroller_name>-errorpages**, in the **openshift-ingress** namespace.

3. Display the copy:

```
$ oc get cm default-errorpages -n openshift-ingress
```

Example output

```
NAME          DATA  AGE
default-errorpages  2    25s 1
```

- 1** The example config map name is **default-errorpages** because the **default** Ingress Controller custom resource (CR) was patched.

4. Confirm that the config map containing the custom error response page mounts on the router volume where the config map key is the filename that has the custom HTTP error code response:

- For 503 custom HTTP custom error code response:

```
$ oc -n openshift-ingress rsh <router_pod> cat
/var/lib/haproxy/conf/error_code_pages/error-page-503.http
```

-
- For 404 custom HTTP custom error code response:

```
$ oc -n openshift-ingress rsh <router_pod> cat
/var/lib/haproxy/conf/error_code_pages/error-page-404.http
```

Verification

Verify your custom error code HTTP response:

1. Create a test project and application:

```
$ oc new-project test-ingress
```

```
$ oc new-app django-psql-example
```

2. For 503 custom http error code response:

- a. Stop all the pods for the application.
- b. Run the following curl command or visit the route hostname in the browser:

```
$ curl -vk <route_hostname>
```

3. For 404 custom http error code response:

- a. Visit a non-existent route or an incorrect route.
- b. Run the following curl command or visit the route hostname in the browser:

```
$ curl -vk <route_hostname>
```

4. Check if the **errorfile** attribute is properly in the **haproxy.config** file:

```
$ oc -n openshift-ingress rsh <router> cat /var/lib/haproxy/conf/haproxy.config | grep errorfile
```

9.8.23. Setting the Ingress Controller maximum connections

A cluster administrator can set the maximum number of simultaneous connections for OpenShift router deployments. You can patch an existing Ingress Controller to increase the maximum number of connections.

Prerequisites

- The following assumes that you already created an Ingress Controller

Procedure

- Update the Ingress Controller to change the maximum number of connections for HAProxy:

```
$ oc -n openshift-ingress-operator patch ingresscontroller/default --type=merge -p '{"spec":
{"tuningOptions": {"maxConnections": 7500}}'
```

**WARNING**

If you set the **spec.tuningOptions.maxConnections** value greater than the current operating system limit, the HAProxy process will not start. See the table in the "Ingress Controller configuration parameters" section for more information about this parameter.

9.9. ADDITIONAL RESOURCES

- [Configuring a custom PKI](#)

CHAPTER 10. INGRESS SHARDING IN OPENSIFT CONTAINER PLATFORM

In OpenShift Container Platform, an Ingress Controller can serve all routes, or it can serve a subset of routes. By default, the Ingress Controller serves any route created in any namespace in the cluster. You can add additional Ingress Controllers to your cluster to optimize routing by creating *shards*, which are subsets of routes based on selected characteristics. To mark a route as a member of a shard, use labels in the route or namespace **metadata** field. The Ingress Controller uses *selectors*, also known as a *selection expression*, to select a subset of routes from the entire pool of routes to serve.

Ingress sharding is useful in cases where you want to load balance incoming traffic across multiple Ingress Controllers, when you want to isolate traffic to be routed to a specific Ingress Controller, or for a variety of other reasons described in the next section.

By default, each route uses the default domain of the cluster. However, routes can be configured to use the domain of the router instead. For more information, see [Creating a route for Ingress Controller Sharding](#).

10.1. INGRESS CONTROLLER SHARDING

You can use Ingress sharding, also known as router sharding, to distribute a set of routes across multiple routers by adding labels to routes, namespaces, or both. The Ingress Controller uses a corresponding set of selectors to admit only the routes that have a specified label. Each Ingress shard comprises the routes that are filtered using a given selection expression.

As the primary mechanism for traffic to enter the cluster, the demands on the Ingress Controller can be significant. As a cluster administrator, you can shard the routes to:

- Balance Ingress Controllers, or routers, with several routes to speed up responses to changes.
- Allocate certain routes to have different reliability guarantees than other routes.
- Allow certain Ingress Controllers to have different policies defined.
- Allow only specific routes to use additional features.
- Expose different routes on different addresses so that internal and external users can see different routes, for example.
- Transfer traffic from one version of an application to another during a blue green deployment.

When Ingress Controllers are sharded, a given route is admitted to zero or more Ingress Controllers in the group. A route's status describes whether an Ingress Controller has admitted it or not. An Ingress Controller will only admit a route if it is unique to its shard.

An Ingress Controller can use three sharding methods:

- Adding only a namespace selector to the Ingress Controller, so that all routes in a namespace with labels that match the namespace selector are in the Ingress shard.
- Adding only a route selector to the Ingress Controller, so that all routes with labels that match the route selector are in the Ingress shard.
- Adding both a namespace selector and route selector to the Ingress Controller, so that routes with labels that match the route selector in a namespace with labels that match the namespace selector are in the Ingress shard.

With sharding, you can distribute subsets of routes over multiple Ingress Controllers. These subsets can be non-overlapping, also called *traditional* sharding, or overlapping, otherwise known as *overlapped* sharding.

10.1.1. Traditional sharding example

An Ingress Controller **finops-router** is configured with the label selector **spec.namespaceSelector.matchLabels.name** set to **finance** and **ops**:

Example YAML definition for finops-router

```
apiVersion: operator.openshift.io/v1
kind: IngressController
metadata:
  name: finops-router
  namespace: openshift-ingress-operator
spec:
  namespaceSelector:
    matchLabels:
      name:
        - finance
        - ops
```

A second Ingress Controller **dev-router** is configured with the label selector **spec.namespaceSelector.matchLabels.name** set to **dev**:

Example YAML definition for dev-router

```
apiVersion: operator.openshift.io/v1
kind: IngressController
metadata:
  name: dev-router
  namespace: openshift-ingress-operator
spec:
  namespaceSelector:
    matchLabels:
      name: dev
```

If all application routes are in separate namespaces, each labeled with **name:finance**, **name:ops**, and **name:dev** respectively, this configuration effectively distributes your routes between the two Ingress Controllers. OpenShift Container Platform routes for console, authentication, and other purposes should not be handled.

In the above scenario, sharding becomes a special case of partitioning, with no overlapping subsets. Routes are divided between router shards.

**WARNING**

The **default** Ingress Controller continues to serve all routes unless the **namespaceSelector** or **routeSelector** fields contain routes that are meant for exclusion. See this [Red Hat Knowledgebase solution](#) and the section "Sharding the default Ingress Controller" for more information on how to exclude routes from the default Ingress Controller.

10.1.2. Overlapped sharding example

In addition to **finops-router** and **dev-router** in the example above, you also have **devops-router**, which is configured with the label selector **spec.namespaceSelector.matchLabels.name** set to **dev** and **ops**:

Example YAML definition for devops-router

```
apiVersion: operator.openshift.io/v1
kind: IngressController
metadata:
  name: devops-router
  namespace: openshift-ingress-operator
spec:
  namespaceSelector:
    matchLabels:
      name:
        - dev
        - ops
```

The routes in the namespaces labeled **name:dev** and **name:ops** are now serviced by two different Ingress Controllers. With this configuration, you have overlapping subsets of routes.

With overlapping subsets of routes you can create more complex routing rules. For example, you can divert higher priority traffic to the dedicated **finops-router** while sending lower priority traffic to **devops-router**.

10.1.3. Sharding the default Ingress Controller

After creating a new Ingress shard, there might be routes that are admitted to your new Ingress shard that are also admitted by the default Ingress Controller. This is because the default Ingress Controller has no selectors and admits all routes by default.

You can restrict an Ingress Controller from servicing routes with specific labels using either namespace selectors or route selectors. The following procedure restricts the default Ingress Controller from servicing your newly sharded **finance**, **ops**, and **dev**, routes using a namespace selector. This adds further isolation to Ingress shards.

**IMPORTANT**

You must keep all of OpenShift Container Platform's administration routes on the same Ingress Controller. Therefore, avoid adding additional selectors to the default Ingress Controller that exclude these essential routes.

Prerequisites

- You installed the OpenShift CLI (**oc**).
- You are logged in as a project administrator.

Procedure

1. Modify the default Ingress Controller by running the following command:

```
$ oc edit ingresscontroller -n openshift-ingress-operator default
```

2. Edit the Ingress Controller to contain a **namespaceSelector** that excludes the routes with any of the **finance**, **ops**, and **dev** labels:

```
apiVersion: operator.openshift.io/v1
kind: IngressController
metadata:
  name: default
  namespace: openshift-ingress-operator
spec:
  namespaceSelector:
    matchExpressions:
      - key: type
        operator: NotIn
        values:
          - finance
          - ops
          - dev
```

The default Ingress Controller will no longer serve the namespaces labeled **name:finance**, **name:ops**, and **name:dev**.

10.1.4. Ingress sharding and DNS

The cluster administrator is responsible for making a separate DNS entry for each router in a project. A router will not forward unknown routes to another router.

Consider the following example:

- Router A lives on host 192.168.0.5 and has routes with ***.foo.com**.
- Router B lives on host 192.168.1.9 and has routes with ***.example.com**.

Separate DNS entries must resolve ***.foo.com** to the node hosting Router A and ***.example.com** to the node hosting Router B:

- ***.foo.com A IN 192.168.0.5**
- ***.example.com A IN 192.168.1.9**

10.1.5. Configuring Ingress Controller sharding by using route labels

Ingress Controller sharding by using route labels means that the Ingress Controller serves any route in any namespace that is selected by the route selector.

Figure 10.1. Ingress sharding using route labels

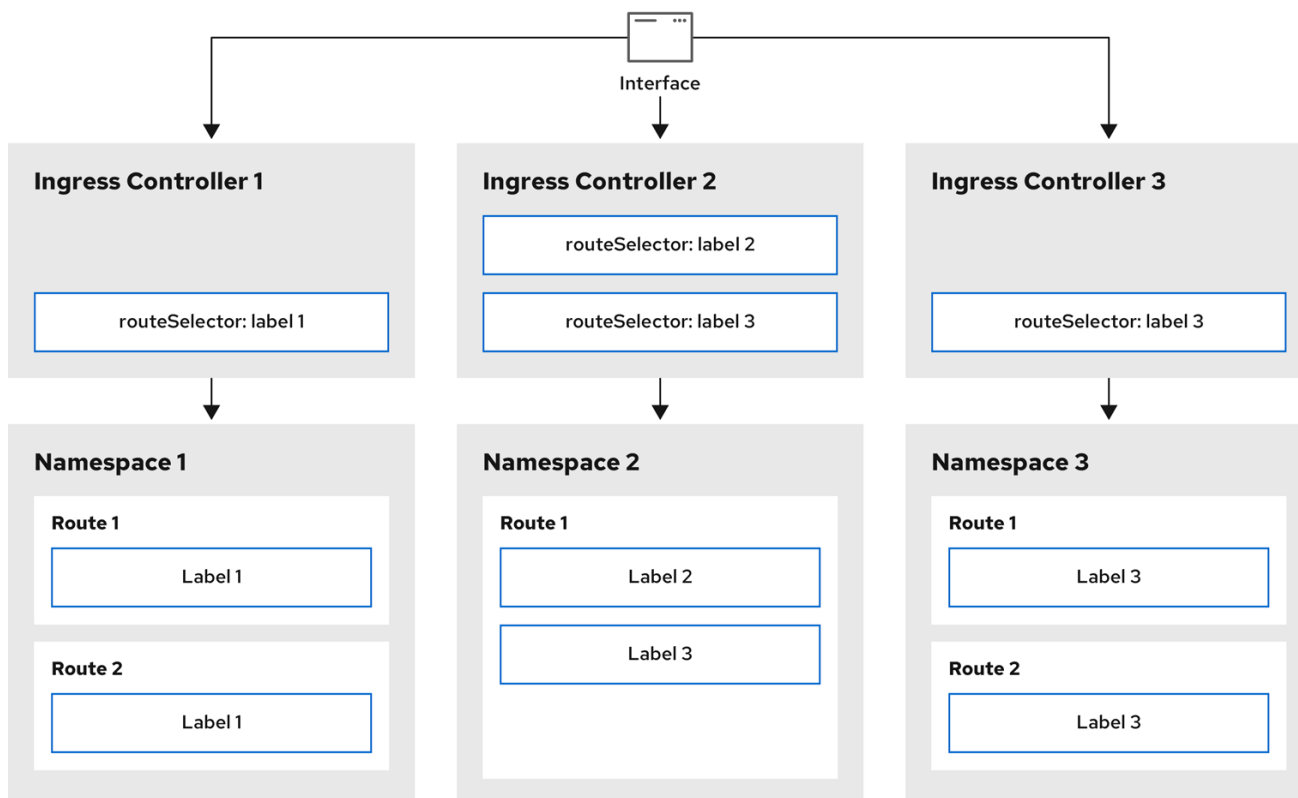

301_OpenShift_0123

Ingress Controller sharding is useful when balancing incoming traffic load among a set of Ingress Controllers and when isolating traffic to a specific Ingress Controller. For example, company A goes to one Ingress Controller and company B to another.

Procedure

1. Edit the **router-internal.yaml** file:

```
# cat router-internal.yaml
apiVersion: operator.openshift.io/v1
kind: IngressController
metadata:
  name: sharded
  namespace: openshift-ingress-operator
spec:
  domain: <apps-sharded.basedomain.example.net> 1
  nodePlacement:
    nodeSelector:
      matchLabels:
        node-role.kubernetes.io/worker: ""
  routeSelector:
    matchLabels:
      type: sharded
```

- 1 Specify a domain to be used by the Ingress Controller. This domain must be different from the default Ingress Controller domain.

2. Apply the Ingress Controller **router-internal.yaml** file:

```
# oc apply -f router-internal.yaml
```

The Ingress Controller selects routes in any namespace that have the label **type: sharded**.

3. Create a new route using the domain configured in the **router-internal.yaml**:

```
$ oc expose svc <service-name> --hostname <route-name>.apps-sharded.basedomain.example.net
```

10.1.6. Configuring Ingress Controller sharding by using namespace labels

Ingress Controller sharding by using namespace labels means that the Ingress Controller serves any route in any namespace that is selected by the namespace selector.

Figure 10.2. Ingress sharding using namespace labels

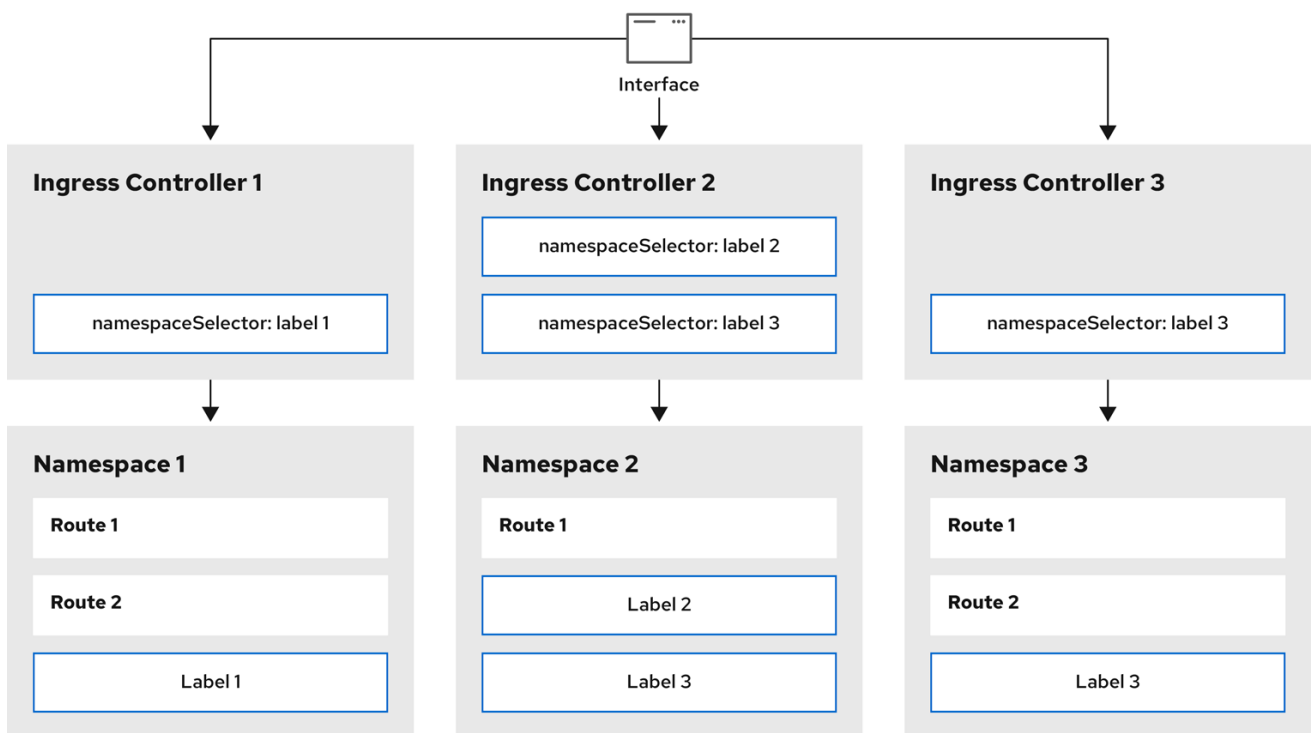

301_OpenShift_0123

Ingress Controller sharding is useful when balancing incoming traffic load among a set of Ingress Controllers and when isolating traffic to a specific Ingress Controller. For example, company A goes to one Ingress Controller and company B to another.

Procedure

1. Edit the **router-internal.yaml** file:

```
# cat router-internal.yaml
```

Example output

```

apiVersion: operator.openshift.io/v1
kind: IngressController
metadata:
  name: sharded
  namespace: openshift-ingress-operator
spec:
  domain: <apps-sharded.basedomain.example.net> 1
  nodePlacement:
    nodeSelector:
      matchLabels:
        node-role.kubernetes.io/worker: ""
  namespaceSelector:
    matchLabels:
      type: sharded

```

- 1** Specify a domain to be used by the Ingress Controller. This domain must be different from the default Ingress Controller domain.

- Apply the Ingress Controller **router-internal.yaml** file:

```
# oc apply -f router-internal.yaml
```

The Ingress Controller selects routes in any namespace that is selected by the namespace selector that have the label **type: sharded**.

- Create a new route using the domain configured in the **router-internal.yaml**:

```
$ oc expose svc <service-name> --hostname <route-name>.apps-sharded.basedomain.example.net
```

10.2. CREATING A ROUTE FOR INGRESS CONTROLLER SHARDING

A route allows you to host your application at a URL. In this case, the hostname is not set and the route uses a subdomain instead. When you specify a subdomain, you automatically use the domain of the Ingress Controller that exposes the route. For situations where a route is exposed by multiple Ingress Controllers, the route is hosted at multiple URLs.

The following procedure describes how to create a route for Ingress Controller sharding, using the **hello-openshift** application as an example.

Ingress Controller sharding is useful when balancing incoming traffic load among a set of Ingress Controllers and when isolating traffic to a specific Ingress Controller. For example, company A goes to one Ingress Controller and company B to another.

Prerequisites

- You installed the OpenShift CLI (**oc**).
- You are logged in as a project administrator.
- You have a web application that exposes a port and an HTTP or TLS endpoint listening for traffic on the port.

- You have configured the Ingress Controller for sharding.

Procedure

1. Create a project called **hello-openshift** by running the following command:

```
$ oc new-project hello-openshift
```

2. Create a pod in the project by running the following command:

```
$ oc create -f https://raw.githubusercontent.com/openshift/origin/master/examples/hello-openshift/hello-pod.json
```

3. Create a service called **hello-openshift** by running the following command:

```
$ oc expose pod/hello-openshift
```

4. Create a route definition called **hello-openshift-route.yaml**:

YAML definition of the created route for sharding:

```
apiVersion: route.openshift.io/v1
kind: Route
metadata:
  labels:
    type: sharded 1
  name: hello-openshift-edge
  namespace: hello-openshift
spec:
  subdomain: hello-openshift 2
  tls:
    termination: edge
  to:
    kind: Service
    name: hello-openshift
```

- 1** Both the label key and its corresponding label value must match the ones specified in the Ingress Controller. In this example, the Ingress Controller has the label key and value **type: sharded**.
- 2** The route will be exposed using the value of the **subdomain** field. When you specify the **subdomain** field, you must leave the hostname unset. If you specify both the **host** and **subdomain** fields, then the route will use the value of the **host** field, and ignore the **subdomain** field.

5. Use **hello-openshift-route.yaml** to create a route to the **hello-openshift** application by running the following command:

```
$ oc -n hello-openshift create -f hello-openshift-route.yaml
```

Verification

- Get the status of the route with the following command:

```
$ oc -n hello-openshift get routes/hello-openshift-edge -o yaml
```

The resulting **Route** resource should look similar to the following:

Example output

```
apiVersion: route.openshift.io/v1
kind: Route
metadata:
  labels:
    type: sharded
  name: hello-openshift-edge
  namespace: hello-openshift
spec:
  subdomain: hello-openshift
  tls:
    termination: edge
  to:
    kind: Service
    name: hello-openshift
status:
  ingress:
    - host: hello-openshift.<apps-sharded.basedomain.example.net> 1
      routerCanonicalHostname: router-sharded.<apps-sharded.basedomain.example.net> 2
      routerName: sharded 3
```

- 1** The hostname the Ingress Controller, or router, uses to expose the route. The value of the **host** field is automatically determined by the Ingress Controller, and uses its domain. In this example, the domain of the Ingress Controller is **<apps-sharded.basedomain.example.net>**.
- 2** The hostname of the Ingress Controller.
- 3** The name of the Ingress Controller. In this example, the Ingress Controller has the name **sharded**.

Additional Resources

- [Baseline Ingress Controller \(router\) performance](#)

CHAPTER 11. INGRESS NODE FIREWALL OPERATOR IN OPENSIFT CONTAINER PLATFORM

The Ingress Node Firewall Operator allows administrators to manage firewall configurations at the node level.

11.1. INGRESS NODE FIREWALL OPERATOR

The Ingress Node Firewall Operator provides ingress firewall rules at a node level by deploying the daemon set to nodes you specify and manage in the firewall configurations. To deploy the daemon set, you create an **IngressNodeFirewallConfig** custom resource (CR). The Operator applies the **IngressNodeFirewallConfig** CR to create ingress node firewall daemon set **daemon**, which run on all nodes that match the **nodeSelector**.

You configure **rules** of the **IngressNodeFirewall** CR and apply them to clusters using the **nodeSelector** and setting values to "true".



IMPORTANT

The Ingress Node Firewall Operator supports only stateless firewall rules.

Network interface controllers (NICs) that do not support native XDP drivers will run at a lower performance.

For OpenShift Container Platform 4.14 or later, you must run Ingress Node Firewall Operator on RHEL 9.0 or later.

Ingress Node Firewall Operator is not supported on Amazon Web Services (AWS) with the default OpenShift installation or on Red Hat OpenShift Service on AWS (ROSA). For more information on Red Hat OpenShift Service on AWS support and ingress, see [Ingress Operator in Red Hat OpenShift Service on AWS](#).

11.2. INSTALLING THE INGRESS NODE FIREWALL OPERATOR

As a cluster administrator, you can install the Ingress Node Firewall Operator by using the OpenShift Container Platform CLI or the web console.

11.2.1. Installing the Ingress Node Firewall Operator using the CLI

As a cluster administrator, you can install the Operator using the CLI.

Prerequisites

- You have installed the OpenShift CLI (**oc**).
- You have an account with administrator privileges.

Procedure

1. To create the **openshift-ingress-node-firewall** namespace, enter the following command:

```
$ cat << EOF | oc create -f -
apiVersion: v1
```

```

kind: Namespace
metadata:
  labels:
    pod-security.kubernetes.io/enforce: privileged
    pod-security.kubernetes.io/enforce-version: v1.24
  name: openshift-ingress-node-firewall
EOF

```

- To create an **OperatorGroup** CR, enter the following command:

```

$ cat << EOF | oc create -f -
apiVersion: operators.coreos.com/v1
kind: OperatorGroup
metadata:
  name: ingress-node-firewall-operators
  namespace: openshift-ingress-node-firewall
EOF

```

- Subscribe to the Ingress Node Firewall Operator.

- To create a **Subscription** CR for the Ingress Node Firewall Operator, enter the following command:

```

$ cat << EOF | oc create -f -
apiVersion: operators.coreos.com/v1alpha1
kind: Subscription
metadata:
  name: ingress-node-firewall-sub
  namespace: openshift-ingress-node-firewall
spec:
  name: ingress-node-firewall
  channel: stable
  source: redhat-operators
  sourceNamespace: openshift-marketplace
EOF

```

- To verify that the Operator is installed, enter the following command:

```
$ oc get ip -n openshift-ingress-node-firewall
```

Example output

```

NAME          CSV                                APPROVAL APPROVED
install-5cvnz ingress-node-firewall.4.15.0-202211122336 Automatic true

```

- To verify the version of the Operator, enter the following command:

```
$ oc get csv -n openshift-ingress-node-firewall
```

Example output

```

NAME          DISPLAY          VERSION          REPLACES
PHASE

```

```
ingress-node-firewall.4.15.0-202211122336 Ingress Node Firewall Operator 4.15.0-
202211122336 ingress-node-firewall.4.15.0-202211102047 Succeeded
```

11.2.2. Installing the Ingress Node Firewall Operator using the web console

As a cluster administrator, you can install the Operator using the web console.

Prerequisites

- You have installed the OpenShift CLI (**oc**).
- You have an account with administrator privileges.

Procedure

1. Install the Ingress Node Firewall Operator:
 - a. In the OpenShift Container Platform web console, click **Operators** → **OperatorHub**.
 - b. Select **Ingress Node Firewall Operator** from the list of available Operators, and then click **Install**.
 - c. On the **Install Operator** page, under **Installed Namespace**, select **Operator recommended Namespace**.
 - d. Click **Install**.
2. Verify that the Ingress Node Firewall Operator is installed successfully:
 - a. Navigate to the **Operators** → **Installed Operators** page.
 - b. Ensure that **Ingress Node Firewall Operator** is listed in the **openshift-ingress-node-firewall** project with a **Status** of **InstallSucceeded**.



NOTE

During installation an Operator might display a **Failed** status. If the installation later succeeds with an **InstallSucceeded** message, you can ignore the **Failed** message.

If the Operator does not have a **Status** of **InstallSucceeded**, troubleshoot using the following steps:

- Inspect the **Operator Subscriptions** and **Install Plans** tabs for any failures or errors under **Status**.
- Navigate to the **Workloads** → **Pods** page and check the logs for pods in the **openshift-ingress-node-firewall** project.
- Check the namespace of the YAML file. If the annotation is missing, you can add the annotation **workload.openshift.io/allowed=management** to the Operator namespace with the following command:

```
$ oc annotate ns/openshift-ingress-node-firewall
workload.openshift.io/allowed=management
```

**NOTE**

For single-node OpenShift clusters, the **openshift-ingress-node-firewall** namespace requires the **workload.openshift.io/allowed=management** annotation.

11.3. DEPLOYING INGRESS NODE FIREWALL OPERATOR

Prerequisite

- The Ingress Node Firewall Operator is installed.

Procedure

To deploy the Ingress Node Firewall Operator, create a **IngressNodeFirewallConfig** custom resource that will deploy the Operator's daemon set. You can deploy one or multiple **IngressNodeFirewall** CRDs to nodes by applying firewall rules.

1. Create the **IngressNodeFirewallConfig** inside the **openshift-ingress-node-firewall** namespace named **ingressnodefirewallconfig**.
2. Run the following command to deploy Ingress Node Firewall Operator rules:

```
$ oc apply -f rule.yaml
```

11.3.1. Ingress Node Firewall configuration object

The fields for the Ingress Node Firewall configuration object are described in the following table:

Table 11.1. Ingress Node Firewall Configuration object

Field	Type	Description
metadata.name	string	The name of the CR object. The name of the firewall rules object must be ingressnodefirewallconfig .
metadata.name space	string	Namespace for the Ingress Firewall Operator CR object. The IngressNodeFirewallConfig CR must be created inside the openshift-ingress-node-firewall namespace.

Field	Type	Description
spec.nodeSelector	string	<p>A node selection constraint used to target nodes through specified node labels. For example:</p> <pre>spec: nodeSelector: node-role.kubernetes.io/worker: ""</pre> <p>NOTE</p> <p>One label used in nodeSelector must match a label on the nodes in order for the daemon set to start. For example, if the node labels node-role.kubernetes.io/worker and node-type.kubernetes.io/vm are applied to a node, then at least one label must be set using nodeSelector for the daemon set to start.</p>

**NOTE**

The Operator consumes the CR and creates an ingress node firewall daemon set on all the nodes that match the **nodeSelector**.

Ingress Node Firewall Operator example configuration

A complete Ingress Node Firewall Configuration is specified in the following example:

Example Ingress Node Firewall Configuration object

```
apiVersion: ingressnodefirewall.openshift.io/v1alpha1
kind: IngressNodeFirewallConfig
metadata:
  name: ingressnodefirewallconfig
  namespace: openshift-ingress-node-firewall
spec:
  nodeSelector:
    node-role.kubernetes.io/worker: ""
```

**NOTE**

The Operator consumes the CR and creates an ingress node firewall daemon set on all the nodes that match the **nodeSelector**.

11.3.2. Ingress Node Firewall rules object

The fields for the Ingress Node Firewall rules object are described in the following table:

Table 11.2. Ingress Node Firewall rules object

Field	Type	Description
metadata.name	string	The name of the CR object.
interfaces	array	The fields for this object specify the interfaces to apply the firewall rules to. For example, - en0 and - en1 .
nodeSelector	array	You can use nodeSelector to select the nodes to apply the firewall rules to. Set the value of your named nodeselector labels to true to apply the rule.
ingress	object	ingress allows you to configure the rules that allow outside access to the services on your cluster.

Ingress object configuration

The values for the **ingress** object are defined in the following table:

Table 11.3. ingress object

Field	Type	Description
sourceCIDRs	array	<p>Allows you to set the CIDR block. You can configure multiple CIDRs from different address families.</p> <div style="display: flex; align-items: flex-start;">  <div> <p>NOTE</p> <p>Different CIDRs allow you to use the same order rule. In the case that there are multiple IngressNodeFirewall objects for the same nodes and interfaces with overlapping CIDRs, the order field will specify which rule is applied first. Rules are applied in ascending order.</p> </div> </div>

Field	Type	Description
rules	array	<p>Ingress firewall rules.order objects are ordered starting at 1 for each source.CIDR with up to 100 rules per CIDR. Lower order rules are executed first.</p> <p>rules.protocolConfig.protocol supports the following protocols: TCP, UDP, SCTP, ICMP and ICMPv6. ICMP and ICMPv6 rules can match against ICMP and ICMPv6 types or codes. TCP, UDP, and SCTP rules can match against a single destination port or a range of ports using <start : end-1> format.</p> <p>Set rules.action to allow to apply the rule or deny to disallow the rule.</p> <div style="display: flex; align-items: flex-start;"> <div style="flex: 1;">  </div> <div style="flex: 1;"> <p>NOTE</p> <p>Ingress firewall rules are verified using a verification webhook that blocks any invalid configuration. The verification webhook prevents you from blocking any critical cluster services such as the API server or SSH.</p> </div> </div>

Ingress Node Firewall rules object example

A complete Ingress Node Firewall configuration is specified in the following example:

Example Ingress Node Firewall configuration

```

apiVersion: ingressnodefirewall.openshift.io/v1alpha1
kind: IngressNodeFirewall
metadata:
  name: ingressnodefirewall
spec:
  interfaces:
  - eth0
  nodeSelector:
    matchLabels:
      <ingress_firewall_label_name>: <label_value> 1
  ingress:
  - sourceCIDRs:
    - 172.16.0.0/12
    rules:
    - order: 10
      protocolConfig:
        protocol: ICMP
        icmp:
          icmpType: 8 #ICMP Echo request
      action: Deny
    - order: 20
      protocolConfig:
        protocol: TCP

```

```

tcp:
  ports: "8000-9000"
  action: Deny
- sourceCIDRs:
  - fc00:f853:ccd:e793::0/64
rules:
- order: 10
protocolConfig:
  protocol: ICMPv6
  icmpv6:
    icmpType: 128 #ICMPV6 Echo request
  action: Deny

```

- 1** A <label_name> and a <label_value> must exist on the node and must match the **nodeselector** label and value applied to the nodes you want the **ingressfirewallconfig** CR to run on. The <label_value> can be **true** or **false**. By using **nodeSelector** labels, you can target separate groups of nodes to apply different rules to using the **ingressfirewallconfig** CR.

Zero trust Ingress Node Firewall rules object example

Zero trust Ingress Node Firewall rules can provide additional security to multi-interface clusters. For example, you can use zero trust Ingress Node Firewall rules to drop all traffic on a specific interface except for SSH.

A complete configuration of a zero trust Ingress Node Firewall rule set is specified in the following example:



IMPORTANT

Users need to add all ports their application will use to their allowlist in the following case to ensure proper functionality.

Example zero trust Ingress Node Firewall rules

```

apiVersion: ingressnodefirewall.openshift.io/v1alpha1
kind: IngressNodeFirewall
metadata:
  name: ingressnodefirewall-zero-trust
spec:
  interfaces:
  - eth1 1
  nodeSelector:
    matchLabels:
      <ingress_firewall_label_name>: <label_value> 2
  ingress:
  - sourceCIDRs:
    - 0.0.0.0/0 3
    rules:
    - order: 10
      protocolConfig:
        protocol: TCP
        tcp:
          ports: 22

```

```

action: Allow
- order: 20
  action: Deny 4

```

- 1 Network-interface cluster
- 2 The <label_name> and <label_value> needs to match the **nodeSelector** label and value applied to the specific nodes with which you wish to apply the **ingressfirewallconfig** CR.
- 3 **0.0.0.0/0** set to match any CIDR
- 4 **action** set to **Deny**

11.4. VIEWING INGRESS NODE FIREWALL OPERATOR RULES

Procedure

1. Run the following command to view all current rules :

```
$ oc get ingressnodefirewall
```

2. Choose one of the returned **<resource>** names and run the following command to view the rules or configs:

```
$ oc get <resource> <name> -o yaml
```

11.5. TROUBLESHOOTING THE INGRESS NODE FIREWALL OPERATOR

- Run the following command to list installed Ingress Node Firewall custom resource definitions (CRD):

```
$ oc get crds | grep ingressnodefirewall
```

Example output

```

NAME                                READY UP-TO-DATE AVAILABLE AGE
ingressnodefirewallconfigs.ingressnodefirewall.openshift.io 2022-08-25T10:03:01Z
ingressnodefirewallnodestates.ingressnodefirewall.openshift.io 2022-08-25T10:03:00Z
ingressnodefirewalls.ingressnodefirewall.openshift.io 2022-08-25T10:03:00Z

```

- Run the following command to view the state of the Ingress Node Firewall Operator:

```
$ oc get pods -n openshift-ingress-node-firewall
```

Example output

```

NAME                                READY STATUS    RESTARTS AGE
ingress-node-firewall-controller-manager 2/2 Running    0      5d21h
ingress-node-firewall-daemon-pqx56      3/3 Running    0      5d21h

```

The following fields provide information about the status of the Operator: **READY**, **STATUS**, **AGE**, and **RESTARTS**. The **STATUS** field is **Running** when the Ingress Node Firewall Operator is deploying a daemon set to the assigned nodes.

- Run the following command to collect all ingress firewall node pods' logs:

```
$ oc adm must-gather -- gather_ingress_node_firewall
```

The logs are available in the sos node's report containing eBPF **bpftool** outputs at **/sos_commands/ebpf**. These reports include lookup tables used or updated as the ingress firewall XDP handles packet processing, updates statistics, and emits events.

CHAPTER 12. CONFIGURING AN INGRESS CONTROLLER FOR MANUAL DNS MANAGEMENT

As a cluster administrator, when you create an Ingress Controller, the Operator manages the DNS records automatically. This has some limitations when the required DNS zone is different from the cluster DNS zone or when the DNS zone is hosted outside the cloud provider.

As a cluster administrator, you can configure an Ingress Controller to stop automatic DNS management and start manual DNS management. Set **dnsManagementPolicy** to specify when it should be automatically or manually managed.

When you change an Ingress Controller from **Managed** to **Unmanaged** DNS management policy, the Operator does not clean up the previous wildcard DNS record provisioned on the cloud. When you change an Ingress Controller from **Unmanaged** to **Managed** DNS management policy, the Operator attempts to create the DNS record on the cloud provider if it does not exist or updates the DNS record if it already exists.



IMPORTANT

When you set **dnsManagementPolicy** to **unmanaged**, you have to manually manage the lifecycle of the wildcard DNS record on the cloud provider.

12.1. MANAGED DNS MANAGEMENT POLICY

The **Managed** DNS management policy for Ingress Controllers ensures that the lifecycle of the wildcard DNS record on the cloud provider is automatically managed by the Operator.

12.2. UNMANAGED DNS MANAGEMENT POLICY

The **Unmanaged** DNS management policy for Ingress Controllers ensures that the lifecycle of the wildcard DNS record on the cloud provider is not automatically managed, instead it becomes the responsibility of the cluster administrator.



NOTE

On the AWS cloud platform, if the domain on the Ingress Controller does not match with **dnsConfig.Spec.BaseDomain** then the DNS management policy is automatically set to **Unmanaged**.

12.3. CREATING A CUSTOM INGRESS CONTROLLER WITH THE UNMANAGED DNS MANAGEMENT POLICY

As a cluster administrator, you can create a new custom Ingress Controller with the **Unmanaged** DNS management policy.

Prerequisites

- Install the OpenShift CLI (**oc**).
- Log in as a user with **cluster-admin** privileges.

Procedure

1. Create a custom resource (CR) file named **sample-ingress.yaml** containing the following:

```

apiVersion: operator.openshift.io/v1
kind: IngressController
metadata:
  namespace: openshift-ingress-operator
  name: <name> 1
spec:
  domain: <domain> 2
  endpointPublishingStrategy:
    type: LoadBalancerService
    loadBalancer:
      scope: External 3
      dnsManagementPolicy: Unmanaged 4

```

- 1 Specify the **<name>** with a name for the **IngressController** object.
- 2 Specify the **domain** based on the DNS record that was created as a prerequisite.
- 3 Specify the **scope** as **External** to expose the load balancer externally.
- 4 **dnsManagementPolicy** indicates if the Ingress Controller is managing the lifecycle of the wildcard DNS record associated with the load balancer. The valid values are **Managed** and **Unmanaged**. The default value is **Managed**.

2. Save the file to apply the changes.

```
oc apply -f <name>.yaml 1
```

12.4. MODIFYING AN EXISTING INGRESS CONTROLLER

As a cluster administrator, you can modify an existing Ingress Controller to manually manage the DNS record lifecycle.

Prerequisites

- Install the OpenShift CLI (**oc**).
- Log in as a user with **cluster-admin** privileges.

Procedure

1. Modify the chosen **IngressController** to set **dnsManagementPolicy**:

```

SCOPE=$(oc -n openshift-ingress-operator get ingresscontroller <name> -o=jsonpath="{.status.endpointPublishingStrategy.loadBalancer.scope}")

oc -n openshift-ingress-operator patch ingresscontrollers/<name> --type=merge --
patch='{"spec":{"endpointPublishingStrategy":{"type":"LoadBalancerService","loadBalancer":
{"dnsManagementPolicy":"Unmanaged", "scope":"${SCOPE}}}}}'

```

2. Optional: You can delete the associated DNS record in the cloud provider.

12.5. ADDITIONAL RESOURCES

- [Ingress Controller configuration parameters](#)

CHAPTER 13. CONFIGURING THE INGRESS CONTROLLER ENDPOINT PUBLISHING STRATEGY

13.1. INGRESS CONTROLLER ENDPOINT PUBLISHING STRATEGY

NodePortService endpoint publishing strategy

The **NodePortService** endpoint publishing strategy publishes the Ingress Controller using a Kubernetes NodePort service.

In this configuration, the Ingress Controller deployment uses container networking. A **NodePortService** is created to publish the deployment. The specific node ports are dynamically allocated by OpenShift Container Platform; however, to support static port allocations, your changes to the node port field of the managed **NodePortService** are preserved.

Figure 13.1. Diagram of NodePortService

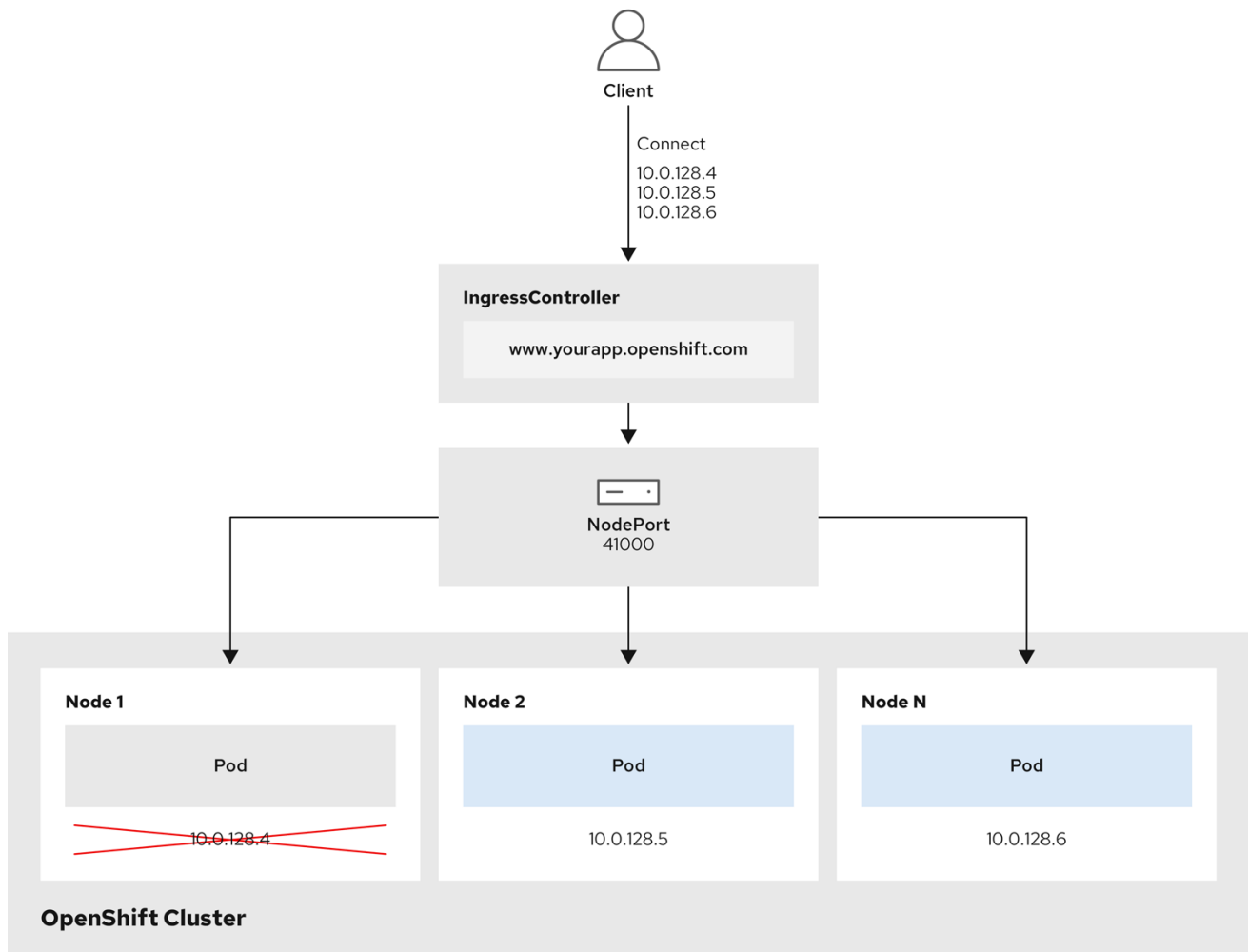

202_OpenShift_0222

The preceding graphic shows the following concepts pertaining to OpenShift Container Platform Ingress NodePort endpoint publishing strategy:

- All the available nodes in the cluster have their own, externally accessible IP addresses. The service running in the cluster is bound to the unique NodePort for all the nodes.
- When the client connects to a node that is down, for example, by connecting the **10.0.128.4** IP

address in the graphic, the node port directly connects the client to an available node that is running the service. In this scenario, no load balancing is required. As the image shows, the **10.0.128.4** address is down and another IP address must be used instead.

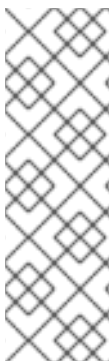

NOTE

The Ingress Operator ignores any updates to `.spec.ports[].nodePort` fields of the service.

By default, ports are allocated automatically and you can access the port allocations for integrations. However, sometimes static port allocations are necessary to integrate with existing infrastructure which may not be easily reconfigured in response to dynamic ports. To achieve integrations with static node ports, you can update the managed service resource directly.

For more information, see the [Kubernetes Services documentation on NodePort](#).

HostNetwork endpoint publishing strategy

The **HostNetwork** endpoint publishing strategy publishes the Ingress Controller on node ports where the Ingress Controller is deployed.

An Ingress Controller with the **HostNetwork** endpoint publishing strategy can have only one pod replica per node. If you want n replicas, you must use at least n nodes where those replicas can be scheduled. Because each pod replica requests ports **80** and **443** on the node host where it is scheduled, a replica cannot be scheduled to a node if another pod on the same node is using those ports.

13.1.1. Configuring the Ingress Controller endpoint publishing scope to Internal

When a cluster administrator installs a new cluster without specifying that the cluster is private, the default Ingress Controller is created with a **scope** set to **External**. Cluster administrators can change an **External** scoped Ingress Controller to **Internal**.

Prerequisites

- You installed the **oc** CLI.

Procedure

- To change an **External** scoped Ingress Controller to **Internal**, enter the following command:

```
$ oc -n openshift-ingress-operator patch ingresscontrollers/default --type=merge --
patch='{"spec":{"endpointPublishingStrategy":{"type":"LoadBalancerService","loadBalancer":
{"scope":"Internal"}}}'
```

- To check the status of the Ingress Controller, enter the following command:

```
$ oc -n openshift-ingress-operator get ingresscontrollers/default -o yaml
```

- The **Progressing** status condition indicates whether you must take further action. For example, the status condition can indicate that you need to delete the service by entering the following command:

```
$ oc -n openshift-ingress delete services/router-default
```

If you delete the service, the Ingress Operator recreates it as **Internal**.

13.1.2. Configuring the Ingress Controller endpoint publishing scope to External

When a cluster administrator installs a new cluster without specifying that the cluster is private, the default Ingress Controller is created with a **scope** set to **External**.

The Ingress Controller's scope can be configured to be **Internal** during installation or after, and cluster administrators can change an **Internal** Ingress Controller to **External**.



IMPORTANT

On some platforms, it is necessary to delete and recreate the service.

Changing the scope can cause disruption to Ingress traffic, potentially for several minutes. This applies to platforms where it is necessary to delete and recreate the service, because the procedure can cause OpenShift Container Platform to deprovision the existing service load balancer, provision a new one, and update DNS.

Prerequisites

- You installed the **oc** CLI.

Procedure

- To change an **Internal** scoped Ingress Controller to **External**, enter the following command:

```
$ oc -n openshift-ingress-operator patch ingresscontrollers/private --type=merge --
patch='{"spec":{"endpointPublishingStrategy":{"type":"LoadBalancerService","loadBalancer":
{"scope":"External"}}}'
```

- To check the status of the Ingress Controller, enter the following command:

```
$ oc -n openshift-ingress-operator get ingresscontrollers/default -o yaml
```

- The **Progressing** status condition indicates whether you must take further action. For example, the status condition can indicate that you need to delete the service by entering the following command:

```
$ oc -n openshift-ingress delete services/router-default
```

If you delete the service, the Ingress Operator recreates it as **External**.

13.2. ADDITIONAL RESOURCES

- For more information, see [Ingress Controller configuration parameters](#).

CHAPTER 14. VERIFYING CONNECTIVITY TO AN ENDPOINT

The Cluster Network Operator (CNO) runs a controller, the connectivity check controller, that performs a connection health check between resources within your cluster. By reviewing the results of the health checks, you can diagnose connection problems or eliminate network connectivity as the cause of an issue that you are investigating.

14.1. CONNECTION HEALTH CHECKS PERFORMED

To verify that cluster resources are reachable, a TCP connection is made to each of the following cluster API services:

- Kubernetes API server service
- Kubernetes API server endpoints
- OpenShift API server service
- OpenShift API server endpoints
- Load balancers

To verify that services and service endpoints are reachable on every node in the cluster, a TCP connection is made to each of the following targets:

- Health check target service
- Health check target endpoints

14.2. IMPLEMENTATION OF CONNECTION HEALTH CHECKS

The connectivity check controller orchestrates connection verification checks in your cluster. The results for the connection tests are stored in **PodNetworkConnectivity** objects in the **openshift-network-diagnostics** namespace. Connection tests are performed every minute in parallel.

The Cluster Network Operator (CNO) deploys several resources to the cluster to send and receive connectivity health checks:

Health check source

This program deploys in a single pod replica set managed by a **Deployment** object. The program consumes **PodNetworkConnectivity** objects and connects to the **spec.targetEndpoint** specified in each object.

Health check target

A pod deployed as part of a daemon set on every node in the cluster. The pod listens for inbound health checks. The presence of this pod on every node allows for the testing of connectivity to each node.

14.3. PODNETWORKCONNECTIVITYCHECK OBJECT FIELDS

The **PodNetworkConnectivityCheck** object fields are described in the following tables.

Table 14.1. PodNetworkConnectivityCheck object fields

Field	Type	Description
metadata.name	string	The name of the object in the following format: <source>-to-<target> . The destination described by <target> includes one of following strings: <ul style="list-style-type: none"> ● load-balancer-api-external ● load-balancer-api-internal ● kubernetes-apiserver-endpoint ● kubernetes-apiserver-service-cluster ● network-check-target ● openshift-apiserver-endpoint ● openshift-apiserver-service-cluster
metadata.namespace	string	The namespace that the object is associated with. This value is always openshift-network-diagnostics .
spec.sourcePod	string	The name of the pod where the connection check originates, such as network-check-source-596b4c6566-rgh92 .
spec.targetEndpoint	string	The target of the connection check, such as api.devcluster.example.com:6443 .
spec.tlsClientCert	object	Configuration for the TLS certificate to use.
spec.tlsClientCert.name	string	The name of the TLS certificate used, if any. The default value is an empty string.
status	object	An object representing the condition of the connection test and logs of recent connection successes and failures.
status.conditions	array	The latest status of the connection check and any previous statuses.
status.failures	array	Connection test logs from unsuccessful attempts.
status.outages	array	Connect test logs covering the time periods of any outages.
status.successes	array	Connection test logs from successful attempts.

The following table describes the fields for objects in the **status.conditions** array:

Table 14.2. `status.conditions`

Field	Type	Description
lastTransitionTime	string	The time that the condition of the connection transitioned from one status to another.
message	string	The details about last transition in a human readable format.
reason	string	The last status of the transition in a machine readable format.
status	string	The status of the condition.
type	string	The type of the condition.

The following table describes the fields for objects in the **`status.conditions`** array:

Table 14.3. `status.outages`

Field	Type	Description
end	string	The timestamp from when the connection failure is resolved.
endLogs	array	Connection log entries, including the log entry related to the successful end of the outage.
message	string	A summary of outage details in a human readable format.
start	string	The timestamp from when the connection failure is first detected.
startLogs	array	Connection log entries, including the original failure.

Connection log fields

The fields for a connection log entry are described in the following table. The object is used in the following fields:

- **`status.failures[]`**
- **`status.successes[]`**
- **`status.outages[].startLogs[]`**
- **`status.outages[].endLogs[]`**

Table 14.4. Connection log object

Field	Type	Description
latency	string	Records the duration of the action.
message	string	Provides the status in a human readable format.
reason	string	Provides the reason for status in a machine readable format. The value is one of TCPConnect , TCPConnectError , DNSResolve , DNSErrors .
success	boolean	Indicates if the log entry is a success or failure.
time	string	The start time of connection check.

14.4. VERIFYING NETWORK CONNECTIVITY FOR AN ENDPOINT

As a cluster administrator, you can verify the connectivity of an endpoint, such as an API server, load balancer, service, or pod.

Prerequisites

- Install the OpenShift CLI (**oc**).
- Access to the cluster as a user with the **cluster-admin** role.

Procedure

1. To list the current **PodNetworkConnectivityCheck** objects, enter the following command:

```
$ oc get podnetworkconnectivitycheck -n openshift-network-diagnostics
```

Example output

```

NAME                                                                                               AGE
network-check-source-ci-ln-x5sv9rb-f76d1-4rgrp-worker-b-6xdmh-to-kubernetes-apiserver-
endpoint-ci-ln-x5sv9rb-f76d1-4rgrp-master-0 75m
network-check-source-ci-ln-x5sv9rb-f76d1-4rgrp-worker-b-6xdmh-to-kubernetes-apiserver-
endpoint-ci-ln-x5sv9rb-f76d1-4rgrp-master-1 73m
network-check-source-ci-ln-x5sv9rb-f76d1-4rgrp-worker-b-6xdmh-to-kubernetes-apiserver-
endpoint-ci-ln-x5sv9rb-f76d1-4rgrp-master-2 75m
network-check-source-ci-ln-x5sv9rb-f76d1-4rgrp-worker-b-6xdmh-to-kubernetes-apiserver-
service-cluster                               75m
network-check-source-ci-ln-x5sv9rb-f76d1-4rgrp-worker-b-6xdmh-to-kubernetes-default-
service-cluster                               75m
network-check-source-ci-ln-x5sv9rb-f76d1-4rgrp-worker-b-6xdmh-to-load-balancer-api-
external                                     75m
network-check-source-ci-ln-x5sv9rb-f76d1-4rgrp-worker-b-6xdmh-to-load-balancer-api-
internal                                     75m
network-check-source-ci-ln-x5sv9rb-f76d1-4rgrp-worker-b-6xdmh-to-network-check-target-ci-
ln-x5sv9rb-f76d1-4rgrp-master-0             75m
network-check-source-ci-ln-x5sv9rb-f76d1-4rgrp-worker-b-6xdmh-to-network-check-target-ci-

```

```

ln-x5sv9rb-f76d1-4rzrp-master-1      75m
network-check-source-ci-ln-x5sv9rb-f76d1-4rzrp-worker-b-6xdmh-to-network-check-target-ci-
ln-x5sv9rb-f76d1-4rzrp-master-2      75m
network-check-source-ci-ln-x5sv9rb-f76d1-4rzrp-worker-b-6xdmh-to-network-check-target-ci-
ln-x5sv9rb-f76d1-4rzrp-worker-b-6xdmh  74m
network-check-source-ci-ln-x5sv9rb-f76d1-4rzrp-worker-b-6xdmh-to-network-check-target-ci-
ln-x5sv9rb-f76d1-4rzrp-worker-c-n8mbf  74m
network-check-source-ci-ln-x5sv9rb-f76d1-4rzrp-worker-b-6xdmh-to-network-check-target-ci-
ln-x5sv9rb-f76d1-4rzrp-worker-d-4hnrz  74m
network-check-source-ci-ln-x5sv9rb-f76d1-4rzrp-worker-b-6xdmh-to-network-check-target-
service-cluster                       75m
network-check-source-ci-ln-x5sv9rb-f76d1-4rzrp-worker-b-6xdmh-to-openshift-apiserver-
endpoint-ci-ln-x5sv9rb-f76d1-4rzrp-master-0 75m
network-check-source-ci-ln-x5sv9rb-f76d1-4rzrp-worker-b-6xdmh-to-openshift-apiserver-
endpoint-ci-ln-x5sv9rb-f76d1-4rzrp-master-1 75m
network-check-source-ci-ln-x5sv9rb-f76d1-4rzrp-worker-b-6xdmh-to-openshift-apiserver-
endpoint-ci-ln-x5sv9rb-f76d1-4rzrp-master-2 74m
network-check-source-ci-ln-x5sv9rb-f76d1-4rzrp-worker-b-6xdmh-to-openshift-apiserver-
service-cluster                       75m

```

2. View the connection test logs:

- a. From the output of the previous command, identify the endpoint that you want to review the connectivity logs for.
- b. To view the object, enter the following command:

```
$ oc get podnetworkconnectivitycheck <name> \
-n openshift-network-diagnostics -o yaml
```

where **<name>** specifies the name of the **PodNetworkConnectivityCheck** object.

Example output

```

apiVersion: controlplane.operator.openshift.io/v1alpha1
kind: PodNetworkConnectivityCheck
metadata:
  name: network-check-source-ci-ln-x5sv9rb-f76d1-4rzrp-worker-b-6xdmh-to-kubernetes-
apiserver-endpoint-ci-ln-x5sv9rb-f76d1-4rzrp-master-0
  namespace: openshift-network-diagnostics
  ...
spec:
  sourcePod: network-check-source-7c88f6d9f-hmg2f
  targetEndpoint: 10.0.0.4:6443
  tlsClientCert:
    name: ""
status:
  conditions:
  - lastTransitionTime: "2021-01-13T20:11:34Z"
    message: 'kubernetes-apiserver-endpoint-ci-ln-x5sv9rb-f76d1-4rzrp-master-0: tcp
    connection to 10.0.0.4:6443 succeeded'
    reason: TCPConnectSuccess
    status: "True"
    type: Reachable
  failures:
  - latency: 2.241775ms

```

```
message: 'kubernetes-apiserver-endpoint-ci-ln-x5sv9rb-f76d1-4rzrp-master-0: failed
  to establish a TCP connection to 10.0.0.4:6443: dial tcp 10.0.0.4:6443: connect:
  connection refused'
reason: TCPConnectError
success: false
time: "2021-01-13T20:10:34Z"
- latency: 2.582129ms
message: 'kubernetes-apiserver-endpoint-ci-ln-x5sv9rb-f76d1-4rzrp-master-0: failed
  to establish a TCP connection to 10.0.0.4:6443: dial tcp 10.0.0.4:6443: connect:
  connection refused'
reason: TCPConnectError
success: false
time: "2021-01-13T20:09:34Z"
- latency: 3.483578ms
message: 'kubernetes-apiserver-endpoint-ci-ln-x5sv9rb-f76d1-4rzrp-master-0: failed
  to establish a TCP connection to 10.0.0.4:6443: dial tcp 10.0.0.4:6443: connect:
  connection refused'
reason: TCPConnectError
success: false
time: "2021-01-13T20:08:34Z"
outages:
- end: "2021-01-13T20:11:34Z"
endLogs:
- latency: 2.032018ms
  message: 'kubernetes-apiserver-endpoint-ci-ln-x5sv9rb-f76d1-4rzrp-master-0:
    tcp connection to 10.0.0.4:6443 succeeded'
  reason: TCPConnect
  success: true
  time: "2021-01-13T20:11:34Z"
- latency: 2.241775ms
  message: 'kubernetes-apiserver-endpoint-ci-ln-x5sv9rb-f76d1-4rzrp-master-0:
    failed to establish a TCP connection to 10.0.0.4:6443: dial tcp 10.0.0.4:6443:
    connect: connection refused'
  reason: TCPConnectError
  success: false
  time: "2021-01-13T20:10:34Z"
- latency: 2.582129ms
  message: 'kubernetes-apiserver-endpoint-ci-ln-x5sv9rb-f76d1-4rzrp-master-0:
    failed to establish a TCP connection to 10.0.0.4:6443: dial tcp 10.0.0.4:6443:
    connect: connection refused'
  reason: TCPConnectError
  success: false
  time: "2021-01-13T20:09:34Z"
- latency: 3.483578ms
  message: 'kubernetes-apiserver-endpoint-ci-ln-x5sv9rb-f76d1-4rzrp-master-0:
    failed to establish a TCP connection to 10.0.0.4:6443: dial tcp 10.0.0.4:6443:
    connect: connection refused'
  reason: TCPConnectError
  success: false
  time: "2021-01-13T20:08:34Z"
message: Connectivity restored after 2m59.999789186s
start: "2021-01-13T20:08:34Z"
startLogs:
- latency: 3.483578ms
  message: 'kubernetes-apiserver-endpoint-ci-ln-x5sv9rb-f76d1-4rzrp-master-0:
    failed to establish a TCP connection to 10.0.0.4:6443: dial tcp 10.0.0.4:6443:
```

```
    connect: connection refused'
    reason: TCPConnectError
    success: false
    time: "2021-01-13T20:08:34Z"
successes:
- latency: 2.845865ms
  message: 'kubernetes-apiserver-endpoint-ci-ln-x5sv9rb-f76d1-4rzrp-master-0: tcp
    connection to 10.0.0.4:6443 succeeded'
  reason: TCPConnect
  success: true
  time: "2021-01-13T21:14:34Z"
- latency: 2.926345ms
  message: 'kubernetes-apiserver-endpoint-ci-ln-x5sv9rb-f76d1-4rzrp-master-0: tcp
    connection to 10.0.0.4:6443 succeeded'
  reason: TCPConnect
  success: true
  time: "2021-01-13T21:13:34Z"
- latency: 2.895796ms
  message: 'kubernetes-apiserver-endpoint-ci-ln-x5sv9rb-f76d1-4rzrp-master-0: tcp
    connection to 10.0.0.4:6443 succeeded'
  reason: TCPConnect
  success: true
  time: "2021-01-13T21:12:34Z"
- latency: 2.696844ms
  message: 'kubernetes-apiserver-endpoint-ci-ln-x5sv9rb-f76d1-4rzrp-master-0: tcp
    connection to 10.0.0.4:6443 succeeded'
  reason: TCPConnect
  success: true
  time: "2021-01-13T21:11:34Z"
- latency: 1.502064ms
  message: 'kubernetes-apiserver-endpoint-ci-ln-x5sv9rb-f76d1-4rzrp-master-0: tcp
    connection to 10.0.0.4:6443 succeeded'
  reason: TCPConnect
  success: true
  time: "2021-01-13T21:10:34Z"
- latency: 1.388857ms
  message: 'kubernetes-apiserver-endpoint-ci-ln-x5sv9rb-f76d1-4rzrp-master-0: tcp
    connection to 10.0.0.4:6443 succeeded'
  reason: TCPConnect
  success: true
  time: "2021-01-13T21:09:34Z"
- latency: 1.906383ms
  message: 'kubernetes-apiserver-endpoint-ci-ln-x5sv9rb-f76d1-4rzrp-master-0: tcp
    connection to 10.0.0.4:6443 succeeded'
  reason: TCPConnect
  success: true
  time: "2021-01-13T21:08:34Z"
- latency: 2.089073ms
  message: 'kubernetes-apiserver-endpoint-ci-ln-x5sv9rb-f76d1-4rzrp-master-0: tcp
    connection to 10.0.0.4:6443 succeeded'
  reason: TCPConnect
  success: true
  time: "2021-01-13T21:07:34Z"
- latency: 2.156994ms
  message: 'kubernetes-apiserver-endpoint-ci-ln-x5sv9rb-f76d1-4rzrp-master-0: tcp
    connection to 10.0.0.4:6443 succeeded'
```

```
reason: TCPConnect
success: true
time: "2021-01-13T21:06:34Z"
- latency: 1.777043ms
message: 'kubernetes-apiserver-endpoint-ci-ln-x5sv9rb-f76d1-4rzrp-master-0: tcp
  connection to 10.0.0.4:6443 succeeded'
reason: TCPConnect
success: true
time: "2021-01-13T21:05:34Z"
```

CHAPTER 15. CHANGING THE MTU FOR THE CLUSTER NETWORK

As a cluster administrator, you can change the MTU for the cluster network after cluster installation. This change is disruptive as cluster nodes must be rebooted to finalize the MTU change. You can change the MTU only for clusters using the OVN-Kubernetes or OpenShift SDN network plugins.

15.1. ABOUT THE CLUSTER MTU

During installation the maximum transmission unit (MTU) for the cluster network is detected automatically based on the MTU of the primary network interface of nodes in the cluster. You do not usually need to override the detected MTU.

You might want to change the MTU of the cluster network for several reasons:

- The MTU detected during cluster installation is not correct for your infrastructure.
- Your cluster infrastructure now requires a different MTU, such as from the addition of nodes that need a different MTU for optimal performance.

Only the OVN-Kubernetes cluster network plugin supports changing the MTU value.

15.1.1. Service interruption considerations

When you initiate an MTU change on your cluster the following effects might impact service availability:

- At least two rolling reboots are required to complete the migration to a new MTU. During this time, some nodes are not available as they restart.
- Specific applications deployed to the cluster with shorter timeout intervals than the absolute TCP timeout interval might experience disruption during the MTU change.

15.1.2. MTU value selection

When planning your MTU migration there are two related but distinct MTU values to consider.

- **Hardware MTU:** This MTU value is set based on the specifics of your network infrastructure.
- **Cluster network MTU:** This MTU value is always less than your hardware MTU to account for the cluster network overlay overhead. The specific overhead is determined by your network plugin. For OVN-Kubernetes, the overhead is **100** bytes.

If your cluster requires different MTU values for different nodes, you must subtract the overhead value for your network plugin from the lowest MTU value that is used by any node in your cluster. For example, if some nodes in your cluster have an MTU of **9001**, and some have an MTU of **1500**, you must set this value to **1400**.



IMPORTANT

To avoid selecting an MTU value that is not acceptable by a node, verify the maximum MTU value (**maxmtu**) that is accepted by the network interface by using the **ip -d link** command.

15.1.3. How the migration process works

The following table summarizes the migration process by segmenting between the user-initiated steps in the process and the actions that the migration performs in response.

Table 15.1. Live migration of the cluster MTU

User-initiated steps	OpenShift Container Platform activity
<p>Set the following values in the Cluster Network Operator configuration:</p> <ul style="list-style-type: none"> ● spec.migration.mtu.machine.to ● spec.migration.mtu.network.from ● spec.migration.mtu.network.to 	<p>Cluster Network Operator (CNO) Confirms that each field is set to a valid value.</p> <ul style="list-style-type: none"> ● The mtu.machine.to must be set to either the new hardware MTU or to the current hardware MTU if the MTU for the hardware is not changing. This value is transient and is used as part of the migration process. Separately, if you specify a hardware MTU that is different from your existing hardware MTU value, you must manually configure the MTU to persist by other means, such as with a machine config, DHCP setting, or a Linux kernel command line. ● The mtu.network.from field must equal the network.status.clusterNetworkMTU field, which is the current MTU of the cluster network. ● The mtu.network.to field must be set to the target cluster network MTU and must be lower than the hardware MTU to allow for the overlay overhead of the network plugin. For OVN-Kubernetes, the overhead is 100 bytes. <p>If the values provided are valid, the CNO writes out a new temporary configuration with the MTU for the cluster network set to the value of the mtu.network.to field.</p> <p>Machine Config Operator (MCO) Performs a rolling reboot of each node in the cluster.</p>
<p>Reconfigure the MTU of the primary network interface for the nodes on the cluster. You can use a variety of methods to accomplish this, including:</p> <ul style="list-style-type: none"> ● Deploying a new NetworkManager connection profile with the MTU change ● Changing the MTU through a DHCP server setting ● Changing the MTU through boot parameters 	<p>N/A</p>
<p>Set the mtu value in the CNO configuration for the network plugin and set spec.migration to null.</p>	<p>Machine Config Operator (MCO) Performs a rolling reboot of each node in the cluster with the new MTU configuration.</p>

15.2. CHANGING THE CLUSTER NETWORK MTU

As a cluster administrator, you can increase or decrease the maximum transmission unit (MTU) for your cluster.



IMPORTANT

The migration is disruptive and nodes in your cluster might be temporarily unavailable as the MTU update takes effect.

The following procedure describes how to change the cluster network MTU by using either machine configs, Dynamic Host Configuration Protocol (DHCP), or an ISO image. If you use either the DHCP or ISO approaches, you must refer to configuration artifacts that you kept after installing your cluster to complete the procedure.

Prerequisites

- You have installed the OpenShift CLI (**oc**).
- You have access to the cluster using an account with **cluster-admin** permissions.
- You have identified the target MTU for your cluster. The MTU for the OVN-Kubernetes network plugin must be set to **100** less than the lowest hardware MTU value in your cluster.

Procedure

1. To obtain the current MTU for the cluster network, enter the following command:

```
$ oc describe network.config cluster
```

Example output

```
...
Status:
Cluster Network:
  Cidr:          10.217.0.0/22
  Host Prefix:   23
  Cluster Network MTU: 1400
  Network Type:  OVNKubernetes
  Service Network:
    10.217.4.0/23
...
```

2. Prepare your configuration for the hardware MTU:
 - If your hardware MTU is specified with DHCP, update your DHCP configuration such as with the following dnsmasq configuration:

```
dhcp-option-force=26,<mtu>
```

where:

<mtu>

Specifies the hardware MTU for the DHCP server to advertise.

- If your hardware MTU is specified with a kernel command line with PXE, update that configuration accordingly.
- If your hardware MTU is specified in a NetworkManager connection configuration, complete the following steps. This approach is the default for OpenShift Container Platform if you do not explicitly specify your network configuration with DHCP, a kernel command line, or some other method. Your cluster nodes must all use the same underlying network configuration for the following procedure to work unmodified.

i. Find the primary network interface:

- If you are using the OpenShift SDN network plugin, enter the following command:

```
$ oc debug node/<node_name> -- chroot /host ip route list match 0.0.0.0/0 | awk '{print $5}'
```

where:

<node_name>

Specifies the name of a node in your cluster.

- If you are using the OVN-Kubernetes network plugin, enter the following command:

```
$ oc debug node/<node_name> -- chroot /host nmcli -g connection.interface-name c show ovs-if-phys0
```

where:

<node_name>

Specifies the name of a node in your cluster.

ii. Create the following NetworkManager configuration in the **<interface>-mtu.conf** file:

Example NetworkManager connection configuration

```
[connection-<interface>-mtu]
match-device=interface-name:<interface>
ethernet.mtu=<mtu>
```

where:

<mtu>

Specifies the new hardware MTU value.

<interface>

Specifies the primary network interface name.

iii. Create two **MachineConfig** objects, one for the control plane nodes and another for the worker nodes in your cluster:

- A. Create the following Butane config in the **control-plane-interface.bu** file:

```
variant: openshift
```

```

version: 4.15.0
metadata:
  name: 01-control-plane-interface
  labels:
    machineconfiguration.openshift.io/role: master
storage:
  files:
    - path: /etc/NetworkManager/conf.d/99-<interface>-mtu.conf 1
      contents:
        local: <interface>-mtu.conf 2
      mode: 0600

```

- 1** **1** Specify the NetworkManager connection name for the primary network interface.
- 2** Specify the local filename for the updated NetworkManager configuration file from the previous step.

B. Create the following Butane config in the **worker-interface.bu** file:

```

variant: openshift
version: 4.15.0
metadata:
  name: 01-worker-interface
  labels:
    machineconfiguration.openshift.io/role: worker
storage:
  files:
    - path: /etc/NetworkManager/conf.d/99-<interface>-mtu.conf 1
      contents:
        local: <interface>-mtu.conf 2
      mode: 0600

```

- 1** Specify the NetworkManager connection name for the primary network interface.
- 2** Specify the local filename for the updated NetworkManager configuration file from the previous step.

C. Create **MachineConfig** objects from the Butane configs by running the following command:

```

$ for manifest in control-plane-interface worker-interface; do
  butane --files-dir . $manifest.bu > $manifest.yaml
done

```

**WARNING**

Do not apply these machine configs until explicitly instructed later in this procedure. Applying these machine configs now causes a loss of stability for the cluster.

- To begin the MTU migration, specify the migration configuration by entering the following command. The Machine Config Operator performs a rolling reboot of the nodes in the cluster in preparation for the MTU change.

```
$ oc patch Network.operator.openshift.io cluster --type=merge --patch \
  '{"spec": {"migration": {"mtu": {"network": {"from": <overlay_from>, "to": <overlay_to> } ,
  "machine": {"to" : <machine_to> } } } }'
```

where:

<overlay_from>

Specifies the current cluster network MTU value.

<overlay_to>

Specifies the target MTU for the cluster network. This value is set relative to the value of **<machine_to>**. For OVN-Kubernetes, this value must be **100** less than the value of **<machine_to>**.

<machine_to>

Specifies the MTU for the primary network interface on the underlying host network.

Example that increases the cluster MTU

```
$ oc patch Network.operator.openshift.io cluster --type=merge --patch \
  '{"spec": {"migration": {"mtu": {"network": {"from": 1400, "to": 9000 } , "machine": {"to" :
  9100} } } }'
```

- As the Machine Config Operator updates machines in each machine config pool, it reboots each node one by one. You must wait until all the nodes are updated. Check the machine config pool status by entering the following command:

```
$ oc get machineconfigpools
```

A successfully updated node has the following status: **UPDATED=true, UPDATING=false, DEGRADED=false**.

**NOTE**

By default, the Machine Config Operator updates one machine per pool at a time, causing the total time the migration takes to increase with the size of the cluster.

- Confirm the status of the new machine configuration on the hosts:

- a. To list the machine configuration state and the name of the applied machine configuration, enter the following command:

```
$ oc describe node | egrep "hostname|machineconfig"
```

Example output

```
kubernetes.io/hostname=master-0
machineconfiguration.openshift.io/currentConfig: rendered-master-
c53e221d9d24e1c8bb6ee89dd3d8ad7b
machineconfiguration.openshift.io/desiredConfig: rendered-master-
c53e221d9d24e1c8bb6ee89dd3d8ad7b
machineconfiguration.openshift.io/reason:
machineconfiguration.openshift.io/state: Done
```

- b. Verify that the following statements are true:

- The value of **machineconfiguration.openshift.io/state** field is **Done**.
- The value of the **machineconfiguration.openshift.io/currentConfig** field is equal to the value of the **machineconfiguration.openshift.io/desiredConfig** field.

- c. To confirm that the machine config is correct, enter the following command:

```
$ oc get machineconfig <config_name> -o yaml | grep ExecStart
```

where **<config_name>** is the name of the machine config from the **machineconfiguration.openshift.io/currentConfig** field.

The machine config must include the following update to the systemd configuration:

```
ExecStart=/usr/local/bin/mtu-migration.sh
```

6. Update the underlying network interface MTU value:

- If you are specifying the new MTU with a NetworkManager connection configuration, enter the following command. The MachineConfig Operator automatically performs a rolling reboot of the nodes in your cluster.

```
$ for manifest in control-plane-interface worker-interface; do
  oc create -f $manifest.yaml
done
```

- If you are specifying the new MTU with a DHCP server option or a kernel command line and PXE, make the necessary changes for your infrastructure.

7. As the Machine Config Operator updates machines in each machine config pool, it reboots each node one by one. You must wait until all the nodes are updated. Check the machine config pool status by entering the following command:

```
$ oc get machineconfigpools
```

A successfully updated node has the following status: **UPDATED=true, UPDATING=false, DEGRADED=false**.

**NOTE**

By default, the Machine Config Operator updates one machine per pool at a time, causing the total time the migration takes to increase with the size of the cluster.

8. Confirm the status of the new machine configuration on the hosts:
 - a. To list the machine configuration state and the name of the applied machine configuration, enter the following command:

```
$ oc describe node | egrep "hostname|machineconfig"
```

Example output

```
kubernetes.io/hostname=master-0
machineconfiguration.openshift.io/currentConfig: rendered-master-
c53e221d9d24e1c8bb6ee89dd3d8ad7b
machineconfiguration.openshift.io/desiredConfig: rendered-master-
c53e221d9d24e1c8bb6ee89dd3d8ad7b
machineconfiguration.openshift.io/reason:
machineconfiguration.openshift.io/state: Done
```

Verify that the following statements are true:

- The value of **machineconfiguration.openshift.io/state** field is **Done**.
- The value of the **machineconfiguration.openshift.io/currentConfig** field is equal to the value of the **machineconfiguration.openshift.io/desiredConfig** field.

- b. To confirm that the machine config is correct, enter the following command:

```
$ oc get machineconfig <config_name> -o yaml | grep path:
```

where **<config_name>** is the name of the machine config from the **machineconfiguration.openshift.io/currentConfig** field.

If the machine config is successfully deployed, the previous output contains the **/etc/NetworkManager/conf.d/99-<interface>-mtu.conf** file path and the **ExecStart=/usr/local/bin/mtu-migration.sh** line.

9. To finalize the MTU migration, enter the following command for the OVN-Kubernetes network plugin:

```
$ oc patch Network.operator.openshift.io cluster --type=merge --patch \
  '{"spec": {"migration": null, "defaultNetwork": {"ovnKubernetesConfig": {"mtu": <mtu> }}}}'
```

where:

<mtu>

Specifies the new cluster network MTU that you specified with **<overlay_to>**.

10. After finalizing the MTU migration, each machine config pool node is rebooted one by one. You must wait until all the nodes are updated. Check the machine config pool status by entering the following command:

```
$ oc get machineconfigpools
```

A successfully updated node has the following status: **UPDATED=true, UPDATING=false, DEGRADED=false**.

Verification

1. To get the current MTU for the cluster network, enter the following command:

```
$ oc describe network.config cluster
```

2. Get the current MTU for the primary network interface of a node:
 - a. To list the nodes in your cluster, enter the following command:

```
$ oc get nodes
```

- b. To obtain the current MTU setting for the primary network interface on a node, enter the following command:

```
$ oc debug node/<node> -- chroot /host ip address show <interface>
```

where:

<node>

Specifies a node from the output from the previous step.

<interface>

Specifies the primary network interface name for the node.

Example output

```
ens3: <BROADCAST,MULTICAST,UP,LOWER_UP> mtu 8051
```

15.3. ADDITIONAL RESOURCES

- [Using advanced networking options for PXE and ISO installations](#)
- [Manually creating NetworkManager profiles in key file format](#)
- [Configuring a dynamic Ethernet connection using nmcli](#)

CHAPTER 16. CONFIGURING THE NODE PORT SERVICE RANGE

As a cluster administrator, you can expand the available node port range. If your cluster uses a large number of node ports, you might need to increase the number of available ports.

The default port range is **30000-32767**. You can never reduce the port range, even if you first expand it beyond the default range.

16.1. PREREQUISITES

- Your cluster infrastructure must allow access to the ports that you specify within the expanded range. For example, if you expand the node port range to **30000-32900**, the inclusive port range of **32768-32900** must be allowed by your firewall or packet filtering configuration.

16.2. EXPANDING THE NODE PORT RANGE

You can expand the node port range for the cluster.

Prerequisites

- Install the OpenShift CLI (**oc**).
- Log in to the cluster with a user with **cluster-admin** privileges.

Procedure

1. To expand the node port range, enter the following command. Replace **<port>** with the largest port number in the new range.

```
$ oc patch network.config.openshift.io cluster --type=merge -p \
  '{
    "spec":
      { "serviceNodePortRange": "30000-<port>" }
  }'
```

TIP

You can alternatively apply the following YAML to update the node port range:

```
apiVersion: config.openshift.io/v1
kind: Network
metadata:
  name: cluster
spec:
  serviceNodePortRange: "30000-<port>"
```

Example output

```
network.config.openshift.io/cluster patched
```

2. To confirm that the configuration is active, enter the following command. It can take several minutes for the update to apply.

```
$ oc get configmaps -n openshift-kube-apiserver config \
  -o jsonpath="{.data['config\.yaml']}" | \
  grep -Eo "service-node-port-range":"[[:digit:]]+-[[:digit:]]+"
```

Example output

```
"service-node-port-range":["30000-33000"]
```

16.3. ADDITIONAL RESOURCES

- [Configuring ingress cluster traffic using a NodePort](#)
- [Network \[config.openshift.io/v1\]](#)
- [Service \[core/v1\]](#)

CHAPTER 17. CONFIGURING THE CLUSTER NETWORK RANGE

As a cluster administrator, you can expand the cluster network range after cluster installation. You might want to expand the cluster network range if you need more IP addresses for additional nodes.

For example, if you deployed a cluster and specified **10.128.0.0/19** as the cluster network range and a host prefix of **23**, you are limited to 16 nodes. You can expand that to 510 nodes by changing the CIDR mask on a cluster to **/14**.

When expanding the cluster network address range, your cluster must use the [OVN-Kubernetes network plugin](#). Other network plugins are not supported.

The following limitations apply when modifying the cluster network IP address range:

- The CIDR mask size specified must always be smaller than the currently configured CIDR mask size, because you can only increase IP space by adding more nodes to an installed cluster
- The host prefix cannot be modified
- Pods that are configured with an overridden default gateway must be recreated after the cluster network expands

17.1. EXPANDING THE CLUSTER NETWORK IP ADDRESS RANGE

You can expand the IP address range for the cluster network. Because this change requires rolling out a new Operator configuration across the cluster, it can take up to 30 minutes to take effect.

Prerequisites

- Install the OpenShift CLI (**oc**).
- Log in to the cluster with a user with **cluster-admin** privileges.
- Ensure that the cluster uses the OVN-Kubernetes network plugin.

Procedure

1. To obtain the cluster network range and host prefix for your cluster, enter the following command:

```
$ oc get network.operator.openshift.io \
  -o jsonpath="{.items[0].spec.clusterNetwork}"
```

Example output

```
[{"cidr":"10.217.0.0/22","hostPrefix":23}]
```

2. To expand the cluster network IP address range, enter the following command. Use the CIDR IP address range and host prefix returned from the output of the previous command.

```
$ oc patch Network.config.openshift.io cluster --type='merge' --patch \
  '{
  "spec":{
    "clusterNetwork": [ {"cidr": "<network>/<cidr>", "hostPrefix": <prefix> } ],
```

```
"networkType": "OVNKubernetes"
  }
}'
```

where:

<network>

Specifies the network part of the **cidr** field that you obtained from the previous step. You cannot change this value.

<cidr>

Specifies the network prefix length. For example, **14**. Change this value to a smaller number than the value from the output in the previous step to expand the cluster network range.

<prefix>

Specifies the current host prefix for your cluster. This value must be the same value for the **hostPrefix** field that you obtained from the previous step.

Example command

```
$ oc patch Network.config.openshift.io cluster --type='merge' --patch \
  {
  "spec":{
    "clusterNetwork": [ {"cidr":"10.217.0.0/14","hostPrefix": 23} ],
    "networkType": "OVNKubernetes"
  }
}'
```

Example output

```
network.config.openshift.io/cluster patched
```

3. To confirm that the configuration is active, enter the following command. It can take up to 30 minutes for this change to take effect.

```
$ oc get network.operator.openshift.io \
  -o jsonpath="{.items[0].spec.clusterNetwork}"
```

Example output

```
[{"cidr":"10.217.0.0/14","hostPrefix":23}]
```

17.2. ADDITIONAL RESOURCES

- [Red Hat OpenShift Network Calculator](#)
- [About the OVN-Kubernetes network plugin](#)

CHAPTER 18. CONFIGURING IP FAILOVER

This topic describes configuring IP failover for pods and services on your OpenShift Container Platform cluster.

IP failover uses [Keepalived](#) to host a set of externally accessible Virtual IP (VIP) addresses on a set of hosts. Each VIP address is only serviced by a single host at a time. Keepalived uses the Virtual Router Redundancy Protocol (VRRP) to determine which host, from the set of hosts, services which VIP. If a host becomes unavailable, or if the service that Keepalived is watching does not respond, the VIP is switched to another host from the set. This means a VIP is always serviced as long as a host is available.

Every VIP in the set is serviced by a node selected from the set. If a single node is available, the VIPs are served. There is no way to explicitly distribute the VIPs over the nodes, so there can be nodes with no VIPs and other nodes with many VIPs. If there is only one node, all VIPs are on it.

The administrator must ensure that all of the VIP addresses meet the following requirements:

- Accessible on the configured hosts from outside the cluster.
- Not used for any other purpose within the cluster.

Keepalived on each node determines whether the needed service is running. If it is, VIPs are supported and Keepalived participates in the negotiation to determine which node serves the VIP. For a node to participate, the service must be listening on the watch port on a VIP or the check must be disabled.

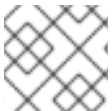

NOTE

Each VIP in the set might be served by a different node.

IP failover monitors a port on each VIP to determine whether the port is reachable on the node. If the port is not reachable, the VIP is not assigned to the node. If the port is set to **0**, this check is suppressed. The check script does the needed testing.

When a node running Keepalived passes the check script, the VIP on that node can enter the **master** state based on its priority and the priority of the current master and as determined by the preemption strategy.

A cluster administrator can provide a script through the **OPENSIFT_HA_NOTIFY_SCRIPT** variable, and this script is called whenever the state of the VIP on the node changes. Keepalived uses the **master** state when it is servicing the VIP, the **backup** state when another node is servicing the VIP, or in the **fault** state when the check script fails. The notify script is called with the new state whenever the state changes.

You can create an IP failover deployment configuration on OpenShift Container Platform. The IP failover deployment configuration specifies the set of VIP addresses, and the set of nodes on which to service them. A cluster can have multiple IP failover deployment configurations, with each managing its own set of unique VIP addresses. Each node in the IP failover configuration runs an IP failover pod, and this pod runs Keepalived.

When using VIPs to access a pod with host networking, the application pod runs on all nodes that are running the IP failover pods. This enables any of the IP failover nodes to become the master and service the VIPs when needed. If application pods are not running on all nodes with IP failover, either some IP failover nodes never service the VIPs or some application pods never receive any traffic. Use the same selector and replication count, for both IP failover and the application pods, to avoid this mismatch.

While using VIPs to access a service, any of the nodes can be in the IP failover set of nodes, since the

service is reachable on all nodes, no matter where the application pod is running. Any of the IP failover nodes can become master at any time. The service can either use external IPs and a service port or it can use a **NodePort**. Setting up a **NodePort** is a privileged operation.

When using external IPs in the service definition, the VIPs are set to the external IPs, and the IP failover monitoring port is set to the service port. When using a node port, the port is open on every node in the cluster, and the service load-balances traffic from whatever node currently services the VIP. In this case, the IP failover monitoring port is set to the **NodePort** in the service definition.



IMPORTANT

Even though a service VIP is highly available, performance can still be affected. Keepalived makes sure that each of the VIPs is serviced by some node in the configuration, and several VIPs can end up on the same node even when other nodes have none. Strategies that externally load-balance across a set of VIPs can be thwarted when IP failover puts multiple VIPs on the same node.

When you use **ExternalIP**, you can set up IP failover to have the same VIP range as the **ExternalIP** range. You can also disable the monitoring port. In this case, all of the VIPs appear on same node in the cluster. Any user can set up a service with an **ExternalIP** and make it highly available.

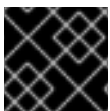

IMPORTANT

There are a maximum of 254 VIPs in the cluster.

18.1. IP FAILOVER ENVIRONMENT VARIABLES

The following table contains the variables used to configure IP failover.

Table 18.1. IP failover environment variables

Variable Name	Default	Description
OPENSIFT_HA_MONITOR_PORT	80	The IP failover pod tries to open a TCP connection to this port on each Virtual IP (VIP). If connection is established, the service is considered to be running. If this port is set to 0 , the test always passes.
OPENSIFT_HA_NETWORK_INTERFACE		The interface name that IP failover uses to send Virtual Router Redundancy Protocol (VRRP) traffic. The default value is eth0 .
OPENSIFT_HA_REPLICA_COUNT	2	The number of replicas to create. This must match spec.replicas value in IP failover deployment configuration.
OPENSIFT_HA_VIRTUAL_IPS		The list of IP address ranges to replicate. This must be provided. For example, 1.2.3.4-6,1.2.3.9 .

Variable Name	Default	Description
OPENSIFT_HA_VRRP_ID_OFFSET	0	The offset value used to set the virtual router IDs. Using different offset values allows multiple IP failover configurations to exist within the same cluster. The default offset is 0 , and the allowed range is 0 through 255 .
OPENSIFT_HA_VIP_GROUPS		The number of groups to create for VRRP. If not set, a group is created for each virtual IP range specified with the OPENSIFT_HA_VIP_GROUPS variable.
OPENSIFT_HA_IPTABLES_CHAIN	INPUT	The name of the iptables chain, to automatically add an iptables rule to allow the VRRP traffic on. If the value is not set, an iptables rule is not added. If the chain does not exist, it is not created.
OPENSIFT_HA_CHECK_SCRIPT		The full path name in the pod file system of a script that is periodically run to verify the application is operating.
OPENSIFT_HA_CHECK_INTERVAL	2	The period, in seconds, that the check script is run.
OPENSIFT_HA_NOTIFY_SCRIPT		The full path name in the pod file system of a script that is run whenever the state changes.
OPENSIFT_HA_PREEMPTION	preempt_nodelay 300	The strategy for handling a new higher priority host. The nopreempt strategy does not move master from the lower priority host to the higher priority host.

18.2. CONFIGURING IP FAILOVER IN YOUR CLUSTER

As a cluster administrator, you can configure IP failover on an entire cluster, or on a subset of nodes, as defined by the label selector. You can also configure multiple IP failover deployment configurations in your cluster, where each one is independent of the others.

The IP failover deployment configuration ensures that a failover pod runs on each of the nodes matching the constraints or the label used.

This pod runs Keepalived, which can monitor an endpoint and use Virtual Router Redundancy Protocol (VRRP) to fail over the virtual IP (VIP) from one node to another if the first node cannot reach the service or endpoint.

For production use, set a **selector** that selects at least two nodes, and set **replicas** equal to the number of selected nodes.

Prerequisites

- You are logged in to the cluster with a user with **cluster-admin** privileges.

- You created a pull secret.

Procedure

1. Create an IP failover service account:

```
$ oc create sa ipfailover
```

2. Update security context constraints (SCC) for **hostNetwork**:

```
$ oc adm policy add-scc-to-user privileged -z ipfailover
```

```
$ oc adm policy add-scc-to-user hostnetwork -z ipfailover
```

3. Create a deployment YAML file to configure IP failover:

Example deployment YAML for IP failover configuration

```
apiVersion: apps/v1
kind: Deployment
metadata:
  name: ipfailover-keepalived 1
  labels:
    ipfailover: hello-openshift
spec:
  strategy:
    type: Recreate
  replicas: 2
  selector:
    matchLabels:
      ipfailover: hello-openshift
  template:
    metadata:
      labels:
        ipfailover: hello-openshift
    spec:
      serviceAccountName: ipfailover
      privileged: true
      hostNetwork: true
      nodeSelector:
        node-role.kubernetes.io/worker: ""
      containers:
        - name: openshift-ipfailover
          image: quay.io/openshift/origin-keepalived-ipfailover
          ports:
            - containerPort: 63000
              hostPort: 63000
          imagePullPolicy: IfNotPresent
          securityContext:
            privileged: true
          volumeMounts:
            - name: lib-modules
              mountPath: /lib/modules
              readOnly: true
```

```

- name: host-slash
  mountPath: /host
  readOnly: true
  mountPropagation: HostToContainer
- name: etc-sysconfig
  mountPath: /etc/sysconfig
  readOnly: true
- name: config-volume
  mountPath: /etc/keepalive
env:
- name: OPENSIFT_HA_CONFIG_NAME
  value: "ipfailover"
- name: OPENSIFT_HA_VIRTUAL_IPS 2
  value: "1.1.1.1-2"
- name: OPENSIFT_HA_VIP_GROUPS 3
  value: "10"
- name: OPENSIFT_HA_NETWORK_INTERFACE 4
  value: "ens3" #The host interface to assign the VIPs
- name: OPENSIFT_HA_MONITOR_PORT 5
  value: "30060"
- name: OPENSIFT_HA_VRRP_ID_OFFSET 6
  value: "0"
- name: OPENSIFT_HA_REPLICA_COUNT 7
  value: "2" #Must match the number of replicas in the deployment
- name: OPENSIFT_HA_USE_UNICAST
  value: "false"
#- name: OPENSIFT_HA_UNICAST_PEERS
  #value: "10.0.148.40,10.0.160.234,10.0.199.110"
- name: OPENSIFT_HA_IPTABLES_CHAIN 8
  value: "INPUT"
#- name: OPENSIFT_HA_NOTIFY_SCRIPT 9
# value: /etc/keepalive/mynotifyscript.sh
- name: OPENSIFT_HA_CHECK_SCRIPT 10
  value: "/etc/keepalive/mycheckscript.sh"
- name: OPENSIFT_HA_PREEMPTION 11
  value: "preempt_delay 300"
- name: OPENSIFT_HA_CHECK_INTERVAL 12
  value: "2"
livenessProbe:
  initialDelaySeconds: 10
  exec:
    command:
      - pgrep
      - keepalived
volumes:
- name: lib-modules
  hostPath:
    path: /lib/modules
- name: host-slash
  hostPath:
    path: /
- name: etc-sysconfig
  hostPath:
    path: /etc/sysconfig
# config-volume contains the check script

```

```
# created with `oc create configmap keepalived-checkscript --from-file=mycheckscript.sh`
- configMap:
  defaultMode: 0755
  name: keepalived-checkscript
  name: config-volume
  imagePullSecrets:
    - name: openshift-pull-secret 13
```

- 1** The name of the IP failover deployment.
- 2** The list of IP address ranges to replicate. This must be provided. For example, **1.2.3.4-6,1.2.3.9**.
- 3** The number of groups to create for VRRP. If not set, a group is created for each virtual IP range specified with the **OPENSIFT_HA_VIP_GROUPS** variable.
- 4** The interface name that IP failover uses to send VRRP traffic. By default, **eth0** is used.
- 5** The IP failover pod tries to open a TCP connection to this port on each VIP. If connection is established, the service is considered to be running. If this port is set to **0**, the test always passes. The default value is **80**.
- 6** The offset value used to set the virtual router IDs. Using different offset values allows multiple IP failover configurations to exist within the same cluster. The default offset is **0**, and the allowed range is **0** through **255**.
- 7** The number of replicas to create. This must match **spec.replicas** value in IP failover deployment configuration. The default value is **2**.
- 8** The name of the **iptables** chain to automatically add an **iptables** rule to allow the VRRP traffic on. If the value is not set, an **iptables** rule is not added. If the chain does not exist, it is not created, and Keepalived operates in unicast mode. The default is **INPUT**.
- 9** The full path name in the pod file system of a script that is run whenever the state changes.
- 10** The full path name in the pod file system of a script that is periodically run to verify the application is operating.
- 11** The strategy for handling a new higher priority host. The default value is **preempt_delay 300**, which causes a Keepalived instance to take over a VIP after 5 minutes if a lower-priority master is holding the VIP.
- 12** The period, in seconds, that the check script is run. The default value is **2**.
- 13** Create the pull secret before creating the deployment, otherwise you will get an error when creating the deployment.

18.3. CONFIGURING CHECK AND NOTIFY SCRIPTS

Keepalived monitors the health of the application by periodically running an optional user-supplied check script. For example, the script can test a web server by issuing a request and verifying the response. As cluster administrator, you can provide an optional notify script, which is called whenever the state changes.

The check and notify scripts run in the IP failover pod and use the pod file system, not the host file system. However, the IP failover pod makes the host file system available under the `/hosts` mount path. When configuring a check or notify script, you must provide the full path to the script. The recommended approach for providing the scripts is to use a **ConfigMap** object.

The full path names of the check and notify scripts are added to the Keepalived configuration file, `_etc/keepalived/keepalived.conf`, which is loaded every time Keepalived starts. The scripts can be added to the pod with a **ConfigMap** object as described in the following methods.

Check script

When a check script is not provided, a simple default script is run that tests the TCP connection. This default test is suppressed when the monitor port is **0**.

Each IP failover pod manages a Keepalived daemon that manages one or more virtual IP (VIP) addresses on the node where the pod is running. The Keepalived daemon keeps the state of each VIP for that node. A particular VIP on a particular node might be in **master**, **backup**, or **fault** state.

If the check script returns non-zero, the node enters the **backup** state, and any VIPs it holds are reassigned.

Notify script

Keepalived passes the following three parameters to the notify script:

- **\$1** - **group** or **instance**
- **\$2** - Name of the **group** or **instance**
- **\$3** - The new state: **master**, **backup**, or **fault**

Prerequisites

- You installed the OpenShift CLI (**oc**).
- You are logged in to the cluster with a user with **cluster-admin** privileges.

Procedure

1. Create the desired script and create a **ConfigMap** object to hold it. The script has no input arguments and must return **0** for **OK** and **1** for **fail**.

The check script, *mycheckscript.sh*:

```
#!/bin/bash
# Whatever tests are needed
# E.g., send request and verify response
exit 0
```

2. Create the **ConfigMap** object :

```
$ oc create configmap mycustomcheck --from-file=mycheckscript.sh
```

3. Add the script to the pod. The **defaultMode** for the mounted **ConfigMap** object files must be able to run by using **oc** commands or by editing the deployment configuration. A value of **0755, 493** decimal, is typical:

■

```
$ oc set env deploy/ipfailover-keepalived \
  OPENSIFT_HA_CHECK_SCRIPT=/etc/keepalive/mycheckscript.sh
```

```
$ oc set volume deploy/ipfailover-keepalived --add --overwrite \
  --name=config-volume \
  --mount-path=/etc/keepalive \
  --source='{ "configMap": { "name": "mycustomcheck", "defaultMode": 493}}'
```



NOTE

The **oc set env** command is whitespace sensitive. There must be no whitespace on either side of the **=** sign.

TIP

You can alternatively edit the **ipfailover-keepalived** deployment configuration:

```
$ oc edit deploy ipfailover-keepalived
```

```
spec:
  containers:
  - env:
    - name: OPENSIFT_HA_CHECK_SCRIPT 1
      value: /etc/keepalive/mycheckscript.sh
  ...
  volumeMounts: 2
  - mountPath: /etc/keepalive
    name: config-volume
  dnsPolicy: ClusterFirst
  ...
  volumes: 3
  - configMap:
    defaultMode: 0755 4
    name: customrouter
    name: config-volume
  ...
```

- 1** In the **spec.container.env** field, add the **OPENSIFT_HA_CHECK_SCRIPT** environment variable to point to the mounted script file.
- 2** Add the **spec.container.volumeMounts** field to create the mount point.
- 3** Add a new **spec.volumes** field to mention the config map.
- 4** This sets run permission on the files. When read back, it is displayed in decimal, **493**.

Save the changes and exit the editor. This restarts **ipfailover-keepalived**.

18.4. CONFIGURING VRRP PREEMPTION

When a Virtual IP (VIP) on a node leaves the **fault** state by passing the check script, the VIP on the node enters the **backup** state if it has lower priority than the VIP on the node that is currently in the **master** state. The **no preempt** strategy does not move **master** from the lower priority VIP on the host to the higher priority VIP on the host. With **preempt_delay 300**, the default, Keepalived waits the specified 300 seconds and moves **master** to the higher priority VIP on the host.

Procedure

- To specify preemption enter **oc edit deploy ipfailover-keepalived** to edit the router deployment configuration:

```
$ oc edit deploy ipfailover-keepalived
...
spec:
  containers:
  - env:
    - name: OPENSIFT_HA_PREEMPTION 1
      value: preempt_delay 300
...
```

- Set the **OPENSIFT_HA_PREEMPTION** value:
 - preempt_delay 300**: Keepalived waits the specified 300 seconds and moves **master** to the higher priority VIP on the host. This is the default value.
 - nopreempt**: does not move **master** from the lower priority VIP on the host to the higher priority VIP on the host.

18.5. DEPLOYING MULTIPLE IP FAILOVER INSTANCES

Each IP failover pod managed by the IP failover deployment configuration, **1** pod per node or replica, runs a Keepalived daemon. As more IP failover deployment configurations are configured, more pods are created and more daemons join into the common Virtual Router Redundancy Protocol (VRRP) negotiation. This negotiation is done by all the Keepalived daemons and it determines which nodes service which virtual IPs (VIP).

Internally, Keepalived assigns a unique **vrrp-id** to each VIP. The negotiation uses this set of **vrrp-ids**, when a decision is made, the VIP corresponding to the winning **vrrp-id** is serviced on the winning node.

Therefore, for every VIP defined in the IP failover deployment configuration, the IP failover pod must assign a corresponding **vrrp-id**. This is done by starting at **OPENSIFT_HA_VRRP_ID_OFFSET** and sequentially assigning the **vrrp-ids** to the list of VIPs. The **vrrp-ids** can have values in the range **1..255**.

When there are multiple IP failover deployment configurations, you must specify **OPENSIFT_HA_VRRP_ID_OFFSET** so that there is room to increase the number of VIPs in the deployment configuration and none of the **vrrp-id** ranges overlap.

18.6. CONFIGURING IP FAILOVER FOR MORE THAN 254 ADDRESSES

IP failover management is limited to 254 groups of Virtual IP (VIP) addresses. By default OpenShift Container Platform assigns one IP address to each group. You can use the **OPENSIFT_HA_VIP_GROUPS** variable to change this so multiple IP addresses are in each group and define the number of VIP groups available for each Virtual Router Redundancy Protocol (VRRP) instance when configuring IP failover.

Grouping VIPs creates a wider range of allocation of VIPs per VRRP in the case of VRRP failover events, and is useful when all hosts in the cluster have access to a service locally. For example, when a service is being exposed with an **ExternalIP**.

**NOTE**

As a rule for failover, do not limit services, such as the router, to one specific host. Instead, services should be replicated to each host so that in the case of IP failover, the services do not have to be recreated on the new host.

**NOTE**

If you are using OpenShift Container Platform health checks, the nature of IP failover and groups means that all instances in the group are not checked. For that reason, [the Kubernetes health checks](#) must be used to ensure that services are live.

Prerequisites

- You are logged in to the cluster with a user with **cluster-admin** privileges.

Procedure

- To change the number of IP addresses assigned to each group, change the value for the **OPENSHIFT_HA_VIP_GROUPS** variable, for example:

Example Deployment YAML for IP failover configuration

```
...
spec:
  env:
    - name: OPENSHIFT_HA_VIP_GROUPS 1
      value: "3"
...
```

- 1** If **OPENSHIFT_HA_VIP_GROUPS** is set to **3** in an environment with seven VIPs, it creates three groups, assigning three VIPs to the first group, and two VIPs to the two remaining groups.

**NOTE**

If the number of groups set by **OPENSHIFT_HA_VIP_GROUPS** is fewer than the number of IP addresses set to fail over, the group contains more than one IP address, and all of the addresses move as a single unit.

18.7. HIGH AVAILABILITY FOR EXTERNALIP

In non-cloud clusters, IP failover and **ExternalIP** to a service can be combined. The result is high availability services for users that create services using **ExternalIP**.

The approach is to specify an **spec.ExternalIP.autoAssignCIDRs** range of the cluster network configuration, and then use the same range in creating the IP failover configuration.

Because IP failover can support up to a maximum of 255 VIPs for the entire cluster, the **spec.ExternalIP.autoAssignCIDRs** must be **/24** or smaller.

18.8. REMOVING IP FAILOVER

When IP failover is initially configured, the worker nodes in the cluster are modified with an **iptables** rule that explicitly allows multicast packets on **224.0.0.18** for Keepalived. Because of the change to the nodes, removing IP failover requires running a job to remove the **iptables** rule and removing the virtual IP addresses used by Keepalived.

Procedure

1. Optional: Identify and delete any check and notify scripts that are stored as config maps:
 - a. Identify whether any pods for IP failover use a config map as a volume:

```
$ oc get pod -l ipfailover \
-o jsonpath="\
{range .items[?(@.spec.volumes[*].configMap)]}
{Namespace: }{.metadata.namespace}
{Pod:   }{.metadata.name}
{Volumes that use config maps:}
{range .spec.volumes[?(@.configMap)]} {volume:   }{.name}
  {configMap: }{.configMap.name}{\n}{end}
{end}"
```

Example output

```
Namespace: default
Pod:   keepalived-worker-59df45db9c-2x9mn
Volumes that use config maps:
volume:   config-volume
configMap: mycustomcheck
```

- b. If the preceding step provided the names of config maps that are used as volumes, delete the config maps:

```
$ oc delete configmap <configmap_name>
```

2. Identify an existing deployment for IP failover:

```
$ oc get deployment -l ipfailover
```

Example output

```
NAMESPACE NAME      READY UP-TO-DATE AVAILABLE AGE
default   ipfailover 2/2   2         2         105d
```

3. Delete the deployment:

```
$ oc delete deployment <ipfailover_deployment_name>
```

4. Remove the **ipfailover** service account:

```
$ oc delete sa ipfailover
```

5. Run a job that removes the IP tables rule that was added when IP failover was initially configured:

- a. Create a file such as **remove-ipfailover-job.yaml** with contents that are similar to the following example:

```
apiVersion: batch/v1
kind: Job
metadata:
  generateName: remove-ipfailover-
  labels:
    app: remove-ipfailover
spec:
  template:
    metadata:
      name: remove-ipfailover
    spec:
      containers:
        - name: remove-ipfailover
          image: quay.io/openshift/origin-keepalived-ipfailover:4.15
          command: ["/var/lib/ipfailover/keepalived/remove-failover.sh"]
      nodeSelector: ❶
        kubernetes.io/hostname: <host_name> ❷
      restartPolicy: Never
```

- ❶ The **nodeSelector** is likely the same as the selector used in the old IP failover deployment.
- ❷ Run the job for each node in your cluster that was configured for IP failover and replace the hostname each time.

- b. Run the job:

```
$ oc create -f remove-ipfailover-job.yaml
```

Example output

```
job.batch/remove-ipfailover-2h8dm created
```

Verification

- Confirm that the job removed the initial configuration for IP failover.

```
$ oc logs job/remove-ipfailover-2h8dm
```

Example output

```
remove-failover.sh: OpenShift IP Failover service terminating.
- Removing ip_vs module ...
- Cleaning up ...
- Releasing VIPs (interface eth0) ...
```

CHAPTER 19. CONFIGURING SYSTEM CONTROLS AND INTERFACE ATTRIBUTES USING THE TUNING PLUGIN

In Linux, `sysctl` allows an administrator to modify kernel parameters at runtime. You can modify interface-level network `sysctls` using the tuning Container Network Interface (CNI) meta plugin. The tuning CNI meta plugin operates in a chain with a main CNI plugin as illustrated.

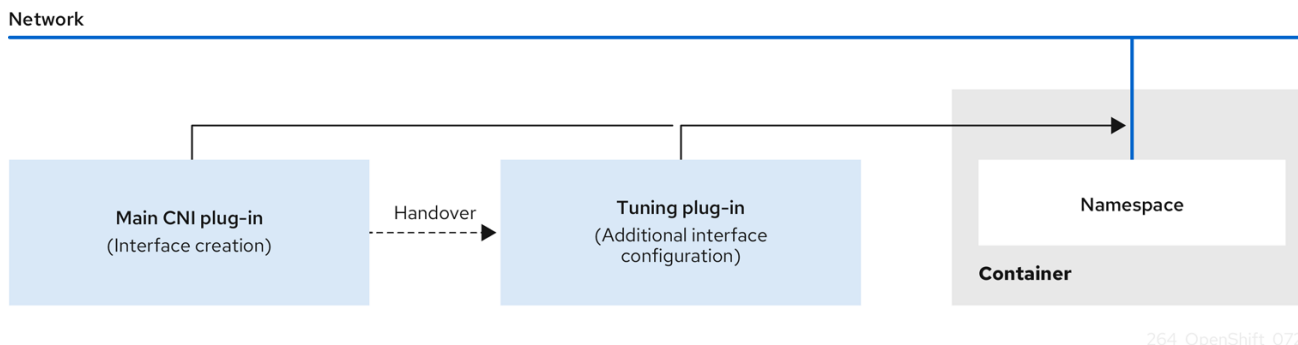

The main CNI plugin assigns the interface and passes this interface to the tuning CNI meta plugin at runtime. You can change some `sysctls` and several interface attributes such as promiscuous mode, all-multicast mode, MTU, and MAC address in the network namespace by using the tuning CNI meta plugin.

19.1. CONFIGURING SYSTEM CONTROLS BY USING THE TUNING CNI

The following procedure configures the tuning CNI to change the interface-level network `net.ipv4.conf.IFNAME.accept_redirects` `sysctl`. This example enables accepting and sending ICMP-redirected packets. In the tuning CNI meta plugin configuration, the interface name is represented by the `IFNAME` token and is replaced with the actual name of the interface at runtime.

Procedure

1. Create a network attachment definition, such as `tuning-example.yaml`, with the following content:

```
apiVersion: "k8s.cni.cncf.io/v1"
kind: NetworkAttachmentDefinition
metadata:
  name: <name> 1
  namespace: default 2
spec:
  config: '{
    "cniVersion": "0.4.0", 3
    "name": "<name>", 4
    "plugins": [{
      "type": "<main_CNI_plugin>" 5
    },
    {
      "type": "tuning", 6
      "sysctl": {
        "net.ipv4.conf.IFNAME.accept_redirects": "1" 7
      }
    }
  ]
}
```

```

    }
  ]
}

```

- 1 Specifies the name for the additional network attachment to create. The name must be unique within the specified namespace.
- 2 Specifies the namespace that the object is associated with.
- 3 Specifies the CNI specification version.
- 4 Specifies the name for the configuration. It is recommended to match the configuration name to the name value of the network attachment definition.
- 5 Specifies the name of the main CNI plugin to configure.
- 6 Specifies the name of the CNI meta plugin.
- 7 Specifies the sysctl to set. The interface name is represented by the **IFNAME** token and is replaced with the actual name of the interface at runtime.

An example YAML file is shown here:

```

apiVersion: "k8s.cni.cncf.io/v1"
kind: NetworkAttachmentDefinition
metadata:
  name: tuningnad
  namespace: default
spec:
  config: '{
    "cniVersion": "0.4.0",
    "name": "tuningnad",
    "plugins": [{
      "type": "bridge"
    },
    {
      "type": "tuning",
      "sysctl": {
        "net.ipv4.conf.IFNAME.accept_redirects": "1"
      }
    }
  ]
}'

```

2. Apply the YAML by running the following command:

```
$ oc apply -f tuning-example.yaml
```

Example output

```
networkattachmentdefinition.k8s.cni.cncf.io/tuningnad created
```

3. Create a pod such as **examplepod.yaml** with the network attachment definition similar to the following:

```

apiVersion: v1
kind: Pod
metadata:
  name: tunepod
  namespace: default
  annotations:
    k8s.v1.cni.cncf.io/networks: tuningnad ❶
spec:
  containers:
  - name: podexample
    image: centos
    command: ["/bin/bash", "-c", "sleep INF"]
    securityContext:
      runAsUser: 2000 ❷
      runAsGroup: 3000 ❸
      allowPrivilegeEscalation: false ❹
      capabilities: ❺
        drop: ["ALL"]
    securityContext:
      runAsNonRoot: true ❻
      seccompProfile: ❼
        type: RuntimeDefault

```

- ❶ Specify the name of the configured **NetworkAttachmentDefinition**.
- ❷ **runAsUser** controls which user ID the container is run with.
- ❸ **runAsGroup** controls which primary group ID the containers is run with.
- ❹ **allowPrivilegeEscalation** determines if a pod can request to allow privilege escalation. If unspecified, it defaults to true. This boolean directly controls whether the **no_new_privs** flag gets set on the container process.
- ❺ **capabilities** permit privileged actions without giving full root access. This policy ensures all capabilities are dropped from the pod.
- ❻ **runAsNonRoot: true** requires that the container will run with a user with any UID other than 0.
- ❼ **RuntimeDefault** enables the default seccomp profile for a pod or container workload.

4. Apply the yaml by running the following command:

```
$ oc apply -f examplepod.yaml
```

5. Verify that the pod is created by running the following command:

```
$ oc get pod
```

Example output

```

NAME      READY   STATUS    RESTARTS   AGE
tunepod  1/1     Running  0           47s

```

- Log in to the pod by running the following command:

```
$ oc rsh tunepod
```

- Verify the values of the configured sysctl flags. For example, find the value **net.ipv4.conf.net1.accept_redirects** by running the following command:

```
sh-4.4# sysctl net.ipv4.conf.net1.accept_redirects
```

Expected output

```
net.ipv4.conf.net1.accept_redirects = 1
```

19.2. ENABLING ALL-MULTICAST MODE BY USING THE TUNING CNI

You can enable all-multicast mode by using the tuning Container Network Interface (CNI) meta plugin.

The following procedure describes how to configure the tuning CNI to enable the all-multicast mode.

Procedure

- Create a network attachment definition, such as **tuning-example.yaml**, with the following content:

```
apiVersion: "k8s.cni.cncf.io/v1"
kind: NetworkAttachmentDefinition
metadata:
  name: <name> 1
  namespace: default 2
spec:
  config: '{
    "cniVersion": "0.4.0", 3
    "name": "<name>", 4
    "plugins": [{
      "type": "<main_CNI_plugin>" 5
    },
    {
      "type": "tuning", 6
      "allmulti": true 7
    }
  ]
}
```

- Specifies the name for the additional network attachment to create. The name must be unique within the specified namespace.
- Specifies the namespace that the object is associated with.
- Specifies the CNI specification version.
- Specifies the name for the configuration. Match the configuration name to the name value of the network attachment definition.

- 5 Specifies the name of the main CNI plugin to configure.
- 6 Specifies the name of the CNI meta plugin.
- 7 Changes the all-multicast mode of interface. If enabled, all multicast packets on the network will be received by the interface.

An example YAML file is shown here:

```
apiVersion: "k8s.cni.cncf.io/v1"
kind: NetworkAttachmentDefinition
metadata:
  name: setallmulti
  namespace: default
spec:
  config: '{
    "cniVersion": "0.4.0",
    "name": "setallmulti",
    "plugins": [
      {
        "type": "bridge"
      },
      {
        "type": "tuning",
        "allmulti": true
      }
    ]
  }'
```

2. Apply the settings specified in the YAML file by running the following command:

```
$ oc apply -f tuning-allmulti.yaml
```

Example output

```
networkattachmentdefinition.k8s.cni.cncf.io/setallmulti created
```

3. Create a pod with a network attachment definition similar to that specified in the following **examplepod.yaml** sample file:

```
apiVersion: v1
kind: Pod
metadata:
  name: allmultipod
  namespace: default
  annotations:
    k8s.v1.cni.cncf.io/networks: setallmulti 1
spec:
  containers:
    - name: podexample
      image: centos
      command: ["/bin/bash", "-c", "sleep INF"]
      securityContext:
        runAsUser: 2000 2
```

```

runAsGroup: 3000 3
allowPrivilegeEscalation: false 4
capabilities: 5
  drop: ["ALL"]
securityContext:
  runAsNonRoot: true 6
  seccompProfile: 7
    type: RuntimeDefault

```

- 1 Specifies the name of the configured **NetworkAttachmentDefinition**.
- 2 Specifies the user ID the container is run with.
- 3 Specifies which primary group ID the containers is run with.
- 4 Specifies if a pod can request privilege escalation. If unspecified, it defaults to **true**. This boolean directly controls whether the **no_new_privs** flag gets set on the container process.
- 5 Specifies the container capabilities. The **drop: ["ALL"]** statement indicates that all Linux capabilities are dropped from the pod, providing a more restrictive security profile.
- 6 Specifies that the container will run with a user with any UID other than 0.
- 7 Specifies the container's seccomp profile. In this case, the type is set to **RuntimeDefault**. Seccomp is a Linux kernel feature that restricts the system calls available to a process, enhancing security by minimizing the attack surface.

4. Apply the settings specified in the YAML file by running the following command:

```
$ oc apply -f examplepod.yaml
```

5. Verify that the pod is created by running the following command:

```
$ oc get pod
```

Example output

```

NAME          READY  STATUS   RESTARTS  AGE
allmultipod  1/1    Running  0          23s

```

6. Log in to the pod by running the following command:

```
$ oc rsh allmultipod
```

7. List all the interfaces associated with the pod by running the following command:

```
sh-4.4# ip link
```

Example output

```
1: lo: <LOOPBACK,UP,LOWER_UP> mtu 65536 qdisc noqueue state UNKNOWN mode
```

```
DEFAULT group default qlen 1000
  link/loopback 00:00:00:00:00:00 brd 00:00:00:00:00:00
2: eth0@if22: <BROADCAST,MULTICAST,UP,LOWER_UP> mtu 8901 qdisc noqueue state
UP mode DEFAULT group default
  link/ether 0a:58:0a:83:00:10 brd ff:ff:ff:ff:ff:ff link-netnsid 0 1
3: net1@if24: <BROADCAST,MULTICAST,ALLMULTI,UP,LOWER_UP> mtu 1500 qdisc
noqueue state UP mode DEFAULT group default
  link/ether ee:9b:66:a4:ec:1d brd ff:ff:ff:ff:ff:ff link-netnsid 0 2
```

- 1** **eth0@if22** is the primary interface
- 2** **net1@if24** is the secondary interface configured with the network-attachment-definition that supports the all-multicast mode (ALLMULTI flag)

19.3. ADDITIONAL RESOURCES

- [Using sysctls in containers](#)
- [SR-IOV network node configuration object](#)
- [Configuring interface-level network sysctl settings and all-multicast mode for SR-IOV networks](#)

CHAPTER 20. USING THE STREAM CONTROL TRANSMISSION PROTOCOL (SCTP) ON A BARE METAL CLUSTER

As a cluster administrator, you can use the Stream Control Transmission Protocol (SCTP) on a cluster.

20.1. SUPPORT FOR STREAM CONTROL TRANSMISSION PROTOCOL (SCTP) ON OPENSIFT CONTAINER PLATFORM

As a cluster administrator, you can enable SCTP on the hosts in the cluster. On Red Hat Enterprise Linux CoreOS (RHCOS), the SCTP module is disabled by default.

SCTP is a reliable message based protocol that runs on top of an IP network.

When enabled, you can use SCTP as a protocol with pods, services, and network policy. A **Service** object must be defined with the **type** parameter set to either the **ClusterIP** or **NodePort** value.

20.1.1. Example configurations using SCTP protocol

You can configure a pod or service to use SCTP by setting the **protocol** parameter to the **SCTP** value in the pod or service object.

In the following example, a pod is configured to use SCTP:

```
apiVersion: v1
kind: Pod
metadata:
  namespace: project1
  name: example-pod
spec:
  containers:
  - name: example-pod
  ...
  ports:
  - containerPort: 30100
    name: sctpserver
    protocol: SCTP
```

In the following example, a service is configured to use SCTP:

```
apiVersion: v1
kind: Service
metadata:
  namespace: project1
  name: sctpserver
spec:
  ...
  ports:
  - name: sctpserver
    protocol: SCTP
    port: 30100
    targetPort: 30100
  type: ClusterIP
```

In the following example, a **NetworkPolicy** object is configured to apply to SCTP network traffic on port **80** from any pods with a specific label:

```
kind: NetworkPolicy
apiVersion: networking.k8s.io/v1
metadata:
  name: allow-sctp-on-http
spec:
  podSelector:
    matchLabels:
      role: web
  ingress:
    - ports:
      - protocol: SCTP
        port: 80
```

20.2. ENABLING STREAM CONTROL TRANSMISSION PROTOCOL (SCTP)

As a cluster administrator, you can load and enable the blacklisted SCTP kernel module on worker nodes in your cluster.

Prerequisites

- Install the OpenShift CLI (**oc**).
- Access to the cluster as a user with the **cluster-admin** role.

Procedure

1. Create a file named **load-sctp-module.yaml** that contains the following YAML definition:

```
apiVersion: machineconfiguration.openshift.io/v1
kind: MachineConfig
metadata:
  name: load-sctp-module
  labels:
    machineconfiguration.openshift.io/role: worker
spec:
  config:
    ignition:
      version: 3.2.0
    storage:
      files:
        - path: /etc/modprobe.d/sctp-blacklist.conf
          mode: 0644
          overwrite: true
          contents:
            source: data:,
        - path: /etc/modules-load.d/sctp-load.conf
          mode: 0644
          overwrite: true
          contents:
            source: data:,sctp
```

2. To create the **MachineConfig** object, enter the following command:

```
$ oc create -f load-sctp-module.yaml
```

3. Optional: To watch the status of the nodes while the MachineConfig Operator applies the configuration change, enter the following command. When the status of a node transitions to **Ready**, the configuration update is applied.

```
$ oc get nodes
```

20.3. VERIFYING STREAM CONTROL TRANSMISSION PROTOCOL (SCTP) IS ENABLED

You can verify that SCTP is working on a cluster by creating a pod with an application that listens for SCTP traffic, associating it with a service, and then connecting to the exposed service.

Prerequisites

- Access to the internet from the cluster to install the **nc** package.
- Install the OpenShift CLI (**oc**).
- Access to the cluster as a user with the **cluster-admin** role.

Procedure

1. Create a pod starts an SCTP listener:
 - a. Create a file named **sctp-server.yaml** that defines a pod with the following YAML:

```
apiVersion: v1
kind: Pod
metadata:
  name: sctpserver
  labels:
    app: sctpserver
spec:
  containers:
  - name: sctpserver
    image: registry.access.redhat.com/ubi9/ubi
    command: ["/bin/sh", "-c"]
    args:
      ["dnf install -y nc && sleep inf"]
    ports:
      - containerPort: 30102
        name: sctpserver
        protocol: SCTP
```

- b. Create the pod by entering the following command:

```
$ oc create -f sctp-server.yaml
```

2. Create a service for the SCTP listener pod.

- a. Create a file named **sctp-service.yaml** that defines a service with the following YAML:

```
apiVersion: v1
kind: Service
metadata:
  name: sctpservice
  labels:
    app: sctpserver
spec:
  type: NodePort
  selector:
    app: sctpserver
  ports:
    - name: sctpserver
      protocol: SCTP
      port: 30102
      targetPort: 30102
```

- b. To create the service, enter the following command:

```
$ oc create -f sctp-service.yaml
```

3. Create a pod for the SCTP client.

- a. Create a file named **sctp-client.yaml** with the following YAML:

```
apiVersion: v1
kind: Pod
metadata:
  name: sctpclient
  labels:
    app: sctpclient
spec:
  containers:
    - name: sctpclient
      image: registry.access.redhat.com/ubi9/ubi
      command: ["/bin/sh", "-c"]
      args:
        ["dnf install -y nc && sleep inf"]
```

- b. To create the **Pod** object, enter the following command:

```
$ oc apply -f sctp-client.yaml
```

4. Run an SCTP listener on the server.

- a. To connect to the server pod, enter the following command:

```
$ oc rsh sctpserver
```

- b. To start the SCTP listener, enter the following command:

```
$ nc -l 30102 --sctp
```

5. Connect to the SCTP listener on the server.

a. Open a new terminal window or tab in your terminal program.

b. Obtain the IP address of the **sctp** service. Enter the following command:

```
$ oc get services sctp -o go-template='{{.spec.clusterIP}}{\n}'
```

c. To connect to the client pod, enter the following command:

```
$ oc rsh sctpclient
```

d. To start the SCTP client, enter the following command. Replace **<cluster_IP>** with the cluster IP address of the **sctp** service.

```
# nc <cluster_IP> 30102 --sctp
```

CHAPTER 21. USING PTP HARDWARE

21.1. ABOUT PTP IN OPENSIFT CONTAINER PLATFORM CLUSTER NODES

Precision Time Protocol (PTP) is used to synchronize clocks in a network. When used in conjunction with hardware support, PTP is capable of sub-microsecond accuracy, and is more accurate than Network Time Protocol (NTP).

You can configure **linuxptp** services and use PTP-capable hardware in OpenShift Container Platform cluster nodes.

Use the OpenShift Container Platform web console or OpenShift CLI (**oc**) to install PTP by deploying the PTP Operator. The PTP Operator creates and manages the **linuxptp** services and provides the following features:

- Discovery of the PTP-capable devices in the cluster.
- Management of the configuration of **linuxptp** services.
- Notification of PTP clock events that negatively affect the performance and reliability of your application with the PTP Operator **cloud-event-proxy** sidecar.

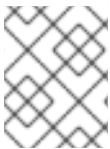

NOTE

The PTP Operator works with PTP-capable devices on clusters provisioned only on bare-metal infrastructure.

21.1.1. Elements of a PTP domain

PTP is used to synchronize multiple nodes connected in a network, with clocks for each node. The clocks synchronized by PTP are organized in a leader-follower hierarchy. The hierarchy is created and updated automatically by the best master clock (BMC) algorithm, which runs on every clock. Follower clocks are synchronized to leader clocks, and follower clocks can themselves be the source for other downstream clocks.

Figure 21.1. PTP nodes in the network

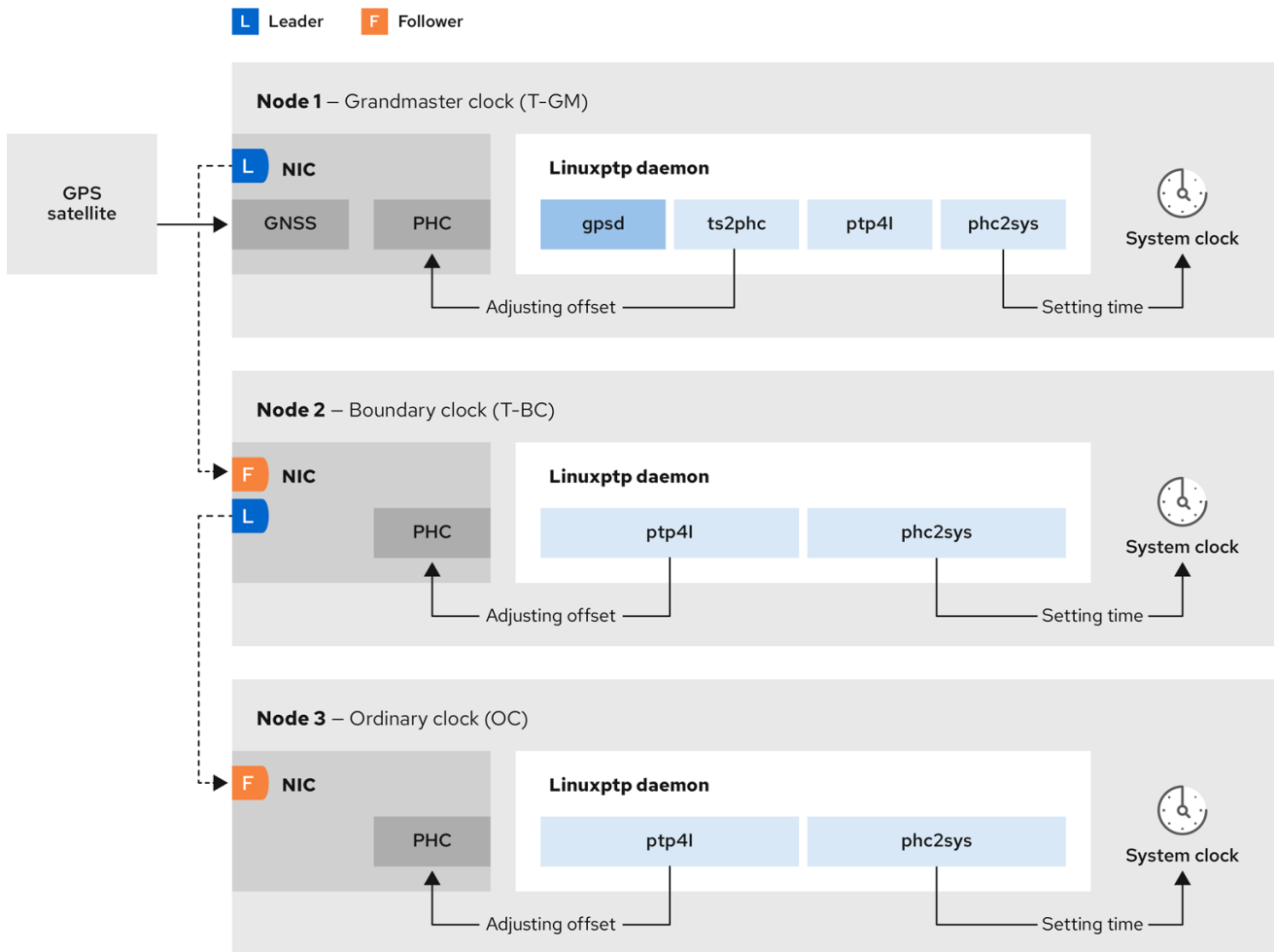

319_OpenShift_1123

The three primary types of PTP clocks are described below.

Grandmaster clock

The grandmaster clock provides standard time information to other clocks across the network and ensures accurate and stable synchronisation. It writes time stamps and responds to time requests from other clocks. Grandmaster clocks synchronize to a Global Navigation Satellite System (GNSS) time source. The Grandmaster clock is the authoritative source of time in the network and is responsible for providing time synchronization to all other devices.

Boundary clock

The boundary clock has ports in two or more communication paths and can be a source and a destination to other destination clocks at the same time. The boundary clock works as a destination clock upstream. The destination clock receives the timing message, adjusts for delay, and then creates a new source time signal to pass down the network. The boundary clock produces a new timing packet that is still correctly synced with the source clock and can reduce the number of connected devices reporting directly to the source clock.

Ordinary clock

The ordinary clock has a single port connection that can play the role of source or destination clock, depending on its position in the network. The ordinary clock can read and write timestamps.

Advantages of PTP over NTP

One of the main advantages that PTP has over NTP is the hardware support present in various network interface controllers (NIC) and network switches. The specialized hardware allows PTP to account for

delays in message transfer and improves the accuracy of time synchronization. To achieve the best possible accuracy, it is recommended that all networking components between PTP clocks are PTP hardware enabled.

Hardware-based PTP provides optimal accuracy, since the NIC can timestamp the PTP packets at the exact moment they are sent and received. Compare this to software-based PTP, which requires additional processing of the PTP packets by the operating system.

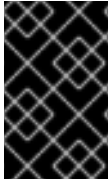

IMPORTANT

Before enabling PTP, ensure that NTP is disabled for the required nodes. You can disable the chrony time service (**chronyd**) using a **MachineConfig** custom resource. For more information, see [Disabling chrony time service](#).

21.1.2. Using dual Intel E810 NIC hardware with PTP

OpenShift Container Platform supports single and dual NIC Intel E810 hardware for precision PTP timing in grandmaster clocks (T-GM) and boundary clocks (T-BC).

Dual NIC grandmaster clock

You can use a cluster host that has dual NIC hardware as PTP grandmaster clock. One NIC receives timing information from the global navigation satellite system (GNSS). The second NIC receives the timing information from the first using the SMA1 Tx/Rx connections on the E810 NIC faceplate. The system clock on the cluster host is synchronized from the NIC that is connected to the GNSS satellite.

Dual NIC grandmaster clocks are a feature of distributed RAN (D-RAN) configurations where the Remote Radio Unit (RRU) and Baseband Unit (BBU) are located at the same radio cell site. D-RAN distributes radio functions across multiple sites, with backhaul connections linking them to the core network.

Figure 21.2. Dual NIC grandmaster clock

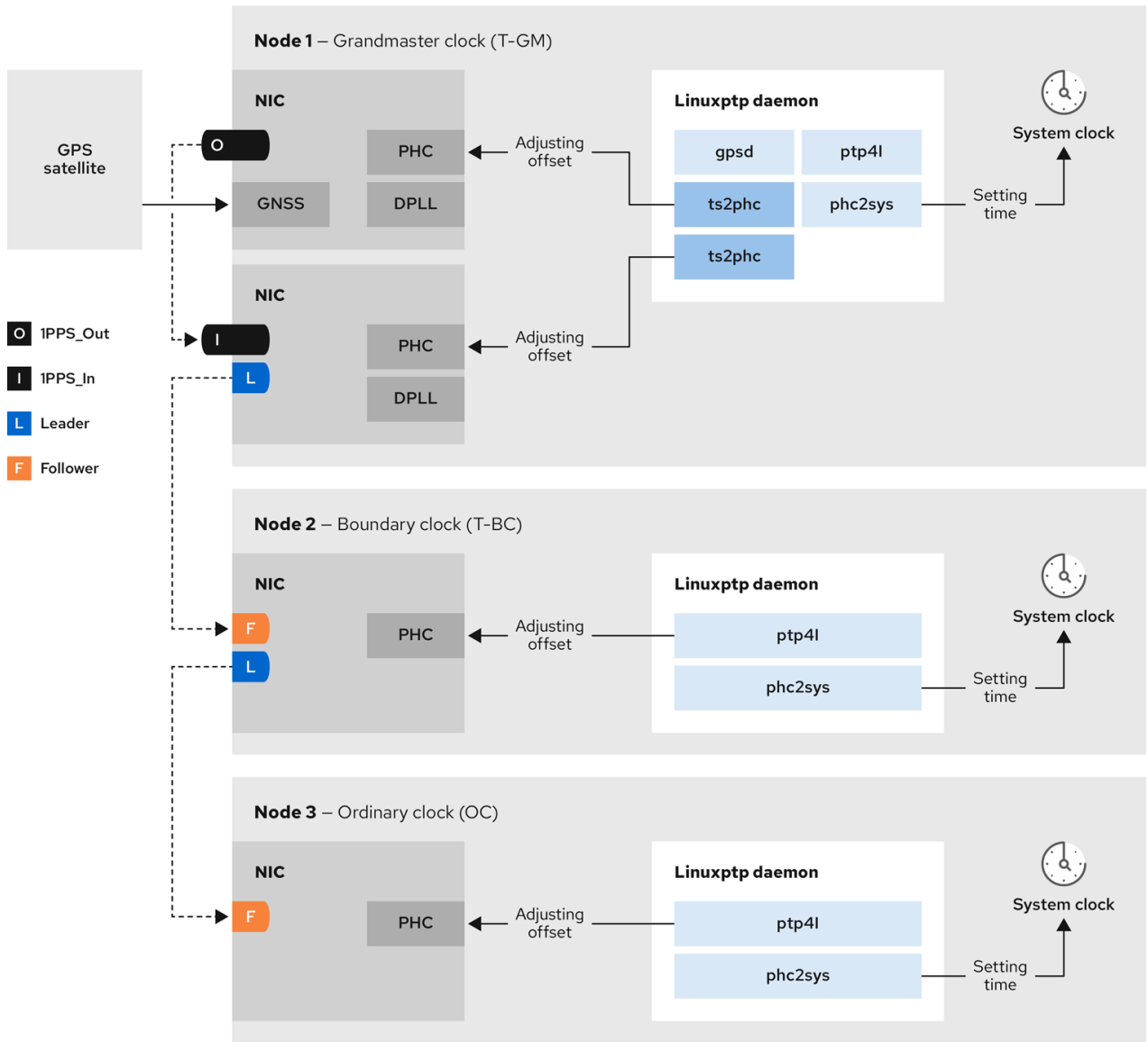

561_OpenShift_0124

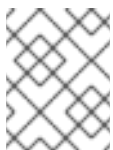

NOTE

In a dual NIC T-GM configuration, a single **ts2phc** process reports as two **ts2phc** instances in the system.

Dual NIC boundary clock

For 5G telco networks that deliver mid-band spectrum coverage, each virtual distributed unit (vDU) requires connections to 6 radio units (RUs). To make these connections, each vDU host requires 2 NICs configured as boundary clocks.

Dual NIC hardware allows you to connect each NIC to the same upstream leader clock with separate **ptp4l** instances for each NIC feeding the downstream clocks.

21.1.3. Overview of linuxptp and gpsd in OpenShift Container Platform nodes

OpenShift Container Platform uses the PTP Operator with **linuxptp** and **gpsd** packages for high precision network synchronization. The **linuxptp** package provides tools and daemons for PTP timing in

networks. Cluster hosts with Global Navigation Satellite System (GNSS) capable NICs use **gpsd** to interface with GNSS clock sources.

The **linuxptp** package includes the **ts2phc**, **pmc**, **ptp4l**, and **phc2sys** programs for system clock synchronization.

ts2phc

ts2phc synchronizes the PTP hardware clock (PHC) across PTP devices with a high degree of precision. **ts2phc** is used in grandmaster clock configurations. It receives the precision timing signal a high precision clock source such as Global Navigation Satellite System (GNSS). GNSS provides an accurate and reliable source of synchronized time for use in large distributed networks. GNSS clocks typically provide time information with a precision of a few nanoseconds.

The **ts2phc** system daemon sends timing information from the grandmaster clock to other PTP devices in the network by reading time information from the grandmaster clock and converting it to PHC format. PHC time is used by other devices in the network to synchronize their clocks with the grandmaster clock.

pmc

pmc implements a PTP management client (**pmc**) according to IEEE standard 1588.1588. **pmc** provides basic management access for the **ptp4l** system daemon. **pmc** reads from standard input and sends the output over the selected transport, printing any replies it receives.

ptp4l

ptp4l implements the PTP boundary clock and ordinary clock and runs as a system daemon. **ptp4l** does the following:

- Synchronizes the PHC to the source clock with hardware time stamping
- Synchronizes the system clock to the source clock with software time stamping

phc2sys

phc2sys synchronizes the system clock to the PHC on the network interface controller (NIC). The **phc2sys** system daemon continuously monitors the PHC for timing information. When it detects a timing error, the PHC corrects the system clock.

The **gpsd** package includes the **ubxtool**, **gpspipe**, **gpsd**, programs for GNSS clock synchronization with the host clock.

ubxtool

ubxtool CLI allows you to communicate with a u-blox GPS system. The **ubxtool** CLI uses the u-blox binary protocol to communicate with the GPS.

gpspipe

gpspipe connects to **gpsd** output and pipes it to **stdout**.

gpsd

gpsd is a service daemon that monitors one or more GPS or AIS receivers connected to the host.

21.1.4. Overview of GNSS timing for PTP grandmaster clocks

OpenShift Container Platform supports receiving precision PTP timing from Global Navigation Satellite System (GNSS) sources and grandmaster clocks (T-GM) in the cluster.

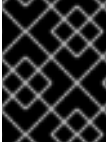

IMPORTANT

OpenShift Container Platform supports PTP timing from GNSS sources with Intel E810 Westport Channel NICs only.

Figure 21.3. Overview of Synchronization with GNSS and T-GM

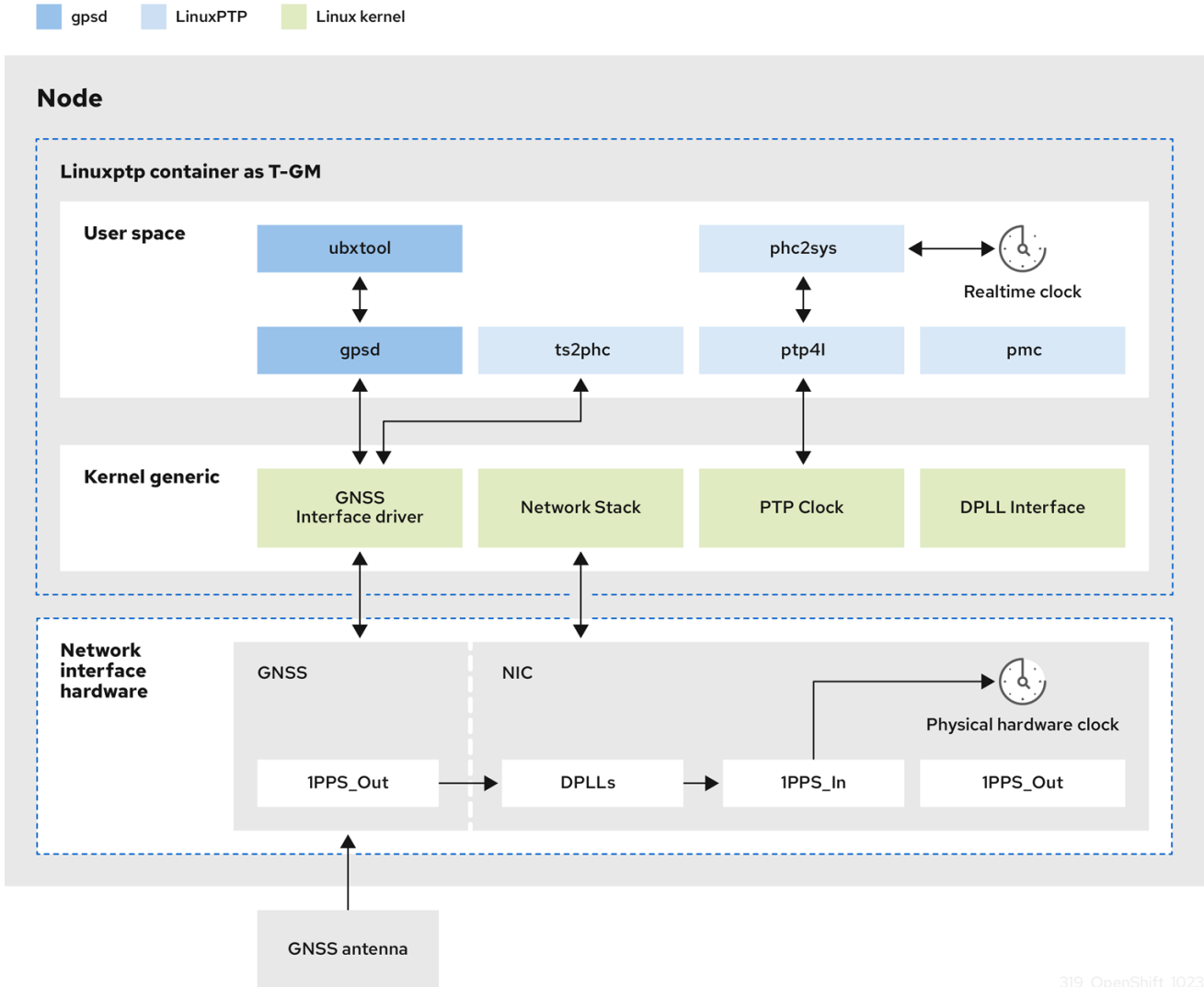

319_OpenShift_1023

Global Navigation Satellite System (GNSS)

GNSS is a satellite-based system used to provide positioning, navigation, and timing information to receivers around the globe. In PTP, GNSS receivers are often used as a highly accurate and stable reference clock source. These receivers receive signals from multiple GNSS satellites, allowing them to calculate precise time information. The timing information obtained from GNSS is used as a reference by the PTP grandmaster clock.

By using GNSS as a reference, the grandmaster clock in the PTP network can provide highly accurate timestamps to other devices, enabling precise synchronization across the entire network.

Digital Phase-Locked Loop (DPLL)

DPLL provides clock synchronization between different PTP nodes in the network. DPLL compares the phase of the local system clock signal with the phase of the incoming synchronization signal, for example, PTP messages from the PTP grandmaster clock. The DPLL continuously adjusts the local clock frequency and phase to minimize the phase difference between the local clock and the reference clock.

21.2. CONFIGURING PTP DEVICES

The PTP Operator adds the **NodePtpDevice.ptp.openshift.io** custom resource definition (CRD) to OpenShift Container Platform.

When installed, the PTP Operator searches your cluster for PTP-capable network devices on each node. It creates and updates a **NodePtpDevice** custom resource (CR) object for each node that provides a compatible PTP-capable network device.

21.2.1. Installing the PTP Operator using the CLI

As a cluster administrator, you can install the Operator by using the CLI.

Prerequisites

- A cluster installed on bare-metal hardware with nodes that have hardware that supports PTP.
- Install the OpenShift CLI (**oc**).
- Log in as a user with **cluster-admin** privileges.

Procedure

1. Create a namespace for the PTP Operator.
 - a. Save the following YAML in the **ptp-namespace.yaml** file:

```
apiVersion: v1
kind: Namespace
metadata:
  name: openshift-ptp
  annotations:
    workload.openshift.io/allowed: management
  labels:
    name: openshift-ptp
    openshift.io/cluster-monitoring: "true"
```

- b. Create the **Namespace** CR:

```
$ oc create -f ptp-namespace.yaml
```

2. Create an Operator group for the PTP Operator.
 - a. Save the following YAML in the **ptp-operatorgroup.yaml** file:

```
apiVersion: operators.coreos.com/v1
kind: OperatorGroup
metadata:
  name: ptp-operators
  namespace: openshift-ptp
spec:
  targetNamespaces:
    - openshift-ptp
```

- b. Create the **OperatorGroup** CR:

```
$ oc create -f ptp-operatorgroup.yaml
```

3. Subscribe to the PTP Operator.

a. Save the following YAML in the **ptp-sub.yaml** file:

```
apiVersion: operators.coreos.com/v1alpha1
kind: Subscription
metadata:
  name: ptp-operator-subscription
  namespace: openshift-ptp
spec:
  channel: "stable"
  name: ptp-operator
  source: redhat-operators
  sourceNamespace: openshift-marketplace
```

b. Create the **Subscription** CR:

```
$ oc create -f ptp-sub.yaml
```

4. To verify that the Operator is installed, enter the following command:

```
$ oc get csv -n openshift-ptp -o custom-
columns=Name:.metadata.name,Phase:.status.phase
```

Example output

```
Name                Phase
4.15.0-202301261535 Succeeded
```

21.2.2. Installing the PTP Operator by using the web console

As a cluster administrator, you can install the PTP Operator by using the web console.



NOTE

You have to create the namespace and Operator group as mentioned in the previous section.

Procedure

1. Install the PTP Operator using the OpenShift Container Platform web console:
 - a. In the OpenShift Container Platform web console, click **Operators** → **OperatorHub**.
 - b. Choose **PTP Operator** from the list of available Operators, and then click **Install**.
 - c. On the **Install Operator** page, under **A specific namespace on the cluster** select **openshift-ptp**. Then, click **Install**.
2. Optional: Verify that the PTP Operator installed successfully:

- a. Switch to the **Operators → Installed Operators** page.
- b. Ensure that **PTP Operator** is listed in the **openshift-ptp** project with a **Status** of **InstallSucceeded**.



NOTE

During installation an Operator might display a **Failed** status. If the installation later succeeds with an **InstallSucceeded** message, you can ignore the **Failed** message.

If the Operator does not appear as installed, to troubleshoot further:

- Go to the **Operators → Installed Operators** page and inspect the **Operator Subscriptions** and **Install Plans** tabs for any failure or errors under **Status**.
- Go to the **Workloads → Pods** page and check the logs for pods in the **openshift-ptp** project.

21.2.3. Discovering PTP capable network devices in your cluster

- To return a complete list of PTP capable network devices in your cluster, run the following command:

```
$ oc get NodePtpDevice -n openshift-ptp -o yaml
```

Example output

```
apiVersion: v1
items:
- apiVersion: ptp.openshift.io/v1
  kind: NodePtpDevice
  metadata:
    creationTimestamp: "2022-01-27T15:16:28Z"
    generation: 1
    name: dev-worker-0 1
    namespace: openshift-ptp
    resourceVersion: "6538103"
    uid: d42fc9ad-bcbf-4590-b6d8-b676c642781a
  spec: {}
  status:
    devices: 2
    - name: eno1
    - name: eno2
    - name: eno3
    - name: eno4
    - name: enp5s0f0
    - name: enp5s0f1
  ...
```

- 1** The value for the **name** parameter is the same as the name of the parent node.
- 2** The **devices** collection includes a list of the PTP capable devices that the PTP Operator discovers for the node.

21.2.4. Using hardware-specific NIC features with the PTP Operator

NIC hardware with built-in PTP capabilities sometimes require device-specific configuration. You can use hardware-specific NIC features for supported hardware with the PTP Operator by configuring a plugin in the **PtpConfig** custom resource (CR). The **linuxptp-daemon** service uses the named parameters in the **plugin** stanza to start **linuxptp** processes (**ptp4l** and **phc2sys**) based on the specific hardware configuration.



IMPORTANT

In OpenShift Container Platform 4.15, the Intel E810 NIC is supported with a **PtpConfig** plugin.

21.2.5. Configuring linuxptp services as a grandmaster clock

You can configure the **linuxptp** services (**ptp4l**, **phc2sys**, **ts2phc**) as grandmaster clock (T-GM) by creating a **PtpConfig** custom resource (CR) that configures the host NIC.

The **ts2phc** utility allows you to synchronize the system clock with the PTP grandmaster clock so that the node can stream precision clock signal to downstream PTP ordinary clocks and boundary clocks.



NOTE

Use the following example **PtpConfig** CR as the basis to configure **linuxptp** services as T-GM for an Intel Westport Channel E810-XXVDA4T network interface.

To configure PTP fast events, set appropriate values for **ptp4lOpts**, **ptp4lConf**, and **ptpClockThreshold**. **ptpClockThreshold** is used only when events are enabled. See "Configuring the PTP fast event notifications publisher" for more information.

Prerequisites

- For T-GM clocks in production environments, install an Intel E810 Westport Channel NIC in the bare-metal cluster host.
- Install the OpenShift CLI (**oc**).
- Log in as a user with **cluster-admin** privileges.
- Install the PTP Operator.

Procedure

1. Create the **PtpConfig** CR. For example:
 - a. Depending on your requirements, use one of the following T-GM configurations for your deployment. Save the YAML in the **grandmaster-clock-ptp-config.yaml** file:

Example 21.1. Example PTP grandmaster clock configuration

```
apiVersion: ptp.openshift.io/v1
kind: PtpConfig
metadata:
  name: grandmaster
  namespace: openshift-ptp
spec:
```

```

profile:
- name: "grandmaster"
  ptp4lOpts: "-2 --summary_interval -4"
  phc2sysOpts: "-r -u 0 -m -O -37 -N 8 -R 16 -s $iface_master -n 24"
  ptpSchedulingPolicy: SCHED_FIFO
  ptpSchedulingPriority: 10
  ptpSettings:
    logReduce: "true"
  plugins:
    e810:
      enableDefaultConfig: false
      settings:
        LocalMaxHoldoverOffSet: 1500
        LocalHoldoverTimeout: 14400
        MaxInSpecOffset: 100
      pins: $e810_pins
      # "$iface_master":
      # "U.FL2": "0 2"
      # "U.FL1": "0 1"
      # "SMA2": "0 2"
      # "SMA1": "0 1"
    ublxCmds:
      - args: #ubxtool -P 29.20 -z CFG-HW-ANT_CFG_VOLTCTRL,1
        - "-P"
        - "29.20"
        - "-z"
        - "CFG-HW-ANT_CFG_VOLTCTRL,1"
        reportOutput: false
      - args: #ubxtool -P 29.20 -e GPS
        - "-P"
        - "29.20"
        - "-e"
        - "GPS"
        reportOutput: false
      - args: #ubxtool -P 29.20 -d Galileo
        - "-P"
        - "29.20"
        - "-d"
        - "Galileo"
        reportOutput: false
      - args: #ubxtool -P 29.20 -d GLONASS
        - "-P"
        - "29.20"
        - "-d"
        - "GLONASS"
        reportOutput: false
      - args: #ubxtool -P 29.20 -d BeiDou
        - "-P"
        - "29.20"
        - "-d"
        - "BeiDou"
        reportOutput: false
      - args: #ubxtool -P 29.20 -d SBAS
        - "-P"
        - "29.20"
        - "-d"

```

```

- "SBAS"
reportOutput: false
- args: #ubxtool -P 29.20 -t -w 5 -v 1 -e SURVEYIN,600,50000
  - "-P"
  - "29.20"
  - "-t"
  - "-w"
  - "5"
  - "-v"
  - "1"
  - "-e"
  - "SURVEYIN,600,50000"
reportOutput: true
- args: #ubxtool -P 29.20 -p MON-HW
  - "-P"
  - "29.20"
  - "-p"
  - "MON-HW"
reportOutput: true
ts2phcOpts: " "
ts2phcConf: |
[nmea]
ts2phc.master 1
[global]
use_syslog 0
verbose 1
logging_level 7
ts2phc.pulsewidth 100000000
ts2phc.nmea_serialport $gnss_serialport
leapfile /usr/share/zoneinfo/leap-seconds.list
[$iface_master]
ts2phc.extts_polarity rising
ts2phc.extts_correction 0
ptp4lConf: |
[$iface_master]
masterOnly 1
[$iface_master_1]
masterOnly 1
[$iface_master_2]
masterOnly 1
[$iface_master_3]
masterOnly 1
[global]
#
# Default Data Set
#
twoStepFlag 1
priority1 128
priority2 128
domainNumber 24
#utc_offset 37
clockClass 6
clockAccuracy 0x27
offsetScaledLogVariance 0xFFFF
free_running 0
freq_est_interval 1

```

```
dscp_event 0
dscp_general 0
dataset_comparison G.8275.x
G.8275.defaultDS.localPriority 128
#
# Port Data Set
#
logAnnounceInterval -3
logSyncInterval -4
logMinDelayReqInterval -4
logMinPdelayReqInterval 0
announceReceiptTimeout 3
syncReceiptTimeout 0
delayAsymmetry 0
fault_reset_interval -4
neighborPropDelayThresh 20000000
masterOnly 0
G.8275.portDS.localPriority 128
#
# Run time options
#
assume_two_step 0
logging_level 6
path_trace_enabled 0
follow_up_info 0
hybrid_e2e 0
inhibit_multicast_service 0
net_sync_monitor 0
tc_spanning_tree 0
tx_timestamp_timeout 50
unicast_listen 0
unicast_master_table 0
unicast_req_duration 3600
use_syslog 1
verbose 0
summary_interval -4
kernel_leap 1
check_fup_sync 0
clock_class_threshold 7
#
# Servo Options
#
pi_proportional_const 0.0
pi_integral_const 0.0
pi_proportional_scale 0.0
pi_proportional_exponent -0.3
pi_proportional_norm_max 0.7
pi_integral_scale 0.0
pi_integral_exponent 0.4
pi_integral_norm_max 0.3
step_threshold 2.0
first_step_threshold 0.00002
clock_servo pi
sanity_freq_limit 200000000
ntpshm_segment 0
#
```

```

# Transport options
#
transportSpecific 0x0
ptp_dst_mac 01:1B:19:00:00:00
p2p_dst_mac 01:80:C2:00:00:0E
udp_ttl 1
udp6_scope 0x0E
uds_address /var/run/ptp4l
#
# Default interface options
#
clock_type BC
network_transport L2
delay_mechanism E2E
time_stamping hardware
tsproc_mode filter
delay_filter moving_median
delay_filter_length 10
egressLatency 0
ingressLatency 0
boundary_clock_jbod 0
#
# Clock description
#
productDescription ;;
revisionData ;;
manufacturerIdentity 00:00:00
userDescription ;
timeSource 0x20
recommend:
- profile: "grandmaster"
  priority: 4
  match:
  - nodeLabel: "node-role.kubernetes.io/$mcp"

```

**NOTE**

The example PTP grandmaster clock configuration is for test purposes only and is not intended for production.

Example 21.2. PTP grandmaster clock configuration for E810 NIC

```

apiVersion: ptp.openshift.io/v1
kind: PtpConfig
metadata:
  name: grandmaster
  namespace: openshift-ptp
spec:
  profile:
  - name: "grandmaster"
    ptp4lOpts: "-2 --summary_interval -4"
    phc2sysOpts: "-r -u 0 -m -O -37 -N 8 -R 16 -s $iface_master -n 24"
    ptpSchedulingPolicy: SCHED_FIFO

```



```

ptpSchedulingPriority: 10
ptpSettings:
  logReduce: "true"
plugins:
  e810:
    enableDefaultConfig: false
    settings:
      LocalMaxHoldoverOffSet: 1500
      LocalHoldoverTimeout: 14400
      MaxInSpecOffset: 100
    pins: $e810_pins
    # "$iface_master":
    # "U.FL2": "0 2"
    # "U.FL1": "0 1"
    # "SMA2": "0 2"
    # "SMA1": "0 1"
    ublxCmds:
      - args: #ubxtool -P 29.20 -z CFG-HW-ANT_CFG_VOLTCTRL,1
        - "-P"
        - "29.20"
        - "-z"
        - "CFG-HW-ANT_CFG_VOLTCTRL,1"
      reportOutput: false
      - args: #ubxtool -P 29.20 -e GPS
        - "-P"
        - "29.20"
        - "-e"
        - "GPS"
      reportOutput: false
      - args: #ubxtool -P 29.20 -d Galileo
        - "-P"
        - "29.20"
        - "-d"
        - "Galileo"
      reportOutput: false
      - args: #ubxtool -P 29.20 -d GLONASS
        - "-P"
        - "29.20"
        - "-d"
        - "GLONASS"
      reportOutput: false
      - args: #ubxtool -P 29.20 -d BeiDou
        - "-P"
        - "29.20"
        - "-d"
        - "BeiDou"
      reportOutput: false
      - args: #ubxtool -P 29.20 -d SBAS
        - "-P"
        - "29.20"
        - "-d"
        - "SBAS"
      reportOutput: false
      - args: #ubxtool -P 29.20 -t -w 5 -v 1 -e SURVEYIN,600,50000
        - "-P"
        - "29.20"

```

```

- "-t"
- "-w"
- "5"
- "-v"
- "1"
- "-e"
- "SURVEYIN,600,50000"
reportOutput: true
- args: #ubxtool -P 29.20 -p MON-HW
- "-P"
- "29.20"
- "-p"
- "MON-HW"
reportOutput: true
ts2phcOpts: " "
ts2phcConf: |
[nmea]
ts2phc.master 1
[global]
use_syslog 0
verbose 1
logging_level 7
ts2phc.pulsewidth 100000000
ts2phc.nmea_serialport $gnss_serialport
leapfile /usr/share/zoneinfo/leap-seconds.list
[$iface_master]
ts2phc.extts_polarity rising
ts2phc.extts_correction 0
ptp4lConf: |
[$iface_master]
masterOnly 1
[$iface_master_1]
masterOnly 1
[$iface_master_2]
masterOnly 1
[$iface_master_3]
masterOnly 1
[global]
#
# Default Data Set
#
twoStepFlag 1
priority1 128
priority2 128
domainNumber 24
#utc_offset 37
clockClass 6
clockAccuracy 0x27
offsetScaledLogVariance 0xFFFF
free_running 0
freq_est_interval 1
dscp_event 0
dscp_general 0
dataset_comparison G.8275.x
G.8275.defaultDS.localPriority 128
#

```

```
# Port Data Set
#
logAnnounceInterval -3
logSyncInterval -4
logMinDelayReqInterval -4
logMinPdelayReqInterval 0
announceReceiptTimeout 3
syncReceiptTimeout 0
delayAsymmetry 0
fault_reset_interval -4
neighborPropDelayThresh 20000000
masterOnly 0
G.8275.portDS.localPriority 128
#
# Run time options
#
assume_two_step 0
logging_level 6
path_trace_enabled 0
follow_up_info 0
hybrid_e2e 0
inhibit_multicast_service 0
net_sync_monitor 0
tc_spanning_tree 0
tx_timestamp_timeout 50
unicast_listen 0
unicast_master_table 0
unicast_req_duration 3600
use_syslog 1
verbose 0
summary_interval -4
kernel_leap 1
check_fup_sync 0
clock_class_threshold 7
#
# Servo Options
#
pi_proportional_const 0.0
pi_integral_const 0.0
pi_proportional_scale 0.0
pi_proportional_exponent -0.3
pi_proportional_norm_max 0.7
pi_integral_scale 0.0
pi_integral_exponent 0.4
pi_integral_norm_max 0.3
step_threshold 2.0
first_step_threshold 0.00002
clock_servo pi
sanity_freq_limit 200000000
ntpshm_segment 0
#
# Transport options
#
transportSpecific 0x0
ptp_dst_mac 01:1B:19:00:00:00
p2p_dst_mac 01:80:C2:00:00:0E
```

```

udp_ttl 1
udp6_scope 0x0E
uds_address /var/run/ptp4l
#
# Default interface options
#
clock_type BC
network_transport L2
delay_mechanism E2E
time_stamping hardware
tsproc_mode filter
delay_filter moving_median
delay_filter_length 10
egressLatency 0
ingressLatency 0
boundary_clock_jbod 0
#
# Clock description
#
productDescription ;;
revisionData ;;
manufacturerIdentity 00:00:00
userDescription ;
timeSource 0x20
recommend:
- profile: "grandmaster"
  priority: 4
  match:
  - nodeLabel: "node-role.kubernetes.io/$mcp"

```



NOTE

For E810 Westport Channel NICs, set the value for **ts2phc.nmea_serialport** to **/dev/gnss0**.

- b. Create the CR by running the following command:

```
$ oc create -f grandmaster-clock-ntp-config.yaml
```

Verification

1. Check that the **PtpConfig** profile is applied to the node.
 - a. Get the list of pods in the **openshift-ntp** namespace by running the following command:

```
$ oc get pods -n openshift-ntp -o wide
```

Example output

```

NAME                                READY STATUS RESTARTS AGE IP           NODE
linuxntp-daemon-74m2g              3/3   Running  3     4d15h 10.16.230.7  compute-
1.example.com

```

```
ptp-operator-5f4f48d7c-x7z kf 1/1 Running 1 4d15h 10.128.1.145 compute-1.example.com
```

- b. Check that the profile is correct. Examine the logs of the **linuxptp** daemon that corresponds to the node you specified in the **PtpConfig** profile. Run the following command:

```
$ oc logs linuxptp-daemon-74m2g -n openshift-ptp -c linuxptp-daemon-container
```

Example output

```
ts2phc[94980.334]: [ts2phc.0.config] nmea delay: 98690975 ns
ts2phc[94980.334]: [ts2phc.0.config] ens3f0 extts index 0 at 1676577329.999999999 corr
0 src 1676577330.901342528 diff -1
ts2phc[94980.334]: [ts2phc.0.config] ens3f0 master offset -1 s2 freq -1
ts2phc[94980.441]: [ts2phc.0.config] nmea sentence:
GNRMC,195453.00,A,4233.24427,N,07126.64420,W,0.008,,160223,,,A,V
phc2sys[94980.450]: [ptp4l.0.config] CLOCK_REALTIME phc offset 943 s2 freq -
89604 delay 504
phc2sys[94980.512]: [ptp4l.0.config] CLOCK_REALTIME phc offset 1000 s2 freq -
89264 delay 474
```

21.2.6. Configuring linuxptp services as a grandmaster clock for dual E810 Westport Channel NICs

You can configure the **linuxptp** services (**ptp4l**, **phc2sys**, **ts2phc**) as grandmaster clock (T-GM) for dual E810 Westport Channel NICs by creating a **PtpConfig** custom resource (CR) that configures the host NICs.

For distributed RAN (D-RAN) use cases, you can configure PTP for dual NICs as follows:

- NIC one is synced to the global navigation satellite system (GNSS) time source.
- NIC two is synced to the 1PPS timing output provided by NIC one. This configuration is provided by the PTP hardware plugin in the **PtpConfig** CR.

The dual NIC PTP T-GM configuration uses a single instance of **ptp4l** and one **ts2phc** process reporting two **ts2phc** instances, one for each NIC. The host system clock is synchronized from the NIC that is connected to the GNSS time source.

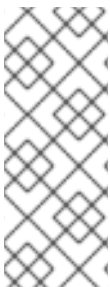

NOTE

Use the following example **PtpConfig** CR as the basis to configure **linuxptp** services as T-GM for dual Intel Westport Channel E810-XXVDA4T network interfaces.

To configure PTP fast events, set appropriate values for **ptp4lOpts**, **ptp4lConf**, and **ptpClockThreshold**. **ptpClockThreshold** is used only when events are enabled. See "Configuring the PTP fast event notifications publisher" for more information.

Prerequisites

- For T-GM clocks in production environments, install two Intel E810 Westport Channel NICs in the bare-metal cluster host.

- Install the OpenShift CLI (**oc**).
- Log in as a user with **cluster-admin** privileges.
- Install the PTP Operator.

Procedure

1. Create the **PtpConfig** CR. For example:
 - a. Save the following YAML in the **grandmaster-clock-ptp-config-dual-nics.yaml** file:

Example 21.3. PTP grandmaster clock configuration for dual E810 NICs

```

apiVersion: ptp.openshift.io/v1
kind: PtpConfig
metadata:
  name: grandmaster
  namespace: openshift-ptp
  annotations:
    ran.openshift.io/ztp-deploy-wave: "10"
spec:
  profile:
  - name: "grandmaster"
    ptp4lOpts: "-2 --summary_interval -4"
    phc2sysOpts: "-r -u 0 -m -O -37 -N 8 -R 16 -s $iface_nic1 -n 24"
    ptpSchedulingPolicy: SCHED_FIFO
    ptpSchedulingPriority: 10
    ptpSettings:
      logReduce: "true"
  plugins:
    e810:
      enableDefaultConfig: false
      settings:
        LocalMaxHoldoverOffSet: 1500
        LocalHoldoverTimeout: 14400
        MaxInSpecOffset: 100
      pins:
        "$iface_nic1":
          "U.FL2": "0 2"
          "U.FL1": "0 1"
          "SMA2": "0 2"
          "SMA1": "2 1"
        "$iface_nic2":
          "U.FL2": "0 2"
          "U.FL1": "0 1"
          "SMA2": "0 2"
          "SMA1": "1 1"
    ublxCmds:
      - args: #ubxtool -P 29.20 -z CFG-HW-ANT_CFG_VOLTCTRL,1
        - "-P"
        - "29.20"
        - "-z"
        - "CFG-HW-ANT_CFG_VOLTCTRL,1"
      reportOutput: false
      - args: #ubxtool -P 29.20 -e GPS
        - "-P"

```

```

- "29.20"
- "-e"
- "GPS"
reportOutput: false
- args: #ubxtool -P 29.20 -d Galileo
  - "-P"
  - "29.20"
  - "-d"
  - "Galileo"
reportOutput: false
- args: #ubxtool -P 29.20 -d GLONASS
  - "-P"
  - "29.20"
  - "-d"
  - "GLONASS"
reportOutput: false
- args: #ubxtool -P 29.20 -d BeiDou
  - "-P"
  - "29.20"
  - "-d"
  - "BeiDou"
reportOutput: false
- args: #ubxtool -P 29.20 -d SBAS
  - "-P"
  - "29.20"
  - "-d"
  - "SBAS"
reportOutput: false
- args: #ubxtool -P 29.20 -t -w 5 -v 1 -e SURVEYIN,600,50000
  - "-P"
  - "29.20"
  - "-t"
  - "-w"
  - "5"
  - "-v"
  - "1"
  - "-e"
  - "SURVEYIN,600,50000"
reportOutput: true
- args: #ubxtool -P 29.20 -p MON-HW
  - "-P"
  - "29.20"
  - "-p"
  - "MON-HW"
reportOutput: true
ts2phcOpts: " "
ts2phcConf: |
[nmea]
ts2phc.master 1
[global]
use_syslog 0
verbose 1
logging_level 7
ts2phc.pulsewidth 100000000
#cat /dev/GNSS to find available serial port
#example value of gnss_serialport is /dev/ttyGNSS_1700_0

```

```
ts2phc.nmea_serialport $gnss_serialport
leapfile /usr/share/zoneinfo/leap-seconds.list
[$iface_nic1]
ts2phc.extts_polarity rising
ts2phc.extts_correction 0
[$iface_nic2]
ts2phc.master 0
ts2phc.extts_polarity rising
#this is a measured value in nanoseconds to compensate for SMA cable delay
ts2phc.extts_correction -10
ptp4lConf: |
[$iface_nic1]
masterOnly 1
[$iface_nic1_1]
masterOnly 1
[$iface_nic1_2]
masterOnly 1
[$iface_nic1_3]
masterOnly 1
[$iface_nic2]
masterOnly 1
[$iface_nic2_1]
masterOnly 1
[$iface_nic2_2]
masterOnly 1
[$iface_nic2_3]
masterOnly 1
[global]
#
# Default Data Set
#
twoStepFlag 1
priority1 128
priority2 128
domainNumber 24
#utc_offset 37
clockClass 6
clockAccuracy 0x27
offsetScaledLogVariance 0xFFFF
free_running 0
freq_est_interval 1
dscp_event 0
dscp_general 0
dataset_comparison G.8275.x
G.8275.defaultDS.localPriority 128
#
# Port Data Set
#
logAnnounceInterval -3
logSyncInterval -4
logMinDelayReqInterval -4
logMinPdelayReqInterval 0
announceReceiptTimeout 3
syncReceiptTimeout 0
delayAsymmetry 0
fault_reset_interval -4
```



```
neighborPropDelayThresh 20000000
masterOnly 0
G.8275.portDS.localPriority 128
#
# Run time options
#
assume_two_step 0
logging_level 6
path_trace_enabled 0
follow_up_info 0
hybrid_e2e 0
inhibit_multicast_service 0
net_sync_monitor 0
tc_spanning_tree 0
tx_timestamp_timeout 50
unicast_listen 0
unicast_master_table 0
unicast_req_duration 3600
use_syslog 1
verbose 0
summary_interval -4
kernel_leap 1
check_fup_sync 0
clock_class_threshold 7
#
# Servo Options
#
pi_proportional_const 0.0
pi_integral_const 0.0
pi_proportional_scale 0.0
pi_proportional_exponent -0.3
pi_proportional_norm_max 0.7
pi_integral_scale 0.0
pi_integral_exponent 0.4
pi_integral_norm_max 0.3
step_threshold 2.0
first_step_threshold 0.00002
clock_servo pi
sanity_freq_limit 200000000
ntpshm_segment 0
#
# Transport options
#
transportSpecific 0x0
ptp_dst_mac 01:1B:19:00:00:00
p2p_dst_mac 01:80:C2:00:00:0E
udp_ttl 1
udp6_scope 0x0E
uds_address /var/run/ptp4l
#
# Default interface options
#
clock_type BC
network_transport L2
delay_mechanism E2E
time_stamping hardware
```

```

tsproc_mode filter
delay_filter moving_median
delay_filter_length 10
egressLatency 0
ingressLatency 0
boundary_clock_jbod 1
#
# Clock description
#
productDescription ;;
revisionData ;;
manufacturerIdentity 00:00:00
userDescription ;
timeSource 0x20
recommend:
- profile: "grandmaster"
priority: 4
match:
- nodeLabel: "node-role.kubernetes.io/$mcp"

```

**NOTE**

For E810 Westport Channel NICs, set the value for **ts2phc.nmea_serialport** to **/dev/gnss0**.

- b. Create the CR by running the following command:

```
$ oc create -f grandmaster-clock-ntp-config-dual-nics.yaml
```

Verification

1. Check that the **PtpConfig** profile is applied to the node.
 - a. Get the list of pods in the **openshift-ntp** namespace by running the following command:

```
$ oc get pods -n openshift-ntp -o wide
```

Example output

```

NAME                                READY STATUS RESTARTS AGE IP           NODE
linuxntp-daemon-74m2g              3/3   Running 3     4d15h 10.16.230.7 compute-1.example.com
ntp-operator-5f4f48d7c-x7zkg      1/1   Running 1     4d15h 10.128.1.145 compute-1.example.com

```

- b. Check that the profile is correct. Examine the logs of the **linuxntp** daemon that corresponds to the node you specified in the **PtpConfig** profile. Run the following command:

```
$ oc logs linuxntp-daemon-74m2g -n openshift-ntp -c linuxntp-daemon-container
```

Example output

```

ts2phc[509863.660]: [ts2phc.0.config] nmea delay: 347527248 ns
ts2phc[509863.660]: [ts2phc.0.config] ens2f0 extts index 0 at 1705516553.000000000
corr 0 src 1705516553.652499081 diff 0
ts2phc[509863.660]: [ts2phc.0.config] ens2f0 master offset      0 s2 freq    -0
l0117 18:35:16.000146 1633226 stats.go:57] state updated for ts2phc =s2
l0117 18:35:16.000163 1633226 event.go:417] dpII State s2, gnss State s2, tsphc state
s2, gm state s2,
ts2phc[1705516516]:[ts2phc.0.config] ens2f0 nmea_status 1 offset 0 s2
GM[1705516516]:[ts2phc.0.config] ens2f0 T-GM-STATUS s2
ts2phc[509863.677]: [ts2phc.0.config] ens7f0 extts index 0 at 1705516553.000000010
corr -10 src 1705516553.652499081 diff 0
ts2phc[509863.677]: [ts2phc.0.config] ens7f0 master offset      0 s2 freq    -0
l0117 18:35:16.016597 1633226 stats.go:57] state updated for ts2phc =s2
phc2sys[509863.719]: [ptp4l.0.config] CLOCK_REALTIME phc offset    -6 s2 freq
+15441 delay    510
phc2sys[509863.782]: [ptp4l.0.config] CLOCK_REALTIME phc offset    -7 s2 freq
+15438 delay    502

```

Additional resources

- [Configuring the PTP fast event notifications publisher](#)

21.2.6.1. Grandmaster clock PtpConfig configuration reference

The following reference information describes the configuration options for the **PtpConfig** custom resource (CR) that configures the **linuxptp** services (**ptp4l**, **phc2sys**, **ts2phc**) as a grandmaster clock.

Table 21.1. PtpConfig configuration options for PTP Grandmaster clock

PtpConfig CR field	Description
plugins	<p>Specify an array of .exec.cmdline options that configure the NIC for grandmaster clock operation. Grandmaster clock configuration requires certain PTP pins to be disabled.</p> <p>The plugin mechanism allows the PTP Operator to do automated hardware configuration. For the Intel Westport Channel NIC, when enableDefaultConfig is true, The PTP Operator runs a hard-coded script to do the required configuration for the NIC.</p>
ptp4lOpts	<p>Specify system configuration options for the ptp4l service. The options should not include the network interface name -i <interface> and service config file -f /etc/ptp4l.conf because the network interface name and the service config file are automatically appended.</p>
ptp4lConf	<p>Specify the required configuration to start ptp4l as a grandmaster clock. For example, the ens2f1 interface synchronizes downstream connected devices. For grandmaster clocks, set clockClass to 6 and set clockAccuracy to 0x27. Set timeSource to 0x20 for when receiving the timing signal from a Global navigation satellite system (GNSS).</p>
tx_timestamp_timeout	<p>Specify the maximum amount of time to wait for the transmit (TX) timestamp from the sender before discarding the data.</p>

PtpConfig CR field	Description
boundary_clock_jbod	Specify the JBOD boundary clock time delay value. This value is used to correct the time values that are passed between the network time devices.
phc2sysOpts	<p>Specify system config options for the phc2sys service. If this field is empty the PTP Operator does not start the phc2sys service.</p> <div style="display: flex; align-items: flex-start;">  <div> <p>NOTE</p> <p>Ensure that the network interface listed here is configured as grandmaster and is referenced as required in the ts2phcConf and ptp4lConf fields.</p> </div> </div>
ptpSchedulingPolicy	Configure the scheduling policy for ptp4l and phc2sys processes. Default value is SCHED_OTHER . Use SCHED_FIFO on systems that support FIFO scheduling.
ptpSchedulingPriority	Set an integer value from 1-65 to configure FIFO priority for ptp4l and phc2sys processes when ptpSchedulingPolicy is set to SCHED_FIFO . The ptpSchedulingPriority field is not used when ptpSchedulingPolicy is set to SCHED_OTHER .
ptpClockThreshold	Optional. If ptpClockThreshold stanza is not present, default values are used for ptpClockThreshold fields. Stanza shows default ptpClockThreshold values. ptpClockThreshold values configure how long after the PTP master clock is disconnected before PTP events are triggered. holdOverTimeout is the time value in seconds before the PTP clock event state changes to FREERUN when the PTP master clock is disconnected. The maxOffsetThreshold and minOffsetThreshold settings configure offset values in nanoseconds that compare against the values for CLOCK_REALTIME (phc2sys) or master offset (ptp4l). When the ptp4l or phc2sys offset value is outside this range, the PTP clock state is set to FREERUN . When the offset value is within this range, the PTP clock state is set to LOCKED .
ts2phcConf	<p>Sets the configuration for the ts2phc command.</p> <p>leapfile is the default path to the current leap seconds definition file in the PTP Operator container image.</p> <p>ts2phc.nmea_serialport is the serial port device that is connected to the NMEA GPS clock source. When configured, the GNSS receiver is accessible on /dev/gnss<id>. If the host has multiple GNSS receivers, you can find the correct device by enumerating either of the following devices:</p> <ul style="list-style-type: none"> ● /sys/class/net/<eth_port>/device/gnss/ ● /sys/class/gnss/gnss<id>/device/
ts2phcOpts	Set options for the ts2phc command.

PtpConfig CR field	Description
recommend	Specify an array of one or more recommend objects that define rules on how the profile should be applied to nodes.
.recommend.profile	Specify the .recommend.profile object name that is defined in the profile section.
.recommend.priority	Specify the priority with an integer value between 0 and 99 . A larger number gets lower priority, so a priority of 99 is lower than a priority of 10 . If a node can be matched with multiple profiles according to rules defined in the match field, the profile with the higher priority is applied to that node.
.recommend.match	Specify .recommend.match rules with nodeLabel or nodeName values.
.recommend.match.nodeLabel	Set nodeLabel with the key of the node.Labels field from the node object by using the oc get nodes --show-labels command. For example, node-role.kubernetes.io/worker .
.recommend.match.nodeName	Set nodeName with the value of the node.Name field from the node object by using the oc get nodes command. For example, compute-1.example.com .

21.2.6.2. Grandmaster clock class sync state reference

The following table describes the PTP grandmaster clock (T-GM) **gm.ClockClass** states. Clock class states categorize T-GM clocks based on their accuracy and stability with regard to the Primary Reference Time Clock (PRTC) or other timing source.

Holdover specification is the amount of time a PTP clock can maintain synchronization without receiving updates from the primary time source.

Table 21.2. T-GM clock class states

Clock class state	Description
gm.ClockClass 6	T-GM clock is connected to a PRTC in LOCKED mode. For example, the PRTC is traceable to a GNSS time source.
gm.ClockClass 7	T-GM clock is in HOLDOVER mode, and within holdover specification. The clock source might not be traceable to a category 1 frequency source.
gm.ClockClass 140	T-GM clock is in HOLDOVER mode, is out of holdover specification, but it is still traceable to the category 1 frequency source.
gm.ClockClass 248	T-GM clock is in FREERUN mode.

For more information, see ["Phase/time traceability information", ITU-T G.8275.1/Y.1369.1 Recommendations](#).

21.2.6.3. Intel Westport Channel E810 hardware configuration reference

Use this information to understand how to use the [Intel E810-XXVDA4T hardware plugin](#) to configure the E810 network interface as PTP grandmaster clock. Hardware pin configuration determines how the network interface interacts with other components and devices in the system. The E810-XXVDA4T NIC has four connectors for external 1PPS signals: **SMA1**, **SMA2**, **U.FL1**, and **U.FL2**.

Table 21.3. Intel E810 NIC hardware connectors configuration

Hardware pin	Recommended setting	Description
U.FL1	0 1	Disables the U.FL1 connector input. The U.FL1 connector is output-only.
U.FL2	0 2	Disables the U.FL2 connector output. The U.FL2 connector is input-only.
SMA1	0 1	Disables the SMA1 connector input. The SMA1 connector is bidirectional.
SMA2	0 2	Disables the SMA2 connector output. The SMA2 connector is bidirectional.

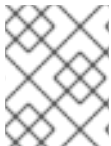

NOTE

SMA1 and **U.FL1** connectors share channel one. **SMA2** and **U.FL2** connectors share channel two.

Set **spec.profile.plugins.e810.ubloxCmds** parameters to configure the GNSS clock in the **PtpConfig** custom resource (CR). Each of these **ubloxCmds** stanzas correspond to a configuration that is applied to the host NIC by using **ubxtool** commands. For example:

```
ubloxCmds:
  - args: #ubxtool -P 29.20 -z CFG-HW-ANT_CFG_VOLTCTRL,1
    - "-p"
    - "29.20"
    - "-z"
    - "CFG-HW-ANT_CFG_VOLTCTRL,1"
  reportOutput: false
```

The following table describes the equivalent **ubxtool** commands:

Table 21.4. Intel E810 ubloxCmds configuration

ubxtool command	Description
-----------------	-------------

ubxtool command	Description
ubxtool -P 29.20 -z CFG-HW-ANT_CFG_VOLTCTRL,1	Enables antenna voltage control. Enables antenna status to be reported in the UBX-MON-RF and UBX-INF-NOTICE log messages.
ubxtool -P 29.20 -e GPS	Enables the antenna to receive GPS signals.
ubxtool -P 29.20 -d Galileo	Configures the antenna to receive signal from the Galileo GPS satellite.
ubxtool -P 29.20 -d GLONASS	Disables the antenna from receiving signal from the GLONASS GPS satellite.
ubxtool -P 29.20 -d BeiDou	Disables the antenna from receiving signal from the BeiDou GPS satellite.
ubxtool -P 29.20 -d SBAS	Disables the antenna from receiving signal from the SBAS GPS satellite.
ubxtool -P 29.20 -t -w 5 -v 1 -e SURVEYIN,600,50000	Configures the GNSS receiver survey-in process to improve its initial position estimate. This can take up to 24 hours to achieve an optimal result.
ubxtool -P 29.20 -p MON-HW	Runs a single automated scan of the hardware and reports on the NIC state and configuration settings.

The E810 plugin implements the following interfaces:

Table 21.5. E810 plugin interfaces

Interface	Description
OnPTPConfigChangeE810	Runs whenever you update the PtpConfig CR. The function parses the plugin options and applies the required configurations to the network device pins based on the configuration data.
AfterRunPTPCommandE810	Runs after launching the PTP processes and running the gpspipe PTP command. The function processes the plugin options and runs ubxtool commands, storing the output in the plugin-specific data.
PopulateHwConfigE810	Populates the NodePtpDevice CR based on hardware-specific data in the PtpConfig CR.

The E810 plugin has the following structs and variables:

Table 21.6. E810 plugin structs and variables

Struct	Description
E810Opts	Represents options for the E810 plugin, including boolean flags and a map of network device pins.
E810UblxCmds	Represents configurations for ubxtool commands with a boolean flag and a slice of strings for command arguments.
E810PluginData	Holds plugin-specific data used during plugin execution.

21.2.6.4. Dual E810 Westport Channel NIC configuration reference

Use this information to understand how to use the [Intel E810-XXVDA4T hardware plugin](#) to configure a pair of E810 network interfaces as PTP grandmaster clock (T-GM).

Before you configure the dual NIC cluster host, you must connect the two NICs with an SMA1 cable using the 1PPS faceplate connections.

When you configure a dual NIC T-GM, you need to compensate for the 1PPS signal delay that occurs when you connect the NICs using the SMA1 connection ports. Various factors such as cable length, ambient temperature, and component and manufacturing tolerances can affect the signal delay. To compensate for the delay, you must calculate the specific value that you use to offset the signal delay.

Table 21.7. E810 dual NIC T-GM PtpConfig CR reference

PtpConfig field	Description
spec.profile.plugins.e810.pins	Configure the E810 hardware pins using the PTP Operator E810 hardware plugin. <ul style="list-style-type: none"> Pin 2 1 enables the 1PPS OUT connection for SMA1 on NIC one. Pin 1 1 enables the 1PPS IN connection for SMA1 on NIC two.
spec.profile.ts2phcConf	Use the ts2phcConf field to configure parameters for NIC one and NIC two. Set ts2phc.master 0 for NIC two. This configures the timing source for NIC two from the 1PPS input, not GNSS. Configure the ts2phc.extts_correction value for NIC two to compensate for the delay that is incurred for the specific SMA cable and cable length that you use. The value that you configure depends on your specific measurements and SMA1 cable length.
spec.profile.ptp4lConf	Set the value of boundary_clock_jbod to 1 to enable support for multiple NICs.

21.2.7. Configuring linuxptp services as a boundary clock

You can configure the **linuxptp** services (**ptp4l**, **phc2sys**) as boundary clock by creating a **PtpConfig** custom resource (CR) object.



NOTE

Use the following example **PtpConfig** CR as the basis to configure **linuxptp** services as the boundary clock for your particular hardware and environment. This example CR does not configure PTP fast events. To configure PTP fast events, set appropriate values for **ptp4IOpts**, **ptp4IConf**, and **ptpClockThreshold**. **ptpClockThreshold** is used only when events are enabled. See "Configuring the PTP fast event notifications publisher" for more information.

Prerequisites

- Install the OpenShift CLI (**oc**).
- Log in as a user with **cluster-admin** privileges.
- Install the PTP Operator.

Procedure

1. Create the following **PtpConfig** CR, and then save the YAML in the **boundary-clock-ptp-config.yaml** file.

Example PTP boundary clock configuration

```

apiVersion: ptp.openshift.io/v1
kind: PtpConfig
metadata:
  name: boundary-clock
  namespace: openshift-ptp
  annotations: {}
spec:
  profile:
    - name: boundary-clock
      ptp4IOpts: "-2"
      phc2sysOpts: "-a -r -n 24"
      ptpSchedulingPolicy: SCHED_FIFO
      ptpSchedulingPriority: 10
      ptpSettings:
        logReduce: "true"
      ptp4IConf: |
        # The interface name is hardware-specific
        [iface_slave]
        masterOnly 0
        [iface_master_1]
        masterOnly 1
        [iface_master_2]
        masterOnly 1
        [iface_master_3]
        masterOnly 1
        [global]
        #
        # Default Data Set
        #
        twoStepFlag 1
        slaveOnly 0
        priority1 128
  
```

```
priority2 128
domainNumber 24
#utc_offset 37
clockClass 248
clockAccuracy 0xFE
offsetScaledLogVariance 0xFFFF
free_running 0
freq_est_interval 1
dscp_event 0
dscp_general 0
dataset_comparison G.8275.x
G.8275.defaultDS.localPriority 128
#
# Port Data Set
#
logAnnounceInterval -3
logSyncInterval -4
logMinDelayReqInterval -4
logMinPdelayReqInterval -4
announceReceiptTimeout 3
syncReceiptTimeout 0
delayAsymmetry 0
fault_reset_interval -4
neighborPropDelayThresh 20000000
masterOnly 0
G.8275.portDS.localPriority 128
#
# Run time options
#
assume_two_step 0
logging_level 6
path_trace_enabled 0
follow_up_info 0
hybrid_e2e 0
inhibit_multicast_service 0
net_sync_monitor 0
tc_spanning_tree 0
tx_timestamp_timeout 50
unicast_listen 0
unicast_master_table 0
unicast_req_duration 3600
use_syslog 1
verbose 0
summary_interval 0
kernel_leap 1
check_fup_sync 0
clock_class_threshold 135
#
# Servo Options
#
pi_proportional_const 0.0
pi_integral_const 0.0
pi_proportional_scale 0.0
pi_proportional_exponent -0.3
pi_proportional_norm_max 0.7
pi_integral_scale 0.0
```

```

pi_integral_exponent 0.4
pi_integral_norm_max 0.3
step_threshold 2.0
first_step_threshold 0.00002
max_frequency 900000000
clock_servo pi
sanity_freq_limit 200000000
ntpshm_segment 0
#
# Transport options
#
transportSpecific 0x0
ptp_dst_mac 01:1B:19:00:00:00
p2p_dst_mac 01:80:C2:00:00:0E
udp_ttl 1
udp6_scope 0x0E
uds_address /var/run/ptp4l
#
# Default interface options
#
clock_type BC
network_transport L2
delay_mechanism E2E
time_stamping hardware
tsproc_mode filter
delay_filter moving_median
delay_filter_length 10
egressLatency 0
ingressLatency 0
boundary_clock_jbod 0
#
# Clock description
#
productDescription ;;
revisionData ;;
manufacturerIdentity 00:00:00
userDescription ;
timeSource 0xA0
recommend:
- profile: boundary-clock
  priority: 4
match:
- nodeLabel: "node-role.kubernetes.io/$mcp"

```

Table 21.8. PTP boundary clock CR configuration options

CR field	Description
name	The name of the PtpConfig CR.
profile	Specify an array of one or more profile objects.
name	Specify the name of a profile object which uniquely identifies a profile object.

CR field	Description
ptp4lOpts	Specify system config options for the ptp4l service. The options should not include the network interface name -i <interface> and service config file -f /etc/ptp4l.conf because the network interface name and the service config file are automatically appended.
ptp4lConf	Specify the required configuration to start ptp4l as boundary clock. For example, ens1f0 synchronizes from a grandmaster clock and ens1f3 synchronizes connected devices.
<interface_1>	The interface that receives the synchronization clock.
<interface_2>	The interface that sends the synchronization clock.
tx_timestamp_timeout	For Intel Columbiaville 800 Series NICs, set tx_timestamp_timeout to 50 .
boundary_clock_jbod	For Intel Columbiaville 800 Series NICs, ensure boundary_clock_jbod is set to 0 . For Intel Fortville X710 Series NICs, ensure boundary_clock_jbod is set to 1 .
phc2sysOpts	Specify system config options for the phc2sys service. If this field is empty, the PTP Operator does not start the phc2sys service.
ptpSchedulingPolicy	Scheduling policy for ptp4l and phc2sys processes. Default value is SCHED_OTHER . Use SCHED_FIFO on systems that support FIFO scheduling.
ptpSchedulingPriority	Integer value from 1-65 used to set FIFO priority for ptp4l and phc2sys processes when ptpSchedulingPolicy is set to SCHED_FIFO . The ptpSchedulingPriority field is not used when ptpSchedulingPolicy is set to SCHED_OTHER .
ptpClockThreshold	Optional. If ptpClockThreshold is not present, default values are used for the ptpClockThreshold fields. ptpClockThreshold configures how long after the PTP master clock is disconnected before PTP events are triggered. holdOverTimeout is the time value in seconds before the PTP clock event state changes to FREERUN when the PTP master clock is disconnected. The maxOffsetThreshold and minOffsetThreshold settings configure offset values in nanoseconds that compare against the values for CLOCK_REALTIME (phc2sys) or master offset (ptp4l). When the ptp4l or phc2sys offset value is outside this range, the PTP clock state is set to FREERUN . When the offset value is within this range, the PTP clock state is set to LOCKED .
recommend	Specify an array of one or more recommend objects that define rules on how the profile should be applied to nodes.
.recommend.profile	Specify the .recommend.profile object name defined in the profile section.

CR field	Description
.recommend.priority	Specify the priority with an integer value between 0 and 99 . A larger number gets lower priority, so a priority of 99 is lower than a priority of 10 . If a node can be matched with multiple profiles according to rules defined in the match field, the profile with the higher priority is applied to that node.
.recommend.match	Specify .recommend.match rules with nodeLabel or nodeName values.
.recommend.match.nodeLabel	Set nodeLabel with the key of the node.Labels field from the node object by using the oc get nodes --show-labels command. For example, node-role.kubernetes.io/worker .
.recommend.match.nodeName	Set nodeName with the value of the node.Name field from the node object by using the oc get nodes command. For example, compute-1.example.com .

2. Create the CR by running the following command:

```
$ oc create -f boundary-clock-ptp-config.yaml
```

Verification

1. Check that the **PtpConfig** profile is applied to the node.
 - a. Get the list of pods in the **openshift-ptp** namespace by running the following command:

```
$ oc get pods -n openshift-ptp -o wide
```

Example output

```
NAME                                READY STATUS RESTARTS AGE IP           NODE
linuxptp-daemon-4xkbb               1/1   Running 0      43m 10.1.196.24  compute-0.example.com
linuxptp-daemon-tdspf               1/1   Running 0      43m 10.1.196.25  compute-1.example.com
ptp-operator-657bbb64c8-2f8sj      1/1   Running 0      43m 10.129.0.61  control-plane-1.example.com
```

- b. Check that the profile is correct. Examine the logs of the **linuxptp** daemon that corresponds to the node you specified in the **PtpConfig** profile. Run the following command:

```
$ oc logs linuxptp-daemon-4xkbb -n openshift-ptp -c linuxptp-daemon-container
```

Example output

```

I1115 09:41:17.117596 4143292 daemon.go:107] in applyNodePTPProfile
I1115 09:41:17.117604 4143292 daemon.go:109] updating NodePTPProfile to:
I1115 09:41:17.117607 4143292 daemon.go:110] -----
I1115 09:41:17.117612 4143292 daemon.go:102] Profile Name: profile1
I1115 09:41:17.117616 4143292 daemon.go:102] Interface:
I1115 09:41:17.117620 4143292 daemon.go:102] Ptp4IOpts: -2
I1115 09:41:17.117623 4143292 daemon.go:102] Phc2sysOpts: -a -r -n 24
I1115 09:41:17.117626 4143292 daemon.go:116] -----

```

Additional resources

- [Configuring FIFO priority scheduling for PTP hardware](#)
- [Configuring the PTP fast event notifications publisher](#)

21.2.7.1. Configuring linuxptp services as boundary clocks for dual NIC hardware

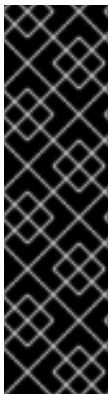

IMPORTANT

Precision Time Protocol (PTP) hardware with dual NIC configured as boundary clocks is a Technology Preview feature only. Technology Preview features are not supported with Red Hat production service level agreements (SLAs) and might not be functionally complete. Red Hat does not recommend using them in production. These features provide early access to upcoming product features, enabling customers to test functionality and provide feedback during the development process.

For more information about the support scope of Red Hat Technology Preview features, see [Technology Preview Features Support Scope](#).

You can configure the **linuxptp** services (**ptp4l**, **phc2sys**) as boundary clocks for dual NIC hardware by creating a **PtpConfig** custom resource (CR) object for each NIC.

Dual NIC hardware allows you to connect each NIC to the same upstream leader clock with separate **ptp4l** instances for each NIC feeding the downstream clocks.

Prerequisites

- Install the OpenShift CLI (**oc**).
- Log in as a user with **cluster-admin** privileges.
- Install the PTP Operator.

Procedure

1. Create two separate **PtpConfig** CRs, one for each NIC, using the reference CR in "Configuring linuxptp services as a boundary clock" as the basis for each CR. For example:
 - a. Create **boundary-clock-ptp-config-nic1.yaml**, specifying values for **phc2sysOpts**:

```

apiVersion: ptp.openshift.io/v1
kind: PtpConfig
metadata:
  name: boundary-clock-ptp-config-nic1

```

```

namespace: openshift-ptp
spec:
  profile:
  - name: "profile1"
    ptp4IOpts: "-2 --summary_interval -4"
    ptp4IConf: | 1
      [ens5f1]
      masterOnly 1
      [ens5f0]
      masterOnly 0
    ...
    phc2sysOpts: "-a -r -m -n 24 -N 8 -R 16" 2

```

- 1** Specify the required interfaces to start **ptp4l** as a boundary clock. For example, **ens5f0** synchronizes from a grandmaster clock and **ens5f1** synchronizes connected devices.
- 2** Required **phc2sysOpts** values. **-m** prints messages to **stdout**. The **linuxptp-daemon DaemonSet** parses the logs and generates Prometheus metrics.

- b. Create **boundary-clock-ptp-config-nic2.yaml**, removing the **phc2sysOpts** field altogether to disable the **phc2sys** service for the second NIC:

```

apiVersion: ptp.openshift.io/v1
kind: PtpConfig
metadata:
  name: boundary-clock-ptp-config-nic2
  namespace: openshift-ptp
spec:
  profile:
  - name: "profile2"
    ptp4IOpts: "-2 --summary_interval -4"
    ptp4IConf: | 1
      [ens7f1]
      masterOnly 1
      [ens7f0]
      masterOnly 0
    ...

```

- 1** Specify the required interfaces to start **ptp4l** as a boundary clock on the second NIC.



NOTE

You must completely remove the **phc2sysOpts** field from the second **PtpConfig** CR to disable the **phc2sys** service on the second NIC.

2. Create the dual NIC **PtpConfig** CRs by running the following commands:

- a. Create the CR that configures PTP for the first NIC:

```
$ oc create -f boundary-clock-ptp-config-nic1.yaml
```

- b. Create the CR that configures PTP for the second NIC:

■

```
$ oc create -f boundary-clock-ptp-config-nic2.yaml
```

Verification

- Check that the PTP Operator has applied the **PtpConfig** CRs for both NICs. Examine the logs for the **linuxptp** daemon corresponding to the node that has the dual NIC hardware installed. For example, run the following command:

```
$ oc logs linuxptp-daemon-cvgr6 -n openshift-ptp -c linuxptp-daemon-container
```

Example output

```
ptp4l[80828.335]: [ptp4l.1.config] master offset      5 s2 freq  -5727 path delay   519
ptp4l[80828.343]: [ptp4l.0.config] master offset    -5 s2 freq  -10607 path delay   533
phc2sys[80828.390]: [ptp4l.0.config] CLOCK_REALTIME phc offset      1 s2 freq  -87239
delay 539
```

21.2.8. Configuring linuxptp services as an ordinary clock

You can configure **linuxptp** services (**ptp4l**, **phc2sys**) as ordinary clock by creating a **PtpConfig** custom resource (CR) object.



NOTE

Use the following example **PtpConfig** CR as the basis to configure **linuxptp** services as an ordinary clock for your particular hardware and environment. This example CR does not configure PTP fast events. To configure PTP fast events, set appropriate values for **ptp4lOpts**, **ptp4lConf**, and **ptpClockThreshold**. **ptpClockThreshold** is required only when events are enabled. See "Configuring the PTP fast event notifications publisher" for more information.

Prerequisites

- Install the OpenShift CLI (**oc**).
- Log in as a user with **cluster-admin** privileges.
- Install the PTP Operator.

Procedure

1. Create the following **PtpConfig** CR, and then save the YAML in the **ordinary-clock-ptp-config.yaml** file.

Example PTP ordinary clock configuration

```
apiVersion: ptp.openshift.io/v1
kind: PtpConfig
metadata:
  name: ordinary-clock
  namespace: openshift-ptp
  annotations: {}
spec:
```



```

profile:
- name: ordinary-clock
  # The interface name is hardware-specific
  interface: $interface
  ptp4IOpts: "-2 -s"
  phc2sysOpts: "-a -r -n 24"
  ptpSchedulingPolicy: SCHED_FIFO
  ptpSchedulingPriority: 10
  ptpSettings:
    logReduce: "true"
  ptp4IConf: |
    [global]
    #
    # Default Data Set
    #
    twoStepFlag 1
    slaveOnly 1
    priority1 128
    priority2 128
    domainNumber 24
    #utc_offset 37
    clockClass 255
    clockAccuracy 0xFE
    offsetScaledLogVariance 0xFFFF
    free_running 0
    freq_est_interval 1
    dscp_event 0
    dscp_general 0
    dataset_comparison G.8275.x
    G.8275.defaultDS.localPriority 128
    #
    # Port Data Set
    #
    logAnnounceInterval -3
    logSyncInterval -4
    logMinDelayReqInterval -4
    logMinPdelayReqInterval -4
    announceReceiptTimeout 3
    syncReceiptTimeout 0
    delayAsymmetry 0
    fault_reset_interval -4
    neighborPropDelayThresh 20000000
    masterOnly 0
    G.8275.portDS.localPriority 128
    #
    # Run time options
    #
    assume_two_step 0
    logging_level 6
    path_trace_enabled 0
    follow_up_info 0
    hybrid_e2e 0
    inhibit_multicast_service 0
    net_sync_monitor 0
    tc_spanning_tree 0
    tx_timestamp_timeout 50

```

```
unicast_listen 0
unicast_master_table 0
unicast_req_duration 3600
use_syslog 1
verbose 0
summary_interval 0
kernel_leap 1
check_fup_sync 0
clock_class_threshold 7
#
# Servo Options
#
pi_proportional_const 0.0
pi_integral_const 0.0
pi_proportional_scale 0.0
pi_proportional_exponent -0.3
pi_proportional_norm_max 0.7
pi_integral_scale 0.0
pi_integral_exponent 0.4
pi_integral_norm_max 0.3
step_threshold 2.0
first_step_threshold 0.00002
max_frequency 900000000
clock_servo pi
sanity_freq_limit 200000000
ntpshm_segment 0
#
# Transport options
#
transportSpecific 0x0
ptp_dst_mac 01:1B:19:00:00:00
p2p_dst_mac 01:80:C2:00:00:0E
udp_ttl 1
udp6_scope 0x0E
uds_address /var/run/ptp4l
#
# Default interface options
#
clock_type OC
network_transport L2
delay_mechanism E2E
time_stamping hardware
tsproc_mode filter
delay_filter moving_median
delay_filter_length 10
egressLatency 0
ingressLatency 0
boundary_clock_jbod 0
#
# Clock description
#
productDescription ;;
revisionData ;;
manufacturerIdentity 00:00:00
userDescription ;
timeSource 0xA0
```

```

recommend:
- profile: ordinary-clock
  priority: 4
  match:
    - nodeLabel: "node-role.kubernetes.io/$mcp"

```

Table 21.9. PTP ordinary clock CR configuration options

CR field	Description
name	The name of the PtpConfig CR.
profile	Specify an array of one or more profile objects. Each profile must be uniquely named.
interface	Specify the network interface to be used by the ptp4l service, for example ens787f1 .
ptp4lOpts	Specify system config options for the ptp4l service, for example -2 to select the IEEE 802.3 network transport. The options should not include the network interface name -i <interface> and service config file -f /etc/ptp4l.conf because the network interface name and the service config file are automatically appended. Append --summary_interval -4 to use PTP fast events with this interface.
phc2sysOpts	Specify system config options for the phc2sys service. If this field is empty, the PTP Operator does not start the phc2sys service. For Intel Columbiaville 800 Series NICs, set phc2sysOpts options to -a -r -m -n 24 -N 8 -R 16 . -m prints messages to stdout . The linuxptp-daemon DaemonSet parses the logs and generates Prometheus metrics.
ptp4lConf	Specify a string that contains the configuration to replace the default /etc/ptp4l.conf file. To use the default configuration, leave the field empty.
tx_timestamp_timeout	For Intel Columbiaville 800 Series NICs, set tx_timestamp_timeout to 50 .
boundary_clock_jbod	For Intel Columbiaville 800 Series NICs, set boundary_clock_jbod to 0 .
ptpSchedulingPolicy	Scheduling policy for ptp4l and phc2sys processes. Default value is SCHED_OTHER . Use SCHED_FIFO on systems that support FIFO scheduling.
ptpSchedulingPriority	Integer value from 1-65 used to set FIFO priority for ptp4l and phc2sys processes when ptpSchedulingPolicy is set to SCHED_FIFO . The ptpSchedulingPriority field is not used when ptpSchedulingPolicy is set to SCHED_OTHER .

CR field	Description
ptpClockThreshold	Optional. If ptpClockThreshold is not present, default values are used for the ptpClockThreshold fields. ptpClockThreshold configures how long after the PTP master clock is disconnected before PTP events are triggered. holdOverTimeout is the time value in seconds before the PTP clock event state changes to FREERUN when the PTP master clock is disconnected. The maxOffsetThreshold and minOffsetThreshold settings configure offset values in nanoseconds that compare against the values for CLOCK_REALTIME (phc2sys) or master offset (ptp4l). When the ptp4l or phc2sys offset value is outside this range, the PTP clock state is set to FREERUN . When the offset value is within this range, the PTP clock state is set to LOCKED .
recommend	Specify an array of one or more recommend objects that define rules on how the profile should be applied to nodes.
.recommend.profile	Specify the .recommend.profile object name defined in the profile section.
.recommend.priority	Set .recommend.priority to 0 for ordinary clock.
.recommend.match	Specify .recommend.match rules with nodeLabel or nodeName values.
.recommend.match.nodeLabel	Set nodeLabel with the key of the node.Labels field from the node object by using the oc get nodes --show-labels command. For example, node-role.kubernetes.io/worker .
.recommend.match.nodeName	Set nodeName with the value of the node.Name field from the node object by using the oc get nodes command. For example, compute-1.example.com .

2. Create the **PtpConfig** CR by running the following command:

```
$ oc create -f ordinary-clock-ptp-config.yaml
```

Verification

1. Check that the **PtpConfig** profile is applied to the node.
 - a. Get the list of pods in the **openshift-ptp** namespace by running the following command:

```
$ oc get pods -n openshift-ptp -o wide
```

Example output

```
NAME                READY STATUS RESTARTS AGE IP           NODE
linuxptp-daemon-4xkbb 1/1   Running 0      43m 10.1.196.24 compute-
```

```

0.example.com
linuxptp-daemon-tdspf      1/1   Running 0      43m  10.1.196.25  compute-
1.example.com
ptp-operator-657bbb64c8-2f8sj 1/1   Running 0      43m  10.129.0.61  control-
plane-1.example.com

```

- b. Check that the profile is correct. Examine the logs of the **linuxptp** daemon that corresponds to the node you specified in the **PtpConfig** profile. Run the following command:

```
$ oc logs linuxptp-daemon-4xkbb -n openshift-ntp -c linuxptp-daemon-container
```

Example output

```

I1115 09:41:17.117596 4143292 daemon.go:107] in applyNodePTPProfile
I1115 09:41:17.117604 4143292 daemon.go:109] updating NodePTPProfile to:
I1115 09:41:17.117607 4143292 daemon.go:110] -----
I1115 09:41:17.117612 4143292 daemon.go:102] Profile Name: profile1
I1115 09:41:17.117616 4143292 daemon.go:102] Interface: ens787f1
I1115 09:41:17.117620 4143292 daemon.go:102] Ptp4IOpts: -2 -s
I1115 09:41:17.117623 4143292 daemon.go:102] Phc2sysOpts: -a -r -n 24
I1115 09:41:17.117626 4143292 daemon.go:116] -----

```

Additional resources

- [Configuring FIFO priority scheduling for PTP hardware](#)
- [Configuring the PTP fast event notifications publisher](#)

21.2.8.1. Intel Columbiaville E800 series NIC as PTP ordinary clock reference

The following table describes the changes that you must make to the reference PTP configuration to use Intel Columbiaville E800 series NICs as ordinary clocks. Make the changes in a **PtpConfig** custom resource (CR) that you apply to the cluster.

Table 21.10. Recommended PTP settings for Intel Columbiaville NIC

PTP configuration	Recommended setting
phc2sysOpts	-a -r -m -n 24 -N 8 -R 16
tx_timestamp_timeout	50
boundary_clock_jbod	0



NOTE

For **phc2sysOpts**, **-m** prints messages to **stdout**. The **linuxptp-daemon DaemonSet** parses the logs and generates Prometheus metrics.

Additional resources

- For a complete example CR that configures **linuxptp** services as an ordinary clock with PTP fast events, see [Configuring linuxptp services as ordinary clock](#).

21.2.9. Configuring FIFO priority scheduling for PTP hardware

In telco or other deployment types that require low latency performance, PTP daemon threads run in a constrained CPU footprint alongside the rest of the infrastructure components. By default, PTP threads run with the **SCHED_OTHER** policy. Under high load, these threads might not get the scheduling latency they require for error-free operation.

To mitigate against potential scheduling latency errors, you can configure the PTP Operator **linuxptp** services to allow threads to run with a **SCHED_FIFO** policy. If **SCHED_FIFO** is set for a **PtpConfig** CR, then **ptp4l** and **phc2sys** will run in the parent container under **chrt** with a priority set by the **ptpSchedulingPriority** field of the **PtpConfig** CR.



NOTE

Setting **ptpSchedulingPolicy** is optional, and is only required if you are experiencing latency errors.

Procedure

1. Edit the **PtpConfig** CR profile:

```
$ oc edit PtpConfig -n openshift-ptp
```

2. Change the **ptpSchedulingPolicy** and **ptpSchedulingPriority** fields:

```
apiVersion: ptp.openshift.io/v1
kind: PtpConfig
metadata:
  name: <ptp_config_name>
  namespace: openshift-ptp
...
spec:
  profile:
    - name: "profile1"
...
  ptpSchedulingPolicy: SCHED_FIFO 1
  ptpSchedulingPriority: 10 2
```

- 1 Scheduling policy for **ptp4l** and **phc2sys** processes. Use **SCHED_FIFO** on systems that support FIFO scheduling.
- 2 Required. Sets the integer value 1-65 used to configure FIFO priority for **ptp4l** and **phc2sys** processes.

3. Save and exit to apply the changes to the **PtpConfig** CR.

Verification

1. Get the name of the **linuxptp-daemon** pod and corresponding node where the **PtpConfig** CR has been applied:

```
$ oc get pods -n openshift-ntp -o wide
```

Example output

```
NAME                                READY STATUS RESTARTS AGE IP      NODE
linuxntp-daemon-gmv2n              3/3   Running 0       1d17h 10.1.196.24 compute-0.example.com
linuxntp-daemon-lgm55              3/3   Running 0       1d17h 10.1.196.25 compute-1.example.com
ntp-operator-3r4dcvf7f4-zndk7     1/1   Running 0       1d7h  10.129.0.61 control-plane-1.example.com
```

2. Check that the **ntp4l** process is running with the updated **chrt** FIFO priority:

```
$ oc -n openshift-ntp logs linuxntp-daemon-lgm55 -c linuxntp-daemon-container|grep chrt
```

Example output

```
l1216 19:24:57.091872 1600715 daemon.go:285] /bin/chrt -f 65 /usr/sbin/ntp4l -f /var/run/ntp4l.0.config -2 --summary_interval -4 -m
```

21.2.10. Configuring log filtering for linuxntp services

The **linuxntp** daemon generates logs that you can use for debugging purposes. In telco or other deployment types that feature a limited storage capacity, these logs can add to the storage demand.

To reduce the number log messages, you can configure the **PtpConfig** custom resource (CR) to exclude log messages that report the **master offset** value. The **master offset** log message reports the difference between the current node's clock and the master clock in nanoseconds.

Prerequisites

- Install the OpenShift CLI (**oc**).
- Log in as a user with **cluster-admin** privileges.
- Install the PTP Operator.

Procedure

1. Edit the **PtpConfig** CR:

```
$ oc edit PtpConfig -n openshift-ntp
```

2. In **spec.profile**, add the **ntpSettings.logReduce** specification and set the value to **true**:

```
apiVersion: ntp.openshift.io/v1
kind: PtpConfig
metadata:
  name: <ntp_config_name>
  namespace: openshift-ntp
...
spec:
```

```
profile:
- name: "profile1"
...
ptpSettings:
  logReduce: "true"
```

**NOTE**

For debugging purposes, you can revert this specification to **False** to include the master offset messages.

3. Save and exit to apply the changes to the **PtpConfig** CR.

Verification

1. Get the name of the **linuxptp-daemon** pod and corresponding node where the **PtpConfig** CR has been applied:

```
$ oc get pods -n openshift-ptp -o wide
```

Example output

```
NAME                                READY STATUS RESTARTS AGE IP      NODE
linuxptp-daemon-gmv2n              3/3   Running 0       1d17h 10.1.196.24 compute-0.example.com
linuxptp-daemon-lgm55              3/3   Running 0       1d17h 10.1.196.25 compute-1.example.com
ptp-operator-3r4dcvf7f4-zndk7     1/1   Running 0       1d7h  10.129.0.61 control-plane-1.example.com
```

2. Verify that master offset messages are excluded from the logs by running the following command:

```
$ oc -n openshift-ptp logs <linux_daemon_container> -c linuxptp-daemon-container | grep "master offset" 1
```

- 1** <linux_daemon_container> is the name of the **linuxptp-daemon** pod, for example **linuxptp-daemon-gmv2n**.

When you configure the **logReduce** specification, this command does not report any instances of **master offset** in the logs of the **linuxptp** daemon.

21.2.11. Troubleshooting common PTP Operator issues

Troubleshoot common problems with the PTP Operator by performing the following steps.

Prerequisites

- Install the OpenShift Container Platform CLI (**oc**).
- Log in as a user with **cluster-admin** privileges.

- Install the PTP Operator on a bare-metal cluster with hosts that support PTP.

Procedure

1. Check the Operator and operands are successfully deployed in the cluster for the configured nodes.

```
$ oc get pods -n openshift-ntp -o wide
```

Example output

NAME	READY	STATUS	RESTARTS	AGE	IP	NODE
linuxntp-daemon-lmvgn-0.example.com	3/3	Running	0	4d17h	10.1.196.24	compute-
linuxntp-daemon-qhfg7-1.example.com	3/3	Running	0	4d17h	10.1.196.25	compute-
ntp-operator-6b8dcbf7f4-zndk7-1.example.com	1/1	Running	0	5d7h	10.129.0.61	control-plane-

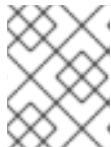

NOTE

When the PTP fast event bus is enabled, the number of ready **linuxntp-daemon** pods is **3/3**. If the PTP fast event bus is not enabled, **2/2** is displayed.

2. Check that supported hardware is found in the cluster.

```
$ oc -n openshift-ntp get nodentpdevices.ntp.openshift.io
```

Example output

NAME	AGE
control-plane-0.example.com	10d
control-plane-1.example.com	10d
compute-0.example.com	10d
compute-1.example.com	10d
compute-2.example.com	10d

3. Check the available PTP network interfaces for a node:

```
$ oc -n openshift-ntp get nodentpdevices.ntp.openshift.io <node_name> -o yaml
```

where:

<node_name>

Specifies the node you want to query, for example, **compute-0.example.com**.

Example output

```
apiVersion: ntp.openshift.io/v1
kind: NodeNtpDevice
metadata:
  creationTimestamp: "2021-09-14T16:52:33Z"
```

```

generation: 1
name: compute-0.example.com
namespace: openshift-ntp
resourceVersion: "177400"
uid: 30413db0-4d8d-46da-9bef-737bacd548fd
spec: {}
status:
  devices:
    - name: eno1
    - name: eno2
    - name: eno3
    - name: eno4
    - name: enp5s0f0
    - name: enp5s0f1

```

4. Check that the PTP interface is successfully synchronized to the primary clock by accessing the **linuxptp-daemon** pod for the corresponding node.

- a. Get the name of the **linuxptp-daemon** pod and corresponding node you want to troubleshoot by running the following command:

```
$ oc get pods -n openshift-ntp -o wide
```

Example output

```

NAME                                READY STATUS RESTARTS AGE IP      NODE
linuxptp-daemon-lmvgn              3/3   Running 0       4d17h 10.1.196.24 compute-0.example.com
linuxptp-daemon-qhfg7              3/3   Running 0       4d17h 10.1.196.25 compute-1.example.com
ptp-operator-6b8dcbf7f4-zndk7     1/1   Running 0       5d7h  10.129.0.61 control-plane-1.example.com

```

- b. Remote shell into the required **linuxptp-daemon** container:

```
$ oc rsh -n openshift-ntp -c linuxptp-daemon-container <linux_daemon_container>
```

where:

<linux_daemon_container>

is the container you want to diagnose, for example **linuxptp-daemon-lmvgn**.

- c. In the remote shell connection to the **linuxptp-daemon** container, use the PTP Management Client (**pmc**) tool to diagnose the network interface. Run the following **pmc** command to check the sync status of the PTP device, for example **ptp4l**.

```
# pmc -u -f /var/run/ptp4l.0.config -b 0 'GET PORT_DATA_SET'
```

Example output when the node is successfully synced to the primary clock

```

sending: GET PORT_DATA_SET
40a6b7.ffe.166ef0-1 seq 0 RESPONSE MANAGEMENT PORT_DATA_SET
portIdentity      40a6b7.ffe.166ef0-1

```

```

portState          SLAVE
logMinDelayReqInterval -4
peerMeanPathDelay  0
logAnnounceInterval -3
announceReceiptTimeout 3
logSyncInterval    -4
delayMechanism     1
logMinPdelayReqInterval -4
versionNumber      2

```

- For GNSS-sourced grandmaster clocks, verify that the in-tree NIC ice driver is correct by running the following command, for example:

```
$ oc rsh -n openshift-ptp -c linuxptp-daemon-container linuxptp-daemon-74m2g ethtool -i ens7f0
```

Example output

```

driver: ice
version: 5.14.0-356.bz2232515.el9.x86_64
firmware-version: 4.20 0x8001778b 1.3346.0

```

- For GNSS-sourced grandmaster clocks, verify that the **linuxptp-daemon** container is receiving signal from the GNSS antenna. If the container is not receiving the GNSS signal, the **/dev/gnss0** file is not populated. To verify, run the following command:

```
$ oc rsh -n openshift-ptp -c linuxptp-daemon-container linuxptp-daemon-jnz6r cat /dev/gnss0
```

Example output

```

$GNRMC,125223.00,A,4233.24463,N,07126.64561,W,0.000,,300823,,A,V*0A
$GNVTG,,T,,M,0.000,N,0.000,K,A*3D
$GNGGA,125223.00,4233.24463,N,07126.64561,W,1,12,99.99,98.6,M,-33.1,M,,*7E
$GNGSA,A,3,25,17,19,11,12,06,05,04,09,20,,,99.99,99.99,99.99,1*37
$GPGSV,3,1,10,04,12,039,41,05,31,222,46,06,50,064,48,09,28,064,42,1*62

```

21.2.12. Collecting PTP Operator data

You can use the **oc adm must-gather** command to collect information about your cluster, including features and objects associated with PTP Operator.

Prerequisites

- You have access to the cluster as a user with the **cluster-admin** role.
- You have installed the OpenShift CLI (**oc**).
- You have installed the PTP Operator.

Procedure

- To collect PTP Operator data with **must-gather**, you must specify the PTP Operator **must-gather** image.

```
$ oc adm must-gather --image=registry.redhat.io/openshift4/ptp-must-gather-rhel8:v4.15
```

21.3. USING THE PTP HARDWARE FAST EVENT NOTIFICATIONS FRAMEWORK

Cloud native applications such as virtual RAN (vRAN) require access to notifications about hardware timing events that are critical to the functioning of the overall network. PTP clock synchronization errors can negatively affect the performance and reliability of your low-latency application, for example, a vRAN application running in a distributed unit (DU).

21.3.1. About PTP and clock synchronization error events

Loss of PTP synchronization is a critical error for a RAN network. If synchronization is lost on a node, the radio might be shut down and the network Over the Air (OTA) traffic might be shifted to another node in the wireless network. Fast event notifications mitigate against workload errors by allowing cluster nodes to communicate PTP clock sync status to the vRAN application running in the DU.

Event notifications are available to vRAN applications running on the same DU node. A publish/subscribe REST API passes events notifications to the messaging bus. Publish/subscribe messaging, or pub-sub messaging, is an asynchronous service-to-service communication architecture where any message published to a topic is immediately received by all of the subscribers to the topic.

The PTP Operator generates fast event notifications for every PTP-capable network interface. You can access the events by using a **cloud-event-proxy** sidecar container over an HTTP or Advanced Message Queuing Protocol (AMQP) message bus.



NOTE

PTP fast event notifications are available for network interfaces configured to use PTP ordinary clocks, PTP grandmaster clocks, or PTP boundary clocks.



NOTE

HTTP transport is the default transport for PTP and bare-metal events. Use HTTP transport instead of AMQP for PTP and bare-metal events where possible. AMQ Interconnect is EOL from 30 June 2024. Extended life cycle support (ELS) for AMQ Interconnect ends 29 November 2029. For more information see, [Red Hat AMQ Interconnect support status](#).

21.3.2. About the PTP fast event notifications framework

Use the Precision Time Protocol (PTP) fast event notifications framework to subscribe cluster applications to PTP events that the bare-metal cluster node generates.

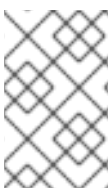

NOTE

The fast events notifications framework uses a REST API for communication. The REST API is based on the *O-RAN O-Cloud Notification API Specification for Event Consumers 3.0* that is available from [O-RAN ALLIANCE Specifications](#).

The framework consists of a publisher, subscriber, and an AMQ or HTTP messaging protocol to handle communications between the publisher and subscriber applications. Applications run the **cloud-event-**

proxy container in a sidecar pattern to subscribe to PTP events. The **cloud-event-proxy** sidecar container can access the same resources as the primary application container without using any of the resources of the primary application and with no significant latency.



NOTE

HTTP transport is the default transport for PTP and bare-metal events. Use HTTP transport instead of AMQP for PTP and bare-metal events where possible. AMQ Interconnect is EOL from 30 June 2024. Extended life cycle support (ELS) for AMQ Interconnect ends 29 November 2029. For more information see, [Red Hat AMQ Interconnect support status](#).

Figure 21.4. Overview of PTP fast events

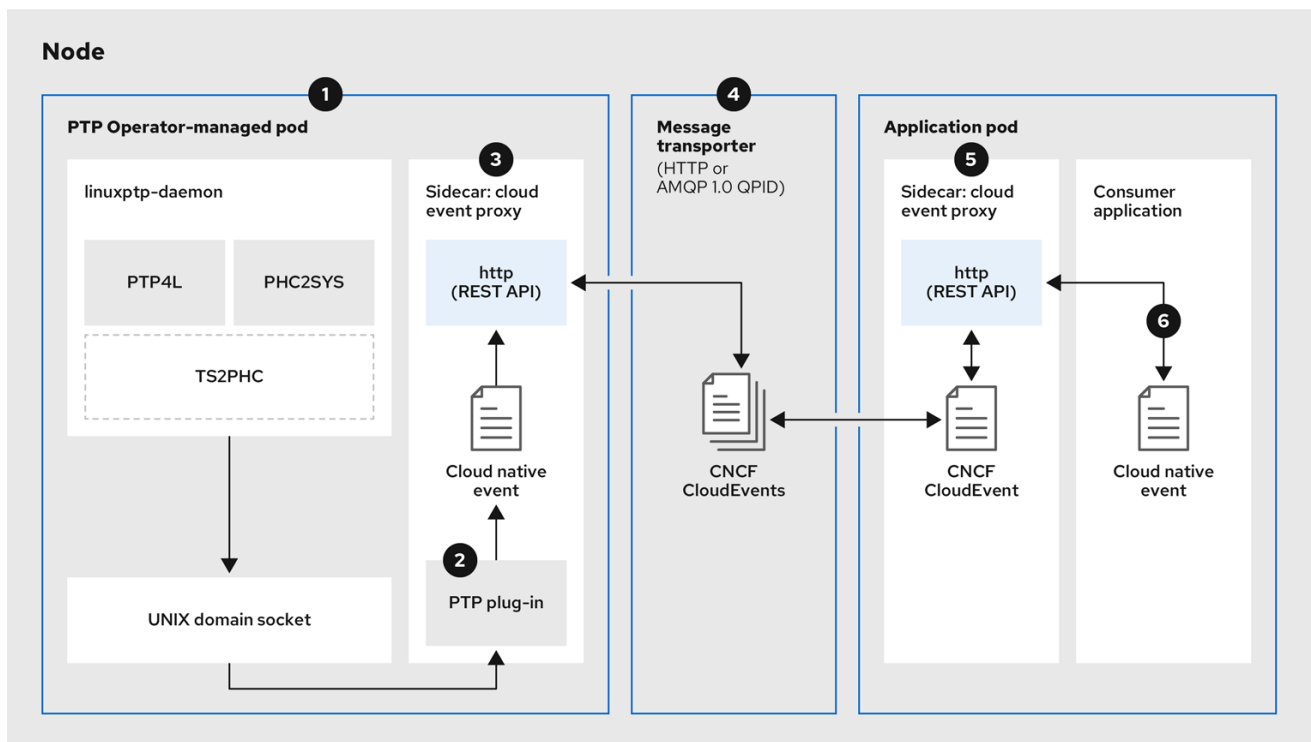

319_OpenShift_0323

1 Event is generated on the cluster host

`linuxptp-daemon` in the PTP Operator-managed pod runs as a Kubernetes **DaemonSet** and manages the various `linuxptp` processes (`ptp4l`, `phc2sys`, and optionally for grandmaster clocks, `ts2phc`). The `linuxptp-daemon` passes the event to the UNIX domain socket.

2 Event is passed to the cloud-event-proxy sidecar

The PTP plugin reads the event from the UNIX domain socket and passes it to the **cloud-event-proxy** sidecar in the PTP Operator-managed pod. `cloud-event-proxy` delivers the event from the Kubernetes infrastructure to Cloud-Native Network Functions (CNFs) with low latency.

3 Event is persisted

The **cloud-event-proxy** sidecar in the PTP Operator-managed pod processes the event and publishes the cloud-native event by using a REST API.

4 Message is transported

The message transporter transports the event to the **cloud-event-proxy** sidecar in the application pod over HTTP or AMQP 1.0 QPID.

5 Event is available from the REST API

The **cloud-event-proxy** sidecar in the Application pod processes the event and makes it available by using the REST API.

6 Consumer application requests a subscription and receives the subscribed event

The consumer application sends an API request to the **cloud-event-proxy** sidecar in the application pod to create a PTP events subscription. The **cloud-event-proxy** sidecar creates an AMQ or HTTP messaging listener protocol for the resource specified in the subscription.

The **cloud-event-proxy** sidecar in the application pod receives the event from the PTP Operator-managed pod, unwraps the cloud events object to retrieve the data, and posts the event to the consumer application. The consumer application listens to the address specified in the resource qualifier and receives and processes the PTP event.

21.3.3. Configuring the PTP fast event notifications publisher

To start using PTP fast event notifications for a network interface in your cluster, you must enable the fast event publisher in the PTP Operator **PtpOperatorConfig** custom resource (CR) and configure **ptpClockThreshold** values in a **PtpConfig** CR that you create.

Prerequisites

- You have installed the OpenShift Container Platform CLI (**oc**).
- You have logged in as a user with **cluster-admin** privileges.
- You have installed the PTP Operator.

Procedure

1. Modify the default PTP Operator config to enable PTP fast events.
 - a. Save the following YAML in the **ptp-operatorconfig.yaml** file:

```
apiVersion: ptp.openshift.io/v1
kind: PtpOperatorConfig
metadata:
  name: default
  namespace: openshift-ptp
spec:
  daemonNodeSelector:
    node-role.kubernetes.io/worker: ""
  ptpEventConfig:
    enableEventPublisher: true 1
```

- 1 Set **enableEventPublisher** to **true** to enable PTP fast event notifications.



NOTE

In OpenShift Container Platform 4.13 or later, you do not need to set the **spec.ptpEventConfig.transportHost** field in the **PtpOperatorConfig** resource when you use HTTP transport for PTP events. Set **transportHost** only when you use AMQP transport for PTP events.

- a. Update the **PtpOperatorConfig** CR:

```
$ oc apply -f ptp-operatorconfig.yaml
```

2. Create a **PtpConfig** custom resource (CR) for the PTP enabled interface, and set the required values for **ptpClockThreshold** and **ptp4IOpts**. The following YAML illustrates the required values that you must set in the **PtpConfig** CR:

```
spec:
  profile:
    - name: "profile1"
      interface: "enp5s0f0"
      ptp4IOpts: "-2 -s --summary_interval -4" 1
      phc2sysOpts: "-a -r -m -n 24 -N 8 -R 16" 2
      ptp4IConf: "" 3
      ptpClockThreshold: 4
        holdOverTimeout: 5
        maxOffsetThreshold: 100
        minOffsetThreshold: -100
```

- 1 Append **--summary_interval -4** to use PTP fast events.
- 2 Required **phc2sysOpts** values. **-m** prints messages to **stdout**. The **linuxptp-daemon DaemonSet** parses the logs and generates Prometheus metrics.
- 3 Specify a string that contains the configuration to replace the default **/etc/ptp4l.conf** file. To use the default configuration, leave the field empty.
- 4 Optional. If the **ptpClockThreshold** stanza is not present, default values are used for the **ptpClockThreshold** fields. The stanza shows default **ptpClockThreshold** values. The **ptpClockThreshold** values configure how long after the PTP master clock is disconnected before PTP events are triggered. **holdOverTimeout** is the time value in seconds before the PTP clock event state changes to **FREERUN** when the PTP master clock is disconnected. The **maxOffsetThreshold** and **minOffsetThreshold** settings configure offset values in nanoseconds that compare against the values for **CLOCK_REALTIME (phc2sys)** or master offset (**ptp4l**). When the **ptp4l** or **phc2sys** offset value is outside this range, the PTP clock state is set to **FREERUN**. When the offset value is within this range, the PTP clock state is set to **LOCKED**.

Additional resources

- For a complete example CR that configures **linuxptp** services as an ordinary clock with PTP fast events, see [Configuring linuxptp services as ordinary clock](#).

21.3.4. Migrating consumer applications to use HTTP transport for PTP or bare-metal events

If you have previously deployed PTP or bare-metal events consumer applications, you need to update the applications to use HTTP message transport.

Prerequisites

- You have installed the OpenShift CLI (**oc**).
- You have logged in as a user with **cluster-admin** privileges.
- You have updated the PTP Operator or Bare Metal Event Relay to version 4.13+ which uses HTTP transport by default.

Procedure

1. Update your events consumer application to use HTTP transport. Set the **http-event-publishers** variable for the cloud event sidecar deployment. For example, in a cluster with PTP events configured, the following YAML snippet illustrates a cloud event sidecar deployment:

```
containers:
  - name: cloud-event-sidecar
    image: cloud-event-sidecar
    args:
      - "--metrics-addr=127.0.0.1:9091"
      - "--store-path=/store"
      - "--transport-host=consumer-events-subscription-service.cloud-
events.svc.cluster.local:9043"
      - "--http-event-publishers=ptp-event-publisher-service-NODE_NAME.openshift-
ptp.svc.cluster.local:9043" 1
      - "--api-port=8089"
```

- 1** The PTP Operator automatically resolves **NODE_NAME** to the host that is generating the PTP events. For example, **compute-1.example.com**.

In a cluster with bare-metal events configured, set the **http-event-publishers** field to **hw-event-publisher-service.openshift-bare-metal-events.svc.cluster.local:9043** in the cloud event sidecar deployment CR.

2. Deploy the **consumer-events-subscription-service** service alongside the events consumer application. For example:

```
apiVersion: v1
kind: Service
metadata:
  annotations:
    prometheus.io/scrape: "true"
    service.alpha.openshift.io/serving-cert-secret-name: sidecar-consumer-secret
  name: consumer-events-subscription-service
  namespace: cloud-events
  labels:
    app: consumer-service
spec:
  ports:
    - name: sub-port
```



```

port: 9043
selector:
  app: consumer
  clusterIP: None
  sessionAffinity: None
type: ClusterIP

```

21.3.5. Installing the AMQ messaging bus

To pass PTP fast event notifications between publisher and subscriber on a node, you can install and configure an AMQ messaging bus to run locally on the node. To use AMQ messaging, you must install the AMQ Interconnect Operator.



NOTE

HTTP transport is the default transport for PTP and bare-metal events. Use HTTP transport instead of AMQP for PTP and bare-metal events where possible. AMQ Interconnect is EOL from 30 June 2024. Extended life cycle support (ELS) for AMQ Interconnect ends 29 November 2029. For more information see, [Red Hat AMQ Interconnect support status](#).

Prerequisites

- Install the OpenShift Container Platform CLI (**oc**).
- Log in as a user with **cluster-admin** privileges.

Procedure

- Install the AMQ Interconnect Operator to its own **amq-interconnect** namespace. See [Adding the Red Hat Integration - AMQ Interconnect Operator](#).

Verification

1. Check that the AMQ Interconnect Operator is available and the required pods are running:

```
$ oc get pods -n amq-interconnect
```

Example output

```

NAME                                READY STATUS RESTARTS AGE
amq-interconnect-645db76c76-k8ghs   1/1   Running 0      23h
interconnect-operator-5cb5fc7cc-4v7qm 1/1   Running 0      23h

```

2. Check that the required **linuxptp-daemon** PTP event producer pods are running in the **openshift-ptp** namespace.

```
$ oc get pods -n openshift-ptp
```

Example output

NAME	READY	STATUS	RESTARTS	AGE
linuxptp-daemon-2t78p	3/3	Running	0	12h
linuxptp-daemon-k8n88	3/3	Running	0	12h

21.3.6. Subscribing DU applications to PTP events with the REST API

Subscribe applications to PTP events by using the resource address `/cluster/node/<node_name>/ptp`, where `<node_name>` is the cluster node running the DU application.

Deploy your **cloud-event-consumer** DU application container and **cloud-event-proxy** sidecar container in a separate DU application pod. The **cloud-event-consumer** DU application subscribes to the **cloud-event-proxy** container in the application pod.

Use the following API endpoints to subscribe the **cloud-event-consumer** DU application to PTP events posted by the **cloud-event-proxy** container at `http://localhost:8089/api/ocloudNotifications/v1/` in the DU application pod:

- [/api/ocloudNotifications/v1/subscriptions](#)
 - **POST**: Creates a new subscription
 - **GET**: Retrieves a list of subscriptions
- [/api/ocloudNotifications/v1/subscriptions/<subscription_id>](#)
 - **GET**: Returns details for the specified subscription ID
- [/api/ocloudNotifications/v1/health](#)
 - **GET**: Returns the health status of **ocloudNotifications** API
- [api/ocloudNotifications/v1/publishers](#)
 - **GET**: Returns an array of **os-clock-sync-state**, **ptp-clock-class-change**, **lock-state**, and **gnss-sync-status** messages for the cluster node
- [/api/ocloudnotifications/v1/<resource_address>/CurrentState](#)
 - **GET**: Returns the current state of one the following event types: **os-clock-sync-state**, **ptp-clock-class-change**, **lock-state**, or **gnss-state-change** events

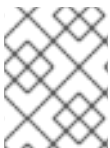

NOTE

9089 is the default port for the **cloud-event-consumer** container deployed in the application pod. You can configure a different port for your DU application as required.

21.3.6.1. PTP events REST API reference

Use the PTP event notifications REST API to subscribe a cluster application to the PTP events that are generated on the parent node.

21.3.6.1.1. api/ocloudNotifications/v1/subscriptions

HTTP method

GET `api/ocloudNotifications/v1/subscriptions`

Description

Returns a list of subscriptions. If subscriptions exist, a **200 OK** status code is returned along with the list of subscriptions.

Example API response

```
[
  {
    "id": "75b1ad8f-c807-4c23-acf5-56f4b7ee3826",
    "endpointUri": "http://localhost:9089/event",
    "uriLocation": "http://localhost:8089/api/ocloudNotifications/v1/subscriptions/75b1ad8f-c807-4c23-acf5-56f4b7ee3826",
    "resource": "/cluster/node/compute-1.example.com/ptp"
  }
]
```

HTTP method**POST api/ocloudNotifications/v1/subscriptions****Description**

Creates a new subscription. If a subscription is successfully created, or if it already exists, a **201 Created** status code is returned.

Table 21.11. Query parameters

Parameter	Type
subscription	data

Example payload

```
{
  "uriLocation": "http://localhost:8089/api/ocloudNotifications/v1/subscriptions",
  "resource": "/cluster/node/compute-1.example.com/ptp"
}
```

21.3.6.1.2. api/ocloudNotifications/v1/subscriptions/<subscription_id>**HTTP method****GET api/ocloudNotifications/v1/subscriptions/<subscription_id>****Description**

Returns details for the subscription with ID **<subscription_id>**

Table 21.12. Query parameters

Parameter	Type
<subscription_id>	string

Example API response

```
{
  "id": "48210fb3-45be-4ce0-aa9b-41a0e58730ab",
  "endpointUri": "http://localhost:9089/event",
  "uriLocation": "http://localhost:8089/api/ocloudNotifications/v1/subscriptions/48210fb3-45be-4ce0-aa9b-41a0e58730ab",
  "resource": "/cluster/node/compute-1.example.com/ptp"
}
```

21.3.6.1.3. api/ocloudNotifications/v1/health

HTTP method

GET api/ocloudNotifications/v1/health/

Description

Returns the health status for the **ocloudNotifications** REST API.

Example API response

```
OK
```

21.3.6.1.4. api/ocloudNotifications/v1/publishers

HTTP method

GET api/ocloudNotifications/v1/publishers

Description

Returns an array of **os-clock-sync-state**, **ptp-clock-class-change**, **lock-state**, and **gnss-sync-status** details for the cluster node. The system generates notifications when the relevant equipment state changes.

- **os-clock-sync-state** notifications describe the host operating system clock synchronization state. Can be in **LOCKED** or **FREERUN** state.
- **ptp-clock-class-change** notifications describe the current state of the PTP clock class.
- **lock-state** notifications describe the current status of the PTP equipment lock state. Can be in **LOCKED**, **HOLDOVER** or **FREERUN** state.
- **gnss-sync-status** notifications describe the GPS synchronization state with regard to the external GNSS clock signal. Can be in **LOCKED** or **FREERUN** state.

You can use equipment synchronization status subscriptions together to deliver a detailed view of the overall synchronization health of the system.

Example API response

```
[
  {
    "id": "0fa415ae-a3cf-4299-876a-589438bacf75",
    "endpointUri": "http://localhost:9085/api/ocloudNotifications/v1/dummy",
    "uriLocation": "http://localhost:9085/api/ocloudNotifications/v1/publishers/0fa415ae-a3cf-4299-876a-589438bacf75",
    "resource": "/cluster/node/compute-1.example.com/sync/sync-status/os-clock-sync-state"
  },
  {
```

```

    "id": "28cd82df-8436-4f50-bbd9-7a9742828a71",
    "endpointUri": "http://localhost:9085/api/ocloudNotifications/v1/dummy",
    "uriLocation": "http://localhost:9085/api/ocloudNotifications/v1/publishers/28cd82df-8436-4f50-
bbd9-7a9742828a71",
    "resource": "/cluster/node/compute-1.example.com/sync/ptp-status/ptp-clock-class-change"
  },
  {
    "id": "44aa480d-7347-48b0-a5b0-e0af01fa9677",
    "endpointUri": "http://localhost:9085/api/ocloudNotifications/v1/dummy",
    "uriLocation": "http://localhost:9085/api/ocloudNotifications/v1/publishers/44aa480d-7347-48b0-
a5b0-e0af01fa9677",
    "resource": "/cluster/node/compute-1.example.com/sync/ptp-status/lock-state"
  },
  {
    "id": "778da345d-4567-67b0-a43f0-rty885a456",
    "endpointUri": "http://localhost:9085/api/ocloudNotifications/v1/dummy",
    "uriLocation": "http://localhost:9085/api/ocloudNotifications/v1/publishers/778da345d-4567-67b0-
a43f0-rty885a456",
    "resource": "/cluster/node/compute-1.example.com/sync/gnss-status/gnss-sync-status"
  }
]

```

You can find **os-clock-sync-state**, **ptp-clock-class-change**, **lock-state**, and **gnss-sync-status** events in the logs for the **cloud-event-proxy** container. For example:

```
$ oc logs -f linuxptp-daemon-cvgr6 -n openshift-ntp -c cloud-event-proxy
```

Example os-clock-sync-state event

```

{
  "id": "c8a784d1-5f4a-4c16-9a81-a3b4313affe5",
  "type": "event.sync.sync-status.os-clock-sync-state-change",
  "source": "/cluster/compute-1.example.com/ntp/CLOCK_REALTIME",
  "dataContentType": "application/json",
  "time": "2022-05-06T15:31:23.906277159Z",
  "data": {
    "version": "v1",
    "values": [
      {
        "resource": "/sync/sync-status/os-clock-sync-state",
        "dataType": "notification",
        "valueType": "enumeration",
        "value": "LOCKED"
      },
      {
        "resource": "/sync/sync-status/os-clock-sync-state",
        "dataType": "metric",
        "valueType": "decimal64.3",
        "value": "-53"
      }
    ]
  }
}

```

Example ptp-clock-class-change event

```

{
  "id":"69eddb52-1650-4e56-b325-86d44688d02b",
  "type":"event.sync.ptp-status.ptp-clock-class-change",
  "source":"/cluster/compute-1.example.com/ptp/ens2fx/master",
  "dataContentType":"application/json",
  "time":"2022-05-06T15:31:23.147100033Z",
  "data":{
    "version":"v1",
    "values":[
      {
        "resource":"/sync/ptp-status/ptp-clock-class-change",
        "dataType":"metric",
        "valueType":"decimal64.3",
        "value":"135"
      }
    ]
  }
}

```

Example lock-state event

```

{
  "id":"305ec18b-1472-47b3-aadd-8f37933249a9",
  "type":"event.sync.ptp-status.ptp-state-change",
  "source":"/cluster/compute-1.example.com/ptp/ens2fx/master",
  "dataContentType":"application/json",
  "time":"2022-05-06T15:31:23.467684081Z",
  "data":{
    "version":"v1",
    "values":[
      {
        "resource":"/sync/ptp-status/lock-state",
        "dataType":"notification",
        "valueType":"enumeration",
        "value":"LOCKED"
      },
      {
        "resource":"/sync/ptp-status/lock-state",
        "dataType":"metric",
        "valueType":"decimal64.3",
        "value":"62"
      }
    ]
  }
}

```

Example gnss-sync-status event

```

{
  "id": "435e1f2a-6854-4555-8520-767325c087d7",
  "type": "event.sync.gnss-status.gnss-state-change",
  "source": "/cluster/node/compute-1.example.com/sync/gnss-status/gnss-sync-status",
  "dataContentType": "application/json",
  "time": "2023-09-27T19:35:33.42347206Z",
  "data": {

```

```

"version": "v1",
"values": [
  {
    "resource": "/cluster/node/compute-1.example.com/ens2fx/master",
    "dataType": "notification",
    "valueType": "enumeration",
    "value": "LOCKED"
  },
  {
    "resource": "/cluster/node/compute-1.example.com/ens2fx/master",
    "dataType": "metric",
    "valueType": "decimal64.3",
    "value": "5"
  }
]
}
}

```

21.3.6.1.5. api/ocloudNotifications/v1/<resource_address>/CurrentState

HTTP method

GET api/ocloudNotifications/v1/cluster/node/<node_name>/sync/ptp-status/lock-state/CurrentState

GET api/ocloudNotifications/v1/cluster/node/<node_name>/sync/sync-status/os-clock-sync-state/CurrentState

GET api/ocloudNotifications/v1/cluster/node/<node_name>/sync/ptp-status/ptp-clock-class-change/CurrentState

Description

Configure the **CurrentState** API endpoint to return the current state of the **os-clock-sync-state**, **ptp-clock-class-change**, **lock-state** events for the cluster node.

- **os-clock-sync-state** notifications describe the host operating system clock synchronization state. Can be in **LOCKED** or **FREERUN** state.
- **ptp-clock-class-change** notifications describe the current state of the PTP clock class.
- **lock-state** notifications describe the current status of the PTP equipment lock state. Can be in **LOCKED**, **HOLDOVER** or **FREERUN** state.

Table 21.13. Query parameters

Parameter	Type
<resource_address>	string

Example lock-state API response

```

{
  "id": "c1ac3aa5-1195-4786-84f8-da0ea4462921",
  "type": "event.sync.ptp-status.ptp-state-change",
  "source": "/cluster/node/compute-1.example.com/sync/ptp-status/lock-state",

```

```

"dataContentType": "application/json",
"time": "2023-01-10T02:41:57.094981478Z",
"data": {
  "version": "v1",
  "values": [
    {
      "resource": "/cluster/node/compute-1.example.com/ens5fx/master",
      "dataType": "notification",
      "valueType": "enumeration",
      "value": "LOCKED"
    },
    {
      "resource": "/cluster/node/compute-1.example.com/ens5fx/master",
      "dataType": "metric",
      "valueType": "decimal64.3",
      "value": "29"
    }
  ]
}

```

Example os-clock-sync-state API response

```

{
  "specversion": "0.3",
  "id": "4f51fe99-feaa-4e66-9112-66c5c9b9afcb",
  "source": "/cluster/node/compute-1.example.com/sync/sync-status/os-clock-sync-state",
  "type": "event.sync.sync-status.os-clock-sync-state-change",
  "subject": "/cluster/node/compute-1.example.com/sync/sync-status/os-clock-sync-state",
  "datacontenttype": "application/json",
  "time": "2022-11-29T17:44:22.202Z",
  "data": {
    "version": "v1",
    "values": [
      {
        "resource": "/cluster/node/compute-1.example.com/CLOCK_REALTIME",
        "dataType": "notification",
        "valueType": "enumeration",
        "value": "LOCKED"
      },
      {
        "resource": "/cluster/node/compute-1.example.com/CLOCK_REALTIME",
        "dataType": "metric",
        "valueType": "decimal64.3",
        "value": "27"
      }
    ]
  }
}

```

Example ptp-clock-class-change API response

```

{
  "id": "064c9e67-5ad4-4afb-98ff-189c6aa9c205",
  "type": "event.sync.ptp-status.ptp-clock-class-change",

```



```

"source": "/cluster/node/compute-1.example.com/sync/ptp-status/ptp-clock-class-change",
"dataContentType": "application/json",
"time": "2023-01-10T02:41:56.785673989Z",
"data": {
  "version": "v1",
  "values": [
    {
      "resource": "/cluster/node/compute-1.example.com/ens5fx/master",
      "dataType": "metric",
      "valueType": "decimal64.3",
      "value": "165"
    }
  ]
}
}
}

```

21.3.7. Monitoring PTP fast event metrics

You can monitor PTP fast events metrics from cluster nodes where the **linuxptp-daemon** is running. You can also monitor PTP fast event metrics in the OpenShift Container Platform web console by using the preconfigured and self-updating Prometheus monitoring stack.

Prerequisites

- Install the OpenShift Container Platform CLI **oc**.
- Log in as a user with **cluster-admin** privileges.
- Install and configure the PTP Operator on a node with PTP-capable hardware.

Procedure

1. Start a debug pod for the node by running the following command:

```
$ oc debug node/<node_name>
```

2. Check for PTP metrics exposed by the **linuxptp-daemon** container. For example, run the following command:

```
sh-4.4# curl http://localhost:9091/metrics
```

Example output

```

# HELP cne_api_events_published Metric to get number of events published by the rest api
# TYPE cne_api_events_published gauge
cne_api_events_published{address="/cluster/node/compute-1.example.com/sync/gnss-status/gnss-sync-status",status="success"} 1
cne_api_events_published{address="/cluster/node/compute-1.example.com/sync/ptp-status/lock-state",status="success"} 94
cne_api_events_published{address="/cluster/node/compute-1.example.com/sync/ptp-status/ptp-clock-class-change",status="success"} 18
cne_api_events_published{address="/cluster/node/compute-1.example.com/sync/sync-status/os-clock-sync-state",status="success"} 27

```

3. To view the PTP event in the OpenShift Container Platform web console, copy the name of the PTP metric you want to query, for example, **openshift_ptp_offset_ns**.
4. In the OpenShift Container Platform web console, click **Observe → Metrics**.
5. Paste the PTP metric name into the **Expression** field, and click **Run queries**.

Additional resources

- [Managing metrics](#)

21.3.8. PTP fast event metrics reference

The following table describes the PTP fast events metrics that are available from cluster nodes where the **linuxptp-daemon** service is running.

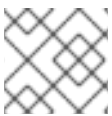

NOTE

Some of the following metrics are applicable for PTP grandmaster clocks (T-GM) only.

Table 21.14. PTP fast event metrics

Metric	Description	Example
openshift_ptp_clock_class	Returns the PTP clock class for the interface. Possible values for PTP clock class are 6 (LOCKED), 7 (PRC UNLOCKED IN-SPEC), 52 (PRC UNLOCKED OUT-OF-SPEC), 187 (PRC UNLOCKED OUT-OF-SPEC), 135 (T-BC HOLDOVER IN-SPEC), 165 (T-BC HOLDOVER OUT-OF-SPEC), 248 (DEFAULT), or 255 (SLAVE ONLY CLOCK). Applicable to T-GM clocks only.	{node="compute-1.example.com",process="ptp4l"} 6
openshift_ptp_clock_state	Returns the current PTP clock state for the interface. Possible values for PTP clock state are FREERUN , LOCKED , or HOLDOVER .	{iface="CLOCK_REALTIME",node="compute-1.example.com",process="phc2sys"} 1
openshift_ptp_delay_ns	Returns the delay in nanoseconds between the primary clock sending the timing packet and the secondary clock receiving the timing packet.	{from="master",iface="ens2fx",node="compute-1.example.com",process="ts2phc"} 0
openshift_ptp_frequency_adjustment_ns	Returns the frequency adjustment in nanoseconds between 2 PTP clocks. For example, between the upstream clock and the NIC, between the system clock and the NIC, or between the PTP hardware clock (phc) and the NIC. Applicable to T-GM clocks only.	{from="phc",iface="CLOCK_REALTIME",node="compute-1.example.com",process="phc2sys"} -6768

Metric	Description	Example
<code>openshift_ptp_frequency_status</code>	Returns the current status of the digital phase-locked loop (DPLL) frequency for the NIC. Possible values are -1 (UNKNOWN), 0 (INVALID), 1 (FREERUN), 2 (LOCKED), 3 (LOCKED_HO_ACQ), or 4 (HOLDOVER).	<code>{from="dpll",iface="ens2fx",node="compute-1.example.com",process="dpll"} 3</code>
<code>openshift_ptp_phase_status</code>	Returns the status of the DPLL phase for the NIC. Possible values are -1 (UNKNOWN), 0 (INVALID), 1 (FREERUN), 2 (LOCKED), 3 (LOCKED_HO_ACQ), or 4 (HOLDOVER).	<code>{from="dpll",iface="ens2fx",node="compute-1.example.com",process="dpll"} 3</code>
<code>openshift_ptp_interface_role</code>	Returns the configured PTP clock role for the interface. Possible values are 0 (PASSIVE), 1 (SLAVE), 2 (MASTER), 3 (FAULTY), 4 (UNKNOWN), or 5 (LISTENING).	<code>{iface="ens2f0", node="compute-1.example.com", process="ptp4l"} 2</code>
<code>openshift_ptp_max_offset_ns</code>	Returns the maximum offset in nanoseconds between 2 clocks or interfaces. For example, between the upstream GNSS clock and the NIC (ts2phc), or between the PTP hardware clock (phc) and the system clock (phc2sys). Applicable to T-GM clocks only.	<code>{from="master", iface="ens2fx", node="compute-1.example.com", process="ts2phc"} 1.038099569e+09</code>
<code>openshift_ptp_offset_ns</code>	Returns the offset in nanoseconds between the DPLL clock or the GNSS clock source and the NIC hardware clock. Applicable to T-GM clocks only.	<code>{from="phc", iface="CLOCK_REALTIME", node="compute-1.example.com", process="phc2sys"} -9</code>
<code>openshift_ptp_process_restart_count</code>	Returns a count of the number of times the ptp4l process was restarted.	<code>{config="ptp4l.0.config", node="compute-1.example.com",process="phc2sys"} 1</code>
<code>openshift_ptp_process_status</code>	Returns a status code that shows whether the PTP process is running or not.	<code>{config="ptp4l.0.config", node="compute-1.example.com",process="phc2sys"} 1</code>

Metric	Description	Example
<code>openshift_ptp_threshold</code>	<p>Returns values for HoldOverTimeout, MaxOffsetThreshold, and MinOffsetThreshold.</p> <ul style="list-style-type: none"> • holdOverTimeout is the time value in seconds before the PTP clock event state changes to FREERUN when the PTP master clock is disconnected. • maxOffsetThreshold and minOffsetThreshold are offset values in nanoseconds that compare against the values for CLOCK_REALTIME (phc2sys) or master offset (ptp4l) values that you configure in the PtpConfig CR for the NIC. 	<code>{node="compute-1.example.com", profile="grandmaster", threshold="HoldOverTimeout"} 5</code>
<code>openshift_ptp_pps_status</code>	<p>Returns the current status of the NIC 1PPS connection. You use the 1PPS connection to synchronize timing between connected NICs. Possible values are 0 (UNAVAILABLE) and 1 (AVAILABLE).</p>	<code>{from="dpll",iface="ens2fx",node="compute-1.example.com",process="dpll"} 1</code>
<code>openshift_ptp_nmea_status</code>	<p>Returns the current status of the NMEA connection. NMEA is the protocol that is used for 1PPS NIC connections. Possible values are 0 (UNAVAILABLE) and 1 (AVAILABLE).</p>	<code>{iface="ens2fx",node="compute-1.example.com",process="ts2phc"} 1</code>
<code>openshift_ptp_gnss_status</code>	<p>Returns the current status of the global navigation satellite system (GNSS) connection. GNSS provides satellite-based positioning, navigation, and timing services globally. Possible values are 0 (NOFIX), 1 (DEAD RECKONING ONLY), 2 (2D-FIX), 3 (3D-FIX), 4 (GPS+DEAD RECKONING FIX), 5, (TIME ONLY FIX).</p>	<code>{from="gnss",iface="ens2fx",node="compute-1.example.com",process="gnss"} 3</code>

21.4. DEVELOPING PTP EVENTS CONSUMER APPLICATIONS

When developing consumer applications that make use of Precision Time Protocol (PTP) events on a bare-metal cluster node, you need to deploy your consumer application and a **cloud-event-proxy** container in a separate application pod. The **cloud-event-proxy** container receives the events from the PTP Operator pod and passes it to the consumer application. The consumer application subscribes to the events posted in the **cloud-event-proxy** container by using a REST API.

For more information about deploying PTP events applications, see [About the PTP fast event notifications framework](#).

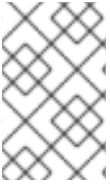
**NOTE**

The following information provides general guidance for developing consumer applications that use PTP events. A complete events consumer application example is outside the scope of this information.

21.4.1. PTP events consumer application reference

PTP event consumer applications require the following features:

1. A web service running with a **POST** handler to receive the cloud native PTP events JSON payload
2. A **createSubscription** function to subscribe to the PTP events producer
3. A **getCurrentState** function to poll the current state of the PTP events producer

The following example Go snippets illustrate these requirements:

Example PTP events consumer server function in Go

```
func server() {
    http.HandleFunc("/event", getEvent)
    http.ListenAndServe("localhost:8989", nil)
}

func getEvent(w http.ResponseWriter, req *http.Request) {
    defer req.Body.Close()
    bodyBytes, err := io.ReadAll(req.Body)
    if err != nil {
        log.Errorf("error reading event %v", err)
    }
    e := string(bodyBytes)
    if e != "" {
        processEvent(bodyBytes)
        log.Infof("received event %s", string(bodyBytes))
    } else {
        w.WriteHeader(http.StatusNoContent)
    }
}
```

Example PTP events createSubscription function in Go

```
import (
    "github.com/redhat-cne/sdk-go/pkg/pubsub"
    "github.com/redhat-cne/sdk-go/pkg/types"
    v1pubsub "github.com/redhat-cne/sdk-go/v1/pubsub"
)

// Subscribe to PTP events using REST API
s1, _ := createsubscription("/cluster/node/<node_name>/sync/sync-status/os-clock-sync-state") 1
s2, _ := createsubscription("/cluster/node/<node_name>/sync/ptp-status/ptp-clock-class-change")
s3, _ := createsubscription("/cluster/node/<node_name>/sync/ptp-status/lock-state")

// Create PTP event subscriptions POST
```

```

func createSubscription(resourceAddress string) (sub pubsub.PubSub, err error) {
    var status int
    apiPath:= "/api/ocloudNotifications/v1/"
    localAPIAddr:=localhost:8989 // vDU service API address
    apiAddr:= "localhost:8089" // event framework API address

    subURL := &types.URI{URL: url.URL{Scheme: "http",
        Host: apiAddr
        Path: fmt.Sprintf("%s%s", apiPath, "subscriptions")}}
    endpointURL := &types.URI{URL: url.URL{Scheme: "http",
        Host: localAPIAddr,
        Path: "event"}}

    sub = v1pubsub.NewPubSub(endpointURL, resourceAddress)
    var subB []byte

    if subB, err = json.Marshal(&sub); err == nil {
        rc := restclient.New()
        if status, subB = rc.PostWithReturn(subURL, subB); status != http.StatusCreated {
            err = fmt.Errorf("error in subscription creation api at %s, returned status %d", subURL, status)
        } else {
            err = json.Unmarshal(subB, &sub)
        }
    } else {
        err = fmt.Errorf("failed to marshal subscription for %s", resourceAddress)
    }
    return
}

```

- 1 Replace **<node_name>** with the FQDN of the node that is generating the PTP events. For example, **compute-1.example.com**.

Example PTP events consumer getCurrentState function in Go

```

//Get PTP event state for the resource
func getCurrentState(resource string) {
    //Create publisher
    url := &types.URI{URL: url.URL{Scheme: "http",
        Host: localhost:8989,
        Path: fmt.Sprintf("/api/ocloudNotifications/v1/%s/CurrentState",resource)}}
    rc := restclient.New()
    status, event := rc.Get(url)
    if status != http.StatusOK {
        log.Errorf("CurrentState:error %d from url %s, %s", status, url.String(), event)
    } else {
        log.Debug("Got CurrentState: %s ", event)
    }
}

```

21.4.2. Reference cloud-event-proxy deployment and service CRs

Use the following example **cloud-event-proxy** deployment and subscriber service CRs as a reference when deploying your PTP events consumer application.

**NOTE**

HTTP transport is the default transport for PTP and bare-metal events. Use HTTP transport instead of AMQP for PTP and bare-metal events where possible. AMQ Interconnect is EOL from 30 June 2024. Extended life cycle support (ELS) for AMQ Interconnect ends 29 November 2029. For more information see, [Red Hat AMQ Interconnect support status](#).

Reference cloud-event-proxy deployment with HTTP transport

```

apiVersion: apps/v1
kind: Deployment
metadata:
  name: event-consumer-deployment
  namespace: <namespace>
  labels:
    app: consumer
spec:
  replicas: 1
  selector:
    matchLabels:
      app: consumer
  template:
    metadata:
      labels:
        app: consumer
    spec:
      serviceAccountName: sidecar-consumer-sa
      containers:
        - name: event-subscriber
          image: event-subscriber-app
        - name: cloud-event-proxy-as-sidecar
          image: openshift4/ose-cloud-event-proxy
          args:
            - "--metrics-addr=127.0.0.1:9091"
            - "--store-path=/store"
            - "--transport-host=consumer-events-subscription-service.cloud-events.svc.cluster.local:9043"
            - "--http-event-publishers=ptp-event-publisher-service-NODE_NAME.openshift-
ptp.svc.cluster.local:9043"
            - "--api-port=8089"
          env:
            - name: NODE_NAME
              valueFrom:
                fieldRef:
                  fieldPath: spec.nodeName
            - name: NODE_IP
              valueFrom:
                fieldRef:
                  fieldPath: status.hostIP
          volumeMounts:
            - name: pubsubstore
              mountPath: /store
      ports:
        - name: metrics-port
          containerPort: 9091

```

```

- name: sub-port
  containerPort: 9043
volumes:
- name: pubsubstore
  emptyDir: {}

```

Reference cloud-event-proxy deployment with AMQ transport

```

apiVersion: apps/v1
kind: Deployment
metadata:
  name: cloud-event-proxy-sidecar
  namespace: cloud-events
  labels:
    app: cloud-event-proxy
spec:
  selector:
    matchLabels:
      app: cloud-event-proxy
  template:
    metadata:
      labels:
        app: cloud-event-proxy
    spec:
      nodeSelector:
        node-role.kubernetes.io/worker: ""
      containers:
        - name: cloud-event-sidecar
          image: openshift4/ose-cloud-event-proxy
          args:
            - "--metrics-addr=127.0.0.1:9091"
            - "--store-path=/store"
            - "--transport-host=amqp://router.router.svc.cluster.local"
            - "--api-port=8089"
          env:
            - name: <node_name>
              valueFrom:
                fieldRef:
                  fieldPath: spec.nodeName
            - name: <node_ip>
              valueFrom:
                fieldRef:
                  fieldPath: status.hostIP
          volumeMounts:
            - name: pubsubstore
              mountPath: /store
          ports:
            - name: metrics-port
              containerPort: 9091
            - name: sub-port
              containerPort: 9043
          volumes:
            - name: pubsubstore
              emptyDir: {}

```

Reference cloud-event-proxy subscriber service

```

apiVersion: v1
kind: Service
metadata:
  annotations:
    prometheus.io/scrape: "true"
    service.alpha.openshift.io/serving-cert-secret-name: sidecar-consumer-secret
  name: consumer-events-subscription-service
  namespace: cloud-events
  labels:
    app: consumer-service
spec:
  ports:
    - name: sub-port
      port: 9043
  selector:
    app: consumer
  clusterIP: None
  sessionAffinity: None
  type: ClusterIP

```

21.4.3. PTP events available from the cloud-event-proxy sidecar REST API

PTP events consumer applications can poll the PTP events producer for the following PTP timing events.

Table 21.15. PTP events available from the cloud-event-proxy sidecar

Resource URI	Description
/cluster/node/<node_name>/sync/ptp-status/lock-state	Describes the current status of the PTP equipment lock state. Can be in LOCKED , HOLDOVER , or FREERUN state.
/cluster/node/<node_name>/sync/sync-status/os-clock-sync-state	Describes the host operating system clock synchronization state. Can be in LOCKED or FREERUN state.
/cluster/node/<node_name>/sync/ptp-status/ptp-clock-class-change	Describes the current state of the PTP clock class.

21.4.4. Subscribing the consumer application to PTP events

Before the PTP events consumer application can poll for events, you need to subscribe the application to the event producer.

21.4.4.1. Subscribing to PTP lock-state events

To create a subscription for PTP **lock-state** events, send a **POST** action to the cloud event API at **http://localhost:8081/api/ocloudNotifications/v1/subscriptions** with the following payload:

```
{
  "endpointUri": "http://localhost:8989/event",
  "resource": "/cluster/node/<node_name>/sync/ptp-status/lock-state",
}
```

Example response

```
{
  "id": "e23473d9-ba18-4f78-946e-401a0caeff90",
  "endpointUri": "http://localhost:8989/event",
  "uriLocation": "http://localhost:8089/api/ocloudNotifications/v1/subscriptions/e23473d9-ba18-4f78-946e-401a0caeff90",
  "resource": "/cluster/node/<node_name>/sync/ptp-status/lock-state",
}
```

21.4.4.2. Subscribing to PTP os-clock-sync-state events

To create a subscription for PTP **os-clock-sync-state** events, send a **POST** action to the cloud event API at **http://localhost:8081/api/ocloudNotifications/v1/subscriptions** with the following payload:

```
{
  "endpointUri": "http://localhost:8989/event",
  "resource": "/cluster/node/<node_name>/sync/sync-status/os-clock-sync-state",
}
```

Example response

```
{
  "id": "e23473d9-ba18-4f78-946e-401a0caeff90",
  "endpointUri": "http://localhost:8989/event",
  "uriLocation": "http://localhost:8089/api/ocloudNotifications/v1/subscriptions/e23473d9-ba18-4f78-946e-401a0caeff90",
  "resource": "/cluster/node/<node_name>/sync/sync-status/os-clock-sync-state",
}
```

21.4.4.3. Subscribing to PTP ptp-clock-class-change events

To create a subscription for PTP **ptp-clock-class-change** events, send a **POST** action to the cloud event API at **http://localhost:8081/api/ocloudNotifications/v1/subscriptions** with the following payload:

```
{
  "endpointUri": "http://localhost:8989/event",
  "resource": "/cluster/node/<node_name>/sync/ptp-status/ptp-clock-class-change",
}
```

Example response

```
{
  "id": "e23473d9-ba18-4f78-946e-401a0caeff90",
  "endpointUri": "http://localhost:8989/event",
  "uriLocation": "http://localhost:8089/api/ocloudNotifications/v1/subscriptions/e23473d9-ba18-4f78-
```

```

946e-401a0caeff90",
"resource": "/cluster/node/<node_name>/sync/ptp-status/ptp-clock-class-change",
}

```

21.4.5. Getting the current PTP clock status

To get the current PTP status for the node, send a **GET** action to one of the following event REST APIs:

- **`http://localhost:8081/api/ocloudNotifications/v1/cluster/node/<node_name>/sync/ptp-status/lock-state/CurrentState`**
- **`http://localhost:8081/api/ocloudNotifications/v1/cluster/node/<node_name>/sync/sync-status/os-clock-sync-state/CurrentState`**
- **`http://localhost:8081/api/ocloudNotifications/v1/cluster/node/<node_name>/sync/ptp-status/ptp-clock-class-change/CurrentState`**

The response is a cloud native event JSON object. For example:

Example lock-state API response

```

{
  "id": "c1ac3aa5-1195-4786-84f8-da0ea4462921",
  "type": "event.sync.ptp-status.ptp-state-change",
  "source": "/cluster/node/compute-1.example.com/sync/ptp-status/lock-state",
  "dataContentType": "application/json",
  "time": "2023-01-10T02:41:57.094981478Z",
  "data": {
    "version": "v1",
    "values": [
      {
        "resource": "/cluster/node/compute-1.example.com/ens5fx/master",
        "dataType": "notification",
        "valueType": "enumeration",
        "value": "LOCKED"
      },
      {
        "resource": "/cluster/node/compute-1.example.com/ens5fx/master",
        "dataType": "metric",
        "valueType": "decimal64.3",
        "value": "29"
      }
    ]
  }
}

```

21.4.6. Verifying that the PTP events consumer application is receiving events

Verify that the **cloud-event-proxy** container in the application pod is receiving PTP events.

Prerequisites

- You have installed the OpenShift CLI (**oc**).
- You have logged in as a user with **cluster-admin** privileges.

- You have installed and configured the PTP Operator.

Procedure

- Get the list of active **linuxptp-daemon** pods. Run the following command:

```
$ oc get pods -n openshift-ntp
```

Example output

```
NAME                READY STATUS  RESTARTS  AGE
linuxptp-daemon-2t78p 3/3   Running  0         8h
linuxptp-daemon-k8n88 3/3   Running  0         8h
```

- Access the metrics for the required consumer-side **cloud-event-proxy** container by running the following command:

```
$ oc exec -it <linuxptp-daemon> -n openshift-ntp -c cloud-event-proxy -- curl 127.0.0.1:9091/metrics
```

where:

<linuxptp-daemon>

Specifies the pod you want to query, for example, **linuxptp-daemon-2t78p**.

Example output

```
# HELP cne_transport_connections_resets Metric to get number of connection resets
# TYPE cne_transport_connections_resets gauge
cne_transport_connection_reset 1
# HELP cne_transport_receiver Metric to get number of receiver created
# TYPE cne_transport_receiver gauge
cne_transport_receiver{address="/cluster/node/compute-1.example.com/ntp",status="active"} 2
cne_transport_receiver{address="/cluster/node/compute-1.example.com/redfish/event",status="active"} 2
# HELP cne_transport_sender Metric to get number of sender created
# TYPE cne_transport_sender gauge
cne_transport_sender{address="/cluster/node/compute-1.example.com/ntp",status="active"} 1
cne_transport_sender{address="/cluster/node/compute-1.example.com/redfish/event",status="active"} 1
# HELP cne_events_ack Metric to get number of events produced
# TYPE cne_events_ack gauge
cne_events_ack{status="success",type="/cluster/node/compute-1.example.com/ntp"} 18
cne_events_ack{status="success",type="/cluster/node/compute-1.example.com/redfish/event"} 18
# HELP cne_events_transport_published Metric to get number of events published by the transport
# TYPE cne_events_transport_published gauge
cne_events_transport_published{address="/cluster/node/compute-1.example.com/ntp",status="failed"} 1
cne_events_transport_published{address="/cluster/node/compute-1.example.com/ntp",status="success"} 18
```

```

cne_events_transport_published{address="/cluster/node/compute-
1.example.com/redfish/event",status="failed"} 1
cne_events_transport_published{address="/cluster/node/compute-
1.example.com/redfish/event",status="success"} 18
# HELP cne_events_transport_received Metric to get number of events received by the
transport
# TYPE cne_events_transport_received gauge
cne_events_transport_received{address="/cluster/node/compute-
1.example.com/ptp",status="success"} 18
cne_events_transport_received{address="/cluster/node/compute-
1.example.com/redfish/event",status="success"} 18
# HELP cne_events_api_published Metric to get number of events published by the rest
api
# TYPE cne_events_api_published gauge
cne_events_api_published{address="/cluster/node/compute-
1.example.com/ptp",status="success"} 19
cne_events_api_published{address="/cluster/node/compute-
1.example.com/redfish/event",status="success"} 19
# HELP cne_events_received Metric to get number of events received
# TYPE cne_events_received gauge
cne_events_received{status="success",type="/cluster/node/compute-1.example.com/ptp"}
18
cne_events_received{status="success",type="/cluster/node/compute-
1.example.com/redfish/event"} 18
# HELP promhttp_metric_handler_requests_in_flight Current number of scrapes being
served.
# TYPE promhttp_metric_handler_requests_in_flight gauge
promhttp_metric_handler_requests_in_flight 1
# HELP promhttp_metric_handler_requests_total Total number of scrapes by HTTP status
code.
# TYPE promhttp_metric_handler_requests_total counter
promhttp_metric_handler_requests_total{code="200"} 4
promhttp_metric_handler_requests_total{code="500"} 0
promhttp_metric_handler_requests_total{code="503"} 0

```

CHAPTER 22. EXTERNAL DNS OPERATOR

22.1. EXTERNAL DNS OPERATOR RELEASE NOTES

The External DNS Operator deploys and manages **ExternalDNS** to provide name resolution for services and routes from the external DNS provider to OpenShift Container Platform.

These release notes track the development of the External DNS Operator in OpenShift Container Platform.

22.1.1. External DNS Operator 1.2.0

The following advisory is available for the External DNS Operator version 1.2.0:

- [RHEA-2022:5867 ExternalDNS Operator 1.2 operator/operand containers](#)

22.1.1.1. New features

- The External DNS Operator now supports AWS shared VPC. For more information, see [Creating DNS records in a different AWS Account using a shared VPC](#) .

22.1.1.2. Bug fixes

- The update strategy for the operand changed from **Rolling** to **Recreate**. ([OCPBUGS-3630](#))

22.1.2. External DNS Operator 1.1.1

The following advisory is available for the External DNS Operator version 1.1.1:

- [RHEA-2024:0536 ExternalDNS Operator 1.1 operator/operand containers](#)

22.1.3. External DNS Operator 1.1.0

This release included a rebase of the operand from the upstream project version 0.13.1. The following advisory is available for the External DNS Operator version 1.1.0:

- [RHEA-2022:9086-01 ExternalDNS Operator 1.1 operator/operand containers](#)

22.1.3.1. Bug fixes

- Previously, the ExternalDNS Operator enforced an empty **defaultMode** value for volumes, which caused constant updates due to a conflict with the OpenShift API. Now, the **defaultMode** value is not enforced and operand deployment does not update constantly. ([OCPBUGS-2793](#))

22.1.4. External DNS Operator 1.0.1

The following advisory is available for the External DNS Operator version 1.0.1:

- [RHEA-2024:0537 ExternalDNS Operator 1.0 operator/operand containers](#)

22.1.5. External DNS Operator 1.0.0

The following advisory is available for the External DNS Operator version 1.0.0:

- [RHEA-2022:5867 ExternalDNS Operator 1.0 operator/operand containers](#)

22.1.5.1. Bug fixes

- Previously, the External DNS Operator issued a warning about the violation of the restricted SCC policy during ExternalDNS operand pod deployments. This issue has been resolved. ([BZ#2086408](#))

22.2. EXTERNAL DNS OPERATOR IN OPENSIFT CONTAINER PLATFORM

The External DNS Operator deploys and manages **ExternalDNS** to provide the name resolution for services and routes from the external DNS provider to OpenShift Container Platform.

22.2.1. External DNS Operator

The External DNS Operator implements the External DNS API from the **olm.openshift.io** API group. The External DNS Operator updates services, routes, and external DNS providers.

Prerequisites

- You have installed the **yq** CLI tool.

Procedure

You can deploy the External DNS Operator on demand from the OperatorHub. Deploying the External DNS Operator creates a **Subscription** object.

1. Check the name of an install plan by running the following command:

```
$ oc -n external-dns-operator get sub external-dns-operator -o yaml | yq '.status.installplan.name'
```

Example output

```
install-zcvlr
```

2. Check if the status of an install plan is **Complete** by running the following command:

```
$ oc -n external-dns-operator get ip <install_plan_name> -o yaml | yq '.status.phase'
```

Example output

```
Complete
```

3. View the status of the **external-dns-operator** deployment by running the following command:

```
$ oc get -n external-dns-operator deployment/external-dns-operator
```

Example output

NAME	READY	UP-TO-DATE	AVAILABLE	AGE
external-dns-operator	1/1	1	1	23h

22.2.2. External DNS Operator logs

You can view External DNS Operator logs by using the **oc logs** command.

Procedure

1. View the logs of the External DNS Operator by running the following command:

```
$ oc logs -n external-dns-operator deployment/external-dns-operator -c external-dns-operator
```

22.2.2.1. External DNS Operator domain name limitations

The External DNS Operator uses the TXT registry which adds the prefix for TXT records. This reduces the maximum length of the domain name for TXT records. A DNS record cannot be present without a corresponding TXT record, so the domain name of the DNS record must follow the same limit as the TXT records. For example, a DNS record of **<domain_name_from_source>** results in a TXT record of **external-dns-<record_type>-<domain_name_from_source>**.

The domain name of the DNS records generated by the External DNS Operator has the following limitations:

Record type	Number of characters
CNAME	44
Wildcard CNAME records on AzureDNS	42
A	48
Wildcard A records on AzureDNS	46

The following error appears in the External DNS Operator logs if the generated domain name exceeds any of the domain name limitations:

```
time="2022-09-02T08:53:57Z" level=error msg="Failure in zone test.example.io. [Id: /hostedzone/Z06988883Q0H0RL6UMXXX]"
time="2022-09-02T08:53:57Z" level=error msg="InvalidChangeBatch: [FATAL problem: DomainLabelTooLong (Domain label is too long) encountered with 'external-dns-a-hello-openshift-aaaaaaaaa-bbbbbbbbbb-cccccc']\n\tstatus code: 400, request id: e54dfd5a-06c6-47b0-bcb9-a4f7c3a4e0c6"
```

22.3. INSTALLING EXTERNAL DNS OPERATOR ON CLOUD PROVIDERS

You can install the External DNS Operator on cloud providers such as AWS, Azure, and GCP.

22.3.1. Installing the External DNS Operator

You can install the External DNS Operator by using the OpenShift Container Platform OperatorHub.

Procedure

1. Click **Operators** → **OperatorHub** in the OpenShift Container Platform web console.
2. Click **External DNS Operator**. You can use the **Filter by keyword** text box or the filter list to search for External DNS Operator from the list of Operators.
3. Select the **external-dns-operator** namespace.
4. On the **External DNS Operator** page, click **Install**.
5. On the **Install Operator** page, ensure that you selected the following options:
 - a. Update the channel as **stable-v1**.
 - b. Installation mode as **A specific name on the cluster**
 - c. Installed namespace as **external-dns-operator**. If namespace **external-dns-operator** does not exist, it gets created during the Operator installation.
 - d. Select **Approval Strategy** as **Automatic** or **Manual**. Approval Strategy is set to **Automatic** by default.
 - e. Click **Install**.

If you select **Automatic** updates, the Operator Lifecycle Manager (OLM) automatically upgrades the running instance of your Operator without any intervention.

If you select **Manual** updates, the OLM creates an update request. As a cluster administrator, you must then manually approve that update request to have the Operator updated to the new version.

Verification

Verify that the External DNS Operator shows the **Status** as **Succeeded** on the **Installed Operators** dashboard.

22.4. EXTERNAL DNS OPERATOR CONFIGURATION PARAMETERS

The External DNS Operator includes the following configuration parameters.

22.4.1. External DNS Operator configuration parameters

The External DNS Operator includes the following configuration parameters:

Parameter	Description
-----------	-------------

Parameter	Description
spec	<p>Enables the type of a cloud provider.</p> <pre>spec: provider: type: AWS 1 aws: credentials: name: aws-access-key 2</pre> <p>1 Defines available options such as AWS, GCP, Azure, and Infoblox.</p> <p>2 Defines a secret name for your cloud provider.</p>
zones	<p>Enables you to specify DNS zones by their domains. If you do not specify zones, the ExternalDNS resource discovers all of the zones present in your cloud provider account.</p> <pre>zones: - "myzoneid" 1</pre> <p>1 Specifies the name of DNS zones.</p>
domains	<p>Enables you to specify AWS zones by their domains. If you do not specify domains, the ExternalDNS resource discovers all of the zones present in your cloud provider account.</p> <pre>domains: - filterType: Include 1 matchType: Exact 2 name: "myzonedomain1.com" 3 - filterType: Include matchType: Pattern 4 pattern: ".*\\.otherzonedomain\\.com" 5</pre> <p>1 Ensures that the ExternalDNS resource includes the domain name.</p> <p>2 Instructs ExternalDNS that the domain matching has to be exact as opposed to regular expression match.</p> <p>3 Defines the name of the domain.</p> <p>4 Sets the regex-domain-filter flag in the ExternalDNS resource. You can limit possible domains by using a Regex filter.</p> <p>5 Defines the regex pattern to be used by the ExternalDNS resource to filter the domains of the target zones.</p>

Parameter	Description
	<p>Enables you to specify the source for the DNS records, Service or Route.</p> <pre> source: 1 type: Service 2 service: serviceType: 3 - LoadBalancer - ClusterIP labelFilter: 4 matchLabels: external-dns.mydomain.org/publish: "yes" hostnameAnnotation: "Allow" 5 fqdnTemplate: - "{{.Name}}.myzonedomain.com" 6 </pre> <p>1 Defines the settings for the source of DNS records.</p> <p>2 The ExternalDNS resource uses the Service type as the source for creating DNS records.</p> <p>3 Sets the service-type-filter flag in the ExternalDNS resource. The serviceType contains the following fields:</p> <ul style="list-style-type: none"> • default: LoadBalancer • expected: ClusterIP • NodePort • LoadBalancer • ExternalName <p>4 Ensures that the controller considers only those resources which matches with label filter.</p> <p>5 The default value for hostnameAnnotation is ignore which instructs ExternalDNS to generate DNS records using the templates specified in the field fqdnTemplates. When the value is Allow the DNS records get generated based on the value specified in the external-dns.alpha.kubernetes.io/hostname annotation.</p> <p>6 The External DNS Operator uses a string to generate DNS names from sources that don't define a hostname, or to add a hostname suffix when paired with the fake source.</p> <pre> source: type: OpenShiftRoute 1 openshiftRouteOptions: routerName: default 2 labelFilter: matchLabels: external-dns.mydomain.org/publish: "yes" </pre> <p>1 Creates DNS records.</p> <p>2</p>

Parameter	Description
	If the source type is OpenShiftRoute , then you can pass the Ingress controller name. The ExternalDNS resource uses the canonical name of

22.5. CREATING DNS RECORDS ON AWS

You can create DNS records on AWS and AWS GovCloud by using External DNS Operator.

22.5.1. Creating DNS records on an public hosted zone for AWS by using Red Hat External DNS Operator

You can create DNS records on a public hosted zone for AWS by using the Red Hat External DNS Operator. You can use the same instructions to create DNS records on a hosted zone for AWS GovCloud.

Procedure

1. Check the user. The user must have access to the **kube-system** namespace. If you don't have the credentials, as you can fetch the credentials from the **kube-system** namespace to use the cloud provider client:

```
$ oc whoami
```

Example output

```
system:admin
```

2. Fetch the values from aws-creds secret present in **kube-system** namespace.

```
$ export AWS_ACCESS_KEY_ID=$(oc get secrets aws-creds -n kube-system --template={{.data.aws_access_key_id}} | base64 -d)
$ export AWS_SECRET_ACCESS_KEY=$(oc get secrets aws-creds -n kube-system --template={{.data.aws_secret_access_key}} | base64 -d)
```

3. Get the routes to check the domain:

```
$ oc get routes --all-namespaces | grep console
```

Example output

```
openshift-console      console      console-openshift-
console.apps.testextdnsoperator.apacshift.support      console      https
reencrypt/Redirect    None
openshift-console      downloads    downloads-openshift-
console.apps.testextdnsoperator.apacshift.support      downloads    http
edge/Redirect          None
```

4. Get the list of dns zones to find the one which corresponds to the previously found route's domain:

```
$ aws route53 list-hosted-zones | grep testextdnsoperator.apacshift.support
```

Example output

```
HOSTEDZONES terraform /hostedzone/Z02355203TNN1XXXX1J6O
testextdnsoperator.apacshift.support. 5
```

5. Create **ExternalDNS** resource for **route** source:

```
$ cat <<EOF | oc create -f -
apiVersion: externaldns.olm.openshift.io/v1beta1
kind: ExternalDNS
metadata:
  name: sample-aws 1
spec:
  domains:
    - filterType: Include 2
      matchType: Exact 3
      name: testextdnsoperator.apacshift.support 4
  provider:
    type: AWS 5
  source: 6
    type: OpenShiftRoute 7
    openshiftRouteOptions:
      routerName: default 8
EOF
```

- 1 Defines the name of external DNS resource.
- 2 By default all hosted zones are selected as potential targets. You can include a hosted zone that you need.
- 3 The matching of the target zone's domain has to be exact (as opposed to regular expression match).
- 4 Specify the exact domain of the zone you want to update. The hostname of the routes must be subdomains of the specified domain.
- 5 Defines the **AWS Route53** DNS provider.
- 6 Defines options for the source of DNS records.
- 7 Defines OpenShift **route** resource as the source for the DNS records which gets created in the previously specified DNS provider.
- 8 If the source is **OpenShiftRoute**, then you can pass the OpenShift Ingress Controller name. External DNS Operator selects the canonical hostname of that router as the target while creating CNAME record.

6. Check the records created for OCP routes using the following command:

```
$ aws route53 list-resource-record-sets --hosted-zone-id Z02355203TNN1XXXX1J6O --
query "ResourceRecordSets[?Type == 'CNAME']" | grep console
```

22.5.2. Creating DNS records in a different AWS Account using a shared VPC

You can use the ExternalDNS Operator to create DNS records in a different AWS account using a shared Virtual Private Cloud (VPC). By using a shared VPC, an organization can connect resources from multiple projects to a common VPC network. Organizations can then use VPC sharing to use a single Route 53 instance across multiple AWS accounts.

Prerequisites

- You have created two Amazon AWS accounts: one with a VPC and a Route 53 private hosted zone configured (Account A), and another for installing a cluster (Account B).
- You have created an IAM Policy and IAM Role with the appropriate permissions in Account A for Account B to create DNS records in the Route 53 hosted zone of Account A.
- You have installed a cluster in Account B into the existing VPC for Account A.
- You have installed the ExternalDNS Operator in the cluster in Account B.

Procedure

1. Get the Role ARN of the IAM Role that you created to allow Account B to access Account A's Route 53 hosted zone by running the following command:

```
$ aws --profile account-a iam get-role --role-name user-rol1 | head -1
```

Example output

```
ROLE arn:aws:iam::1234567890123:role/user-rol1 2023-09-14T17:21:54+00:00 3600 /  
ARO3SGB2ZRKRT5NISNJV user-rol1
```

2. Locate the private hosted zone to use with Account A's credentials by running the following command:

```
$ aws --profile account-a route53 list-hosted-zones | grep  
testextdnsoperator.apacshift.support
```

Example output

```
HOSTEDZONES terraform /hostedzone/Z02355203TNN1XXXX1J6O  
testextdnsoperator.apacshift.support. 5
```

3. Create the **ExternalDNS** object by running the following command:

```
$ cat <<EOF | oc create -f -  
apiVersion: externaldns.olm.openshift.io/v1beta1  
kind: ExternalDNS  
metadata:  
  name: sample-aws  
spec:  
  domains:  
  - filterType: Include  
    matchType: Exact  
    name: testextdnsoperator.apacshift.support  
  provider:  
  type: AWS
```

```
aws:
  assumeRole:
    arn: arn:aws:iam::12345678901234:role/user-rol1 1
  source:
    type: OpenShiftRoute
    openshiftRouteOptions:
      routerName: default
EOF
```

- 1** Specify the Role ARN to have DNS records created in Account A.

4. Check the records created for OpenShift Container Platform (OCP) routes by using the following command:

```
$ aws --profile account-a route53 list-resource-record-sets --hosted-zone-id
Z02355203TNN1XXXX1J6O --query "ResourceRecordSets[?Type == 'CNAME']" | grep
console-openshift-console
```

22.6. CREATING DNS RECORDS ON AZURE

You can create DNS records on Azure by using the External DNS Operator.

22.6.1. Creating DNS records on an Azure public DNS zone

You can create DNS records on a public DNS zone for Azure by using the External DNS Operator.

Prerequisites

- You must have administrator privileges.
- The **admin** user must have access to the **kube-system** namespace.

Procedure

1. Fetch the credentials from the **kube-system** namespace to use the cloud provider client by running the following command:

```
$ CLIENT_ID=$(oc get secrets azure-credentials -n kube-system --template=
{{.data.azure_client_id}} | base64 -d)
$ CLIENT_SECRET=$(oc get secrets azure-credentials -n kube-system --template=
{{.data.azure_client_secret}} | base64 -d)
$ RESOURCE_GROUP=$(oc get secrets azure-credentials -n kube-system --template=
{{.data.azure_resourcegroup}} | base64 -d)
$ SUBSCRIPTION_ID=$(oc get secrets azure-credentials -n kube-system --template=
{{.data.azure_subscription_id}} | base64 -d)
$ TENANT_ID=$(oc get secrets azure-credentials -n kube-system --template=
{{.data.azure_tenant_id}} | base64 -d)
```

2. Log in to Azure by running the following command:

```
$ az login --service-principal -u "${CLIENT_ID}" -p "${CLIENT_SECRET}" --tenant
"${TENANT_ID}"
```

- Get a list of routes by running the following command:

```
$ oc get routes --all-namespaces | grep console
```

Example output

```
openshift-console      console      console-openshift-
console.apps.test.azure.example.com      console      https  reencrypt/Redirect
None
openshift-console      downloads    downloads-openshift-
console.apps.test.azure.example.com      downloads    http   edge/Redirect
None
```

- Get a list of DNS zones by running the following command:

```
$ az network dns zone list --resource-group "${RESOURCE_GROUP}"
```

- Create a YAML file, for example, **external-dns-sample-azure.yaml**, that defines the **ExternalDNS** object:

Example external-dns-sample-azure.yaml file

```
apiVersion: externaldns.olm.openshift.io/v1beta1
kind: ExternalDNS
metadata:
  name: sample-azure 1
spec:
  zones:
    - "/subscriptions/1234567890/resourceGroups/test-azure-xxxx-
rg/providers/Microsoft.Network/dnszones/test.azure.example.com" 2
  provider:
    type: Azure 3
  source:
    openshiftRouteOptions: 4
    routerName: default 5
    type: OpenShiftRoute 6
```

- Specifies the External DNS name.
- Defines the zone ID.
- Defines the provider type.
- You can define options for the source of DNS records.
- If the source type is **OpenShiftRoute**, you can pass the OpenShift Ingress Controller name. External DNS selects the canonical hostname of that router as the target while creating CNAME record.
- Defines the **route** resource as the source for the Azure DNS records.

- Check the DNS records created for OpenShift Container Platform routes by running the following command:

```
$ az network dns record-set list -g "${RESOURCE_GROUP}" -z test.azure.example.com |
grep console
```

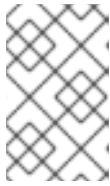

NOTE

To create records on private hosted zones on private Azure DNS, you need to specify the private zone under the **zones** field which populates the provider type to **azure-private-dns** in the **ExternalDNS** container arguments.

22.7. CREATING DNS RECORDS ON GCP

You can create DNS records on GCP by using the External DNS Operator.

22.7.1. Creating DNS records on a public managed zone for GCP

You can create DNS records on a public managed zone for GCP by using the External DNS Operator.

Prerequisites

- You must have administrator privileges.

Procedure

1. Copy the **gcp-credentials** secret in the **encoded-gcloud.json** file by running the following command:

```
$ oc get secret gcp-credentials -n kube-system --template='{{$v := index .data
"service_account.json"}}{{$v}}' | base64 -d - > decoded-gcloud.json
```

2. Export your Google credentials by running the following command:

```
$ export GOOGLE_CREDENTIALS=decoded-gcloud.json
```

3. Activate your account by using the following command:

```
$ gcloud auth activate-service-account <client_email as per decoded-gcloud.json> --key-
file=decoded-gcloud.json
```

4. Set your project by running the following command:

```
$ gcloud config set project <project_id as per decoded-gcloud.json>
```

5. Get a list of routes by running the following command:

```
$ oc get routes --all-namespaces | grep console
```

Example output

```
openshift-console      console      console-openshift-
console.apps.test.gcp.example.com      console      https reencrypt/Redirect
None
```

```
openshift-console      downloads      downloads-openshift-
console.apps.test.gcp.example.com      downloads      http  edge/Redirect
None
```

6. Get a list of managed zones by running the following command:

```
$ gcloud dns managed-zones list | grep test.gcp.example.com
```

Example output

```
qe-cvs4g-private-zone test.gcp.example.com
```

7. Create a YAML file, for example, **external-dns-sample-gcp.yaml**, that defines the **ExternalDNS** object:

Example external-dns-sample-gcp.yaml file

```
apiVersion: externaldns.olm.openshift.io/v1beta1
kind: ExternalDNS
metadata:
  name: sample-gcp 1
spec:
  domains:
    - filterType: Include 2
      matchType: Exact 3
      name: test.gcp.example.com 4
  provider:
    type: GCP 5
  source:
    openshiftRouteOptions: 6
      routerName: default 7
    type: OpenShiftRoute 8
```

- 1 Specifies the External DNS name.
- 2 By default, all hosted zones are selected as potential targets. You can include your hosted zone.
- 3 The domain of the target must match the string defined by the **name** key.
- 4 Specify the exact domain of the zone you want to update. The hostname of the routes must be subdomains of the specified domain.
- 5 Defines the provider type.
- 6 You can define options for the source of DNS records.
- 7 If the source type is **OpenShiftRoute**, you can pass the OpenShift Ingress Controller name. External DNS selects the canonical hostname of that router as the target while creating CNAME record.
- 8 Defines the **route** resource as the source for GCP DNS records.

- Check the DNS records created for OpenShift Container Platform routes by running the following command:

```
$ gcloud dns record-sets list --zone=qe-cvs4g-private-zone | grep console
```

22.8. CREATING DNS RECORDS ON INFOBLOX

You can create DNS records on Infoblox by using the External DNS Operator.

22.8.1. Creating DNS records on a public DNS zone on Infoblox

You can create DNS records on a public DNS zone on Infoblox by using the External DNS Operator.

Prerequisites

- You have access to the OpenShift CLI (**oc**).
- You have access to the Infoblox UI.

Procedure

- Create a **secret** object with Infoblox credentials by running the following command:

```
$ oc -n external-dns-operator create secret generic infoblox-credentials --from-literal=EXTERNAL_DNS_INFOBLOX_WAPI_USERNAME=<infoblox_username> --from-literal=EXTERNAL_DNS_INFOBLOX_WAPI_PASSWORD=<infoblox_password>
```

- Get a list of routes by running the following command:

```
$ oc get routes --all-namespaces | grep console
```

Example Output

```
openshift-console      console      console-openshift-console.apps.test.example.com
console                https reencrypt/Redirect  None
openshift-console     downloads   downloads-openshift-
console.apps.test.example.com      downloads      http  edge/Redirect
None
```

- Create a YAML file, for example, **external-dns-sample-infoblox.yaml**, that defines the **ExternalDNS** object:

Example external-dns-sample-infoblox.yaml file

```
apiVersion: externaldns.olm.openshift.io/v1beta1
kind: ExternalDNS
metadata:
  name: sample-infoblox 1
spec:
  provider:
    type: Infoblox 2
  infoblox:
```

```

credentials:
  name: infoblox-credentials
  gridHost: ${INFOBLOX_GRID_PUBLIC_IP}
  wapiPort: 443
  wapiVersion: "2.3.1"
domains:
- filterType: Include
  matchType: Exact
  name: test.example.com
source:
  type: OpenShiftRoute 3
  openshiftRouteOptions:
    routerName: default 4

```

- 1 Specifies the External DNS name.
- 2 Defines the provider type.
- 3 You can define options for the source of DNS records.
- 4 If the source type is **OpenShiftRoute**, you can pass the OpenShift Ingress Controller name. External DNS selects the canonical hostname of that router as the target while creating CNAME record.

4. Create the **ExternalDNS** resource on Infoblox by running the following command:

```
$ oc create -f external-dns-sample-infoblox.yaml
```

5. From the Infoblox UI, check the DNS records created for **console** routes:
 - a. Click **Data Management** → **DNS** → **Zones**.
 - b. Select the zone name.

22.9. CONFIGURING THE CLUSTER-WIDE PROXY ON THE EXTERNAL DNS OPERATOR

After configuring the cluster-wide proxy, the Operator Lifecycle Manager (OLM) triggers automatic updates to all of the deployed Operators with the new contents of the **HTTP_PROXY**, **HTTPS_PROXY**, and **NO_PROXY** environment variables.

22.9.1. Trusting the certificate authority of the cluster-wide proxy

You can configure the External DNS Operator to trust the certificate authority of the cluster-wide proxy.

Procedure

1. Create the config map to contain the CA bundle in the **external-dns-operator** namespace by running the following command:

```
$ oc -n external-dns-operator create configmap trusted-ca
```

2. To inject the trusted CA bundle into the config map, add the **config.openshift.io/inject-trusted-cabundle=true** label to the config map by running the following command:

```
$ oc -n external-dns-operator label cm trusted-ca config.openshift.io/inject-trusted-cabundle=true
```

3. Update the subscription of the External DNS Operator by running the following command:

```
$ oc -n external-dns-operator patch subscription external-dns-operator --type='json' -p='[{"op": "add", "path": "/spec/config", "value":{"env":[{"name":"TRUSTED_CA_CONFIGMAP_NAME","value":"trusted-ca"}]}]'
```

Verification

- After the deployment of the External DNS Operator is completed, verify that the trusted CA environment variable is added to the **external-dns-operator** deployment by running the following command:

```
$ oc -n external-dns-operator exec deploy/external-dns-operator -c external-dns-operator --printenv TRUSTED_CA_CONFIGMAP_NAME
```

Example output

```
trusted-ca
```

CHAPTER 23. NETWORK POLICY

23.1. ABOUT NETWORK POLICY

As a cluster administrator, you can define network policies that restrict traffic to pods in your cluster.

23.1.1. About network policy

In a cluster using a network plugin that supports Kubernetes network policy, network isolation is controlled entirely by **NetworkPolicy** objects. In OpenShift Container Platform 4.15, OpenShift SDN supports using network policy in its default network isolation mode.



WARNING

Network policy does not apply to the host network namespace. Pods with host networking enabled are unaffected by network policy rules. However, pods connecting to the host-networked pods might be affected by the network policy rules.

Network policies cannot block traffic from localhost or from their resident nodes.

By default, all pods in a project are accessible from other pods and network endpoints. To isolate one or more pods in a project, you can create **NetworkPolicy** objects in that project to indicate the allowed incoming connections. Project administrators can create and delete **NetworkPolicy** objects within their own project.

If a pod is matched by selectors in one or more **NetworkPolicy** objects, then the pod will accept only connections that are allowed by at least one of those **NetworkPolicy** objects. A pod that is not selected by any **NetworkPolicy** objects is fully accessible.

A network policy applies to only the TCP, UDP, ICMP, and SCTP protocols. Other protocols are not affected.

The following example **NetworkPolicy** objects demonstrate supporting different scenarios:

- Deny all traffic:
To make a project deny by default, add a **NetworkPolicy** object that matches all pods but accepts no traffic:

```
kind: NetworkPolicy
apiVersion: networking.k8s.io/v1
metadata:
  name: deny-by-default
spec:
  podSelector: {}
  ingress: []
```

- Only allow connections from the OpenShift Container Platform Ingress Controller:

To make a project allow only connections from the OpenShift Container Platform Ingress Controller, add the following **NetworkPolicy** object.

```
apiVersion: networking.k8s.io/v1
kind: NetworkPolicy
metadata:
  name: allow-from-openshift-ingress
spec:
  ingress:
  - from:
    - namespaceSelector:
        matchLabels:
          network.openshift.io/policy-group: ingress
  podSelector: {}
  policyTypes:
  - Ingress
```

- Only accept connections from pods within a project:
To make pods accept connections from other pods in the same project, but reject all other connections from pods in other projects, add the following **NetworkPolicy** object:

```
kind: NetworkPolicy
apiVersion: networking.k8s.io/v1
metadata:
  name: allow-same-namespace
spec:
  podSelector: {}
  ingress:
  - from:
    - podSelector: {}
```

- Only allow HTTP and HTTPS traffic based on pod labels:
To enable only HTTP and HTTPS access to the pods with a specific label (**role=frontend** in following example), add a **NetworkPolicy** object similar to the following:

```
kind: NetworkPolicy
apiVersion: networking.k8s.io/v1
metadata:
  name: allow-http-and-https
spec:
  podSelector:
    matchLabels:
      role: frontend
  ingress:
  - ports:
    - protocol: TCP
      port: 80
    - protocol: TCP
      port: 443
```

- Accept connections by using both namespace and pod selectors:
To match network traffic by combining namespace and pod selectors, you can use a **NetworkPolicy** object similar to the following:

```

kind: NetworkPolicy
apiVersion: networking.k8s.io/v1
metadata:
  name: allow-pod-and-namespace-both
spec:
  podSelector:
    matchLabels:
      name: test-pods
  ingress:
    - from:
      - namespaceSelector:
          matchLabels:
            project: project_name
        podSelector:
          matchLabels:
            name: test-pods

```

NetworkPolicy objects are additive, which means you can combine multiple **NetworkPolicy** objects together to satisfy complex network requirements.

For example, for the **NetworkPolicy** objects defined in previous samples, you can define both **allow-same-namespace** and **allow-http-and-https** policies within the same project. Thus allowing the pods with the label **role=frontend**, to accept any connection allowed by each policy. That is, connections on any port from pods in the same namespace, and connections on ports **80** and **443** from pods in any namespace.

23.1.1.1. Using the allow-from-router network policy

Use the following **NetworkPolicy** to allow external traffic regardless of the router configuration:

```

apiVersion: networking.k8s.io/v1
kind: NetworkPolicy
metadata:
  name: allow-from-router
spec:
  ingress:
    - from:
      - namespaceSelector:
          matchLabels:
            policy-group.network.openshift.io/ingress: "" 1
  podSelector: {}
  policyTypes:
    - Ingress

```

1 **policy-group.network.openshift.io/ingress: ""** label supports both OpenShift-SDN and OVN-Kubernetes.

23.1.1.2. Using the allow-from-hostnetwork network policy

Add the following **allow-from-hostnetwork NetworkPolicy** object to direct traffic from the host network pods:

```

apiVersion: networking.k8s.io/v1

```



```

kind: NetworkPolicy
metadata:
  name: allow-from-hostnetwork
spec:
  ingress:
  - from:
    - namespaceSelector:
        matchLabels:
          policy-group.network.openshift.io/host-network: ""
  podSelector: {}
  policyTypes:
  - Ingress

```

23.1.2. Optimizations for network policy with OpenShift SDN

Use a network policy to isolate pods that are differentiated from one another by labels within a namespace.

It is inefficient to apply **NetworkPolicy** objects to large numbers of individual pods in a single namespace. Pod labels do not exist at the IP address level, so a network policy generates a separate Open vSwitch (OVS) flow rule for every possible link between every pod selected with a **podSelector**.

For example, if the spec **podSelector** and the ingress **podSelector** within a **NetworkPolicy** object each match 200 pods, then 40,000 (200*200) OVS flow rules are generated. This might slow down a node.

When designing your network policy, refer to the following guidelines:

- Reduce the number of OVS flow rules by using namespaces to contain groups of pods that need to be isolated.
NetworkPolicy objects that select a whole namespace, by using the **namespaceSelector** or an empty **podSelector**, generate only a single OVS flow rule that matches the VXLAN virtual network ID (VNID) of the namespace.
- Keep the pods that do not need to be isolated in their original namespace, and move the pods that require isolation into one or more different namespaces.
- Create additional targeted cross-namespace network policies to allow the specific traffic that you do want to allow from the isolated pods.

23.1.3. Optimizations for network policy with OVN-Kubernetes network plugin

When designing your network policy, refer to the following guidelines:

- For network policies with the same **spec.podSelector** spec, it is more efficient to use one network policy with multiple **ingress** or **egress** rules, than multiple network policies with subsets of **ingress** or **egress** rules.
- Every **ingress** or **egress** rule based on the **podSelector** or **namespaceSelector** spec generates the number of OVS flows proportional to **number of pods selected by network policy + number of pods selected by ingress or egress rule**. Therefore, it is preferable to use the **podSelector** or **namespaceSelector** spec that can select as many pods as you need in one rule, instead of creating individual rules for every pod.

For example, the following policy contains two rules:

```

apiVersion: networking.k8s.io/v1

```

```

kind: NetworkPolicy
metadata:
  name: test-network-policy
spec:
  podSelector: {}
  ingress:
  - from:
    - podSelector:
        matchLabels:
          role: frontend
  - from:
    - podSelector:
        matchLabels:
          role: backend

```

The following policy expresses those same two rules as one:

```

apiVersion: networking.k8s.io/v1
kind: NetworkPolicy
metadata:
  name: test-network-policy
spec:
  podSelector: {}
  ingress:
  - from:
    - podSelector:
        matchExpressions:
        - {key: role, operator: In, values: [frontend, backend]}

```

The same guideline applies to the **spec.podSelector** spec. If you have the same **ingress** or **egress** rules for different network policies, it might be more efficient to create one network policy with a common **spec.podSelector** spec. For example, the following two policies have different rules:

```

apiVersion: networking.k8s.io/v1
kind: NetworkPolicy
metadata:
  name: policy1
spec:
  podSelector:
    matchLabels:
      role: db
  ingress:
  - from:
    - podSelector:
        matchLabels:
          role: frontend
---
apiVersion: networking.k8s.io/v1
kind: NetworkPolicy
metadata:
  name: policy2
spec:
  podSelector:
    matchLabels:

```

```

    role: client
  ingress:
  - from:
    - podSelector:
      matchLabels:
        role: frontend

```

The following network policy expresses those same two rules as one:

```

apiVersion: networking.k8s.io/v1
kind: NetworkPolicy
metadata:
  name: policy3
spec:
  podSelector:
    matchExpressions:
    - {key: role, operator: In, values: [db, client]}
  ingress:
  - from:
    - podSelector:
      matchLabels:
        role: frontend

```

You can apply this optimization when only multiple selectors are expressed as one. In cases where selectors are based on different labels, it may not be possible to apply this optimization. In those cases, consider applying some new labels for network policy optimization specifically.

23.1.4. Next steps

- [Creating a network policy](#)
- Optional: [Defining a default network policy](#)

23.1.5. Additional resources

- [Projects and namespaces](#)
- [Configuring multitenant network policy](#)
- [NetworkPolicy API](#)

23.2. CREATING A NETWORK POLICY

As a user with the **admin** role, you can create a network policy for a namespace.

23.2.1. Example NetworkPolicy object

The following annotates an example NetworkPolicy object:

```

kind: NetworkPolicy
apiVersion: networking.k8s.io/v1
metadata:
  name: allow-27107 1
spec:

```

```

podSelector: 2
  matchLabels:
    app: mongodb
ingress:
- from:
  - podSelector: 3
    matchLabels:
      app: app
ports: 4
  - protocol: TCP
    port: 27017

```

- 1 The name of the NetworkPolicy object.
- 2 A selector that describes the pods to which the policy applies. The policy object can only select pods in the project that defines the NetworkPolicy object.
- 3 A selector that matches the pods from which the policy object allows ingress traffic. The selector matches pods in the same namespace as the NetworkPolicy.
- 4 A list of one or more destination ports on which to accept traffic.

23.2.2. Creating a network policy using the CLI

To define granular rules describing ingress or egress network traffic allowed for namespaces in your cluster, you can create a network policy.



NOTE

If you log in with a user with the **cluster-admin** role, then you can create a network policy in any namespace in the cluster.

Prerequisites

- Your cluster uses a network plugin that supports **NetworkPolicy** objects, such as the OVN-Kubernetes network plugin or the OpenShift SDN network plugin with **mode: NetworkPolicy** set. This mode is the default for OpenShift SDN.
- You installed the OpenShift CLI (**oc**).
- You are logged in to the cluster with a user with **admin** privileges.
- You are working in the namespace that the network policy applies to.

Procedure

1. Create a policy rule:
 - a. Create a **<policy_name>.yaml** file:

```
$ touch <policy_name>.yaml
```

where:

<policy_name>

Specifies the network policy file name.

- b. Define a network policy in the file that you just created, such as in the following examples:

Deny ingress from all pods in all namespaces

This is a fundamental policy, blocking all cross-pod networking other than cross-pod traffic allowed by the configuration of other Network Policies.

```
kind: NetworkPolicy
apiVersion: networking.k8s.io/v1
metadata:
  name: deny-by-default
spec:
  podSelector: {}
  policyTypes:
  - Ingress
  ingress: []
```

Allow ingress from all pods in the same namespace

```
kind: NetworkPolicy
apiVersion: networking.k8s.io/v1
metadata:
  name: allow-same-namespace
spec:
  podSelector:
  ingress:
  - from:
    - podSelector: {}
```

Allow ingress traffic to one pod from a particular namespace

This policy allows traffic to pods labelled **pod-a** from pods running in **namespace-y**.

```
kind: NetworkPolicy
apiVersion: networking.k8s.io/v1
metadata:
  name: allow-traffic-pod
spec:
  podSelector:
  matchLabels:
    pod: pod-a
  policyTypes:
  - Ingress
  ingress:
  - from:
    - namespaceSelector:
        matchLabels:
          kubernetes.io/metadata.name: namespace-y
```

2. To create the network policy object, enter the following command:

```
$ oc apply -f <policy_name>.yaml -n <namespace>
```

where:

<policy_name>

Specifies the network policy file name.

<namespace>

Optional: Specifies the namespace if the object is defined in a different namespace than the current namespace.

Example output

```
networkpolicy.networking.k8s.io/deny-by-default created
```



NOTE

If you log in to the web console with **cluster-admin** privileges, you have a choice of creating a network policy in any namespace in the cluster directly in YAML or from a form in the web console.

23.2.3. Creating a default deny all network policy

This is a fundamental policy, blocking all cross-pod networking other than network traffic allowed by the configuration of other deployed network policies. This procedure enforces a default **deny-by-default** policy.



NOTE

If you log in with a user with the **cluster-admin** role, then you can create a network policy in any namespace in the cluster.

Prerequisites

- Your cluster uses a network plugin that supports **NetworkPolicy** objects, such as the OVN-Kubernetes network plugin or the OpenShift SDN network plugin with **mode: NetworkPolicy** set. This mode is the default for OpenShift SDN.
- You installed the OpenShift CLI (**oc**).
- You are logged in to the cluster with a user with **admin** privileges.
- You are working in the namespace that the network policy applies to.

Procedure

1. Create the following YAML that defines a **deny-by-default** policy to deny ingress from all pods in all namespaces. Save the YAML in the **deny-by-default.yaml** file:

```
kind: NetworkPolicy
apiVersion: networking.k8s.io/v1
metadata:
  name: deny-by-default
```

```
namespace: default 1
spec:
  podSelector: {} 2
  ingress: [] 3
```

- 1 namespace: default** deploys this policy to the **default** namespace.
- 2 podSelector:** is empty, this means it matches all the pods. Therefore, the policy applies to all pods in the default namespace.
- 3** There are no **ingress** rules specified. This causes incoming traffic to be dropped to all pods.

2. Apply the policy by entering the following command:

```
$ oc apply -f deny-by-default.yaml
```

Example output

```
networkpolicy.networking.k8s.io/deny-by-default created
```

23.2.4. Creating a network policy to allow traffic from external clients

With the **deny-by-default** policy in place you can proceed to configure a policy that allows traffic from external clients to a pod with the label **app=web**.



NOTE

If you log in with a user with the **cluster-admin** role, then you can create a network policy in any namespace in the cluster.

Follow this procedure to configure a policy that allows external service from the public Internet directly or by using a Load Balancer to access the pod. Traffic is only allowed to a pod with the label **app=web**.

Prerequisites

- Your cluster uses a network plugin that supports **NetworkPolicy** objects, such as the OVN-Kubernetes network plugin or the OpenShift SDN network plugin with **mode: NetworkPolicy** set. This mode is the default for OpenShift SDN.
- You installed the OpenShift CLI (**oc**).
- You are logged in to the cluster with a user with **admin** privileges.
- You are working in the namespace that the network policy applies to.

Procedure

1. Create a policy that allows traffic from the public Internet directly or by using a load balancer to access the pod. Save the YAML in the **web-allow-external.yaml** file:

```
kind: NetworkPolicy
```

```

apiVersion: networking.k8s.io/v1
metadata:
  name: web-allow-external
  namespace: default
spec:
  policyTypes:
  - Ingress
  podSelector:
    matchLabels:
      app: web
  ingress:
  - {}

```

- Apply the policy by entering the following command:

```
$ oc apply -f web-allow-external.yaml
```

Example output

```
networkpolicy.networking.k8s.io/web-allow-external created
```

This policy allows traffic from all resources, including external traffic as illustrated in the following diagram:

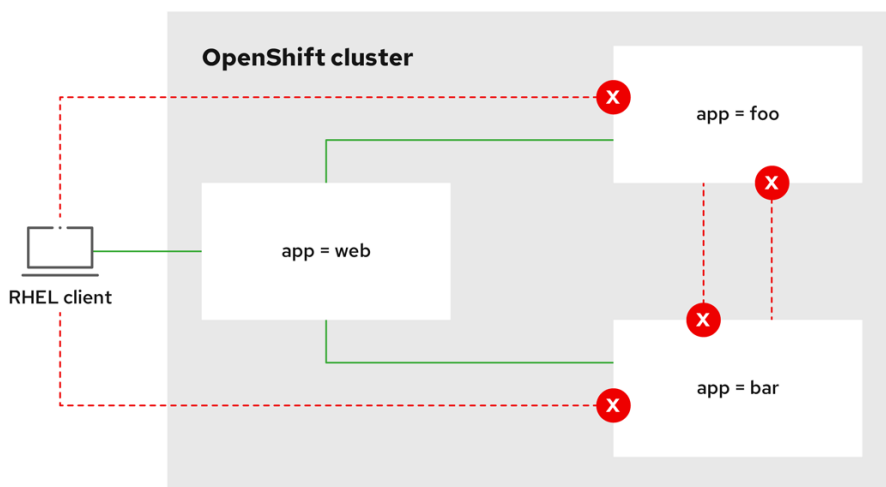

292_OpenShift_1122

23.2.5. Creating a network policy allowing traffic to an application from all namespaces



NOTE

If you log in with a user with the **cluster-admin** role, then you can create a network policy in any namespace in the cluster.

Follow this procedure to configure a policy that allows traffic from all pods in all namespaces to a particular application.

Prerequisites

- Your cluster uses a network plugin that supports **NetworkPolicy** objects, such as the OVN-Kubernetes network plugin or the OpenShift SDN network plugin with **mode: NetworkPolicy** set. This mode is the default for OpenShift SDN.
- You installed the OpenShift CLI (**oc**).
- You are logged in to the cluster with a user with **admin** privileges.
- You are working in the namespace that the network policy applies to.

Procedure

1. Create a policy that allows traffic from all pods in all namespaces to a particular application. Save the YAML in the **web-allow-all-namespaces.yaml** file:

```
kind: NetworkPolicy
apiVersion: networking.k8s.io/v1
metadata:
  name: web-allow-all-namespaces
  namespace: default
spec:
  podSelector:
    matchLabels:
      app: web ❶
  policyTypes:
  - Ingress
  ingress:
  - from:
    - namespaceSelector: {} ❷
```

- ❶ Applies the policy only to **app:web** pods in default namespace.
- ❷ Selects all pods in all namespaces.



NOTE

By default, if you omit specifying a **namespaceSelector** it does not select any namespaces, which means the policy allows traffic only from the namespace the network policy is deployed to.

2. Apply the policy by entering the following command:

```
$ oc apply -f web-allow-all-namespaces.yaml
```

Example output

```
networkpolicy.networking.k8s.io/web-allow-all-namespaces created
```

Verification

1. Start a web service in the **default** namespace by entering the following command:

```
$ oc run web --namespace=default --image=nginx --labels="app=web" --expose --port=80
```

- Run the following command to deploy an **alpine** image in the **secondary** namespace and to start a shell:

```
$ oc run test-$RANDOM --namespace=secondary --rm -i -t --image=alpine -- sh
```

- Run the following command in the shell and observe that the request is allowed:

```
# wget -qO- --timeout=2 http://web.default
```

Expected output

```
<!DOCTYPE html>
<html>
<head>
<title>Welcome to nginx!</title>
<style>
html { color-scheme: light dark; }
body { width: 35em; margin: 0 auto;
font-family: Tahoma, Verdana, Arial, sans-serif; }
</style>
</head>
<body>
<h1>Welcome to nginx!</h1>
<p>If you see this page, the nginx web server is successfully installed and
working. Further configuration is required.</p>

<p>For online documentation and support please refer to
<a href="http://nginx.org/">nginx.org</a>.<br/>
Commercial support is available at
<a href="http://nginx.com/">nginx.com</a>.</p>

<p><em>Thank you for using nginx.</em></p>
</body>
</html>
```

23.2.6. Creating a network policy allowing traffic to an application from a namespace

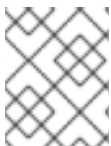

NOTE

If you log in with a user with the **cluster-admin** role, then you can create a network policy in any namespace in the cluster.

Follow this procedure to configure a policy that allows traffic to a pod with the label **app=web** from a particular namespace. You might want to do this to:

- Restrict traffic to a production database only to namespaces where production workloads are deployed.

- Enable monitoring tools deployed to a particular namespace to scrape metrics from the current namespace.

Prerequisites

- Your cluster uses a network plugin that supports **NetworkPolicy** objects, such as the OVN-Kubernetes network plugin or the OpenShift SDN network plugin with **mode: NetworkPolicy** set. This mode is the default for OpenShift SDN.
- You installed the OpenShift CLI (**oc**).
- You are logged in to the cluster with a user with **admin** privileges.
- You are working in the namespace that the network policy applies to.

Procedure

1. Create a policy that allows traffic from all pods in a particular namespaces with a label **purpose=production**. Save the YAML in the **web-allow-prod.yaml** file:

```
kind: NetworkPolicy
apiVersion: networking.k8s.io/v1
metadata:
  name: web-allow-prod
  namespace: default
spec:
  podSelector:
    matchLabels:
      app: web 1
  policyTypes:
  - Ingress
  ingress:
  - from:
    - namespaceSelector:
        matchLabels:
          purpose: production 2
```

- 1 Applies the policy only to **app:web** pods in the default namespace.
- 2 Restricts traffic to only pods in namespaces that have the label **purpose=production**.

2. Apply the policy by entering the following command:

```
$ oc apply -f web-allow-prod.yaml
```

Example output

```
networkpolicy.networking.k8s.io/web-allow-prod created
```

Verification

1. Start a web service in the **default** namespace by entering the following command:

```
$ oc run web --namespace=default --image=nginx --labels="app=web" --expose --port=80
```

2. Run the following command to create the **prod** namespace:

```
$ oc create namespace prod
```

3. Run the following command to label the **prod** namespace:

```
$ oc label namespace/prod purpose=production
```

4. Run the following command to create the **dev** namespace:

```
$ oc create namespace dev
```

5. Run the following command to label the **dev** namespace:

```
$ oc label namespace/dev purpose=testing
```

6. Run the following command to deploy an **alpine** image in the **dev** namespace and to start a shell:

```
$ oc run test-$RANDOM --namespace=dev --rm -i -t --image=alpine -- sh
```

7. Run the following command in the shell and observe that the request is blocked:

```
# wget -qO- --timeout=2 http://web.default
```

Expected output

```
wget: download timed out
```

8. Run the following command to deploy an **alpine** image in the **prod** namespace and start a shell:

```
$ oc run test-$RANDOM --namespace=prod --rm -i -t --image=alpine -- sh
```

9. Run the following command in the shell and observe that the request is allowed:

```
# wget -qO- --timeout=2 http://web.default
```

Expected output

```
<!DOCTYPE html>
<html>
<head>
<title>Welcome to nginx!</title>
<style>
html { color-scheme: light dark; }
body { width: 35em; margin: 0 auto;
font-family: Tahoma, Verdana, Arial, sans-serif; }
</style>
```

```

</head>
<body>
<h1>Welcome to nginx!</h1>
<p>If you see this page, the nginx web server is successfully installed and
working. Further configuration is required.</p>

<p>For online documentation and support please refer to
<a href="http://nginx.org/">nginx.org</a>.<br/>
Commercial support is available at
<a href="http://nginx.com/">nginx.com</a>.</p>

<p><em>Thank you for using nginx.</em></p>
</body>
</html>

```

23.2.7. Additional resources

- [Accessing the web console](#)
- [Logging for egress firewall and network policy rules](#)

23.3. VIEWING A NETWORK POLICY

As a user with the **admin** role, you can view a network policy for a namespace.

23.3.1. Example NetworkPolicy object

The following annotates an example NetworkPolicy object:

```

kind: NetworkPolicy
apiVersion: networking.k8s.io/v1
metadata:
  name: allow-27107 1
spec:
  podSelector: 2
    matchLabels:
      app: mongodb
  ingress:
  - from:
    - podSelector: 3
      matchLabels:
        app: app
  ports: 4
  - protocol: TCP
    port: 27017

```

- 1** The name of the NetworkPolicy object.
- 2** A selector that describes the pods to which the policy applies. The policy object can only select pods in the project that defines the NetworkPolicy object.
- 3** A selector that matches the pods from which the policy object allows ingress traffic. The selector matches pods in the same namespace as the NetworkPolicy.

- 4 A list of one or more destination ports on which to accept traffic.

23.3.2. Viewing network policies using the CLI

You can examine the network policies in a namespace.



NOTE

If you log in with a user with the **cluster-admin** role, then you can view any network policy in the cluster.

Prerequisites

- You installed the OpenShift CLI (**oc**).
- You are logged in to the cluster with a user with **admin** privileges.
- You are working in the namespace where the network policy exists.

Procedure

- List network policies in a namespace:
 - To view network policy objects defined in a namespace, enter the following command:

```
$ oc get networkpolicy
```

- Optional: To examine a specific network policy, enter the following command:

```
$ oc describe networkpolicy <policy_name> -n <namespace>
```

where:

<policy_name>

Specifies the name of the network policy to inspect.

<namespace>

Optional: Specifies the namespace if the object is defined in a different namespace than the current namespace.

For example:

```
$ oc describe networkpolicy allow-same-namespace
```

Output for **oc describe** command

```
Name:      allow-same-namespace
Namespace: ns1
Created on: 2021-05-24 22:28:56 -0400 EDT
Labels:    <none>
Annotations: <none>
Spec:
```

PodSelector: <none> (Allowing the specific traffic to all pods in this namespace)
 Allowing ingress traffic:
 To Port: <any> (traffic allowed to all ports)
 From:
 PodSelector: <none>
 Not affecting egress traffic
 Policy Types: Ingress



NOTE

If you log in to the web console with **cluster-admin** privileges, you have a choice of viewing a network policy in any namespace in the cluster directly in YAML or from a form in the web console.

23.4. EDITING A NETWORK POLICY

As a user with the **admin** role, you can edit an existing network policy for a namespace.

23.4.1. Editing a network policy

You can edit a network policy in a namespace.



NOTE

If you log in with a user with the **cluster-admin** role, then you can edit a network policy in any namespace in the cluster.

Prerequisites

- Your cluster uses a network plugin that supports **NetworkPolicy** objects, such as the OVN-Kubernetes network plugin or the OpenShift SDN network plugin with **mode: NetworkPolicy** set. This mode is the default for OpenShift SDN.
- You installed the OpenShift CLI (**oc**).
- You are logged in to the cluster with a user with **admin** privileges.
- You are working in the namespace where the network policy exists.

Procedure

1. Optional: To list the network policy objects in a namespace, enter the following command:

```
$ oc get networkpolicy
```

where:

<namespace>

Optional: Specifies the namespace if the object is defined in a different namespace than the current namespace.

2. Edit the network policy object.

- If you saved the network policy definition in a file, edit the file and make any necessary changes, and then enter the following command.

```
$ oc apply -n <namespace> -f <policy_file>.yaml
```

where:

<namespace>

Optional: Specifies the namespace if the object is defined in a different namespace than the current namespace.

<policy_file>

Specifies the name of the file containing the network policy.

- If you need to update the network policy object directly, enter the following command:

```
$ oc edit networkpolicy <policy_name> -n <namespace>
```

where:

<policy_name>

Specifies the name of the network policy.

<namespace>

Optional: Specifies the namespace if the object is defined in a different namespace than the current namespace.

3. Confirm that the network policy object is updated.

```
$ oc describe networkpolicy <policy_name> -n <namespace>
```

where:

<policy_name>

Specifies the name of the network policy.

<namespace>

Optional: Specifies the namespace if the object is defined in a different namespace than the current namespace.



NOTE

If you log in to the web console with **cluster-admin** privileges, you have a choice of editing a network policy in any namespace in the cluster directly in YAML or from the policy in the web console through the **Actions** menu.

23.4.2. Example NetworkPolicy object

The following annotates an example NetworkPolicy object:

```
kind: NetworkPolicy
apiVersion: networking.k8s.io/v1
metadata:
  name: allow-27107 1
```



```
spec:
  podSelector: ❷
    matchLabels:
      app: mongodb
  ingress:
  - from:
    - podSelector: ❸
      matchLabels:
        app: app
  ports: ❹
  - protocol: TCP
    port: 27017
```

- ❶ The name of the NetworkPolicy object.
- ❷ A selector that describes the pods to which the policy applies. The policy object can only select pods in the project that defines the NetworkPolicy object.
- ❸ A selector that matches the pods from which the policy object allows ingress traffic. The selector matches pods in the same namespace as the NetworkPolicy.
- ❹ A list of one or more destination ports on which to accept traffic.

23.4.3. Additional resources

- [Creating a network policy](#)

23.5. DELETING A NETWORK POLICY

As a user with the **admin** role, you can delete a network policy from a namespace.

23.5.1. Deleting a network policy using the CLI

You can delete a network policy in a namespace.



NOTE

If you log in with a user with the **cluster-admin** role, then you can delete any network policy in the cluster.

Prerequisites

- Your cluster uses a network plugin that supports **NetworkPolicy** objects, such as the OVN-Kubernetes network plugin or the OpenShift SDN network plugin with **mode: NetworkPolicy** set. This mode is the default for OpenShift SDN.
- You installed the OpenShift CLI (**oc**).
- You are logged in to the cluster with a user with **admin** privileges.
- You are working in the namespace where the network policy exists.

Procedure

- To delete a network policy object, enter the following command:

```
$ oc delete networkpolicy <policy_name> -n <namespace>
```

where:

<policy_name>

Specifies the name of the network policy.

<namespace>

Optional: Specifies the namespace if the object is defined in a different namespace than the current namespace.

Example output

```
networkpolicy.networking.k8s.io/default-deny deleted
```

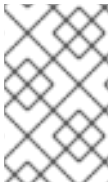

NOTE

If you log in to the web console with **cluster-admin** privileges, you have a choice of deleting a network policy in any namespace in the cluster directly in YAML or from the policy in the web console through the **Actions** menu.

23.6. DEFINING A DEFAULT NETWORK POLICY FOR PROJECTS

As a cluster administrator, you can modify the new project template to automatically include network policies when you create a new project. If you do not yet have a customized template for new projects, you must first create one.

23.6.1. Modifying the template for new projects

As a cluster administrator, you can modify the default project template so that new projects are created using your custom requirements.

To create your own custom project template:

Prerequisites

- You have access to an OpenShift Container Platform cluster using an account with **cluster-admin** permissions.

Procedure

1. Log in as a user with **cluster-admin** privileges.
2. Generate the default project template:

```
$ oc adm create-bootstrap-project-template -o yaml > template.yaml
```

3. Use a text editor to modify the generated **template.yaml** file by adding objects or modifying existing objects.

- The project template must be created in the **openshift-config** namespace. Load your modified template:

```
$ oc create -f template.yaml -n openshift-config
```

- Edit the project configuration resource using the web console or CLI.

- Using the web console:
 - Navigate to the **Administration** → **Cluster Settings** page.
 - Click **Configuration** to view all configuration resources.
 - Find the entry for **Project** and click **Edit YAML**.

- Using the CLI:
 - Edit the **project.config.openshift.io/cluster** resource:

```
$ oc edit project.config.openshift.io/cluster
```

- Update the **spec** section to include the **projectRequestTemplate** and **name** parameters, and set the name of your uploaded project template. The default name is **project-request**.

Project configuration resource with custom project template

```
apiVersion: config.openshift.io/v1
kind: Project
metadata:
  # ...
spec:
  projectRequestTemplate:
    name: <template_name>
  # ...
```

- After you save your changes, create a new project to verify that your changes were successfully applied.

23.6.2. Adding network policies to the new project template

As a cluster administrator, you can add network policies to the default template for new projects. OpenShift Container Platform will automatically create all the **NetworkPolicy** objects specified in the template in the project.

Prerequisites

- Your cluster uses a default CNI network plugin that supports **NetworkPolicy** objects, such as the OpenShift SDN network plugin with **mode: NetworkPolicy** set. This mode is the default for OpenShift SDN.
- You installed the OpenShift CLI (**oc**).
- You must log in to the cluster with a user with **cluster-admin** privileges.
- You must have created a custom default project template for new projects.

Procedure

1. Edit the default template for a new project by running the following command:

```
$ oc edit template <project_template> -n openshift-config
```

Replace **<project_template>** with the name of the default template that you configured for your cluster. The default template name is **project-request**.

2. In the template, add each **NetworkPolicy** object as an element to the **objects** parameter. The **objects** parameter accepts a collection of one or more objects. In the following example, the **objects** parameter collection includes several **NetworkPolicy** objects.

```
objects:
- apiVersion: networking.k8s.io/v1
  kind: NetworkPolicy
  metadata:
    name: allow-from-same-namespace
  spec:
    podSelector: {}
    ingress:
    - from:
      - podSelector: {}
- apiVersion: networking.k8s.io/v1
  kind: NetworkPolicy
  metadata:
    name: allow-from-openshift-ingress
  spec:
    ingress:
    - from:
      - namespaceSelector:
          matchLabels:
            network.openshift.io/policy-group: ingress
      podSelector: {}
      policyTypes:
      - Ingress
- apiVersion: networking.k8s.io/v1
  kind: NetworkPolicy
  metadata:
    name: allow-from-kube-apiserver-operator
  spec:
    ingress:
    - from:
      - namespaceSelector:
          matchLabels:
            kubernetes.io/metadata.name: openshift-kube-apiserver-operator
      podSelector:
          matchLabels:
            app: kube-apiserver-operator
      policyTypes:
      - Ingress
...
```

3. Optional: Create a new project to confirm that your network policy objects are created successfully by running the following commands:
 - a. Create a new project:

```
$ oc new-project <project> 1
```

- 1** Replace **<project>** with the name for the project you are creating.

- b. Confirm that the network policy objects in the new project template exist in the new project:

```
$ oc get networkpolicy
NAME                POD-SELECTOR  AGE
allow-from-openshift-ingress <none>       7s
allow-from-same-namespace <none>       7s
```

23.7. CONFIGURING MULTITENANT ISOLATION WITH NETWORK POLICY

As a cluster administrator, you can configure your network policies to provide multitenant network isolation.



NOTE

If you are using the OpenShift SDN network plugin, configuring network policies as described in this section provides network isolation similar to multitenant mode but with network policy mode set.

23.7.1. Configuring multitenant isolation by using network policy

You can configure your project to isolate it from pods and services in other project namespaces.

Prerequisites

- Your cluster uses a network plugin that supports **NetworkPolicy** objects, such as the OVN-Kubernetes network plugin or the OpenShift SDN network plugin with **mode: NetworkPolicy** set. This mode is the default for OpenShift SDN.
- You installed the OpenShift CLI (**oc**).
- You are logged in to the cluster with a user with **admin** privileges.

Procedure

1. Create the following **NetworkPolicy** objects:
 - a. A policy named **allow-from-openshift-ingress**.

```
$ cat << EOF | oc create -f -
apiVersion: networking.k8s.io/v1
kind: NetworkPolicy
metadata:
  name: allow-from-openshift-ingress
```

```
spec:
  ingress:
  - from:
    - namespaceSelector:
        matchLabels:
          policy-group.network.openshift.io/ingress: ""
  podSelector: {}
  policyTypes:
  - Ingress
EOF
```

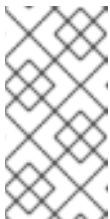
**NOTE**

policy-group.network.openshift.io/ingress: "" is the preferred namespace selector label for OpenShift SDN. You can use the **network.openshift.io/policy-group: ingress** namespace selector label, but this is a legacy label.

- b. A policy named **allow-from-openshift-monitoring**:

```
$ cat << EOF | oc create -f -
apiVersion: networking.k8s.io/v1
kind: NetworkPolicy
metadata:
  name: allow-from-openshift-monitoring
spec:
  ingress:
  - from:
    - namespaceSelector:
        matchLabels:
          network.openshift.io/policy-group: monitoring
  podSelector: {}
  policyTypes:
  - Ingress
EOF
```

- c. A policy named **allow-same-namespace**:

```
$ cat << EOF | oc create -f -
kind: NetworkPolicy
apiVersion: networking.k8s.io/v1
metadata:
  name: allow-same-namespace
spec:
  podSelector:
  ingress:
  - from:
    - podSelector: {}
EOF
```

- d. A policy named **allow-from-kube-apiserver-operator**:

```
$ cat << EOF | oc create -f -
apiVersion: networking.k8s.io/v1
```

```

kind: NetworkPolicy
metadata:
  name: allow-from-kube-apiserver-operator
spec:
  ingress:
  - from:
    - namespaceSelector:
        matchLabels:
          kubernetes.io/metadata.name: openshift-kube-apiserver-operator
      podSelector:
        matchLabels:
          app: kube-apiserver-operator
  policyTypes:
  - Ingress
EOF

```

For more details, see [New kube-apiserver-operator webhook controller validating health of webhook](#).

- Optional: To confirm that the network policies exist in your current project, enter the following command:

```
$ oc describe networkpolicy
```

Example output

```

Name:      allow-from-openshift-ingress
Namespace: example1
Created on: 2020-06-09 00:28:17 -0400 EDT
Labels:    <none>
Annotations: <none>
Spec:
  PodSelector: <none> (Allowing the specific traffic to all pods in this namespace)
  Allowing ingress traffic:
    To Port: <any> (traffic allowed to all ports)
  From:
    NamespaceSelector: network.openshift.io/policy-group: ingress
  Not affecting egress traffic
  Policy Types: Ingress

```

```

Name:      allow-from-openshift-monitoring
Namespace: example1
Created on: 2020-06-09 00:29:57 -0400 EDT
Labels:    <none>
Annotations: <none>
Spec:
  PodSelector: <none> (Allowing the specific traffic to all pods in this namespace)
  Allowing ingress traffic:
    To Port: <any> (traffic allowed to all ports)
  From:
    NamespaceSelector: network.openshift.io/policy-group: monitoring
  Not affecting egress traffic
  Policy Types: Ingress

```

23.7.2. Next steps

- [Defining a default network policy](#)

23.7.3. Additional resources

- [OpenShift SDN network isolation modes](#)

CHAPTER 24. CIDR RANGE DEFINITIONS

You must specify non-overlapping ranges for the following CIDR ranges.



NOTE

Machine CIDR ranges cannot be changed after creating your cluster.

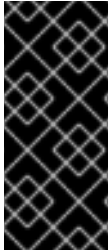

IMPORTANT

OVN-Kubernetes, the default network provider in OpenShift Container Platform 4.14 and later versions, uses the following IP address ranges internally: **100.64.0.0/16**, **169.254.169.0/29**, **100.88.0.0/16**, **fd98::/64**, **fd69::/125**, and the **fd97::/64**. If your cluster uses OVN-Kubernetes, do not include any IP address ranges in any other CIDR definitions in your cluster.

24.1. MACHINE CIDR

In the Machine classless inter-domain routing (CIDR) field, you must specify the IP address range for machines or cluster nodes.

The default is **10.0.0.0/16**. This range must not conflict with any connected networks.

24.2. SERVICE CIDR

In the Service CIDR field, you must specify the IP address range for services. The range must be large enough to accommodate your workload. The address block must not overlap with any external service accessed from within the cluster. The default is **172.30.0.0/16**.

24.3. POD CIDR

In the pod CIDR field, you must specify the IP address range for pods.

The pod CIDR is the same as the **clusterNetwork** CIDR and the cluster CIDR. The range must be large enough to accommodate your workload. The address block must not overlap with any external service accessed from within the cluster. The default is **10.128.0.0/14**. You can expand the range after cluster installation.

Additional resources

- [Cluster Network Operator configuration](#)
- [Configuring the cluster network range](#)

24.4. HOST PREFIX

In the Host Prefix field, you must specify the subnet prefix length assigned to pods scheduled to individual machines. The host prefix determines the pod IP address pool for each machine.

For example, if the host prefix is set to **/23**, each machine is assigned a **/23** subnet from the pod CIDR address range. The default is **/23**, allowing 510 cluster nodes, and 510 pod IP addresses per node.

CHAPTER 25. AWS LOAD BALANCER OPERATOR

25.1. AWS LOAD BALANCER OPERATOR RELEASE NOTES

The AWS Load Balancer (ALB) Operator deploys and manages an instance of the **AWSLoadBalancerController** resource.

These release notes track the development of the AWS Load Balancer Operator in OpenShift Container Platform.

For an overview of the AWS Load Balancer Operator, see [AWS Load Balancer Operator in OpenShift Container Platform](#).



NOTE

AWS Load Balancer Operator currently does not support AWS GovCloud.

25.1.1. AWS Load Balancer Operator 1.1.1

The following advisory is available for the AWS Load Balancer Operator version 1.1.1:

- [RHEA-2024:0555 Release of AWS Load Balancer Operator 1.1.z on OperatorHub](#)

25.1.2. AWS Load Balancer Operator 1.1.0

The AWS Load Balancer Operator version 1.1.0 supports the AWS Load Balancer Controller version 2.4.4.

The following advisory is available for the AWS Load Balancer Operator version 1.1.0:

- [RHEA-2023:6218 Release of AWS Load Balancer Operator on OperatorHub Enhancement Advisory Update](#)

25.1.2.1. Notable changes

- This release uses the Kubernetes API version 0.27.2.

25.1.2.2. New features

- The AWS Load Balancer Operator now supports a standardized Security Token Service (STS) flow by using the Cloud Credential Operator.

25.1.2.3. Bug fixes

- A FIPS-compliant cluster must use TLS version 1.2. Previously, webhooks for the AWS Load Balancer Controller only accepted TLS 1.3 as the minimum version, resulting in an error such as the following on a FIPS-compliant cluster:

```
remote error: tls: protocol version not supported
```

Now, the AWS Load Balancer Controller accepts TLS 1.2 as the minimum TLS version, resolving this issue. ([OCPBUGS-14846](#))

25.1.3. AWS Load Balancer Operator 1.0.1

The following advisory is available for the AWS Load Balancer Operator version 1.0.1:

- [Release of AWS Load Balancer Operator 1.0.1 on OperatorHub](#)

25.1.4. AWS Load Balancer Operator 1.0.0

The AWS Load Balancer Operator is now generally available with this release. The AWS Load Balancer Operator version 1.0.0 supports the AWS Load Balancer Controller version 2.4.4.

The following advisory is available for the AWS Load Balancer Operator version 1.0.0:

- [RHEA-2023:1954 Release of AWS Load Balancer Operator on OperatorHub Enhancement Advisory Update](#)



IMPORTANT

The AWS Load Balancer (ALB) Operator version 1.x.x cannot upgrade automatically from the Technology Preview version 0.x.x. To upgrade from an earlier version, you must uninstall the ALB operands and delete the **aws-load-balancer-operator** namespace.

25.1.4.1. Notable changes

- This release uses the new **v1** API version.

25.1.4.2. Bug fixes

- Previously, the controller provisioned by the AWS Load Balancer Operator did not properly use the configuration for the cluster-wide proxy. These settings are now applied appropriately to the controller. ([OCPBUGS-4052](#), [OCPBUGS-5295](#))

25.1.5. Earlier versions

The two earliest versions of the AWS Load Balancer Operator are available as a Technology Preview. These versions should not be used in a production cluster. For more information about the support scope of Red Hat Technology Preview features, see [Technology Preview Features Support Scope](#).

The following advisory is available for the AWS Load Balancer Operator version 0.2.0:

- [RHEA-2022:9084 Release of AWS Load Balancer Operator on OperatorHub Enhancement Advisory Update](#)

The following advisory is available for the AWS Load Balancer Operator version 0.0.1:

- [RHEA-2022:5780 Release of AWS Load Balancer Operator on OperatorHub Enhancement Advisory Update](#)

25.2. AWS LOAD BALANCER OPERATOR IN OPENSIFT CONTAINER PLATFORM

The AWS Load Balancer Operator deploys and manages the AWS Load Balancer Controller. You can install the AWS Load Balancer Operator from OperatorHub by using OpenShift Container Platform web console or CLI.

25.2.1. AWS Load Balancer Operator considerations

Review the following limitations before installing and using the AWS Load Balancer Operator:

- The IP traffic mode only works on AWS Elastic Kubernetes Service (EKS). The AWS Load Balancer Operator disables the IP traffic mode for the AWS Load Balancer Controller. As a result of disabling the IP traffic mode, the AWS Load Balancer Controller cannot use the pod readiness gate.
- The AWS Load Balancer Operator adds command-line flags such as **--disable-ingress-class-annotation** and **--disable-ingress-group-name-annotation** to the AWS Load Balancer Controller. Therefore, the AWS Load Balancer Operator does not allow using the **kubernetes.io/ingress.class** and **alb.ingress.kubernetes.io/group.name** annotations in the **Ingress** resource.

25.2.2. AWS Load Balancer Operator

The AWS Load Balancer Operator can tag the public subnets if the **kubernetes.io/role/elb** tag is missing. Also, the AWS Load Balancer Operator detects the following information from the underlying AWS cloud:

- The ID of the virtual private cloud (VPC) on which the cluster hosting the Operator is deployed in.
- Public and private subnets of the discovered VPC.

The AWS Load Balancer Operator supports the Kubernetes service resource of type **LoadBalancer** by using Network Load Balancer (NLB) with the **instance** target type only.

Procedure

1. You can deploy the AWS Load Balancer Operator on demand from OperatorHub, by creating a **Subscription** object by running the following command:

```
$ oc -n aws-load-balancer-operator get sub aws-load-balancer-operator --
template='{{.status.installplan.name}}'{{"\n"}}'
```

Example output

```
install-zlfbt
```

2. Check if the status of an install plan is **Complete** by running the following command:

```
$ oc -n aws-load-balancer-operator get ip <install_plan_name> --template='{{.status.phase}}
{{"\n"}}'
```

Example output

```
Complete
```

3. View the status of the **aws-load-balancer-operator-controller-manager** deployment by running the following command:

```
$ oc get -n aws-load-balancer-operator deployment/aws-load-balancer-operator-controller-manager
```

Example output

```
NAME                                READY  UP-TO-DATE  AVAILABLE  AGE
aws-load-balancer-operator-controller-manager  1/1    1           1          23h
```

25.2.3. Using the AWS Load Balancer Operator in an AWS VPC cluster extended into an Outpost

You can configure the AWS Load Balancer Operator to provision an AWS Application Load Balancer in an AWS VPC cluster extended into an Outpost. AWS Outposts does not support AWS Network Load Balancers. As a result, the AWS Load Balancer Operator cannot provision Network Load Balancers in an Outpost.

You can create an AWS Application Load Balancer either in the cloud subnet or in the Outpost subnet. An Application Load Balancer in the cloud can attach to cloud-based compute nodes and an Application Load Balancer in the Outpost can attach to edge compute nodes. You must annotate Ingress resources with the Outpost subnet or the VPC subnet, but not both.

Prerequisites

- You have extended an AWS VPC cluster into an Outpost.
- You have installed the OpenShift CLI (**oc**).
- You have installed the AWS Load Balancer Operator and created the AWS Load Balancer Controller.

Procedure

- Configure the **Ingress** resource to use a specified subnet:

Example Ingress resource configuration

```
apiVersion: networking.k8s.io/v1
kind: Ingress
metadata:
  name: <application_name>
  annotations:
    alb.ingress.kubernetes.io/subnets: <subnet_id> 1
spec:
  ingressClassName: alb
  rules:
  - http:
    paths:
    - path: /
      pathType: Exact
      backend:
        service:
          name: <application_name>
          port:
            number: 80
```

-
- 1 Specifies the subnet to use.
 - To use the Application Load Balancer in an Outpost, specify the Outpost subnet ID.
 - To use the Application Load Balancer in the cloud, you must specify at least two subnets in different availability zones.

25.2.4. AWS Load Balancer Operator logs

You can view the AWS Load Balancer Operator logs by using the **oc logs** command.

Procedure

- View the logs of the AWS Load Balancer Operator by running the following command:

```
$ oc logs -n aws-load-balancer-operator deployment/aws-load-balancer-operator-controller-manager -c manager
```

25.3. INSTALLING THE AWS LOAD BALANCER OPERATOR

The AWS Load Balancer Operator deploys and manages the AWS Load Balancer Controller. You can install the AWS Load Balancer Operator from the OperatorHub by using OpenShift Container Platform web console or CLI.

25.3.1. Installing the AWS Load Balancer Operator by using the web console

You can install the AWS Load Balancer Operator by using the web console.

Prerequisites

- You have logged in to the OpenShift Container Platform web console as a user with **cluster-admin** permissions.
- Your cluster is configured with AWS as the platform type and cloud provider.
- If you are using a security token service (STS) or user-provisioned infrastructure, follow the related preparation steps. For example, if you are using AWS Security Token Service, see "Preparing for the AWS Load Balancer Operator on a cluster using the AWS Security Token Service (STS)".

Procedure

1. Navigate to **Operators** → **OperatorHub** in the OpenShift Container Platform web console.
2. Select the **AWS Load Balancer Operator**. You can use the **Filter by keyword** text box or use the filter list to search for the AWS Load Balancer Operator from the list of Operators.
3. Select the **aws-load-balancer-operator** namespace.
4. On the **Install Operator** page, select the following options:
 - a. **Update the channel** as **stable-v1**.

- b. **Installation mode** as **All namespaces on the cluster (default)**
 - c. **Installed Namespace** as **aws-load-balancer-operator**. If the **aws-load-balancer-operator** namespace does not exist, it gets created during the Operator installation.
 - d. Select **Update approval** as **Automatic** or **Manual**. By default, the **Update approval** is set to **Automatic**. If you select automatic updates, the Operator Lifecycle Manager (OLM) automatically upgrades the running instance of your Operator without any intervention. If you select manual updates, the OLM creates an update request. As a cluster administrator, you must then manually approve that update request to update the Operator updated to the new version.
5. Click **Install**.

Verification

- Verify that the AWS Load Balancer Operator shows the **Status** as **Succeeded** on the Installed Operators dashboard.

25.3.2. Installing the AWS Load Balancer Operator by using the CLI

You can install the AWS Load Balancer Operator by using the CLI.

Prerequisites

- You are logged in to the OpenShift Container Platform web console as a user with **cluster-admin** permissions.
- Your cluster is configured with AWS as the platform type and cloud provider.
- You are logged into the OpenShift CLI (**oc**).

Procedure

1. Create a **Namespace** object:
 - a. Create a YAML file that defines the **Namespace** object:

Example namespace.yaml file

```
apiVersion: v1
kind: Namespace
metadata:
  name: aws-load-balancer-operator
```

- b. Create the **Namespace** object by running the following command:
- ```
$ oc apply -f namespace.yaml
```
2. Create an **OperatorGroup** object:
    - a. Create a YAML file that defines the **OperatorGroup** object:

#### Example operatorgroup.yaml file

■

```

apiVersion: operators.coreos.com/v1
kind: OperatorGroup
metadata:
 name: aws-lb-operatorgroup
 namespace: aws-load-balancer-operator
spec:
 upgradeStrategy: Default

```

- b. Create the **OperatorGroup** object by running the following command:

```
$ oc apply -f operatorgroup.yaml
```

3. Create a **Subscription** object:

- a. Create a YAML file that defines the **Subscription** object:

#### Example subscription.yaml file

```

apiVersion: operators.coreos.com/v1alpha1
kind: Subscription
metadata:
 name: aws-load-balancer-operator
 namespace: aws-load-balancer-operator
spec:
 channel: stable-v1
 installPlanApproval: Automatic
 name: aws-load-balancer-operator
 source: qe-app-registry
 sourceNamespace: openshift-marketplace

```

- b. Create the **Subscription** object by running the following command:

```
$ oc apply -f subscription.yaml
```

### Verification

1. Get the name of the install plan from the subscription:

```
$ oc -n aws-load-balancer-operator \
 get subscription aws-load-balancer-operator \
 --template='{{.status.installplan.name}}{\n\''
```

2. Check the status of the install plan:

```
$ oc -n aws-load-balancer-operator \
 get ip <install_plan_name> \
 --template='{{.status.phase}}{\n\''
```

The output must be **Complete**.

## 25.4. PREPARING FOR THE AWS LOAD BALANCER OPERATOR ON A CLUSTER USING THE AWS SECURITY TOKEN SERVICE



You can install the AWS Load Balancer Operator on a cluster that uses STS. Follow these steps to prepare your cluster before installing the Operator.

The AWS Load Balancer Operator relies on the **CredentialsRequest** object to bootstrap the Operator and the AWS Load Balancer Controller. The AWS Load Balancer Operator waits until the required secrets are created and available.

### 25.4.1. Creating an IAM role for the AWS Load Balancer Operator

An additional AWS Identity and Access Management (IAM) role is required to successfully install the AWS Load Balancer Operator on a cluster that uses STS. The IAM role is required to interact with subnets and Virtual Private Clouds (VPCs). The AWS Load Balancer Operator generates the **CredentialsRequest** object with the IAM role to bootstrap itself.

You can create the IAM role by using the following options:

- Using [the Cloud Credential Operator utility \(ccoctl\)](#) and a predefined **CredentialsRequest** object.
- Using the AWS CLI and predefined AWS manifests.

Use the AWS CLI if your environment does not support the **ccoctl** command.

#### 25.4.1.1. Creating an AWS IAM role by using the Cloud Credential Operator utility

You can use the Cloud Credential Operator utility (**ccoctl**) to create an AWS IAM role for the AWS Load Balancer Operator. An AWS IAM role is used to interact with subnets and Virtual Private Clouds (VPCs).

#### Prerequisites

- You must extract and prepare the **ccoctl** binary.

#### Procedure

1. Download the **CredentialsRequest** custom resource (CR) and store it in a directory by running the following command:

```
$ curl --create-dirs -o <credrequests-dir>/operator.yaml
https://raw.githubusercontent.com/openshift/aws-load-balancer-operator/main/hack/operator-credentials-request.yaml
```

2. Use the **ccoctl** utility to create an AWS IAM role by running the following command:

```
$ ccoctl aws create-iam-roles \
 --name <name> \
 --region=<aws_region> \
 --credentials-requests-dir=<credrequests-dir> \
 --identity-provider-arn <oidc-arn>
```

#### Example output

```
2023/09/12 11:38:57 Role arn:aws:iam::777777777777:role/<name>-aws-load-balancer-
operator-aws-load-balancer-operator created 1
2023/09/12 11:38:57 Saved credentials configuration to: /home/user/<credrequests-
```

```
dir>/manifests/aws-load-balancer-operator-aws-load-balancer-operator-credentials.yaml
2023/09/12 11:38:58 Updated Role policy for Role <name>-aws-load-balancer-operator-aws-
load-balancer-operator created
```

- 1 Note the Amazon Resource Name (ARN) of an AWS IAM role.



#### NOTE

The length of an AWS IAM role name must be less than or equal to 12 characters.

### 25.4.1.2. Creating an AWS IAM role by using the AWS CLI

You can use the AWS Command Line Interface to create an IAM role for the AWS Load Balancer Operator. The IAM role is used to interact with subnets and Virtual Private Clouds (VPCs).

#### Prerequisites

- You must have access to the AWS Command Line Interface (**aws**).

#### Procedure

1. Generate a trust policy file by using your identity provider by running the following command:

```
$ cat <<EOF > albo-operator-trust-policy.json
{
 "Version": "2012-10-17",
 "Statement": [
 {
 "Effect": "Allow",
 "Principal": {
 "Federated": "arn:aws:iam::777777777777:oidc-provider/<oidc-provider-id>" 1
 },
 "Action": "sts:AssumeRoleWithWebIdentity",
 "Condition": {
 "StringEquals": {
 "<oidc-provider-id>:sub": "system:serviceaccount:aws-load-balancer-
operator:aws-load-balancer-operator-controller-manager" 2
 }
 }
 }
]
}
EOF
```

- 1 Specifies the Amazon Resource Name (ARN) of the identity provider.
- 2 Specifies the service account for the AWS Load Balancer Operator.

2. Create the IAM role with the generated trust policy by running the following command:

```
$ aws iam create-role --role-name albo-operator --assume-role-policy-document file://albo-
operator-trust-policy.json
```

## Example output

```
ROLE arn:aws:iam::777777777777:role/albo-operator 2023-08-02T12:13:22Z 1
ASSUMEROLEPOLICYDOCUMENT 2012-10-17
STATEMENT sts:AssumeRoleWithWebIdentity Allow
STRINGEQUALS system:serviceaccount:aws-load-balancer-operator:aws-load-balancer-
controller-manager
PRINCIPAL arn:aws:iam:777777777777:oidc-provider/<oidc-provider-id>
```

**1** Note the ARN of the created IAM role.

- Download the permission policy for the AWS Load Balancer Operator by running the following command:

```
$ curl -o albo-operator-permission-policy.json
https://raw.githubusercontent.com/openshift/aws-load-balancer-operator/main/hack/operator-
permission-policy.json
```

- Attach the permission policy for the AWS Load Balancer Controller to the IAM role by running the following command:

```
$ aws iam put-role-policy --role-name albo-operator --policy-name perms-policy-albo-
operator --policy-document file://albo-operator-permission-policy.json
```

### 25.4.2. Configuring the ARN role for the AWS Load Balancer Operator

You can configure the Amazon Resource Name (ARN) role for the AWS Load Balancer Operator as an environment variable. You can configure the ARN role by using the CLI.

#### Prerequisites

- You have installed the OpenShift CLI (**oc**).

#### Procedure

- Create the **aws-load-balancer-operator** project by running the following command:

```
$ oc new-project aws-load-balancer-operator
```

- Create the **OperatorGroup** object by running the following command:

```
$ cat <<EOF | oc apply -f -
apiVersion: operators.coreos.com/v1
kind: OperatorGroup
metadata:
 name: aws-load-balancer-operator
 namespace: aws-load-balancer-operator
spec:
 targetNamespaces: []
EOF
```

- Create the **Subscription** object by running the following command:

```

$ cat <<EOF | oc apply -f -
apiVersion: operators.coreos.com/v1alpha1
kind: Subscription
metadata:
 name: aws-load-balancer-operator
 namespace: aws-load-balancer-operator
spec:
 channel: stable-v1
 name: aws-load-balancer-operator
 source: redhat-operators
 sourceNamespace: openshift-marketplace
 config:
 env:
 - name: ROLEARN
 value: "<role-arn>" 1
EOF

```

- 1** Specifies the ARN role to be used in the **CredentialsRequest** to provision the AWS credentials for the AWS Load Balancer Operator.



#### NOTE

The AWS Load Balancer Operator waits until the secret is created before moving to the **Available** status.

### 25.4.3. Creating an IAM role for the AWS Load Balancer Controller

The **CredentialsRequest** object for the AWS Load Balancer Controller must be set with a manually provisioned IAM role.

You can create the IAM role by using the following options:

- Using [the Cloud Credential Operator utility \(\*\*ccoctl\*\*\)](#) and a predefined **CredentialsRequest** object.
- Using the AWS CLI and predefined AWS manifests.

Use the AWS CLI if your environment does not support the **ccoctl** command.

#### 25.4.3.1. Creating an AWS IAM role for the controller by using the Cloud Credential Operator utility

You can use the Cloud Credential Operator utility (**ccoctl**) to create an AWS IAM role for the AWS Load Balancer Controller. An AWS IAM role is used to interact with subnets and Virtual Private Clouds (VPCs).

##### Prerequisites

- You must extract and prepare the **ccoctl** binary.

##### Procedure

1. Download the **CredentialsRequest** custom resource (CR) and store it in a directory by running the following command:

```
$ curl --create-dirs -o <credrequests-dir>/controller.yaml
https://raw.githubusercontent.com/openshift/aws-load-balancer-
operator/main/hack/controller/controller-credentials-request.yaml
```

2. Use the **ccoctl** utility to create an AWS IAM role by running the following command:

```
$ ccoctl aws create-iam-roles \
 --name <name> \
 --region=<aws_region> \
 --credentials-requests-dir=<credrequests-dir> \
 --identity-provider-arn <oidc-arn>
```

### Example output

```
2023/09/12 11:38:57 Role arn:aws:iam::777777777777:role/<name>-aws-load-balancer-
operator-aws-load-balancer-controller created 1
2023/09/12 11:38:57 Saved credentials configuration to: /home/user/<credrequests-
dir>/manifests/aws-load-balancer-operator-aws-load-balancer-controller-credentials.yaml
2023/09/12 11:38:58 Updated Role policy for Role <name>-aws-load-balancer-operator-aws-
load-balancer-controller created
```

- 1** Note the Amazon Resource Name (ARN) of an AWS IAM role.

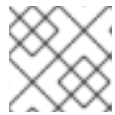

### NOTE

The length of an AWS IAM role name must be less than or equal to 12 characters.

#### 25.4.3.2. Creating an AWS IAM role for the controller by using the AWS CLI

You can use the AWS command line interface to create an AWS IAM role for the AWS Load Balancer Controller. An AWS IAM role is used to interact with subnets and Virtual Private Clouds (VPCs).

#### Prerequisites

- You must have access to the AWS command line interface (**aws**).

#### Procedure

1. Generate a trust policy file using your identity provider by running the following command:

```
$ cat <<EOF > albo-controller-trust-policy.json
{
 "Version": "2012-10-17",
 "Statement": [
 {
 "Effect": "Allow",
 "Principal": {
 "Federated": "arn:aws:iam::777777777777:oidc-provider/<oidc-provider-id>" 1
 }
 }
]
}
```

```

 "Action": "sts:AssumeRoleWithWebIdentity",
 "Condition": {
 "StringEquals": {
 "<oidc-provider-id>.sub": "system:serviceaccount:aws-load-balancer-
operator:aws-load-balancer-controller-cluster" ❷
 }
 }
]
}
EOF

```

❶ Specifies the Amazon Resource Name (ARN) of the identity provider.

❷ Specifies the service account for the AWS Load Balancer Controller.

2. Create an AWS IAM role with the generated trust policy by running the following command:

```
$ aws iam create-role --role-name albo-controller --assume-role-policy-document file://albo-controller-trust-policy.json
```

### Example output

```

ROLE arn:aws:iam::777777777777:role/albo-controller 2023-08-02T12:13:22Z ❶
ASSUMEROLEPOLICYDOCUMENT 2012-10-17
STATEMENT sts:AssumeRoleWithWebIdentity Allow
STRINGEQUALS system:serviceaccount:aws-load-balancer-operator:aws-load-balancer-
controller-cluster
PRINCIPAL arn:aws:iam:777777777777:oidc-provider/<oidc-provider-id>

```

❶ Note the ARN of an AWS IAM role.

3. Download the permission policy for the AWS Load Balancer Controller by running the following command:

```
$ curl -o albo-controller-permission-policy.json
https://raw.githubusercontent.com/openshift/aws-load-balancer-operator/main/assets/iam-policy.json
```

4. Attach the permission policy for the AWS Load Balancer Controller to an AWS IAM role by running the following command:

```
$ aws iam put-role-policy --role-name albo-controller --policy-name perms-policy-albo-controller --policy-document file://albo-controller-permission-policy.json
```

5. Create a YAML file that defines the **AWSLoadBalancerController** object:

### Example `sample-aws-lb-manual-creds.yaml` file:

```

apiVersion: networking.olm.openshift.io/v1
kind: AWSLoadBalancerController ❶
metadata:

```

```

name: cluster 2
spec:
 credentialsRequestConfig:
 stsIAMRoleARN: <role-arn> 3

```

- 1** Defines the **AWSLoadBalancerController** object.
- 2** Defines the AWS Load Balancer Controller name. All related resources use this instance name as a suffix.
- 3** Specifies the ARN role. The **CredentialsRequest** object uses this ARN role to provision the AWS credentials.

#### 25.4.4. Additional resources

- [Configuring the Cloud Credential Operator utility](#)

## 25.5. CREATING AN INSTANCE OF THE AWS LOAD BALANCER CONTROLLER

After installing the AWS Load Balancer Operator, you can create the AWS Load Balancer Controller.

### 25.5.1. Creating the AWS Load Balancer Controller

You can install only a single instance of the **AWSLoadBalancerController** object in a cluster. You can create the AWS Load Balancer Controller by using CLI. The AWS Load Balancer Operator reconciles only the **cluster** named resource.

#### Prerequisites

- You have created the **echoserver** namespace.
- You have access to the OpenShift CLI (**oc**).

#### Procedure

1. Create a YAML file that defines the **AWSLoadBalancerController** object:

#### Example **sample-aws-lb.yaml** file

```

apiVersion: networking.olm.openshift.io/v1
kind: AWSLoadBalancerController 1
metadata:
 name: cluster 2
spec:
 subnetTagging: Auto 3
 additionalResourceTags: 4
 - key: example.org/security-scope
 value: staging
 ingressClass: alb 5
config:

```

```

replicas: 2 6
enabledAddons: 7
 - AWSWAFv2 8

```

- 1** Defines the **AWSLoadBalancerController** object.
- 2** Defines the AWS Load Balancer Controller name. This instance name gets added as a suffix to all related resources.
- 3** Configures the subnet tagging method for the AWS Load Balancer Controller. The following values are valid:
  - **Auto:** The AWS Load Balancer Operator determines the subnets that belong to the cluster and tags them appropriately. The Operator cannot determine the role correctly if the internal subnet tags are not present on internal subnet.
  - **Manual:** You manually tag the subnets that belong to the cluster with the appropriate role tags. Use this option if you installed your cluster on user-provided infrastructure.
- 4** Defines the tags used by the AWS Load Balancer Controller when it provisions AWS resources.
- 5** Defines the ingress class name. The default value is **alb**.
- 6** Specifies the number of replicas of the AWS Load Balancer Controller.
- 7** Specifies annotations as an add-on for the AWS Load Balancer Controller.
- 8** Enables the **alb.ingress.kubernetes.io/wafv2-acl-arn** annotation.

2. Create the **AWSLoadBalancerController** object by running the following command:

```
$ oc create -f sample-aws-lb.yaml
```

3. Create a YAML file that defines the **Deployment** resource:

#### Example `sample-aws-lb.yaml` file

```

apiVersion: apps/v1
kind: Deployment 1
metadata:
 name: <echoserver> 2
 namespace: echoserver
spec:
 selector:
 matchLabels:
 app: echoserver
 replicas: 3 3
 template:
 metadata:
 labels:
 app: echoserver
 spec:
 containers:

```



```

- image: openshift/origin-node
 command:
 - "/bin/socat"
 args:
 - TCP4-LISTEN:8080,reuseaddr,fork
 - EXEC:'/bin/bash -c \'printf \\'HTTP/1.0 200 OK\r\n\r\n\'; sed -e \\'/^r/q\''"
 imagePullPolicy: Always
 name: echoserver
 ports:
 - containerPort: 8080

```

- 1 Defines the deployment resource.
- 2 Specifies the deployment name.
- 3 Specifies the number of replicas of the deployment.

4. Create a YAML file that defines the **Service** resource:

#### Example service-albo.yaml file:

```

apiVersion: v1
kind: Service 1
metadata:
 name: <echoserver> 2
 namespace: echoserver
spec:
 ports:
 - port: 80
 targetPort: 8080
 protocol: TCP
 type: NodePort
 selector:
 app: echoserver

```

- 1 Defines the service resource.
- 2 Specifies the service name.

5. Create a YAML file that defines the **Ingress** resource:

#### Example ingress-albo.yaml file:

```

apiVersion: networking.k8s.io/v1
kind: Ingress
metadata:
 name: <name> 1
 namespace: echoserver
 annotations:
 alb.ingress.kubernetes.io/scheme: internet-facing
 alb.ingress.kubernetes.io/target-type: instance
spec:
 ingressClassName: alb

```

```

rules:
 - http:
 paths:
 - path: /
 pathType: Exact
 backend:
 service:
 name: <echoserver> 2
 port:
 number: 80

```

- 1 Specify a name for the **Ingress** resource.
- 2 Specifies the service name.

## Verification

- Save the status of the **Ingress** resource in the **HOST** variable by running the following command:

```
$ HOST=$(oc get ingress -n echoserver echoserver --template='{{(index .status.loadBalancer.ingress 0).hostname}}')
```

- Verify the status of the **Ingress** resource by running the following command:

```
$ curl $HOST
```

## 25.6. SERVING MULTIPLE INGRESS RESOURCES THROUGH A SINGLE AWS LOAD BALANCER

You can route the traffic to different services that are part of a single domain through a single AWS Load Balancer. Each Ingress resource provides different endpoints of the domain.

### 25.6.1. Creating multiple ingress resources through a single AWS Load Balancer

You can route the traffic to multiple ingress resources through a single AWS Load Balancer by using the CLI.

#### Prerequisites

- You have an access to the OpenShift CLI (**oc**).

#### Procedure

1. Create an **IngressClassParams** resource YAML file, for example, **sample-single-lb-params.yaml**, as follows:

```

apiVersion: elbv2.k8s.aws/v1beta1 1
kind: IngressClassParams
metadata:
 name: single-lb-params 2

```

```
spec:
 group:
 name: single-lb 3
```

- 1 Defines the API group and version of the **IngressClassParams** resource.
- 2 Specifies the **IngressClassParams** resource name.
- 3 Specifies the **IngressGroup** resource name. All of the **Ingress** resources of this class belong to this **IngressGroup**.

2. Create the **IngressClassParams** resource by running the following command:

```
$ oc create -f sample-single-lb-params.yaml
```

3. Create the **IngressClass** resource YAML file, for example, **sample-single-lb-class.yaml**, as follows:

```
apiVersion: networking.k8s.io/v1 1
kind: IngressClass
metadata:
 name: single-lb 2
spec:
 controller: ingress.k8s.aws/alb 3
 parameters:
 apiGroup: elbv2.k8s.aws 4
 kind: IngressClassParams 5
 name: single-lb-params 6
```

- 1 Defines the API group and version of the **IngressClass** resource.
- 2 Specifies the ingress class name.
- 3 Defines the controller name. The **ingress.k8s.aws/alb** value denotes that all ingress resources of this class should be managed by the AWS Load Balancer Controller.
- 4 Defines the API group of the **IngressClassParams** resource.
- 5 Defines the resource type of the **IngressClassParams** resource.
- 6 Defines the **IngressClassParams** resource name.

4. Create the **IngressClass** resource by running the following command:

```
$ oc create -f sample-single-lb-class.yaml
```

5. Create the **AWSLoadBalancerController** resource YAML file, for example, **sample-single-lb.yaml**, as follows:

```
apiVersion: networking.olm.openshift.io/v1
kind: AWSLoadBalancerController
metadata:
 name: cluster
```

```
spec:
 subnetTagging: Auto
 ingressClass: single-lb 1
```

- 1** Defines the name of the **IngressClass** resource.

6. Create the **AWSLoadBalancerController** resource by running the following command:

```
$ oc create -f sample-single-lb.yaml
```

7. Create the **Ingress** resource YAML file, for example, **sample-multiple-ingress.yaml**, as follows:

```
apiVersion: networking.k8s.io/v1
kind: Ingress
metadata:
 name: example-1 1
 annotations:
 alb.ingress.kubernetes.io/scheme: internet-facing 2
 alb.ingress.kubernetes.io/group.order: "1" 3
 alb.ingress.kubernetes.io/target-type: instance 4
spec:
 ingressClassName: single-lb 5
 rules:
 - host: example.com 6
 http:
 paths:
 - path: /blog 7
 pathType: Prefix
 backend:
 service:
 name: example-1 8
 port:
 number: 80 9

apiVersion: networking.k8s.io/v1
kind: Ingress
metadata:
 name: example-2
 annotations:
 alb.ingress.kubernetes.io/scheme: internet-facing
 alb.ingress.kubernetes.io/group.order: "2"
 alb.ingress.kubernetes.io/target-type: instance
spec:
 ingressClassName: single-lb
 rules:
 - host: example.com
 http:
 paths:
 - path: /store
 pathType: Prefix
 backend:
 service:
 name: example-2
```

```

 port:
 number: 80

apiVersion: networking.k8s.io/v1
kind: Ingress
metadata:
 name: example-3
 annotations:
 alb.ingress.kubernetes.io/scheme: internet-facing
 alb.ingress.kubernetes.io/group.order: "3"
 alb.ingress.kubernetes.io/target-type: instance
spec:
 ingressClassName: single-lb
 rules:
 - host: example.com
 http:
 paths:
 - path: /
 pathType: Prefix
 backend:
 service:
 name: example-3
 port:
 number: 80

```

- 1 Specifies the ingress name.
- 2 Indicates the load balancer to provision in the public subnet to access the internet.
- 3 Specifies the order in which the rules from the multiple ingress resources are matched when the request is received at the load balancer.
- 4 Indicates that the load balancer will target OpenShift Container Platform nodes to reach the service.
- 5 Specifies the ingress class that belongs to this ingress.
- 6 Defines a domain name used for request routing.
- 7 Defines the path that must route to the service.
- 8 Defines the service name that serves the endpoint configured in the **Ingress** resource.
- 9 Defines the port on the service that serves the endpoint.

8. Create the **Ingress** resource by running the following command:

```
$ oc create -f sample-multiple-ingress.yaml
```

## 25.7. ADDING TLS TERMINATION

You can add TLS termination on the AWS Load Balancer.

### 25.7.1. Adding TLS termination on the AWS Load Balancer

You can route the traffic for the domain to pods of a service and add TLS termination on the AWS Load Balancer.

## Prerequisites

- You have an access to the OpenShift CLI (**oc**).

## Procedure

- Create a YAML file that defines the **AWSLoadBalancerController** resource:

### Example `add-tls-termination-albc.yaml` file

```
apiVersion: networking.olm.openshift.io/v1
kind: AWSLoadBalancerController
metadata:
 name: cluster
spec:
 subnetTagging: Auto
 ingressClass: tls-termination 1
```

- 1 Defines the ingress class name. If the ingress class is not present in your cluster the AWS Load Balancer Controller creates one. The AWS Load Balancer Controller reconciles the additional ingress class values if **spec.controller** is set to **ingress.k8s.aws/alb**.

- Create a YAML file that defines the **Ingress** resource:

### Example `add-tls-termination-ingress.yaml` file

```
apiVersion: networking.k8s.io/v1
kind: Ingress
metadata:
 name: <example> 1
 annotations:
 alb.ingress.kubernetes.io/scheme: internet-facing 2
 alb.ingress.kubernetes.io/certificate-arn: arn:aws:acm:us-west-2:xxxxx 3
spec:
 ingressClassName: tls-termination 4
 rules:
 - host: <example.com> 5
 http:
 paths:
 - path: /
 pathType: Exact
 backend:
 service:
 name: <example-service> 6
 port:
 number: 80
```

- 1 Specifies the ingress name.

- 2 The controller provisions the load balancer for ingress in a public subnet to access the load balancer over the internet.
- 3 The Amazon Resource Name (ARN) of the certificate that you attach to the load balancer.
- 4 Defines the ingress class name.
- 5 Defines the domain for traffic routing.
- 6 Defines the service for traffic routing.

## 25.8. CONFIGURING CLUSTER-WIDE PROXY

You can configure the cluster-wide proxy in the AWS Load Balancer Operator. After configuring the cluster-wide proxy, Operator Lifecycle Manager (OLM) automatically updates all the deployments of the Operators with the environment variables such as **HTTP\_PROXY**, **HTTPS\_PROXY**, and **NO\_PROXY**. These variables are populated to the managed controller by the AWS Load Balancer Operator.

### 25.8.1. Trusting the certificate authority of the cluster-wide proxy

1. Create the config map to contain the certificate authority (CA) bundle in the **aws-load-balancer-operator** namespace by running the following command:

```
$ oc -n aws-load-balancer-operator create configmap trusted-ca
```

2. To inject the trusted CA bundle into the config map, add the **config.openshift.io/inject-trusted-cabundle=true** label to the config map by running the following command:

```
$ oc -n aws-load-balancer-operator label cm trusted-ca config.openshift.io/inject-trusted-cabundle=true
```

3. Update the AWS Load Balancer Operator subscription to access the config map in the AWS Load Balancer Operator deployment by running the following command:

```
$ oc -n aws-load-balancer-operator patch subscription aws-load-balancer-operator --
type='merge' -p '{"spec":{"config":{"env":
[{"name":"TRUSTED_CA_CONFIGMAP_NAME","value":"trusted-ca"}],"volumes":
[{"name":"trusted-ca","configMap":{"name":"trusted-ca"}],"volumeMounts":[{"name":"trusted-
ca","mountPath":"/etc/pki/tls/certs/albo-tls-ca-bundle.crt","subPath":"ca-bundle.crt"}]}}}'
```

4. After the AWS Load Balancer Operator is deployed, verify that the CA bundle is added to the **aws-load-balancer-operator-controller-manager** deployment by running the following command:

```
$ oc -n aws-load-balancer-operator exec deploy/aws-load-balancer-operator-controller-
manager -c manager -- bash -c "ls -l /etc/pki/tls/certs/albo-tls-ca-bundle.crt; printenv
TRUSTED_CA_CONFIGMAP_NAME"
```

#### Example output

```
-rw-r--r--. 1 root 1000690000 5875 Jan 11 12:25 /etc/pki/tls/certs/albo-tls-ca-bundle.crt
trusted-ca
```

- 
- 5. Optional: Restart deployment of the AWS Load Balancer Operator every time the config map changes by running the following command:

```
$ oc -n aws-load-balancer-operator rollout restart deployment/aws-load-balancer-operator-controller-manager
```

### 25.8.2. Additional resources

- [Certificate injection using Operators](#)



## CHAPTER 26. MULTIPLE NETWORKS

### 26.1. UNDERSTANDING MULTIPLE NETWORKS

In Kubernetes, container networking is delegated to networking plugins that implement the Container Network Interface (CNI).

OpenShift Container Platform uses the Multus CNI plugin to allow chaining of CNI plugins. During cluster installation, you configure your *default* pod network. The default network handles all ordinary network traffic for the cluster. You can define an *additional network* based on the available CNI plugins and attach one or more of these networks to your pods. You can define more than one additional network for your cluster, depending on your needs. This gives you flexibility when you configure pods that deliver network functionality, such as switching or routing.

#### 26.1.1. Usage scenarios for an additional network

You can use an additional network in situations where network isolation is needed, including data plane and control plane separation. Isolating network traffic is useful for the following performance and security reasons:

##### Performance

You can send traffic on two different planes to manage how much traffic is along each plane.

##### Security

You can send sensitive traffic onto a network plane that is managed specifically for security considerations, and you can separate private data that must not be shared between tenants or customers.

All of the pods in the cluster still use the cluster-wide default network to maintain connectivity across the cluster. Every pod has an **eth0** interface that is attached to the cluster-wide pod network. You can view the interfaces for a pod by using the **oc exec -it <pod\_name> -- ip a** command. If you add additional network interfaces that use Multus CNI, they are named **net1**, **net2**, ..., **netN**.

To attach additional network interfaces to a pod, you must create configurations that define how the interfaces are attached. You specify each interface by using a **NetworkAttachmentDefinition** custom resource (CR). A CNI configuration inside each of these CRs defines how that interface is created.

#### 26.1.2. Additional networks in OpenShift Container Platform

OpenShift Container Platform provides the following CNI plugins for creating additional networks in your cluster:

- **bridge**: [Configure a bridge-based additional network](#) to allow pods on the same host to communicate with each other and the host.
- **host-device**: [Configure a host-device additional network](#) to allow pods access to a physical Ethernet network device on the host system.
- **ipvlan**: [Configure an ipvlan-based additional network](#) to allow pods on a host to communicate with other hosts and pods on those hosts, similar to a macvlan-based additional network. Unlike a macvlan-based additional network, each pod shares the same MAC address as the parent physical network interface.
- **vlan**: [Configure a vlan-based additional network](#) to allow VLAN-based network isolation and connectivity for pods.

- **macvlan**: [Configure a macvlan-based additional network](#) to allow pods on a host to communicate with other hosts and pods on those hosts by using a physical network interface. Each pod that is attached to a macvlan-based additional network is provided a unique MAC address.
- **tap**: [Configure a tap-based additional network](#) to create a tap device inside the container namespace. A tap device enables user space programs to send and receive network packets.
- **SR-IOV**: [Configure an SR-IOV based additional network](#) to allow pods to attach to a virtual function (VF) interface on SR-IOV capable hardware on the host system.

## 26.2. CONFIGURING AN ADDITIONAL NETWORK

As a cluster administrator, you can configure an additional network for your cluster. The following network types are supported:

- [Bridge](#)
- [Host device](#)
- [VLAN](#)
- [IPVLAN](#)
- [MACVLAN](#)
- [TAP](#)
- [OVN-Kubernetes](#)

### 26.2.1. Approaches to managing an additional network

You can manage the life cycle of an additional network by two approaches. Each approach is mutually exclusive and you can only use one approach for managing an additional network at a time. For either approach, the additional network is managed by a Container Network Interface (CNI) plugin that you configure.

For an additional network, IP addresses are provisioned through an IP Address Management (IPAM) CNI plugin that you configure as part of the additional network. The IPAM plugin supports a variety of IP address assignment approaches including DHCP and static assignment.

- **Modify the Cluster Network Operator (CNO) configuration:** The CNO automatically creates and manages the **NetworkAttachmentDefinition** object. In addition to managing the object lifecycle the CNO ensures a DHCP is available for an additional network that uses a DHCP assigned IP address.
- **Applying a YAML manifest:** You can manage the additional network directly by creating an **NetworkAttachmentDefinition** object. This approach allows for the chaining of CNI plugins.

**NOTE**

When deploying OpenShift Container Platform nodes with multiple network interfaces on Red Hat OpenStack Platform (RHOSP) with OVN SDN, DNS configuration of the secondary interface might take precedence over the DNS configuration of the primary interface. In this case, remove the DNS nameservers for the subnet id that is attached to the secondary interface:

```
$ openstack subnet set --dns-nameserver 0.0.0.0 <subnet_id>
```

## 26.2.2. Configuration for an additional network attachment

An additional network is configured by using the **NetworkAttachmentDefinition** API in the **k8s.cni.cncf.io** API group.

**IMPORTANT**

Do not store any sensitive information or a secret in the **NetworkAttachmentDefinition** object because this information is accessible by the project administration user.

The configuration for the API is described in the following table:

**Table 26.1. NetworkAttachmentDefinition API fields**

| Field                     | Type          | Description                                       |
|---------------------------|---------------|---------------------------------------------------|
| <b>metadata.name</b>      | <b>string</b> | The name for the additional network.              |
| <b>metadata.namespace</b> | <b>string</b> | The namespace that the object is associated with. |
| <b>spec.config</b>        | <b>string</b> | The CNI plugin configuration in JSON format.      |

### 26.2.2.1. Configuration of an additional network through the Cluster Network Operator

The configuration for an additional network attachment is specified as part of the Cluster Network Operator (CNO) configuration.

The following YAML describes the configuration parameters for managing an additional network with the CNO:

#### Cluster Network Operator configuration

```
apiVersion: operator.openshift.io/v1
kind: Network
metadata:
 name: cluster
spec:
 # ...
 additionalNetworks: 1
 - name: <name> 2
 namespace: <namespace> 3
 rawCNIConfig: |- 4
```

```
{
 ...
}
type: Raw
```

- 1 An array of one or more additional network configurations.
- 2 The name for the additional network attachment that you are creating. The name must be unique within the specified **namespace**.
- 3 The namespace to create the network attachment in. If you do not specify a value, then the **default** namespace is used.
- 4 A CNI plugin configuration in JSON format.

### 26.2.2.2. Configuration of an additional network from a YAML manifest

The configuration for an additional network is specified from a YAML configuration file, such as in the following example:

```
apiVersion: k8s.cni.cncf.io/v1
kind: NetworkAttachmentDefinition
metadata:
 name: <name> 1
spec:
 config: |- 2
 {
 ...
 }
```

- 1 The name for the additional network attachment that you are creating.
- 2 A CNI plugin configuration in JSON format.

### 26.2.3. Configurations for additional network types

The specific configuration fields for additional networks is described in the following sections.

#### 26.2.3.1. Configuration for a bridge additional network

The following object describes the configuration parameters for the bridge CNI plugin:

Table 26.2. Bridge CNI plugin JSON configuration object

| Field             | Type          | Description                                                                                |
|-------------------|---------------|--------------------------------------------------------------------------------------------|
| <b>cniVersion</b> | <b>string</b> | The CNI specification version. The <b>0.3.1</b> value is required.                         |
| <b>name</b>       | <b>string</b> | The value for the <b>name</b> parameter you provided previously for the CNO configuration. |

| Field                      | Type           | Description                                                                                                                                                                                                                                                                                   |
|----------------------------|----------------|-----------------------------------------------------------------------------------------------------------------------------------------------------------------------------------------------------------------------------------------------------------------------------------------------|
| <b>type</b>                | <b>string</b>  | The name of the CNI plugin to configure: <b>bridge</b> .                                                                                                                                                                                                                                      |
| <b>ipam</b>                | <b>object</b>  | The configuration object for the IPAM CNI plugin. The plugin manages IP address assignment for the attachment definition.                                                                                                                                                                     |
| <b>bridge</b>              | <b>string</b>  | Optional: Specify the name of the virtual bridge to use. If the bridge interface does not exist on the host, it is created. The default value is <b>cni0</b> .                                                                                                                                |
| <b>ipMasq</b>              | <b>boolean</b> | Optional: Set to <b>true</b> to enable IP masquerading for traffic that leaves the virtual network. The source IP address for all traffic is rewritten to the bridge's IP address. If the bridge does not have an IP address, this setting has no effect. The default value is <b>false</b> . |
| <b>isGateway</b>           | <b>boolean</b> | Optional: Set to <b>true</b> to assign an IP address to the bridge. The default value is <b>false</b> .                                                                                                                                                                                       |
| <b>isDefaultGateway</b>    | <b>boolean</b> | Optional: Set to <b>true</b> to configure the bridge as the default gateway for the virtual network. The default value is <b>false</b> . If <b>isDefaultGateway</b> is set to <b>true</b> , then <b>isGateway</b> is also set to <b>true</b> automatically.                                   |
| <b>forceAddress</b>        | <b>boolean</b> | Optional: Set to <b>true</b> to allow assignment of a previously assigned IP address to the virtual bridge. When set to <b>false</b> , if an IPv4 address or an IPv6 address from overlapping subsets is assigned to the virtual bridge, an error occurs. The default value is <b>false</b> . |
| <b>hairpinMode</b>         | <b>boolean</b> | Optional: Set to <b>true</b> to allow the virtual bridge to send an Ethernet frame back through the virtual port it was received on. This mode is also known as <i>reflective relay</i> . The default value is <b>false</b> .                                                                 |
| <b>promiscMode</b>         | <b>boolean</b> | Optional: Set to <b>true</b> to enable promiscuous mode on the bridge. The default value is <b>false</b> .                                                                                                                                                                                    |
| <b>vlan</b>                | <b>string</b>  | Optional: Specify a virtual LAN (VLAN) tag as an integer value. By default, no VLAN tag is assigned.                                                                                                                                                                                          |
| <b>preserveDefaultVlan</b> | <b>string</b>  | Optional: Indicates whether the default vlan must be preserved on the <b>veth</b> end connected to the bridge. Defaults to true.                                                                                                                                                              |
| <b>vlanTrunk</b>           | <b>list</b>    | Optional: Assign a VLAN trunk tag. The default value is <b>none</b> .                                                                                                                                                                                                                         |
| <b>mtu</b>                 | <b>string</b>  | Optional: Set the maximum transmission unit (MTU) to the specified value. The default value is automatically set by the kernel.                                                                                                                                                               |

| Field              | Type           | Description                                                                                                                                                     |
|--------------------|----------------|-----------------------------------------------------------------------------------------------------------------------------------------------------------------|
| <b>enabledad</b>   | <b>boolean</b> | Optional: Enables duplicate address detection for the container side <b>veth</b> . The default value is <b>false</b> .                                          |
| <b>macspoofchk</b> | <b>boolean</b> | Optional: Enables mac spoof check, limiting the traffic originating from the container to the mac address of the interface. The default value is <b>false</b> . |

**NOTE**

The VLAN parameter configures the VLAN tag on the host end of the **veth** and also enables the **vlan\_filtering** feature on the bridge interface.

**NOTE**

To configure uplink for a L2 network you need to allow the vlan on the uplink interface by using the following command:

```
$ bridge vlan add vid VLAN_ID dev DEV
```

### 26.2.3.1.1. bridge configuration example

The following example configures an additional network named **bridge-net**:

```
{
 "cniVersion": "0.3.1",
 "name": "bridge-net",
 "type": "bridge",
 "isGateway": true,
 "vlan": 2,
 "ipam": {
 "type": "dhcp"
 }
}
```

### 26.2.3.2. Configuration for a host device additional network

**NOTE**

Specify your network device by setting only one of the following parameters: **device**, **hwaddr**, **kernelpath**, or **pciBusID**.

The following object describes the configuration parameters for the host-device CNI plugin:

**Table 26.3. Host device CNI plugin JSON configuration object**

| Field             | Type          | Description                                                                                   |
|-------------------|---------------|-----------------------------------------------------------------------------------------------|
| <b>cniVersion</b> | <b>string</b> | The CNI specification version. The <b>0.3.1</b> value is required.                            |
| <b>name</b>       | <b>string</b> | The value for the <b>name</b> parameter you provided previously for the CNO configuration.    |
| <b>type</b>       | <b>string</b> | The name of the CNI plugin to configure: <b>host-device</b> .                                 |
| <b>device</b>     | <b>string</b> | Optional: The name of the device, such as <b>eth0</b> .                                       |
| <b>hwaddr</b>     | <b>string</b> | Optional: The device hardware MAC address.                                                    |
| <b>kernelpath</b> | <b>string</b> | Optional: The Linux kernel device path, such as <b>/sys/devices/pci0000:00/0000:00:1f.6</b> . |
| <b>pciBusID</b>   | <b>string</b> | Optional: The PCI address of the network device, such as <b>0000:00:1f.6</b> .                |

#### 26.2.3.2.1. host-device configuration example

The following example configures an additional network named **hostdev-net**:

```
{
 "cniVersion": "0.3.1",
 "name": "hostdev-net",
 "type": "host-device",
 "device": "eth1"
}
```

#### 26.2.3.3. Configuration for an VLAN additional network

The following object describes the configuration parameters for the VLAN CNI plugin:

Table 26.4. VLAN CNI plugin JSON configuration object

| Field             | Type          | Description                                                                                                                                                |
|-------------------|---------------|------------------------------------------------------------------------------------------------------------------------------------------------------------|
| <b>cniVersion</b> | <b>string</b> | The CNI specification version. The <b>0.3.1</b> value is required.                                                                                         |
| <b>name</b>       | <b>string</b> | The value for the <b>name</b> parameter you provided previously for the CNO configuration.                                                                 |
| <b>type</b>       | <b>string</b> | The name of the CNI plugin to configure: <b>vlan</b> .                                                                                                     |
| <b>master</b>     | <b>string</b> | The Ethernet interface to associate with the network attachment. If a <b>master</b> is not specified, the interface for the default network route is used. |

| Field                  | Type           | Description                                                                                                                                                                                                      |
|------------------------|----------------|------------------------------------------------------------------------------------------------------------------------------------------------------------------------------------------------------------------|
| <b>vlanId</b>          | <b>integer</b> | Set the id of the vlan.                                                                                                                                                                                          |
| <b>ipam</b>            | <b>object</b>  | The configuration object for the IPAM CNI plugin. The plugin manages IP address assignment for the attachment definition.                                                                                        |
| <b>mtu</b>             | <b>integer</b> | Optional: Set the maximum transmission unit (MTU) to the specified value. The default value is automatically set by the kernel.                                                                                  |
| <b>dns</b>             | <b>integer</b> | Optional: DNS information to return, for example, a priority-ordered list of DNS nameservers.                                                                                                                    |
| <b>linkInContainer</b> | <b>boolean</b> | Optional: Specifies whether the master interface is in the container network namespace or the main network namespace. Set the value to <b>true</b> to request the use of a container namespace master interface. |

#### 26.2.3.3.1. vlan configuration example

The following example configures an additional network named **vlan-net**:

```
{
 "name": "vlan-net",
 "cniVersion": "0.3.1",
 "type": "vlan",
 "master": "eth0",
 "mtu": 1500,
 "vlanId": 5,
 "linkInContainer": false,
 "ipam": {
 "type": "host-local",
 "subnet": "10.1.1.0/24"
 },
 "dns": {
 "nameservers": ["10.1.1.1", "8.8.8.8"]
 }
}
```

#### 26.2.3.4. Configuration for an IPVLAN additional network

The following object describes the configuration parameters for the IPVLAN CNI plugin:

Table 26.5. IPVLAN CNI plugin JSON configuration object

| Field             | Type          | Description                                                        |
|-------------------|---------------|--------------------------------------------------------------------|
| <b>cniVersion</b> | <b>string</b> | The CNI specification version. The <b>0.3.1</b> value is required. |



| Field                  | Type           | Description                                                                                                                                                                                                      |
|------------------------|----------------|------------------------------------------------------------------------------------------------------------------------------------------------------------------------------------------------------------------|
| <b>name</b>            | <b>string</b>  | The value for the <b>name</b> parameter you provided previously for the CNO configuration.                                                                                                                       |
| <b>type</b>            | <b>string</b>  | The name of the CNI plugin to configure: <b>ipvlan</b> .                                                                                                                                                         |
| <b>ipam</b>            | <b>object</b>  | The configuration object for the IPAM CNI plugin. The plugin manages IP address assignment for the attachment definition. This is required unless the plugin is chained.                                         |
| <b>mode</b>            | <b>string</b>  | Optional: The operating mode for the virtual network. The value must be <b>I2</b> , <b>I3</b> , or <b>I3s</b> . The default value is <b>I2</b> .                                                                 |
| <b>master</b>          | <b>string</b>  | Optional: The Ethernet interface to associate with the network attachment. If a <b>master</b> is not specified, the interface for the default network route is used.                                             |
| <b>mtu</b>             | <b>integer</b> | Optional: Set the maximum transmission unit (MTU) to the specified value. The default value is automatically set by the kernel.                                                                                  |
| <b>linkInContainer</b> | <b>boolean</b> | Optional: Specifies whether the master interface is in the container network namespace or the main network namespace. Set the value to <b>true</b> to request the use of a container namespace master interface. |



## NOTE

- The **ipvlan** object does not allow virtual interfaces to communicate with the **master** interface. Therefore the container will not be able to reach the host by using the **ipvlan** interface. Be sure that the container joins a network that provides connectivity to the host, such as a network supporting the Precision Time Protocol (**PTP**).
- A single **master** interface cannot simultaneously be configured to use both **macvlan** and **ipvlan**.
- For IP allocation schemes that cannot be interface agnostic, the **ipvlan** plugin can be chained with an earlier plugin that handles this logic. If the **master** is omitted, then the previous result must contain a single interface name for the **ipvlan** plugin to enslave. If **ipam** is omitted, then the previous result is used to configure the **ipvlan** interface.

### 26.2.3.4.1. ipvlan configuration example

The following example configures an additional network named **ipvlan-net**:

```
{
 "cniVersion": "0.3.1",
```

```

"name": "ipvlan-net",
"type": "ipvlan",
"master": "eth1",
"linkInContainer": false,
"mode": "I3",
"ipam": {
 "type": "static",
 "addresses": [
 {
 "address": "192.168.10.10/24"
 }
]
}
}
}

```

### 26.2.3.5. Configuration for a MACVLAN additional network

The following object describes the configuration parameters for the macvlan CNI plugin:

Table 26.6. MACVLAN CNI plugin JSON configuration object

| Field                  | Type           | Description                                                                                                                                                                                                         |
|------------------------|----------------|---------------------------------------------------------------------------------------------------------------------------------------------------------------------------------------------------------------------|
| <b>cniVersion</b>      | <b>string</b>  | The CNI specification version. The <b>0.3.1</b> value is required.                                                                                                                                                  |
| <b>name</b>            | <b>string</b>  | The value for the <b>name</b> parameter you provided previously for the CNO configuration.                                                                                                                          |
| <b>type</b>            | <b>string</b>  | The name of the CNI plugin to configure: <b>macvlan</b> .                                                                                                                                                           |
| <b>ipam</b>            | <b>object</b>  | The configuration object for the IPAM CNI plugin. The plugin manages IP address assignment for the attachment definition.                                                                                           |
| <b>mode</b>            | <b>string</b>  | Optional: Configures traffic visibility on the virtual network. Must be either <b>bridge</b> , <b>passthru</b> , <b>private</b> , or <b>vepa</b> . If a value is not provided, the default value is <b>bridge</b> . |
| <b>master</b>          | <b>string</b>  | Optional: The host network interface to associate with the newly created macvlan interface. If a value is not specified, then the default route interface is used.                                                  |
| <b>mtu</b>             | <b>string</b>  | Optional: The maximum transmission unit (MTU) to the specified value. The default value is automatically set by the kernel.                                                                                         |
| <b>linkInContainer</b> | <b>boolean</b> | Optional: Specifies whether the master interface is in the container network namespace or the main network namespace. Set the value to <b>true</b> to request the use of a container namespace master interface.    |

**NOTE**

If you specify the **master** key for the plugin configuration, use a different physical network interface than the one that is associated with your primary network plugin to avoid possible conflicts.

**26.2.3.5.1. macvlan configuration example**

The following example configures an additional network named **macvlan-net**:

```
{
 "cniVersion": "0.3.1",
 "name": "macvlan-net",
 "type": "macvlan",
 "master": "eth1",
 "linkInContainer": false,
 "mode": "bridge",
 "ipam": {
 "type": "dhcp"
 }
}
```

**26.2.3.6. Configuration for a TAP additional network**

The following object describes the configuration parameters for the TAP CNI plugin:

**Table 26.7. TAP CNI plugin JSON configuration object**

| Field                 | Type           | Description                                                                                                                     |
|-----------------------|----------------|---------------------------------------------------------------------------------------------------------------------------------|
| <b>cniVersion</b>     | <b>string</b>  | The CNI specification version. The <b>0.3.1</b> value is required.                                                              |
| <b>name</b>           | <b>string</b>  | The value for the <b>name</b> parameter you provided previously for the CNO configuration.                                      |
| <b>type</b>           | <b>string</b>  | The name of the CNI plugin to configure: <b>tap</b> .                                                                           |
| <b>mac</b>            | <b>string</b>  | Optional: Request the specified MAC address for the interface.                                                                  |
| <b>mtu</b>            | <b>integer</b> | Optional: Set the maximum transmission unit (MTU) to the specified value. The default value is automatically set by the kernel. |
| <b>selinuxcontext</b> | <b>string</b>  | Optional: The SELinux context to associate with the tap device.                                                                 |



**NOTE**

The value **system\_u:system\_r:container\_t:s0** is required for OpenShift Container Platform.

| Field             | Type           | Description                                                           |
|-------------------|----------------|-----------------------------------------------------------------------|
| <b>multiQueue</b> | <b>boolean</b> | Optional: Set to <b>true</b> to enable multi-queue.                   |
| <b>owner</b>      | <b>integer</b> | Optional: The user owning the tap device.                             |
| <b>group</b>      | <b>integer</b> | Optional: The group owning the tap device.                            |
| <b>bridge</b>     | <b>string</b>  | Optional: Set the tap device as a port of an already existing bridge. |

### 26.2.3.6.1. Tap configuration example

The following example configures an additional network named **mynet**:

```
{
 "name": "mynet",
 "cniVersion": "0.3.1",
 "type": "tap",
 "mac": "00:11:22:33:44:55",
 "mtu": 1500,
 "selinuxcontext": "system_u:system_r:container_t:s0",
 "multiQueue": true,
 "owner": 0,
 "group": 0
 "bridge": "br1"
}
```

### 26.2.3.6.2. Setting SELinux boolean for the TAP CNI plugin

To create the tap device with the **container\_t** SELinux context, enable the **container\_use\_devices** boolean on the host by using the Machine Config Operator (MCO).

#### Prerequisites

- You have installed the OpenShift CLI (**oc**).

#### Procedure

- Create a new YAML file named, such as **setsebool-container-use-devices.yaml**, with the following details:

```
apiVersion: machineconfiguration.openshift.io/v1
kind: MachineConfig
metadata:
 labels:
 machineconfiguration.openshift.io/role: worker
 name: 99-worker-setsebool
spec:
 config:
 ignition:
 version: 3.2.0
```

```

systemd:
units:
- enabled: true
name: setsebool.service
contents: |
[Unit]
Description=Set SELinux boolean for the TAP CNI plugin
Before=kubelet.service

[Service]
Type=oneshot
ExecStart=/usr/sbin/setsebool container_use_devices=on
RemainAfterExit=true

[Install]
WantedBy=multi-user.target graphical.target

```

2. Create the new **MachineConfig** object by running the following command:

```
$ oc apply -f setsebool-container-use-devices.yaml
```

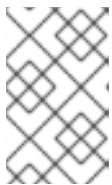

#### NOTE

Applying any changes to the **MachineConfig** object causes all affected nodes to gracefully reboot after the change is applied. This update can take some time to be applied.

3. Verify the change is applied by running the following command:

```
$ oc get machineconfigpools
```

#### Expected output

| NAME                 | CONFIG                                           | UPDATED             | UPDATING | DEGRADED |
|----------------------|--------------------------------------------------|---------------------|----------|----------|
| MACHINECOUNT         | READYMACHINECOUNT                                | UPDATEDMACHINECOUNT |          |          |
| DEGRADEDMACHINECOUNT | AGE                                              |                     |          |          |
| master               | rendered-master-e5e0c8e8be9194e7c5a882e047379cfa | True                | False    |          |
| False                | 3 3 3 0                                          | 7d2h                |          |          |
| worker               | rendered-worker-d6c9ca107fba6cd76cdcbfcedcafa0f2 | True                | False    | False    |
| 3                    | 3 3 0 7d                                         |                     |          |          |

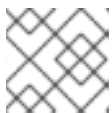

#### NOTE

All nodes should be in the updated and ready state.

#### Additional resources

- For more information about enabling an SELinux boolean on a node, see [Setting SELinux booleans](#)

#### 26.2.3.7. Configuration for an OVN-Kubernetes additional network

The Red Hat OpenShift Networking OVN-Kubernetes network plugin allows the configuration of secondary network interfaces for pods. To configure secondary network interfaces, you must define the configurations in the **NetworkAttachmentDefinition** custom resource (CR).

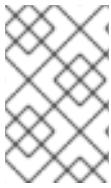

#### NOTE

Pod and multi-network policy creation might remain in a pending state until the OVN-Kubernetes control plane agent in the nodes processes the associated **network-attachment-definition** CR.

You can configure an OVN-Kubernetes additional network in either *layer 2* or *localnet* topologies.

- A layer 2 topology supports east-west cluster traffic, but does not allow access to the underlying physical network.
- A localnet topology allows connections to the physical network, but requires additional configuration of the underlying Open vSwitch (OVS) bridge on cluster nodes.

The following sections provide example configurations for each of the topologies that OVN-Kubernetes currently allows for secondary networks.



#### NOTE

Networks names must be unique. For example, creating multiple **NetworkAttachmentDefinition** CRs with different configurations that reference the same network is unsupported.

#### 26.2.3.7.1. Supported platforms for OVN-Kubernetes additional network

You can use an OVN-Kubernetes additional network with the following supported platforms:

- Bare metal
- IBM Power®
- IBM Z®
- IBM® LinuxONE
- VMware vSphere
- Red Hat OpenStack Platform (RHOSP)

#### 26.2.3.7.2. OVN-Kubernetes network plugin JSON configuration table

The following table describes the configuration parameters for the OVN-Kubernetes CNI network plugin:

**Table 26.8. OVN-Kubernetes network plugin JSON configuration table**

| Field             | Type          | Description                                                         |
|-------------------|---------------|---------------------------------------------------------------------|
| <b>cniVersion</b> | <b>string</b> | The CNI specification version. The required value is <b>0.3.1</b> . |

| Field                   | Type           | Description                                                                                                                                                                                                                                                                                                                                                                                                                                                                                                                                                                                                |
|-------------------------|----------------|------------------------------------------------------------------------------------------------------------------------------------------------------------------------------------------------------------------------------------------------------------------------------------------------------------------------------------------------------------------------------------------------------------------------------------------------------------------------------------------------------------------------------------------------------------------------------------------------------------|
| <b>name</b>             | <b>string</b>  | The name of the network. These networks are not namespaced. For example, you can have a network named <b>I2-network</b> referenced from two different <b>NetworkAttachmentDefinitions</b> that exist on two different namespaces. This ensures that pods making use of the <b>NetworkAttachmentDefinition</b> on their own different namespaces can communicate over the same secondary network. However, those two different <b>NetworkAttachmentDefinitions</b> must also share the same network specific parameters such as <b>topology</b> , <b>subnets</b> , <b>mtu</b> , and <b>excludeSubnets</b> . |
| <b>type</b>             | <b>string</b>  | The name of the CNI plugin to configure. This value must be set to <b>ovn-k8s-cni-overlay</b> .                                                                                                                                                                                                                                                                                                                                                                                                                                                                                                            |
| <b>topology</b>         | <b>string</b>  | The topological configuration for the network. Must be one of <b>layer2</b> or <b>localnet</b> .                                                                                                                                                                                                                                                                                                                                                                                                                                                                                                           |
| <b>subnets</b>          | <b>string</b>  | The subnet to use for the network across the cluster.<br><br>For " <b>topology</b> ":" <b>layer2</b> " deployments, IPv6 ( <b>2001:DBB::/64</b> ) and dual-stack ( <b>192.168.100.0/24,2001:DBB::/64</b> ) subnets are supported.<br><br>When omitted, the logical switch implementing the network only provides layer 2 communication, and users must configure IP addresses for the pods. Port security only prevents MAC spoofing.                                                                                                                                                                      |
| <b>mtu</b>              | <b>string</b>  | The maximum transmission unit (MTU). The default value, <b>1300</b> , is automatically set by the kernel.                                                                                                                                                                                                                                                                                                                                                                                                                                                                                                  |
| <b>netAttachDefName</b> | <b>string</b>  | The metadata <b>namespace</b> and <b>name</b> of the network attachment definition object where this configuration is included. For example, if this configuration is defined in a <b>NetworkAttachmentDefinition</b> in namespace <b>ns1</b> named <b>I2-network</b> , this should be set to <b>ns1/I2-network</b> .                                                                                                                                                                                                                                                                                      |
| <b>excludeSubnets</b>   | <b>string</b>  | A comma-separated list of CIDRs and IP addresses. IP addresses are removed from the assignable IP address pool and are never passed to the pods.                                                                                                                                                                                                                                                                                                                                                                                                                                                           |
| <b>vlanID</b>           | <b>integer</b> | If topology is set to <b>localnet</b> , the specified VLAN tag is assigned to traffic from this additional network. The default is to not assign a VLAN tag.                                                                                                                                                                                                                                                                                                                                                                                                                                               |

### 26.2.3.7.3. Compatibility with multi-network policy

The multi-network policy API, which is provided by the **MultiNetworkPolicy** custom resource definition (CRD) in the **k8s.cni.cncf.io** API group, is compatible with an OVN-Kubernetes secondary network. When defining a network policy, the network policy rules that can be used depend on whether the OVN-Kubernetes secondary network defines the **subnets** field. Refer to the following table for details:

**Table 26.9. Supported multi-network policy selectors based on subnets CNI configuration**

| subnets field specified | Allowed multi-network policy selectors                                                                                        |
|-------------------------|-------------------------------------------------------------------------------------------------------------------------------|
| Yes                     | <ul style="list-style-type: none"> <li>• <b>podSelector</b> and <b>namespaceSelector</b></li> <li>• <b>ipBlock</b></li> </ul> |
| No                      | <ul style="list-style-type: none"> <li>• <b>ipBlock</b></li> </ul>                                                            |

For example, the following multi-network policy is valid only if the **subnets** field is defined in the additional network CNI configuration for the additional network named **blue2**:

#### Example multi-network policy that uses a pod selector

```

apiVersion: k8s.cni.cncf.io/v1beta1
kind: MultiNetworkPolicy
metadata:
 name: allow-same-namespace
 annotations:
 k8s.v1.cni.cncf.io/policy-for: blue2
spec:
 podSelector:
 ingress:
 - from:
 - podSelector: {}

```

The following example uses the **ipBlock** network policy selector, which is always valid for an OVN-Kubernetes additional network:

#### Example multi-network policy that uses an IP block selector

```

apiVersion: k8s.cni.cncf.io/v1beta1
kind: MultiNetworkPolicy
metadata:
 name: ingress-ipblock
 annotations:
 k8s.v1.cni.cncf.io/policy-for: default/flatl2net
spec:
 podSelector:
 matchLabels:
 name: access-control
 policyTypes:
 - Ingress
 ingress:

```



- from:
- ipBlock:
  - cidr: 10.200.0.0/30

#### 26.2.3.7.4. Configuration for a layer 2 switched topology

The switched (layer 2) topology networks interconnect the workloads through a cluster-wide logical switch. This configuration can be used for IPv6 and dual-stack deployments.



#### NOTE

Layer 2 switched topology networks only allow for the transfer of data packets between pods within a cluster.

The following JSON example configures a switched secondary network:

```
{
 "cniVersion": "0.3.1",
 "name": "l2-network",
 "type": "ovn-k8s-cni-overlay",
 "topology": "layer2",
 "subnets": "10.100.200.0/24",
 "mtu": 1300,
 "netAttachDefName": "ns1/l2-network",
 "excludeSubnets": "10.100.200.0/29"
}
```

#### 26.2.3.7.5. Configuration for a localnet topology

The switched (localnet) topology interconnects the workloads through a cluster-wide logical switch to a physical network.

##### 26.2.3.7.5.1. Prerequisites for configuring OVN-Kubernetes additional network

- The NMState Operator is installed. For more information, see [About the Kubernetes NMState Operator](#).

##### 26.2.3.7.5.2. Configuration for an OVN-Kubernetes additional network mapping

You must map an additional network to the OVN bridge to use it as an OVN-Kubernetes additional network. Bridge mappings allow network traffic to reach the physical network. A bridge mapping associates a physical network name, also known as an interface label, to a bridge created with Open vSwitch (OVS).

You can create an **NodeNetworkConfigurationPolicy** object, part of the **nmstate.io/v1** API group, to declaratively create the mapping. This API is provided by the NMState Operator. By using this API you can apply the bridge mapping to nodes that match your specified **nodeSelector** expression, such as **node-role.kubernetes.io/worker: "**

When attaching an additional network, you can either use the existing **br-ex** bridge or create a new bridge. Which approach to use depends on your specific network infrastructure.

- If your nodes include only a single network interface, you must use the existing bridge. This network interface is owned and managed by OVN-Kubernetes and you must not remove it from

the **br-ex** bridge or alter the interface configuration. If you remove or alter the network interface, your cluster network will stop working correctly.

- If your nodes include several network interfaces, you can attach a different network interface to a new bridge, and use that for your additional network. This approach provides for traffic isolation from your primary cluster network.

The **localnet1** network is mapped to the **br-ex** bridge in the following example:

### Example mapping for sharing a bridge

```
apiVersion: nmstate.io/v1
kind: NodeNetworkConfigurationPolicy
metadata:
 name: mapping 1
spec:
 nodeSelector:
 node-role.kubernetes.io/worker: " 2
desiredState:
 ovn:
 bridge-mappings:
 - localnet: localnet1 3
 bridge: br-ex 4
 state: present 5
```

- 1 The name for the configuration object.
- 2 A node selector that specifies the nodes to apply the node network configuration policy to.
- 3 The name for the additional network from which traffic is forwarded to the OVS bridge. This additional network must match the name of the **spec.config.name** field of the **NetworkAttachmentDefinition** object that defines the OVN-Kubernetes additional network.
- 4 The name of the OVS bridge on the node. This value is required only if you specify **state: present**.
- 5 The state for the mapping. Must be either **present** to add the bridge or **absent** to remove the bridge. The default value is **present**.

In the following example, the **localnet2** network interface is attached to the **ovs-br1** bridge. Through this attachment, the network interface is available to the OVN-Kubernetes network plugin as an additional network.

### Example mapping for nodes with multiple interfaces

```
apiVersion: nmstate.io/v1
kind: NodeNetworkConfigurationPolicy
metadata:
 name: ovs-br1-multiple-networks 1
spec:
 nodeSelector:
 node-role.kubernetes.io/worker: " 2
desiredState:
 interfaces:
 - name: ovs-br1 3
```

```

description: |-
 A dedicated OVS bridge with eth1 as a port
 allowing all VLANs and untagged traffic
type: ovs-bridge
state: up
bridge:
 options:
 stp: true
 port:
 - name: eth1 ④
ovn:
 bridge-mappings:
 - localnet: localnet2 ⑤
 bridge: ovs-br1 ⑥
 state: present ⑦

```

- ① The name for the configuration object.
- ② A node selector that specifies the nodes to apply the node network configuration policy to.
- ③ A new OVS bridge, separate from the default bridge used by OVN-Kubernetes for all cluster traffic.
- ④ A network device on the host system to associate with this new OVS bridge.
- ⑤ The name for the additional network from which traffic is forwarded to the OVS bridge. This additional network must match the name of the **spec.config.name** field of the **NetworkAttachmentDefinition** object that defines the OVN-Kubernetes additional network.
- ⑥ The name of the OVS bridge on the node. This value is required only if you specify **state: present**.
- ⑦ The state for the mapping. Must be either **present** to add the bridge or **absent** to remove the bridge. The default value is **present**.

This declarative approach is recommended because the NMState Operator applies additional network configuration to all nodes specified by the node selector automatically and transparently.

The following JSON example configures a localnet secondary network:

```

{
 "cniVersion": "0.3.1",
 "name": "ns1-localnet-network",
 "type": "ovn-k8s-cni-overlay",
 "topology": "localnet",
 "subnets": "202.10.130.112/28",
 "vlanID": 33,
 "mtu": 1500,
 "netAttachDefName": "ns1/localnet-network"
 "excludeSubnets": "10.100.200.0/29"
}

```

#### 26.2.3.7.6. Configuring pods for additional networks

You must specify the secondary network attachments through the **k8s.v1.cni.cncf.io/networks** annotation.

The following example provisions a pod with two secondary attachments, one for each of the attachment configurations presented in this guide.

```
apiVersion: v1
kind: Pod
metadata:
 annotations:
 k8s.v1.cni.cncf.io/networks: l2-network
 name: tinypod
 namespace: ns1
spec:
 containers:
 - args:
 - pause
 image: k8s.gcr.io/e2e-test-images/agnhost:2.36
 imagePullPolicy: IfNotPresent
 name: agnhost-container
```

#### 26.2.3.7.7. Configuring pods with a static IP address

The following example provisions a pod with a static IP address.

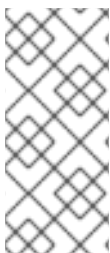

#### NOTE

- You can only specify the IP address for a pod's secondary network attachment for layer 2 attachments.
- Specifying a static IP address for the pod is only possible when the attachment configuration does not feature subnets.

```
apiVersion: v1
kind: Pod
metadata:
 annotations:
 k8s.v1.cni.cncf.io/networks: '[
 {
 "name": "l2-network", 1
 "mac": "02:03:04:05:06:07", 2
 "interface": "myiface1", 3
 "ips": [
 "192.0.2.20/24"
] 4
 }
]'
```

```
name: tinypod
namespace: ns1
spec:
 containers:
 - args:
 - pause
```

```
image: k8s.gcr.io/e2e-test-images/agnhost:2.36
imagePullPolicy: IfNotPresent
name: agnhost-container
```

- 1 The name of the network. This value must be unique across all **NetworkAttachmentDefinitions**.
- 2 The MAC address to be assigned for the interface.
- 3 The name of the network interface to be created for the pod.
- 4 The IP addresses to be assigned to the network interface.

### 26.2.4. Configuration of IP address assignment for an additional network

The IP address management (IPAM) Container Network Interface (CNI) plugin provides IP addresses for other CNI plugins.

You can use the following IP address assignment types:

- Static assignment.
- Dynamic assignment through a DHCP server. The DHCP server you specify must be reachable from the additional network.
- Dynamic assignment through the Whereabouts IPAM CNI plugin.

#### 26.2.4.1. Static IP address assignment configuration

The following table describes the configuration for static IP address assignment:

**Table 26.10. ipam static configuration object**

| Field            | Type          | Description                                                                                                                    |
|------------------|---------------|--------------------------------------------------------------------------------------------------------------------------------|
| <b>type</b>      | <b>string</b> | The IPAM address type. The value <b>static</b> is required.                                                                    |
| <b>addresses</b> | <b>array</b>  | An array of objects specifying IP addresses to assign to the virtual interface. Both IPv4 and IPv6 IP addresses are supported. |
| <b>routes</b>    | <b>array</b>  | An array of objects specifying routes to configure inside the pod.                                                             |
| <b>dns</b>       | <b>array</b>  | Optional: An array of objects specifying the DNS configuration.                                                                |

The **addresses** array requires objects with the following fields:

**Table 26.11. ipam.addresses[] array**

| Field | Type | Description |
|-------|------|-------------|
|-------|------|-------------|

| Field          | Type          | Description                                                                                                                                                                                                                  |
|----------------|---------------|------------------------------------------------------------------------------------------------------------------------------------------------------------------------------------------------------------------------------|
| <b>address</b> | <b>string</b> | An IP address and network prefix that you specify. For example, if you specify <b>10.10.21.10/24</b> , then the additional network is assigned an IP address of <b>10.10.21.10</b> and the netmask is <b>255.255.255.0</b> . |
| <b>gateway</b> | <b>string</b> | The default gateway to route egress network traffic to.                                                                                                                                                                      |

Table 26.12. `ipam.routes[]` array

| Field      | Type          | Description                                                                                                    |
|------------|---------------|----------------------------------------------------------------------------------------------------------------|
| <b>dst</b> | <b>string</b> | The IP address range in CIDR format, such as <b>192.168.17.0/24</b> or <b>0.0.0.0/0</b> for the default route. |
| <b>gw</b>  | <b>string</b> | The gateway where network traffic is routed.                                                                   |

Table 26.13. `ipam.dns` object

| Field              | Type         | Description                                                                                                                                                                                        |
|--------------------|--------------|----------------------------------------------------------------------------------------------------------------------------------------------------------------------------------------------------|
| <b>nameservers</b> | <b>array</b> | An array of one or more IP addresses for to send DNS queries to.                                                                                                                                   |
| <b>domain</b>      | <b>array</b> | The default domain to append to a hostname. For example, if the domain is set to <b>example.com</b> , a DNS lookup query for <b>example-host</b> is rewritten as <b>example-host.example.com</b> . |
| <b>search</b>      | <b>array</b> | An array of domain names to append to an unqualified hostname, such as <b>example-host</b> , during a DNS lookup query.                                                                            |

### Static IP address assignment configuration example

```
{
 "ipam": {
 "type": "static",
 "addresses": [
 {
 "address": "191.168.1.7/24"
 }
]
 }
}
```

#### 26.2.4.2. Dynamic IP address (DHCP) assignment configuration

The following JSON describes the configuration for dynamic IP address address assignment with DHCP.

## RENEWAL OF DHCP LEASES

A pod obtains its original DHCP lease when it is created. The lease must be periodically renewed by a minimal DHCP server deployment running on the cluster.

To trigger the deployment of the DHCP server, you must create a shim network attachment by editing the Cluster Network Operator configuration, as in the following example:

### Example shim network attachment definition

```
apiVersion: operator.openshift.io/v1
kind: Network
metadata:
 name: cluster
spec:
 additionalNetworks:
 - name: dhcp-shim
 namespace: default
 type: Raw
 rawCNIConfig: |-
 {
 "name": "dhcp-shim",
 "cniVersion": "0.3.1",
 "type": "bridge",
 "ipam": {
 "type": "dhcp"
 }
 }
...
```

Table 26.14. `ipam` DHCP configuration object

| Field             | Type                | Description                                               |
|-------------------|---------------------|-----------------------------------------------------------|
| <code>type</code> | <code>string</code> | The IPAM address type. The value <b>dhcp</b> is required. |

### Dynamic IP address (DHCP) assignment configuration example

```
{
 "ipam": {
 "type": "dhcp"
 }
}
```

#### 26.2.4.3. Dynamic IP address assignment configuration with Whereabouts

The Whereabouts CNI plugin allows the dynamic assignment of an IP address to an additional network without the use of a DHCP server.

The following table describes the configuration for dynamic IP address assignment with Whereabouts:

Table 26.15. `ipam` whereabouts configuration object

| Field          | Type          | Description                                                                                                                                |
|----------------|---------------|--------------------------------------------------------------------------------------------------------------------------------------------|
| <b>type</b>    | <b>string</b> | The IPAM address type. The value <b>whereabouts</b> is required.                                                                           |
| <b>range</b>   | <b>string</b> | An IP address and range in CIDR notation. IP addresses are assigned from within this range of addresses.                                   |
| <b>exclude</b> | <b>array</b>  | Optional: A list of zero or more IP addresses and ranges in CIDR notation. IP addresses within an excluded address range are not assigned. |

### Dynamic IP address assignment configuration example that uses Whereabouts

```
{
 "ipam": {
 "type": "whereabouts",
 "range": "192.0.2.192/27",
 "exclude": [
 "192.0.2.192/30",
 "192.0.2.196/32"
]
 }
}
```

#### 26.2.4.4. Creating a whereabouts-reconciler daemon set

The Whereabouts reconciler is responsible for managing dynamic IP address assignments for the pods within a cluster by using the Whereabouts IP Address Management (IPAM) solution. It ensures that each pod gets a unique IP address from the specified IP address range. It also handles IP address releases when pods are deleted or scaled down.



#### NOTE

You can also use a **NetworkAttachmentDefinition** custom resource (CR) for dynamic IP address assignment.

The **whereabouts-reconciler** daemon set is automatically created when you configure an additional network through the Cluster Network Operator. It is not automatically created when you configure an additional network from a YAML manifest.

To trigger the deployment of the **whereabouts-reconciler** daemon set, you must manually create a **whereabouts-shim** network attachment by editing the Cluster Network Operator custom resource (CR) file.

Use the following procedure to deploy the **whereabouts-reconciler** daemon set.

#### Procedure

1. Edit the **Network.operator.openshift.io** custom resource (CR) by running the following command:



```
$ oc edit network.operator.openshift.io cluster
```

2. Include the **additionalNetworks** section shown in this example YAML extract within the **spec** definition of the custom resource (CR):

```
apiVersion: operator.openshift.io/v1
kind: Network
metadata:
 name: cluster
...
spec:
 additionalNetworks:
 - name: whereabouts-shim
 namespace: default
 rawCNIConfig: |-
 {
 "name": "whereabouts-shim",
 "cniVersion": "0.3.1",
 "type": "bridge",
 "ipam": {
 "type": "whereabouts"
 }
 }
 type: Raw
...
```

3. Save the file and exit the text editor.
4. Verify that the **whereabouts-reconciler** daemon set deployed successfully by running the following command:

```
$ oc get all -n openshift-multus | grep whereabouts-reconciler
```

### Example output

```
pod/whereabouts-reconciler-jnp6g 1/1 Running 0 6s
pod/whereabouts-reconciler-k76gg 1/1 Running 0 6s
pod/whereabouts-reconciler-k86t9 1/1 Running 0 6s
pod/whereabouts-reconciler-p4sxx 1/1 Running 0 6s
pod/whereabouts-reconciler-rvfdv 1/1 Running 0 6s
pod/whereabouts-reconciler-svzw9 1/1 Running 0 6s
daemonset.apps/whereabouts-reconciler 6 6 6 6 6 kubernetes.io/os=linux 6s
```

#### 26.2.4.5. Configuring the Whereabouts IP reconciler schedule

The Whereabouts IPAM CNI plugin runs the IP reconciler daily. This process cleans up any stranded IP allocations that might result in exhausting IPs and therefore prevent new pods from getting an IP allocated to them.

Use this procedure to change the frequency at which the IP reconciler runs.

#### Prerequisites

- You installed the OpenShift CLI (**oc**).

- You have access to the cluster as a user with the **cluster-admin** role.
- You have deployed the **whereabouts-reconciler** daemon set, and the **whereabouts-reconciler** pods are up and running.

## Procedure

1. Run the following command to create a **ConfigMap** object named **whereabouts-config** in the **openshift-multus** namespace with a specific cron expression for the IP reconciler:

```
$ oc create configmap whereabouts-config -n openshift-multus --from-literal=reconciler_cron_expression="*/15 * * * *"
```

This cron expression indicates the IP reconciler runs every 15 minutes. Adjust the expression based on your specific requirements.



### NOTE

The **whereabouts-reconciler** daemon set can only consume a cron expression pattern that includes five asterisks. The sixth, which is used to denote seconds, is currently not supported.

2. Retrieve information about resources related to the **whereabouts-reconciler** daemon set and pods within the **openshift-multus** namespace by running the following command:

```
$ oc get all -n openshift-multus | grep whereabouts-reconciler
```

### Example output

```
pod/whereabouts-reconciler-2p7hw 1/1 Running 0 4m14s
pod/whereabouts-reconciler-76jk7 1/1 Running 0 4m14s
pod/whereabouts-reconciler-94zw6 1/1 Running 0 4m14s
pod/whereabouts-reconciler-mf6h8 1/1 Running 0 4m14s
pod/whereabouts-reconciler-pgshz 1/1 Running 0 4m14s
pod/whereabouts-reconciler-xn5xz 1/1 Running 0 4m14s
daemonset.apps/whereabouts-reconciler 6 6 6 6 6
kubernetes.io/os=linux 4m16s
```

3. Run the following command to verify that the **whereabouts-reconciler** pod runs the IP reconciler with the configured interval:

```
$ oc -n openshift-multus logs whereabouts-reconciler-2p7hw
```

### Example output

```
2024-02-02T16:33:54Z [debug] event not relevant: "/cron-schedule/..2024_02_02_16_33_54.1375928161": CREATE
2024-02-02T16:33:54Z [debug] event not relevant: "/cron-schedule/..2024_02_02_16_33_54.1375928161": CHMOD
2024-02-02T16:33:54Z [debug] event not relevant: "/cron-schedule/..data_tmp": RENAME
2024-02-02T16:33:54Z [verbose] using expression: */15 * * * *
2024-02-02T16:33:54Z [verbose] configuration updated to file "/cron-schedule/..data". New cron expression: */15 * * * *
```

```

2024-02-02T16:33:54Z [verbose] successfully updated CRON configuration id "00c2d1c9-
631d-403f-bb86-73ad104a6817" - new cron expression: */15 * * * *
2024-02-02T16:33:54Z [debug] event not relevant: "/cron-schedule/config": CREATE
2024-02-02T16:33:54Z [debug] event not relevant: "/cron-
schedule/..2024_02_02_16_26_17.3874177937": REMOVE
2024-02-02T16:45:00Z [verbose] starting reconciler run
2024-02-02T16:45:00Z [debug] NewReconcileLooper - inferred connection data
2024-02-02T16:45:00Z [debug] listing IP pools
2024-02-02T16:45:00Z [debug] no IP addresses to cleanup
2024-02-02T16:45:00Z [verbose] reconciler success

```

#### 26.2.4.6. Creating a configuration for assignment of dual-stack IP addresses dynamically

Dual-stack IP address assignment can be configured with the **ipRanges** parameter for:

- IPv4 addresses
- IPv6 addresses
- multiple IP address assignment

#### Procedure

1. Set **type** to **whereabouts**.
2. Use **ipRanges** to allocate IP addresses as shown in the following example:

```

cniVersion: operator.openshift.io/v1
kind: Network
metadata:
 name: cluster
spec:
 additionalNetworks:
 - name: whereabouts-shim
 namespace: default
 type: Raw
 rawCNICofig: |-
 {
 "name": "whereabouts-dual-stack",
 "cniVersion": "0.3.1",
 "type": "bridge",
 "ipam": {
 "type": "whereabouts",
 "ipRanges": [
 {"range": "192.168.10.0/24"},
 {"range": "2001:db8::/64"}
]
 }
 }

```

3. Attach network to a pod. For more information, see "Adding a pod to an additional network".
4. Verify that all IP addresses are assigned.
5. Run the following command to ensure the IP addresses are assigned as metadata.

-

```
$ oc exec -it mypod -- ip a
```

### Additional resources

- [Attaching a pod to an additional network](#)

## 26.2.5. Creating an additional network attachment with the Cluster Network Operator

The Cluster Network Operator (CNO) manages additional network definitions. When you specify an additional network to create, the CNO creates the **NetworkAttachmentDefinition** object automatically.

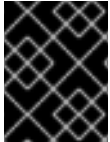

### IMPORTANT

Do not edit the **NetworkAttachmentDefinition** objects that the Cluster Network Operator manages. Doing so might disrupt network traffic on your additional network.

### Prerequisites

- Install the OpenShift CLI (**oc**).
- Log in as a user with **cluster-admin** privileges.

### Procedure

1. Optional: Create the namespace for the additional networks:

```
$ oc create namespace <namespace_name>
```

2. To edit the CNO configuration, enter the following command:

```
$ oc edit networks.operator.openshift.io cluster
```

3. Modify the CR that you are creating by adding the configuration for the additional network that you are creating, as in the following example CR.

```
apiVersion: operator.openshift.io/v1
kind: Network
metadata:
 name: cluster
spec:
 # ...
 additionalNetworks:
 - name: tertiary-net
 namespace: namespace2
 type: Raw
 rawCNICfg: |-
 {
 "cniVersion": "0.3.1",
 "name": "tertiary-net",
 "type": "ipvlan",
 "master": "eth1",
 "mode": "l2",
```

```

"ipam": {
 "type": "static",
 "addresses": [
 {
 "address": "192.168.1.23/24"
 }
]
}
}

```

4. Save your changes and quit the text editor to commit your changes.

### Verification

- Confirm that the CNO created the **NetworkAttachmentDefinition** object by running the following command. There might be a delay before the CNO creates the object.

```
$ oc get network-attachment-definitions -n <namespace>
```

where:

**<namespace>**

Specifies the namespace for the network attachment that you added to the CNO configuration.

### Example output

```

NAME AGE
test-network-1 14m

```

## 26.2.6. Creating an additional network attachment by applying a YAML manifest

### Prerequisites

- Install the OpenShift CLI (**oc**).
- Log in as a user with **cluster-admin** privileges.

### Procedure

1. Create a YAML file with your additional network configuration, such as in the following example:

```

apiVersion: k8s.cni.cncf.io/v1
kind: NetworkAttachmentDefinition
metadata:
 name: next-net
spec:
 config: |-
 {
 "cniVersion": "0.3.1",
 "name": "work-network",
 "type": "host-device",
 "device": "eth1",

```

```
"ipam": {
 "type": "dhcp"
}
```

- To create the additional network, enter the following command:

```
$ oc apply -f <file>.yaml
```

where:

**<file>**

Specifies the name of the file contained the YAML manifest.

## 26.2.7. About configuring the master interface in the container network namespace

In OpenShift Container Platform 4.14 and later, the ability to allow users to create a MAC-VLAN, IP-VLAN, and VLAN subinterface based on a master interface in a container namespace is now generally available.

This feature allows you to create the master interfaces as part of the pod network configuration in a separate network attachment definition. You can then base the VLAN, MACVLAN, or IPVLAN on this interface without requiring the knowledge of the network configuration of the node.

To ensure the use of a container namespace master interface, specify the **linkInContainer** and set the value to **true** in the VLAN, MACVLAN, or IPVLAN plugin configuration depending on the particular type of additional network.

### 26.2.7.1. Creating multiple VLANs on SR-IOV VFs

An example use case for utilizing this feature is to create multiple VLANs based on SR-IOV VFs. To do so, begin by creating an SR-IOV network and then define the network attachments for the VLAN interfaces.

The following example shows how to configure the setup illustrated in this diagram.

**Figure 26.1. Creating VLANs**

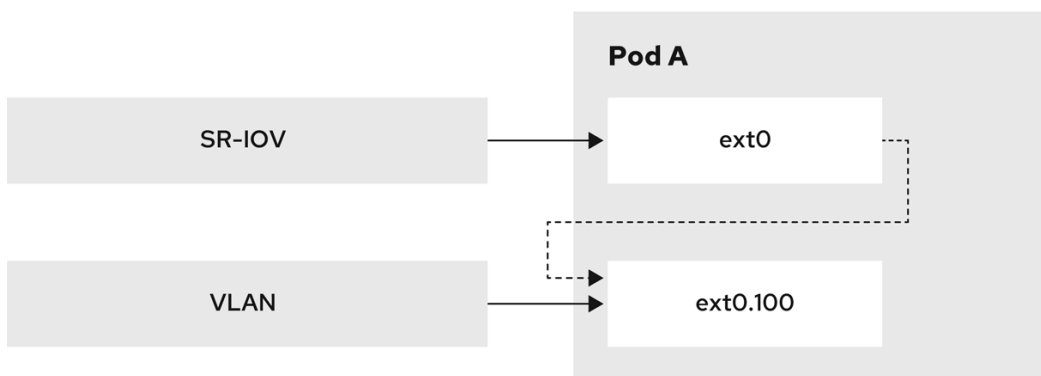

345\_OpenShift\_0823

### Prerequisites

- You installed the OpenShift CLI (**oc**).

- You have access to the cluster as a user with the **cluster-admin** role.
- You have installed the SR-IOV Network Operator.

## Procedure

1. Create a dedicated container namespace where you want to deploy your pod by using the following command:

```
$ oc new-project test-namespace
```

2. Create an SR-IOV node policy:
  - a. Create an **SriovNetworkNodePolicy** object, and then save the YAML in the **sriov-node-network-policy.yaml** file:

```
apiVersion: sriovnetwork.openshift.io/v1
kind: SriovNetworkNodePolicy
metadata:
 name: sriovnic
 namespace: openshift-sriov-network-operator
spec:
 deviceType: netdevice
 isRdma: false
 needVhostNet: true
 nicSelector:
 vendor: "15b3" 1
 deviceID: "101b" 2
 rootDevices: ["00:05.0"]
 numVfs: 10
 priority: 99
 resourceName: sriovnic
 nodeSelector:
 feature.node.kubernetes.io/network-sriov.capable: "true"
```



### NOTE

The SR-IOV network node policy configuration example, with the setting **deviceType: netdevice**, is tailored specifically for Mellanox Network Interface Cards (NICs).

- 1 The vendor hexadecimal code of the SR-IOV network device. The value **15b3** is associated with a Mellanox NIC.
- 2 The device hexadecimal code of the SR-IOV network device.

- b. Apply the YAML by running the following command:

```
$ oc apply -f sriov-node-network-policy.yaml
```

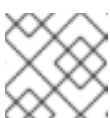

### NOTE

Applying this might take some time due to the node requiring a reboot.

## 3. Create an SR-IOV network:

- a. Create the **SriovNetwork** custom resource (CR) for the additional SR-IOV network attachment as in the following example CR. Save the YAML as the file **sriov-network-attachment.yaml**:

```
apiVersion: sriovnetwork.openshift.io/v1
kind: SriovNetwork
metadata:
 name: sriov-network
 namespace: openshift-sriov-network-operator
spec:
 networkNamespace: test-namespace
 resourceName: sriovnic
 spoofChk: "off"
 trust: "on"
```

- b. Apply the YAML by running the following command:

```
$ oc apply -f sriov-network-attachment.yaml
```

## 4. Create the VLAN additional network:

- a. Using the following YAML example, create a file named **ipvlan100-additional-network-configuration.yaml**:

```
apiVersion: k8s.cni.cncf.io/v1
kind: NetworkAttachmentDefinition
metadata:
 name: vlan-100
 namespace: test-namespace
spec:
 config: |
 {
 "cniVersion": "0.4.0",
 "name": "vlan-100",
 "plugins": [
 {
 "type": "vlan",
 "master": "ext0", 1
 "mtu": 1500,
 "vlanId": 100,
 "linkInContainer": true, 2
 "ipam": {"type": "whereabouts", "ipRanges": [{"range": "1.1.1.0/24"}]}
 }
]
 }
 }
```

**1** The VLAN configuration needs to specify the master name. This can be configured in the pod networks annotation.

**2** The **linkInContainer** parameter must be specified.

- b. Apply the YAML file by running the following command:

-



```
$ oc apply -f vlan100-additional-network-configuration.yaml
```

5. Create a pod definition by using the earlier specified networks:
  - a. Using the following YAML example, create a file named **pod-a.yaml** file:



### NOTE

The manifest below includes 2 resources:

- Namespace with security labels
- Pod definition with appropriate network annotation

```
apiVersion: v1
kind: Namespace
metadata:
 name: test-namespace
 labels:
 pod-security.kubernetes.io/enforce: privileged
 pod-security.kubernetes.io/audit: privileged
 pod-security.kubernetes.io/warn: privileged
 security.openshift.io/scc.podSecurityLabelSync: "false"

apiVersion: v1
kind: Pod
metadata:
 name: nginx-pod
 namespace: test-namespace
 annotations:
 k8s.v1.cni.cncf.io/networks: '[
 {
 "name": "sriov-network",
 "namespace": "test-namespace",
 "interface": "ext0" 1
 },
 {
 "name": "vlan-100",
 "namespace": "test-namespace",
 "interface": "ext0.100"
 }
]'
spec:
 securityContext:
 runAsNonRoot: true
 containers:
 - name: nginx-container
 image: nginxinc/nginx-unprivileged:latest
 securityContext:
 allowPrivilegeEscalation: false
 capabilities:
 drop: ["ALL"]
 ports:
```

```
- containerPort: 80
seccompProfile:
 type: "RuntimeDefault"
```

- 1 The name to be used as the master for the VLAN interface.

- b. Apply the YAML file by running the following command:

```
$ oc apply -f pod-a.yaml
```

6. Get detailed information about the **nginx-pod** within the **test-namespace** by running the following command:

```
$ oc describe pods nginx-pod -n test-namespace
```

### Example output

```
Name: nginx-pod
Namespace: test-namespace
Priority: 0
Node: worker-1/10.46.186.105
Start Time: Mon, 14 Aug 2023 16:23:13 -0400
Labels: <none>
Annotations: k8s.ovn.org/pod-networks:
 {"default":{"ip_addresses":
["10.131.0.26/23"],"mac_address":"0a:58:0a:83:00:1a","gateway_ips":["10.131.0.1"],"routes":
[{"dest":"10.128.0.0...
 k8s.v1.cni.cncf.io/network-status:
 [{
 "name": "ovn-kubernetes",
 "interface": "eth0",
 "ips": [
 "10.131.0.26"
],
 "mac": "0a:58:0a:83:00:1a",
 "default": true,
 "dns": {}
 },{
 "name": "test-namespace/sriov-network",
 "interface": "ext0",
 "mac": "6e:a7:5e:3f:49:1b",
 "dns": {},
 "device-info": {
 "type": "pci",
 "version": "1.0.0",
 "pci": {
 "pci-address": "0000:d8:00.2"
 }
 }
 },{
 "name": "test-namespace/vlan-100",
 "interface": "ext0.100",
 "ips": [
 "1.1.1.1"
```

```

],
 "mac": "6e:a7:5e:3f:49:1b",
 "dns": {}
 }}
 k8s.v1.cni.cncf.io/networks:
 [{ "name": "sriov-network", "namespace": "test-namespace", "interface": "ext0" }, {
"name": "vlan-100", "namespace": "test-namespace", "i...
 openshift.io/scc: privileged
Status: Running
IP: 10.131.0.26
IPs:
IP: 10.131.0.26

```

### 26.2.7.2. Creating a subinterface based on a bridge master interface in a container namespace

Creating a subinterface can be applied to other types of interfaces. Follow this procedure to create a subinterface based on a bridge master interface in a container namespace.

#### Prerequisites

- You have installed the OpenShift CLI (**oc**).
- You are logged in to the OpenShift Container Platform cluster as a user with **cluster-admin** privileges.

#### Procedure

1. Create a dedicated container namespace where you want to deploy your pod by running the following command:

```
$ oc new-project test-namespace
```

2. Using the following YAML example, create a bridge **NetworkAttachmentDefinition** custom resource (CR) file named **bridge-nad.yaml**:

```

apiVersion: "k8s.cni.cncf.io/v1"
kind: NetworkAttachmentDefinition
metadata:
 name: bridge-network
spec:
 config: '{
 "cniVersion": "0.4.0",
 "name": "bridge-network",
 "type": "bridge",
 "bridge": "br-001",
 "isGateway": true,
 "ipMasq": true,
 "hairpinMode": true,
 "ipam": {
 "type": "host-local",
 "subnet": "10.0.0.0/24",
 "routes": [{"dst": "0.0.0.0/0"}]
 }
 }'

```

- 3. Run the following command to apply the **NetworkAttachmentDefinition** CR to your OpenShift Container Platform cluster:

```
$ oc apply -f bridge-nad.yaml
```

- 4. Verify that the **NetworkAttachmentDefinition** CR has been created successfully by running the following command:

```
$ oc get network-attachment-definitions
```

### Example output

```
NAME AGE
bridge-network 15s
```

- 5. Using the following YAML example, create a file named **ipvlan-additional-network-configuration.yaml** for the IPVLAN additional network configuration:

```
apiVersion: k8s.cni.cncf.io/v1
kind: NetworkAttachmentDefinition
metadata:
 name: ipvlan-net
 namespace: test-namespace
spec:
 config: '{
 "cniVersion": "0.3.1",
 "name": "ipvlan-net",
 "type": "ipvlan",
 "master": "ext0", 1
 "mode": "l3",
 "linkInContainer": true, 2
 "ipam": {"type": "whereabouts", "ipRanges": [{"range": "10.0.0.0/24"}]}
 }'
```

1 Specifies the ethernet interface to associate with the network attachment. This is subsequently configured in the pod networks annotation.

2 Specifies that the master interface is in the container network namespace.

- 6. Apply the YAML file by running the following command:

```
$ oc apply -f ipvlan-additional-network-configuration.yaml
```

- 7. Verify that the **NetworkAttachmentDefinition** CR has been created successfully by running the following command:

```
$ oc get network-attachment-definitions
```

### Example output

```

NAME AGE
bridge-network 87s
ipvlan-net 9s

```

8. Using the following YAML example, create a file named **pod-a.yaml** for the pod definition:

```

apiVersion: v1
kind: Pod
metadata:
 name: pod-a
 namespace: test-namespace
 annotations:
 k8s.v1.cni.cncf.io/networks: '[
 {
 "name": "bridge-network",
 "interface": "ext0" 1
 },
 {
 "name": "ipvlan-net",
 "interface": "ext1"
 }
]'
spec:
 securityContext:
 runAsNonRoot: true
 seccompProfile:
 type: RuntimeDefault
 containers:
 - name: test-pod
 image: quay.io/openshifttest/hello-
sdn@sha256:c89445416459e7adea9a5a416b3365ed3d74f2491beb904d61dc8d1eb89a72a4

 securityContext:
 allowPrivilegeEscalation: false
 capabilities:
 drop: [ALL]

```

- 1** Specifies the name to be used as the master for the IPVLAN interface.

9. Apply the YAML file by running the following command:

```
$ oc apply -f pod-a.yaml
```

10. Verify that the pod is running by using the following command:

```
$ oc get pod -n test-namespace
```

### Example output

```

NAME READY STATUS RESTARTS AGE
pod-a 1/1 Running 0 2m36s

```

11. Show network interface information about the **pod-a** resource within the **test-namespace** by running the following command:

```
$ oc exec -n test-namespace pod-a -- ip a
```

### Example output

```
1: lo: <LOOPBACK,UP,LOWER_UP> mtu 65536 qdisc noqueue state UNKNOWN group
default qlen 1000
 link/loopback 00:00:00:00:00:00 brd 00:00:00:00:00:00
 inet 127.0.0.1/8 scope host lo
 valid_lft forever preferred_lft forever
 inet6 ::1/128 scope host
 valid_lft forever preferred_lft forever
3: eth0@if105: <BROADCAST,MULTICAST,UP,LOWER_UP> mtu 1400 qdisc noqueue
state UP group default
 link/ether 0a:58:0a:d9:00:5d brd ff:ff:ff:ff:ff:ff link-netnsid 0
 inet 10.217.0.93/23 brd 10.217.1.255 scope global eth0
 valid_lft forever preferred_lft forever
 inet6 fe80::488b:91ff:fe84:a94b/64 scope link
 valid_lft forever preferred_lft forever
4: ext0@if107: <BROADCAST,MULTICAST,UP,LOWER_UP> mtu 1500 qdisc noqueue
state UP group default
 link/ether be:da:bd:7e:f4:37 brd ff:ff:ff:ff:ff:ff link-netnsid 0
 inet 10.0.0.2/24 brd 10.0.0.255 scope global ext0
 valid_lft forever preferred_lft forever
 inet6 fe80::bcda:bdff:fe7e:f437/64 scope link
 valid_lft forever preferred_lft forever
5: ext1@ext0: <BROADCAST,MULTICAST,NOARP,UP,LOWER_UP> mtu 1500 qdisc
noqueue state UNKNOWN group default
 link/ether be:da:bd:7e:f4:37 brd ff:ff:ff:ff:ff:ff
 inet 10.0.0.1/24 brd 10.0.0.255 scope global ext1
 valid_lft forever preferred_lft forever
 inet6 fe80::beda:bd00:17e:f437/64 scope link
 valid_lft forever preferred_lft forever
```

This output shows that the network interface **ext1** is associated with the physical interface **ext0**.

## 26.3. ABOUT VIRTUAL ROUTING AND FORWARDING

### 26.3.1. About virtual routing and forwarding

Virtual routing and forwarding (VRF) devices combined with IP rules provide the ability to create virtual routing and forwarding domains. VRF reduces the number of permissions needed by CNF, and provides increased visibility of the network topology of secondary networks. VRF is used to provide multi-tenancy functionality, for example, where each tenant has its own unique routing tables and requires different default gateways.

Processes can bind a socket to the VRF device. Packets through the binded socket use the routing table associated with the VRF device. An important feature of VRF is that it impacts only OSI model layer 3 traffic and above so L2 tools, such as LLDP, are not affected. This allows higher priority IP rules such as policy based routing to take precedence over the VRF device rules directing specific traffic.

#### 26.3.1.1. Benefits of secondary networks for pods for telecommunications operators

In telecommunications use cases, each CNF can potentially be connected to multiple different networks sharing the same address space. These secondary networks can potentially conflict with the cluster's main network CIDR. Using the CNI VRF plugin, network functions can be connected to different customers' infrastructure using the same IP address, keeping different customers isolated. IP addresses are overlapped with OpenShift Container Platform IP space. The CNI VRF plugin also reduces the number of permissions needed by CNF and increases the visibility of network topologies of secondary networks.

## 26.4. CONFIGURING MULTI-NETWORK POLICY

As a cluster administrator, you can configure multi-network for additional networks. You can specify multi-network policy for SR-IOV, macvlan, and OVN-Kubernetes additional networks. Macvlan additional networks are fully supported. Other types of additional networks, such as ipvlan, are not supported.

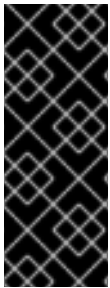

### IMPORTANT

Support for configuring multi-network policies for SR-IOV additional networks is a Technology Preview feature and is only supported with kernel network interface cards (NICs). SR-IOV is not supported for Data Plane Development Kit (DPDK) applications.

For more information about the support scope of Red Hat Technology Preview features, see [Technology Preview Features Support Scope](#).

### 26.4.1. Differences between multi-network policy and network policy

Although the **MultiNetworkPolicy** API implements the **NetworkPolicy** API, there are several important differences:

- You must use the **MultiNetworkPolicy** API:

```
apiVersion: k8s.cni.cncf.io/v1beta1
kind: MultiNetworkPolicy
```

- You must use the **multi-networkpolicy** resource name when using the CLI to interact with multi-network policies. For example, you can view a multi-network policy object with the **oc get multi-networkpolicy <name>** command where **<name>** is the name of a multi-network policy.
- You must specify an annotation with the name of the network attachment definition that defines the macvlan or SR-IOV additional network:

```
apiVersion: k8s.cni.cncf.io/v1beta1
kind: MultiNetworkPolicy
metadata:
 annotations:
 k8s.v1.cni.cncf.io/policy-for: <network_name>
```

where:

**<network\_name>**

Specifies the name of a network attachment definition.

### 26.4.2. Enabling multi-network policy for the cluster

As a cluster administrator, you can enable multi-network policy support on your cluster.

### Prerequisites

- Install the OpenShift CLI (**oc**).
- Log in to the cluster with a user with **cluster-admin** privileges.

### Procedure

1. Create the **multinetwork-enable-patch.yaml** file with the following YAML:

```
apiVersion: operator.openshift.io/v1
kind: Network
metadata:
 name: cluster
spec:
 useMultiNetworkPolicy: true
```

2. Configure the cluster to enable multi-network policy:

```
$ oc patch network.operator.openshift.io cluster --type=merge --patch-file=multinetwork-
enable-patch.yaml
```

### Example output

```
network.operator.openshift.io/cluster patched
```

## 26.4.3. Supporting multi-network policies in IPv6 networks

The ICMPv6 Neighbor Discovery Protocol (NDP) is a set of messages and processes that enable devices to discover and maintain information about neighboring nodes. NDP plays a crucial role in IPv6 networks, facilitating the interaction between devices on the same link.

The Cluster Network Operator (CNO) deploys the iptables implementation of multi-network policy when the **useMultiNetworkPolicy** parameter is set to **true**.

To support multi-network policies in IPv6 networks the Cluster Network Operator deploys the following set of rules in every pod affected by a multi-network policy:

### Multi-network policy custom rules

```
kind: ConfigMap
apiVersion: v1
metadata:
 name: multi-networkpolicy-custom-rules
 namespace: openshift-multus
data:

 custom-v6-rules.txt: |
 # accept NDP
 -p icmpv6 --icmpv6-type neighbor-solicitation -j ACCEPT 1
 -p icmpv6 --icmpv6-type neighbor-advertisement -j ACCEPT 2
```



```
accept RA/RS
-p icmpv6 --icmpv6-type router-solicitation -j ACCEPT 3
-p icmpv6 --icmpv6-type router-advertisement -j ACCEPT 4
```

- 1** This rule allows incoming ICMPv6 neighbor solicitation messages, which are part of the neighbor discovery protocol (NDP). These messages help determine the link-layer addresses of neighboring nodes.
- 2** This rule allows incoming ICMPv6 neighbor advertisement messages, which are part of NDP and provide information about the link-layer address of the sender.
- 3** This rule permits incoming ICMPv6 router solicitation messages. Hosts use these messages to request router configuration information.
- 4** This rule allows incoming ICMPv6 router advertisement messages, which give configuration information to hosts.

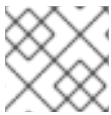

## NOTE

You cannot edit these predefined rules.

These rules collectively enable essential ICMPv6 traffic for correct network functioning, including address resolution and router communication in an IPv6 environment. With these rules in place and a multi-network policy denying traffic, applications are not expected to experience connectivity issues.

### 26.4.4. Working with multi-network policy

As a cluster administrator, you can create, edit, view, and delete multi-network policies.

#### 26.4.4.1. Prerequisites

- You have enabled multi-network policy support for your cluster.

#### 26.4.4.2. Creating a multi-network policy using the CLI

To define granular rules describing ingress or egress network traffic allowed for namespaces in your cluster, you can create a multi-network policy.

##### Prerequisites

- Your cluster uses a network plugin that supports **NetworkPolicy** objects, such as the OVN-Kubernetes network plugin or the OpenShift SDN network plugin with **mode: NetworkPolicy** set. This mode is the default for OpenShift SDN.
- You installed the OpenShift CLI (**oc**).
- You are logged in to the cluster with a user with **cluster-admin** privileges.
- You are working in the namespace that the multi-network policy applies to.

##### Procedure

1. Create a policy rule:

- a. Create a **<policy\_name>.yaml** file:

```
$ touch <policy_name>.yaml
```

where:

**<policy\_name>**

Specifies the multi-network policy file name.

- b. Define a multi-network policy in the file that you just created, such as in the following examples:

**Deny ingress from all pods in all namespaces**

This is a fundamental policy, blocking all cross-pod networking other than cross-pod traffic allowed by the configuration of other Network Policies.

```
apiVersion: k8s.cni.cncf.io/v1beta1
kind: MultiNetworkPolicy
metadata:
 name: deny-by-default
 annotations:
 k8s.v1.cni.cncf.io/policy-for:<namespace_name>/<network_name>
spec:
 podSelector: {}
 policyTypes:
 - Ingress
 ingress: []
```

where:

**<network\_name>**

Specifies the name of a network attachment definition.

**Allow ingress from all pods in the same namespace**

```
apiVersion: k8s.cni.cncf.io/v1beta1
kind: MultiNetworkPolicy
metadata:
 name: allow-same-namespace
 annotations:
 k8s.v1.cni.cncf.io/policy-for: <network_name>
spec:
 podSelector:
 ingress:
 - from:
 - podSelector: {}
```

where:

**<network\_name>**

Specifies the name of a network attachment definition.

## Allow ingress traffic to one pod from a particular namespace

This policy allows traffic to pods labelled **pod-a** from pods running in **namespace-y**.

```

apiVersion: k8s.cni.cncf.io/v1beta1
kind: MultiNetworkPolicy
metadata:
 name: allow-traffic-pod
 annotations:
 k8s.v1.cni.cncf.io/policy-for: <network_name>
spec:
 podSelector:
 matchLabels:
 pod: pod-a
 policyTypes:
 - Ingress
 ingress:
 - from:
 - namespaceSelector:
 matchLabels:
 kubernetes.io/metadata.name: namespace-y

```

where:

### <network\_name>

Specifies the name of a network attachment definition.

## Restrict traffic to a service

This policy when applied ensures every pod with both labels **app=bookstore** and **role=api** can only be accessed by pods with label **app=bookstore**. In this example the application could be a REST API server, marked with labels **app=bookstore** and **role=api**.

This example addresses the following use cases:

- Restricting the traffic to a service to only the other microservices that need to use it.
- Restricting the connections to a database to only permit the application using it.

```

apiVersion: k8s.cni.cncf.io/v1beta1
kind: MultiNetworkPolicy
metadata:
 name: api-allow
 annotations:
 k8s.v1.cni.cncf.io/policy-for: <network_name>
spec:
 podSelector:
 matchLabels:
 app: bookstore
 role: api
 ingress:
 - from:
 - podSelector:
 matchLabels:
 app: bookstore

```

where:

**<network\_name>**

Specifies the name of a network attachment definition.

- To create the multi-network policy object, enter the following command:

```
$ oc apply -f <policy_name>.yaml -n <namespace>
```

where:

**<policy\_name>**

Specifies the multi-network policy file name.

**<namespace>**

Optional: Specifies the namespace if the object is defined in a different namespace than the current namespace.

### Example output

```
multinetworkpolicy.k8s.cni.cncf.io/deny-by-default created
```



### NOTE

If you log in to the web console with **cluster-admin** privileges, you have a choice of creating a network policy in any namespace in the cluster directly in YAML or from a form in the web console.

### 26.4.4.3. Editing a multi-network policy

You can edit a multi-network policy in a namespace.

#### Prerequisites

- Your cluster uses a network plugin that supports **NetworkPolicy** objects, such as the OVN-Kubernetes network plugin or the OpenShift SDN network plugin with **mode: NetworkPolicy** set. This mode is the default for OpenShift SDN.
- You installed the OpenShift CLI (**oc**).
- You are logged in to the cluster with a user with **cluster-admin** privileges.
- You are working in the namespace where the multi-network policy exists.

#### Procedure

- Optional: To list the multi-network policy objects in a namespace, enter the following command:

```
$ oc get multi-networkpolicy
```

where:

**<namespace>**

Optional: Specifies the namespace if the object is defined in a different namespace than the current namespace.

## 2. Edit the multi-network policy object.

- If you saved the multi-network policy definition in a file, edit the file and make any necessary changes, and then enter the following command.

```
$ oc apply -n <namespace> -f <policy_file>.yaml
```

where:

### <namespace>

Optional: Specifies the namespace if the object is defined in a different namespace than the current namespace.

### <policy\_file>

Specifies the name of the file containing the network policy.

- If you need to update the multi-network policy object directly, enter the following command:

```
$ oc edit multi-networkpolicy <policy_name> -n <namespace>
```

where:

### <policy\_name>

Specifies the name of the network policy.

### <namespace>

Optional: Specifies the namespace if the object is defined in a different namespace than the current namespace.

## 3. Confirm that the multi-network policy object is updated.

```
$ oc describe multi-networkpolicy <policy_name> -n <namespace>
```

where:

### <policy\_name>

Specifies the name of the multi-network policy.

### <namespace>

Optional: Specifies the namespace if the object is defined in a different namespace than the current namespace.



## NOTE

If you log in to the web console with **cluster-admin** privileges, you have a choice of editing a network policy in any namespace in the cluster directly in YAML or from the policy in the web console through the **Actions** menu.

### 26.4.4.4. Viewing multi-network policies using the CLI

You can examine the multi-network policies in a namespace.

## Prerequisites

- You installed the OpenShift CLI (**oc**).
- You are logged in to the cluster with a user with **cluster-admin** privileges.
- You are working in the namespace where the multi-network policy exists.

## Procedure

- List multi-network policies in a namespace:
  - To view multi-network policy objects defined in a namespace, enter the following command:

```
$ oc get multi-networkpolicy
```

- Optional: To examine a specific multi-network policy, enter the following command:

```
$ oc describe multi-networkpolicy <policy_name> -n <namespace>
```

where:

### <policy\_name>

Specifies the name of the multi-network policy to inspect.

### <namespace>

Optional: Specifies the namespace if the object is defined in a different namespace than the current namespace.



## NOTE

If you log in to the web console with **cluster-admin** privileges, you have a choice of viewing a network policy in any namespace in the cluster directly in YAML or from a form in the web console.

### 26.4.4.5. Deleting a multi-network policy using the CLI

You can delete a multi-network policy in a namespace.

## Prerequisites

- Your cluster uses a network plugin that supports **NetworkPolicy** objects, such as the OVN-Kubernetes network plugin or the OpenShift SDN network plugin with **mode: NetworkPolicy** set. This mode is the default for OpenShift SDN.
- You installed the OpenShift CLI (**oc**).
- You are logged in to the cluster with a user with **cluster-admin** privileges.
- You are working in the namespace where the multi-network policy exists.

## Procedure

- To delete a multi-network policy object, enter the following command:

```
$ oc delete multi-networkpolicy <policy_name> -n <namespace>
```

where:

**<policy\_name>**

Specifies the name of the multi-network policy.

**<namespace>**

Optional: Specifies the namespace if the object is defined in a different namespace than the current namespace.

**Example output**

```
multinetworkpolicy.k8s.cni.cncf.io/default-deny deleted
```



**NOTE**

If you log in to the web console with **cluster-admin** privileges, you have a choice of deleting a network policy in any namespace in the cluster directly in YAML or from the policy in the web console through the **Actions** menu.

#### 26.4.4.6. Creating a default deny all multi-network policy

This is a fundamental policy, blocking all cross-pod networking other than network traffic allowed by the configuration of other deployed network policies. This procedure enforces a default **deny-by-default** policy.



**NOTE**

If you log in with a user with the **cluster-admin** role, then you can create a network policy in any namespace in the cluster.

**Prerequisites**

- Your cluster uses a network plugin that supports **NetworkPolicy** objects, such as the OVN-Kubernetes network plugin or the OpenShift SDN network plugin with **mode: NetworkPolicy** set. This mode is the default for OpenShift SDN.
- You installed the OpenShift CLI (**oc**).
- You are logged in to the cluster with a user with **cluster-admin** privileges.
- You are working in the namespace that the multi-network policy applies to.

**Procedure**

1. Create the following YAML that defines a **deny-by-default** policy to deny ingress from all pods in all namespaces. Save the YAML in the **deny-by-default.yaml** file:

```
apiVersion: k8s.cni.cncf.io/v1beta1
kind: MultiNetworkPolicy
metadata:
 name: deny-by-default
```

```

namespace: default 1
annotations:
 k8s.v1.cni.cncf.io/policy-for: <namespace_name>/<network_name> 2
spec:
 podSelector: {} 3
 policyTypes: 4
 - Ingress 5
 ingress: [] 6

```

- 1** **namespace: default** deploys this policy to the **default** namespace.
- 2** **network\_name**: specifies the name of a network attachment definition.
- 3** **podSelector**: is empty, this means it matches all the pods. Therefore, the policy applies to all pods in the default namespace.
- 4** **policyTypes**: a list of rule types that the **NetworkPolicy** relates to.
- 5** Specifies as **Ingress** only **policyType**.
- 6** There are no **ingress** rules specified. This causes incoming traffic to be dropped to all pods.

2. Apply the policy by entering the following command:

```
$ oc apply -f deny-by-default.yaml
```

#### Example output

```
multinetworkpolicy.k8s.cni.cncf.io/deny-by-default created
```

### 26.4.4.7. Creating a multi-network policy to allow traffic from external clients

With the **deny-by-default** policy in place you can proceed to configure a policy that allows traffic from external clients to a pod with the label **app=web**.



#### NOTE

If you log in with a user with the **cluster-admin** role, then you can create a network policy in any namespace in the cluster.

Follow this procedure to configure a policy that allows external service from the public Internet directly or by using a Load Balancer to access the pod. Traffic is only allowed to a pod with the label **app=web**.

#### Prerequisites

- Your cluster uses a network plugin that supports **NetworkPolicy** objects, such as the OVN-Kubernetes network plugin or the OpenShift SDN network plugin with **mode: NetworkPolicy** set. This mode is the default for OpenShift SDN.
- You installed the OpenShift CLI (**oc**).



- You are logged in to the cluster with a user with **cluster-admin** privileges.
- You are working in the namespace that the multi-network policy applies to.

## Procedure

1. Create a policy that allows traffic from the public Internet directly or by using a load balancer to access the pod. Save the YAML in the **web-allow-external.yaml** file:

```

apiVersion: k8s.cni.cncf.io/v1beta1
kind: MultiNetworkPolicy
metadata:
 name: web-allow-external
 namespace: default
 annotations:
 k8s.v1.cni.cncf.io/policy-for: <network_name>
spec:
 policyTypes:
 - Ingress
 podSelector:
 matchLabels:
 app: web
 ingress:
 - {}

```

2. Apply the policy by entering the following command:

```
$ oc apply -f web-allow-external.yaml
```

## Example output

```
multinetworkpolicy.k8s.cni.cncf.io/web-allow-external created
```

This policy allows traffic from all resources, including external traffic as illustrated in the following diagram:

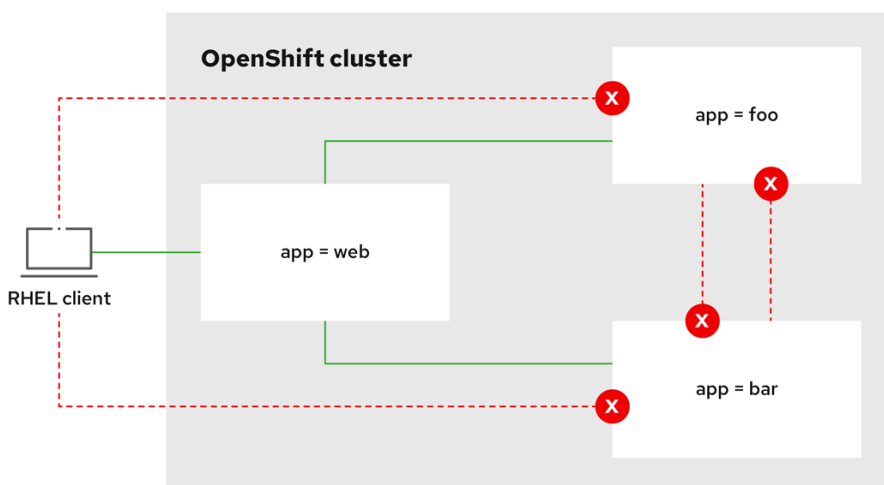

292\_OpenShift\_1122

### 26.4.4.8. Creating a multi-network policy allowing traffic to an application from all namespaces



#### NOTE

If you log in with a user with the **cluster-admin** role, then you can create a network policy in any namespace in the cluster.

Follow this procedure to configure a policy that allows traffic from all pods in all namespaces to a particular application.

#### Prerequisites

- Your cluster uses a network plugin that supports **NetworkPolicy** objects, such as the OVN-Kubernetes network plugin or the OpenShift SDN network plugin with **mode: NetworkPolicy** set. This mode is the default for OpenShift SDN.
- You installed the OpenShift CLI (**oc**).
- You are logged in to the cluster with a user with **cluster-admin** privileges.
- You are working in the namespace that the multi-network policy applies to.

#### Procedure

1. Create a policy that allows traffic from all pods in all namespaces to a particular application. Save the YAML in the **web-allow-all-namespaces.yaml** file:

```
apiVersion: k8s.cni.cncf.io/v1beta1
kind: MultiNetworkPolicy
metadata:
 name: web-allow-all-namespaces
 namespace: default
 annotations:
 k8s.v1.cni.cncf.io/policy-for: <network_name>
spec:
 podSelector:
 matchLabels:
 app: web 1
 policyTypes:
 - Ingress
 ingress:
 - from:
 - namespaceSelector: {} 2
```

**1** Applies the policy only to **app:web** pods in default namespace.

**2** Selects all pods in all namespaces.

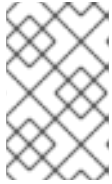
**NOTE**

By default, if you omit specifying a **namespaceSelector** it does not select any namespaces, which means the policy allows traffic only from the namespace the network policy is deployed to.

2. Apply the policy by entering the following command:

```
$ oc apply -f web-allow-all-namespaces.yaml
```

**Example output**

```
multinetworkpolicy.k8s.cni.cncf.io/web-allow-all-namespaces created
```

**Verification**

1. Start a web service in the **default** namespace by entering the following command:

```
$ oc run web --namespace=default --image=nginx --labels="app=web" --expose --port=80
```

2. Run the following command to deploy an **alpine** image in the **secondary** namespace and to start a shell:

```
$ oc run test-$RANDOM --namespace=secondary --rm -i -t --image=alpine -- sh
```

3. Run the following command in the shell and observe that the request is allowed:

```
wget -qO- --timeout=2 http://web.default
```

**Expected output**

```
<!DOCTYPE html>
<html>
<head>
<title>Welcome to nginx!</title>
<style>
html { color-scheme: light dark; }
body { width: 35em; margin: 0 auto;
font-family: Tahoma, Verdana, Arial, sans-serif; }
</style>
</head>
<body>
<h1>Welcome to nginx!</h1>
<p>If you see this page, the nginx web server is successfully installed and
working. Further configuration is required.</p>

<p>For online documentation and support please refer to
nginx.org.

Commercial support is available at
nginx.com.</p>
```

```
<p>Thank you for using nginx.</p>
</body>
</html>
```

#### 26.4.4.9. Creating a multi-network policy allowing traffic to an application from a namespace

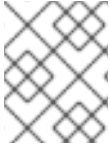

#### NOTE

If you log in with a user with the **cluster-admin** role, then you can create a network policy in any namespace in the cluster.

Follow this procedure to configure a policy that allows traffic to a pod with the label **app=web** from a particular namespace. You might want to do this to:

- Restrict traffic to a production database only to namespaces where production workloads are deployed.
- Enable monitoring tools deployed to a particular namespace to scrape metrics from the current namespace.

#### Prerequisites

- Your cluster uses a network plugin that supports **NetworkPolicy** objects, such as the OVN-Kubernetes network plugin or the OpenShift SDN network plugin with **mode: NetworkPolicy** set. This mode is the default for OpenShift SDN.
- You installed the OpenShift CLI (**oc**).
- You are logged in to the cluster with a user with **cluster-admin** privileges.
- You are working in the namespace that the multi-network policy applies to.

#### Procedure

1. Create a policy that allows traffic from all pods in a particular namespaces with a label **purpose=production**. Save the YAML in the **web-allow-prod.yaml** file:

```
apiVersion: k8s.cni.cncf.io/v1beta1
kind: MultiNetworkPolicy
metadata:
 name: web-allow-prod
 namespace: default
 annotations:
 k8s.v1.cni.cncf.io/policy-for: <network_name>
spec:
 podSelector:
 matchLabels:
 app: web 1
 policyTypes:
 - Ingress
 ingress:
 - from:
```

```
- namespaceSelector:
 matchLabels:
 purpose: production 2
```

- 1 Applies the policy only to **app:web** pods in the default namespace.
- 2 Restricts traffic to only pods in namespaces that have the label **purpose=production**.

2. Apply the policy by entering the following command:

```
$ oc apply -f web-allow-prod.yaml
```

### Example output

```
multinetworkpolicy.k8s.cni.cncf.io/web-allow-prod created
```

### Verification

1. Start a web service in the **default** namespace by entering the following command:

```
$ oc run web --namespace=default --image=nginx --labels="app=web" --expose --port=80
```

2. Run the following command to create the **prod** namespace:

```
$ oc create namespace prod
```

3. Run the following command to label the **prod** namespace:

```
$ oc label namespace/prod purpose=production
```

4. Run the following command to create the **dev** namespace:

```
$ oc create namespace dev
```

5. Run the following command to label the **dev** namespace:

```
$ oc label namespace/dev purpose=testing
```

6. Run the following command to deploy an **alpine** image in the **dev** namespace and to start a shell:

```
$ oc run test-$RANDOM --namespace=dev --rm -i -t --image=alpine -- sh
```

7. Run the following command in the shell and observe that the request is blocked:

```
wget -qO- --timeout=2 http://web.default
```

### Expected output

```
wget: download timed out
```

- 8. Run the following command to deploy an **alpine** image in the **prod** namespace and start a shell:

```
$ oc run test-$RANDOM --namespace=prod --rm -i -t --image=alpine -- sh
```

- 9. Run the following command in the shell and observe that the request is allowed:

```
wget -qO- --timeout=2 http://web.default
```

#### Expected output

```
<!DOCTYPE html>
<html>
<head>
<title>Welcome to nginx!</title>
<style>
html { color-scheme: light dark; }
body { width: 35em; margin: 0 auto;
font-family: Tahoma, Verdana, Arial, sans-serif; }
</style>
</head>
<body>
<h1>Welcome to nginx!</h1>
<p>If you see this page, the nginx web server is successfully installed and
working. Further configuration is required.</p>

<p>For online documentation and support please refer to
nginx.org.

Commercial support is available at
nginx.com.</p>

<p>Thank you for using nginx.</p>
</body>
</html>
```

### 26.4.5. Additional resources

- [About network policy](#)
- [Understanding multiple networks](#)
- [Configuring a macvlan network](#)
- [Configuring an SR-IOV network device](#)

## 26.5. ATTACHING A POD TO AN ADDITIONAL NETWORK

As a cluster user you can attach a pod to an additional network.

### 26.5.1. Adding a pod to an additional network

You can add a pod to an additional network. The pod continues to send normal cluster-related network traffic over the default network.

When a pod is created additional networks are attached to it. However, if a pod already exists, you cannot attach additional networks to it.

The pod must be in the same namespace as the additional network.

## Prerequisites

- Install the OpenShift CLI (**oc**).
- Log in to the cluster.

## Procedure

1. Add an annotation to the **Pod** object. Only one of the following annotation formats can be used:

- a. To attach an additional network without any customization, add an annotation with the following format. Replace **<network>** with the name of the additional network to associate with the pod:

```
metadata:
 annotations:
 k8s.v1.cni.cncf.io/networks: <network>[,<network>,...] 1
```

- 1 To specify more than one additional network, separate each network with a comma. Do not include whitespace between the comma. If you specify the same additional network multiple times, that pod will have multiple network interfaces attached to that network.

- b. To attach an additional network with customizations, add an annotation with the following format:

```
metadata:
 annotations:
 k8s.v1.cni.cncf.io/networks: |-
 [
 {
 "name": "<network>", 1
 "namespace": "<namespace>", 2
 "default-route": ["<default-route>"] 3
 }
]
```

- 1 Specify the name of the additional network defined by a **NetworkAttachmentDefinition** object.
- 2 Specify the namespace where the **NetworkAttachmentDefinition** object is defined.
- 3 Optional: Specify an override for the default route, such as **192.168.17.1**.

2. To create the pod, enter the following command. Replace **<name>** with the name of the pod.

```
$ oc create -f <name>.yaml
```

- Optional: To Confirm that the annotation exists in the **Pod** CR, enter the following command, replacing **<name>** with the name of the pod.

```
$ oc get pod <name> -o yaml
```

In the following example, the **example-pod** pod is attached to the **net1** additional network:

```
$ oc get pod example-pod -o yaml
apiVersion: v1
kind: Pod
metadata:
 annotations:
 k8s.v1.cni.cncf.io/networks: macvlan-bridge
 k8s.v1.cni.cncf.io/network-status: |- 1
 [
 {
 "name": "openshift-sdn",
 "interface": "eth0",
 "ips": [
 "10.128.2.14"
],
 "default": true,
 "dns": {}
 },
 {
 "name": "macvlan-bridge",
 "interface": "net1",
 "ips": [
 "20.2.2.100"
],
 "mac": "22:2f:60:a5:f8:00",
 "dns": {}
 }
]
 name: example-pod
 namespace: default
spec:
 ...
status:
 ...
```

- 1** The **k8s.v1.cni.cncf.io/network-status** parameter is a JSON array of objects. Each object describes the status of an additional network attached to the pod. The annotation value is stored as a plain text value.

### 26.5.1.1. Specifying pod-specific addressing and routing options

When attaching a pod to an additional network, you may want to specify further properties about that network in a particular pod. This allows you to change some aspects of routing, as well as specify static IP addresses and MAC addresses. To accomplish this, you can use the JSON formatted annotations.

#### Prerequisites

- The pod must be in the same namespace as the additional network.
- Install the OpenShift CLI (**oc**).



- You must log in to the cluster.

## Procedure

To add a pod to an additional network while specifying addressing and/or routing options, complete the following steps:

1. Edit the **Pod** resource definition. If you are editing an existing **Pod** resource, run the following command to edit its definition in the default editor. Replace **<name>** with the name of the **Pod** resource to edit.

```
$ oc edit pod <name>
```

2. In the **Pod** resource definition, add the **k8s.v1.cni.cncf.io/networks** parameter to the pod **metadata** mapping. The **k8s.v1.cni.cncf.io/networks** accepts a JSON string of a list of objects that reference the name of **NetworkAttachmentDefinition** custom resource (CR) names in addition to specifying additional properties.

```
metadata:
 annotations:
 k8s.v1.cni.cncf.io/networks: ' [<network>[,<network>,...]]' 1
```

- 1 Replace **<network>** with a JSON object as shown in the following examples. The single quotes are required.

3. In the following example the annotation specifies which network attachment will have the default route, using the **default-route** parameter.

```
apiVersion: v1
kind: Pod
metadata:
 name: example-pod
 annotations:
 k8s.v1.cni.cncf.io/networks: '[
 {
 "name": "net1"
 },
 {
 "name": "net2", 1
 "default-route": ["192.0.2.1"] 2
 }
]'
```

```
spec:
 containers:
 - name: example-pod
 command: ["/bin/bash", "-c", "sleep 2000000000000"]
 image: centos/tools
```

- 1 The **name** key is the name of the additional network to associate with the pod.
- 2 The **default-route** key specifies a value of a gateway for traffic to be routed over if no other routing entry is present in the routing table. If more than one **default-route** key is specified, this will cause the pod to fail to become active.

The default route will cause any traffic that is not specified in other routes to be routed to the gateway.

**IMPORTANT**

Setting the default route to an interface other than the default network interface for OpenShift Container Platform may cause traffic that is anticipated for pod-to-pod traffic to be routed over another interface.

To verify the routing properties of a pod, the **oc** command may be used to execute the **ip** command within a pod.

```
$ oc exec -it <pod_name> -- ip route
```

**NOTE**

You may also reference the pod's **k8s.v1.cni.cncf.io/network-status** to see which additional network has been assigned the default route, by the presence of the **default-route** key in the JSON-formatted list of objects.

To set a static IP address or MAC address for a pod you can use the JSON formatted annotations. This requires you create networks that specifically allow for this functionality. This can be specified in a rawCNICongfig for the CNO.

1. Edit the CNO CR by running the following command:

```
$ oc edit networks.operator.openshift.io cluster
```

The following YAML describes the configuration parameters for the CNO:

**Cluster Network Operator YAML configuration**

```
name: <name> 1
namespace: <namespace> 2
rawCNICongfig: '{ 3
 ...
}'
type: Raw
```

- 1 Specify a name for the additional network attachment that you are creating. The name must be unique within the specified **namespace**.
- 2 Specify the namespace to create the network attachment in. If you do not specify a value, then the **default** namespace is used.
- 3 Specify the CNI plugin configuration in JSON format, which is based on the following template.

The following object describes the configuration parameters for utilizing static MAC address and IP address using the macvlan CNI plugin:

**macvlan CNI plugin JSON configuration object using static IP and MAC address**

```
{
 "cniVersion": "0.3.1",
 "name": "<name>", 1
```

```

"plugins": [{
 "type": "macvlan",
 "capabilities": { "ips": true },
 "master": "eth0",
 "mode": "bridge",
 "ipam": {
 "type": "static"
 }
}, {
 "capabilities": { "mac": true },
 "type": "tuning"
}]
}

```

- 1 Specifies the name for the additional network attachment to create. The name must be unique within the specified **namespace**.
- 2 Specifies an array of CNI plugin configurations. The first object specifies a macvlan plugin configuration and the second object specifies a tuning plugin configuration.
- 3 Specifies that a request is made to enable the static IP address functionality of the CNI plugin runtime configuration capabilities.
- 4 Specifies the interface that the macvlan plugin uses.
- 5 Specifies that a request is made to enable the static MAC address functionality of a CNI plugin.

The above network attachment can be referenced in a JSON formatted annotation, along with keys to specify which static IP and MAC address will be assigned to a given pod.

Edit the pod with:

```
$ oc edit pod <name>
```

### macvlan CNI plugin JSON configuration object using static IP and MAC address

```

apiVersion: v1
kind: Pod
metadata:
 name: example-pod
 annotations:
 k8s.v1.cni.cncf.io/networks: '[
 {
 "name": "<name>",
 "ips": ["192.0.2.205/24"],
 "mac": "CA:FE:C0:FF:EE:00"
 }
]'

```

- 1 Use the **<name>** as provided when creating the **rawCNICConfig** above.
- 2 Provide an IP address including the subnet mask.

- 3 Provide the MAC address.

**NOTE**

Static IP addresses and MAC addresses do not have to be used at the same time, you may use them individually, or together.

To verify the IP address and MAC properties of a pod with additional networks, use the **oc** command to execute the `ip` command within a pod.

```
$ oc exec -it <pod_name> -- ip a
```

## 26.6. REMOVING A POD FROM AN ADDITIONAL NETWORK

As a cluster user you can remove a pod from an additional network.

### 26.6.1. Removing a pod from an additional network

You can remove a pod from an additional network only by deleting the pod.

#### Prerequisites

- An additional network is attached to the pod.
- Install the OpenShift CLI (**oc**).
- Log in to the cluster.

#### Procedure

- To delete the pod, enter the following command:

```
$ oc delete pod <name> -n <namespace>
```

- **<name>** is the name of the pod.
- **<namespace>** is the namespace that contains the pod.

## 26.7. EDITING AN ADDITIONAL NETWORK

As a cluster administrator you can modify the configuration for an existing additional network.

### 26.7.1. Modifying an additional network attachment definition

As a cluster administrator, you can make changes to an existing additional network. Any existing pods attached to the additional network will not be updated.

#### Prerequisites

- You have configured an additional network for your cluster.

- Install the OpenShift CLI (**oc**).
- Log in as a user with **cluster-admin** privileges.

## Procedure

To edit an additional network for your cluster, complete the following steps:

1. Run the following command to edit the Cluster Network Operator (CNO) CR in your default text editor:
 

```
$ oc edit networks.operator.openshift.io cluster
```
2. In the **additionalNetworks** collection, update the additional network with your changes.
3. Save your changes and quit the text editor to commit your changes.
4. Optional: Confirm that the CNO updated the **NetworkAttachmentDefinition** object by running the following command. Replace **<network-name>** with the name of the additional network to display. There might be a delay before the CNO updates the **NetworkAttachmentDefinition** object to reflect your changes.

```
$ oc get network-attachment-definitions <network-name> -o yaml
```

For example, the following console output displays a **NetworkAttachmentDefinition** object that is named **net1**:

```
$ oc get network-attachment-definitions net1 -o go-template='{{printf "%s\n" .spec.config}}'
{ "cniVersion": "0.3.1", "type": "macvlan",
 "master": "ens5",
 "mode": "bridge",
 "ipam": { "type": "static", "routes": [{"dst": "0.0.0.0/0", "gw": "10.128.2.1"}], "addresses":
 [{"address": "10.128.2.100/23", "gateway": "10.128.2.1"}], "dns": {"nameservers":
 ["172.30.0.10"], "domain": "us-west-2.compute.internal", "search": ["us-west-
 2.compute.internal"]}} }
```

## 26.8. REMOVING AN ADDITIONAL NETWORK

As a cluster administrator you can remove an additional network attachment.

### 26.8.1. Removing an additional network attachment definition

As a cluster administrator, you can remove an additional network from your OpenShift Container Platform cluster. The additional network is not removed from any pods it is attached to.

#### Prerequisites

- Install the OpenShift CLI (**oc**).
- Log in as a user with **cluster-admin** privileges.

#### Procedure

To remove an additional network from your cluster, complete the following steps:

1. Edit the Cluster Network Operator (CNO) in your default text editor by running the following command:

```
$ oc edit networks.operator.openshift.io cluster
```

2. Modify the CR by removing the configuration from the **additionalNetworks** collection for the network attachment definition you are removing.

```
apiVersion: operator.openshift.io/v1
kind: Network
metadata:
 name: cluster
spec:
 additionalNetworks: [] 1
```

- 1** If you are removing the configuration mapping for the only additional network attachment definition in the **additionalNetworks** collection, you must specify an empty collection.

3. Save your changes and quit the text editor to commit your changes.
4. Optional: Confirm that the additional network CR was deleted by running the following command:

```
$ oc get network-attachment-definition --all-namespaces
```

## 26.9. ASSIGNING A SECONDARY NETWORK TO A VRF

As a cluster administrator, you can configure an additional network for a virtual routing and forwarding (VRF) domain by using the CNI VRF plugin. The virtual network that this plugin creates is associated with the physical interface that you specify.

Using a secondary network with a VRF instance has the following advantages:

### Workload isolation

Isolate workload traffic by configuring a VRF instance for the additional network.

### Improved security

Enable improved security through isolated network paths in the VRF domain.

### Multi-tenancy support

Support multi-tenancy through network segmentation with a unique routing table in the VRF domain for each tenant.



### NOTE

Applications that use VRFs must bind to a specific device. The common usage is to use the **SO\_BINDTODEVICE** option for a socket. The **SO\_BINDTODEVICE** option binds the socket to the device that is specified in the passed interface name, for example, **eth1**. To use the **SO\_BINDTODEVICE** option, the application must have **CAP\_NET\_RAW** capabilities.

Using a VRF through the **ip vrf exec** command is not supported in OpenShift Container Platform pods. To use VRF, bind applications directly to the VRF interface.

## Additional resources

- [About virtual routing and forwarding](#)

### 26.9.1. Creating an additional network attachment with the CNI VRF plugin

The Cluster Network Operator (CNO) manages additional network definitions. When you specify an additional network to create, the CNO creates the **NetworkAttachmentDefinition** custom resource (CR) automatically.



#### NOTE

Do not edit the **NetworkAttachmentDefinition** CRs that the Cluster Network Operator manages. Doing so might disrupt network traffic on your additional network.

To create an additional network attachment with the CNI VRF plugin, perform the following procedure.

#### Prerequisites

- Install the OpenShift Container Platform CLI (oc).
- Log in to the OpenShift cluster as a user with cluster-admin privileges.

#### Procedure

1. Create the **Network** custom resource (CR) for the additional network attachment and insert the **rawCNIConfig** configuration for the additional network, as in the following example CR. Save the YAML as the file **additional-network-attachment.yaml**.

```
apiVersion: operator.openshift.io/v1
kind: Network
metadata:
 name: cluster
spec:
 additionalNetworks:
 - name: test-network-1
 namespace: additional-network-1
 type: Raw
 rawCNIConfig: '{
 "cniVersion": "0.3.1",
 "name": "macvlan-vrf",
 "plugins": [1
 {
 "type": "macvlan",
 "master": "eth1",
 "ipam": {
 "type": "static",
 "addresses": [
 {
 "address": "191.168.1.23/24"
 }
]
 }
 }
],
 }'
```

```

 "type": "vrf", 2
 "vrfname": "vrf-1", 3
 "table": 1001 4
 }}
}'

```

- 1 **plugins** must be a list. The first item in the list must be the secondary network underpinning the VRF network. The second item in the list is the VRF plugin configuration.
- 2 **type** must be set to **vrf**.
- 3 **vrfname** is the name of the VRF that the interface is assigned to. If it does not exist in the pod, it is created.
- 4 Optional. **table** is the routing table ID. By default, the **tableid** parameter is used. If it is not specified, the CNI assigns a free routing table ID to the VRF.

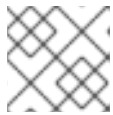

#### NOTE

VRF functions correctly only when the resource is of type **netdevice**.

2. Create the **Network** resource:

```
$ oc create -f additional-network-attachment.yaml
```

3. Confirm that the CNO created the **NetworkAttachmentDefinition** CR by running the following command. Replace **<namespace>** with the namespace that you specified when configuring the network attachment, for example, **additional-network-1**.

```
$ oc get network-attachment-definitions -n <namespace>
```

#### Example output

```

NAME AGE
additional-network-1 14m

```



#### NOTE

There might be a delay before the CNO creates the CR.

### Verification

1. Create a pod and assign it to the additional network with the VRF instance:
  - a. Create a YAML file that defines the **Pod** resource:

#### Example pod-additional-net.yaml file

```

apiVersion: v1
kind: Pod
metadata:
 name: pod-additional-net

```



```

annotations:
 k8s.v1.cni.cncf.io/networks: '[
 {
 "name": "test-network-1" 1
 }
]'
spec:
 containers:
 - name: example-pod-1
 command: ["/bin/bash", "-c", "sleep 9000000"]
 image: centos:8

```

- 1 Specify the name of the additional network with the VRF instance.

- b. Create the **Pod** resource by running the following command:

```
$ oc create -f pod-additional-net.yaml
```

### Example output

```
pod/test-pod created
```

2. Verify that the pod network attachment is connected to the VRF additional network. Start a remote session with the pod and run the following command:

```
$ ip vrf show
```

### Example output

```

Name Table

vrf-1 1001

```

3. Confirm that the VRF interface is the controller for the additional interface:

```
$ ip link
```

### Example output

```
5: net1: <BROADCAST,MULTICAST,UP,LOWER_UP> mtu 1500 qdisc noqueue master red
state UP mode
```

## CHAPTER 27. HARDWARE NETWORKS

### 27.1. ABOUT SINGLE ROOT I/O VIRTUALIZATION (SR-IOV) HARDWARE NETWORKS

The Single Root I/O Virtualization (SR-IOV) specification is a standard for a type of PCI device assignment that can share a single device with multiple pods.

SR-IOV can segment a compliant network device, recognized on the host node as a physical function (PF), into multiple virtual functions (VFs). The VF is used like any other network device. The SR-IOV network device driver for the device determines how the VF is exposed in the container:

- **netdevice** driver: A regular kernel network device in the **netns** of the container
- **vfio-pci** driver: A character device mounted in the container

You can use SR-IOV network devices with additional networks on your OpenShift Container Platform cluster installed on bare metal or Red Hat OpenStack Platform (RHOSP) infrastructure for applications that require high bandwidth or low latency.

You can configure multi-network policies for SR-IOV networks. The support for this is technology preview and SR-IOV additional networks are only supported with kernel NICs. They are not supported for Data Plane Development Kit (DPDK) applications.



#### NOTE

Creating multi-network policies on SR-IOV networks might not deliver the same performance to applications compared to SR-IOV networks without a multi-network policy configured.



#### IMPORTANT

Multi-network policies for SR-IOV network is a Technology Preview feature only. Technology Preview features are not supported with Red Hat production service level agreements (SLAs) and might not be functionally complete. Red Hat does not recommend using them in production. These features provide early access to upcoming product features, enabling customers to test functionality and provide feedback during the development process.

For more information about the support scope of Red Hat Technology Preview features, see [Technology Preview Features Support Scope](#).

You can enable SR-IOV on a node by using the following command:

```
$ oc label node <node_name> feature.node.kubernetes.io/network-sriov.capable="true"
```

#### 27.1.1. Components that manage SR-IOV network devices

The SR-IOV Network Operator creates and manages the components of the SR-IOV stack. It performs the following functions:

- Orchestrates discovery and management of SR-IOV network devices

- Generates **NetworkAttachmentDefinition** custom resources for the SR-IOV Container Network Interface (CNI)
- Creates and updates the configuration of the SR-IOV network device plugin
- Creates node specific **SriovNetworkNodeState** custom resources
- Updates the **spec.interfaces** field in each **SriovNetworkNodeState** custom resource

The Operator provisions the following components:

#### SR-IOV network configuration daemon

A daemon set that is deployed on worker nodes when the SR-IOV Network Operator starts. The daemon is responsible for discovering and initializing SR-IOV network devices in the cluster.

#### SR-IOV Network Operator webhook

A dynamic admission controller webhook that validates the Operator custom resource and sets appropriate default values for unset fields.

#### SR-IOV Network resources injector

A dynamic admission controller webhook that provides functionality for patching Kubernetes pod specifications with requests and limits for custom network resources such as SR-IOV VFs. The SR-IOV network resources injector adds the **resource** field to only the first container in a pod automatically.

#### SR-IOV network device plugin

A device plugin that discovers, advertises, and allocates SR-IOV network virtual function (VF) resources. Device plugins are used in Kubernetes to enable the use of limited resources, typically in physical devices. Device plugins give the Kubernetes scheduler awareness of resource availability, so that the scheduler can schedule pods on nodes with sufficient resources.

#### SR-IOV CNI plugin

A CNI plugin that attaches VF interfaces allocated from the SR-IOV network device plugin directly into a pod.

#### SR-IOV InfiniBand CNI plugin

A CNI plugin that attaches InfiniBand (IB) VF interfaces allocated from the SR-IOV network device plugin directly into a pod.



#### NOTE

The SR-IOV Network resources injector and SR-IOV Network Operator webhook are enabled by default and can be disabled by editing the **default SriovOperatorConfig** CR. Use caution when disabling the SR-IOV Network Operator Admission Controller webhook. You can disable the webhook under specific circumstances, such as troubleshooting, or if you want to use unsupported devices.

#### 27.1.1.1. Supported platforms

The SR-IOV Network Operator is supported on the following platforms:

- Bare metal
- Red Hat OpenStack Platform (RHOSP)

#### 27.1.1.2. Supported devices

OpenShift Container Platform supports the following network interface controllers:

**Table 27.1. Supported network interface controllers**

Manufacturer	Model	Vendor ID	Device ID
Broadcom	BCM57414	14e4	16d7
Broadcom	BCM57508	14e4	1750
Broadcom	BCM57504	14e4	1751
Intel	X710	8086	1572
Intel	X710 Backplane	8086	1581
Intel	X710 Base T	8086	15ff
Intel	XL710	8086	1583
Intel	XXV710	8086	158b
Intel	E810-CQDA2	8086	1592
Intel	E810-2CQDA2	8086	1592
Intel	E810-XXVDA2	8086	159b
Intel	E810-XXVDA4	8086	1593
Intel	E810-XXVDA4T	8086	1593
Mellanox	MT27700 Family [ConnectX-4]	15b3	1013
Mellanox	MT27710 Family [ConnectX-4 Lx]	15b3	1015
Mellanox	MT27800 Family [ConnectX-5]	15b3	1017
Mellanox	MT28880 Family [ConnectX-5 Ex]	15b3	1019
Mellanox	MT28908 Family [ConnectX-6]	15b3	101b
Mellanox	MT2892 Family [ConnectX-6 Dx]	15b3	101d
Mellanox	MT2894 Family [ConnectX-6 Lx]	15b3	101f
Mellanox	Mellanox MT2910 Family [ConnectX-7]	15b3	1021

Manufacturer	Model	Vendor ID	Device ID
Mellanox	MT42822 BlueField-2 in ConnectX-6 NIC mode	15b3	a2d6
Pensando <sup>[1]</sup>	DSC-25 dual-port 25G distributed services card for ionic driver	0x1dd8	0x1002
Pensando <sup>[1]</sup>	DSC-100 dual-port 100G distributed services card for ionic driver	0x1dd8	0x1003
Silicom	STS Family	8086	1591

1. OpenShift SR-IOV is supported, but you must set a static, Virtual Function (VF) media access control (MAC) address using the SR-IOV CNI config file when using SR-IOV.



## NOTE

For the most up-to-date list of supported cards and compatible OpenShift Container Platform versions available, see [OpenShift Single Root I/O Virtualization \(SR-IOV\) and PTP hardware networks Support Matrix](#).

### 27.1.1.3. Automated discovery of SR-IOV network devices

The SR-IOV Network Operator searches your cluster for SR-IOV capable network devices on worker nodes. The Operator creates and updates a `SriovNetworkNodeState` custom resource (CR) for each worker node that provides a compatible SR-IOV network device.

The CR is assigned the same name as the worker node. The **status.interfaces** list provides information about the network devices on a node.



## IMPORTANT

Do not modify a **`SriovNetworkNodeState`** object. The Operator creates and manages these resources automatically.

#### 27.1.1.3.1. Example `SriovNetworkNodeState` object

The following YAML is an example of a **`SriovNetworkNodeState`** object created by the SR-IOV Network Operator:

#### An `SriovNetworkNodeState` object

```
apiVersion: sriovnetwork.openshift.io/v1
kind: SriovNetworkNodeState
metadata:
 name: node-25 1
 namespace: openshift-sriov-network-operator
ownerReferences:
- apiVersion: sriovnetwork.openshift.io/v1
 blockOwnerDeletion: true
```

```

 controller: true
 kind: SriovNetworkNodePolicy
 name: default
spec:
 dpConfigVersion: "39824"
status:
 interfaces: 2
 - deviceID: "1017"
 driver: mlx5_core
 mtu: 1500
 name: ens785f0
 pciAddress: "0000:18:00.0"
 totalvfs: 8
 vendor: 15b3
 - deviceID: "1017"
 driver: mlx5_core
 mtu: 1500
 name: ens785f1
 pciAddress: "0000:18:00.1"
 totalvfs: 8
 vendor: 15b3
 - deviceID: 158b
 driver: i40e
 mtu: 1500
 name: ens817f0
 pciAddress: 0000:81:00.0
 totalvfs: 64
 vendor: "8086"
 - deviceID: 158b
 driver: i40e
 mtu: 1500
 name: ens817f1
 pciAddress: 0000:81:00.1
 totalvfs: 64
 vendor: "8086"
 - deviceID: 158b
 driver: i40e
 mtu: 1500
 name: ens803f0
 pciAddress: 0000:86:00.0
 totalvfs: 64
 vendor: "8086"
 syncStatus: Succeeded

```

- 1 The value of the **name** field is the same as the name of the worker node.
- 2 The **interfaces** stanza includes a list of all of the SR-IOV devices discovered by the Operator on the worker node.

#### 27.1.1.4. Example use of a virtual function in a pod

You can run a remote direct memory access (RDMA) or a Data Plane Development Kit (DPDK) application in a pod with SR-IOV VF attached.

This example shows a pod using a virtual function (VF) in RDMA mode:

## Pod spec that uses RDMA mode

```

apiVersion: v1
kind: Pod
metadata:
 name: rdma-app
 annotations:
 k8s.v1.cni.cncf.io/networks: sriov-rdma-mlnx
spec:
 containers:
 - name: testpmd
 image: <RDMA_image>
 imagePullPolicy: IfNotPresent
 securityContext:
 runAsUser: 0
 capabilities:
 add: ["IPC_LOCK", "SYS_RESOURCE", "NET_RAW"]
 command: ["sleep", "infinity"]

```

The following example shows a pod with a VF in DPDK mode:

## Pod spec that uses DPDK mode

```

apiVersion: v1
kind: Pod
metadata:
 name: dpdk-app
 annotations:
 k8s.v1.cni.cncf.io/networks: sriov-dpdk-net
spec:
 containers:
 - name: testpmd
 image: <DPDK_image>
 securityContext:
 runAsUser: 0
 capabilities:
 add: ["IPC_LOCK", "SYS_RESOURCE", "NET_RAW"]
 volumeMounts:
 - mountPath: /dev/hugepages
 name: hugepage
 resources:
 limits:
 memory: "1Gi"
 cpu: "2"
 hugepages-1Gi: "4Gi"
 requests:
 memory: "1Gi"
 cpu: "2"
 hugepages-1Gi: "4Gi"
 command: ["sleep", "infinity"]
 volumes:
 - name: hugepage
 emptyDir:
 medium: HugePages

```

### 27.1.1.5. DPDK library for use with container applications

An [optional library](#), **app-netutil**, provides several API methods for gathering network information about a pod from within a container running within that pod.

This library can assist with integrating SR-IOV virtual functions (VFs) in Data Plane Development Kit (DPDK) mode into the container. The library provides both a Golang API and a C API.

Currently there are three API methods implemented:

#### **GetCPUInfo()**

This function determines which CPUs are available to the container and returns the list.

#### **GetHugepages()**

This function determines the amount of huge page memory requested in the **Pod** spec for each container and returns the values.

#### **GetInterfaces()**

This function determines the set of interfaces in the container and returns the list. The return value includes the interface type and type-specific data for each interface.

The repository for the library includes a sample Dockerfile to build a container image, **dpdk-app-centos**. The container image can run one of the following DPDK sample applications, depending on an environment variable in the pod specification: **I2fwd**, **I3wd** or **testpmd**. The container image provides an example of integrating the **app-netutil** library into the container image itself. The library can also integrate into an init container. The init container can collect the required data and pass the data to an existing DPDK workload.

### 27.1.1.6. Huge pages resource injection for Downward API

When a pod specification includes a resource request or limit for huge pages, the Network Resources Injector automatically adds Downward API fields to the pod specification to provide the huge pages information to the container.

The Network Resources Injector adds a volume that is named **podnetinfo** and is mounted at **/etc/podnetinfo** for each container in the pod. The volume uses the Downward API and includes a file for huge pages requests and limits. The file naming convention is as follows:

- **/etc/podnetinfo/hugepages\_1G\_request\_<container-name>**
- **/etc/podnetinfo/hugepages\_1G\_limit\_<container-name>**
- **/etc/podnetinfo/hugepages\_2M\_request\_<container-name>**
- **/etc/podnetinfo/hugepages\_2M\_limit\_<container-name>**

The paths specified in the previous list are compatible with the **app-netutil** library. By default, the library is configured to search for resource information in the **/etc/podnetinfo** directory. If you choose to specify the Downward API path items yourself manually, the **app-netutil** library searches for the following paths in addition to the paths in the previous list.

- **/etc/podnetinfo/hugepages\_request**
- **/etc/podnetinfo/hugepages\_limit**
- **/etc/podnetinfo/hugepages\_1G\_request**



- `/etc/podnetinfo/hugepages_1G_limit`
- `/etc/podnetinfo/hugepages_2M_request`
- `/etc/podnetinfo/hugepages_2M_limit`

As with the paths that the Network Resources Injector can create, the paths in the preceding list can optionally end with a `_<container-name>` suffix.

### 27.1.2. Additional resources

- [Configuring multi-network policy](#)

### 27.1.3. Next steps

- [Installing the SR-IOV Network Operator](#)
- Optional: [Configuring the SR-IOV Network Operator](#)
- [Configuring an SR-IOV network device](#)
- If you use OpenShift Virtualization: [Connecting a virtual machine to an SR-IOV network](#)
- [Configuring an SR-IOV network attachment](#)
- [Adding a pod to an SR-IOV additional network](#)

## 27.2. INSTALLING THE SR-IOV NETWORK OPERATOR

You can install the Single Root I/O Virtualization (SR-IOV) Network Operator on your cluster to manage SR-IOV network devices and network attachments.

### 27.2.1. Installing the SR-IOV Network Operator

As a cluster administrator, you can install the Single Root I/O Virtualization (SR-IOV) Network Operator by using the OpenShift Container Platform CLI or the web console.

#### 27.2.1.1. CLI: Installing the SR-IOV Network Operator

As a cluster administrator, you can install the Operator using the CLI.

#### Prerequisites

- A cluster installed on bare-metal hardware with nodes that have hardware that supports SR-IOV.
- Install the OpenShift CLI (**oc**).
- An account with **cluster-admin** privileges.

#### Procedure

1. To create the **openshift-sriov-network-operator** namespace, enter the following command:

```
$ cat << EOF | oc create -f -
apiVersion: v1
kind: Namespace
metadata:
 name: openshift-sriov-network-operator
 annotations:
 workload.openshift.io/allowed: management
EOF
```

- To create an OperatorGroup CR, enter the following command:

```
$ cat << EOF | oc create -f -
apiVersion: operators.coreos.com/v1
kind: OperatorGroup
metadata:
 name: sriov-network-operators
 namespace: openshift-sriov-network-operator
spec:
 targetNamespaces:
 - openshift-sriov-network-operator
EOF
```

- To create a Subscription CR for the SR-IOV Network Operator, enter the following command:

```
$ cat << EOF | oc create -f -
apiVersion: operators.coreos.com/v1alpha1
kind: Subscription
metadata:
 name: sriov-network-operator-subscription
 namespace: openshift-sriov-network-operator
spec:
 channel: stable
 name: sriov-network-operator
 source: redhat-operators
 sourceNamespace: openshift-marketplace
EOF
```

- To verify that the Operator is installed, enter the following command:

```
$ oc get csv -n openshift-sriov-network-operator \
-o custom-columns=Name:.metadata.name,Phase:.status.phase
```

### Example output

```
Name Phase
sriov-network-operator.4.15.0-202310121402 Succeeded
```

## 27.2.1.2. Web console: Installing the SR-IOV Network Operator

As a cluster administrator, you can install the Operator using the web console.

### Prerequisites

- A cluster installed on bare-metal hardware with nodes that have hardware that supports SR-IOV.
- Install the OpenShift CLI (**oc**).
- An account with **cluster-admin** privileges.

## Procedure

1. Install the SR-IOV Network Operator:
  - a. In the OpenShift Container Platform web console, click **Operators** → **OperatorHub**.
  - b. Select **SR-IOV Network Operator** from the list of available Operators, and then click **Install**.
  - c. On the **Install Operator** page, under **Installed Namespace**, select **Operator recommended Namespace**.
  - d. Click **Install**.
2. Verify that the SR-IOV Network Operator is installed successfully:
  - a. Navigate to the **Operators** → **Installed Operators** page.
  - b. Ensure that **SR-IOV Network Operator** is listed in the **openshift-sriov-network-operator** project with a **Status** of **InstallSucceeded**.



### NOTE

During installation an Operator might display a **Failed** status. If the installation later succeeds with an **InstallSucceeded** message, you can ignore the **Failed** message.

If the Operator does not appear as installed, to troubleshoot further:

- Inspect the **Operator Subscriptions** and **Install Plans** tabs for any failure or errors under **Status**.
- Navigate to the **Workloads** → **Pods** page and check the logs for pods in the **openshift-sriov-network-operator** project.
- Check the namespace of the YAML file. If the annotation is missing, you can add the annotation **workload.openshift.io/allowed=management** to the Operator namespace with the following command:

```
$ oc annotate ns/openshift-sriov-network-operator
workload.openshift.io/allowed=management
```



### NOTE

For single-node OpenShift clusters, the annotation **workload.openshift.io/allowed=management** is required for the namespace.

## 27.2.2. Next steps

- Optional: [Configuring the SR-IOV Network Operator](#)

## 27.3. CONFIGURING THE SR-IOV NETWORK OPERATOR

The Single Root I/O Virtualization (SR-IOV) Network Operator manages the SR-IOV network devices and network attachments in your cluster.

### 27.3.1. Configuring the SR-IOV Network Operator



#### IMPORTANT

Modifying the SR-IOV Network Operator configuration is not normally necessary. The default configuration is recommended for most use cases. Complete the steps to modify the relevant configuration only if the default behavior of the Operator is not compatible with your use case.

The SR-IOV Network Operator adds the **SriovOperatorConfig.sriovnetwork.openshift.io** CustomResourceDefinition resource. The Operator automatically creates a SriovOperatorConfig custom resource (CR) named **default** in the **openshift-sriov-network-operator** namespace.



#### NOTE

The **default** CR contains the SR-IOV Network Operator configuration for your cluster. To change the Operator configuration, you must modify this CR.

#### 27.3.1.1. SR-IOV Network Operator config custom resource

The fields for the **sriovoperatorconfig** custom resource are described in the following table:

Table 27.2. SR-IOV Network Operator config custom resource

Field	Type	Description
<b>metadata.name</b>	<b>string</b>	Specifies the name of the SR-IOV Network Operator instance. The default value is <b>default</b> . Do not set a different value.
<b>metadata.name space</b>	<b>string</b>	Specifies the namespace of the SR-IOV Network Operator instance. The default value is <b>openshift-sriov-network-operator</b> . Do not set a different value.
<b>spec.configDaemonNodeSelector</b>	<b>string</b>	Specifies the node selection to control scheduling the SR-IOV Network Config Daemon on selected nodes. By default, this field is not set and the Operator deploys the SR-IOV Network Config daemon set on worker nodes.

Field	Type	Description
<b>spec.disableDrain</b>	<b>boolean</b>	Specifies whether to disable the node draining process or enable the node draining process when you apply a new policy to configure the NIC on a node. Setting this field to <b>true</b> facilitates software development and installing OpenShift Container Platform on a single node. By default, this field is not set.  For single-node clusters, set this field to <b>true</b> after installing the Operator. This field must remain set to <b>true</b> .
<b>spec.enableInjector</b>	<b>boolean</b>	Specifies whether to enable or disable the Network Resources Injector daemon set. By default, this field is set to <b>true</b> .
<b>spec.enableOperatorWebhook</b>	<b>boolean</b>	Specifies whether to enable or disable the Operator Admission Controller webhook daemon set. By default, this field is set to <b>true</b> .
<b>spec.logLevel</b>	<b>integer</b>	Specifies the log verbosity level of the Operator. Set to <b>0</b> to show only the basic logs. Set to <b>2</b> to show all the available logs. By default, this field is set to <b>2</b> .

### 27.3.1.2. About the Network Resources Injector

The Network Resources Injector is a Kubernetes Dynamic Admission Controller application. It provides the following capabilities:

- Mutation of resource requests and limits in a pod specification to add an SR-IOV resource name according to an SR-IOV network attachment definition annotation.
- Mutation of a pod specification with a Downward API volume to expose pod annotations, labels, and huge pages requests and limits. Containers that run in the pod can access the exposed information as files under the **/etc/podnetinfo** path.

By default, the Network Resources Injector is enabled by the SR-IOV Network Operator and runs as a daemon set on all control plane nodes. The following is an example of Network Resources Injector pods running in a cluster with three control plane nodes:

```
$ oc get pods -n openshift-sriov-network-operator
```

#### Example output

```
NAME READY STATUS RESTARTS AGE
network-resources-injector-5cz5p 1/1 Running 0 10m
network-resources-injector-dwqpx 1/1 Running 0 10m
network-resources-injector-lktz5 1/1 Running 0 10m
```

### 27.3.1.3. About the SR-IOV Network Operator admission controller webhook

The SR-IOV Network Operator Admission Controller webhook is a Kubernetes Dynamic Admission Controller application. It provides the following capabilities:

- Validation of the **SriovNetworkNodePolicy** CR when it is created or updated.
- Mutation of the **SriovNetworkNodePolicy** CR by setting the default value for the **priority** and **deviceType** fields when the CR is created or updated.

By default the SR-IOV Network Operator Admission Controller webhook is enabled by the Operator and runs as a daemon set on all control plane nodes.



## NOTE

Use caution when disabling the SR-IOV Network Operator Admission Controller webhook. You can disable the webhook under specific circumstances, such as troubleshooting, or if you want to use unsupported devices. For information about configuring unsupported devices, see [Configuring the SR-IOV Network Operator to use an unsupported NIC](#).

The following is an example of the Operator Admission Controller webhook pods running in a cluster with three control plane nodes:

```
$ oc get pods -n openshift-sriov-network-operator
```

### Example output

NAME	READY	STATUS	RESTARTS	AGE
operator-webhook-9jkw6	1/1	Running	0	16m
operator-webhook-kbr5p	1/1	Running	0	16m
operator-webhook-rpfrl	1/1	Running	0	16m

#### 27.3.1.4. About custom node selectors

The SR-IOV Network Config daemon discovers and configures the SR-IOV network devices on cluster nodes. By default, it is deployed to all the **worker** nodes in the cluster. You can use node labels to specify on which nodes the SR-IOV Network Config daemon runs.

#### 27.3.1.5. Disabling or enabling the Network Resources Injector

To disable or enable the Network Resources Injector, which is enabled by default, complete the following procedure.

##### Prerequisites

- Install the OpenShift CLI (**oc**).
- Log in as a user with **cluster-admin** privileges.
- You must have installed the SR-IOV Network Operator.

##### Procedure

- Set the **enableInjector** field. Replace **<value>** with **false** to disable the feature or **true** to enable the feature.

```
$ oc patch sriovoperatorconfig default \
 --type=merge -n openshift-sriov-network-operator \
 --patch '{ "spec": { "enableInjector": <value> } }'
```

### TIP

You can alternatively apply the following YAML to update the Operator:

```
apiVersion: sriovnetwork.openshift.io/v1
kind: SriovOperatorConfig
metadata:
 name: default
 namespace: openshift-sriov-network-operator
spec:
 enableInjector: <value>
```

#### 27.3.1.6. Disabling or enabling the SR-IOV Network Operator admission controller webhook

To disable or enable the admission controller webhook, which is enabled by default, complete the following procedure.

#### Prerequisites

- Install the OpenShift CLI (**oc**).
- Log in as a user with **cluster-admin** privileges.
- You must have installed the SR-IOV Network Operator.

#### Procedure

- Set the **enableOperatorWebhook** field. Replace **<value>** with **false** to disable the feature or **true** to enable it:

```
$ oc patch sriovoperatorconfig default --type=merge \
 -n openshift-sriov-network-operator \
 --patch '{ "spec": { "enableOperatorWebhook": <value> } }'
```

### TIP

You can alternatively apply the following YAML to update the Operator:

```
apiVersion: sriovnetwork.openshift.io/v1
kind: SriovOperatorConfig
metadata:
 name: default
 namespace: openshift-sriov-network-operator
spec:
 enableOperatorWebhook: <value>
```

#### 27.3.1.7. Configuring a custom NodeSelector for the SR-IOV Network Config daemon

The SR-IOV Network Config daemon discovers and configures the SR-IOV network devices on cluster nodes. By default, it is deployed to all the **worker** nodes in the cluster. You can use node labels to specify on which nodes the SR-IOV Network Config daemon runs.

To specify the nodes where the SR-IOV Network Config daemon is deployed, complete the following procedure.



### IMPORTANT

When you update the **configDaemonNodeSelector** field, the SR-IOV Network Config daemon is recreated on each selected node. While the daemon is recreated, cluster users are unable to apply any new SR-IOV Network node policy or create new SR-IOV pods.

### Procedure

- To update the node selector for the operator, enter the following command:

```
$ oc patch sriovoperatorconfig default --type=json \
-n openshift-sriov-network-operator \
--patch '{
 "op": "replace",
 "path": "/spec/configDaemonNodeSelector",
 "value": {<node_label>}
}'
```

Replace **<node\_label>** with a label to apply as in the following example: **"node-role.kubernetes.io/worker": ""**.

### TIP

You can alternatively apply the following YAML to update the Operator:

```
apiVersion: sriovnetwork.openshift.io/v1
kind: SriovOperatorConfig
metadata:
 name: default
 namespace: openshift-sriov-network-operator
spec:
 configDaemonNodeSelector:
 <node_label>
```

#### 27.3.1.8. Configuring the SR-IOV Network Operator for single node installations

By default, the SR-IOV Network Operator drains workloads from a node before every policy change. The Operator performs this action to ensure that there no workloads using the virtual functions before the reconfiguration.

For installations on a single node, there are no other nodes to receive the workloads. As a result, the Operator must be configured not to drain the workloads from the single node.





## IMPORTANT

After performing the following procedure to disable draining workloads, you must remove any workload that uses an SR-IOV network interface before you change any SR-IOV network node policy.

### Prerequisites

- Install the OpenShift CLI (**oc**).
- Log in as a user with **cluster-admin** privileges.
- You must have installed the SR-IOV Network Operator.

### Procedure

- To set the **disableDrain** field to **true**, enter the following command:

```
$ oc patch sriovoperatorconfig default --type=merge \
-n openshift-sriov-network-operator \
--patch '{ "spec": { "disableDrain": true } }'
```

### TIP

You can alternatively apply the following YAML to update the Operator:

```
apiVersion: sriovnetwork.openshift.io/v1
kind: SriovOperatorConfig
metadata:
 name: default
 namespace: openshift-sriov-network-operator
spec:
 disableDrain: true
```

#### 27.3.1.9. Deploying the SR-IOV Operator for hosted control planes



## IMPORTANT

Hosted control planes on the AWS platform is a Technology Preview feature only. Technology Preview features are not supported with Red Hat production service level agreements (SLAs) and might not be functionally complete. Red Hat does not recommend using them in production. These features provide early access to upcoming product features, enabling customers to test functionality and provide feedback during the development process.

For more information about the support scope of Red Hat Technology Preview features, see [Technology Preview Features Support Scope](#).

After you configure and deploy your hosting service cluster, you can create a subscription to the SR-IOV Operator on a hosted cluster. The SR-IOV pod runs on worker machines rather than the control plane.

### Prerequisites

You must configure and deploy the hosted cluster on AWS. For more information, see [Configuring the hosting cluster on AWS \(Technology Preview\)](#).

## Procedure

1. Create a namespace and an Operator group:

```
apiVersion: v1
kind: Namespace
metadata:
 name: openshift-sriov-network-operator

apiVersion: operators.coreos.com/v1
kind: OperatorGroup
metadata:
 name: sriov-network-operators
 namespace: openshift-sriov-network-operator
spec:
 targetNamespaces:
 - openshift-sriov-network-operator
```

2. Create a subscription to the SR-IOV Operator:

```
apiVersion: operators.coreos.com/v1alpha1
kind: Subscription
metadata:
 name: sriov-network-operator-subscription
 namespace: openshift-sriov-network-operator
spec:
 channel: stable
 name: sriov-network-operator
 config:
 nodeSelector:
 node-role.kubernetes.io/worker: ""
 source: s/qe-app-registry/redhat-operators
 sourceNamespace: openshift-marketplace
```

## Verification

1. To verify that the SR-IOV Operator is ready, run the following command and view the resulting output:

```
$ oc get csv -n openshift-sriov-network-operator
```

### Example output

```
NAME DISPLAY VERSION REPLACES
PHASE
sriov-network-operator.4.15.0-202211021237 SR-IOV Network Operator 4.15.0-
202211021237 sriov-network-operator.4.15.0-202210290517 Succeeded
```

2. To verify that the SR-IOV pods are deployed, run the following command:

```
$ oc get pods -n openshift-sriov-network-operator
```

## 27.3.2. Next steps

- [Configuring an SR-IOV network device](#)

## 27.4. CONFIGURING AN SR-IOV NETWORK DEVICE

You can configure a Single Root I/O Virtualization (SR-IOV) device in your cluster.

### 27.4.1. SR-IOV network node configuration object

You specify the SR-IOV network device configuration for a node by creating an SR-IOV network node policy. The API object for the policy is part of the **sriovnetwork.openshift.io** API group.

The following YAML describes an SR-IOV network node policy:

```

apiVersion: sriovnetwork.openshift.io/v1
kind: SriovNetworkNodePolicy
metadata:
 name: <name> 1
 namespace: openshift-sriov-network-operator 2
spec:
 resourceName: <sriov_resource_name> 3
 nodeSelector:
 feature.node.kubernetes.io/network-sriov.capable: "true" 4
 priority: <priority> 5
 mtu: <mtu> 6
 needVhostNet: false 7
 numVfs: <num> 8
 externallyManaged: false 9
 nicSelector: 10
 vendor: "<vendor_code>" 11
 deviceID: "<device_id>" 12
 pfNames: ["<pf_name>", ...] 13
 rootDevices: ["<pci_bus_id>", ...] 14
 netFilter: "<filter_string>" 15
 deviceType: <device_type> 16
 isRdma: false 17
 linkType: <link_type> 18
 eSwitchMode: "switchdev" 19
 excludeTopology: false 20

```

- 1 The name for the custom resource object.
- 2 The namespace where the SR-IOV Network Operator is installed.
- 3 The resource name of the SR-IOV network device plugin. You can create multiple SR-IOV network node policies for a resource name.

When specifying a name, be sure to use the accepted syntax expression **^[a-zA-Z0-9\_]+\$** in the **resourceName**.

4

The node selector specifies the nodes to configure. Only SR-IOV network devices on the selected nodes are configured. The SR-IOV Container Network Interface (CNI) plugin and device plugin are



### IMPORTANT

The SR-IOV Network Operator applies node network configuration policies to nodes in sequence. Before applying node network configuration policies, the SR-IOV Network Operator checks if the machine config pool (MCP) for a node is in an unhealthy state such as **Degraded** or **Updating**. If a node is in an unhealthy MCP, the process of applying node network configuration policies to all targeted nodes in the cluster pauses until the MCP returns to a healthy state.

To avoid a node in an unhealthy MCP from blocking the application of node network configuration policies to other nodes, including nodes in other MCPs, you must create a separate node network configuration policy for each MCP.

- 5 Optional: The priority is an integer value between **0** and **99**. A smaller value receives higher priority. For example, a priority of **10** is a higher priority than **99**. The default value is **99**.
- 6 Optional: The maximum transmission unit (MTU) of the virtual function. The maximum MTU value can vary for different network interface controller (NIC) models.
- 7 Optional: Set **needVhostNet** to **true** to mount the **/dev/vhost-net** device in the pod. Use the mounted **/dev/vhost-net** device with Data Plane Development Kit (DPDK) to forward traffic to the kernel network stack.
- 8 The number of the virtual functions (VF) to create for the SR-IOV physical network device. For an Intel network interface controller (NIC), the number of VFs cannot be larger than the total VFs supported by the device. For a Mellanox NIC, the number of VFs cannot be larger than **128**.
- 9 Set **externallyManaged** to **true** to allow the SR-IOV Network Operator to use all or a subset of externally managed virtual functions (VFs) and attach them to pods. With the value set to **false** the SR-IOV Network Operator manages and configures all allocated VFs.



### NOTE

When **externallyManaged** is set to **true**, you must create the Virtual Functions (VFs) before applying the policy. If not, the webhook will block the request. If **externallyManaged** is set to **false**, the SR-IOV Network Operator handles the creation and management of VFs, including resetting them if necessary. Therefore to use VFs on the host system they must be created manually and **externallyManaged** must be set to **true** so the SR-IOV Network Operator will not take any actions on the PF and the VFs that are not defined in the policy **nicSelector**.

- 10 The NIC selector identifies the device for the Operator to configure. You do not have to specify values for all the parameters. It is recommended to identify the network device with enough precision to avoid selecting a device unintentionally.

If you specify **rootDevices**, you must also specify a value for **vendor**, **deviceID**, or **pfNames**. If you specify both **pfNames** and **rootDevices** at the same time, ensure that they refer to the same device. If you specify a value for **netFilter**, then you do not need to specify any other parameter because a network ID is unique.

- 11 Optional: The vendor hexadecimal code of the SR-IOV network device. The only allowed values are

- 12 Optional: The device hexadecimal code of the SR-IOV network device. For example, **101b** is the device ID for a Mellanox ConnectX-6 device.
- 13 Optional: An array of one or more physical function (PF) names for the device.
- 14 Optional: An array of one or more PCI bus addresses for the PF of the device. Provide the address in the following format: **0000:02:00.1**.
- 15 Optional: The platform-specific network filter. The only supported platform is Red Hat OpenStack Platform (RHOSP). Acceptable values use the following format: **openstack/NetworkID:xxxxxxxx-xxxx-xxxx-xxxx-xxxxxxxxxxxx**. Replace **xxxxxxxx-xxxx-xxxx-xxxx-xxxxxxxxxxxx** with the value from the **/var/config/openstack/latest/network\_data.json** metadata file.
- 16 Optional: The driver type for the virtual functions. The only allowed values are **netdevice** and **vfio-pci**. The default value is **netdevice**.

For a Mellanox NIC to work in DPDK mode on bare metal nodes, use the **netdevice** driver type and set **isRdma** to **true**.

- 17 Optional: Configures whether to enable remote direct memory access (RDMA) mode. The default value is **false**.

If the **isRdma** parameter is set to **true**, you can continue to use the RDMA-enabled VF as a normal network device. A device can be used in either mode.

Set **isRdma** to **true** and additionally set **needVhostNet** to **true** to configure a Mellanox NIC for use with Fast Datapath DPDK applications.

- 18 Optional: The link type for the VFs. The default value is **eth** for Ethernet. Change this value to 'ib' for InfiniBand.

When **linkType** is set to **ib**, **isRdma** is automatically set to **true** by the SR-IOV Network Operator webhook. When **linkType** is set to **ib**, **deviceType** should not be set to **vfio-pci**.

Do not set **linkType** to **eth** for **SriovNetworkNodePolicy**, because this can lead to an incorrect number of available devices reported by the device plugin.

- 19 Optional: To enable hardware offloading, the **eSwitchMode** field must be set to **"switchdev"**.
- 20 Optional: To exclude advertising an SR-IOV network resource's NUMA node to the Topology Manager, set the value to **true**. The default value is **false**.

### 27.4.1.1. SR-IOV network node configuration examples

The following example describes the configuration for an InfiniBand device:

#### Example configuration for an InfiniBand device

```
apiVersion: sriovnetwork.openshift.io/v1
kind: SriovNetworkNodePolicy
metadata:
 name: policy-ib-net-1
 namespace: openshift-sriov-network-operator
spec:
 resourceName: ibnic1
 nodeSelector:
```

```

feature.node.kubernetes.io/network-sriov.capable: "true"
numVfs: 4
nicSelector:
 vendor: "15b3"
 deviceID: "101b"
 rootDevices:
 - "0000:19:00.0"
linkType: ib
isRdma: true

```

The following example describes the configuration for an SR-IOV network device in a RHOSP virtual machine:

### Example configuration for an SR-IOV device in a virtual machine

```

apiVersion: sriovnetwork.openshift.io/v1
kind: SriovNetworkNodePolicy
metadata:
 name: policy-sriov-net-openstack-1
 namespace: openshift-sriov-network-operator
spec:
 resourceName: sriovnic1
 nodeSelector:
 feature.node.kubernetes.io/network-sriov.capable: "true"
 numVfs: 1 1
 nicSelector:
 vendor: "15b3"
 deviceID: "101b"
 netFilter: "openstack/NetworkID:ea24bd04-8674-4f69-b0ee-fa0b3bd20509" 2

```

- 1** The **numVfs** field is always set to **1** when configuring the node network policy for a virtual machine.
- 2** The **netFilter** field must refer to a network ID when the virtual machine is deployed on RHOSP. Valid values for **netFilter** are available from an **SriovNetworkNodeState** object.

#### 27.4.1.2. Virtual function (VF) partitioning for SR-IOV devices

In some cases, you might want to split virtual functions (VFs) from the same physical function (PF) into multiple resource pools. For example, you might want some of the VFs to load with the default driver and the remaining VFs load with the **vfiopci** driver. In such a deployment, the **pfNames** selector in your **SriovNetworkNodePolicy** custom resource (CR) can be used to specify a range of VFs for a pool using the following format: **<pfname>#<first\_vf>-<last\_vf>**.

For example, the following YAML shows the selector for an interface named **netpf0** with VF **2** through **7**:

```
pfNames: ["netpf0#2-7"]
```

- **netpf0** is the PF interface name.
- **2** is the first VF index (0-based) that is included in the range.
- **7** is the last VF index (0-based) that is included in the range.

You can select VFs from the same PF by using different policy CRs if the following requirements are met:

- The **numVfs** value must be identical for policies that select the same PF.
- The VF index must be in the range of **0** to **<numVfs>-1**. For example, if you have a policy with **numVfs** set to **8**, then the **<first\_vf>** value must not be smaller than **0**, and the **<last\_vf>** must not be larger than **7**.
- The VFs ranges in different policies must not overlap.
- The **<first\_vf>** must not be larger than the **<last\_vf>**.

The following example illustrates NIC partitioning for an SR-IOV device.

The policy **policy-net-1** defines a resource pool **net-1** that contains the VF **0** of PF **netpf0** with the default VF driver. The policy **policy-net-1-dpdk** defines a resource pool **net-1-dpdk** that contains the VF **8** to **15** of PF **netpf0** with the **vfio** VF driver.

Policy **policy-net-1**:

```
apiVersion: sriovnetwork.openshift.io/v1
kind: SriovNetworkNodePolicy
metadata:
 name: policy-net-1
 namespace: openshift-sriov-network-operator
spec:
 resourceName: net1
 nodeSelector:
 feature.node.kubernetes.io/network-sriov.capable: "true"
 numVfs: 16
 nicSelector:
 pfNames: ["netpf0#0-0"]
 deviceType: netdevice
```

Policy **policy-net-1-dpdk**:

```
apiVersion: sriovnetwork.openshift.io/v1
kind: SriovNetworkNodePolicy
metadata:
 name: policy-net-1-dpdk
 namespace: openshift-sriov-network-operator
spec:
 resourceName: net1 dpdk
 nodeSelector:
 feature.node.kubernetes.io/network-sriov.capable: "true"
 numVfs: 16
 nicSelector:
 pfNames: ["netpf0#8-15"]
 deviceType: vfio-pci
```

### Verifying that the interface is successfully partitioned

Confirm that the interface partitioned to virtual functions (VFs) for the SR-IOV device by running the following command.

```
$ ip link show <interface> 1
```

- 1 Replace **<interface>** with the interface that you specified when partitioning to VFs for the SR-IOV device, for example, **ens3f1**.

### Example output

```
5: ens3f1: <BROADCAST,MULTICAST,UP,LOWER_UP> mtu 1500 qdisc mq state UP mode
DEFAULT group default qlen 1000
link/ether 3c:fd:fe:d1:bc:01 brd ff:ff:ff:ff:ff:ff
```

```
vf 0 link/ether 5a:e7:88:25:ea:a0 brd ff:ff:ff:ff:ff:ff, spoof checking on, link-state auto, trust off
vf 1 link/ether 3e:1d:36:d7:3d:49 brd ff:ff:ff:ff:ff:ff, spoof checking on, link-state auto, trust off
vf 2 link/ether ce:09:56:97:df:f9 brd ff:ff:ff:ff:ff:ff, spoof checking on, link-state auto, trust off
vf 3 link/ether 5e:91:cf:88:d1:38 brd ff:ff:ff:ff:ff:ff, spoof checking on, link-state auto, trust off
vf 4 link/ether e6:06:a1:96:2f:de brd ff:ff:ff:ff:ff:ff, spoof checking on, link-state auto, trust off
```

## 27.4.2. Configuring SR-IOV network devices

The SR-IOV Network Operator adds the **SriovNetworkNodePolicy.sriovnetwork.openshift.io** CustomResourceDefinition to OpenShift Container Platform. You can configure an SR-IOV network device by creating a SriovNetworkNodePolicy custom resource (CR).



### NOTE

When applying the configuration specified in a **SriovNetworkNodePolicy** object, the SR-IOV Operator might drain the nodes, and in some cases, reboot nodes.

It might take several minutes for a configuration change to apply.

### Prerequisites

- You installed the OpenShift CLI (**oc**).
- You have access to the cluster as a user with the **cluster-admin** role.
- You have installed the SR-IOV Network Operator.
- You have enough available nodes in your cluster to handle the evicted workload from drained nodes.
- You have not selected any control plane nodes for SR-IOV network device configuration.

### Procedure

1. Create an **SriovNetworkNodePolicy** object, and then save the YAML in the **<name>-sriov-node-network.yaml** file. Replace **<name>** with the name for this configuration.
2. Optional: Label the SR-IOV capable cluster nodes with **SriovNetworkNodePolicy.Spec.NodeSelector** if they are not already labeled. For more information about labeling nodes, see "Understanding how to update labels on nodes".
3. Create the **SriovNetworkNodePolicy** object:
  -



```
$ oc create -f <name>-sriov-node-network.yaml
```

where **<name>** specifies the name for this configuration.

After applying the configuration update, all the pods in **sriov-network-operator** namespace transition to the **Running** status.

4. To verify that the SR-IOV network device is configured, enter the following command. Replace **<node\_name>** with the name of a node with the SR-IOV network device that you just configured.

```
$ oc get sriovnetworknodestates -n openshift-sriov-network-operator <node_name> -o
jsonpath='{.status.syncStatus}'
```

### Additional resources

- [Understanding how to update labels on nodes](#) .

### 27.4.3. Troubleshooting SR-IOV configuration

After following the procedure to configure an SR-IOV network device, the following sections address some error conditions.

To display the state of nodes, run the following command:

```
$ oc get sriovnetworknodestates -n openshift-sriov-network-operator <node_name>
```

where: **<node\_name>** specifies the name of a node with an SR-IOV network device.

#### Error output: Cannot allocate memory

```
"lastSyncError": "write /sys/bus/pci/devices/0000:3b:00.1/sriov_numvfs: cannot allocate memory"
```

When a node indicates that it cannot allocate memory, check the following items:

- Confirm that global SR-IOV settings are enabled in the BIOS for the node.
- Confirm that VT-d is enabled in the BIOS for the node.

### 27.4.4. Assigning an SR-IOV network to a VRF

As a cluster administrator, you can assign an SR-IOV network interface to your VRF domain by using the CNI VRF plugin.

To do this, add the VRF configuration to the optional **metaPlugins** parameter of the **SriovNetwork** resource.

**NOTE**

Applications that use VRFs need to bind to a specific device. The common usage is to use the **SO\_BINDTODEVICE** option for a socket. **SO\_BINDTODEVICE** binds the socket to a device that is specified in the passed interface name, for example, **eth1**. To use **SO\_BINDTODEVICE**, the application must have **CAP\_NET\_RAW** capabilities.

Using a VRF through the **ip vrf exec** command is not supported in OpenShift Container Platform pods. To use VRF, bind applications directly to the VRF interface.

#### 27.4.4.1. Creating an additional SR-IOV network attachment with the CNI VRF plugin

The SR-IOV Network Operator manages additional network definitions. When you specify an additional SR-IOV network to create, the SR-IOV Network Operator creates the **NetworkAttachmentDefinition** custom resource (CR) automatically.

**NOTE**

Do not edit **NetworkAttachmentDefinition** custom resources that the SR-IOV Network Operator manages. Doing so might disrupt network traffic on your additional network.

To create an additional SR-IOV network attachment with the CNI VRF plugin, perform the following procedure.

#### Prerequisites

- Install the OpenShift Container Platform CLI (oc).
- Log in to the OpenShift Container Platform cluster as a user with cluster-admin privileges.

#### Procedure

1. Create the **SriovNetwork** custom resource (CR) for the additional SR-IOV network attachment and insert the **metaPlugins** configuration, as in the following example CR. Save the YAML as the file **sriov-network-attachment.yaml**.

```
apiVersion: sriovnetwork.openshift.io/v1
kind: SriovNetwork
metadata:
 name: example-network
 namespace: additional-sriov-network-1
spec:
 ipam: |
 {
 "type": "host-local",
 "subnet": "10.56.217.0/24",
 "rangeStart": "10.56.217.171",
 "rangeEnd": "10.56.217.181",
 "routes": [{
 "dst": "0.0.0.0/0"
 }],
 "gateway": "10.56.217.1"
 }
 vlan: 0
 resourceName: intelNics
```

```
metaPlugins : |
 {
 "type": "vrf", ❶
 "vrfname": "example-vrf-name" ❷
 }
```

- ❶ **type** must be set to **vrf**.
- ❷ **vrfname** is the name of the VRF that the interface is assigned to. If it does not exist in the pod, it is created.

2. Create the **SriovNetwork** resource:

```
$ oc create -f sriov-network-attachment.yaml
```

### Verifying that the **NetworkAttachmentDefinition** CR is successfully created

- Confirm that the SR-IOV Network Operator created the **NetworkAttachmentDefinition** CR by running the following command.

```
$ oc get network-attachment-definitions -n <namespace> ❶
```

- ❶ Replace **<namespace>** with the namespace that you specified when configuring the network attachment, for example, **additional-sriov-network-1**.

### Example output

```
NAME AGE
additional-sriov-network-1 14m
```



### NOTE

There might be a delay before the SR-IOV Network Operator creates the CR.

### Verifying that the additional SR-IOV network attachment is successful

To verify that the VRF CNI is correctly configured and the additional SR-IOV network attachment is attached, do the following:

1. Create an SR-IOV network that uses the VRF CNI.
2. Assign the network to a pod.
3. Verify that the pod network attachment is connected to the SR-IOV additional network. Remote shell into the pod and run the following command:

```
$ ip vrf show
```

### Example output

Name	Table
red	10

4. Confirm the VRF interface is master of the secondary interface:

```
$ ip link
```

### Example output

```
...
5: net1: <BROADCAST,MULTICAST,UP,LOWER_UP> mtu 1500 qdisc noqueue master red
state UP mode
...
```

## 27.4.5. Exclude the SR-IOV network topology for NUMA-aware scheduling

You can exclude advertising the Non-Uniform Memory Access (NUMA) node for the SR-IOV network to the Topology Manager for more flexible SR-IOV network deployments during NUMA-aware pod scheduling.

In some scenarios, it is a priority to maximize CPU and memory resources for a pod on a single NUMA node. By not providing a hint to the Topology Manager about the NUMA node for the pod's SR-IOV network resource, the Topology Manager can deploy the SR-IOV network resource and the pod CPU and memory resources to different NUMA nodes. This can add to network latency because of the data transfer between NUMA nodes. However, it is acceptable in scenarios when workloads require optimal CPU and memory performance.

For example, consider a compute node, **compute-1**, that features two NUMA nodes: **numa0** and **numa1**. The SR-IOV-enabled NIC is present on **numa0**. The CPUs available for pod scheduling are present on **numa1** only. By setting the **excludeTopology** specification to **true**, the Topology Manager can assign CPU and memory resources for the pod to **numa1** and can assign the SR-IOV network resource for the same pod to **numa0**. This is only possible when you set the **excludeTopology** specification to **true**. Otherwise, the Topology Manager attempts to place all resources on the same NUMA node.

### 27.4.5.1. Excluding the SR-IOV network topology for NUMA-aware scheduling

To exclude advertising the SR-IOV network resource's Non-Uniform Memory Access (NUMA) node to the Topology Manager, you can configure the **excludeTopology** specification in the **SriovNetworkNodePolicy** custom resource. Use this configuration for more flexible SR-IOV network deployments during NUMA-aware pod scheduling.

#### Prerequisites

- You have installed the OpenShift CLI (**oc**).
- You have configured the CPU Manager policy to **static**. For more information about CPU Manager, see the *Additional resources* section.
- You have configured the Topology Manager policy to **single-numa-node**.
- You have installed the SR-IOV Network Operator.

## Procedure

1. Create the **SriovNetworkNodePolicy** CR:
  - a. Save the following YAML in the **sriov-network-node-policy.yaml** file, replacing values in the YAML to match your environment:

```

apiVersion: sriovnetwork.openshift.io/v1
kind: SriovNetworkNodePolicy
metadata:
 name: <policy_name>
 namespace: openshift-sriov-network-operator
spec:
 resourceName: sriovnuma0 1
 nodeSelector:
 kubernetes.io/hostname: <node_name>
 numVfs: <number_of_Vfs>
 nicSelector: 2
 vendor: "<vendor_ID>"
 deviceID: "<device_ID>"
 deviceType: netdevice
 excludeTopology: true 3

```

- 1** The resource name of the SR-IOV network device plugin. This YAML uses a sample **resourceName** value.
- 2** Identify the device for the Operator to configure by using the NIC selector.
- 3** To exclude advertising the NUMA node for the SR-IOV network resource to the Topology Manager, set the value to **true**. The default value is **false**.



### NOTE

If multiple **SriovNetworkNodePolicy** resources target the same SR-IOV network resource, the **SriovNetworkNodePolicy** resources must have the same value as the **excludeTopology** specification. Otherwise, the conflicting policy is rejected.

- b. Create the **SriovNetworkNodePolicy** resource by running the following command:

```
$ oc create -f sriov-network-node-policy.yaml
```

### Example output

```
sriovnetworknodepolicy.sriovnetwork.openshift.io/policy-for-numa-0 created
```

2. Create the **SriovNetwork** CR:
  - a. Save the following YAML in the **sriov-network.yaml** file, replacing values in the YAML to match your environment:

```

apiVersion: sriovnetwork.openshift.io/v1
kind: SriovNetwork

```

```

metadata:
 name: sriov-numa-0-network ❶
 namespace: openshift-sriov-network-operator
spec:
 resourceName: sriovnuma0 ❷
 networkNamespace: <namespace> ❸
 ipam: |- ❹
 {
 "type": "<ipam_type>",
 }

```

- ❶ Replace **sriov-numa-0-network** with the name for the SR-IOV network resource.
- ❷ Specify the resource name for the **SriovNetworkNodePolicy** CR from the previous step. This YAML uses a sample **resourceName** value.
- ❸ Enter the namespace for your SR-IOV network resource.
- ❹ Enter the IP address management configuration for the SR-IOV network.

b. Create the **SriovNetwork** resource by running the following command:

```
$ oc create -f sriov-network.yaml
```

#### Example output

```
sriovnetwork.sriovnetwork.openshift.io/sriov-numa-0-network created
```

3. Create a pod and assign the SR-IOV network resource from the previous step:

a. Save the following YAML in the **sriov-network-pod.yaml** file, replacing values in the YAML to match your environment:

```

apiVersion: v1
kind: Pod
metadata:
 name: <pod_name>
 annotations:
 k8s.v1.cni.cncf.io/networks: |-
 [
 {
 "name": "sriov-numa-0-network", ❶
 }
]
spec:
 containers:
 - name: <container_name>
 image: <image>
 imagePullPolicy: IfNotPresent
 command: ["sleep", "infinity"]

```

- ❶ This is the name of the **SriovNetwork** resource that uses the **SriovNetworkNodePolicy** resource.

- b. Create the **Pod** resource by running the following command:

```
$ oc create -f sriov-network-pod.yaml
```

### Example output

```
pod/example-pod created
```

## Verification

1. Verify the status of the pod by running the following command, replacing **<pod\_name>** with the name of the pod:

```
$ oc get pod <pod_name>
```

### Example output

```
NAME READY STATUS RESTARTS AGE
test-deployment-sriov-76cbbf4756-k9v72 1/1 Running 0 45h
```

2. Open a debug session with the target pod to verify that the SR-IOV network resources are deployed to a different node than the memory and CPU resources.
  - a. Open a debug session with the pod by running the following command, replacing **<pod\_name>** with the target pod name.

```
$ oc debug pod/<pod_name>
```

- b. Set **/host** as the root directory within the debug shell. The debug pod mounts the root file system from the host in **/host** within the pod. By changing the root directory to **/host**, you can run binaries from the host file system:

```
$ chroot /host
```

- c. View information about the CPU allocation by running the following commands:

```
$ lscpu | grep NUMA
```

### Example output

```
NUMA node(s): 2
NUMA node0 CPU(s): 0,2,4,6,8,10,12,14,16,18,...
NUMA node1 CPU(s): 1,3,5,7,9,11,13,15,17,19,...
```

```
$ cat /proc/self/status | grep Cpus
```

### Example output

```
Cpus_allowed: aa
Cpus_allowed_list: 1,3,5,7
```

```
$ cat /sys/class/net/net1/device/numa_node
```

### Example output

```
0
```

In this example, CPUs 1,3,5, and 7 are allocated to **NUMA node1** but the SR-IOV network resource can use the NIC in **NUMA node0**.



### NOTE

If the **excludeTopology** specification is set to **True**, it is possible that the required resources exist in the same NUMA node.

### Additional resources

- [Using CPU Manager](#)

### 27.4.6. Next steps

- [Configuring an SR-IOV network attachment](#)

## 27.5. CONFIGURING AN SR-IOV ETHERNET NETWORK ATTACHMENT

You can configure an Ethernet network attachment for an Single Root I/O Virtualization (SR-IOV) device in the cluster.

### 27.5.1. Ethernet device configuration object

You can configure an Ethernet network device by defining an **SriovNetwork** object.

The following YAML describes an **SriovNetwork** object:

```
apiVersion: sriovnetwork.openshift.io/v1
kind: SriovNetwork
metadata:
 name: <name> 1
 namespace: openshift-sriov-network-operator 2
spec:
 resourceName: <sriov_resource_name> 3
 networkNamespace: <target_namespace> 4
 vlan: <vlan> 5
 spoofChk: "<spoof_check>" 6
 ipam: |- 7
 {}
 linkState: <link_state> 8
 maxTxRate: <max_tx_rate> 9
 minTxRate: <min_tx_rate> 10
 vlanQoS: <vlan_qos> 11
 trust: "<trust_vf>" 12
 capabilities: <capabilities> 13
```



- 1 A name for the object. The SR-IOV Network Operator creates a **NetworkAttachmentDefinition** object with same name.
- 2 The namespace where the SR-IOV Network Operator is installed.
- 3 The value for the **spec.resourceName** parameter from the **SriovNetworkNodePolicy** object that defines the SR-IOV hardware for this additional network.
- 4 The target namespace for the **SriovNetwork** object. Only pods in the target namespace can attach to the additional network.
- 5 Optional: A Virtual LAN (VLAN) ID for the additional network. The integer value must be from **0** to **4095**. The default value is **0**.
- 6 Optional: The spoof check mode of the VF. The allowed values are the strings **"on"** and **"off"**.



### IMPORTANT

You must enclose the value you specify in quotes or the object is rejected by the SR-IOV Network Operator.

- 7 A configuration object for the IPAM CNI plugin as a YAML block scalar. The plugin manages IP address assignment for the attachment definition.
- 8 Optional: The link state of virtual function (VF). Allowed value are **enable**, **disable** and **auto**.
- 9 Optional: A maximum transmission rate, in Mbps, for the VF.
- 10 Optional: A minimum transmission rate, in Mbps, for the VF. This value must be less than or equal to the maximum transmission rate.



### NOTE

Intel NICs do not support the **minTxRate** parameter. For more information, see [BZ#1772847](#).

- 11 Optional: An IEEE 802.1p priority level for the VF. The default value is **0**.
- 12 Optional: The trust mode of the VF. The allowed values are the strings **"on"** and **"off"**.



### IMPORTANT

You must enclose the value that you specify in quotes, or the SR-IOV Network Operator rejects the object.

- 13 Optional: The capabilities to configure for this additional network. You can specify **'{ "ips": true }'** to enable IP address support or **'{ "mac": true }'** to enable MAC address support.

#### 27.5.1.1. Configuration of IP address assignment for an additional network

The IP address management (IPAM) Container Network Interface (CNI) plugin provides IP addresses for other CNI plugins.

You can use the following IP address assignment types:

- Static assignment.
- Dynamic assignment through a DHCP server. The DHCP server you specify must be reachable from the additional network.
- Dynamic assignment through the Whereabouts IPAM CNI plugin.

#### 27.5.1.1.1. Static IP address assignment configuration

The following table describes the configuration for static IP address assignment:

Table 27.3. `ipam` static configuration object

Field	Type	Description
<b>type</b>	<b>string</b>	The IPAM address type. The value <b>static</b> is required.
<b>addresses</b>	<b>array</b>	An array of objects specifying IP addresses to assign to the virtual interface. Both IPv4 and IPv6 IP addresses are supported.
<b>routes</b>	<b>array</b>	An array of objects specifying routes to configure inside the pod.
<b>dns</b>	<b>array</b>	Optional: An array of objects specifying the DNS configuration.

The **addresses** array requires objects with the following fields:

Table 27.4. `ipam.addresses[]` array

Field	Type	Description
<b>address</b>	<b>string</b>	An IP address and network prefix that you specify. For example, if you specify <b>10.10.21.10/24</b> , then the additional network is assigned an IP address of <b>10.10.21.10</b> and the netmask is <b>255.255.255.0</b> .
<b>gateway</b>	<b>string</b>	The default gateway to route egress network traffic to.

Table 27.5. `ipam.routes[]` array

Field	Type	Description
<b>dst</b>	<b>string</b>	The IP address range in CIDR format, such as <b>192.168.17.0/24</b> or <b>0.0.0.0/0</b> for the default route.
<b>gw</b>	<b>string</b>	The gateway where network traffic is routed.

Table 27.6. `ipam.dns` object

Field	Type	Description
<b>nameservers</b>	<b>array</b>	An array of one or more IP addresses for to send DNS queries to.
<b>domain</b>	<b>array</b>	The default domain to append to a hostname. For example, if the domain is set to <b>example.com</b> , a DNS lookup query for <b>example-host</b> is rewritten as <b>example-host.example.com</b> .
<b>search</b>	<b>array</b>	An array of domain names to append to an unqualified hostname, such as <b>example-host</b> , during a DNS lookup query.

### Static IP address assignment configuration example

```
{
 "ipam": {
 "type": "static",
 "addresses": [
 {
 "address": "191.168.1.7/24"
 }
]
 }
}
```

#### 27.5.1.1.2. Dynamic IP address (DHCP) assignment configuration

The following JSON describes the configuration for dynamic IP address address assignment with DHCP.

## RENEWAL OF DHCP LEASES

A pod obtains its original DHCP lease when it is created. The lease must be periodically renewed by a minimal DHCP server deployment running on the cluster.

The SR-IOV Network Operator does not create a DHCP server deployment; The Cluster Network Operator is responsible for creating the minimal DHCP server deployment.

To trigger the deployment of the DHCP server, you must create a shim network attachment by editing the Cluster Network Operator configuration, as in the following example:

### Example shim network attachment definition

```
apiVersion: operator.openshift.io/v1
kind: Network
metadata:
 name: cluster
spec:
 additionalNetworks:
 - name: dhcp-shim
 namespace: default
 type: Raw
 rawCNIConfig: |-
 {
 "name": "dhcp-shim",
 "cniVersion": "0.3.1",
 "type": "bridge",
 "ipam": {
 "type": "dhcp"
 }
 }
...
```

Table 27.7. ipam DHCP configuration object

Field	Type	Description
<b>type</b>	<b>string</b>	The IPAM address type. The value <b>dhcp</b> is required.

### Dynamic IP address (DHCP) assignment configuration example

```
{
 "ipam": {
 "type": "dhcp"
 }
}
```

#### 27.5.1.1.3. Dynamic IP address assignment configuration with Whereabouts

The Whereabouts CNI plugin allows the dynamic assignment of an IP address to an additional network without the use of a DHCP server.

The following table describes the configuration for dynamic IP address assignment with Whereabouts:

**Table 27.8. ipam whereabouts configuration object**

Field	Type	Description
<b>type</b>	<b>string</b>	The IPAM address type. The value <b>whereabouts</b> is required.
<b>range</b>	<b>string</b>	An IP address and range in CIDR notation. IP addresses are assigned from within this range of addresses.
<b>exclude</b>	<b>array</b>	Optional: A list of zero or more IP addresses and ranges in CIDR notation. IP addresses within an excluded address range are not assigned.

### Dynamic IP address assignment configuration example that uses Whereabouts

```
{
 "ipam": {
 "type": "whereabouts",
 "range": "192.0.2.192/27",
 "exclude": [
 "192.0.2.192/30",
 "192.0.2.196/32"
]
 }
}
```

#### 27.5.1.2. Creating a configuration for assignment of dual-stack IP addresses dynamically

Dual-stack IP address assignment can be configured with the **ipRanges** parameter for:

- IPv4 addresses
- IPv6 addresses
- multiple IP address assignment

#### Procedure

1. Set **type** to **whereabouts**.
2. Use **ipRanges** to allocate IP addresses as shown in the following example:

```
cniVersion: operator.openshift.io/v1
kind: Network
metadata:
 name: cluster
spec:
 additionalNetworks:
 - name: whereabouts-shim
 namespace: default
 type: Raw
```

```
rawCNIConfig: |-
 {
 "name": "whereabouts-dual-stack",
 "cniVersion": "0.3.1",
 "type": "bridge",
 "ipam": {
 "type": "whereabouts",
 "ipRanges": [
 {"range": "192.168.10.0/24"},
 {"range": "2001:db8::/64"}
]
 }
 }
}
```

3. Attach network to a pod. For more information, see "Adding a pod to an additional network".
4. Verify that all IP addresses are assigned.
5. Run the following command to ensure the IP addresses are assigned as metadata.

```
$ oc exec -it mypod -- ip a
```

#### Additional resources

- [Attaching a pod to an additional network](#)

### 27.5.2. Configuring SR-IOV additional network

You can configure an additional network that uses SR-IOV hardware by creating an **SriovNetwork** object. When you create an **SriovNetwork** object, the SR-IOV Network Operator automatically creates a **NetworkAttachmentDefinition** object.



#### NOTE

Do not modify or delete an **SriovNetwork** object if it is attached to any pods in a **running** state.

#### Prerequisites

- Install the OpenShift CLI (**oc**).
- Log in as a user with **cluster-admin** privileges.

#### Procedure

1. Create a **SriovNetwork** object, and then save the YAML in the **<name>.yaml** file, where **<name>** is a name for this additional network. The object specification might resemble the following example:

```
apiVersion: sriovnetwork.openshift.io/v1
kind: SriovNetwork
metadata:
 name: attach1
 namespace: openshift-sriov-network-operator
```

```
spec:
 resourceName: net1
 networkNamespace: project2
 ipam: |-
 {
 "type": "host-local",
 "subnet": "10.56.217.0/24",
 "rangeStart": "10.56.217.171",
 "rangeEnd": "10.56.217.181",
 "gateway": "10.56.217.1"
 }
}
```

- To create the object, enter the following command:

```
$ oc create -f <name>.yaml
```

where **<name>** specifies the name of the additional network.

- Optional: To confirm that the **NetworkAttachmentDefinition** object that is associated with the **SriovNetwork** object that you created in the previous step exists, enter the following command. Replace **<namespace>** with the networkNamespace you specified in the **SriovNetwork** object.

```
$ oc get net-attach-def -n <namespace>
```

### 27.5.3. Next steps

- [Adding a pod to an SR-IOV additional network](#)

### 27.5.4. Additional resources

- [Configuring an SR-IOV network device](#)

## 27.6. CONFIGURING AN SR-IOV INFINIBAND NETWORK ATTACHMENT

You can configure an InfiniBand (IB) network attachment for an Single Root I/O Virtualization (SR-IOV) device in the cluster.

### 27.6.1. InfiniBand device configuration object

You can configure an InfiniBand (IB) network device by defining an **SriovIBNetwork** object.

The following YAML describes an **SriovIBNetwork** object:

```
apiVersion: sriovnetwork.openshift.io/v1
kind: SriovIBNetwork
metadata:
 name: <name> 1
 namespace: openshift-sriov-network-operator 2
spec:
 resourceName: <sriov_resource_name> 3
 networkNamespace: <target_namespace> 4
 ipam: |- 5
```

```

{}
linkState: <link_state> 6
capabilities: <capabilities> 7

```

- 1 A name for the object. The SR-IOV Network Operator creates a **NetworkAttachmentDefinition** object with same name.
- 2 The namespace where the SR-IOV Operator is installed.
- 3 The value for the **spec.resourceName** parameter from the **SriovNetworkNodePolicy** object that defines the SR-IOV hardware for this additional network.
- 4 The target namespace for the **SriovIBNetwork** object. Only pods in the target namespace can attach to the network device.
- 5 Optional: A configuration object for the IPAM CNI plugin as a YAML block scalar. The plugin manages IP address assignment for the attachment definition.
- 6 Optional: The link state of virtual function (VF). Allowed values are **enable**, **disable** and **auto**.
- 7 Optional: The capabilities to configure for this network. You can specify **'{ "ips": true }'** to enable IP address support or **'{ "infinibandGUID": true }'** to enable IB Global Unique Identifier (GUID) support.

### 27.6.1.1. Configuration of IP address assignment for an additional network

The IP address management (IPAM) Container Network Interface (CNI) plugin provides IP addresses for other CNI plugins.

You can use the following IP address assignment types:

- Static assignment.
- Dynamic assignment through a DHCP server. The DHCP server you specify must be reachable from the additional network.
- Dynamic assignment through the Whereabouts IPAM CNI plugin.

#### 27.6.1.1.1. Static IP address assignment configuration

The following table describes the configuration for static IP address assignment:

**Table 27.9. ipam static configuration object**

Field	Type	Description
<b>type</b>	<b>string</b>	The IPAM address type. The value <b>static</b> is required.
<b>addresses</b>	<b>array</b>	An array of objects specifying IP addresses to assign to the virtual interface. Both IPv4 and IPv6 IP addresses are supported.
<b>routes</b>	<b>array</b>	An array of objects specifying routes to configure inside the pod.



Field	Type	Description
<b>dns</b>	<b>array</b>	Optional: An array of objects specifying the DNS configuration.

The **addresses** array requires objects with the following fields:

Table 27.10. **ipam.addresses[]** array

Field	Type	Description
<b>address</b>	<b>string</b>	An IP address and network prefix that you specify. For example, if you specify <b>10.10.21.10/24</b> , then the additional network is assigned an IP address of <b>10.10.21.10</b> and the netmask is <b>255.255.255.0</b> .
<b>gateway</b>	<b>string</b>	The default gateway to route egress network traffic to.

Table 27.11. **ipam.routes[]** array

Field	Type	Description
<b>dst</b>	<b>string</b>	The IP address range in CIDR format, such as <b>192.168.17.0/24</b> or <b>0.0.0.0/0</b> for the default route.
<b>gw</b>	<b>string</b>	The gateway where network traffic is routed.

Table 27.12. **ipam.dns** object

Field	Type	Description
<b>nameservers</b>	<b>array</b>	An array of one or more IP addresses for to send DNS queries to.
<b>domain</b>	<b>array</b>	The default domain to append to a hostname. For example, if the domain is set to <b>example.com</b> , a DNS lookup query for <b>example-host</b> is rewritten as <b>example-host.example.com</b> .
<b>search</b>	<b>array</b>	An array of domain names to append to an unqualified hostname, such as <b>example-host</b> , during a DNS lookup query.

### Static IP address assignment configuration example

```
{
 "ipam": {
 "type": "static",
 "addresses": [
 {
 "address": "191.168.1.7/24"
 }
]
 }
}
```

```

]
}
}

```

### 27.6.1.1.2. Dynamic IP address (DHCP) assignment configuration

The following JSON describes the configuration for dynamic IP address address assignment with DHCP.

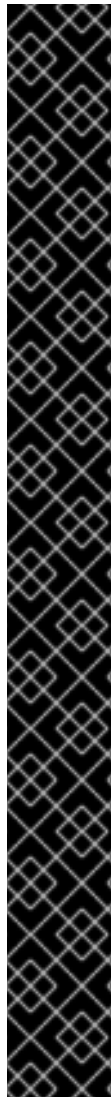

#### RENEWAL OF DHCP LEASES

A pod obtains its original DHCP lease when it is created. The lease must be periodically renewed by a minimal DHCP server deployment running on the cluster.

To trigger the deployment of the DHCP server, you must create a shim network attachment by editing the Cluster Network Operator configuration, as in the following example:

#### Example shim network attachment definition

```

apiVersion: operator.openshift.io/v1
kind: Network
metadata:
 name: cluster
spec:
 additionalNetworks:
 - name: dhcp-shim
 namespace: default
 type: Raw
 rawCNIConfig: |-
 {
 "name": "dhcp-shim",
 "cniVersion": "0.3.1",
 "type": "bridge",
 "ipam": {
 "type": "dhcp"
 }
 }
 # ...

```

Table 27.13. ipam DHCP configuration object

Field	Type	Description
<b>type</b>	<b>string</b>	The IPAM address type. The value <b>dhcp</b> is required.

#### Dynamic IP address (DHCP) assignment configuration example

```

{
 "ipam": {
 "type": "dhcp"
 }
}

```

### 27.6.1.1.3. Dynamic IP address assignment configuration with Whereabouts

The Whereabouts CNI plugin allows the dynamic assignment of an IP address to an additional network without the use of a DHCP server.

The following table describes the configuration for dynamic IP address assignment with Whereabouts:

**Table 27.14. ipam whereabouts configuration object**

Field	Type	Description
<b>type</b>	<b>string</b>	The IPAM address type. The value <b>whereabouts</b> is required.
<b>range</b>	<b>string</b>	An IP address and range in CIDR notation. IP addresses are assigned from within this range of addresses.
<b>exclude</b>	<b>array</b>	Optional: A list of zero or more IP addresses and ranges in CIDR notation. IP addresses within an excluded address range are not assigned.

### Dynamic IP address assignment configuration example that uses Whereabouts

```
{
 "ipam": {
 "type": "whereabouts",
 "range": "192.0.2.192/27",
 "exclude": [
 "192.0.2.192/30",
 "192.0.2.196/32"
]
 }
}
```

### 27.6.1.2. Creating a configuration for assignment of dual-stack IP addresses dynamically

Dual-stack IP address assignment can be configured with the **ipRanges** parameter for:

- IPv4 addresses
- IPv6 addresses
- multiple IP address assignment

#### Procedure

1. Set **type** to **whereabouts**.
2. Use **ipRanges** to allocate IP addresses as shown in the following example:

```
cniVersion: operator.openshift.io/v1
kind: Network
=metadata:
 name: cluster
```

```

spec:
 additionalNetworks:
 - name: whereabouts-shim
 namespace: default
 type: Raw
 rawCNIConfig: |-
 {
 "name": "whereabouts-dual-stack",
 "cniVersion": "0.3.1",
 "type": "bridge",
 "ipam": {
 "type": "whereabouts",
 "ipRanges": [
 {"range": "192.168.10.0/24"},
 {"range": "2001:db8::/64"}
]
 }
 }

```

3. Attach network to a pod. For more information, see "Adding a pod to an additional network".
4. Verify that all IP addresses are assigned.
5. Run the following command to ensure the IP addresses are assigned as metadata.

```
$ oc exec -it mypod -- ip a
```

#### Additional resources

- [Attaching a pod to an additional network](#)

### 27.6.2. Configuring SR-IOV additional network

You can configure an additional network that uses SR-IOV hardware by creating an **SriovIBNetwork** object. When you create an **SriovIBNetwork** object, the SR-IOV Network Operator automatically creates a **NetworkAttachmentDefinition** object.

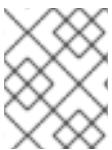

#### NOTE

Do not modify or delete an **SriovIBNetwork** object if it is attached to any pods in a **running** state.

#### Prerequisites

- Install the OpenShift CLI (**oc**).
- Log in as a user with **cluster-admin** privileges.

#### Procedure

1. Create a **SriovIBNetwork** object, and then save the YAML in the **<name>.yaml** file, where **<name>** is a name for this additional network. The object specification might resemble the following example:

```

apiVersion: sriovnetwork.openshift.io/v1
kind: SriovIBNetwork
metadata:
 name: attach1
 namespace: openshift-sriov-network-operator
spec:
 resourceName: net1
 networkNamespace: project2
 ipam: |-
 {
 "type": "host-local",
 "subnet": "10.56.217.0/24",
 "rangeStart": "10.56.217.171",
 "rangeEnd": "10.56.217.181",
 "gateway": "10.56.217.1"
 }

```

2. To create the object, enter the following command:

```
$ oc create -f <name>.yaml
```

where **<name>** specifies the name of the additional network.

3. Optional: To confirm that the **NetworkAttachmentDefinition** object that is associated with the **SriovIBNetwork** object that you created in the previous step exists, enter the following command. Replace **<namespace>** with the networkNamespace you specified in the **SriovIBNetwork** object.

```
$ oc get net-attach-def -n <namespace>
```

### 27.6.3. Next steps

- [Adding a pod to an SR-IOV additional network](#)

### 27.6.4. Additional resources

- [Configuring an SR-IOV network device](#)

## 27.7. ADDING A POD TO AN SR-IOV ADDITIONAL NETWORK

You can add a pod to an existing Single Root I/O Virtualization (SR-IOV) network.

### 27.7.1. Runtime configuration for a network attachment

When attaching a pod to an additional network, you can specify a runtime configuration to make specific customizations for the pod. For example, you can request a specific MAC hardware address.

You specify the runtime configuration by setting an annotation in the pod specification. The annotation key is **k8s.v1.cni.cncf.io/networks**, and it accepts a JSON object that describes the runtime configuration.

#### 27.7.1.1. Runtime configuration for an Ethernet-based SR-IOV attachment

The following JSON describes the runtime configuration options for an Ethernet-based SR-IOV network attachment.

```
[
 {
 "name": "<name>", 1
 "mac": "<mac_address>", 2
 "ips": ["<cidr_range>"] 3
 }
]
```

- 1 The name of the SR-IOV network attachment definition CR.
- 2 Optional: The MAC address for the SR-IOV device that is allocated from the resource type defined in the SR-IOV network attachment definition CR. To use this feature, you also must specify { **"mac": true** } in the **SriovNetwork** object.
- 3 Optional: IP addresses for the SR-IOV device that is allocated from the resource type defined in the SR-IOV network attachment definition CR. Both IPv4 and IPv6 addresses are supported. To use this feature, you also must specify { **"ips": true** } in the **SriovNetwork** object.

### Example runtime configuration

```
apiVersion: v1
kind: Pod
metadata:
 name: sample-pod
 annotations:
 k8s.v1.cni.cncf.io/networks: |-
 [
 {
 "name": "net1",
 "mac": "20:04:0f:f1:88:01",
 "ips": ["192.168.10.1/24", "2001::1/64"]
 }
]
spec:
 containers:
 - name: sample-container
 image: <image>
 imagePullPolicy: IfNotPresent
 command: ["sleep", "infinity"]
```

#### 27.7.1.2. Runtime configuration for an InfiniBand-based SR-IOV attachment

The following JSON describes the runtime configuration options for an InfiniBand-based SR-IOV network attachment.

```
[
 {
 "name": "<network_attachment>", 1
 "infiniband-guid": "<guid>", 2
 }
]
```

```
"ips": ["<cidr_range>"] 3
}
]
```

- 1 The name of the SR-IOV network attachment definition CR.
- 2 The InfiniBand GUID for the SR-IOV device. To use this feature, you also must specify { **"infinibandGUID": true** } in the **SriovIBNetwork** object.
- 3 The IP addresses for the SR-IOV device that is allocated from the resource type defined in the SR-IOV network attachment definition CR. Both IPv4 and IPv6 addresses are supported. To use this feature, you also must specify { **"ips": true** } in the **SriovIBNetwork** object.

### Example runtime configuration

```
apiVersion: v1
kind: Pod
metadata:
 name: sample-pod
 annotations:
 k8s.v1.cni.cncf.io/networks: |-
 [
 {
 "name": "ib1",
 "infiniband-guid": "c2:11:22:33:44:55:66:77",
 "ips": ["192.168.10.1/24", "2001::1/64"]
 }
]
spec:
 containers:
 - name: sample-container
 image: <image>
 imagePullPolicy: IfNotPresent
 command: ["sleep", "infinity"]
```

#### 27.7.2. Adding a pod to an additional network

You can add a pod to an additional network. The pod continues to send normal cluster-related network traffic over the default network.

When a pod is created additional networks are attached to it. However, if a pod already exists, you cannot attach additional networks to it.

The pod must be in the same namespace as the additional network.



## NOTE

The SR-IOV Network Resource Injector adds the **resource** field to the first container in a pod automatically.

If you are using an Intel network interface controller (NIC) in Data Plane Development Kit (DPDK) mode, only the first container in your pod is configured to access the NIC. Your SR-IOV additional network is configured for DPDK mode if the **deviceType** is set to **vfio-pci** in the **SriovNetworkNodePolicy** object.

You can work around this issue by either ensuring that the container that needs access to the NIC is the first container defined in the **Pod** object or by disabling the Network Resource Injector. For more information, see [BZ#1990953](#).

## Prerequisites

- Install the OpenShift CLI (**oc**).
- Log in to the cluster.
- Install the SR-IOV Operator.
- Create either an **SriovNetwork** object or an **SriovIBNetwork** object to attach the pod to.

## Procedure

1. Add an annotation to the **Pod** object. Only one of the following annotation formats can be used:
  - a. To attach an additional network without any customization, add an annotation with the following format. Replace **<network>** with the name of the additional network to associate with the pod:

```
metadata:
 annotations:
 k8s.v1.cni.cncf.io/networks: <network>[,<network>,...] 1
```

- 1** To specify more than one additional network, separate each network with a comma. Do not include whitespace between the comma. If you specify the same additional network multiple times, that pod will have multiple network interfaces attached to that network.

- b. To attach an additional network with customizations, add an annotation with the following format:

```
metadata:
 annotations:
 k8s.v1.cni.cncf.io/networks: |-
 [
 {
 "name": "<network>", 1
 "namespace": "<namespace>", 2
 "default-route": ["<default-route>"] 3
 }
]
```



- 1 Specify the name of the additional network defined by a **NetworkAttachmentDefinition** object.
- 2 Specify the namespace where the **NetworkAttachmentDefinition** object is defined.
- 3 Optional: Specify an override for the default route, such as **192.168.17.1**.

2. To create the pod, enter the following command. Replace **<name>** with the name of the pod.

```
$ oc create -f <name>.yaml
```

3. Optional: To Confirm that the annotation exists in the **Pod** CR, enter the following command, replacing **<name>** with the name of the pod.

```
$ oc get pod <name> -o yaml
```

In the following example, the **example-pod** pod is attached to the **net1** additional network:

```
$ oc get pod example-pod -o yaml
apiVersion: v1
kind: Pod
metadata:
 annotations:
 k8s.v1.cni.cncf.io/networks: macvlan-bridge
 k8s.v1.cni.cncf.io/network-status: |- 1
 [
 {
 "name": "openshift-sdn",
 "interface": "eth0",
 "ips": [
 "10.128.2.14"
],
 "default": true,
 "dns": {}
 },
 {
 "name": "macvlan-bridge",
 "interface": "net1",
 "ips": [
 "20.2.2.100"
],
 "mac": "22:2f:60:a5:f8:00",
 "dns": {}
 }
]
 name: example-pod
 namespace: default
spec:
 ...
status:
 ...
```

- 1 The **k8s.v1.cni.cncf.io/network-status** parameter is a JSON array of objects. Each object describes the status of an additional network attached to the pod. The annotation value is stored as a plain text value.

### 27.7.3. Creating a non-uniform memory access (NUMA) aligned SR-IOV pod

You can create a NUMA aligned SR-IOV pod by restricting SR-IOV and the CPU resources allocated from the same NUMA node with **restricted** or **single-numa-node** Topology Manager policies.

#### Prerequisites

- You have installed the OpenShift CLI (**oc**).
- You have configured the CPU Manager policy to **static**. For more information on CPU Manager, see the "Additional resources" section.
- You have configured the Topology Manager policy to **single-numa-node**.



#### NOTE

When **single-numa-node** is unable to satisfy the request, you can configure the Topology Manager policy to **restricted**. For more flexible SR-IOV network resource scheduling, see *Excluding SR-IOV network topology during NUMA-aware scheduling* in the *Additional resources* section.

#### Procedure

1. Create the following SR-IOV pod spec, and then save the YAML in the **<name>-sriov-pod.yaml** file. Replace **<name>** with a name for this pod.

The following example shows an SR-IOV pod spec:

```
apiVersion: v1
kind: Pod
metadata:
 name: sample-pod
 annotations:
 k8s.v1.cni.cncf.io/networks: <name> 1
spec:
 containers:
 - name: sample-container
 image: <image> 2
 command: ["sleep", "infinity"]
 resources:
 limits:
 memory: "1Gi" 3
 cpu: "2" 4
 requests:
 memory: "1Gi"
 cpu: "2"
```

- 1** Replace **<name>** with the name of the SR-IOV network attachment definition CR.
- 2** Replace **<image>** with the name of the **sample-pod** image.
- 3** To create the SR-IOV pod with guaranteed QoS, set **memory limits** equal to **memory requests**.
- 4** To create the SR-IOV pod with guaranteed QoS, set **cpu limits** equals to **cpu requests**.

2. Create the sample SR-IOV pod by running the following command:

```
$ oc create -f <filename> 1
```

- 1 Replace **<filename>** with the name of the file you created in the previous step.

3. Confirm that the **sample-pod** is configured with guaranteed QoS.

```
$ oc describe pod sample-pod
```

4. Confirm that the **sample-pod** is allocated with exclusive CPUs.

```
$ oc exec sample-pod -- cat /sys/fs/cgroup/cpuset/cpuset.cpus
```

5. Confirm that the SR-IOV device and CPUs that are allocated for the **sample-pod** are on the same NUMA node.

```
$ oc exec sample-pod -- cat /sys/fs/cgroup/cpuset/cpuset.cpus
```

#### 27.7.4. A test pod template for clusters that use SR-IOV on OpenStack

The following **testpmd** pod demonstrates container creation with huge pages, reserved CPUs, and the SR-IOV port.

##### An example **testpmd** pod

```
apiVersion: v1
kind: Pod
metadata:
 name: testpmd-sriov
 namespace: mynamespace
 annotations:
 cpu-load-balancing.crio.io: "disable"
 cpu-quota.crio.io: "disable"
...
spec:
 containers:
 - name: testpmd
 command: ["sleep", "999999"]
 image: registry.redhat.io/openshift4/dpdk-base-rhel8:v4.9
 securityContext:
 capabilities:
 add: ["IPC_LOCK", "SYS_ADMIN"]
 privileged: true
 runAsUser: 0
 resources:
 requests:
 memory: 1000Mi
 hugepages-1Gi: 1Gi
 cpu: '2'
 openshift.io/sriov1: 1
 limits:
 hugepages-1Gi: 1Gi
```

```

cpu: '2'
memory: 1000Mi
openshift.io/sriov1: 1
volumeMounts:
- mountPath: /dev/hugepages
 name: hugepage
 readOnly: False
runtimeClassName: performance-cnf-performanceprofile 1
volumes:
- name: hugepage
 emptyDir:
 medium: HugePages

```

**1** This example assumes that the name of the performance profile is **cnf-performance profile**.

### 27.7.5. Additional resources

- [Configuring an SR-IOV Ethernet network attachment](#)
- [Configuring an SR-IOV InfiniBand network attachment](#)
- [Using CPU Manager](#)
- [Exclude SR-IOV network topology for NUMA-aware scheduling](#)

## 27.8. CONFIGURING INTERFACE-LEVEL NETWORK SYSCTL SETTINGS AND ALL-MULTICAST MODE FOR SR-IOV NETWORKS

As a cluster administrator, you can change interface-level network sysctls and several interface attributes such as promiscuous mode, all-multicast mode, MTU, and MAC address by using the tuning Container Network Interface (CNI) meta plugin for a pod connected to a SR-IOV network device.

### 27.8.1. Labeling nodes with an SR-IOV enabled NIC

If you want to enable SR-IOV on only SR-IOV capable nodes there are a couple of ways to do this:

1. Install the Node Feature Discovery (NFD) Operator. NFD detects the presence of SR-IOV enabled NICs and labels the nodes with **node.alpha.kubernetes-incubator.io/nfd-network-sriov.capable = true**.
2. Examine the **SriovNetworkNodeState** CR for each node. The **interfaces** stanza includes a list of all of the SR-IOV devices discovered by the SR-IOV Network Operator on the worker node. Label each node with **feature.node.kubernetes.io/network-sriov.capable: "true"** by using the following command:

```
$ oc label node <node_name> feature.node.kubernetes.io/network-sriov.capable="true"
```

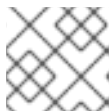

#### NOTE

You can label the nodes with whatever name you want.

### 27.8.2. Setting one sysctl flag

You can set interface-level network **sysctl** settings for a pod connected to a SR-IOV network device.

In this example, **net.ipv4.conf.IFNAME.accept\_redirects** is set to **1** on the created virtual interfaces.

The **sysctl-tuning-test** is a namespace used in this example.

- Use the following command to create the **sysctl-tuning-test** namespace:

```
$ oc create namespace sysctl-tuning-test
```

### 27.8.2.1. Setting one sysctl flag on nodes with SR-IOV network devices

The SR-IOV Network Operator adds the **SriovNetworkNodePolicy.sriovnetwork.openshift.io** custom resource definition (CRD) to OpenShift Container Platform. You can configure an SR-IOV network device by creating a **SriovNetworkNodePolicy** custom resource (CR).



#### NOTE

When applying the configuration specified in a **SriovNetworkNodePolicy** object, the SR-IOV Operator might drain and reboot the nodes.

It can take several minutes for a configuration change to apply.

Follow this procedure to create a **SriovNetworkNodePolicy** custom resource (CR).

#### Procedure

1. Create an **SriovNetworkNodePolicy** custom resource (CR). For example, save the following YAML as the file **policyoneflag-sriov-node-network.yaml**:

```
apiVersion: sriovnetwork.openshift.io/v1
kind: SriovNetworkNodePolicy
metadata:
 name: policyoneflag 1
 namespace: openshift-sriov-network-operator 2
spec:
 resourceName: policyoneflag 3
 nodeSelector: 4
 feature.node.kubernetes.io/network-sriov.capable="true"
 priority: 10 5
 numVfs: 5 6
 nicSelector: 7
 pfNames: ["ens5"] 8
 deviceType: "netdevice" 9
 isRdma: false 10
```

- 1 The name for the custom resource object.
- 2 The namespace where the SR-IOV Network Operator is installed.
- 3 The resource name of the SR-IOV network device plugin. You can create multiple SR-IOV network node policies for a resource name.

- 4 The node selector specifies the nodes to configure. Only SR-IOV network devices on the selected nodes are configured. The SR-IOV Container Network Interface (CNI) plugin and
- 5 Optional: The priority is an integer value between **0** and **99**. A smaller value receives higher priority. For example, a priority of **10** is a higher priority than **99**. The default value is **99**.
- 6 The number of the virtual functions (VFs) to create for the SR-IOV physical network device. For an Intel network interface controller (NIC), the number of VFs cannot be larger than the total VFs supported by the device. For a Mellanox NIC, the number of VFs cannot be larger than **128**.
- 7 The NIC selector identifies the device for the Operator to configure. You do not have to specify values for all the parameters. It is recommended to identify the network device with enough precision to avoid selecting a device unintentionally. If you specify **rootDevices**, you must also specify a value for **vendor**, **deviceID**, or **pfNames**. If you specify both **pfNames** and **rootDevices** at the same time, ensure that they refer to the same device. If you specify a value for **netFilter**, then you do not need to specify any other parameter because a network ID is unique.
- 8 Optional: An array of one or more physical function (PF) names for the device.
- 9 Optional: The driver type for the virtual functions. The only allowed value is **netdevice**. For a Mellanox NIC to work in DPDK mode on bare metal nodes, set **isRdma** to **true**.
- 10 Optional: Configures whether to enable remote direct memory access (RDMA) mode. The default value is **false**. If the **isRdma** parameter is set to **true**, you can continue to use the RDMA-enabled VF as a normal network device. A device can be used in either mode. Set **isRdma** to **true** and additionally set **needVhostNet** to **true** to configure a Mellanox NIC for use with Fast Datapath DPDK applications.

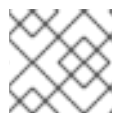
**NOTE**

The **vfiopci** driver type is not supported.

2. Create the **SriovNetworkNodePolicy** object:

```
$ oc create -f policyoneflag-sriov-node-network.yaml
```

After applying the configuration update, all the pods in **sriov-network-operator** namespace change to the **Running** status.

3. To verify that the SR-IOV network device is configured, enter the following command. Replace **<node\_name>** with the name of a node with the SR-IOV network device that you just configured.

```
$ oc get sriovnetworknodestates -n openshift-sriov-network-operator <node_name> -o jsonpath='{.status.syncStatus}'
```

**Example output**

```
Succeeded
```

### 27.8.2.2. Configuring sysctl on a SR-IOV network

You can set interface specific **sysctl** settings on virtual interfaces created by SR-IOV by adding the tuning configuration to the optional **metaPlugins** parameter of the **SriovNetwork** resource.

The SR-IOV Network Operator manages additional network definitions. When you specify an additional SR-IOV network to create, the SR-IOV Network Operator creates the **NetworkAttachmentDefinition** custom resource (CR) automatically.



## NOTE

Do not edit **NetworkAttachmentDefinition** custom resources that the SR-IOV Network Operator manages. Doing so might disrupt network traffic on your additional network.

To change the interface-level network **net.ipv4.conf.IFNAME.accept\_redirects** **sysctl** settings, create an additional SR-IOV network with the Container Network Interface (CNI) tuning plugin.

## Prerequisites

- Install the OpenShift Container Platform CLI (oc).
- Log in to the OpenShift Container Platform cluster as a user with cluster-admin privileges.

## Procedure

1. Create the **SriovNetwork** custom resource (CR) for the additional SR-IOV network attachment and insert the **metaPlugins** configuration, as in the following example CR. Save the YAML as the file **sriov-network-interface-sysctl.yaml**.

```
apiVersion: sriovnetwork.openshift.io/v1
kind: SriovNetwork
metadata:
 name: onevalidflag 1
 namespace: openshift-sriov-network-operator 2
spec:
 resourceName: policyoneflag 3
 networkNamespace: sysctl-tuning-test 4
 ipam: { "type": "static" } 5
 capabilities: { "mac": true, "ips": true } 6
 metaPlugins : | 7
 {
 "type": "tuning",
 "capabilities":{
 "mac":true
 },
 "sysctl":{
 "net.ipv4.conf.IFNAME.accept_redirects": "1"
 }
 }
}
```

- 1 A name for the object. The SR-IOV Network Operator creates a **NetworkAttachmentDefinition** object with same name.
- 2 The namespace where the SR-IOV Network Operator is installed.
- 3 The value for the **spec.resourceName** parameter from the **SriovNetworkNodePolicy**

- 4 The target namespace for the **SriovNetwork** object. Only pods in the target namespace can attach to the additional network.
- 5 A configuration object for the IPAM CNI plugin as a YAML block scalar. The plugin manages IP address assignment for the attachment definition.
- 6 Optional: Set capabilities for the additional network. You can specify "{ **"ips": true }**" to enable IP address support or "{ **"mac": true }**" to enable MAC address support.
- 7 Optional: The metaPlugins parameter is used to add additional capabilities to the device. In this use case set the **type** field to **tuning**. Specify the interface-level network **sysctl** you want to set in the **sysctl** field.

2. Create the **SriovNetwork** resource:

```
$ oc create -f sriov-network-interface-sysctl.yaml
```

### Verifying that the **NetworkAttachmentDefinition** CR is successfully created

- Confirm that the SR-IOV Network Operator created the **NetworkAttachmentDefinition** CR by running the following command:

```
$ oc get network-attachment-definitions -n <namespace> 1
```

- 1 Replace **<namespace>** with the value for **networkNamespace** that you specified in the **SriovNetwork** object. For example, **sysctl-tuning-test**.

### Example output

```
NAME AGE
onevalidflag 14m
```

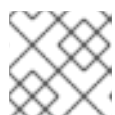

#### NOTE

There might be a delay before the SR-IOV Network Operator creates the CR.

### Verifying that the additional SR-IOV network attachment is successful

To verify that the tuning CNI is correctly configured and the additional SR-IOV network attachment is attached, do the following:

1. Create a **Pod** CR. Save the following YAML as the file **examplepod.yaml**:

```
apiVersion: v1
kind: Pod
metadata:
 name: tunepod
 namespace: sysctl-tuning-test
 annotations:
 k8s.v1.cni.cncf.io/networks: |-
 [
 {
```



```

 "name": "onevalidflag", 1
 "mac": "0a:56:0a:83:04:0c", 2
 "ips": ["10.100.100.200/24"] 3
 }
]
spec:
 containers:
 - name: podexample
 image: centos
 command: ["/bin/bash", "-c", "sleep INF"]
 securityContext:
 runAsUser: 2000
 runAsGroup: 3000
 allowPrivilegeEscalation: false
 capabilities:
 drop: ["ALL"]
 securityContext:
 runAsNonRoot: true
 seccompProfile:
 type: RuntimeDefault

```

- 1 The name of the SR-IOV network attachment definition CR.
- 2 Optional: The MAC address for the SR-IOV device that is allocated from the resource type defined in the SR-IOV network attachment definition CR. To use this feature, you also must specify { **"mac": true** } in the **SriovNetwork** object.
- 3 Optional: IP addresses for the SR-IOV device that are allocated from the resource type defined in the SR-IOV network attachment definition CR. Both IPv4 and IPv6 addresses are supported. To use this feature, you also must specify { **"ips": true** } in the **SriovNetwork** object.

2. Create the **Pod** CR:

```
$ oc apply -f examplepod.yaml
```

3. Verify that the pod is created by running the following command:

```
$ oc get pod -n sysctl-tuning-test
```

### Example output

```

NAME READY STATUS RESTARTS AGE
tunepod 1/1 Running 0 47s

```

4. Log in to the pod by running the following command:

```
$ oc rsh -n sysctl-tuning-test tunepod
```

5. Verify the values of the configured sysctl flag. Find the value **net.ipv4.conf.INTERFACE.accept\_redirects** by running the following command::

```
$ sysctl net.ipv4.conf.net1.accept_redirects
```

## Example output

```
net.ipv4.conf.net1.accept_redirects = 1
```

### 27.8.3. Configuring sysctl settings for pods associated with bonded SR-IOV interface flag

You can set interface-level network **sysctl** settings for a pod connected to a bonded SR-IOV network device.

In this example, the specific network interface-level **sysctl** settings that can be configured are set on the bonded interface.

The **sysctl-tuning-test** is a namespace used in this example.

- Use the following command to create the **sysctl-tuning-test** namespace:

```
$ oc create namespace sysctl-tuning-test
```

#### 27.8.3.1. Setting all sysctl flag on nodes with bonded SR-IOV network devices

The SR-IOV Network Operator adds the **SriovNetworkNodePolicy.sriovnetwork.openshift.io** custom resource definition (CRD) to OpenShift Container Platform. You can configure an SR-IOV network device by creating a **SriovNetworkNodePolicy** custom resource (CR).



#### NOTE

When applying the configuration specified in a **SriovNetworkNodePolicy** object, the SR-IOV Operator might drain the nodes, and in some cases, reboot nodes.

It might take several minutes for a configuration change to apply.

Follow this procedure to create a **SriovNetworkNodePolicy** custom resource (CR).

#### Procedure

1. Create an **SriovNetworkNodePolicy** custom resource (CR). Save the following YAML as the file **policyallflags-sriov-node-network.yaml**. Replace **policyallflags** with the name for the configuration.

```
apiVersion: sriovnetwork.openshift.io/v1
kind: SriovNetworkNodePolicy
metadata:
 name: policyallflags 1
 namespace: openshift-sriov-network-operator 2
spec:
 resourceName: policyallflags 3
 nodeSelector: 4
 node.alpha.kubernetes-incubator.io/nfd-network-sriov.capable = `true`
 priority: 10 5
 numVfs: 5 6
 nicSelector: 7
```

```

 pfNames: ["ens1f0"] 8
 deviceType: "netdevice" 9
 isRdma: false 10

```

- 1 The name for the custom resource object.
- 2 The namespace where the SR-IOV Network Operator is installed.
- 3 The resource name of the SR-IOV network device plugin. You can create multiple SR-IOV network node policies for a resource name.
- 4 The node selector specifies the nodes to configure. Only SR-IOV network devices on the selected nodes are configured. The SR-IOV Container Network Interface (CNI) plugin and device plugin are deployed on selected nodes only.
- 5 Optional: The priority is an integer value between **0** and **99**. A smaller value receives higher priority. For example, a priority of **10** is a higher priority than **99**. The default value is **99**.
- 6 The number of virtual functions (VFs) to create for the SR-IOV physical network device. For an Intel network interface controller (NIC), the number of VFs cannot be larger than the total VFs supported by the device. For a Mellanox NIC, the number of VFs cannot be larger than **128**.
- 7 The NIC selector identifies the device for the Operator to configure. You do not have to specify values for all the parameters. It is recommended to identify the network device with enough precision to avoid selecting a device unintentionally. If you specify **rootDevices**, you must also specify a value for **vendor**, **deviceID**, or **pfNames**. If you specify both **pfNames** and **rootDevices** at the same time, ensure that they refer to the same device. If you specify a value for **netFilter**, then you do not need to specify any other parameter because a network ID is unique.
- 8 Optional: An array of one or more physical function (PF) names for the device.
- 9 Optional: The driver type for the virtual functions. The only allowed value is **netdevice**. For a Mellanox NIC to work in DPDK mode on bare metal nodes, set **isRdma** to **true**.
- 10 Optional: Configures whether to enable remote direct memory access (RDMA) mode. The default value is **false**. If the **isRdma** parameter is set to **true**, you can continue to use the RDMA-enabled VF as a normal network device. A device can be used in either mode. Set **isRdma** to **true** and additionally set **needVhostNet** to **true** to configure a Mellanox NIC for use with Fast Datapath DPDK applications.

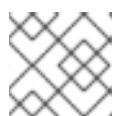

#### NOTE

The **vfio-pci** driver type is not supported.

2. Create the SriovNetworkNodePolicy object:

```
$ oc create -f policyallflags-sriov-node-network.yaml
```

After applying the configuration update, all the pods in `sriov-network-operator` namespace change to the **Running** status.

- To verify that the SR-IOV network device is configured, enter the following command. Replace **<node\_name>** with the name of a node with the SR-IOV network device that you just configured.

```
$ oc get sriovnetworknodestates -n openshift-sriov-network-operator <node_name> -o
jsonpath='{.status.syncStatus}'
```

### Example output

```
Succeeded
```

### 27.8.3.2. Configuring sysctl on a bonded SR-IOV network

You can set interface specific **sysctl** settings on a bonded interface created from two SR-IOV interfaces. Do this by adding the tuning configuration to the optional **Plugins** parameter of the bond network attachment definition.



#### NOTE

Do not edit **NetworkAttachmentDefinition** custom resources that the SR-IOV Network Operator manages. Doing so might disrupt network traffic on your additional network.

To change specific interface-level network **sysctl** settings create the **SriovNetwork** custom resource (CR) with the Container Network Interface (CNI) tuning plugin by using the following procedure.

#### Prerequisites

- Install the OpenShift Container Platform CLI (oc).
- Log in to the OpenShift Container Platform cluster as a user with cluster-admin privileges.

#### Procedure

- Create the **SriovNetwork** custom resource (CR) for the bonded interface as in the following example CR. Save the YAML as the file **sriov-network-attachment.yaml**.

```
apiVersion: sriovnetwork.openshift.io/v1
kind: SriovNetwork
metadata:
 name: allvalidflags 1
 namespace: openshift-sriov-network-operator 2
spec:
 resourceName: policyallflags 3
 networkNamespace: sysctl-tuning-test 4
 capabilities: { "mac": true, "ips": true } 5
```

- A name for the object. The SR-IOV Network Operator creates a NetworkAttachmentDefinition object with same name.
- The namespace where the SR-IOV Network Operator is installed.
- The value for the **spec.resourceName** parameter from the **SriovNetworkNodePolicy** object that defines the SR-IOV hardware for this additional network.

- 4 The target namespace for the **SriovNetwork** object. Only pods in the target namespace can attach to the additional network.
- 5 Optional: The capabilities to configure for this additional network. You can specify "{ **ips**: true }" to enable IP address support or "{ **mac**: true }" to enable MAC address support.

2. Create the **SriovNetwork** resource:

```
$ oc create -f sriov-network-attachment.yaml
```

3. Create a bond network attachment definition as in the following example CR. Save the YAML as the file **sriov-bond-network-interface.yaml**.

```
apiVersion: "k8s.cni.cncf.io/v1"
kind: NetworkAttachmentDefinition
metadata:
 name: bond-sysctl-network
 namespace: sysctl-tuning-test
spec:
 config: {
 "cniVersion": "0.4.0",
 "name": "bond-net",
 "plugins": [
 {
 "type": "bond", 1
 "mode": "active-backup", 2
 "failOverMac": 1, 3
 "linksInContainer": true, 4
 "miimon": "100",
 "links": [5
 {"name": "net1"},
 {"name": "net2"}
],
 "ipam": { 6
 "type": "static"
 }
 },
 {
 "type": "tuning", 7
 "capabilities": {
 "mac": true
 },
 "sysctl": {
 "net.ipv4.conf.IFNAME.accept_redirects": "0",
 "net.ipv4.conf.IFNAME.accept_source_route": "0",
 "net.ipv4.conf.IFNAME.disable_policy": "1",
 "net.ipv4.conf.IFNAME.secure_redirects": "0",
 "net.ipv4.conf.IFNAME.send_redirects": "0",
 "net.ipv6.conf.IFNAME.accept_redirects": "0",
 "net.ipv6.conf.IFNAME.accept_source_route": "1",
 "net.ipv6.neigh.IFNAME.base_reachable_time_ms": "20000",
 "net.ipv6.neigh.IFNAME.retrans_time_ms": "2000"
 }
 }
]
 }
}
```

```

 }
]
}'

```

- 1 The type is **bond**.
- 2 The **mode** attribute specifies the bonding mode. The bonding modes supported are:
  - **balance-rr** - 0
  - **active-backup** - 1
  - **balance-xor** - 2
 For **balance-rr** or **balance-xor** modes, you must set the **trust** mode to **on** for the SR-IOV virtual function.
- 3 The **failover** attribute is mandatory for active-backup mode.
- 4 The **linksInContainer=true** flag informs the Bond CNI that the required interfaces are to be found inside the container. By default, Bond CNI looks for these interfaces on the host which does not work for integration with SRIOV and Multus.
- 5 The **links** section defines which interfaces will be used to create the bond. By default, Multus names the attached interfaces as: "net", plus a consecutive number, starting with one.
- 6 A configuration object for the IPAM CNI plugin as a YAML block scalar. The plugin manages IP address assignment for the attachment definition. In this pod example IP addresses are configured manually, so in this case, **ipam** is set to static.
- 7 Add additional capabilities to the device. For example, set the **type** field to **tuning**. Specify the interface-level network **sysctl** you want to set in the **sysctl** field. This example sets all interface-level network **sysctl** settings that can be set.

4. Create the bond network attachment resource:

```

$ oc create -f sriov-bond-network-interface.yaml

```

### Verifying that the **NetworkAttachmentDefinition** CR is successfully created

- Confirm that the SR-IOV Network Operator created the **NetworkAttachmentDefinition** CR by running the following command:

```

$ oc get network-attachment-definitions -n <namespace> 1

```

- 1 Replace **<namespace>** with the networkNamespace that you specified when configuring the network attachment, for example, **sysctl-tuning-test**.

### Example output

```

NAME AGE
bond-sysctl-network 22m
allvalidflags 47m

```

**NOTE**

There might be a delay before the SR-IOV Network Operator creates the CR.

### Verifying that the additional SR-IOV network resource is successful

To verify that the tuning CNI is correctly configured and the additional SR-IOV network attachment is attached, do the following:

1. Create a **Pod** CR. For example, save the following YAML as the file **examplepod.yaml**:

```

apiVersion: v1
kind: Pod
metadata:
 name: tunepod
 namespace: sysctl-tuning-test
 annotations:
 k8s.v1.cni.cncf.io/networks: |-
 [
 {"name": "allvalidflags"}, 1
 {"name": "allvalidflags"},
 {
 "name": "bond-sysctl-network",
 "interface": "bond0",
 "mac": "0a:56:0a:83:04:0c", 2
 "ips": ["10.100.100.200/24"] 3
 }
]
spec:
 containers:
 - name: podexample
 image: centos
 command: ["/bin/bash", "-c", "sleep INF"]
 securityContext:
 runAsUser: 2000
 runAsGroup: 3000
 allowPrivilegeEscalation: false
 capabilities:
 drop: ["ALL"]
 securityContext:
 runAsNonRoot: true
 seccompProfile:
 type: RuntimeDefault

```

- 1** The name of the SR-IOV network attachment definition CR.
- 2** Optional: The MAC address for the SR-IOV device that is allocated from the resource type defined in the SR-IOV network attachment definition CR. To use this feature, you also must specify { **"mac": true** } in the **SriovNetwork** object.
- 3** Optional: IP addresses for the SR-IOV device that are allocated from the resource type defined in the SR-IOV network attachment definition CR. Both IPv4 and IPv6 addresses are supported. To use this feature, you also must specify { **"ips": true** } in the **SriovNetwork** object.

2. Apply the YAML:

```
$ oc apply -f examplepod.yaml
```

3. Verify that the pod is created by running the following command:

```
$ oc get pod -n sysctl-tuning-test
```

#### Example output

```
NAME READY STATUS RESTARTS AGE
tunepod 1/1 Running 0 47s
```

4. Log in to the pod by running the following command:

```
$ oc rsh -n sysctl-tuning-test tunepod
```

5. Verify the values of the configured **sysctl** flag. Find the value **net.ipv6.neigh.IFNAME.base\_reachable\_time\_ms** by running the following command::

```
$ sysctl net.ipv6.neigh.bond0.base_reachable_time_ms
```

#### Example output

```
net.ipv6.neigh.bond0.base_reachable_time_ms = 20000
```

### 27.8.4. About all-multicast mode

Enabling all-multicast mode, particularly in the context of rootless applications, is critical. If you do not enable this mode, you would be required to grant the **NET\_ADMIN** capability to the pod's Security Context Constraints (SCC). If you were to allow the **NET\_ADMIN** capability to grant the pod privileges to make changes that extend beyond its specific requirements, you could potentially expose security vulnerabilities.

The tuning CNI plugin supports changing several interface attributes, including all-multicast mode. By enabling this mode, you can allow applications running on Virtual Functions (VFs) that are configured on a SR-IOV network device to receive multicast traffic from applications on other VFs, whether attached to the same or different physical functions.

#### 27.8.4.1. Enabling the all-multicast mode on an SR-IOV network

You can enable the all-multicast mode on an SR-IOV interface by:

- Adding the tuning configuration to the **metaPlugins** parameter of the **SriovNetwork** resource
- Setting the **allmulti** field to **true** in the tuning configuration



#### NOTE

Ensure that you create the virtual function (VF) with trust enabled.



The SR-IOV Network Operator manages additional network definitions. When you specify an additional SR-IOV network to create, the SR-IOV Network Operator creates the **NetworkAttachmentDefinition** custom resource (CR) automatically.



## NOTE

Do not edit **NetworkAttachmentDefinition** custom resources that the SR-IOV Network Operator manages. Doing so might disrupt network traffic on your additional network.

Enable the all-multicast mode on a SR-IOV network by following this guidance.

## Prerequisites

- You have installed the OpenShift Container Platform CLI (oc).
- You are logged in to the OpenShift Container Platform cluster as a user with **cluster-admin** privileges.
- You have installed the SR-IOV Network Operator.
- You have configured an appropriate **SriovNetworkNodePolicy** object.

## Procedure

1. Create a YAML file with the following settings that defines a **SriovNetworkNodePolicy** object for a Mellanox ConnectX-5 device. Save the YAML file as **sriovnetpolicy-mlx.yaml**.

```
apiVersion: sriovnetwork.openshift.io/v1
kind: SriovNetworkNodePolicy
metadata:
 name: sriovnetpolicy-mlx
 namespace: openshift-sriov-network-operator
spec:
 deviceType: netdevice
 nicSelector:
 deviceID: "1017"
 pfNames:
 - ens8f0np0#0-9
 rootDevices:
 - 0000:d8:00.0
 vendor: "15b3"
 nodeSelector:
 feature.node.kubernetes.io/network-sriov.capable: "true"
 numVfs: 10
 priority: 99
 resourceName: resourcemlx
```

2. Optional: If the SR-IOV capable cluster nodes are not already labeled, add the **SriovNetworkNodePolicy.Spec.NodeSelector** label. For more information about labeling nodes, see "Understanding how to update labels on nodes".
3. Create the **SriovNetworkNodePolicy** object by running the following command:

```
$ oc create -f sriovnetpolicy-mlx.yaml
```

After applying the configuration update, all the pods in the **sriov-network-operator** namespace automatically move to a **Running** status.

4. Create the **enable-allmulti-test** namespace by running the following command:

```
$ oc create namespace enable-allmulti-test
```

5. Create the **SriovNetwork** custom resource (CR) for the additional SR-IOV network attachment and insert the **metaPlugins** configuration, as in the following example CR YAML, and save the file as **sriov-enable-all-multicast.yaml**.

```
apiVersion: sriovnetwork.openshift.io/v1
kind: SriovNetwork
metadata:
 name: enableallmulti 1
 namespace: openshift-sriov-network-operator 2
spec:
 resourceName: enableallmulti 3
 networkNamespace: enable-allmulti-test 4
 ipam: '{ "type": "static" }' 5
 capabilities: '{ "mac": true, "ips": true }' 6
 trust: "on" 7
 metaPlugins : | 8
 {
 "type": "tuning",
 "capabilities":{
 "mac":true
 },
 "allmulti": true
 }
}
```

- 1 Specify a name for the object. The SR-IOV Network Operator creates a **NetworkAttachmentDefinition** object with the same name.
- 2 Specify the namespace where the SR-IOV Network Operator is installed.
- 3 Specify a value for the **spec.resourceName** parameter from the **SriovNetworkNodePolicy** object that defines the SR-IOV hardware for this additional network.
- 4 Specify the target namespace for the **SriovNetwork** object. Only pods in the target namespace can attach to the additional network.
- 5 Specify a configuration object for the IPAM CNI plugin as a YAML block scalar. The plugin manages IP address assignment for the attachment definition.
- 6 Optional: Set capabilities for the additional network. You can specify **"{ "ips": true }"** to enable IP address support or **"{ "mac": true }"** to enable MAC address support.
- 7 Specify the trust mode of the virtual function. This must be set to "on".
- 8 Add more capabilities to the device by using the **metaPlugins** parameter. In this use case, set the **type** field to **tuning**, and add the **allmulti** field and set it to **true**.

6. Create the **SriovNetwork** resource by running the following command:

```
$ oc create -f sriov-enable-all-multicast.yaml
```

### Verification of the **NetworkAttachmentDefinition** CR

- Confirm that the SR-IOV Network Operator created the **NetworkAttachmentDefinition** CR by running the following command:

```
$ oc get network-attachment-definitions -n <namespace> 1
```

- 1** Replace **<namespace>** with the value for **networkNamespace** that you specified in the **SriovNetwork** object. For this example, that is **enable-allmulti-test**.

### Example output

```
NAME AGE
enableallmulti 14m
```



### NOTE

There might be a delay before the SR-IOV Network Operator creates the CR.

1. Display information about the SR-IOV network resources by running the following command:

```
$ oc get sriovnetwork -n openshift-sriov-network-operator
```

### Verification of the additional SR-IOV network attachment

To verify that the tuning CNI is correctly configured and that the additional SR-IOV network attachment is attached, follow these steps:

1. Create a **Pod** CR. Save the following sample YAML in a file named **examplepod.yaml**:

```
apiVersion: v1
kind: Pod
metadata:
 name: samplepod
 namespace: enable-allmulti-test
 annotations:
 k8s.v1.cni.cncf.io/networks: |-
 [
 {
 "name": "enableallmulti", 1
 "mac": "0a:56:0a:83:04:0c", 2
 "ips": ["10.100.100.200/24"] 3
 }
]
spec:
 containers:
 - name: podexample
```

```

image: centos
command: ["/bin/bash", "-c", "sleep INF"]
securityContext:
 runAsUser: 2000
 runAsGroup: 3000
 allowPrivilegeEscalation: false
 capabilities:
 drop: ["ALL"]
securityContext:
 runAsNonRoot: true
seccompProfile:
 type: RuntimeDefault

```

- 1 Specify the name of the SR-IOV network attachment definition CR.
- 2 Optional: Specify the MAC address for the SR-IOV device that is allocated from the resource type defined in the SR-IOV network attachment definition CR. To use this feature, you also must specify `{"mac": true}` in the `SriovNetwork` object.
- 3 Optional: Specify the IP addresses for the SR-IOV device that are allocated from the resource type defined in the SR-IOV network attachment definition CR. Both IPv4 and IPv6 addresses are supported. To use this feature, you also must specify `{"ips": true }` in the `SriovNetwork` object.

2. Create the **Pod** CR by running the following command:

```
$ oc apply -f examplepod.yaml
```

3. Verify that the pod is created by running the following command:

```
$ oc get pod -n enable-allmulti-test
```

### Example output

```

NAME READY STATUS RESTARTS AGE
samplepod 1/1 Running 0 47s

```

4. Log in to the pod by running the following command:

```
$ oc rsh -n enable-allmulti-test samplepod
```

5. List all the interfaces associated with the pod by running the following command:

```
sh-4.4# ip link
```

### Example output

```

1: lo: <LOOPBACK,UP,LOWER_UP> mtu 65536 qdisc noqueue state UNKNOWN mode
DEFAULT group default qlen 1000
 link/loopback 00:00:00:00:00:00 brd 00:00:00:00:00:00
2: eth0@if22: <BROADCAST,MULTICAST,UP,LOWER_UP> mtu 8901 qdisc noqueue state
UP mode DEFAULT group default
 link/ether 0a:58:0a:83:00:10 brd ff:ff:ff:ff:ff:ff link-netnsid 0

```

```
3: net1@if24: <BROADCAST,MULTICAST,ALLMULTI,UP,LOWER_UP> mtu 1500 qdisc
noqueue state UP mode DEFAULT group default
link/ether ee:9b:66:a4:ec:1d brd ff:ff:ff:ff:ff:ff link-netnsid 0
```

- 1 **eth0@if22** is the primary interface
- 2 **net1@if24** is the secondary interface configured with the network-attachment-definition that supports the all-multicast mode (**ALLMULTI** flag)

## 27.9. USING HIGH PERFORMANCE MULTICAST

You can use multicast on your Single Root I/O Virtualization (SR-IOV) hardware network.

### 27.9.1. High performance multicast

The OpenShift SDN network plugin supports multicast between pods on the default network. This is best used for low-bandwidth coordination or service discovery, and not high-bandwidth applications. For applications such as streaming media, like Internet Protocol television (IPTV) and multipoint videoconferencing, you can utilize Single Root I/O Virtualization (SR-IOV) hardware to provide near-native performance.

When using additional SR-IOV interfaces for multicast:

- Multicast packages must be sent or received by a pod through the additional SR-IOV interface.
- The physical network which connects the SR-IOV interfaces decides the multicast routing and topology, which is not controlled by OpenShift Container Platform.

### 27.9.2. Configuring an SR-IOV interface for multicast

The follow procedure creates an example SR-IOV interface for multicast.

#### Prerequisites

- Install the OpenShift CLI (**oc**).
- You must log in to the cluster with a user that has the **cluster-admin** role.

#### Procedure

1. Create a **SriovNetworkNodePolicy** object:

```
apiVersion: sriovnetwork.openshift.io/v1
kind: SriovNetworkNodePolicy
metadata:
 name: policy-example
 namespace: openshift-sriov-network-operator
spec:
 resourceName: example
 nodeSelector:
 feature.node.kubernetes.io/network-sriov.capable: "true"
 numVfs: 4
 nicSelector:
```

```

vendor: "8086"
pfNames: ["ens803f0"]
rootDevices: ["0000:86:00.0"]

```

2. Create a **SriovNetwork** object:

```

apiVersion: sriovnetwork.openshift.io/v1
kind: SriovNetwork
metadata:
 name: net-example
 namespace: openshift-sriov-network-operator
spec:
 networkNamespace: default
 ipam: | 1
 {
 "type": "host-local", 2
 "subnet": "10.56.217.0/24",
 "rangeStart": "10.56.217.171",
 "rangeEnd": "10.56.217.181",
 "routes": [
 {"dst": "224.0.0.0/5"},
 {"dst": "232.0.0.0/5"}
],
 "gateway": "10.56.217.1"
 }
 resourceName: example

```

- 1** **2** If you choose to configure DHCP as IPAM, ensure that you provision the following default routes through your DHCP server: **224.0.0.0/5** and **232.0.0.0/5**. This is to override the static multicast route set by the default network provider.

3. Create a pod with multicast application:

```

apiVersion: v1
kind: Pod
metadata:
 name: testpmd
 namespace: default
 annotations:
 k8s.v1.cni.cncf.io/networks: nic1
spec:
 containers:
 - name: example
 image: rhel7:latest
 securityContext:
 capabilities:
 add: ["NET_ADMIN"] 1
 command: ["sleep", "infinity"]

```

- 1** The **NET\_ADMIN** capability is required only if your application needs to assign the multicast IP address to the SR-IOV interface. Otherwise, it can be omitted.

## 27.10. USING DPDK AND RDMA

The containerized Data Plane Development Kit (DPDK) application is supported on OpenShift Container Platform. You can use Single Root I/O Virtualization (SR-IOV) network hardware with the Data Plane Development Kit (DPDK) and with remote direct memory access (RDMA).

For information about supported devices, see [Supported devices](#).

### 27.10.1. Using a virtual function in DPDK mode with an Intel NIC

#### Prerequisites

- Install the OpenShift CLI (**oc**).
- Install the SR-IOV Network Operator.
- Log in as a user with **cluster-admin** privileges.

#### Procedure

1. Create the following **SriovNetworkNodePolicy** object, and then save the YAML in the **intel-dpdk-node-policy.yaml** file.

```
apiVersion: sriovnetwork.openshift.io/v1
kind: SriovNetworkNodePolicy
metadata:
 name: intel-dpdk-node-policy
 namespace: openshift-sriov-network-operator
spec:
 resourceName: intelnics
 nodeSelector:
 feature.node.kubernetes.io/network-sriov.capable: "true"
 priority: <priority>
 numVfs: <num>
 nicSelector:
 vendor: "8086"
 deviceID: "158b"
 pfNames: ["<pf_name>", ...]
 rootDevices: ["<pci_bus_id>", "..."]
 deviceType: vfio-pci ❶
```

- ❶ Specify the driver type for the virtual functions to **vfio-pci**.

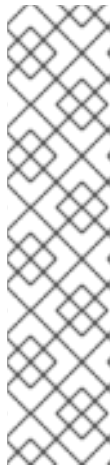
**NOTE**

See the **Configuring SR-IOV network devices** section for a detailed explanation on each option in **SriovNetworkNodePolicy**.

When applying the configuration specified in a **SriovNetworkNodePolicy** object, the SR-IOV Operator may drain the nodes, and in some cases, reboot nodes. It may take several minutes for a configuration change to apply. Ensure that there are enough available nodes in your cluster to handle the evicted workload beforehand.

After the configuration update is applied, all the pods in **openshift-sriov-network-operator** namespace will change to a **Running** status.

2. Create the **SriovNetworkNodePolicy** object by running the following command:

```
$ oc create -f intel-dpdk-node-policy.yaml
```

3. Create the following **SriovNetwork** object, and then save the YAML in the **intel-dpdk-network.yaml** file.

```
apiVersion: sriovnetwork.openshift.io/v1
kind: SriovNetwork
metadata:
 name: intel-dpdk-network
 namespace: openshift-sriov-network-operator
spec:
 networkNamespace: <target_namespace>
 ipam: |-
 # ... 1
 vlan: <vlan>
 resourceName: intelnic3
```

- 1 Specify a configuration object for the ipam CNI plugin as a YAML block scalar. The plugin manages IP address assignment for the attachment definition.

**NOTE**

See the "Configuring SR-IOV additional network" section for a detailed explanation on each option in **SriovNetwork**.

An optional library, `app-netutil`, provides several API methods for gathering network information about a container's parent pod.

4. Create the **SriovNetwork** object by running the following command:

```
$ oc create -f intel-dpdk-network.yaml
```

5. Create the following **Pod** spec, and then save the YAML in the **intel-dpdk-pod.yaml** file.

```
apiVersion: v1
kind: Pod
metadata:
```



```

name: dpdk-app
namespace: <target_namespace> ❶
annotations:
 k8s.v1.cni.cncf.io/networks: intel-dpdk-network
spec:
 containers:
 - name: testpmd
 image: <DPDK_image> ❷
 securityContext:
 runAsUser: 0
 capabilities:
 add: ["IPC_LOCK", "SYS_RESOURCE", "NET_RAW"] ❸
 volumeMounts:
 - mountPath: /mnt/huge ❹
 name: hugepage
 resources:
 limits:
 openshift.io/intelnic: "1" ❺
 memory: "1Gi"
 cpu: "4" ❻
 hugepages-1Gi: "4Gi" ❼
 requests:
 openshift.io/intelnic: "1"
 memory: "1Gi"
 cpu: "4"
 hugepages-1Gi: "4Gi"
 command: ["sleep", "infinity"]
 volumes:
 - name: hugepage
 emptyDir:
 medium: HugePages

```

- ❶ Specify the same **target\_namespace** where the **SriovNetwork** object **intel-dpdk-network** is created. If you would like to create the pod in a different namespace, change **target\_namespace** in both the **Pod** spec and the **SriovNetwork** object.
- ❷ Specify the DPDK image which includes your application and the DPDK library used by application.
- ❸ Specify additional capabilities required by the application inside the container for hugepage allocation, system resource allocation, and network interface access.
- ❹ Mount a hugepage volume to the DPDK pod under **/mnt/huge**. The hugepage volume is backed by the emptyDir volume type with the medium being **Hugepages**.
- ❺ Optional: Specify the number of DPDK devices allocated to DPDK pod. This resource request and limit, if not explicitly specified, will be automatically added by the SR-IOV network resource injector. The SR-IOV network resource injector is an admission controller component managed by the SR-IOV Operator. It is enabled by default and can be disabled by setting **enableInjector** option to **false** in the default **SriovOperatorConfig** CR.
- ❻ Specify the number of CPUs. The DPDK pod usually requires exclusive CPUs to be allocated from the kubelet. This is achieved by setting CPU Manager policy to **static** and creating a pod with **Guaranteed** QoS.

- 7 Specify hugepage size **hugepages-1Gi** or **hugepages-2Mi** and the quantity of hugepages that will be allocated to the DPDK pod. Configure **2Mi** and **1Gi** hugepages separately.

6. Create the DPDK pod by running the following command:

```
$ oc create -f intel-dpdk-pod.yaml
```

## 27.10.2. Using a virtual function in DPDK mode with a Mellanox NIC

You can create a network node policy and create a Data Plane Development Kit (DPDK) pod using a virtual function in DPDK mode with a Mellanox NIC.

### Prerequisites

- You have installed the OpenShift CLI (**oc**).
- You have installed the Single Root I/O Virtualization (SR-IOV) Network Operator.
- You have logged in as a user with **cluster-admin** privileges.

### Procedure

1. Save the following **SriovNetworkNodePolicy** YAML configuration to an **mlx-dpdk-node-policy.yaml** file:

```
apiVersion: sriovnetwork.openshift.io/v1
kind: SriovNetworkNodePolicy
metadata:
 name: mlx-dpdk-node-policy
 namespace: openshift-sriov-network-operator
spec:
 resourceName: mlxnic
 nodeSelector:
 feature.node.kubernetes.io/network-sriov.capable: "true"
 priority: <priority>
 numVfs: <num>
 nicSelector:
 vendor: "15b3"
 deviceID: "1015" 1
 pfNames: ["<pf_name>", ...]
 rootDevices: ["<pci_bus_id>", "..."]
 deviceType: netdevice 2
 isRdma: true 3
```

- 1 Specify the device hex code of the SR-IOV network device.
- 2 Specify the driver type for the virtual functions to **netdevice**. A Mellanox SR-IOV Virtual Function (VF) can work in DPDK mode without using the **vfiopci** device type. The VF device appears as a kernel network interface inside a container.
- 3 Enable Remote Direct Memory Access (RDMA) mode. This is required for Mellanox cards to work in DPDK mode.

**NOTE**

See *Configuring an SR-IOV network device* for a detailed explanation of each option in the **SriovNetworkNodePolicy** object.

When applying the configuration specified in an **SriovNetworkNodePolicy** object, the SR-IOV Operator might drain the nodes, and in some cases, reboot nodes. It might take several minutes for a configuration change to apply. Ensure that there are enough available nodes in your cluster to handle the evicted workload beforehand.

After the configuration update is applied, all the pods in the **openshift-sriov-network-operator** namespace will change to a **Running** status.

2. Create the **SriovNetworkNodePolicy** object by running the following command:

```
$ oc create -f mlx-dpdk-node-policy.yaml
```

3. Save the following **SriovNetwork** YAML configuration to an **mlx-dpdk-network.yaml** file:

```
apiVersion: sriovnetwork.openshift.io/v1
kind: SriovNetwork
metadata:
 name: mlx-dpdk-network
 namespace: openshift-sriov-network-operator
spec:
 networkNamespace: <target_namespace>
 ipam: |- 1
 ...
 vlan: <vlan>
 resourceName: mlxnic
```

- 1 Specify a configuration object for the IP Address Management (IPAM) Container Network Interface (CNI) plugin as a YAML block scalar. The plugin manages IP address assignment for the attachment definition.

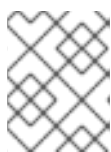
**NOTE**

See *Configuring an SR-IOV network device* for a detailed explanation on each option in the **SriovNetwork** object.

The **app-netutil** option library provides several API methods for gathering network information about the parent pod of a container.

4. Create the **SriovNetwork** object by running the following command:

```
$ oc create -f mlx-dpdk-network.yaml
```

5. Save the following **Pod** YAML configuration to an **mlx-dpdk-pod.yaml** file:

```
apiVersion: v1
kind: Pod
metadata:
```

```

name: dpdk-app
namespace: <target_namespace> ❶
annotations:
 k8s.v1.cni.cncf.io/networks: mlx-dpdk-network
spec:
 containers:
 - name: testpmd
 image: <DPDK_image> ❷
 securityContext:
 runAsUser: 0
 capabilities:
 add: ["IPC_LOCK", "SYS_RESOURCE", "NET_RAW"] ❸
 volumeMounts:
 - mountPath: /mnt/huge ❹
 name: hugepage
 resources:
 limits:
 openshift.io/mlxnic: "1" ❺
 memory: "1Gi"
 cpu: "4" ❻
 hugepages-1Gi: "4Gi" ❼
 requests:
 openshift.io/mlxnic: "1"
 memory: "1Gi"
 cpu: "4"
 hugepages-1Gi: "4Gi"
 command: ["sleep", "infinity"]
 volumes:
 - name: hugepage
 emptyDir:
 medium: HugePages

```

- ❶ Specify the same **target\_namespace** where **SriovNetwork** object **mlx-dpdk-network** is created. To create the pod in a different namespace, change **target\_namespace** in both the **Pod** spec and **SriovNetwork** object.
- ❷ Specify the DPDK image which includes your application and the DPDK library used by the application.
- ❸ Specify additional capabilities required by the application inside the container for hugepage allocation, system resource allocation, and network interface access.
- ❹ Mount the hugepage volume to the DPDK pod under **/mnt/huge**. The hugepage volume is backed by the **emptyDir** volume type with the medium being **HugePages**.
- ❺ Optional: Specify the number of DPDK devices allocated for the DPDK pod. If not explicitly specified, this resource request and limit is automatically added by the SR-IOV network resource injector. The SR-IOV network resource injector is an admission controller component managed by SR-IOV Operator. It is enabled by default and can be disabled by setting the **enableInjector** option to **false** in the default **SriovOperatorConfig** CR.
- ❻ Specify the number of CPUs. The DPDK pod usually requires that exclusive CPUs be allocated from the kubelet. To do this, set the CPU Manager policy to **static** and create a pod with **Guaranteed** Quality of Service (QoS).

- 7 Specify hugepage size **hugepages-1Gi** or **hugepages-2Mi** and the quantity of hugepages that will be allocated to the DPDK pod. Configure **2Mi** and **1Gi** hugepages separately.

6. Create the DPDK pod by running the following command:

```
$ oc create -f mlx-dpdk-pod.yaml
```

### 27.10.3. Using the TAP CNI to run a rootless DPDK workload with kernel access

DPDK applications can use **virtio-user** as an exception path to inject certain types of packets, such as log messages, into the kernel for processing. For more information about this feature, see [Virtio\\_user as Exception Path](#).

In OpenShift Container Platform version 4.14 and later, you can use non-privileged pods to run DPDK applications alongside the tap CNI plugin. To enable this functionality, you need to mount the **vhost-net** device by setting the **needVhostNet** parameter to **true** within the **SriovNetworkNodePolicy** object.

Figure 27.1. DPDK and TAP example configuration

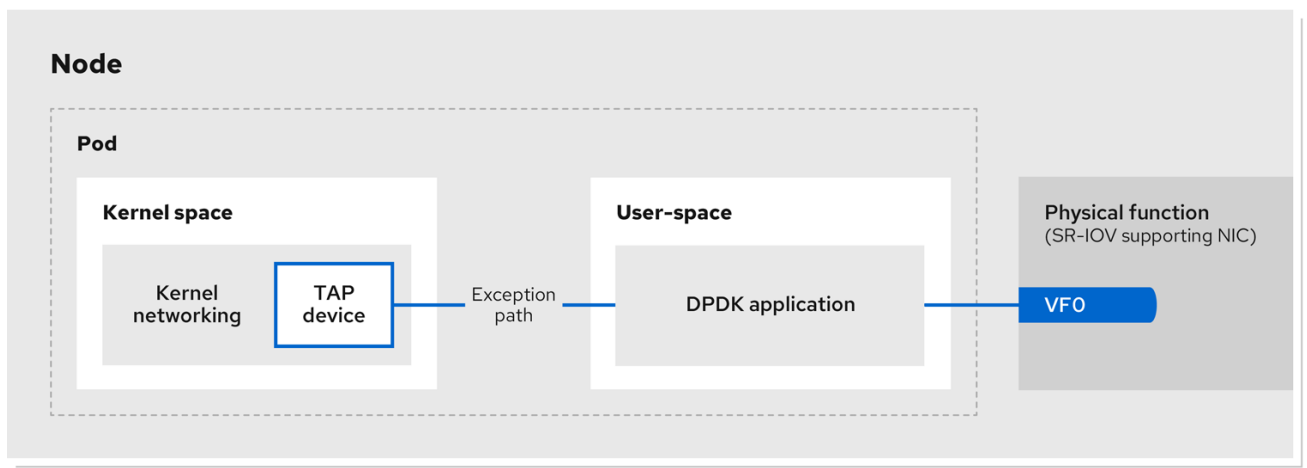

348\_OpenShift\_0923

#### Prerequisites

- You have installed the OpenShift CLI (**oc**).
- You have installed the SR-IOV Network Operator.
- You are logged in as a user with **cluster-admin** privileges.
- Ensure that **setsebools container\_use\_devices=on** is set as root on all nodes.

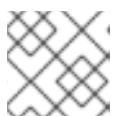

#### NOTE

Use the Machine Config Operator to set this SELinux boolean.

#### Procedure

1. Create a file, such as **test-namespace.yaml**, with content like the following example:

```

apiVersion: v1
kind: Namespace
metadata:
 name: test-namespace
labels:
 pod-security.kubernetes.io/enforce: privileged
 pod-security.kubernetes.io/audit: privileged
 pod-security.kubernetes.io/warn: privileged
 security.openshift.io/scc.podSecurityLabelSync: "false"

```

2. Create the new **Namespace** object by running the following command:

```
$ oc apply -f test-namespace.yaml
```

3. Create a file, such as **sriov-node-network-policy.yaml**, with content like the following example::

```

apiVersion: sriovnetwork.openshift.io/v1
kind: SriovNetworkNodePolicy
metadata:
 name: sriovnic
 namespace: openshift-sriov-network-operator
spec:
 deviceType: netdevice 1
 isRdma: true 2
 needVhostNet: true 3
 nicSelector:
 vendor: "15b3" 4
 deviceID: "101b" 5
 rootDevices: ["00:05.0"]
 numVfs: 10
 priority: 99
 resourceName: sriovnic
 nodeSelector:
 feature.node.kubernetes.io/network-sriov.capable: "true"

```

- 1** This indicates that the profile is tailored specifically for Mellanox Network Interface Controllers (NICs).
- 2** Setting **isRdma** to **true** is only required for a Mellanox NIC.
- 3** This mounts the **/dev/net/tun** and **/dev/vhost-net** devices into the container so the application can create a tap device and connect the tap device to the DPDK workload.
- 4** The vendor hexadecimal code of the SR-IOV network device. The value 15b3 is associated with a Mellanox NIC.
- 5** The device hexadecimal code of the SR-IOV network device.

4. Create the **SriovNetworkNodePolicy** object by running the following command:

```
$ oc create -f sriov-node-network-policy.yaml
```

5. Create the following **SriovNetwork** object, and then save the YAML in the **sriov-network-attachment.yaml** file:

```
apiVersion: sriovnetwork.openshift.io/v1
kind: SriovNetwork
metadata:
 name: sriov-network
 namespace: openshift-sriov-network-operator
spec:
 networkNamespace: test-namespace
 resourceName: sriovnic
 spoofChk: "off"
 trust: "on"
```

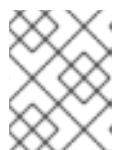

#### NOTE

See the "Configuring SR-IOV additional network" section for a detailed explanation on each option in **SriovNetwork**.

An optional library, **app-netutil**, provides several API methods for gathering network information about a container's parent pod.

6. Create the **SriovNetwork** object by running the following command:

```
$ oc create -f sriov-network-attachment.yaml
```

7. Create a file, such as **tap-example.yaml**, that defines a network attachment definition, with content like the following example:

```
apiVersion: "k8s.cni.cncf.io/v1"
kind: NetworkAttachmentDefinition
metadata:
 name: tap-one
 namespace: test-namespace 1
spec:
 config: '{
 "cniVersion": "0.4.0",
 "name": "tap",
 "plugins": [
 {
 "type": "tap",
 "multiQueue": true,
 "selinuxcontext": "system_u:system_r:container_t:s0"
 },
 {
 "type": "tuning",
 "capabilities": {
 "mac": true
 }
 }
]
 }'
```

- 1** Specify the same **target\_namespace** where the **SriovNetwork** object is created.

8. Create the **NetworkAttachmentDefinition** object by running the following command:

```
$ oc apply -f tap-example.yaml
```

9. Create a file, such as **dpdk-pod-rootless.yaml**, with content like the following example:

```
apiVersion: v1
kind: Pod
metadata:
 name: dpdk-app
 namespace: test-namespace 1
 annotations:
 k8s.v1.cni.cncf.io/networks: '[
 {"name": "sriov-network", "namespace": "test-namespace"},
 {"name": "tap-one", "interface": "ext0", "namespace": "test-namespace"}]'
spec:
 nodeSelector:
 kubernetes.io/hostname: "worker-0"
 securityContext:
 fsGroup: 1001 2
 runAsGroup: 1001 3
 seccompProfile:
 type: RuntimeDefault
 containers:
 - name: testpmd
 image: <DPDK_image> 4
 securityContext:
 capabilities:
 drop: ["ALL"] 5
 add: 6
 - IPC_LOCK
 - NET_RAW #for mlx only 7
 runAsUser: 1001 8
 privileged: false 9
 allowPrivilegeEscalation: true 10
 runAsNonRoot: true 11
 volumeMounts:
 - mountPath: /mnt/huge 12
 name: hugepages
 resources:
 limits:
 openshift.io/sriovnic: "1" 13
 memory: "1Gi"
 cpu: "4" 14
 hugepages-1Gi: "4Gi" 15
 requests:
 openshift.io/sriovnic: "1"
 memory: "1Gi"
 cpu: "4"
 hugepages-1Gi: "4Gi"
 command: ["sleep", "infinity"]
 runtimeClassName: performance-cnf-performanceprofile 16
 volumes:
```



```
- name: hugepages
 emptyDir:
 medium: HugePages
```

- 1 Specify the same **target\_namespace** in which the **SriovNetwork** object is created. If you want to create the pod in a different namespace, change **target\_namespace** in both the **Pod** spec and the **SriovNetwork** object.
- 2 Sets the group ownership of volume-mounted directories and files created in those volumes.
- 3 Specify the primary group ID used for running the container.
- 4 Specify the DPDK image that contains your application and the DPDK library used by application.
- 5 Removing all capabilities (**ALL**) from the container's securityContext means that the container has no special privileges beyond what is necessary for normal operation.
- 6 Specify additional capabilities required by the application inside the container for hugepage allocation, system resource allocation, and network interface access. These capabilities must also be set in the binary file by using the **setcap** command.
- 7 Mellanox network interface controller (NIC) requires the **NET\_RAW** capability.
- 8 Specify the user ID used for running the container.
- 9 This setting indicates that the container or containers within the pod should not be granted privileged access to the host system.
- 10 This setting allows a container to escalate its privileges beyond the initial non-root privileges it might have been assigned.
- 11 This setting ensures that the container runs with a non-root user. This helps enforce the principle of least privilege, limiting the potential impact of compromising the container and reducing the attack surface.
- 12 Mount a hugepage volume to the DPDK pod under **/mnt/huge**. The hugepage volume is backed by the emptyDir volume type with the medium being **Hugepages**.
- 13 Optional: Specify the number of DPDK devices allocated for the DPDK pod. If not explicitly specified, this resource request and limit is automatically added by the SR-IOV network resource injector. The SR-IOV network resource injector is an admission controller component managed by SR-IOV Operator. It is enabled by default and can be disabled by setting the **enableInjector** option to **false** in the default **SriovOperatorConfig** CR.
- 14 Specify the number of CPUs. The DPDK pod usually requires exclusive CPUs to be allocated from the kubelet. This is achieved by setting CPU Manager policy to **static** and creating a pod with **Guaranteed** QoS.
- 15 Specify hugepage size **hugepages-1Gi** or **hugepages-2Mi** and the quantity of hugepages that will be allocated to the DPDK pod. Configure **2Mi** and **1Gi** hugepages separately. Configuring **1Gi** hugepage requires adding kernel arguments to Nodes. For example, adding kernel arguments **default\_hugepagesz=1GB**, **hugepagesz=1G** and **hugepages=16** will result in **16\*1Gi** hugepages be allocated during system boot.
- 16 If your performance profile is not named **cnf-performance profile**, replace that string with the correct performance profile name

the correct performance profile name.

10. Create the DPDK pod by running the following command:

```
$ oc create -f dpdk-pod-rootless.yaml
```

**Additional resources**

- [Enabling the container\\_use\\_devices boolean](#)
- [Creating a performance profile](#)
- [Configuring an SR-IOV network device](#)

**27.10.4. Overview of achieving a specific DPDK line rate**

To achieve a specific Data Plane Development Kit (DPDK) line rate, deploy a Node Tuning Operator and configure Single Root I/O Virtualization (SR-IOV). You must also tune the DPDK settings for the following resources:

- Isolated CPUs
- Hugepages
- The topology scheduler



**NOTE**

In previous versions of OpenShift Container Platform, the Performance Addon Operator was used to implement automatic tuning to achieve low latency performance for OpenShift Container Platform applications. In OpenShift Container Platform 4.11 and later, this functionality is part of the Node Tuning Operator.

**DPDK test environment**

The following diagram shows the components of a traffic-testing environment:

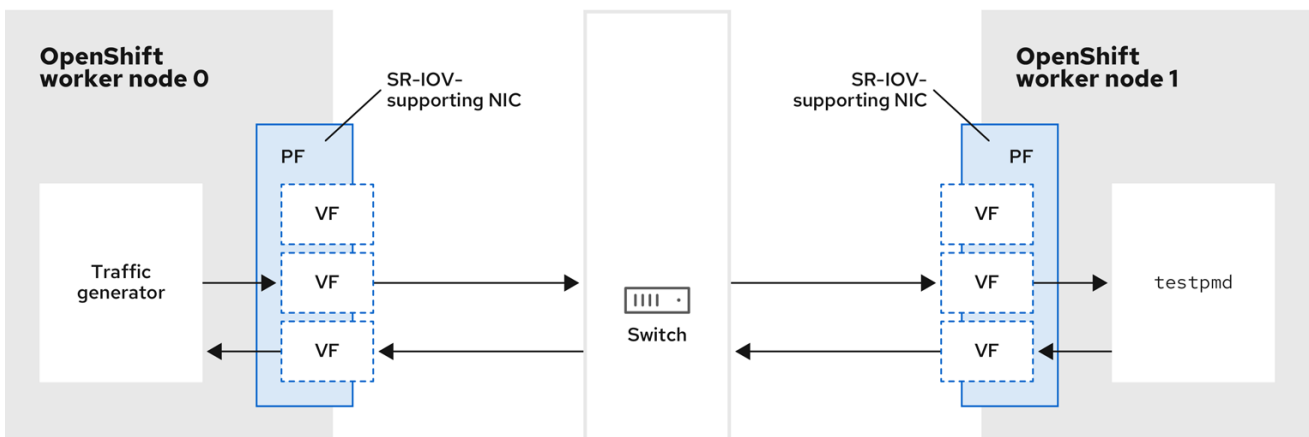

261\_OpenShift\_0722

- **Traffic generator:** An application that can generate high-volume packet traffic.

- **SR-IOV-supporting NIC:** A network interface card compatible with SR-IOV. The card runs a number of virtual functions on a physical interface.
- **Physical Function (PF):** A PCI Express (PCIe) function of a network adapter that supports the SR-IOV interface.
- **Virtual Function (VF):** A lightweight PCIe function on a network adapter that supports SR-IOV. The VF is associated with the PCIe PF on the network adapter. The VF represents a virtualized instance of the network adapter.
- **Switch:** A network switch. Nodes can also be connected back-to-back.
- **testpmd:** An example application included with DPDK. The **testpmd** application can be used to test the DPDK in a packet-forwarding mode. The **testpmd** application is also an example of how to build a fully-fledged application using the DPDK Software Development Kit (SDK).
- **worker 0** and **worker 1:** OpenShift Container Platform nodes.

### 27.10.5. Using SR-IOV and the Node Tuning Operator to achieve a DPDK line rate

You can use the Node Tuning Operator to configure isolated CPUs, hugepages, and a topology scheduler. You can then use the Node Tuning Operator with Single Root I/O Virtualization (SR-IOV) to achieve a specific Data Plane Development Kit (DPDK) line rate.

#### Prerequisites

- You have installed the OpenShift CLI (**oc**).
- You have installed the SR-IOV Network Operator.
- You have logged in as a user with **cluster-admin** privileges.
- You have deployed a standalone Node Tuning Operator.



#### NOTE

In previous versions of OpenShift Container Platform, the Performance Addon Operator was used to implement automatic tuning to achieve low latency performance for OpenShift applications. In OpenShift Container Platform 4.11 and later, this functionality is part of the Node Tuning Operator.

#### Procedure

1. Create a **PerformanceProfile** object based on the following example:

```
apiVersion: performance.openshift.io/v2
kind: PerformanceProfile
metadata:
 name: performance
spec:
 globallyDisableIrqLoadBalancing: true
 cpu:
 isolated: 21-51,73-103 1
 reserved: 0-20,52-72 2
 hugepages:
```

```

defaultHugepagesSize: 1G 3
pages:
 - count: 32
 size: 1G
net:
 userLevelNetworking: true
numa:
 topologyPolicy: "single-numa-node"
nodeSelector:
 node-role.kubernetes.io/worker-cnf: ""

```

- 1** If hyperthreading is enabled on the system, allocate the relevant symbolic links to the **isolated** and **reserved** CPU groups. If the system contains multiple non-uniform memory access nodes (NUMAs), allocate CPUs from both NUMAs to both groups. You can also use the Performance Profile Creator for this task. For more information, see *Creating a performance profile*.
- 2** You can also specify a list of devices that will have their queues set to the reserved CPU count. For more information, see *Reducing NIC queues using the Node Tuning Operator*.
- 3** Allocate the number and size of hugepages needed. You can specify the NUMA configuration for the hugepages. By default, the system allocates an even number to every NUMA node on the system. If needed, you can request the use of a realtime kernel for the nodes. See *Provisioning a worker with real-time capabilities* for more information.

2. Save the **yaml** file as **mlx-dpdk-perfprofile-policy.yaml**.
3. Apply the performance profile using the following command:

```
$ oc create -f mlx-dpdk-perfprofile-policy.yaml
```

### 27.10.5.1. Example SR-IOV Network Operator for virtual functions

You can use the Single Root I/O Virtualization (SR-IOV) Network Operator to allocate and configure Virtual Functions (VFs) from SR-IOV-supporting Physical Function NICs on the nodes.

For more information on deploying the Operator, see *Installing the SR-IOV Network Operator*. For more information on configuring an SR-IOV network device, see *Configuring an SR-IOV network device*.

There are some differences between running Data Plane Development Kit (DPDK) workloads on Intel VFs and Mellanox VFs. This section provides object configuration examples for both VF types. The following is an example of an **sriovNetworkNodePolicy** object used to run DPDK applications on Intel NICs:

```

apiVersion: sriovnetwork.openshift.io/v1
kind: SriovNetworkNodePolicy
metadata:
 name: dpdk-nic-1
 namespace: openshift-sriov-network-operator
spec:
 deviceType: vfio-pci 1
 needVhostNet: true 2
 nicSelector:
 pfNames: ["ens3f0"]

```

```

nodeSelector:
 node-role.kubernetes.io/worker-cnf: ""
numVfs: 10
priority: 99
resourceName: dpdk_nic_1

apiVersion: sriovnetwork.openshift.io/v1
kind: SriovNetworkNodePolicy
metadata:
 name: dpdk-nic-1
 namespace: openshift-sriov-network-operator
spec:
 deviceType: vfio-pci
 needVhostNet: true
 nicSelector:
 pfNames: ["ens3f1"]
 nodeSelector:
 node-role.kubernetes.io/worker-cnf: ""
 numVfs: 10
 priority: 99
 resourceName: dpdk_nic_2

```

- 1 For Intel NICs, **deviceType** must be **vfio-pci**.
- 2 If kernel communication with DPDK workloads is required, add **needVhostNet: true**. This mounts the **/dev/net/tun** and **/dev/vhost-net** devices into the container so the application can create a tap device and connect the tap device to the DPDK workload.

The following is an example of an **sriovNetworkNodePolicy** object for Mellanox NICs:

```

apiVersion: sriovnetwork.openshift.io/v1
kind: SriovNetworkNodePolicy
metadata:
 name: dpdk-nic-1
 namespace: openshift-sriov-network-operator
spec:
 deviceType: netdevice 1
 isRdma: true 2
 nicSelector:
 rootDevices:
 - "0000:5e:00.1"
 nodeSelector:
 node-role.kubernetes.io/worker-cnf: ""
 numVfs: 5
 priority: 99
 resourceName: dpdk_nic_1

apiVersion: sriovnetwork.openshift.io/v1
kind: SriovNetworkNodePolicy
metadata:
 name: dpdk-nic-2
 namespace: openshift-sriov-network-operator
spec:
 deviceType: netdevice
 isRdma: true

```

```

nicSelector:
 rootDevices:
 - "0000:5e:00.0"
nodeSelector:
 node-role.kubernetes.io/worker-cnf: ""
numVfs: 5
priority: 99
resourceName: dpdk_nic_2

```

- 1 For Mellanox devices the **deviceType** must be **netdevice**.
- 2 For Mellanox devices **isRdma** must be **true**. Mellanox cards are connected to DPDK applications using Flow Bifurcation. This mechanism splits traffic between Linux user space and kernel space, and can enhance line rate processing capability.

### 27.10.5.2. Example SR-IOV network operator

The following is an example definition of an **sriovNetwork** object. In this case, Intel and Mellanox configurations are identical:

```

apiVersion: sriovnetwork.openshift.io/v1
kind: SriovNetwork
metadata:
 name: dpdk-network-1
 namespace: openshift-sriov-network-operator
spec:
 ipam: '{"type": "host-local", "ranges": [{"subnet": "10.0.1.0/24"}], "dataDir":
 "/run/my-orchestrator/container-ipam-state-1"}' 1
 networkNamespace: dpdk-test 2
 spoofChk: "off"
 trust: "on"
 resourceName: dpdk_nic_1 3

apiVersion: sriovnetwork.openshift.io/v1
kind: SriovNetwork
metadata:
 name: dpdk-network-2
 namespace: openshift-sriov-network-operator
spec:
 ipam: '{"type": "host-local", "ranges": [{"subnet": "10.0.2.0/24"}], "dataDir":
 "/run/my-orchestrator/container-ipam-state-1"}'
 networkNamespace: dpdk-test
 spoofChk: "off"
 trust: "on"
 resourceName: dpdk_nic_2

```

- 1 You can use a different IP Address Management (IPAM) implementation, such as Whereabouts. For more information, see *Dynamic IP address assignment configuration with Whereabouts*.
- 2 You must request the **networkNamespace** where the network attachment definition will be created. You must create the **sriovNetwork** CR under the **openshift-sriov-network-operator** namespace.
- 3 The **resourceName** value must match that of the **resourceName** created under the **sriovNetworkNodePolicy**.

```

apiVersion: v1
kind: Namespace
metadata:
 name: dpdk-test

```

### 27.10.5.3. Example DPDK base workload

The following is an example of a Data Plane Development Kit (DPDK) container:

```
apiVersion: v1
kind: Namespace
metadata:
 name: dpdk-test

apiVersion: v1
kind: Pod
metadata:
 annotations:
 k8s.v1.cni.cncf.io/networks: '[1
 {
 "name": "dpdk-network-1",
 "namespace": "dpdk-test"
 },
 {
 "name": "dpdk-network-2",
 "namespace": "dpdk-test"
 }
]'
 irq-load-balancing.crio.io: "disable" 2
 cpu-load-balancing.crio.io: "disable"
 cpu-quota.crio.io: "disable"
labels:
 app: dpdk
 name: testpmd
 namespace: dpdk-test
spec:
 runtimeClassName: performance-performance 3
 containers:
 - command:
 - /bin/bash
 - -c
 - sleep INF
 image: registry.redhat.io/openshift4/dpdk-base-rhel8
 imagePullPolicy: Always
 name: dpdk
 resources: 4
 limits:
 cpu: "16"
 hugepages-1Gi: 8Gi
 memory: 2Gi
 requests:
 cpu: "16"
 hugepages-1Gi: 8Gi
 memory: 2Gi
 securityContext:
 capabilities:
 add:
 - IPC_LOCK
```

```

- SYS_RESOURCE
- NET_RAW
- NET_ADMIN
runAsUser: 0
volumeMounts:
- mountPath: /mnt/huge
 name: hugepages
terminationGracePeriodSeconds: 5
volumes:
- emptyDir:
 medium: HugePages
 name: hugepages

```

- 1 Request the SR-IOV networks you need. Resources for the devices will be injected automatically.
- 2 Disable the CPU and IRQ load balancing base. See *Disabling interrupt processing for individual pods* for more information.
- 3 Set the **runtimeClass** to **performance-performance**. Do not set the **runtimeClass** to **HostNetwork** or **privileged**.
- 4 Request an equal number of resources for requests and limits to start the pod with **Guaranteed** Quality of Service (QoS).



#### NOTE

Do not start the pod with **SLEEP** and then exec into the pod to start the testpmd or the DPDK workload. This can add additional interrupts as the **exec** process is not pinned to any CPU.

#### 27.10.5.4. Example testpmd script

The following is an example script for running **testpmd**:

```

#!/bin/bash
set -ex
export CPU=$(cat /sys/fs/cgroup/cpuset/cpuset.cpus)
echo ${CPU}

dpdk-testpmd -l ${CPU} -a ${PCIDEVICE_OPENSIFT_IO_DPDK_NIC_1} -a
${PCIDEVICE_OPENSIFT_IO_DPDK_NIC_2} -n 4 -- -i --nb-cores=15 --rxd=4096 --txd=4096 --
rxq=7 --txq=7 --forward-mode=mac --eth-peer=0,50:00:00:00:00:01 --eth-peer=1,50:00:00:00:00:02

```

This example uses two different **sriovNetwork** CRs. The environment variable contains the Virtual Function (VF) PCI address that was allocated for the pod. If you use the same network in the pod definition, you must split the **pciAddress**. It is important to configure the correct MAC addresses of the traffic generator. This example uses custom MAC addresses.

#### 27.10.6. Using a virtual function in RDMA mode with a Mellanox NIC





## IMPORTANT

RDMA over Converged Ethernet (RoCE) is a Technology Preview feature only. Technology Preview features are not supported with Red Hat production service level agreements (SLAs) and might not be functionally complete. Red Hat does not recommend using them in production. These features provide early access to upcoming product features, enabling customers to test functionality and provide feedback during the development process.

For more information about the support scope of Red Hat Technology Preview features, see [Technology Preview Features Support Scope](#).

RDMA over Converged Ethernet (RoCE) is the only supported mode when using RDMA on OpenShift Container Platform.

### Prerequisites

- Install the OpenShift CLI (**oc**).
- Install the SR-IOV Network Operator.
- Log in as a user with **cluster-admin** privileges.

### Procedure

1. Create the following **SriovNetworkNodePolicy** object, and then save the YAML in the **mlx-rdma-node-policy.yaml** file.

```
apiVersion: sriovnetwork.openshift.io/v1
kind: SriovNetworkNodePolicy
metadata:
 name: mlx-rdma-node-policy
 namespace: openshift-sriov-network-operator
spec:
 resourceName: mlxnic
 nodeSelector:
 feature.node.kubernetes.io/network-sriov.capable: "true"
 priority: <priority>
 numVfs: <num>
 nicSelector:
 vendor: "15b3"
 deviceID: "1015" 1
 pfNames: ["<pf_name>", ...]
 rootDevices: ["<pci_bus_id>", "..."]
 deviceType: netdevice 2
 isRdma: true 3
```

- 1 Specify the device hex code of the SR-IOV network device.
- 2 Specify the driver type for the virtual functions to **netdevice**.
- 3 Enable RDMA mode.

**NOTE**

See the **Configuring SR-IOV network devices** section for a detailed explanation on each option in **SriovNetworkNodePolicy**.

When applying the configuration specified in a **SriovNetworkNodePolicy** object, the SR-IOV Operator may drain the nodes, and in some cases, reboot nodes. It may take several minutes for a configuration change to apply. Ensure that there are enough available nodes in your cluster to handle the evicted workload beforehand.

After the configuration update is applied, all the pods in the **openshift-sriov-network-operator** namespace will change to a **Running** status.

2. Create the **SriovNetworkNodePolicy** object by running the following command:

```
$ oc create -f mlx-rdma-node-policy.yaml
```

3. Create the following **SriovNetwork** object, and then save the YAML in the **mlx-rdma-network.yaml** file.

```
apiVersion: sriovnetwork.openshift.io/v1
kind: SriovNetwork
metadata:
 name: mlx-rdma-network
 namespace: openshift-sriov-network-operator
spec:
 networkNamespace: <target_namespace>
 ipam: |- ❶
 # ...
 vlan: <vlan>
 resourceName: mlxnic
```

- ❶ Specify a configuration object for the ipam CNI plugin as a YAML block scalar. The plugin manages IP address assignment for the attachment definition.

**NOTE**

See the "Configuring SR-IOV additional network" section for a detailed explanation on each option in **SriovNetwork**.

An optional library, `app-netutil`, provides several API methods for gathering network information about a container's parent pod.

4. Create the **SriovNetworkNodePolicy** object by running the following command:

```
$ oc create -f mlx-rdma-network.yaml
```

5. Create the following **Pod** spec, and then save the YAML in the **mlx-rdma-pod.yaml** file.

```
apiVersion: v1
kind: Pod
metadata:
```

```

name: rdma-app
namespace: <target_namespace> ❶
annotations:
 k8s.v1.cni.cncf.io/networks: mlx-rdma-network
spec:
 containers:
 - name: testpmd
 image: <RDMA_image> ❷
 securityContext:
 runAsUser: 0
 capabilities:
 add: ["IPC_LOCK", "SYS_RESOURCE", "NET_RAW"] ❸
 volumeMounts:
 - mountPath: /mnt/huge ❹
 name: hugepage
 resources:
 limits:
 memory: "1Gi"
 cpu: "4" ❺
 hugepages-1Gi: "4Gi" ❻
 requests:
 memory: "1Gi"
 cpu: "4"
 hugepages-1Gi: "4Gi"
 command: ["sleep", "infinity"]
 volumes:
 - name: hugepage
 emptyDir:
 medium: HugePages

```

- ❶ Specify the same **target\_namespace** where **SriovNetwork** object **mlx-rdma-network** is created. If you would like to create the pod in a different namespace, change **target\_namespace** in both **Pod** spec and **SriovNetwork** object.
- ❷ Specify the RDMA image which includes your application and RDMA library used by application.
- ❸ Specify additional capabilities required by the application inside the container for hugepage allocation, system resource allocation, and network interface access.
- ❹ Mount the hugepage volume to RDMA pod under **/mnt/huge**. The hugepage volume is backed by the emptyDir volume type with the medium being **Hugepages**.
- ❺ Specify number of CPUs. The RDMA pod usually requires exclusive CPUs be allocated from the kubelet. This is achieved by setting CPU Manager policy to **static** and create pod with **Guaranteed** QoS.
- ❻ Specify hugepage size **hugepages-1Gi** or **hugepages-2Mi** and the quantity of hugepages that will be allocated to the RDMA pod. Configure **2Mi** and **1Gi** hugepages separately. Configuring **1Gi** hugepage requires adding kernel arguments to Nodes.

6. Create the RDMA pod by running the following command:

```
$ oc create -f mlx-rdma-pod.yaml
```

## 27.10.7. A test pod template for clusters that use OVS-DPDK on OpenStack

The following **testpmd** pod demonstrates container creation with huge pages, reserved CPUs, and the SR-IOV port.

### An example **testpmd** pod

```

apiVersion: v1
kind: Pod
metadata:
 name: testpmd-dpdk
 namespace: mynamespace
 annotations:
 cpu-load-balancing.crio.io: "disable"
 cpu-quota.crio.io: "disable"
...
spec:
 containers:
 - name: testpmd
 command: ["sleep", "99999"]
 image: registry.redhat.io/openshift4/dpdk-base-rhel8:v4.9
 securityContext:
 capabilities:
 add: ["IPC_LOCK", "SYS_ADMIN"]
 privileged: true
 runAsUser: 0
 resources:
 requests:
 memory: 1000Mi
 hugepages-1Gi: 1Gi
 cpu: '2'
 openshift.io/dpdk1: 1 1
 limits:
 hugepages-1Gi: 1Gi
 cpu: '2'
 memory: 1000Mi
 openshift.io/dpdk1: 1
 volumeMounts:
 - mountPath: /mnt/huge
 name: hugepage
 readOnly: False
 runtimeClassName: performance-cnf-performanceprofile 2
 volumes:
 - name: hugepage
 emptyDir:
 medium: HugePages

```

1 The name **dpdk1** in this example is a user-created **SriovNetworkNodePolicy** resource. You can substitute this name for that of a resource that you create.

2 If your performance profile is not named **cnf-performance profile**, replace that string with the correct performance profile name.

## 27.10.8. A test pod template for clusters that use OVS hardware offloading on OpenStack

The following **testpmd** pod demonstrates Open vSwitch (OVS) hardware offloading on Red Hat OpenStack Platform (RHOSP).

### An example testpmd pod

```

apiVersion: v1
kind: Pod
metadata:
 name: testpmd-sriov
 namespace: mynamespace
 annotations:
 k8s.v1.cni.cncf.io/networks: hwoffload1
spec:
 runtimeClassName: performance-cnf-performanceprofile 1
 containers:
 - name: testpmd
 command: ["sleep", "99999"]
 image: registry.redhat.io/openshift4/dpdk-base-rhel8:v4.9
 securityContext:
 capabilities:
 add: ["IPC_LOCK", "SYS_ADMIN"]
 privileged: true
 runAsUser: 0
 resources:
 requests:
 memory: 1000Mi
 hugepages-1Gi: 1Gi
 cpu: '2'
 limits:
 hugepages-1Gi: 1Gi
 cpu: '2'
 memory: 1000Mi
 volumeMounts:
 - mountPath: /mnt/huge
 name: hugepage
 readOnly: False
 volumes:
 - name: hugepage
 emptyDir:
 medium: HugePages

```

**1** If your performance profile is not named **cnf-performance profile**, replace that string with the correct performance profile name.

## 27.10.9. Additional resources

- [Creating a performance profile](#)
- [Adjusting the NIC queues with the performance profile](#)
- [Provisioning real-time and low latency workloads](#)

- [Installing the SR-IOV Network Operator](#)
- [Configuring an SR-IOV network device](#)
- [Dynamic IP address assignment configuration with Whereabouts](#)
- [Disabling interrupt processing for individual pods](#)
- [Configuring an SR-IOV Ethernet network attachment](#)
- The [app-netutil library](#) provides several API methods for gathering network information about a container's parent pod.

## 27.11. USING POD-LEVEL BONDING

Bonding at the pod level is vital to enable workloads inside pods that require high availability and more throughput. With pod-level bonding, you can create a bond interface from multiple single root I/O virtualization (SR-IOV) virtual function interfaces in a kernel mode interface. The SR-IOV virtual functions are passed into the pod and attached to a kernel driver.

One scenario where pod level bonding is required is creating a bond interface from multiple SR-IOV virtual functions on different physical functions. Creating a bond interface from two different physical functions on the host can be used to achieve high availability and throughput at pod level.

For guidance on tasks such as creating a SR-IOV network, network policies, network attachment definitions and pods, see [Configuring an SR-IOV network device](#).

### 27.11.1. Configuring a bond interface from two SR-IOV interfaces

Bonding enables multiple network interfaces to be aggregated into a single logical "bonded" interface. Bond Container Network Interface (Bond-CNI) brings bond capability into containers.

Bond-CNI can be created using Single Root I/O Virtualization (SR-IOV) virtual functions and placing them in the container network namespace.

OpenShift Container Platform only supports Bond-CNI using SR-IOV virtual functions. The SR-IOV Network Operator provides the SR-IOV CNI plugin needed to manage the virtual functions. Other CNIs or types of interfaces are not supported.

#### Prerequisites

- The SR-IOV Network Operator must be installed and configured to obtain virtual functions in a container.
- To configure SR-IOV interfaces, an SR-IOV network and policy must be created for each interface.
- The SR-IOV Network Operator creates a network attachment definition for each SR-IOV interface, based on the SR-IOV network and policy defined.
- The **linkState** is set to the default value **auto** for the SR-IOV virtual function.

#### 27.11.1.1. Creating a bond network attachment definition

Now that the SR-IOV virtual functions are available, you can create a bond network attachment definition.

```

apiVersion: "k8s.cni.cncf.io/v1"
kind: NetworkAttachmentDefinition
metadata:
 name: bond-net1
 namespace: demo
spec:
 config: '{
 "type": "bond", ①
 "cniVersion": "0.3.1",
 "name": "bond-net1",
 "mode": "active-backup", ②
 "failOverMac": 1, ③
 "linksInContainer": true, ④
 "miimon": "100",
 "mtu": 1500,
 "links": [⑤
 {"name": "net1"},
 {"name": "net2"}
],
 "ipam": {
 "type": "host-local",
 "subnet": "10.56.217.0/24",
 "routes": [{
 "dst": "0.0.0.0/0"
 }],
 "gateway": "10.56.217.1"
 }
 }'

```

- ① The **cni-type** is always set to **bond**.
- ② The **mode** attribute specifies the bonding mode.



#### NOTE

The bonding modes supported are:

- **balance-rr** - 0
- **active-backup** - 1
- **balance-xor** - 2

For **balance-rr** or **balance-xor** modes, you must set the **trust** mode to **on** for the SR-IOV virtual function.

- ③ The **failover** attribute is mandatory for active-backup mode and must be set to 1.
- ④ The **linksInContainer=true** flag informs the Bond CNI that the required interfaces are to be found inside the container. By default, Bond CNI looks for these interfaces on the host which does not work for integration with SRIOV and Multus.
- ⑤ The **links** section defines which interfaces will be used to create the bond. By default, Multus names the attached interfaces as: "net", plus a consecutive number, starting with one.

### 27.11.1.2. Creating a pod using a bond interface

1. Test the setup by creating a pod with a YAML file named for example **podbonding.yaml** with content similar to the following:

```
apiVersion: v1
kind: Pod
metadata:
 name: bondpod1
 namespace: demo
 annotations:
 k8s.v1.cni.cncf.io/networks: demo/sriovnet1, demo/sriovnet2, demo/bond-net1 1
spec:
 containers:
 - name: podexample
 image: quay.io/openshift/origin-network-interface-bond-cni:4.11.0
 command: ["/bin/bash", "-c", "sleep INF"]
```

- 1** Note the network annotation: it contains two SR-IOV network attachments, and one bond network attachment. The bond attachment uses the two SR-IOV interfaces as bonded port interfaces.

2. Apply the yaml by running the following command:

```
$ oc apply -f podbonding.yaml
```

3. Inspect the pod interfaces with the following command:

```
$ oc rsh -n demo bondpod1
sh-4.4#
sh-4.4# ip a
1: lo: <LOOPBACK,UP,LOWER_UP> mtu 65536 qdisc noqueue state UNKNOWN qlen 1000
link/loopback 00:00:00:00:00:00 brd 00:00:00:00:00:00
inet 127.0.0.1/8 scope host lo
valid_lft forever preferred_lft forever
3: eth0@if150: <BROADCAST,MULTICAST,UP,LOWER_UP,M-DOWN> mtu 1450 qdisc
noqueue state UP
link/ether 62:b1:b5:c8:fb:7a brd ff:ff:ff:ff:ff:ff
inet 10.244.1.122/24 brd 10.244.1.255 scope global eth0
valid_lft forever preferred_lft forever
4: net3: <BROADCAST,MULTICAST,UP,LOWER_UP400> mtu 1500 qdisc noqueue state
UP qlen 1000
link/ether 9e:23:69:42:fb:8a brd ff:ff:ff:ff:ff:ff 1
inet 10.56.217.66/24 scope global bond0
valid_lft forever preferred_lft forever
43: net1: <BROADCAST,MULTICAST,UP,LOWER_UP800> mtu 1500 qdisc mq master
bond0 state UP qlen 1000
link/ether 9e:23:69:42:fb:8a brd ff:ff:ff:ff:ff:ff 2
44: net2: <BROADCAST,MULTICAST,UP,LOWER_UP800> mtu 1500 qdisc mq master
bond0 state UP qlen 1000
link/ether 9e:23:69:42:fb:8a brd ff:ff:ff:ff:ff:ff 3
```

- 1** The bond interface is automatically named **net3**. To set a specific interface name add **@name** suffix to the pod's **k8s.v1.cni.cncf.io/networks** annotation.



- 2 The **net1** interface is based on an SR-IOV virtual function.
- 3 The **net2** interface is based on an SR-IOV virtual function.



#### NOTE

If no interface names are configured in the pod annotation, interface names are assigned automatically as **net<n>**, with **<n>** starting at **1**.

4. Optional: If you want to set a specific interface name for example **bond0**, edit the **k8s.v1.cni.cncf.io/networks** annotation and set **bond0** as the interface name as follows:

annotations:

```
k8s.v1.cni.cncf.io/networks: demo/sriovnet1, demo/sriovnet2, demo/bond-net1@bond0
```

## 27.12. CONFIGURING HARDWARE OFFLOADING

As a cluster administrator, you can configure hardware offloading on compatible nodes to increase data processing performance and reduce load on host CPUs.

### 27.12.1. About hardware offloading

Open vSwitch hardware offloading is a method of processing network tasks by diverting them away from the CPU and offloading them to a dedicated processor on a network interface controller. As a result, clusters can benefit from faster data transfer speeds, reduced CPU workloads, and lower computing costs.

The key element for this feature is a modern class of network interface controllers known as SmartNICs. A SmartNIC is a network interface controller that is able to handle computationally-heavy network processing tasks. In the same way that a dedicated graphics card can improve graphics performance, a SmartNIC can improve network performance. In each case, a dedicated processor improves performance for a specific type of processing task.

In OpenShift Container Platform, you can configure hardware offloading for bare metal nodes that have a compatible SmartNIC. Hardware offloading is configured and enabled by the SR-IOV Network Operator.

Hardware offloading is not compatible with all workloads or application types. Only the following two communication types are supported:

- pod-to-pod
- pod-to-service, where the service is a ClusterIP service backed by a regular pod

In all cases, hardware offloading takes place only when those pods and services are assigned to nodes that have a compatible SmartNIC. Suppose, for example, that a pod on a node with hardware offloading tries to communicate with a service on a regular node. On the regular node, all the processing takes place in the kernel, so the overall performance of the pod-to-service communication is limited to the maximum performance of that regular node. Hardware offloading is not compatible with DPDK applications.

Enabling hardware offloading on a node, but not configuring pods to use, it can result in decreased throughput performance for pod traffic. You cannot configure hardware offloading for pods that are managed by OpenShift Container Platform.

## 27.12.2. Supported devices

Hardware offloading is supported on the following network interface controllers:

**Table 27.15. Supported network interface controllers**

Manufacturer	Model	Vendor ID	Device ID
Mellanox	MT27800 Family [ConnectX-5]	15b3	1017
Mellanox	MT28880 Family [ConnectX-5 Ex]	15b3	1019
Mellanox	MT2892 Family [ConnectX-6 Dx]	15b3	101d
Mellanox	MT2894 Family [ConnectX-6 Lx]	15b3	101f
Mellanox	MT42822 BlueField-2 in ConnectX-6 NIC mode	15b3	a2d6

## 27.12.3. Prerequisites

- Your cluster has at least one bare metal machine with a network interface controller that is supported for hardware offloading.
- You [installed the SR-IOV Network Operator](#).
- Your cluster uses the [OVN-Kubernetes network plugin](#).
- In your [OVN-Kubernetes network plugin configuration](#), the `gatewayConfig.routingViaHost` field is set to **false**.

## 27.12.4. Configuring a machine config pool for hardware offloading

To enable hardware offloading, you must first create a dedicated machine config pool and configure it to work with the SR-IOV Network Operator.

### Prerequisites

- You installed the OpenShift CLI (**oc**).
- You have access to the cluster as a user with the **cluster-admin** role.

### Procedure

1. Create a machine config pool for machines you want to use hardware offloading on.
  - a. Create a file, such as **mcp-offloading.yaml**, with content like the following example:

```
apiVersion: machineconfiguration.openshift.io/v1
kind: MachineConfigPool
metadata:
 name: mcp-offloading 1
spec:
```

```

machineConfigSelector:
 matchExpressions:
 - {key: machineconfiguration.openshift.io/role, operator: In, values: [worker,mcp-
offloading]} ❷
 nodeSelector:
 matchLabels:
 node-role.kubernetes.io/mcp-offloading: "" ❸

```

❶ ❷ The name of your machine config pool for hardware offloading.

❸ This node role label is used to add nodes to the machine config pool.

b. Apply the configuration for the machine config pool:

```
$ oc create -f mcp-offloading.yaml
```

2. Add nodes to the machine config pool. Label each node with the node role label of your pool:

```
$ oc label node worker-2 node-role.kubernetes.io/mcp-offloading=""
```

3. Optional: To verify that the new pool is created, run the following command:

```
$ oc get nodes
```

### Example output

```

NAME STATUS ROLES AGE VERSION
master-0 Ready master 2d v1.28.5
master-1 Ready master 2d v1.28.5
master-2 Ready master 2d v1.28.5
worker-0 Ready worker 2d v1.28.5
worker-1 Ready worker 2d v1.28.5
worker-2 Ready mcp-offloading,worker 47h v1.28.5
worker-3 Ready mcp-offloading,worker 47h v1.28.5

```

4. Add this machine config pool to the **SriovNetworkPoolConfig** custom resource:

a. Create a file, such as **sriov-pool-config.yaml**, with content like the following example:

```

apiVersion: sriovnetwork.openshift.io/v1
kind: SriovNetworkPoolConfig
metadata:
 name: sriovnetworkpoolconfig-offload
 namespace: openshift-sriov-network-operator
spec:
 ovsHardwareOffloadConfig:
 name: mcp-offloading ❶

```

❶ The name of your machine config pool for hardware offloading.

b. Apply the configuration:

```
$ oc create -f <SriovNetworkPoolConfig_name>.yaml
```



## NOTE

When you apply the configuration specified in a **SriovNetworkPoolConfig** object, the SR-IOV Operator drains and restarts the nodes in the machine config pool.

It might take several minutes for a configuration changes to apply.

### 27.12.5. Configuring the SR-IOV network node policy

You can create an SR-IOV network device configuration for a node by creating an SR-IOV network node policy. To enable hardware offloading, you must define the **.spec.eSwitchMode** field with the value **"switchdev"**.

The following procedure creates an SR-IOV interface for a network interface controller with hardware offloading.

#### Prerequisites

- You installed the OpenShift CLI (**oc**).
- You have access to the cluster as a user with the **cluster-admin** role.

#### Procedure

1. Create a file, such as **sriov-node-policy.yaml**, with content like the following example:

```
apiVersion: sriovnetwork.openshift.io/v1
kind: SriovNetworkNodePolicy
metadata:
 name: sriov-node-policy 1
 namespace: openshift-sriov-network-operator
spec:
 deviceType: netdevice 2
 eSwitchMode: "switchdev" 3
 nicSelector:
 deviceID: "1019"
 rootDevices:
 - 0000:d8:00.0
 vendor: "15b3"
 pfNames:
 - ens8f0
 nodeSelector:
 feature.node.kubernetes.io/network-sriov.capable: "true"
 numVfs: 6
 priority: 5
 resourceName: mlxnic
```

- 1 The name for the custom resource object.
- 2 Required. Hardware offloading is not supported with **vfio-pci**.

**3** Required.

2. Apply the configuration for the policy:

```
$ oc create -f sriov-node-policy.yaml
```



#### NOTE

When you apply the configuration specified in a **SriovNetworkPoolConfig** object, the SR-IOV Operator drains and restarts the nodes in the machine config pool.

It might take several minutes for a configuration change to apply.

### 27.12.5.1. An example SR-IOV network node policy for OpenStack

The following example describes an SR-IOV interface for a network interface controller (NIC) with hardware offloading on Red Hat OpenStack Platform (RHOSP).

#### An SR-IOV interface for a NIC with hardware offloading on RHOSP

```
apiVersion: sriovnetwork.openshift.io/v1
kind: SriovNetworkNodePolicy
metadata:
 name: ${name}
 namespace: openshift-sriov-network-operator
spec:
 deviceType: switchdev
 isRdma: true
 nicSelector:
 netFilter: openstack/NetworkID:${net_id}
 nodeSelector:
 feature.node.kubernetes.io/network-sriov.capable: 'true'
 numVfs: 1
 priority: 99
 resourceName: ${name}
```

### 27.12.6. Improving network traffic performance using a virtual function

Follow this procedure to assign a virtual function to the OVN-Kubernetes management port and increase its network traffic performance.

This procedure results in the creation of two pools: the first has a virtual function used by OVN-Kubernetes, and the second comprises the remaining virtual functions.

#### Prerequisites

- You installed the OpenShift CLI (**oc**).
- You have access to the cluster as a user with the **cluster-admin** role.

#### Procedure

1. Add the **network.operator.openshift.io/smart-nic** label to each worker node with a SmartNIC present by running the following command:

```
$ oc label node <node-name> network.operator.openshift.io/smart-nic=
```

Use the **oc get nodes** command to get a list of the available nodes.

2. Create a policy named **sriov-node-mgmt-vf-policy.yaml** for the management port with content such as the following example:

```
apiVersion: sriovnetwork.openshift.io/v1
kind: SriovNetworkNodePolicy
metadata:
 name: sriov-node-mgmt-vf-policy
 namespace: openshift-sriov-network-operator
spec:
 deviceType: netdevice
 eSwitchMode: "switchdev"
 nicSelector:
 deviceID: "1019"
 rootDevices:
 - 0000:d8:00.0
 vendor: "15b3"
 pfNames:
 - ens8f0#0-0 1
 nodeSelector:
 network.operator.openshift.io/smart-nic: ""
 numVfs: 6 2
 priority: 5
 resourceName: mgmtvf
```

- 1 Replace this device with the appropriate network device for your use case. The **#0-0** part of the **pfNames** value reserves a single virtual function used by OVN-Kubernetes.
- 2 The value provided here is an example. Replace this value with one that meets your requirements. For more information, see *SR-IOV network node configuration object* in the *Additional resources* section.

3. Create a policy named **sriov-node-policy.yaml** with content such as the following example:

```
apiVersion: sriovnetwork.openshift.io/v1
kind: SriovNetworkNodePolicy
metadata:
 name: sriov-node-policy
 namespace: openshift-sriov-network-operator
spec:
 deviceType: netdevice
 eSwitchMode: "switchdev"
 nicSelector:
 deviceID: "1019"
 rootDevices:
 - 0000:d8:00.0
 vendor: "15b3"
 pfNames:
```

```
- ens8f0#1-5 1
nodeSelector:
 network.operator.openshift.io/smart-nic: ""
numVfs: 6 2
priority: 5
resourceName: mlxnic
```

- 1** Replace this device with the appropriate network device for your use case.
- 2** The value provided here is an example. Replace this value with the value specified in the **sriov-node-mgmt-vf-policy.yaml** file. For more information, see *SR-IOV network node configuration object* in the *Additional resources* section.



## NOTE

The **sriov-node-mgmt-vf-policy.yaml** file has different values for the **pfNames** and **resourceName** keys than the **sriov-node-policy.yaml** file.

4. Apply the configuration for both policies:

```
$ oc create -f sriov-node-policy.yaml
```

```
$ oc create -f sriov-node-mgmt-vf-policy.yaml
```

5. Create a Cluster Network Operator (CNO) ConfigMap in the cluster for the management configuration:
  - a. Create a ConfigMap named **hardware-offload-config.yaml** with the following contents:

```
apiVersion: v1
kind: ConfigMap
metadata:
 name: hardware-offload-config
 namespace: openshift-network-operator
data:
 mgmt-port-resource-name: openshift.io/mgmtvf
```

- b. Apply the configuration for the ConfigMap:

```
$ oc create -f hardware-offload-config.yaml
```

### Additional resources

- [SR-IOV network node configuration object](#)

## 27.12.7. Creating a network attachment definition

After you define the machine config pool and the SR-IOV network node policy, you can create a network attachment definition for the network interface card you specified.

### Prerequisites

- You installed the OpenShift CLI (**oc**).
- You have access to the cluster as a user with the **cluster-admin** role.

## Procedure

1. Create a file, such as **net-attach-def.yaml**, with content like the following example:

```
apiVersion: "k8s.cni.cncf.io/v1"
kind: NetworkAttachmentDefinition
metadata:
 name: net-attach-def 1
 namespace: net-attach-def 2
 annotations:
 k8s.v1.cni.cncf.io/resourceName: openshift.io/mlxnics 3
spec:
 config: '{"cniVersion":"0.3.1","name":"ovn-kubernetes","type":"ovn-k8s-cni-overlay","ipam":
 {}, "dns":{}}'
```

- 1** The name for your network attachment definition.
- 2** The namespace for your network attachment definition.
- 3** This is the value of the **spec.resourceName** field you specified in the **SriovNetworkNodePolicy** object.

2. Apply the configuration for the network attachment definition:

```
$ oc create -f net-attach-def.yaml
```

## Verification

- Run the following command to see whether the new definition is present:

```
$ oc get net-attach-def -A
```

### Example output

```
NAMESPACE NAME AGE
net-attach-def net-attach-def 43h
```

## 27.12.8. Adding the network attachment definition to your pods

After you create the machine config pool, the **SriovNetworkPoolConfig** and **SriovNetworkNodePolicy** custom resources, and the network attachment definition, you can apply these configurations to your pods by adding the network attachment definition to your pod specifications.

## Procedure

- In the pod specification, add the **.metadata.annotations.k8s.v1.cni.cncf.io/networks** field and specify the network attachment definition you created for hardware offloading:



```
....
metadata:
 annotations:
 v1.multus-cni.io/default-network: net-attach-def/net-attach-def 1
```

- 1 The value must be the name and namespace of the network attachment definition you created for hardware offloading.

## 27.13. SWITCHING BLUEFIELD-2 FROM DPU TO NIC

You can switch the Bluefield-2 network device from data processing unit (DPU) mode to network interface controller (NIC) mode.

### 27.13.1. Switching Bluefield-2 from DPU mode to NIC mode

Use the following procedure to switch Bluefield-2 from data processing units (DPU) mode to network interface controller (NIC) mode.



#### IMPORTANT

Currently, only switching Bluefield-2 from DPU to NIC mode is supported. Switching from NIC mode to DPU mode is unsupported.

#### Prerequisites

- You have installed the SR-IOV Network Operator. For more information, see "Installing SR-IOV Network Operator".
- You have updated Bluefield-2 to the latest firmware. For more information, see [Firmware for NVIDIA BlueField-2](#).

#### Procedure

1. Add the following labels to each of your worker nodes by entering the following commands:

```
$ oc label node <example_node_name_one> node-role.kubernetes.io/sriov=
```

```
$ oc label node <example_node_name_two> node-role.kubernetes.io/sriov=
```

2. Create a machine config pool for the SR-IOV Network Operator, for example:

```
apiVersion: machineconfiguration.openshift.io/v1
kind: MachineConfigPool
metadata:
 name: sriov
spec:
 machineConfigSelector:
 matchExpressions:
 - {key: machineconfiguration.openshift.io/role, operator: In, values: [worker,sriov]}
 nodeSelector:
 matchLabels:
 node-role.kubernetes.io/sriov: ""
```

3. Apply the following **machineconfig.yaml** file to the worker nodes:

```

apiVersion: machineconfiguration.openshift.io/v1
kind: MachineConfig
metadata:
 labels:
 machineconfiguration.openshift.io/role: sriov
 name: 99-bf2-dpu
spec:
 config:
 ignition:
 version: 3.2.0
 storage:
 files:
 - contents:
 source: data:text/plain;charset=utf-
8;base64,ZmluZF9jb250YWluZXI0KSB7CiAgY3JpY3RsIHBzIC1vIGpzb24gfCBqcSAtdciAnLmNv
bnRhaW5lcnNbXSB8IHNIbGVjdCgubWV0YWRhdGEubmFtZT09InNyaW92LW5ldHdvcnstY29
uZmlnLWRhZW1vbiIpIHwgLmlkLmJpY3R5dGlsIG91dHB1dD0kKGZpbmRfY29udGFpbmVyKT
sgW1sgLW4gliRvdXRwdXQiIF1dOyBkbwogIGVjaG8gIndhaXRpbmZmZmZmZmZmZmZmZmZmZm
0byBjb21lIHVwIlgogIHNSZWVwIDE7CmRvbmUKISBzdWRvIGNyaWN0bCBleGVjIHRvdXRwdX
QgL2JpbmRhdGEvc2NyaXB0cy9iZjltc3dpdGNoLW1vZGUuc2ggliRAIgo=
 mode: 0755
 overwrite: true
 path: /etc/default/switch_in_sriov_config_daemon.sh
 - name: dpu-switch.service
 enabled: true
 contents: |
 [Unit]
 Description=Switch BlueField2 card to NIC/DPU mode
 RequiresMountsFor=%t/containers
 Wants=network.target
 After=network-online.target kubelet.service
 [Service]
 SuccessExitStatus=0 120
 RemainAfterExit=True
 ExecStart=/bin/bash -c '/etc/default/switch_in_sriov_config_daemon.sh nic || shutdown
-r now' 1
 Type=oneshot
 [Install]
 WantedBy=multi-user.target

```

- 1** Optional: The PCI address of a specific card can optionally be specified, for example **ExecStart=/bin/bash -c '/etc/default/switch\_in\_sriov\_config\_daemon.sh nic 0000:5e:00:0 || echo done'**. By default, the first device is selected. If there is more than one device, you must specify which PCI address to be used. The PCI address must be the same on all nodes that are switching Bluefield-2 from DPU mode to NIC mode.

4. Wait for the worker nodes to restart. After restarting, the Bluefield-2 network device on the worker nodes is switched into NIC mode.

#### Additional resources

## 27.14. UNINSTALLING THE SR-IOV NETWORK OPERATOR

To uninstall the SR-IOV Network Operator, you must delete any running SR-IOV workloads, uninstall the Operator, and delete the webhooks that the Operator used.

### 27.14.1. Uninstalling the SR-IOV Network Operator

As a cluster administrator, you can uninstall the SR-IOV Network Operator.

#### Prerequisites

- You have access to an OpenShift Container Platform cluster using an account with **cluster-admin** permissions.
- You have the SR-IOV Network Operator installed.

#### Procedure

1. Delete all SR-IOV custom resources (CRs):

```
$ oc delete sriovnetwork -n openshift-sriov-network-operator --all
```

```
$ oc delete sriovnetworknodepolicy -n openshift-sriov-network-operator --all
```

```
$ oc delete sriovibnetwork -n openshift-sriov-network-operator --all
```

2. Follow the instructions in the "Deleting Operators from a cluster" section to remove the SR-IOV Network Operator from your cluster.
3. Delete the SR-IOV custom resource definitions that remain in the cluster after the SR-IOV Network Operator is uninstalled:

```
$ oc delete crd sriovibnetworks.sriovnetwork.openshift.io
```

```
$ oc delete crd sriovnetworknodepolicies.sriovnetwork.openshift.io
```

```
$ oc delete crd sriovnetworknodestates.sriovnetwork.openshift.io
```

```
$ oc delete crd sriovnetworkpoolconfigs.sriovnetwork.openshift.io
```

```
$ oc delete crd sriovnetworks.sriovnetwork.openshift.io
```

```
$ oc delete crd sriovoperatorconfigs.sriovnetwork.openshift.io
```

4. Delete the SR-IOV webhooks:

```
$ oc delete mutatingwebhookconfigurations network-resources-injector-config
```

```
$ oc delete MutatingWebhookConfiguration sriov-operator-webhook-config
```

```
$ oc delete ValidatingWebhookConfiguration sriov-operator-webhook-config
```

5. Delete the SR-IOV Network Operator namespace:

```
$ oc delete namespace openshift-sriov-network-operator
```

### Additional resources

- [Deleting Operators from a cluster](#)

## CHAPTER 28. OVN-KUBERNETES NETWORK PLUGIN

### 28.1. ABOUT THE OVN-KUBERNETES NETWORK PLUGIN

The OpenShift Container Platform cluster uses a virtualized network for pod and service networks.

Part of Red Hat OpenShift Networking, the OVN-Kubernetes network plugin is the default network provider for OpenShift Container Platform. OVN-Kubernetes is based on Open Virtual Network (OVN) and provides an overlay-based networking implementation. A cluster that uses the OVN-Kubernetes plugin also runs Open vSwitch (OVS) on each node. OVN configures OVS on each node to implement the declared network configuration.



#### NOTE

OVN-Kubernetes is the default networking solution for OpenShift Container Platform and single-node OpenShift deployments.

OVN-Kubernetes, which arose from the OVS project, uses many of the same constructs, such as open flow rules, to determine how packets travel through the network. For more information, see the [Open Virtual Network website](#).

OVN-Kubernetes is a series of daemons for OVS that translate virtual network configurations into **OpenFlow** rules. **OpenFlow** is a protocol for communicating with network switches and routers, providing a means for remotely controlling the flow of network traffic on a network device, allowing network administrators to configure, manage, and monitor the flow of network traffic.

OVN-Kubernetes provides more of the advanced functionality not available with **OpenFlow**. OVN supports distributed virtual routing, distributed logical switches, access control, DHCP and DNS. OVN implements distributed virtual routing within logic flows which equate to open flows. So for example if you have a pod that sends out a DHCP request on the network, it sends out that broadcast looking for DHCP address there will be a logic flow rule that matches that packet, and it responds giving it a gateway, a DNS server an IP address and so on.

OVN-Kubernetes runs a daemon on each node. There are daemon sets for the databases and for the OVN controller that run on every node. The OVN controller programs the Open vSwitch daemon on the nodes to support the network provider features; egress IPs, firewalls, routers, hybrid networking, IPSEC encryption, IPv6, network policy, network policy logs, hardware offloading and multicast.

#### 28.1.1. OVN-Kubernetes purpose

The OVN-Kubernetes network plugin is an open-source, fully-featured Kubernetes CNI plugin that uses Open Virtual Network (OVN) to manage network traffic flows. OVN is a community developed, vendor-agnostic network virtualization solution. The OVN-Kubernetes network plugin:

- Uses OVN (Open Virtual Network) to manage network traffic flows. OVN is a community developed, vendor-agnostic network virtualization solution.
- Implements Kubernetes network policy support, including ingress and egress rules.
- Uses the Geneve (Generic Network Virtualization Encapsulation) protocol rather than VXLAN to create an overlay network between nodes.

The OVN-Kubernetes network plugin provides the following advantages over OpenShift SDN.

- Full support for IPv6 single-stack and IPv4/IPv6 dual-stack networking on supported platforms
- Support for hybrid clusters with both Linux and Microsoft Windows workloads
- Optional IPsec encryption of intra-cluster communications
- Offload of network data processing from host CPU to compatible network cards and data processing units (DPUs)

### 28.1.2. Supported network plugin feature matrix

Red Hat OpenShift Networking offers two options for the network plugin, OpenShift SDN and OVN-Kubernetes, for the network plugin. The following table summarizes the current feature support for both network plugins:

**Table 28.1. Default CNI network plugin feature comparison**

Feature	OVN-Kubernetes	OpenShift SDN
Egress IPs	Supported	Supported
Egress firewall <sup>[1]</sup>	Supported	Supported
Egress router	Supported <sup>[2]</sup>	Supported
Hybrid networking	Supported	Not supported
IPsec encryption for intra-cluster communication	Supported	Not supported
IPv6	Supported <sup>[3][4]</sup>	Not supported
Kubernetes network policy	Supported	Supported
Kubernetes network policy logs	Supported	Not supported
Hardware offloading	Supported	Not supported
Multicast	Supported	Supported

1. Egress firewall is also known as egress network policy in OpenShift SDN. This is not the same as network policy egress.
2. Egress router for OVN-Kubernetes supports only redirect mode.
3. IPv6 is supported only on bare metal, vSphere, IBM Power®, IBM Z®, and Red Hat OpenStack clusters.
4. IPv6 single stack is not supported on IBM Power®, IBM Z®, and Red Hat OpenStack clusters.

### 28.1.3. OVN-Kubernetes IPv6 and dual-stack limitations

The OVN-Kubernetes network plugin has the following limitations:

- For clusters configured for dual-stack networking, both IPv4 and IPv6 traffic must use the same network interface as the default gateway. If this requirement is not met, pods on the host in the **ovnkube-node** daemon set enter the **CrashLoopBackOff** state. If you display a pod with a command such as **oc get pod -n openshift-ovn-kubernetes -l app=ovnkube-node -o yaml**, the **status** field contains more than one message about the default gateway, as shown in the following output:

```
I1006 16:09:50.985852 60651 helper_linux.go:73] Found default gateway interface br-ex
192.168.127.1
I1006 16:09:50.985923 60651 helper_linux.go:73] Found default gateway interface ens4
fe80::5054:ff:febe:bcd4
F1006 16:09:50.985939 60651 ovnkube.go:130] multiple gateway interfaces detected: br-ex
ens4
```

The only resolution is to reconfigure the host networking so that both IP families use the same network interface for the default gateway.

- For clusters configured for dual-stack networking, both the IPv4 and IPv6 routing tables must contain the default gateway. If this requirement is not met, pods on the host in the **ovnkube-node** daemon set enter the **CrashLoopBackOff** state. If you display a pod with a command such as **oc get pod -n openshift-ovn-kubernetes -l app=ovnkube-node -o yaml**, the **status** field contains more than one message about the default gateway, as shown in the following output:

```
I0512 19:07:17.589083 108432 helper_linux.go:74] Found default gateway interface br-ex
192.168.123.1
F0512 19:07:17.589141 108432 ovnkube.go:133] failed to get default gateway interface
```

The only resolution is to reconfigure the host networking so that both IP families contain the default gateway.

#### 28.1.4. Session affinity

Session affinity is a feature that applies to Kubernetes **Service** objects. You can use *session affinity* if you want to ensure that each time you connect to a <service\_VIP>:<Port>, the traffic is always load balanced to the same back end. For more information, including how to set session affinity based on a client's IP address, see [Session affinity](#).

##### Stickiness timeout for session affinity

The OVN-Kubernetes network plugin for OpenShift Container Platform calculates the stickiness timeout for a session from a client based on the last packet. For example, if you run a **curl** command 10 times, the sticky session timer starts from the tenth packet not the first. As a result, if the client is continuously contacting the service, then the session never times out. The timeout starts when the service has not received a packet for the amount of time set by the **timeoutSeconds** parameter.

##### Additional resources

- [Configuring an egress firewall for a project](#)
- [About network policy](#)
- [Logging network policy events](#)

- [Enabling multicast for a project](#)
- [Configuring IPsec encryption](#)
- [Network \[operator.openshift.io/v1\]](#)

## 28.2. OVN-KUBERNETES ARCHITECTURE

### 28.2.1. Introduction to OVN-Kubernetes architecture

The following diagram shows the OVN-Kubernetes architecture.



Figure 28.1. OVK-Kubernetes architecture

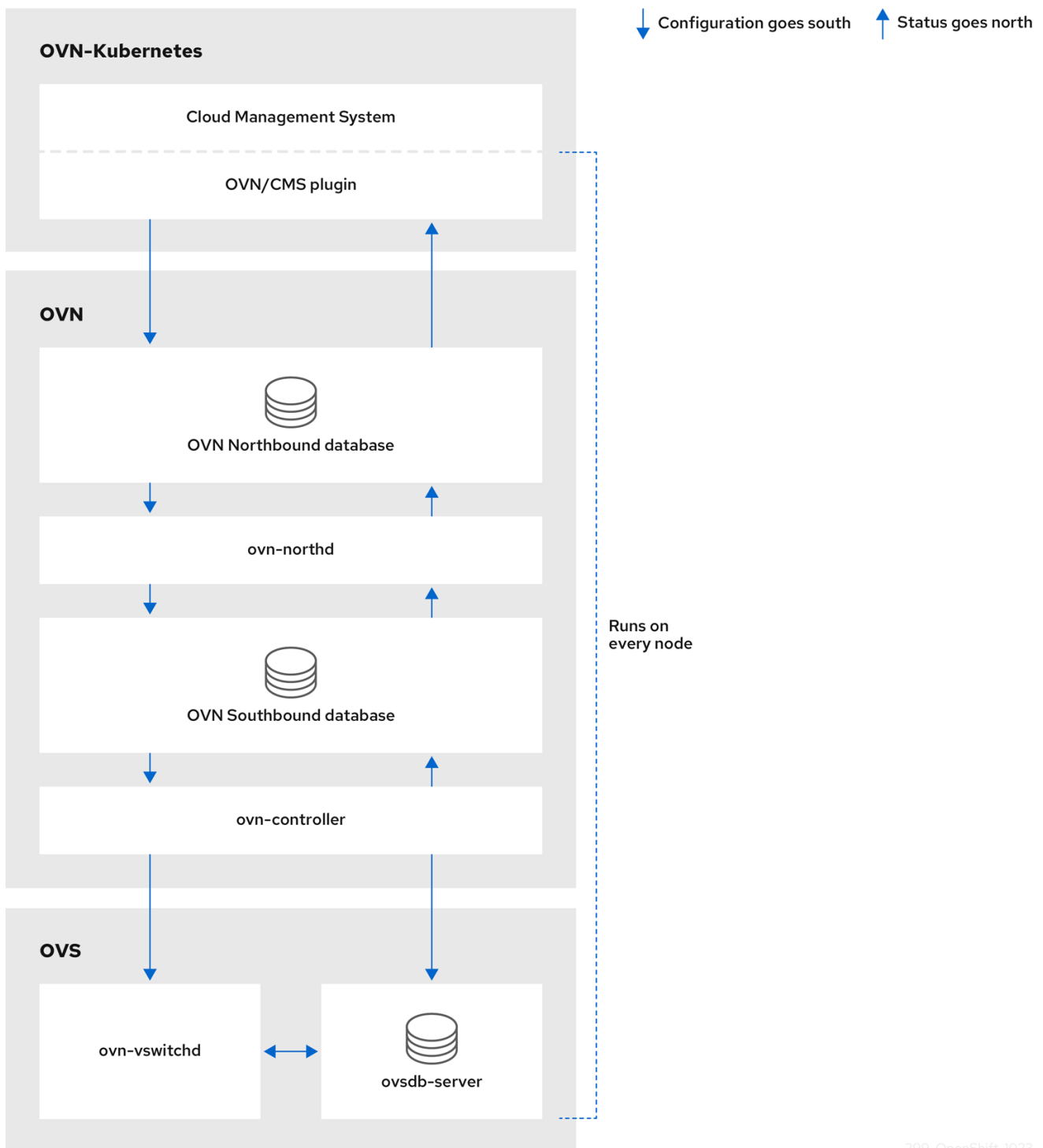

The key components are:

- **Cloud Management System (CMS)** - A platform specific client for OVN that provides a CMS specific plugin for OVN integration. The plugin translates the cloud management system's concept of the logical network configuration, stored in the CMS configuration database in a CMS-specific format, into an intermediate representation understood by OVN.
- **OVN Northbound database (nbdb) container** - Stores the logical network configuration passed by the CMS plugin.

- **OVN Southbound database (sbdb) container** - Stores the physical and logical network configuration state for Open vSwitch (OVS) system on each node, including tables that bind them.
- **OVN north daemon (ovn-northd)** - This is the intermediary client between **nbdb** container and **sbdb** container. It translates the logical network configuration in terms of conventional network concepts, taken from the **nbdb** container, into logical data path flows in the **sbdb** container. The container name for **ovn-northd** daemon is **northd** and it runs in the **ovnkube-node** pods.
- **ovn-controller** - This is the OVN agent that interacts with OVS and hypervisors, for any information or update that is needed for **sbdb** container. The **ovn-controller** reads logical flows from the **sbdb** container, translates them into **OpenFlow** flows and sends them to the node's OVS daemon. The container name is **ovn-controller** and it runs in the **ovnkube-node** pods.

The OVN northd, northbound database, and southbound database run on each node in the cluster and mostly contain and process information that is local to that node.

The OVN northbound database has the logical network configuration passed down to it by the cloud management system (CMS). The OVN northbound database contains the current desired state of the network, presented as a collection of logical ports, logical switches, logical routers, and more. The **ovn-northd (northd)** container connects to the OVN northbound database and the OVN southbound database. It translates the logical network configuration in terms of conventional network concepts, taken from the OVN northbound database, into logical data path flows in the OVN southbound database.

The OVN southbound database has physical and logical representations of the network and binding tables that link them together. It contains the chassis information of the node and other constructs like remote transit switch ports that are required to connect to the other nodes in the cluster. The OVN southbound database also contains all the logic flows. The logic flows are shared with the **ovn-controller** process that runs on each node and the **ovn-controller** turns those into **OpenFlow** rules to program **Open vSwitch (OVS)**.

The Kubernetes control plane nodes contain two **ovnkube-control-plane** pods on separate nodes, which perform the central IP address management (IPAM) allocation for each node in the cluster. At any given time, a single **ovnkube-control-plane** pod is the leader.

### 28.2.2. Listing all resources in the OVN-Kubernetes project

Finding the resources and containers that run in the OVN-Kubernetes project is important to help you understand the OVN-Kubernetes networking implementation.

#### Prerequisites

- Access to the cluster as a user with the **cluster-admin** role.
- The OpenShift CLI (**oc**) installed.

#### Procedure

1. Run the following command to get all resources, endpoints, and **ConfigMaps** in the OVN-Kubernetes project:

```
$ oc get all,ep,cm -n openshift-ovn-kubernetes
```

#### Example output

-

Warning: apps.openshift.io/v1 DeploymentConfig is deprecated in v4.14+, unavailable in v4.10000+

NAME	READY	STATUS	RESTARTS	AGE
pod/ovnkube-control-plane-65c6f55656-6d55h	2/2	Running	0	114m
pod/ovnkube-control-plane-65c6f55656-fd7vw	2/2	Running	2 (104m ago)	114m
pod/ovnkube-node-bcvts	8/8	Running	0	113m
pod/ovnkube-node-drgvv	8/8	Running	0	113m
pod/ovnkube-node-f2pxt	8/8	Running	0	113m
pod/ovnkube-node-frqsb	8/8	Running	0	105m
pod/ovnkube-node-lbxkk	8/8	Running	0	105m
pod/ovnkube-node-tt7bx	8/8	Running	1 (102m ago)	105m

NAME	TYPE	CLUSTER-IP	EXTERNAL-IP	PORT(S)	AGE
service/ovn-kubernetes-control-plane	ClusterIP	None	<none>	9108/TCP	114m
service/ovn-kubernetes-node	ClusterIP	None	<none>	9103/TCP,9105/TCP	114m

NAME	DESIRED	CURRENT	READY	UP-TO-DATE	AVAILABLE
daemonset.apps/ovnkube-node	6	6	6	6	6
beta.kubernetes.io/os=linux	114m				

NAME	READY	UP-TO-DATE	AVAILABLE	AGE
deployment.apps/ovnkube-control-plane	3/3	3	3	114m

NAME	DESIRED	CURRENT	READY	AGE
replicaset.apps/ovnkube-control-plane-65c6f55656	3	3	3	114m

NAME	ENDPOINTS	AGE
endpoints/ovn-kubernetes-control-plane	10.0.0.3:9108,10.0.0.4:9108,10.0.0.5:9108	114m
endpoints/ovn-kubernetes-node	10.0.0.3:9105,10.0.0.4:9105,10.0.0.5:9105 + 9 more...	114m

NAME	DATA	AGE
configmap/control-plane-status	1	113m
configmap/kube-root-ca.crt	1	114m
configmap/openshift-service-ca.crt	1	114m
configmap/ovn-ca	1	114m
configmap/ovnkube-config	1	114m
configmap/signer-ca	1	114m

There is one **ovnkube-node** pod for each node in the cluster. The **ovnkube-config** config map has the OpenShift Container Platform OVN-Kubernetes configurations.

- List all of the containers in the **ovnkube-node** pods by running the following command:

```
$ oc get pods ovnkube-node-bcvts -o jsonpath='{.spec.containers[*].name}' -n openshift-ovn-kubernetes
```

### Expected output

```
ovn-controller ovn-acl-logging kube-rbac-proxy-node kube-rbac-proxy-ovn-metrics northd
nbdb sbdb ovnkube-controller
```

The **ovnkube-node** pod is made up of several containers. It is responsible for hosting the northbound database (**nbdb** container), the southbound database (**sbdb** container), the north daemon (**northd** container), **ovn-controller** and the **ovnkube-controller** container. The **ovnkube-controller** container watches for API objects like pods, egress IPs, namespaces, services, endpoints, egress firewall, and network policies. It is also responsible for allocating pod IP from the available subnet pool for that node.

- List all the containers in the **ovnkube-control-plane** pods by running the following command:

```
$ oc get pods ovnkube-control-plane-65c6f55656-6d55h -o
jsonpath='{.spec.containers[*].name}' -n openshift-ovn-kubernetes
```

### Expected output

```
kube-rbac-proxy ovnkube-cluster-manager
```

The **ovnkube-control-plane** pod has a container (**ovnkube-cluster-manager**) that resides on each OpenShift Container Platform node. The **ovnkube-cluster-manager** container allocates pod subnet, transit switch subnet IP and join switch subnet IP to each node in the cluster. The **kube-rbac-proxy** container monitors metrics for the **ovnkube-cluster-manager** container.

## 28.2.3. Listing the OVN-Kubernetes northbound database contents

Each node is controlled by the **ovnkube-controller** container running in the **ovnkube-node** pod on that node. To understand the OVN logical networking entities you need to examine the northbound database that is running as a container inside the **ovnkube-node** pod on that node to see what objects are in the node you wish to see.

### Prerequisites

- Access to the cluster as a user with the **cluster-admin** role.
- The OpenShift CLI (**oc**) installed.



### PROCEDURE

To run **ovn nbctl** or **ovn sbctl** commands in a cluster you must open a remote shell into the **nbdb** or **sbdb** containers on the relevant node

- List pods by running the following command:

```
$ oc get po -n openshift-ovn-kubernetes
```

### Example output

NAME	READY	STATUS	RESTARTS	AGE
ovnkube-control-plane-8444dff7f9-4lh9k	2/2	Running	0	27m
ovnkube-control-plane-8444dff7f9-5rjh9	2/2	Running	0	27m
ovnkube-node-55xs2	8/8	Running	0	26m
ovnkube-node-7r84r	8/8	Running	0	16m
ovnkube-node-bqq8p	8/8	Running	0	17m

```

ovnkube-node-mkj4f 8/8 Running 0 26m
ovnkube-node-mlr8k 8/8 Running 0 26m
ovnkube-node-wqn2m 8/8 Running 0 16m

```

- Optional: To list the pods with node information, run the following command:

```
$ oc get pods -n openshift-ovn-kubernetes -owide
```

### Example output

```

NAME READY STATUS RESTARTS AGE IP NODE
NOMINATED NODE READINESS GATES
ovnkube-control-plane-8444dff7f9-4lh9k 2/2 Running 0 27m 10.0.0.3 ci-ln-
t487nnb-72292-mdcnq-master-1 <none> <none>
ovnkube-control-plane-8444dff7f9-5rjh9 2/2 Running 0 27m 10.0.0.4 ci-ln-
t487nnb-72292-mdcnq-master-2 <none> <none>
ovnkube-node-55xs2 8/8 Running 0 26m 10.0.0.4 ci-ln-t487nnb-
72292-mdcnq-master-2 <none> <none>
ovnkube-node-7r84r 8/8 Running 0 17m 10.0.128.3 ci-ln-t487nnb-
72292-mdcnq-worker-b-wbz7z <none> <none>
ovnkube-node-bqq8p 8/8 Running 0 17m 10.0.128.2 ci-ln-
t487nnb-72292-mdcnq-worker-a-lh7ms <none> <none>
ovnkube-node-mkj4f 8/8 Running 0 27m 10.0.0.5 ci-ln-t487nnb-
72292-mdcnq-master-0 <none> <none>
ovnkube-node-mlr8k 8/8 Running 0 27m 10.0.0.3 ci-ln-t487nnb-
72292-mdcnq-master-1 <none> <none>
ovnkube-node-wqn2m 8/8 Running 0 17m 10.0.128.4 ci-ln-
t487nnb-72292-mdcnq-worker-c-przlm <none> <none>

```

- Navigate into a pod to look at the northbound database by running the following command:

```
$ oc rsh -c nbdb -n openshift-ovn-kubernetes ovnkube-node-55xs2
```

- Run the following command to show all the objects in the northbound database:

```
$ ovn-nbctl show
```

The output is too long to list here. The list includes the NAT rules, logical switches, load balancers and so on.

You can narrow down and focus on specific components by using some of the following optional commands:

- Run the following command to show the list of logical routers:

```
$ oc exec -n openshift-ovn-kubernetes -it ovnkube-node-55xs2 \
-c northd -- ovn-nbctl lr-list
```

### Example output

```
45339f4f-7d0b-41d0-b5f9-9fca9ce40ce6 (GR_ci-ln-t487nnb-72292-mdcnq-master-2)
96a0a0f0-e7ed-4fec-8393-3195563de1b8 (ovn_cluster_router)
```

**NOTE**

From this output you can see there is router on each node plus an **ovn\_cluster\_router**.

- b. Run the following command to show the list of logical switches:

```
$ oc exec -n openshift-ovn-kubernetes -it ovnkube-node-55xs2 \
-c nbdb -- ovn-nbctl ls-list
```

**Example output**

```
bdd7dc3d-d848-4a74-b293-cc15128ea614 (ci-ln-t487nnb-72292-mdcnq-master-2)
b349292d-ee03-4914-935f-1940b6cb91e5 (ext_ci-ln-t487nnb-72292-mdcnq-master-2)
0aac0754-ea32-4e33-b086-35eeabf0a140 (join)
992509d7-2c3f-4432-88db-c179e43592e5 (transit_switch)
```

**NOTE**

From this output you can see there is an ext switch for each node plus switches with the node name itself and a join switch.

- c. Run the following command to show the list of load balancers:

```
$ oc exec -n openshift-ovn-kubernetes -it ovnkube-node-55xs2 \
-c nbdb -- ovn-nbctl lb-list
```

**Example output**

UUID	LB	PROTO	VIP	IPs
7c84c673-ed2a-4436-9a1f-9bc5dd181eea	Service_default/	tcp	172.30.0.1:443	10.0.0.3:6443,169.254.169.2:6443,10.0.0.5:6443
4d663fd9-ddc8-4271-b333-4c0e279e20bb	Service_default/	tcp	172.30.0.1:443	10.0.0.3:6443,10.0.0.4:6443,10.0.0.5:6443
292eb07f-b82f-4962-868a-4f541d250bca	Service_openshif	tcp	172.30.105.247:443	10.129.0.12:8443
034b5a7f-bb6a-45e9-8e6d-573a82dc5ee3	Service_openshif	tcp	172.30.192.38:443	10.0.0.3:10259,10.0.0.4:10259,10.0.0.5:10259
a68bb53e-be84-48df-bd38-bdd82fcd4026	Service_openshif	tcp	172.30.161.125:8443	10.129.0.32:8443
6cc21b3d-2c54-4c94-8ff5-d8e017269c2e	Service_openshif	tcp	172.30.3.144:443	10.129.0.22:8443
37996ffd-7268-4862-a27f-61cd62e09c32	Service_openshif	tcp	172.30.181.107:443	10.129.0.18:8443
81d4da3c-f811-411f-ae0c-bc6713d0861d	Service_openshif	tcp	172.30.228.23:443	10.129.0.29:8443
ac5a4f3b-b6ba-4ceb-82d0-d84f2c41306e	Service_openshif	tcp	172.30.14.240:9443	10.129.0.36:9443
c88979fb-1ef5-414b-90ac-43b579351ac9	Service_openshif	tcp	172.30.231.192:9001	10.128.0.5:9001,10.128.2.5:9001,10.129.0.5:9001,10.129.2.4:9001,10.130.0.3:9001,10.131.0.3:9001
fc0a3fb-4a77-4230-a84a-be45dce757e8	Service_openshif	tcp		

```

172.30.189.92:443 10.130.0.17:8440
67ef3e7b-ceb9-4bf0-8d96-b43bde4c9151 Service_openshif tcp
172.30.67.218:443 10.129.0.9:8443
d0032fba-7d5e-424a-af25-4ab9b5d46e81 Service_openshif tcp
172.30.102.137:2379 10.0.0.3:2379,10.0.0.4:2379,10.0.0.5:2379
 tcp 172.30.102.137:9979
10.0.0.3:9979,10.0.0.4:9979,10.0.0.5:9979
7361c537-3eec-4e6c-bc0c-0522d182abd4 Service_openshif tcp
172.30.198.215:9001
10.0.0.3:9001,10.0.0.4:9001,10.0.0.5:9001,10.0.128.2:9001,10.0.128.3:9001,10.0.128.4:9
001
0296c437-1259-410b-a6fd-81c310ad0af5 Service_openshif tcp
172.30.198.215:9001
10.0.0.3:9001,169.254.169.2:9001,10.0.0.5:9001,10.0.128.2:9001,10.0.128.3:9001,10.0.1
28.4:9001
5d5679f5-45b8-479d-9f7c-08b123c688b8 Service_openshif tcp
172.30.38.253:17698 10.128.0.52:17698,10.129.0.84:17698,10.130.0.60:17698
2adcbab4-d1c9-447d-9573-b5dc9f2efbfa Service_openshif tcp
172.30.148.52:443 10.0.0.4:9202,10.0.0.5:9202
 tcp 172.30.148.52:444
10.0.0.4:9203,10.0.0.5:9203
 tcp 172.30.148.52:445
10.0.0.4:9204,10.0.0.5:9204
 tcp 172.30.148.52:446
10.0.0.4:9205,10.0.0.5:9205
2a33a6d7-af1b-4892-87cc-326a380b809b Service_openshif tcp
172.30.67.219:9091 10.129.2.16:9091,10.131.0.16:9091
 tcp 172.30.67.219:9092
10.129.2.16:9092,10.131.0.16:9092
 tcp 172.30.67.219:9093
10.129.2.16:9093,10.131.0.16:9093
 tcp 172.30.67.219:9094
10.129.2.16:9094,10.131.0.16:9094
f56f59d7-231a-4974-99b3-792e2741ec8d Service_openshif tcp
172.30.89.212:443 10.128.0.41:8443,10.129.0.68:8443,10.130.0.44:8443
08c2c6d7-d217-4b96-b5d8-c80c4e258116 Service_openshif tcp
172.30.102.137:2379 10.0.0.3:2379,169.254.169.2:2379,10.0.0.5:2379
 tcp 172.30.102.137:9979
10.0.0.3:9979,169.254.169.2:9979,10.0.0.5:9979
60a69c56-fc6a-4de6-bd88-3f2af5ba5665 Service_openshif tcp
172.30.10.193:443 10.129.0.25:8443
ab1ef694-0826-4671-a22c-565fc2d282ec Service_openshif tcp
172.30.196.123:443 10.128.0.33:8443,10.129.0.64:8443,10.130.0.37:8443
b1fb34d3-0944-4770-9ee3-2683e7a630e2 Service_openshif tcp
172.30.158.93:8443 10.129.0.13:8443
95811c11-56e2-4877-be1e-c78ccb3a82a9 Service_openshif tcp
172.30.46.85:9001 10.130.0.16:9001
4baba1d1-b873-4535-884c-3f6fc07a50fd Service_openshif tcp 172.30.28.87:443
10.129.0.26:8443
6c2e1c90-f0ca-484e-8a8e-40e71442110a Service_openshif udp 172.30.0.10:53
10.128.0.13:5353,10.128.2.6:5353,10.129.0.39:5353,10.129.2.6:5353,10.130.0.11:5353,1
0.131.0.9:5353

```

**NOTE**

From this truncated output you can see there are many OVN-Kubernetes load balancers. Load balancers in OVN-Kubernetes are representations of services.

5. Run the following command to display the options available with the command **ovn-nbctl**:

```
$ oc exec -n openshift-ovn-kubernetes -it ovnkube-node-55xs2 \
-c nbdb ovn-nbctl --help
```

### 28.2.4. Command line arguments for ovn-nbctl to examine northbound database contents

The following table describes the command line arguments that can be used with **ovn-nbctl** to examine the contents of the northbound database.

**NOTE**

Open a remote shell in the pod you want to view the contents of and then run the **ovn-nbctl** commands.

Table 28.2. Command line arguments to examine northbound database contents

Argument	Description
<b>ovn-nbctl show</b>	An overview of the northbound database contents as seen from a specific node.
<b>ovn-nbctl show &lt;switch_or_router&gt;</b>	Show the details associated with the specified switch or router.
<b>ovn-nbctl lr-list</b>	Show the logical routers.
<b>ovn-nbctl lrp-list &lt;router&gt;</b>	Using the router information from <b>ovn-nbctl lr-list</b> to show the router ports.
<b>ovn-nbctl lr-nat-list &lt;router&gt;</b>	Show network address translation details for the specified router.
<b>ovn-nbctl ls-list</b>	Show the logical switches
<b>ovn-nbctl lsp-list &lt;switch&gt;</b>	Using the switch information from <b>ovn-nbctl ls-list</b> to show the switch port.
<b>ovn-nbctl lsp-get-type &lt;port&gt;</b>	Get the type for the logical port.
<b>ovn-nbctl lb-list</b>	Show the load balancers.



## 28.2.5. Listing the OVN-Kubernetes southbound database contents

Each node is controlled by the **ovnkube-controller** container running in the **ovnkube-node** pod on that node. To understand the OVN logical networking entities you need to examine the northbound database that is running as a container inside the **ovnkube-node** pod on that node to see what objects are in the node you wish to see.

### Prerequisites

- Access to the cluster as a user with the **cluster-admin** role.
- The OpenShift CLI (**oc**) installed.



### PROCEDURE

To run **ovn nbctl** or **sbctl** commands in a cluster you must open a remote shell into the **nbdb** or **sbdb** containers on the relevant node

1. List the pods by running the following command:

```
$ oc get po -n openshift-ovn-kubernetes
```

### Example output

NAME	READY	STATUS	RESTARTS	AGE
ovnkube-control-plane-8444dff7f9-4lh9k	2/2	Running	0	27m
ovnkube-control-plane-8444dff7f9-5rjh9	2/2	Running	0	27m
ovnkube-node-55xs2	8/8	Running	0	26m
ovnkube-node-7r84r	8/8	Running	0	16m
ovnkube-node-bqq8p	8/8	Running	0	17m
ovnkube-node-mkj4f	8/8	Running	0	26m
ovnkube-node-mlr8k	8/8	Running	0	26m
ovnkube-node-wqn2m	8/8	Running	0	16m

2. Optional: To list the pods with node information, run the following command:

```
$ oc get pods -n openshift-ovn-kubernetes -owide
```

### Example output

NAME	READY	STATUS	RESTARTS	AGE	IP	NODE
ovnkube-control-plane-8444dff7f9-4lh9k	2/2	Running	0	27m	10.0.0.3	ci-ln-t487nnb-72292-mdcnq-master-1
ovnkube-control-plane-8444dff7f9-5rjh9	2/2	Running	0	27m	10.0.0.4	ci-ln-t487nnb-72292-mdcnq-master-2
ovnkube-node-55xs2	8/8	Running	0	26m	10.0.0.4	ci-ln-t487nnb-72292-mdcnq-master-2
ovnkube-node-7r84r	8/8	Running	0	17m	10.0.128.3	ci-ln-t487nnb-72292-mdcnq-worker-b-wbz7z
ovnkube-node-bqq8p	8/8	Running	0	17m	10.0.128.2	ci-ln-t487nnb-72292-mdcnq-worker-a-lh7ms
ovnkube-node-mkj4f	8/8	Running	0	27m	10.0.0.5	ci-ln-t487nnb-

```

72292-mdcnq-master-0 <none> <none>
ovnkube-node-mlr8k 8/8 Running 0 27m 10.0.0.3 ci-ln-t487nnb-
72292-mdcnq-master-1 <none> <none>
ovnkube-node-wqn2m 8/8 Running 0 17m 10.0.128.4 ci-ln-
t487nnb-72292-mdcnq-worker-c-przlm <none> <none>

```

3. Navigate into a pod to look at the southbound database:

```
$ oc rsh -c sbdb -n openshift-ovn-kubernetes ovnkube-node-55xs2
```

4. Run the following command to show all the objects in the southbound database:

```
$ ovn-sbctl show
```

### Example output

```

Chassis "5db31703-35e9-413b-8cdf-69e7eecb41f7"
 hostname: ci-ln-9gp362t-72292-v2p94-worker-a-8bmwz
 Encap geneve
 ip: "10.0.128.4"
 options: {csum="true"}
 Port_Binding tstor-ci-ln-9gp362t-72292-v2p94-worker-a-8bmwz
Chassis "070debed-99b7-4bce-b17d-17e720b7f8bc"
 hostname: ci-ln-9gp362t-72292-v2p94-worker-b-svmp6
 Encap geneve
 ip: "10.0.128.2"
 options: {csum="true"}
 Port_Binding k8s-ci-ln-9gp362t-72292-v2p94-worker-b-svmp6
 Port_Binding rtoc-GR-ci-ln-9gp362t-72292-v2p94-worker-b-svmp6
 Port_Binding openshift-monitoring_alertmanager-main-1
 Port_Binding rtoc-GR-ci-ln-9gp362t-72292-v2p94-worker-b-svmp6
 Port_Binding etor-GR-ci-ln-9gp362t-72292-v2p94-worker-b-svmp6
 Port_Binding cr-rtos-ci-ln-9gp362t-72292-v2p94-worker-b-svmp6
 Port_Binding openshift-e2e-loki_loki-promtail-qcrcz
 Port_Binding jtor-GR-ci-ln-9gp362t-72292-v2p94-worker-b-svmp6
 Port_Binding openshift-multus_network-metrics-daemon-mkd4t
 Port_Binding openshift-ingress-canary_ingress-canary-xtvj4
 Port_Binding openshift-ingress_router-default-6c76cbc498-pvlqk
 Port_Binding openshift-dns_dns-default-zz582
 Port_Binding openshift-monitoring_thanos-querier-57585899f5-lbf4f
 Port_Binding openshift-network-diagnostics_network-check-target-tn228
 Port_Binding openshift-monitoring_prometheus-k8s-0
 Port_Binding openshift-image-registry_image-registry-68899bd877-xqxjj
Chassis "179ba069-0af1-401c-b044-e5ba90f60fea"
 hostname: ci-ln-9gp362t-72292-v2p94-master-0
 Encap geneve
 ip: "10.0.0.5"
 options: {csum="true"}
 Port_Binding tstor-ci-ln-9gp362t-72292-v2p94-master-0
Chassis "68c954f2-5a76-47be-9e84-1cb13bd9dab9"
 hostname: ci-ln-9gp362t-72292-v2p94-worker-c-mjf9w
 Encap geneve
 ip: "10.0.128.3"
 options: {csum="true"}
 Port_Binding tstor-ci-ln-9gp362t-72292-v2p94-worker-c-mjf9w

```

```

Chassis "2de65d9e-9abf-4b6e-a51d-a1e038b4d8af"
 hostname: ci-ln-9gp362t-72292-v2p94-master-2
 Encap geneve
 ip: "10.0.0.4"
 options: {csum="true"}
 Port_Binding tstor-ci-ln-9gp362t-72292-v2p94-master-2
Chassis "1d371cb8-5e21-44fd-9025-c4b162cc4247"
 hostname: ci-ln-9gp362t-72292-v2p94-master-1
 Encap geneve
 ip: "10.0.0.3"
 options: {csum="true"}
 Port_Binding tstor-ci-ln-9gp362t-72292-v2p94-master-1

```

This detailed output shows the chassis and the ports that are attached to the chassis which in this case are all of the router ports and anything that runs like host networking. Any pods communicate out to the wider network using source network address translation (SNAT). Their IP address is translated into the IP address of the node that the pod is running on and then sent out into the network.

In addition to the chassis information the southbound database has all the logic flows and those logic flows are then sent to the **ovn-controller** running on each of the nodes. The **ovn-controller** translates the logic flows into open flow rules and ultimately programs **OpenvSwitch** so that your pods can then follow open flow rules and make it out of the network.

5. Run the following command to display the options available with the command **ovn-sbctl**:

```

$ oc exec -n openshift-ovn-kubernetes -it ovnkube-node-55xs2 \
-c sbdb ovn-sbctl --help

```

### 28.2.6. Command line arguments for ovn-sbctl to examine southbound database contents

The following table describes the command line arguments that can be used with **ovn-sbctl** to examine the contents of the southbound database.



#### NOTE

Open a remote shell in the pod you wish to view the contents of and then run the **ovn-sbctl** commands.

Table 28.3. Command line arguments to examine southbound database contents

Argument	Description
<b>ovn-sbctl show</b>	An overview of the southbound database contents as seen from a specific node.
<b>ovn-sbctl list Port_Binding &lt;port&gt;</b>	List the contents of southbound database for a the specified port .
<b>ovn-sbctl dump-flows</b>	List the logical flows.

### 28.2.7. OVN-Kubernetes logical architecture

OVN is a network virtualization solution. It creates logical switches and routers. These switches and routers are interconnected to create any network topologies. When you run **ovnkube-trace** with the log level set to 2 or 5 the OVN-Kubernetes logical components are exposed. The following diagram shows how the routers and switches are connected in OpenShift Container Platform.

Figure 28.2. OVN-Kubernetes router and switch components

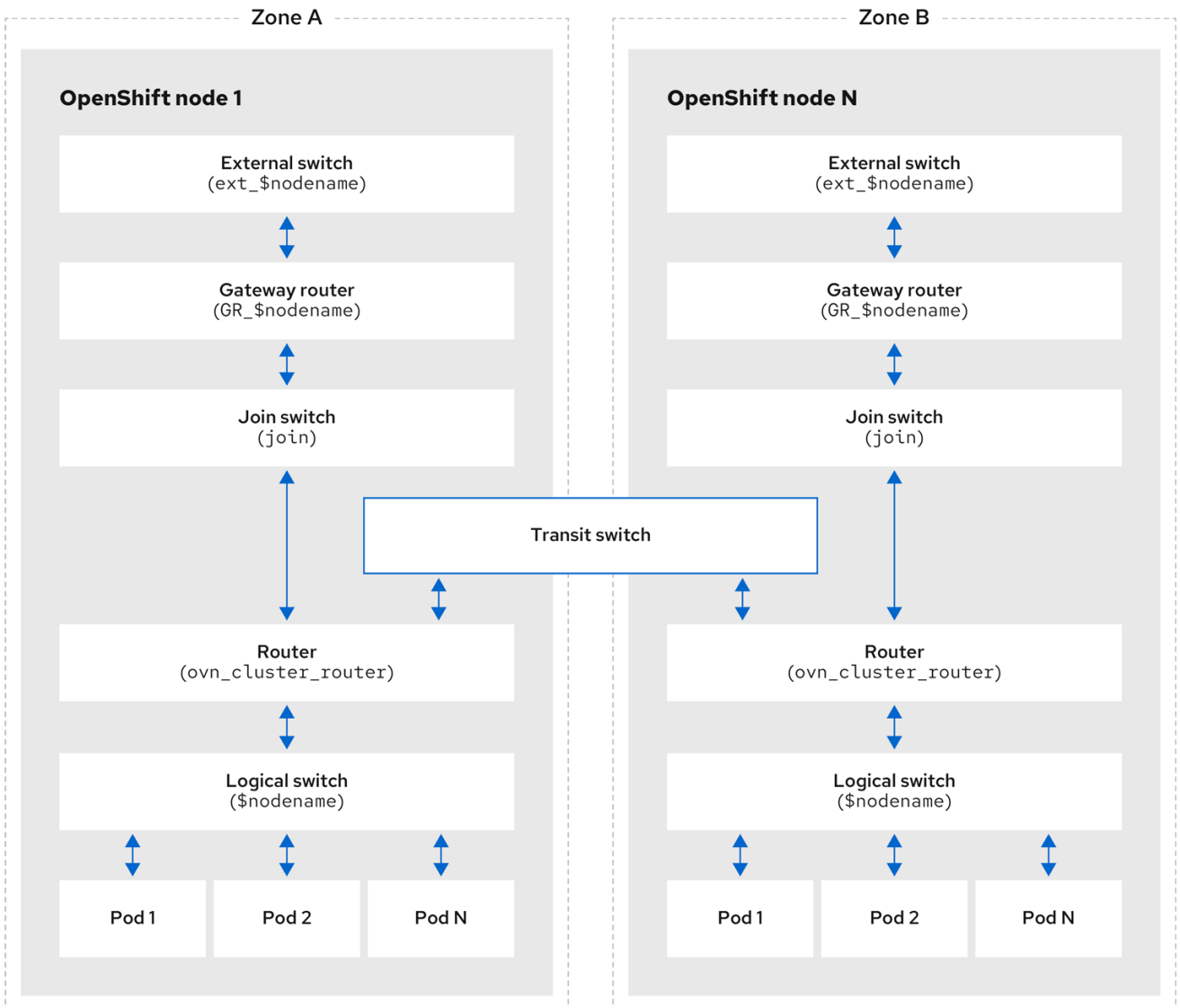

299\_OpenShift\_1023

The key components involved in packet processing are:

#### Gateway routers

Gateway routers sometimes called L3 gateway routers, are typically used between the distributed routers and the physical network. Gateway routers including their logical patch ports are bound to a physical location (not distributed), or chassis. The patch ports on this router are known as L3gateway ports in the **ovn-sbdb**.

#### Distributed logical routers

Distributed logical routers and the logical switches behind them, to which virtual machines and containers attach, effectively reside on each hypervisor.

#### Join local switch

Join local switches are used to connect the distributed router and gateway routers. It reduces the number of IP addresses needed on the distributed router.

### Logical switches with patch ports

Logical switches with patch ports are used to virtualize the network stack. They connect remote logical ports through tunnels.

### Logical switches with localnet ports

Logical switches with localnet ports are used to connect OVN to the physical network. They connect remote logical ports by bridging the packets to directly connected physical L2 segments using localnet ports.

### Patch ports

Patch ports represent connectivity between logical switches and logical routers and between peer logical routers. A single connection has a pair of patch ports at each such point of connectivity, one on each side.

### I3gateway ports

I3gateway ports are the port binding entries in the **ovn-sbdb** for logical patch ports used in the gateway routers. They are called I3gateway ports rather than patch ports just to portray the fact that these ports are bound to a chassis just like the gateway router itself.

### localnet ports

localnet ports are present on the bridged logical switches that allows a connection to a locally accessible network from each **ovn-controller** instance. This helps model the direct connectivity to the physical network from the logical switches. A logical switch can only have a single localnet port attached to it.

## 28.2.7.1. Installing network-tools on local host

Install **network-tools** on your local host to make a collection of tools available for debugging OpenShift Container Platform cluster network issues.

### Procedure

1. Clone the **network-tools** repository onto your workstation with the following command:

```
$ git clone git@github.com:openshift/network-tools.git
```

2. Change into the directory for the repository you just cloned:

```
$ cd network-tools
```

3. Optional: List all available commands:

```
$./debug-scripts/network-tools -h
```

## 28.2.7.2. Running network-tools

Get information about the logical switches and routers by running **network-tools**.

### Prerequisites

- You installed the OpenShift CLI (**oc**).

- You are logged in to the cluster as a user with **cluster-admin** privileges.
- You have installed **network-tools** on local host.

## Procedure

1. Open a remote shell into a pod by running the following command:

```
$ oc rsh -n openshift-ovn-kubernetes ovnkube-node-2hsbt
```

2. List the routers by running the following command:

```
$./debug-scripts/network-tools ovn-db-run-command ovn-nbctl lr-list
```

### Example output

```
944a7b53-7948-4ad2-a494-82b55eecf87 (GR_ci-ln-54932yb-72292-kd676-worker-c-rzj99)
84bd4a4c-4b0b-4a47-b0cf-a2c32709fc53 (ovn_cluster_router)
```

3. List the localnet ports by running the following command:

```
$./debug-scripts/network-tools ovn-db-run-command \
 ovn-sbctl find Port_Binding type=localnet
```

### Example output

```
_uuid : d05298f5-805b-4838-9224-1211afc2f199
additional_chassis : []
additional_encap : []
chassis : []
datapath : f3c2c959-743b-4037-854d-26627902597c
encap : []
external_ids : {}
gateway_chassis : []
ha_chassis_group : []
logical_port : br-ex_ci-ln-54932yb-72292-kd676-worker-c-rzj99
mac : [unknown]
mirror_rules : []
nat_addresses : []
options : {network_name=physnet}
parent_port : []
port_security : []
requested_additional_chassis: []
requested_chassis : []
tag : []
tunnel_key : 2
type : localnet
up : false
virtual_parent : []
```

```
[...]
```

4. List the **l3gateway** ports by running the following command:

```
-
```

```
$./debug-scripts/network-tools ovn-db-run-command \
ovn-sbctl find Port_Binding type=l3gateway
```

### Example output

```
_uuid : 5207a1f3-1cf3-42f1-83e9-387bbb06b03c
additional_chassis : []
additional_encap : []
chassis : ca6eb600-3a10-4372-a83e-e0d957c4cd92
datapath : f3c2c959-743b-4037-854d-26627902597c
encap : []
external_ids : {}
gateway_chassis : []
ha_chassis_group : []
logical_port : etor-GR_ci-ln-54932yb-72292-kd676-worker-c-rzj99
mac : ["42:01:0a:00:80:04"]
mirror_rules : []
nat_addresses : ["42:01:0a:00:80:04 10.0.128.4"]
options : {l3gateway-chassis="84737c36-b383-4c83-92c5-2bd5b3c7e772", peer=rtoe-GR_ci-ln-54932yb-72292-kd676-worker-c-rzj99}
parent_port : []
port_security : []
requested_additional_chassis: []
requested_chassis : []
tag : []
tunnel_key : 1
type : l3gateway
up : true
virtual_parent : []

_uuid : 6088d647-84f2-43f2-b53f-c9d379042679
additional_chassis : []
additional_encap : []
chassis : ca6eb600-3a10-4372-a83e-e0d957c4cd92
datapath : dc9cea00-d94a-41b8-bdb0-89d42d13aa2e
encap : []
external_ids : {}
gateway_chassis : []
ha_chassis_group : []
logical_port : jtor-GR_ci-ln-54932yb-72292-kd676-worker-c-rzj99
mac : [router]
mirror_rules : []
nat_addresses : []
options : {l3gateway-chassis="84737c36-b383-4c83-92c5-2bd5b3c7e772", peer=rtoj-GR_ci-ln-54932yb-72292-kd676-worker-c-rzj99}
parent_port : []
port_security : []
requested_additional_chassis: []
requested_chassis : []
tag : []
tunnel_key : 2
type : l3gateway
up : true
```

```
virtual_parent : []
```

```
[...]
```

- List the patch ports by running the following command:

```
$./debug-scripts/network-tools ovn-db-run-command \
 ovn-sbctl find Port_Binding type=patch
```

### Example output

```
_uuid : 785fb8b6-ee5a-4792-a415-5b1cb855dac2
additional_chassis : []
additional_encap : []
chassis : []
datapath : f1ddd1cc-dc0d-43b4-90ca-12651305acec
encap : []
external_ids : {}
gateway_chassis : []
ha_chassis_group : []
logical_port : stor-ci-ln-54932yb-72292-kd676-worker-c-rzj99
mac : [router]
mirror_rules : []
nat_addresses : ["0a:58:0a:80:02:01 10.128.2.1 is_chassis_resident(\"cr-rtos-ci-ln-54932yb-72292-kd676-worker-c-rzj99\")"]
options : {peer=rtos-ci-ln-54932yb-72292-kd676-worker-c-rzj99}
parent_port : []
port_security : []
requested_additional_chassis: []
requested_chassis : []
tag : []
tunnel_key : 1
type : patch
up : false
virtual_parent : []

_uuid : c01ff587-21a5-40b4-8244-4cd0425e5d9a
additional_chassis : []
additional_encap : []
chassis : []
datapath : f6795586-bf92-4f84-9222-efe4ac6a7734
encap : []
external_ids : {}
gateway_chassis : []
ha_chassis_group : []
logical_port : rtj-ovn_cluster_router
mac : ["0a:58:64:40:00:01 100.64.0.1/16"]
mirror_rules : []
nat_addresses : []
options : {peer=jtor-ovn_cluster_router}
parent_port : []
port_security : []
requested_additional_chassis: []
requested_chassis : []
tag : []
```



```
tunnel_key : 1
type : patch
up : false
virtual_parent : []
[...]
```

### 28.2.8. Additional resources

- [Tracing Openflow with ovnkube-trace](#)
- [OVN architecture](#)
- [ovn-nbctl linux manual page](#)
- [ovn-sbctl linux manual page](#)

## 28.3. TROUBLESHOOTING OVN-KUBERNETES

OVN-Kubernetes has many sources of built-in health checks and logs. Follow the instructions in these sections to examine your cluster. If a support case is necessary, follow the [support guide](#) to collect additional information through a **must-gather**. Only use the **--gather\_network\_logs** when instructed by support.

### 28.3.1. Monitoring OVN-Kubernetes health by using readiness probes

The **ovnkube-control-plane** and **ovnkube-node** pods have containers configured with readiness probes.

#### Prerequisites

- Access to the OpenShift CLI (**oc**).
- You have access to the cluster with **cluster-admin** privileges.
- You have installed **jq**.

#### Procedure

1. Review the details of the **ovnkube-node** readiness probe by running the following command:

```
$ oc get pods -n openshift-ovn-kubernetes -l app=ovnkube-node \
-o json | jq '.items[0].spec.containers[] | .name,.readinessProbe'
```

The readiness probe for the northbound and southbound database containers in the **ovnkube-node** pod checks for the health of the databases and the **ovnkube-controller** container.

The **ovnkube-controller** container in the **ovnkube-node** pod has a readiness probe to verify the presence of the OVN-Kubernetes CNI configuration file, the absence of which would indicate that the pod is not running or is not ready to accept requests to configure pods.

2. Show all events including the probe failures, for the namespace by using the following command:

```
$ oc get events -n openshift-ovn-kubernetes
```

3. Show the events for just a specific pod:

```
$ oc describe pod ovnkube-node-9lqfk -n openshift-ovn-kubernetes
```

4. Show the messages and statuses from the cluster network operator:

```
$ oc get co/network -o json | jq '.status.conditions[]'
```

5. Show the **ready** status of each container in **ovnkube-node** pods by running the following script:

```
$ for p in $(oc get pods --selector app=ovnkube-node -n openshift-ovn-kubernetes \
-o jsonpath='{range.items[*]}{" "}{.metadata.name}'); do echo === $p ===; \
oc get pods -n openshift-ovn-kubernetes $p -o json | jq '.status.containerStatuses[] | .name,
.ready'; \
done
```



#### NOTE

The expectation is all container statuses are reporting as **true**. Failure of a readiness probe sets the status to **false**.

#### Additional resources

- [Monitoring application health by using health checks](#)

### 28.3.2. Viewing OVN-Kubernetes alerts in the console

The Alerting UI provides detailed information about alerts and their governing alerting rules and silences.

#### Prerequisites

- You have access to the cluster as a developer or as a user with view permissions for the project that you are viewing metrics for.

#### Procedure (UI)

1. In the **Administrator** perspective, select **Observe** → **Alerting**. The three main pages in the Alerting UI in this perspective are the **Alerts**, **Silences**, and **Alerting Rules** pages.
2. View the rules for OVN-Kubernetes alerts by selecting **Observe** → **Alerting** → **Alerting Rules**.

### 28.3.3. Viewing OVN-Kubernetes alerts in the CLI

You can get information about alerts and their governing alerting rules and silences from the command line.

#### Prerequisites

- Access to the cluster as a user with the **cluster-admin** role.
- The OpenShift CLI (**oc**) installed.
- You have installed **jq**.

## Procedure

1. View active or firing alerts by running the following commands.
  - a. Set the alert manager route environment variable by running the following command:

```
$ ALERT_MANAGER=$(oc get route alertmanager-main -n openshift-monitoring \
-o jsonpath='{@.spec.host}')
```

- b. Issue a **curl** request to the alert manager route API by running the following command, replacing **\$ALERT\_MANAGER** with the URL of your **Alertmanager** instance:

```
$ curl -s -k -H "Authorization: Bearer $(oc create token prometheus-k8s -n openshift-
monitoring)" https://$ALERT_MANAGER/api/v1/alerts | jq '.data[] | "\(.labels.severity) \
(.labels.alertname) \(.labels.pod) \(.labels.container) \(.labels.endpoint) \
(.labels.instance)'"
```

2. View alerting rules by running the following command:

```
$ oc -n openshift-monitoring exec -c prometheus prometheus-k8s-0 -- curl -s
'http://localhost:9090/api/v1/rules' | jq '.data.groups[].rules[] | select(((.name|contains("ovn"))
or (.name|contains("OVN")) or (.name|contains("Ovn")) or (.name|contains("North")) or
(.name|contains("South")))) and .type=="alerting")'
```

### 28.3.4. Viewing the OVN-Kubernetes logs using the CLI

You can view the logs for each of the pods in the **ovnkube-master** and **ovnkube-node** pods using the OpenShift CLI (**oc**).

#### Prerequisites

- Access to the cluster as a user with the **cluster-admin** role.
- Access to the OpenShift CLI (**oc**).
- You have installed **jq**.

## Procedure

1. View the log for a specific pod:

```
$ oc logs -f <pod_name> -c <container_name> -n <namespace>
```

where:

**-f**

Optional: Specifies that the output follows what is being written into the logs.

**<pod\_name>**

Specifies the name of the pod.

**<container\_name>**

Optional: Specifies the name of a container. When a pod has more than one container, you must specify the container name.

**<namespace>**

Specify the namespace the pod is running in.

For example:

```
$ oc logs ovnkube-node-5dx44 -n openshift-ovn-kubernetes
```

```
$ oc logs -f ovnkube-node-5dx44 -c ovnkube-controller -n openshift-ovn-kubernetes
```

The contents of log files are printed out.

2. Examine the most recent entries in all the containers in the **ovnkube-node** pods:

```
$ for p in $(oc get pods --selector app=ovnkube-node -n openshift-ovn-kubernetes \
-o jsonpath='{range.items[*]}{" "}{.metadata.name}'); \
do echo === $p ===; for container in $(oc get pods -n openshift-ovn-kubernetes $p \
-o json | jq -r '.status.containerStatuses[] | .name');do echo ---$container---; \
oc logs -c $container $p -n openshift-ovn-kubernetes --tail=5; done; done
```

3. View the last 5 lines of every log in every container in an **ovnkube-node** pod using the following command:

```
$ oc logs -l app=ovnkube-node -n openshift-ovn-kubernetes --all-containers --tail 5
```

### 28.3.5. Viewing the OVN-Kubernetes logs using the web console

You can view the logs for each of the pods in the **ovnkube-master** and **ovnkube-node** pods in the web console.

#### Prerequisites

- Access to the OpenShift CLI (**oc**).

#### Procedure

1. In the OpenShift Container Platform console, navigate to **Workloads** → **Pods** or navigate to the pod through the resource you want to investigate.
2. Select the **openshift-ovn-kubernetes** project from the drop-down menu.
3. Click the name of the pod you want to investigate.
4. Click **Logs**. By default for the **ovnkube-master** the logs associated with the **northd** container are displayed.
5. Use the down-down menu to select logs for each container in turn.

#### 28.3.5.1. Changing the OVN-Kubernetes log levels

The default log level for OVN-Kubernetes is 4. To debug OVN-Kubernetes, set the log level to 5. Follow this procedure to increase the log level of the OVN-Kubernetes to help you debug an issue.

#### Prerequisites

- You have access to the cluster with **cluster-admin** privileges.
- You have access to the OpenShift Container Platform web console.

## Procedure

1. Run the following command to get detailed information for all pods in the OVN-Kubernetes project:

```
$ oc get po -o wide -n openshift-ovn-kubernetes
```

## Example output

```

NAME READY STATUS RESTARTS AGE IP NODE
NOMINATED NODE READINESS GATES
ovnkube-control-plane-65497d4548-9ptdr 2/2 Running 2 (128m ago) 147m 10.0.0.3 10.0.0.3
ci-ln-3njdr9b-72292-5nwkp-master-0 <none> <none>
ovnkube-control-plane-65497d4548-j6zfk 2/2 Running 0 147m 10.0.0.5 10.0.0.5
ln-3njdr9b-72292-5nwkp-master-2 <none> <none>
ovnkube-node-5dx44 8/8 Running 0 146m 10.0.0.3 10.0.0.3
ci-ln-3njdr9b-72292-5nwkp-master-0 <none> <none>
ovnkube-node-dpfn4 8/8 Running 0 146m 10.0.0.4 10.0.0.4
ci-ln-3njdr9b-72292-5nwkp-master-1 <none> <none>
ovnkube-node-kwc9l 8/8 Running 0 134m 10.0.128.2 10.0.128.2
ci-ln-3njdr9b-72292-5nwkp-worker-a-2fjcj <none> <none>
ovnkube-node-mcrhl 8/8 Running 0 134m 10.0.128.4 10.0.128.4
ci-ln-3njdr9b-72292-5nwkp-worker-c-v9x5v <none> <none>
ovnkube-node-nsct4 8/8 Running 0 146m 10.0.0.5 10.0.0.5
ci-ln-3njdr9b-72292-5nwkp-master-2 <none> <none>
ovnkube-node-zrj9f 8/8 Running 0 134m 10.0.128.3 10.0.128.3
ci-ln-3njdr9b-72292-5nwkp-worker-b-v78h7 <none> <none>

```

2. Create a **ConfigMap** file similar to the following example and use a filename such as **env-overrides.yaml**:

## Example ConfigMap file

```

kind: ConfigMap
apiVersion: v1
metadata:
 name: env-overrides
 namespace: openshift-ovn-kubernetes
data:
 ci-ln-3njdr9b-72292-5nwkp-master-0: | 1
 # This sets the log level for the ovn-kubernetes node process:
 OVN_KUBE_LOG_LEVEL=5
 # You might also/instead want to enable debug logging for ovn-controller:
 OVN_LOG_LEVEL=dbg
 ci-ln-3njdr9b-72292-5nwkp-master-2: |
 # This sets the log level for the ovn-kubernetes node process:
 OVN_KUBE_LOG_LEVEL=5
 # You might also/instead want to enable debug logging for ovn-controller:
 OVN_LOG_LEVEL=dbg
 _master: | 2

```

```
This sets the log level for the ovn-kubernetes master process as well as the ovn-
dbchecker:
OVN_KUBE_LOG_LEVEL=5
You might also/instead want to enable debug logging for northd, nbdb and sbdb on all
masters:
OVN_LOG_LEVEL=dbg
```

- 1 Specify the name of the node you want to set the debug log level on.
- 2 Specify **\_master** to set the log levels of **ovnkube-master** components.

3. Apply the **ConfigMap** file by using the following command:

```
$ oc apply -n openshift-ovn-kubernetes -f env-overrides.yaml
```

### Example output

```
configmap/env-overrides.yaml created
```

4. Restart the **ovnkube** pods to apply the new log level by using the following commands:

```
$ oc delete pod -n openshift-ovn-kubernetes \
--field-selector spec.nodeName=ci-ln-3njdr9b-72292-5nwkp-master-0 -l app=ovnkube-node
```

```
$ oc delete pod -n openshift-ovn-kubernetes \
--field-selector spec.nodeName=ci-ln-3njdr9b-72292-5nwkp-master-2 -l app=ovnkube-node
```

```
$ oc delete pod -n openshift-ovn-kubernetes -l app=ovnkube-node
```

5. To verify that the `ConfigMap` file has been applied to all nodes for a specific pod, run the following command:

```
$ oc logs -n openshift-ovn-kubernetes --all-containers --prefix ovnkube-node-<xxxx> | grep -
E -m 10 '(Logging config:[vconsole|DBG)'
```

where:

**<XXXX>**

Specifies the random sequence of letters for a pod from the previous step.

### Example output

```
[pod/ovnkube-node-2cpjc/sbdb] + exec /usr/share/ovn/scripts/ovn-ctl --no-monitor '--ovn-
sb-log=-vconsole:info -vfile:off -vPATTERN:console:%D{%Y-%m-
%dT%H:%M:%S.###Z}|%05N|c%T|p|m' run_sb_ovsdb
[pod/ovnkube-node-2cpjc/ovnkube-controller] I1012 14:39:59.984506 35767
config.go:2247] Logging config: {File: CNIFile:/var/log/ovn-kubernetes/ovn-k8s-cni-
overlay.log LibovsdbFile:/var/log/ovnkube/libovsdb.log Level:5 LogFileMaxSize:100
LogFileMaxBackups:5 LogFileMaxAge:0 ACLLoggingRateLimit:20}
[pod/ovnkube-node-2cpjc/northd] + exec ovn-northd --no-chdir -vconsole:info -vfile:off '-
vPATTERN:console:%D{%Y-%m-%dT%H:%M:%S.###Z}|%05N|c%T|p|m' --pidfile
/var/run/ovn/ovn-northd.pid --n-threads=1
```

```
[pod/ovnkube-node-2cpjc/nbdb] + exec /usr/share/ovn/scripts/ovn-ctl --no-monitor '--ovn-nb-log=-vconsole:info -vfile:off -vPATTERN:console:%D{%Y-%m-%dT%H:%M:%S.###Z}|%05N|%c%T|%p|%m' run_nb_ovsdb
[pod/ovnkube-node-2cpjc/ovn-controller] 2023-10-12T14:39:54.552Z|00002|hmap|DBG|lib/shash.c:114: 1 bucket with 6+ nodes, including 1 bucket with 6 nodes (32 nodes total across 32 buckets)
[pod/ovnkube-node-2cpjc/ovn-controller] 2023-10-12T14:39:54.553Z|00003|hmap|DBG|lib/shash.c:114: 1 bucket with 6+ nodes, including 1 bucket with 6 nodes (64 nodes total across 64 buckets)
[pod/ovnkube-node-2cpjc/ovn-controller] 2023-10-12T14:39:54.553Z|00004|hmap|DBG|lib/shash.c:114: 1 bucket with 6+ nodes, including 1 bucket with 7 nodes (32 nodes total across 32 buckets)
[pod/ovnkube-node-2cpjc/ovn-controller] 2023-10-12T14:39:54.553Z|00005|reconnect|DBG|unix:/var/run/openvswitch/db.sock: entering BACKOFF
[pod/ovnkube-node-2cpjc/ovn-controller] 2023-10-12T14:39:54.553Z|00007|reconnect|DBG|unix:/var/run/openvswitch/db.sock: entering CONNECTING
[pod/ovnkube-node-2cpjc/ovn-controller] 2023-10-12T14:39:54.553Z|00008|ovsdb_cs|DBG|unix:/var/run/openvswitch/db.sock: SERVER_SCHEMA_REQUESTED -> SERVER_SCHEMA_REQUESTED at lib/ovsdb-cs.c:423
```

6. Optional: Check the **ConfigMap** file has been applied by running the following command:

```
for f in $(oc -n openshift-ovn-kubernetes get po -l 'app=ovnkube-node' --no-headers -o custom-columns=N:.metadata.name) ; do echo "---- $f ----" ; oc -n openshift-ovn-kubernetes exec -c ovnkube-controller $f -- pgrep -a -f init-ovnkube-controller | grep -P -o '^.*loglevel\s+\d' ; done
```

### Example output

```
---- ovnkube-node-2dt57 ----
60981 /usr/bin/ovnkube --init-ovnkube-controller xpst8-worker-c-vmh5n.c.openshift-qe.internal --init-node xpst8-worker-c-vmh5n.c.openshift-qe.internal --config-file=/run/ovnkube-config/ovnkube.conf --ovn-empty-lb-events --loglevel 4
---- ovnkube-node-4zznh ----
178034 /usr/bin/ovnkube --init-ovnkube-controller xpst8-master-2.c.openshift-qe.internal --init-node xpst8-master-2.c.openshift-qe.internal --config-file=/run/ovnkube-config/ovnkube.conf --ovn-empty-lb-events --loglevel 4
---- ovnkube-node-548sx ----
77499 /usr/bin/ovnkube --init-ovnkube-controller xpst8-worker-a-fjtnb.c.openshift-qe.internal --init-node xpst8-worker-a-fjtnb.c.openshift-qe.internal --config-file=/run/ovnkube-config/ovnkube.conf --ovn-empty-lb-events --loglevel 4
---- ovnkube-node-6btrf ----
73781 /usr/bin/ovnkube --init-ovnkube-controller xpst8-worker-b-p8rww.c.openshift-qe.internal --init-node xpst8-worker-b-p8rww.c.openshift-qe.internal --config-file=/run/ovnkube-config/ovnkube.conf --ovn-empty-lb-events --loglevel 4
---- ovnkube-node-fkc9r ----
130707 /usr/bin/ovnkube --init-ovnkube-controller xpst8-master-0.c.openshift-qe.internal --init-node xpst8-master-0.c.openshift-qe.internal --config-file=/run/ovnkube-config/ovnkube.conf --ovn-empty-lb-events --loglevel 5
---- ovnkube-node-tk9l4 ----
```

```
181328 /usr/bin/ovnkube --init-ovnkube-controller xpst8-master-1.c.openshift-qe.internal --
init-node xpst8-master-1.c.openshift-qe.internal --config-file=/run/ovnkube-
config/ovnkube.conf --ovn-empty-lb-events --loglevel 4
```

### 28.3.6. Checking the OVN-Kubernetes pod network connectivity

The connectivity check controller, in OpenShift Container Platform 4.10 and later, orchestrates connection verification checks in your cluster. These include Kubernetes API, OpenShift API and individual nodes. The results for the connection tests are stored in **PodNetworkConnectivity** objects in the **openshift-network-diagnostics** namespace. Connection tests are performed every minute in parallel.

#### Prerequisites

- Access to the OpenShift CLI (**oc**).
- Access to the cluster as a user with the **cluster-admin** role.
- You have installed **jq**.

#### Procedure

1. To list the current **PodNetworkConnectivityCheck** objects, enter the following command:

```
$ oc get podnetworkconnectivitychecks -n openshift-network-diagnostics
```

2. View the most recent success for each connection object by using the following command:

```
$ oc get podnetworkconnectivitychecks -n openshift-network-diagnostics \
-o json | jq '.items[] | .spec.targetEndpoint, .status.successes[0]'
```

3. View the most recent failures for each connection object by using the following command:

```
$ oc get podnetworkconnectivitychecks -n openshift-network-diagnostics \
-o json | jq '.items[] | .spec.targetEndpoint, .status.failures[0]'
```

4. View the most recent outages for each connection object by using the following command:

```
$ oc get podnetworkconnectivitychecks -n openshift-network-diagnostics \
-o json | jq '.items[] | .spec.targetEndpoint, .status.outages[0]'
```

The connectivity check controller also logs metrics from these checks into Prometheus.

5. View all the metrics by running the following command:

```
$ oc exec prometheus-k8s-0 -n openshift-monitoring -- \
promtool query instant http://localhost:9090 \
'{component="openshift-network-diagnostics"}
```

6. View the latency between the source pod and the openshift api service for the last 5 minutes:



```
$ oc exec prometheus-k8s-0 -n openshift-monitoring -- \
promtool query instant http://localhost:9090 \
'{component="openshift-network-diagnostics}'
```

### 28.3.7. Additional resources

- [Gathering data about your cluster for Red Hat Support](#)
- [Implementation of connection health checks](#)
- [Verifying network connectivity for an endpoint](#)

## 28.4. OVN-KUBERNETES NETWORK POLICY

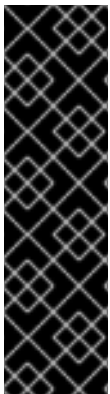

### IMPORTANT

The **AdminNetworkPolicy** resource is a Technology Preview feature only. Technology Preview features are not supported with Red Hat production service level agreements (SLAs) and might not be functionally complete. Red Hat does not recommend using them in production. These features provide early access to upcoming product features, enabling customers to test functionality and provide feedback during the development process.

For more information about the support scope of Red Hat Technology Preview features, see [Technology Preview Features Support Scope](#).

Kubernetes offers two features that users can use to enforce network security. One feature that allows users to enforce network policy is the **NetworkPolicy** API that is designed mainly for application developers and namespace tenants to protect their namespaces by creating namespace-scoped policies. For more information, see [About network policy](#).

The second feature is **AdminNetworkPolicy** which is comprised of two API: the **AdminNetworkPolicy** (ANP) API and the **BaselineAdminNetworkPolicy** (BANP) API. ANP and BANP are designed for cluster and network administrators to protect their entire cluster by creating cluster-scoped policies. Cluster administrators can use ANPs to enforce non-overrideable policies that take precedence over **NetworkPolicy** objects. Administrators can use BANP to setup and enforce optional cluster-scoped network policy rules that are overrideable by users using **NetworkPolicy** objects if need be. When used together ANP and BANP can create multi-tenancy policy that administrators can use to secure their cluster.

OVN-Kubernetes CNI in OpenShift Container Platform implements these network policies using Access Control List (ACLs) Tiers to evaluate and apply them. ACLs are evaluated in descending order from Tier 1 to Tier 3.

Tier 1 evaluates **AdminNetworkPolicy** (ANP) objects. Tier 2 evaluates **NetworkPolicy** objects. Tier 3 evaluates **BaselineAdminNetworkPolicy** (BANP) objects.

Figure 28.3. OVK-Kubernetes Access Control List (ACL)

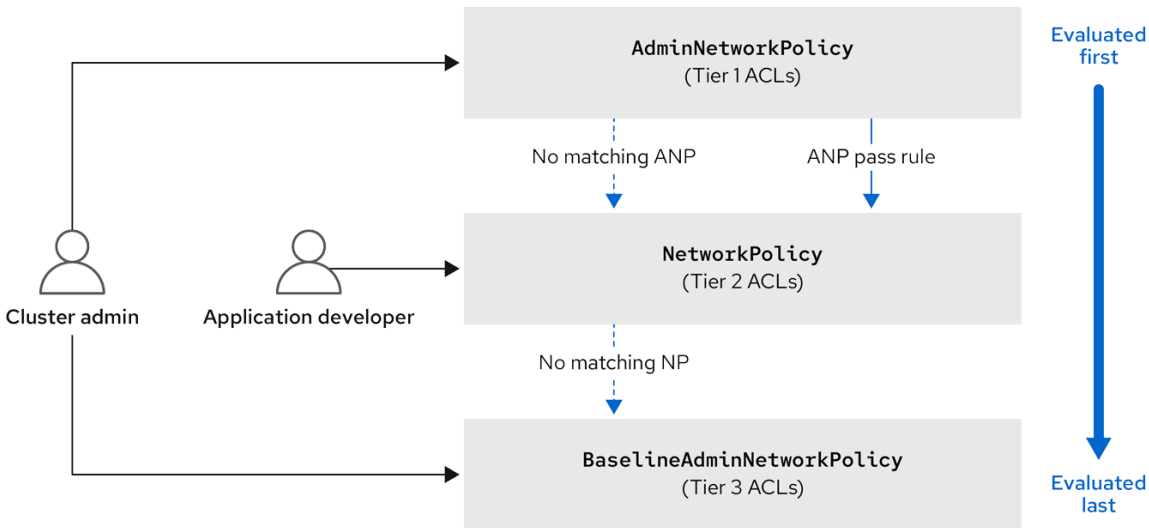

615\_OpenShift\_0324

If traffic matches an ANP rule, the rules in that ANP will be evaluated first. If the match is an ANP **allow** or **deny** rule, any existing **NetworkPolicies** and **BaselineAdminNetworkPolicy** (BANP) in the cluster will be intentionally skipped from evaluation. If the match is an ANP **pass** rule, then evaluation moves from tier 1 of the ACLs to tier 2 where the **NetworkPolicy** policy is evaluated.

### 28.4.1. AdminNetworkPolicy

An **AdminNetworkPolicy** (ANP) is a cluster-scoped custom resource definition (CRD). As a OpenShift Container Platform administrator, you can use ANP to secure your network by creating network policies before creating namespaces. Additionally, you can create network policies on a cluster-scoped level that is non-overridable by **NetworkPolicy** objects.

The key difference between **AdminNetworkPolicy** and **NetworkPolicy** objects are that the former is for administrators and is cluster scoped while the latter is for tenant owners and is namespace scoped.

An ANP allows administrators to specify the following:

- A **priority** value that determines the order of its evaluation. The lower the value the higher the precedence.
- A **subject** that consists of a set of namespaces or namespace..
- A list of ingress rules to be applied for all ingress traffic towards the **subject**.
- A list of egress rules to be applied for all egress traffic from the **subject**.

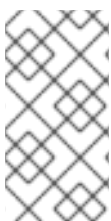

**NOTE**

The **AdminNetworkPolicy** resource is a **TechnologyPreviewNoUpgrade** feature that can be enabled on test clusters that are not in production. For more information on feature gates and **TechnologyPreviewNoUpgrade** features, see "Enabling features using feature gates" in the "Additional resources" of this section.

#### AdminNetworkPolicy example

Example 28.1. Example YAML file for an ANP

```

apiVersion: policy.networking.k8s.io/v1alpha1
kind: AdminNetworkPolicy
metadata:
 name: sample-anp-deny-pass-rules 1
spec:
 priority: 50 2
 subject:
 namespaces:
 matchLabels:
 kubernetes.io/metadata.name: example.name 3
 ingress: 4
 - name: "deny-all-ingress-tenant-1" 5
 action: "Deny"
 from:
 - pods:
 namespaces: 6
 namespaceSelector:
 matchLabels:
 custom-anp: tenant-1
 podSelector:
 matchLabels:
 custom-anp: tenant-1 7
 egress: 8
 - name: "pass-all-egress-to-tenant-1"
 action: "Pass"
 to:
 - pods:
 namespaces:
 namespaceSelector:
 matchLabels:
 custom-anp: tenant-1
 podSelector:
 matchLabels:
 custom-anp: tenant-1

```

- 1 Specify a name for your ANP.
- 2 The **spec.priority** field supports a maximum of 100 ANP in the values of 0-99 in a cluster. The lower the value the higher the precedence. Creating **AdminNetworkPolicy** with the same priority creates a nondeterministic outcome.
- 3 Specify the namespace to apply the ANP resource.
- 4 ANP have both ingress and egress rules. ANP rules for **spec.ingress** field accepts values of **Pass**, **Deny**, and **Allow** for the **action** field.
- 5 Specify a name for the **ingress.name**.
- 6 Specify the namespaces to select the pods from to apply the ANP resource.
- 7 Specify **podSelector.matchLabels** name of the pods to apply the ANP resource.
- 8 ANP have both ingress and egress rules. ANP rules for **spec.egress** field accepts values of **Pass**, **Deny**, and **Allow** for the **action** field.

## Additional resources

- [Enabling features using feature gates](#)
- [Network Policy API Working Group](#)

### 28.4.1.1. AdminNetworkPolicy actions for rules

As an administrator, you can set **Allow**, **Deny**, or **Pass** as the **action** field for your **AdminNetworkPolicy** rules. Because OVN-Kubernetes uses a tiered ACLs to evaluate network traffic rules, ANP allow you to set very strong policy rules that can only be changed by an administrator modifying them, deleting the rule, or overriding them by setting a higher priority rule.

#### AdminNetworkPolicy Allow example

The following ANP that is defined at priority 9 ensures all ingress traffic is allowed from the **monitoring** namespace towards any tenant (all other namespaces) in the cluster.

#### Example 28.2. Example YAML file for a strongAllow ANP

```
apiVersion: policy.networking.k8s.io/v1alpha1
kind: AdminNetworkPolicy
metadata:
 name: allow-monitoring
spec:
 priority: 9
 subject:
 namespaces: {}
 ingress:
 - name: "allow-ingress-from-monitoring"
 action: "Allow"
 from:
 - namespaces:
 namespaceSelector:
 matchLabels:
 kubernetes.io/metadata.name: monitoring
...
```

This is an example of a strong **Allow** ANP because it is non-overridable by all the parties involved. No tenants can block themselves from being monitored using **NetworkPolicy** objects and the monitoring tenant also has no say in what it can or cannot monitor.

#### AdminNetworkPolicy Deny example

The following ANP that is defined at priority 5 ensures all ingress traffic from the **monitoring** namespace is blocked towards restricted tenants (namespaces that have labels **security: restricted**).

#### Example 28.3. Example YAML file for a strongDeny ANP

```
apiVersion: policy.networking.k8s.io/v1alpha1
kind: AdminNetworkPolicy
metadata:
 name: block-monitoring
spec:
```

```

priority: 5
subject:
 namespaces:
 matchLabels:
 security: restricted
ingress:
- name: "deny-ingress-from-monitoring"
 action: "Deny"
 from:
 - namespaces:
 namespaceSelector:
 matchLabels:
 kubernetes.io/metadata.name: monitoring
...

```

This is a strong **Deny** ANP that is non-overridable by all the parties involved. The restricted tenant owners cannot authorize themselves to allow monitoring traffic, and the infrastructure's monitoring service cannot scrape anything from these sensitive namespaces.

When combined with the strong **Allow** example, the **block-monitoring** ANP has a lower priority value giving it higher precedence, which ensures restricted tenants are never monitored.

#### AdminNetworkPolicy Pass example

The following ANP that is defined at priority 7 ensures all ingress traffic from the **monitoring** namespace towards internal infrastructure tenants (namespaces that have labels **security: internal**) are passed on to tier 2 of the ACLs and evaluated by the namespaces' **NetworkPolicy** objects.

#### Example 28.4. Example YAML file for a strongPass ANP

```

apiVersion: policy.networking.k8s.io/v1alpha1
kind: AdminNetworkPolicy
metadata:
 name: pass-monitoring
spec:
 priority: 7
 subject:
 namespaces:
 matchLabels:
 security: internal
 ingress:
 - name: "pass-ingress-from-monitoring"
 action: "Pass"
 from:
 - namespaces:
 namespaceSelector:
 matchLabels:
 kubernetes.io/metadata.name: monitoring
...

```

This example is a strong **Pass** action ANP because it delegates the decision to **NetworkPolicy** objects defined by tenant owners. This **pass-monitoring** ANP allows all tenant owners grouped at security level **internal** to choose if their metrics should be scraped by the infrastructures' monitoring service using namespace scoped **NetworkPolicy** objects.

## 28.4.2. BaselineAdminNetworkPolicy

**BaselineAdminNetworkPolicy** (BANP) is a cluster-scoped custom resource definition (CRD). As a OpenShift Container Platform administrator, you can use BANP to setup and enforce optional baseline network policy rules that are overridable by users using **NetworkPolicy** objects if need be. Rule actions for BANP are **allow** or **deny**.

The **BaselineAdminNetworkPolicy** resource is a cluster singleton object that can be used as a guardrail policy incase a passed traffic policy does not match any **NetworkPolicy** objects in the cluster. A BANP can also be used as a default security model that provides guardrails that intra-cluster traffic is blocked by default and a user will need to use **NetworkPolicy** objects to allow known traffic. You must use **default** as the name when creating a BANP resource.

A BANP allows administrators to specify:

- A **subject** that consists of a set of namespaces or namespace.
- A list of ingress rules to be applied for all ingress traffic towards the **subject**.
- A list of egress rules to be applied for all egress traffic from the **subject**.



### NOTE

**BaselineAdminNetworkPolicy** is a **TechnologyPreviewNoUpgrade** feature that can be enabled on test clusters that are not in production.

### BaselineAdminNetworkPolicy example

#### Example 28.5. Example YAML file for BANP

```
apiVersion: policy.networking.k8s.io/v1alpha1
kind: BaselineAdminNetworkPolicy
metadata:
 name: default 1
spec:
 subject:
 namespaces:
 matchLabels:
 kubernetes.io/metadata.name: example.name 2
 ingress: 3
 - name: "deny-all-ingress-from-tenant-1" 4
 action: "Deny"
 from:
 - pods:
 namespaces:
 namespaceSelector:
 matchLabels:
 custom-banp: tenant-1 5
 podSelector:
 matchLabels:
 custom-banp: tenant-1 6
 egress:
 - name: "allow-all-egress-to-tenant-1"
 action: "Allow"
 to:
```

```
- pods:
 namespaces:
 namespaceSelector:
 matchLabels:
 custom-banp: tenant-1
 podSelector:
 matchLabels:
 custom-banp: tenant-1
```

- 1 The policy name must be **default** because BANP is a singleton object.
- 2 Specify the namespace to apply the ANP to.
- 3 BANP have both ingress and egress rules. BANP rules for **spec.ingress** and **spec.egress** fields accepts values of **Deny** and **Allow** for the **action** field.
- 4 Specify a name for the **ingress.name**
- 5 Specify the namespaces to select the pods from to apply the BANP resource.
- 6 Specify **podSelector.matchLabels** name of the pods to apply the BANP resource.

### BaselineAdminNetworkPolicy Deny example

The following BANP singleton ensures that the administrator has set up a default deny policy for all ingress monitoring traffic coming into the tenants at **internal** security level. When combined with the "AdminNetworkPolicy Pass example", this deny policy acts as a guardrail policy for all ingress traffic that is passed by the ANP **pass-monitoring** policy.

#### Example 28.6. Example YAML file for a guardrailDeny rule

```
apiVersion: policy.networking.k8s.io/v1alpha1
kind: BaselineAdminNetworkPolicy
metadata:
 name: default
spec:
 subject:
 namespaces:
 matchLabels:
 security: internal
 ingress:
 - name: "deny-ingress-from-monitoring"
 action: "Deny"
 from:
 - namespaces:
 namespaceSelector:
 matchLabels:
 kubernetes.io/metadata.name: monitoring
...
```

You can use an **AdminNetworkPolicy** resource with a **Pass** value for the **action** field in conjunction with the **BaselineAdminNetworkPolicy** resource to create a multi-tenant policy. This multi-tenant policy allows one tenant to collect monitoring data on their application while simultaneously not

collecting data from a second tenant.

As an administrator, if you apply both the "AdminNetworkPolicy **Pass** action example" and the "BaselineAdminNetwork Policy **Deny** example", tenants are then left with the ability to choose to create a **NetworkPolicy** resource that will be evaluated before the BANP.

For example, Tenant 1 can set up the following **NetworkPolicy** resource to monitor ingress traffic:

### Example 28.7. Example NetworkPolicy

```
apiVersion: networking.k8s.io/v1
kind: NetworkPolicy
metadata:
 name: allow-monitoring
 namespace: tenant 1
spec:
 podSelector:
 policyTypes:
 - Ingress
 ingress:
 - from:
 - namespaceSelector:
 matchLabels:
 kubernetes.io/metadata.name: monitoring
...
```

In this scenario, Tenant 1's policy would be evaluated after the "AdminNetworkPolicy **Pass** action example" and before the "BaselineAdminNetwork Policy **Deny** example", which denies all ingress monitoring traffic coming into tenants with **security** level **internal**. With Tenant 1's **NetworkPolicy** object in place, they will be able to collect data on their application. Tenant 2, however, who does not have any **NetworkPolicy** objects in place, will not be able to collect data. As an administrator, you have not by default monitored internal tenants, but instead, you created a BANP that allows tenants to use **NetworkPolicy** objects to override the default behavior of your BANP.

## 28.5. TRACING OPENFLOW WITH OVNKUBE-TRACE

OVN and OVS traffic flows can be simulated in a single utility called **ovnkube-trace**. The **ovnkube-trace** utility runs **ovn-trace**, **ovs-appctl ofproto/trace** and **ovn-detrace** and correlates that information in a single output.

You can execute the **ovnkube-trace** binary from a dedicated container. For releases after OpenShift Container Platform 4.7, you can also copy the binary to a local host and execute it from that host.

### 28.5.1. Installing the ovnkube-trace on local host

The **ovnkube-trace** tool traces packet simulations for arbitrary UDP or TCP traffic between points in an OVN-Kubernetes driven OpenShift Container Platform cluster. Copy the **ovnkube-trace** binary to your local host making it available to run against the cluster.

#### Prerequisites

- You installed the OpenShift CLI (**oc**).



- You are logged in to the cluster with a user with **cluster-admin** privileges.

## Procedure

- Create a pod variable by using the following command:

```
$ POD=$(oc get pods -n openshift-ovn-kubernetes -l app=ovnkube-control-plane -o name | head -1 | awk -F '/' '{print $NF}')
```

- Run the following command on your local host to copy the binary from the **ovnkube-control-plane** pods:

```
$ oc cp -n openshift-ovn-kubernetes $POD:/usr/bin/ovnkube-trace -c ovnkube-cluster-manager ovnkube-trace
```

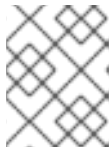

### NOTE

If you are using Red Hat Enterprise Linux (RHEL) 8 to run the **ovnkube-trace** tool, you must copy the file **/usr/lib/rhel8/ovnkube-trace** to your local host.

- Make **ovnkube-trace** executable by running the following command:

```
$ chmod +x ovnkube-trace
```

- Display the options available with **ovnkube-trace** by running the following command:

```
$./ovnkube-trace -help
```

## Expected output

```
Usage of ./ovnkube-trace:
 -addr-family string
 Address family (ip4 or ip6) to be used for tracing (default "ip4")
 -dst string
 dest: destination pod name
 -dst-ip string
 destination IP address (meant for tests to external targets)
 -dst-namespace string
 k8s namespace of dest pod (default "default")
 -dst-port string
 dst-port: destination port (default "80")
 -kubeconfig string
 absolute path to the kubeconfig file
 -loglevel string
 loglevel: klog level (default "0")
 -ovn-config-namespace string
 namespace used by ovn-config itself
 -service string
 service: destination service name
 -skip-detrace
 skip ovn-detrace command
 -src string
 src: source pod name
```

```

-src-namespace string
 k8s namespace of source pod (default "default")
-tcp
 use tcp transport protocol
-udp
 use udp transport protocol

```

The command-line arguments supported are familiar Kubernetes constructs, such as namespaces, pods, services so you do not need to find the MAC address, the IP address of the destination nodes, or the ICMP type.

The log levels are:

- 0 (minimal output)
- 2 (more verbose output showing results of trace commands)
- 5 (debug output)

### 28.5.2. Running `ovnkube-trace`

Run **ovn-trace** to simulate packet forwarding within an OVN logical network.

#### Prerequisites

- You installed the OpenShift CLI (**oc**).
- You are logged in to the cluster with a user with **cluster-admin** privileges.
- You have installed **ovnkube-trace** on local host

#### Example: Testing that DNS resolution works from a deployed pod

This example illustrates how to test the DNS resolution from a deployed pod to the core DNS pod that runs in the cluster.

#### Procedure

1. Start a web service in the default namespace by entering the following command:

```

$ oc run web --namespace=default --image=quay.io/openshifttest/nginx --labels="app=web" -
-expose --port=80

```

2. List the pods running in the **openshift-dns** namespace:

```

oc get pods -n openshift-dns

```

#### Example output

```

NAME READY STATUS RESTARTS AGE
dns-default-8s42x 2/2 Running 0 5h8m
dns-default-mdw6r 2/2 Running 0 4h58m
dns-default-p8t5h 2/2 Running 0 4h58m
dns-default-rl6nk 2/2 Running 0 5h8m
dns-default-xbgqx 2/2 Running 0 5h8m

```

```

dns-default-zv8f6 2/2 Running 0 4h58m
node-resolver-62jbb 1/1 Running 0 5h8m
node-resolver-8z4cj 1/1 Running 0 4h59m
node-resolver-bq244 1/1 Running 0 5h8m
node-resolver-hc58n 1/1 Running 0 4h59m
node-resolver-lm6z4 1/1 Running 0 5h8m
node-resolver-zfx5k 1/1 Running 0 5h

```

3. Run the following **ovnkube-trace** command to verify DNS resolution is working:

```

$./ovnkube-trace \
-src-namespace default \ ❶
-src web \ ❷
-dst-namespace openshift-dns \ ❸
-dst dns-default-p8t5h \ ❹
-udp -dst-port 53 \ ❺
-loglevel 0 ❻

```

- ❶ Namespace of the source pod
- ❷ Source pod name
- ❸ Namespace of destination pod
- ❹ Destination pod name
- ❺ Use the **udp** transport protocol. Port 53 is the port the DNS service uses.
- ❻ Set the log level to 0 (0 is minimal and 5 is debug)

#### Example output if the **src&dst** pod lands on the same node:

```

ovn-trace source pod to destination pod indicates success from web to dns-default-p8t5h
ovn-trace destination pod to source pod indicates success from dns-default-p8t5h to web
ovs-appctl ofproto/trace source pod to destination pod indicates success from web to dns-
default-p8t5h
ovs-appctl ofproto/trace destination pod to source pod indicates success from dns-default-
p8t5h to web
ovn-detrace source pod to destination pod indicates success from web to dns-default-p8t5h
ovn-detrace destination pod to source pod indicates success from dns-default-p8t5h to web

```

#### Example output if the **src&dst** pod lands on a different node:

```

ovn-trace source pod to destination pod indicates success from web to dns-default-8s42x
ovn-trace (remote) source pod to destination pod indicates success from web to dns-default-
8s42x
ovn-trace destination pod to source pod indicates success from dns-default-8s42x to web
ovn-trace (remote) destination pod to source pod indicates success from dns-default-8s42x to
web
ovs-appctl ofproto/trace source pod to destination pod indicates success from web to dns-
default-8s42x
ovs-appctl ofproto/trace destination pod to source pod indicates success from dns-default-

```

```
8s42x to web
```

```
ovn-detrace source pod to destination pod indicates success from web to dns-default-8s42x
ovn-detrace destination pod to source pod indicates success from dns-default-8s42x to web
```

The output indicates success from the deployed pod to the DNS port and also indicates that it is successful going back in the other direction. So you know bi-directional traffic is supported on UDP port 53 if my web pod wants to do dns resolution from core DNS.

If for example that did not work and you wanted to get the **ovn-trace**, the **ovs-appctl** of **proto/trace** and **ovn-detrace**, and more debug type information increase the log level to 2 and run the command again as follows:

```

$./ovnkube-trace \
 -src-namespace default \
 -src web \
 -dst-namespace openshift-dns \
 -dst dns-default-467qw \
 -udp -dst-port 53 \
 -loglevel 2

```

The output from this increased log level is too much to list here. In a failure situation the output of this command shows which flow is dropping that traffic. For example an egress or ingress network policy may be configured on the cluster that does not allow that traffic.

### Example: Verifying by using debug output a configured default deny

This example illustrates how to identify by using the debug output that an ingress default deny policy blocks traffic.

#### Procedure

1. Create the following YAML that defines a **deny-by-default** policy to deny ingress from all pods in all namespaces. Save the YAML in the **deny-by-default.yaml** file:

```

kind: NetworkPolicy
apiVersion: networking.k8s.io/v1
metadata:
 name: deny-by-default
 namespace: default
spec:
 podSelector: {}
 ingress: []

```

2. Apply the policy by entering the following command:

```
$ oc apply -f deny-by-default.yaml
```

#### Example output

```
networkpolicy.networking.k8s.io/deny-by-default created
```

3. Start a web service in the **default** namespace by entering the following command:

```
$ oc run web --namespace=default --image=quay.io/openshifttest/nginx --labels="app=web" -
-expose --port=80
```

- Run the following command to create the **prod** namespace:

```
$ oc create namespace prod
```

- Run the following command to label the **prod** namespace:

```
$ oc label namespace/prod purpose=production
```

- Run the following command to deploy an **alpine** image in the **prod** namespace and start a shell:

```
$ oc run test-6459 --namespace=prod --rm -i -t --image=alpine -- sh
```

- Open another terminal session.

- In this new terminal session run **ovn-trace** to verify the failure in communication between the source pod **test-6459** running in namespace **prod** and destination pod running in the **default** namespace:

```
$/ovnkube-trace \
-src-namespace prod \
-src test-6459 \
-dst-namespace default \
-dst web \
-tcp -dst-port 80 \
-loglevel 0
```

### Example output

```
ovn-trace source pod to destination pod indicates failure from test-6459 to web
```

- Increase the log level to 2 to expose the reason for the failure by running the following command:

```
$/ovnkube-trace \
-src-namespace prod \
-src test-6459 \
-dst-namespace default \
-dst web \
-tcp -dst-port 80 \
-loglevel 2
```

### Example output

```
...

3. ls_out_acl_hint (northd.c:7454): !ct.new && ct.est && !ct.rpl && ct_mark.blocked == 0,
priority 4, uuid 12efc456
 reg0[8] = 1;
 reg0[10] = 1;
```

```

next;
5. ls_out_acl_action (northd.c:7835): reg8[30..31] == 0, priority 500, uuid 69372c5d
 reg8[30..31] = 1;
 next(4);
5. ls_out_acl_action (northd.c:7835): reg8[30..31] == 1, priority 500, uuid 2fa0af89
 reg8[30..31] = 2;
 next(4);
4. ls_out_acl_eval (northd.c:7691): reg8[30..31] == 2 && reg0[10] == 1 && (outport ==
@a16982411286042166782_ingressDefaultDeny), priority 2000, uuid 447d0dab
 reg8[17] = 1;
 ct_commit { ct_mark.blocked = 1; }; ❶
 next;
...

```

❶ Ingress traffic is blocked due to the default deny policy being in place.

10. Create a policy that allows traffic from all pods in a particular namespaces with a label **purpose=production**. Save the YAML in the **web-allow-prod.yaml** file:

```

kind: NetworkPolicy
apiVersion: networking.k8s.io/v1
metadata:
 name: web-allow-prod
 namespace: default
spec:
 podSelector:
 matchLabels:
 app: web
 policyTypes:
 - Ingress
 ingress:
 - from:
 - namespaceSelector:
 matchLabels:
 purpose: production

```

11. Apply the policy by entering the following command:

```
$ oc apply -f web-allow-prod.yaml
```

12. Run **ovnkube-trace** to verify that traffic is now allowed by entering the following command:

```

$./ovnkube-trace \
 -src-namespace prod \
 -src test-6459 \
 -dst-namespace default \
 -dst web \
 -tcp -dst-port 80 \
 -loglevel 0

```

### Expected output

```
ovn-trace source pod to destination pod indicates success from test-6459 to web
```

```

ovn-trace destination pod to source pod indicates success from web to test-6459
ovs-appctl ofproto/trace source pod to destination pod indicates success from test-6459 to
web
ovs-appctl ofproto/trace destination pod to source pod indicates success from web to test-
6459
ovn-detrace source pod to destination pod indicates success from test-6459 to web
ovn-detrace destination pod to source pod indicates success from web to test-6459

```

- Run the following command in the shell that was opened in step six to connect nginx to the web-server:

```
wget -qO- --timeout=2 http://web.default
```

### Expected output

```

<!DOCTYPE html>
<html>
<head>
<title>Welcome to nginx!</title>
<style>
 body {
 width: 35em;
 margin: 0 auto;
 font-family: Tahoma, Verdana, Arial, sans-serif;
 }
</style>
</head>
<body>
<h1>Welcome to nginx!</h1>
<p>If you see this page, the nginx web server is successfully installed and
working. Further configuration is required.</p>

<p>For online documentation and support please refer to
nginx.org.

Commercial support is available at
nginx.com.</p>

<p>Thank you for using nginx.</p>
</body>
</html>

```

### 28.5.3. Additional resources

- [Tracing Openflow with ovnkube-trace utility](#)
- [ovnkube-trace](#)

## 28.6. MIGRATING FROM THE OPENSIFT SDN NETWORK PLUGIN

As a cluster administrator, you can migrate to the OVN-Kubernetes network plugin from the OpenShift SDN network plugin.

To learn more about OVN-Kubernetes, read [About the OVN-Kubernetes network plugin](#).

## 28.6.1. Migration to the OVN-Kubernetes network plugin

Migrating to the OVN-Kubernetes network plugin is a manual process that includes some downtime during which your cluster is unreachable. Although a rollback procedure is provided, the migration is intended to be a one-way process.

A migration to the OVN-Kubernetes network plugin is supported on the following platforms:

- Bare metal hardware
- Amazon Web Services (AWS)
- Google Cloud Platform (GCP)
- IBM Cloud®
- Microsoft Azure
- Red Hat OpenStack Platform (RHOSP)
- VMware vSphere



### IMPORTANT

Migrating to or from the OVN-Kubernetes network plugin is not supported for managed OpenShift cloud services such as Red Hat OpenShift Dedicated, Azure Red Hat OpenShift (ARO), and Red Hat OpenShift Service on AWS (ROSA).

Migrating from OpenShift SDN network plugin to OVN-Kubernetes network plugin is not supported on Nutanix.



### NOTE

OpenShift SDN CNI is deprecated as of OpenShift Container Platform 4.14. As of OpenShift Container Platform 4.15, the network plugin is not an option for new installations. In a subsequent future release, the OpenShift SDN network plugin is planned to be removed and no longer supported. Red Hat will provide bug fixes and support for this feature until it is removed, but this feature will no longer receive enhancements. As an alternative to OpenShift SDN CNI, you can use OVN Kubernetes CNI instead.

### 28.6.1.1. Considerations for migrating to the OVN-Kubernetes network plugin

If you have more than 150 nodes in your OpenShift Container Platform cluster, then open a support case for consultation on your migration to the OVN-Kubernetes network plugin.

The subnets assigned to nodes and the IP addresses assigned to individual pods are not preserved during the migration.

While the OVN-Kubernetes network plugin implements many of the capabilities present in the OpenShift SDN network plugin, the configuration is not the same.

- If your cluster uses any of the following OpenShift SDN network plugin capabilities, you must manually configure the same capability in the OVN-Kubernetes network plugin:
  - Namespace isolation



- Egress router pods
- If your cluster or surrounding network uses any part of the **100.64.0.0/16** address range, you must choose another unused IP range by specifying the **v4InternalSubnet** spec under the **spec.defaultNetwork.ovnKubernetesConfig** object definition. OVN-Kubernetes uses the IP range **100.64.0.0/16** internally by default.

The following sections highlight the differences in configuration between the aforementioned capabilities in OVN-Kubernetes and OpenShift SDN network plugins.

### Namespace isolation

OVN-Kubernetes supports only the network policy isolation mode.



### IMPORTANT

If your cluster uses OpenShift SDN configured in either the multitenant or subnet isolation modes, you cannot migrate to the OVN-Kubernetes network plugin.

### Egress IP addresses

OpenShift SDN supports two different Egress IP modes:

- In the *automatically assigned* approach, an egress IP address range is assigned to a node.
- In the *manually assigned* approach, a list of one or more egress IP addresses is assigned to a node.

The migration process supports migrating Egress IP configurations that use the automatically assigned mode.

The differences in configuring an egress IP address between OVN-Kubernetes and OpenShift SDN is described in the following table:

**Table 28.4. Differences in egress IP address configuration**

OVN-Kubernetes	OpenShift SDN
<ul style="list-style-type: none"> <li>• Create an <b>EgressIPs</b> object</li> <li>• Add an annotation on a <b>Node</b> object</li> </ul>	<ul style="list-style-type: none"> <li>• Patch a <b>NetNamespace</b> object</li> <li>• Patch a <b>HostSubnet</b> object</li> </ul>

For more information on using egress IP addresses in OVN-Kubernetes, see "Configuring an egress IP address".

### Egress network policies

The difference in configuring an egress network policy, also known as an egress firewall, between OVN-Kubernetes and OpenShift SDN is described in the following table:

**Table 28.5. Differences in egress network policy configuration**

OVN-Kubernetes	OpenShift SDN
<ul style="list-style-type: none"> <li>• Create an <b>EgressFirewall</b> object in a namespace</li> </ul>	<ul style="list-style-type: none"> <li>• Create an <b>EgressNetworkPolicy</b> object in a namespace</li> </ul>



## NOTE

Because the name of an **EgressFirewall** object can only be set to **default**, after the migration all migrated **EgressNetworkPolicy** objects are named **default**, regardless of what the name was under OpenShift SDN.

If you subsequently rollback to OpenShift SDN, all **EgressNetworkPolicy** objects are named **default** as the prior name is lost.

For more information on using an egress firewall in OVN-Kubernetes, see "Configuring an egress firewall for a project".

### Egress router pods

OVN-Kubernetes supports egress router pods in redirect mode. OVN-Kubernetes does not support egress router pods in HTTP proxy mode or DNS proxy mode.

When you deploy an egress router with the Cluster Network Operator, you cannot specify a node selector to control which node is used to host the egress router pod.

### Multicast

The difference between enabling multicast traffic on OVN-Kubernetes and OpenShift SDN is described in the following table:

**Table 28.6. Differences in multicast configuration**

OVN-Kubernetes	OpenShift SDN
<ul style="list-style-type: none"> <li>• Add an annotation on a <b>Namespace</b> object</li> </ul>	<ul style="list-style-type: none"> <li>• Add an annotation on a <b>NetNamespace</b> object</li> </ul>

For more information on using multicast in OVN-Kubernetes, see "Enabling multicast for a project".

### Network policies

OVN-Kubernetes fully supports the Kubernetes **NetworkPolicy** API in the **networking.k8s.io/v1** API group. No changes are necessary in your network policies when migrating from OpenShift SDN.

#### 28.6.1.2. How the migration process works

The following table summarizes the migration process by segmenting between the user-initiated steps in the process and the actions that the migration performs in response.

**Table 28.7. Migrating to OVN-Kubernetes from OpenShift SDN**

User-initiated steps	Migration activity
Set the <b>migration</b> field of the <b>Network.operator.openshift.io</b> custom resource (CR) named <b>cluster</b> to <b>OVNKubernetes</b> . Make sure the <b>migration</b> field is <b>null</b> before setting it to a value.	<p><b>Cluster Network Operator (CNO)</b></p> <p>Updates the status of the <b>Network.config.openshift.io</b> CR named <b>cluster</b> accordingly.</p> <p><b>Machine Config Operator (MCO)</b></p> <p>Rolls out an update to the systemd configuration necessary for OVN-Kubernetes; the MCO updates a single machine per pool at a time by default, causing the total time the migration takes to increase with the size of the cluster.</p>
Update the <b>networkType</b> field of the <b>Network.config.openshift.io</b> CR.	<p><b>CNO</b></p> <p>Performs the following actions:</p> <ul style="list-style-type: none"> <li>• Destroys the OpenShift SDN control plane pods.</li> <li>• Deploys the OVN-Kubernetes control plane pods.</li> <li>• Updates the Multus objects to reflect the new network plugin.</li> </ul>
Reboot each node in the cluster.	<p><b>Cluster</b></p> <p>As nodes reboot, the cluster assigns IP addresses to pods on the OVN-Kubernetes cluster network.</p>

If a rollback to OpenShift SDN is required, the following table describes the process.

**Table 28.8. Performing a rollback to OpenShift SDN**

User-initiated steps	Migration activity
Suspend the MCO to ensure that it does not interrupt the migration.	The MCO stops.
Set the <b>migration</b> field of the <b>Network.operator.openshift.io</b> custom resource (CR) named <b>cluster</b> to <b>OpenShiftSDN</b> . Make sure the <b>migration</b> field is <b>null</b> before setting it to a value.	<p><b>CNO</b></p> <p>Updates the status of the <b>Network.config.openshift.io</b> CR named <b>cluster</b> accordingly.</p>

User-initiated steps	Migration activity
Update the <b>networkType</b> field.	<p><b>CNO</b></p> <p>Performs the following actions:</p> <ul style="list-style-type: none"> <li>• Destroys the OVN-Kubernetes control plane pods.</li> <li>• Deploys the OpenShift SDN control plane pods.</li> <li>• Updates the Multus objects to reflect the new network plugin.</li> </ul>
Reboot each node in the cluster.	<p><b>Cluster</b></p> <p>As nodes reboot, the cluster assigns IP addresses to pods on the OpenShift-SDN network.</p>
Enable the MCO after all nodes in the cluster reboot.	<p><b>MCO</b></p> <p>Rolls out an update to the systemd configuration necessary for OpenShift SDN; the MCO updates a single machine per pool at a time by default, so the total time the migration takes increases with the size of the cluster.</p>

### 28.6.2. Migrating to the OVN-Kubernetes network plugin

As a cluster administrator, you can change the network plugin for your cluster to OVN-Kubernetes. During the migration, you must reboot every node in your cluster.

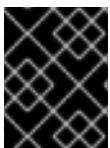

#### IMPORTANT

While performing the migration, your cluster is unavailable and workloads might be interrupted. Perform the migration only when an interruption in service is acceptable.

#### Prerequisites

- A cluster configured with the OpenShift SDN CNI network plugin in the network policy isolation mode.
- Install the OpenShift CLI (**oc**).
- Access to the cluster as a user with the **cluster-admin** role.
- A recent backup of the etcd database is available.
- A reboot can be triggered manually for each node.
- The cluster is in a known good state, without any errors.

- On all cloud platforms after updating software, a security group rule must be in place to allow UDP packets on port **6081** for all nodes.

## Procedure

1. To backup the configuration for the cluster network, enter the following command:

```
$ oc get Network.config.openshift.io cluster -o yaml > cluster-openshift-sdn.yaml
```

2. To prepare all the nodes for the migration, set the **migration** field on the Cluster Network Operator configuration object by entering the following command:

```
$ oc patch Network.operator.openshift.io cluster --type='merge' \
 --patch '{"spec": {"migration": {"networkType": "OVNKubernetes" } } }'
```



### NOTE

This step does not deploy OVN-Kubernetes immediately. Instead, specifying the **migration** field triggers the Machine Config Operator (MCO) to apply new machine configs to all the nodes in the cluster in preparation for the OVN-Kubernetes deployment.

3. Optional: You can disable automatic migration of several OpenShift SDN capabilities to the OVN-Kubernetes equivalents:
  - Egress IPs
  - Egress firewall
  - Multicast

To disable automatic migration of the configuration for any of the previously noted OpenShift SDN features, specify the following keys:

```
$ oc patch Network.operator.openshift.io cluster --type='merge' \
 --patch '{
 "spec": {
 "migration": {
 "networkType": "OVNKubernetes",
 "features": {
 "egressIP": <bool>,
 "egressFirewall": <bool>,
 "multicast": <bool>
 }
 }
 }
 }'
```

where:

**bool**: Specifies whether to enable migration of the feature. The default is **true**.

4. Optional: You can customize the following settings for OVN-Kubernetes to meet your network infrastructure requirements:

- Maximum transmission unit (MTU). Consider the following before customizing the MTU for this optional step:
  - If you use the default MTU, and you want to keep the default MTU during migration, this step can be ignored.
  - If you used a custom MTU, and you want to keep the custom MTU during migration, you must declare the custom MTU value in this step.
  - This step does not work if you want to change the MTU value during migration. Instead, you must first follow the instructions for "Changing the cluster MTU". You can then keep the custom MTU value by performing this procedure and declaring the custom MTU value in this step.



#### NOTE

OpenShift-SDN and OVN-Kubernetes have different overlay overhead. MTU values should be selected by following the guidelines found on the "MTU value selection" page.

- Geneve (Generic Network Virtualization Encapsulation) overlay network port
- OVN-Kubernetes IPv4 internal subnet
- OVN-Kubernetes IPv6 internal subnet

To customize either of the previously noted settings, enter and customize the following command. If you do not need to change the default value, omit the key from the patch.

```
$ oc patch Network.operator.openshift.io cluster --type=merge \
 --patch '{
 "spec":{
 "defaultNetwork":{
 "ovnKubernetesConfig":{
 "mtu":<mtu>,
 "genevePort":<port>,
 "v4InternalSubnet":"<ipv4_subnet>",
 "v6InternalSubnet":"<ipv6_subnet>"
 }
 }
 }
}'
```

where:

#### mtu

The MTU for the Geneve overlay network. This value is normally configured automatically, but if the nodes in your cluster do not all use the same MTU, then you must set this explicitly to **100** less than the smallest node MTU value.

#### port

The UDP port for the Geneve overlay network. If a value is not specified, the default is **6081**. The port cannot be the same as the VXLAN port that is used by OpenShift SDN. The default value for the VXLAN port is **4789**.

#### ipv4\_subnet

An IPv4 address range for internal use by OVN-Kubernetes. You must ensure that the IP address range does not overlap with any other subnet used by your OpenShift Container Platform installation. The IP address range must be larger than the maximum number of

nodes that can be added to the cluster. The default value is **100.64.0.0/16**.

### ipv6\_subnet

An IPv6 address range for internal use by OVN-Kubernetes. You must ensure that the IP address range does not overlap with any other subnet used by your OpenShift Container Platform installation. The IP address range must be larger than the maximum number of nodes that can be added to the cluster. The default value is **fd98::/48**.

### Example patch command to update mtu field

```
$ oc patch Network.operator.openshift.io cluster --type=merge \
 --patch '{
 "spec":{
 "defaultNetwork":{
 "ovnKubernetesConfig":{
 "mtu":1200
 }
 }
 }
}'
```

5. As the MCO updates machines in each machine config pool, it reboots each node one by one. You must wait until all the nodes are updated. Check the machine config pool status by entering the following command:

```
$ oc get mcp
```

A successfully updated node has the following status: **UPDATED=true, UPDATING=false, DEGRADED=false**.



#### NOTE

By default, the MCO updates one machine per pool at a time, causing the total time the migration takes to increase with the size of the cluster.

6. Confirm the status of the new machine configuration on the hosts:
  - a. To list the machine configuration state and the name of the applied machine configuration, enter the following command:

```
$ oc describe node | egrep "hostname|machineconfig"
```

### Example output

```
kubernetes.io/hostname=master-0
machineconfiguration.openshift.io/currentConfig: rendered-master-
c53e221d9d24e1c8bb6ee89dd3d8ad7b
machineconfiguration.openshift.io/desiredConfig: rendered-master-
c53e221d9d24e1c8bb6ee89dd3d8ad7b
machineconfiguration.openshift.io/reason:
machineconfiguration.openshift.io/state: Done
```

Verify that the following statements are true:

- The value of **machineconfiguration.openshift.io/state** field is **Done**.

- The value of the **machineconfiguration.openshift.io/currentConfig** field is equal to the value of the **machineconfiguration.openshift.io/desiredConfig** field.
- b. To confirm that the machine config is correct, enter the following command:

```
$ oc get machineconfig <config_name> -o yaml | grep ExecStart
```

where **<config\_name>** is the name of the machine config from the **machineconfiguration.openshift.io/currentConfig** field.

The machine config must include the following update to the systemd configuration:

```
ExecStart=/usr/local/bin/configure-ovs.sh OVNKubernetes
```

- c. If a node is stuck in the **NotReady** state, investigate the machine config daemon pod logs and resolve any errors.
- i. To list the pods, enter the following command:

```
$ oc get pod -n openshift-machine-config-operator
```

### Example output

NAME	READY	STATUS	RESTARTS	AGE
machine-config-controller-75f756f89d-sjp8b	1/1	Running	0	37m
machine-config-daemon-5cf4b	2/2	Running	0	43h
machine-config-daemon-7wzcd	2/2	Running	0	43h
machine-config-daemon-fc946	2/2	Running	0	43h
machine-config-daemon-g2v28	2/2	Running	0	43h
machine-config-daemon-gcl4f	2/2	Running	0	43h
machine-config-daemon-l5tnv	2/2	Running	0	43h
machine-config-operator-79d9c55d5-hth92	1/1	Running	0	37m
machine-config-server-bsc8h	1/1	Running	0	43h
machine-config-server-hklrm	1/1	Running	0	43h
machine-config-server-k9rtx	1/1	Running	0	43h

The names for the config daemon pods are in the following format: **machine-config-daemon-**<seq>****. The **<seq>** value is a random five character alphanumeric sequence.

- ii. Display the pod log for the first machine config daemon pod shown in the previous output by enter the following command:
- ```
$ oc logs <pod> -n openshift-machine-config-operator
```
- where **pod** is the name of a machine config daemon pod.
- iii. Resolve any errors in the logs shown by the output from the previous command.
7. To start the migration, configure the OVN-Kubernetes network plugin by using one of the following commands:
- To specify the network provider without changing the cluster network IP address block, enter the following command:

```
$ oc patch Network.config.openshift.io cluster \
  --type='merge' --patch '{ "spec": { "networkType": "OVNKubernetes" } }'
```

- To specify a different cluster network IP address block, enter the following command:

```
$ oc patch Network.config.openshift.io cluster \
  --type='merge' --patch '{
  "spec": {
    "clusterNetwork": [
      {
        "cidr": "<cidr>",
        "hostPrefix": <prefix>
      }
    ],
    "networkType": "OVNKubernetes"
  }
}'
```

where **cidr** is a CIDR block and **prefix** is the slice of the CIDR block apportioned to each node in your cluster. You cannot use any CIDR block that overlaps with the **100.64.0.0/16** CIDR block because the OVN-Kubernetes network provider uses this block internally.



IMPORTANT

You cannot change the service network address block during the migration.

8. Verify that the Multus daemon set rollout is complete before continuing with subsequent steps:

```
$ oc -n openshift-multus rollout status daemonset/multus
```

The name of the Multus pods is in the form of **multus-*<xxxxxx>*** where **<xxxxxx>** is a random sequence of letters. It might take several moments for the pods to restart.

Example output

```
Waiting for daemon set "multus" rollout to finish: 1 out of 6 new pods have been updated...
...
Waiting for daemon set "multus" rollout to finish: 5 of 6 updated pods are available...
daemon set "multus" successfully rolled out
```

9. To complete changing the network plugin, reboot each node in your cluster. You can reboot the nodes in your cluster with either of the following approaches:

- With the **oc rsh** command, you can use a bash script similar to the following:

```
#!/bin/bash
readarray -t POD_NODES <<< "$(oc get pod -n openshift-machine-config-operator -o
wide| grep daemon|awk '{print $1" "$7}')"

for i in "${POD_NODES[@]}"
do
  read -r POD NODE <<< "$i"
  until oc rsh -n openshift-machine-config-operator "$POD" chroot /rootfs shutdown -r +1
  do
```

```

    echo "cannot reboot node $NODE, retry" && sleep 3
done
done

```

- With the **ssh** command, you can use a bash script similar to the following. The script assumes that you have configured sudo to not prompt for a password.

```

#!/bin/bash

for ip in $(oc get nodes -o jsonpath='{.items[*].status.addresses[?(@.type=="InternalIP")].address}')
do
    echo "reboot node $ip"
    ssh -o StrictHostKeyChecking=no core@$ip sudo shutdown -r -t 3
done

```

10. Confirm that the migration succeeded:

- To confirm that the network plugin is OVN-Kubernetes, enter the following command. The value of **status.networkType** must be **OVNKubernetes**.

```
$ oc get network.config/cluster -o jsonpath='{.status.networkType}'
```

- To confirm that the cluster nodes are in the **Ready** state, enter the following command:

```
$ oc get nodes
```

- To confirm that your pods are not in an error state, enter the following command:

```
$ oc get pods --all-namespaces -o wide --sort-by='{.spec.nodeName}'
```

If pods on a node are in an error state, reboot that node.

- To confirm that all of the cluster Operators are not in an abnormal state, enter the following command:

```
$ oc get co
```

The status of every cluster Operator must be the following: **AVAILABLE="True"**, **PROGRESSING="False"**, **DEGRADED="False"**. If a cluster Operator is not available or degraded, check the logs for the cluster Operator for more information.

11. Complete the following steps only if the migration succeeds and your cluster is in a good state:

- To remove the migration configuration from the CNO configuration object, enter the following command:

```
$ oc patch Network.operator.openshift.io cluster --type='merge' \
--patch '{ "spec": { "migration": null } }'
```

- To remove custom configuration for the OpenShift SDN network provider, enter the following command:

```
$ oc patch Network.operator.openshift.io cluster --type='merge' \
  --patch '{ "spec": { "defaultNetwork": { "openshiftSDNConfig": null } } }'
```

- c. To remove the OpenShift SDN network provider namespace, enter the following command:

```
$ oc delete namespace openshift-sdn
```

28.6.3. Additional resources

- [Red Hat OpenShift Network Calculator](#)
- [Configuration parameters for the OVN-Kubernetes network plugin](#)
- [Backing up etcd](#)
- [About network policy](#)
- [Changing the cluster MTU](#)
- [MTU value selection](#)
- OVN-Kubernetes capabilities
 - [Configuring an egress IP address](#)
 - [Configuring an egress firewall for a project](#)
 - [Enabling multicast for a project](#)
- OpenShift SDN capabilities
 - [Configuring egress IPs for a project](#)
 - [Configuring an egress firewall for a project](#)
 - [Enabling multicast for a project](#)
- [Network \[operator.openshift.io/v1\]](#)

28.7. ROLLING BACK TO THE OPENSIFT SDN NETWORK PROVIDER

As a cluster administrator, you can rollback to the OpenShift SDN network plugin from the OVN-Kubernetes network plugin if the migration to OVN-Kubernetes is unsuccessful.

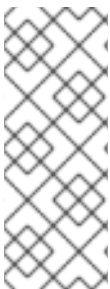

NOTE

OpenShift SDN CNI is deprecated as of OpenShift Container Platform 4.14. As of OpenShift Container Platform 4.15, the network plugin is not an option for new installations. In a subsequent future release, the OpenShift SDN network plugin is planned to be removed and no longer supported. Red Hat will provide bug fixes and support for this feature until it is removed, but this feature will no longer receive enhancements. As an alternative to OpenShift SDN CNI, you can use OVN Kubernetes CNI instead.

28.7.1. Migrating to the OpenShift SDN network plugin

As a cluster administrator, you can migrate to the OpenShift SDN Container Network Interface (CNI) network plugin. During the migration you must reboot every node in your cluster.



IMPORTANT

Rollback to OpenShift SDN if the migration to OVN-Kubernetes fails.

Prerequisites

- Install the OpenShift CLI (**oc**).
- Access to the cluster as a user with the **cluster-admin** role.
- A cluster installed on infrastructure configured with the OVN-Kubernetes network plugin.
- A recent backup of the etcd database is available.
- A reboot can be triggered manually for each node.
- The cluster is in a known good state, without any errors.

Procedure

1. Stop all of the machine configuration pools managed by the Machine Config Operator (MCO):

- Stop the master configuration pool:

```
$ oc patch MachineConfigPool master --type='merge' --patch \
  '{ "spec": { "paused": true } }'
```

- Stop the worker machine configuration pool:

```
$ oc patch MachineConfigPool worker --type='merge' --patch \
  '{ "spec": { "paused": true } }'
```

2. To prepare for the migration, set the migration field to **null** by entering the following command:

```
$ oc patch Network.operator.openshift.io cluster --type='merge' \
  --patch '{ "spec": { "migration": null } }'
```

3. To start the migration, set the network plugin back to OpenShift SDN by entering the following commands:

```
$ oc patch Network.operator.openshift.io cluster --type='merge' \
  --patch '{ "spec": { "migration": { "networkType": "OpenShiftSDN" } } }'
```

```
$ oc patch Network.config.openshift.io cluster --type='merge' \
  --patch '{ "spec": { "networkType": "OpenShiftSDN" } }'
```

4. Optional: You can disable automatic migration of several OVN-Kubernetes capabilities to the OpenShift SDN equivalents:
 - Egress IPs

- Egress firewall
- Multicast

To disable automatic migration of the configuration for any of the previously noted OpenShift SDN features, specify the following keys:

```
$ oc patch Network.operator.openshift.io cluster --type='merge' \
--patch '{
  "spec": {
    "migration": {
      "networkType": "OpenShiftSDN",
      "features": {
        "egressIP": <bool>,
        "egressFirewall": <bool>,
        "multicast": <bool>
      }
    }
  }
}'
```

where:

bool: Specifies whether to enable migration of the feature. The default is **true**.

- Optional: You can customize the following settings for OpenShift SDN to meet your network infrastructure requirements:
 - Maximum transmission unit (MTU)
 - VXLAN port

To customize either or both of the previously noted settings, customize and enter the following command. If you do not need to change the default value, omit the key from the patch.

```
$ oc patch Network.operator.openshift.io cluster --type=merge \
--patch '{
  "spec":{
    "defaultNetwork":{
      "openshiftSDNConfig":{
        "mtu":<mtu>,
        "vxlanPort":<port>
      }
    }
  }
}'
```

mtu

The MTU for the VXLAN overlay network. This value is normally configured automatically, but if the nodes in your cluster do not all use the same MTU, then you must set this explicitly to **50** less than the smallest node MTU value.

port

The UDP port for the VXLAN overlay network. If a value is not specified, the default is **4789**. The port cannot be the same as the Geneve port that is used by OVN-Kubernetes. The default value for the Geneve port is **6081**.

Example patch command

```
$ oc patch Network.operator.openshift.io cluster --type=merge \
  --patch '{
  "spec":{
    "defaultNetwork":{
      "openshiftSDNConfig":{
        "mtu":1200
      }
    }
  }
}'
```

6. Reboot each node in your cluster. You can reboot the nodes in your cluster with either of the following approaches:

- With the **oc rsh** command, you can use a bash script similar to the following:

```
#!/bin/bash
readarray -t POD_NODES <<< "$(oc get pod -n openshift-machine-config-operator -o
wide| grep daemon|awk '{print $1" "$7}')"

for i in "${POD_NODES[@]}"
do
  read -r POD NODE <<< "$i"
  until oc rsh -n openshift-machine-config-operator "$POD" chroot /rootfs shutdown -r +1
  do
    echo "cannot reboot node $NODE, retry" && sleep 3
  done
done
```

- With the **ssh** command, you can use a bash script similar to the following. The script assumes that you have configured sudo to not prompt for a password.

```
#!/bin/bash

for ip in $(oc get nodes -o jsonpath='{.items[*].status.addresses[?
(@.type=="InternalIP")].address}')
do
  echo "reboot node $ip"
  ssh -o StrictHostKeyChecking=no core@$ip sudo shutdown -r -t 3
done
```

7. Wait until the Multus daemon set rollout completes. Run the following command to see your rollout status:

```
$ oc -n openshift-multus rollout status daemonset/multus
```

The name of the Multus pods is in the form of **multus-`<xxxxxx>`** where **`<xxxxxx>`** is a random sequence of letters. It might take several moments for the pods to restart.

Example output

```
Waiting for daemon set "multus" rollout to finish: 1 out of 6 new pods have been updated...
...
Waiting for daemon set "multus" rollout to finish: 5 of 6 updated pods are available...
daemon set "multus" successfully rolled out
```

8. After the nodes in your cluster have rebooted and the multus pods are rolled out, start all of the machine configuration pools by running the following commands::

- Start the master configuration pool:

```
$ oc patch MachineConfigPool master --type='merge' --patch \
  '{ "spec": { "paused": false } }'
```

- Start the worker configuration pool:

```
$ oc patch MachineConfigPool worker --type='merge' --patch \
  '{ "spec": { "paused": false } }'
```

As the MCO updates machines in each config pool, it reboots each node.

By default the MCO updates a single machine per pool at a time, so the time that the migration requires to complete grows with the size of the cluster.

9. Confirm the status of the new machine configuration on the hosts:
 - a. To list the machine configuration state and the name of the applied machine configuration, enter the following command:

```
$ oc describe node | egrep "hostname|machineconfig"
```

Example output

```
kubernetes.io/hostname=master-0
machineconfiguration.openshift.io/currentConfig: rendered-master-
c53e221d9d24e1c8bb6ee89dd3d8ad7b
machineconfiguration.openshift.io/desiredConfig: rendered-master-
c53e221d9d24e1c8bb6ee89dd3d8ad7b
machineconfiguration.openshift.io/reason:
machineconfiguration.openshift.io/state: Done
```

Verify that the following statements are true:

- The value of **machineconfiguration.openshift.io/state** field is **Done**.
 - The value of the **machineconfiguration.openshift.io/currentConfig** field is equal to the value of the **machineconfiguration.openshift.io/desiredConfig** field.
- b. To confirm that the machine config is correct, enter the following command:

```
$ oc get machineconfig <config_name> -o yaml
```

where **<config_name>** is the name of the machine config from the **machineconfiguration.openshift.io/currentConfig** field.

10. Confirm that the migration succeeded:
 - a. To confirm that the network plugin is OpenShift SDN, enter the following command. The value of **status.networkType** must be **OpenShiftSDN**.

```
$ oc get network.config/cluster -o jsonpath='{.status.networkType}'
```

- b. To confirm that the cluster nodes are in the **Ready** state, enter the following command:

```
$ oc get nodes
```

- c. If a node is stuck in the **NotReady** state, investigate the machine config daemon pod logs and resolve any errors.

- i. To list the pods, enter the following command:

```
$ oc get pod -n openshift-machine-config-operator
```

Example output

| NAME | READY | STATUS | RESTARTS | AGE |
|--|-------|---------|----------|-----|
| machine-config-controller-75f756f89d-sjp8b | 1/1 | Running | 0 | 37m |
| machine-config-daemon-5cf4b | 2/2 | Running | 0 | 43h |
| machine-config-daemon-7wzcd | 2/2 | Running | 0 | 43h |
| machine-config-daemon-fc946 | 2/2 | Running | 0 | 43h |
| machine-config-daemon-g2v28 | 2/2 | Running | 0 | 43h |
| machine-config-daemon-gcl4f | 2/2 | Running | 0 | 43h |
| machine-config-daemon-l5tnv | 2/2 | Running | 0 | 43h |
| machine-config-operator-79d9c55d5-hth92 | 1/1 | Running | 0 | 37m |
| machine-config-server-bsc8h | 1/1 | Running | 0 | 43h |
| machine-config-server-hklrm | 1/1 | Running | 0 | 43h |
| machine-config-server-k9rtx | 1/1 | Running | 0 | 43h |

The names for the config daemon pods are in the following format: **machine-config-daemon-`<seq>`**. The `<seq>` value is a random five character alphanumeric sequence.

- ii. To display the pod log for each machine config daemon pod shown in the previous output, enter the following command:

```
$ oc logs <pod> -n openshift-machine-config-operator
```

where **pod** is the name of a machine config daemon pod.

- iii. Resolve any errors in the logs shown by the output from the previous command.

- d. To confirm that your pods are not in an error state, enter the following command:

```
$ oc get pods --all-namespaces -o wide --sort-by='{.spec.nodeName}'
```

If pods on a node are in an error state, reboot that node.

11. Complete the following steps only if the migration succeeds and your cluster is in a good state:

- a. To remove the migration configuration from the Cluster Network Operator configuration object, enter the following command:

```
$ oc patch Network.operator.openshift.io cluster --type='merge' \
  --patch '{ "spec": { "migration": null } }'
```

- b. To remove the OVN-Kubernetes configuration, enter the following command:

```
$ oc patch Network.operator.openshift.io cluster --type='merge' \
  --patch '{ "spec": { "defaultNetwork": { "ovnKubernetesConfig":null } } }
```

- c. To remove the OVN-Kubernetes network provider namespace, enter the following command:

```
$ oc delete namespace openshift-ovn-kubernetes
```

28.8. CONVERTING TO IPV4/IPV6 DUAL-STACK NETWORKING

As a cluster administrator, you can convert your IPv4 single-stack cluster to a dual-network cluster network that supports IPv4 and IPv6 address families. After converting to dual-stack, all newly created pods are dual-stack enabled.



NOTE

- While using dual-stack networking, you cannot use IPv4-mapped IPv6 addresses, such as `::FFFF:198.51.100.1`, where IPv6 is required.
- A dual-stack network is supported on clusters provisioned on bare metal, IBM Power®, IBM Z® infrastructure, single-node OpenShift, and VMware vSphere.

28.8.1. Converting to a dual-stack cluster network

As a cluster administrator, you can convert your single-stack cluster network to a dual-stack cluster network.



NOTE

After converting to dual-stack networking only newly created pods are assigned IPv6 addresses. Any pods created before the conversion must be recreated to receive an IPv6 address.

Prerequisites

- You installed the OpenShift CLI (**oc**).
- You are logged in to the cluster with a user with **cluster-admin** privileges.
- Your cluster uses the OVN-Kubernetes network plugin.
- The cluster nodes have IPv6 addresses.
- You have configured an IPv6-enabled router based on your infrastructure.

Procedure

1. To specify IPv6 address blocks for the cluster and service networks, create a file containing the following YAML:

```
- op: add
  path: /spec/clusterNetwork/-
  value: 1
```

```

cidr: fd01::/48
hostPrefix: 64
- op: add
path: /spec/serviceNetwork/-
value: fd02::/112 2

```

- 1 Specify an object with the **cidr** and **hostPrefix** fields. The host prefix must be **64** or greater. The IPv6 CIDR prefix must be large enough to accommodate the specified host prefix.
- 2 Specify an IPv6 CIDR with a prefix of **112**. Kubernetes uses only the lowest 16 bits. For a prefix of **112**, IP addresses are assigned from **112** to **128** bits.

2. To patch the cluster network configuration, enter the following command:

```

$ oc patch network.config.openshift.io cluster \
--type='json' --patch-file <file>.yaml

```

where:

file

Specifies the name of the file you created in the previous step.

Example output

```

network.config.openshift.io/cluster patched

```

Verification

Complete the following step to verify that the cluster network recognizes the IPv6 address blocks that you specified in the previous procedure.

1. Display the network configuration:

```

$ oc describe network

```

Example output

```

Status:
Cluster Network:
  Cidr:      10.128.0.0/14
  Host Prefix: 23
  Cidr:      fd01::/48
  Host Prefix: 64
Cluster Network MTU: 1400
Network Type:    OVNKubernetes
Service Network:
  172.30.0.0/16
  fd02::/112

```

28.8.2. Converting to a single-stack cluster network

As a cluster administrator, you can convert your dual-stack cluster network to a single-stack cluster network.

Prerequisites

- You installed the OpenShift CLI (**oc**).
- You are logged in to the cluster with a user with **cluster-admin** privileges.
- Your cluster uses the OVN-Kubernetes network plugin.
- The cluster nodes have IPv6 addresses.
- You have enabled dual-stack networking.

Procedure

1. Edit the **networks.config.openshift.io** custom resource (CR) by running the following command:

```
$ oc edit networks.config.openshift.io
```

2. Remove the IPv6 specific configuration that you have added to the **cidr** and **hostPrefix** fields in the previous procedure.

28.9. LOGGING FOR EGRESS FIREWALL AND NETWORK POLICY RULES

As a cluster administrator, you can configure audit logging for your cluster and enable logging for one or more namespaces. OpenShift Container Platform produces audit logs for both egress firewalls and network policies.

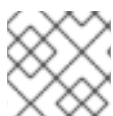

NOTE

Audit logging is available for only the [OVN-Kubernetes network plugin](#).

28.9.1. Audit logging

The OVN-Kubernetes network plugin uses Open Virtual Network (OVN) ACLs to manage egress firewalls and network policies. Audit logging exposes allow and deny ACL events.

You can configure the destination for audit logs, such as a syslog server or a UNIX domain socket. Regardless of any additional configuration, an audit log is always saved to **/var/log/ovn/acl-audit-log.log** on each OVN-Kubernetes pod in the cluster.

Audit logging is enabled per namespace by annotating the namespace with the **k8s.ovn.org/acl-logging** key as in the following example:

Example namespace annotation

```
kind: Namespace
apiVersion: v1
metadata:
  name: example1
```

```

annotations:
  k8s.ovn.org/acl-logging: |-
    {
      "deny": "info",
      "allow": "info"
    }

```

The logging format is compatible with syslog as defined by RFC5424. The syslog facility is configurable and defaults to **local0**. An example log entry might resemble the following:

Example ACL deny log entry for a network policy

```

2023-11-02T16:28:54.139Z|00004|acl_log(ovn_pinctrl0)|INFO|name="NP:verify-audit-logging:Ingress", verdict=drop, severity=alert, direction=to-lport:tcp,vlan_tci=0x0000,dl_src=0a:58:0a:81:02:01,dl_dst=0a:58:0a:81:02:23,nw_src=10.131.0.39,nw_dst=10.129.2.35,nw_tos=0,nw_ecn=0,nw_ttl=62,nw_frag=no,tp_src=58496,tp_dst=8080,tcp_flags=syn
2023-11-02T16:28:55.187Z|00005|acl_log(ovn_pinctrl0)|INFO|name="NP:verify-audit-logging:Ingress", verdict=drop, severity=alert, direction=to-lport:tcp,vlan_tci=0x0000,dl_src=0a:58:0a:81:02:01,dl_dst=0a:58:0a:81:02:23,nw_src=10.131.0.39,nw_dst=10.129.2.35,nw_tos=0,nw_ecn=0,nw_ttl=62,nw_frag=no,tp_src=58496,tp_dst=8080,tcp_flags=syn
2023-11-02T16:28:57.235Z|00006|acl_log(ovn_pinctrl0)|INFO|name="NP:verify-audit-logging:Ingress", verdict=drop, severity=alert, direction=to-lport:tcp,vlan_tci=0x0000,dl_src=0a:58:0a:81:02:01,dl_dst=0a:58:0a:81:02:23,nw_src=10.131.0.39,nw_dst=10.129.2.35,nw_tos=0,nw_ecn=0,nw_ttl=62,nw_frag=no,tp_src=58496,tp_dst=8080,tcp_flags=syn

```

The following table describes namespace annotation values:

Table 28.9. Audit logging namespace annotation

| Annotation | Value |
|--------------------------------|--|
| k8s.ovn.org/acl-logging | <p>You must specify at least one of allow, deny, or both to enable audit logging for a namespace.</p> <p>deny
Optional: Specify alert, warning, notice, info, or debug.</p> <p>allow
Optional: Specify alert, warning, notice, info, or debug.</p> |

28.9.2. Audit configuration

The configuration for audit logging is specified as part of the OVN-Kubernetes cluster network provider configuration. The following YAML illustrates the default values for the audit logging:

Audit logging configuration

```

apiVersion: operator.openshift.io/v1
kind: Network
metadata:
  name: cluster
spec:
  defaultNetwork:
    ovnKubernetesConfig:

```

```

policyAuditConfig:
  destination: "null"
  maxFileSize: 50
  rateLimit: 20
  syslogFacility: local0

```

The following table describes the configuration fields for audit logging.

Table 28.10. policyAuditConfig object

| Field | Type | Description |
|-----------------------|---------|--|
| rateLimit | integer | The maximum number of messages to generate every second per node. The default value is 20 messages per second. |
| maxFileSize | integer | The maximum size for the audit log in bytes. The default value is 50000000 or 50 MB. |
| maxLogFiles | integer | The maximum number of log files that are retained. |
| destination | string | One of the following additional audit log targets:
libc
The libc syslog() function of the journald process on the host.
udp:<host>:<port>
A syslog server. Replace <host>:<port> with the host and port of the syslog server.
unix:<file>
A Unix Domain Socket file specified by <file> .
null
Do not send the audit logs to any additional target. |
| syslogFacility | string | The syslog facility, such as kern , as defined by RFC5424. The default value is local0 . |

28.9.3. Configuring egress firewall and network policy auditing for a cluster

As a cluster administrator, you can customize audit logging for your cluster.

Prerequisites

- Install the OpenShift CLI (**oc**).
- Log in to the cluster with a user with **cluster-admin** privileges.

Procedure

- To customize the audit logging configuration, enter the following command:

```
$ oc edit network.operator.openshift.io/cluster
```

TIP

You can alternatively customize and apply the following YAML to configure audit logging:

```

apiVersion: operator.openshift.io/v1
kind: Network
metadata:
  name: cluster
spec:
  defaultNetwork:
    ovnKubernetesConfig:
      policyAuditConfig:
        destination: "null"
        maxFileSize: 50
        rateLimit: 20
        syslogFacility: local0

```

Verification

1. To create a namespace with network policies complete the following steps:
 - a. Create a namespace for verification:

```

$ cat <<EOF | oc create -f -
kind: Namespace
apiVersion: v1
metadata:
  name: verify-audit-logging
annotations:
  k8s.ovn.org/acl-logging: '{ "deny": "alert", "allow": "alert" }'
EOF

```

Example output

```

namespace/verify-audit-logging created

```

- b. Create network policies for the namespace:

```

$ cat <<EOF | oc create -n verify-audit-logging -f -
apiVersion: networking.k8s.io/v1
kind: NetworkPolicy
metadata:
  name: deny-all
spec:
  podSelector:
    matchLabels:
  policyTypes:
  - Ingress
  - Egress
---
apiVersion: networking.k8s.io/v1
kind: NetworkPolicy
metadata:
  name: allow-from-same-namespace

```

```

namespace: verify-audit-logging
spec:
  podSelector: {}
  policyTypes:
  - Ingress
  - Egress
  ingress:
  - from:
    - podSelector: {}
  egress:
  - to:
    - namespaceSelector:
        matchLabels:
          kubernetes.io/metadata.name: verify-audit-logging
EOF

```

Example output

```

networkpolicy.networking.k8s.io/deny-all created
networkpolicy.networking.k8s.io/allow-from-same-namespace created

```

2. Create a pod for source traffic in the **default** namespace:

```

$ cat <<EOF | oc create -n default -f -
apiVersion: v1
kind: Pod
metadata:
  name: client
spec:
  containers:
  - name: client
    image: registry.access.redhat.com/rhel7/rhel-tools
    command: ["/bin/sh", "-c"]
    args:
      ["sleep inf"]
EOF

```

3. Create two pods in the **verify-audit-logging** namespace:

```

$ for name in client server; do
cat <<EOF | oc create -n verify-audit-logging -f -
apiVersion: v1
kind: Pod
metadata:
  name: ${name}
spec:
  containers:
  - name: ${name}
    image: registry.access.redhat.com/rhel7/rhel-tools
    command: ["/bin/sh", "-c"]
    args:
      ["sleep inf"]
EOF
done

```

Example output

```
pod/client created
pod/server created
```

4. To generate traffic and produce network policy audit log entries, complete the following steps:

- a. Obtain the IP address for pod named **server** in the **verify-audit-logging** namespace:

```
$ POD_IP=$(oc get pods server -n verify-audit-logging -o jsonpath='{.status.podIP}')
```

- b. Ping the IP address from the previous command from the pod named **client** in the **default** namespace and confirm that all packets are dropped:

```
$ oc exec -it client -n default -- /bin/ping -c 2 $POD_IP
```

Example output

```
PING 10.128.2.55 (10.128.2.55) 56(84) bytes of data.

--- 10.128.2.55 ping statistics ---
2 packets transmitted, 0 received, 100% packet loss, time 2041ms
```

- c. Ping the IP address saved in the **POD_IP** shell environment variable from the pod named **client** in the **verify-audit-logging** namespace and confirm that all packets are allowed:

```
$ oc exec -it client -n verify-audit-logging -- /bin/ping -c 2 $POD_IP
```

Example output

```
PING 10.128.0.86 (10.128.0.86) 56(84) bytes of data.
64 bytes from 10.128.0.86: icmp_seq=1 ttl=64 time=2.21 ms
64 bytes from 10.128.0.86: icmp_seq=2 ttl=64 time=0.440 ms

--- 10.128.0.86 ping statistics ---
2 packets transmitted, 2 received, 0% packet loss, time 1001ms
rtt min/avg/max/mdev = 0.440/1.329/2.219/0.890 ms
```

5. Display the latest entries in the network policy audit log:

```
$ for pod in $(oc get pods -n openshift-ovn-kubernetes -l app=ovnkube-node --no-headers=true | awk '{ print $1 }') ; do
  oc exec -it $pod -n openshift-ovn-kubernetes -- tail -4 /var/log/ovn/acl-audit-log.log
done
```

Example output

```
2023-11-02T16:28:54.139Z|00004|acl_log(ovn_pinctrl0)|INFO|name="NP:verify-audit-logging:Ingress", verdict=drop, severity=alert, direction=to-lport:tcp,vlan_tci=0x0000,dl_src=0a:58:0a:81:02:01,dl_dst=0a:58:0a:81:02:23,nw_src=10.131.0.39,nw_dst=10.129.2.35,nw_tos=0,nw_ecn=0,nw_ttl=62,nw_frag=no,tp_src=58496,tp_dst=8080,tcp_flags=syn
```



```

2023-11-02T16:28:55.187Z|00005|acl_log(ovn_pinctrl0)|INFO|name="NP:verify-audit-logging:Ingress", verdict=drop, severity=alert, direction=to-lport:
tcp,vlan_tci=0x0000,dl_src=0a:58:0a:81:02:01,dl_dst=0a:58:0a:81:02:23,nw_src=10.131.0.39,nw_dst=10.129.2.35,nw_tos=0,nw_ecn=0,nw_ttl=62,nw_frag=no,tp_src=58496,tp_dst=8080,tcp_flags=syn
2023-11-02T16:28:57.235Z|00006|acl_log(ovn_pinctrl0)|INFO|name="NP:verify-audit-logging:Ingress", verdict=drop, severity=alert, direction=to-lport:
tcp,vlan_tci=0x0000,dl_src=0a:58:0a:81:02:01,dl_dst=0a:58:0a:81:02:23,nw_src=10.131.0.39,nw_dst=10.129.2.35,nw_tos=0,nw_ecn=0,nw_ttl=62,nw_frag=no,tp_src=58496,tp_dst=8080,tcp_flags=syn
2023-11-02T16:49:57.909Z|00028|acl_log(ovn_pinctrl0)|INFO|name="NP:verify-audit-logging:allow-from-same-namespace:Egress:0", verdict=allow, severity=alert, direction=from-lport:
icmp,vlan_tci=0x0000,dl_src=0a:58:0a:81:02:22,dl_dst=0a:58:0a:81:02:23,nw_src=10.129.2.34,nw_dst=10.129.2.35,nw_tos=0,nw_ecn=0,nw_ttl=64,nw_frag=no,icmp_type=8,icmp_code=0
2023-11-02T16:49:57.909Z|00029|acl_log(ovn_pinctrl0)|INFO|name="NP:verify-audit-logging:allow-from-same-namespace:Ingress:0", verdict=allow, severity=alert, direction=to-lport:
icmp,vlan_tci=0x0000,dl_src=0a:58:0a:81:02:22,dl_dst=0a:58:0a:81:02:23,nw_src=10.129.2.34,nw_dst=10.129.2.35,nw_tos=0,nw_ecn=0,nw_ttl=64,nw_frag=no,icmp_type=8,icmp_code=0
2023-11-02T16:49:58.932Z|00030|acl_log(ovn_pinctrl0)|INFO|name="NP:verify-audit-logging:allow-from-same-namespace:Egress:0", verdict=allow, severity=alert, direction=from-lport:
icmp,vlan_tci=0x0000,dl_src=0a:58:0a:81:02:22,dl_dst=0a:58:0a:81:02:23,nw_src=10.129.2.34,nw_dst=10.129.2.35,nw_tos=0,nw_ecn=0,nw_ttl=64,nw_frag=no,icmp_type=8,icmp_code=0
2023-11-02T16:49:58.932Z|00031|acl_log(ovn_pinctrl0)|INFO|name="NP:verify-audit-logging:allow-from-same-namespace:Ingress:0", verdict=allow, severity=alert, direction=to-lport:
icmp,vlan_tci=0x0000,dl_src=0a:58:0a:81:02:22,dl_dst=0a:58:0a:81:02:23,nw_src=10.129.2.34,nw_dst=10.129.2.35,nw_tos=0,nw_ecn=0,nw_ttl=64,nw_frag=no,icmp_type=8,icmp_code=0

```

28.9.4. Enabling egress firewall and network policy audit logging for a namespace

As a cluster administrator, you can enable audit logging for a namespace.

Prerequisites

- Install the OpenShift CLI (**oc**).
- Log in to the cluster with a user with **cluster-admin** privileges.

Procedure

- To enable audit logging for a namespace, enter the following command:

```
$ oc annotate namespace <namespace> \
k8s.ovn.org/acl-logging='{ "deny": "alert", "allow": "notice" }'
```

where:

<namespace>

Specifies the name of the namespace.

TIP

You can alternatively apply the following YAML to enable audit logging:

```
kind: Namespace
apiVersion: v1
metadata:
  name: <namespace>
  annotations:
    k8s.ovn.org/acl-logging: |-
      {
        "deny": "alert",
        "allow": "notice"
      }
```

Example output

```
namespace/verify-audit-logging annotated
```

Verification

- Display the latest entries in the audit log:

```
$ for pod in $(oc get pods -n openshift-ovn-kubernetes -l app=ovnkube-node --no-headers=true | awk '{ print $1 }') ; do
  oc exec -it $pod -n openshift-ovn-kubernetes -- tail -4 /var/log/ovn/acl-audit-log.log
done
```

Example output

```
2023-11-02T16:49:57.909Z|00028|acl_log(ovn_pinctrl0)|INFO|name="NP:verify-audit-logging:allow-from-same-namespace:Egress:0", verdict=allow, severity=alert, direction=from-
lport:
icmp,vlan_tci=0x0000,dl_src=0a:58:0a:81:02:22,dl_dst=0a:58:0a:81:02:23,nw_src=10.129.2.34,
nw_dst=10.129.2.35,nw_tos=0,nw_ecn=0,nw_ttl=64,nw_frag=no,icmp_type=8,icmp_code=0
2023-11-02T16:49:57.909Z|00029|acl_log(ovn_pinctrl0)|INFO|name="NP:verify-audit-logging:allow-from-same-namespace:Ingress:0", verdict=allow, severity=alert, direction=to-
lport:
icmp,vlan_tci=0x0000,dl_src=0a:58:0a:81:02:22,dl_dst=0a:58:0a:81:02:23,nw_src=10.129.2.34,
nw_dst=10.129.2.35,nw_tos=0,nw_ecn=0,nw_ttl=64,nw_frag=no,icmp_type=8,icmp_code=0
2023-11-02T16:49:58.932Z|00030|acl_log(ovn_pinctrl0)|INFO|name="NP:verify-audit-logging:allow-from-same-namespace:Egress:0", verdict=allow, severity=alert, direction=from-
lport:
icmp,vlan_tci=0x0000,dl_src=0a:58:0a:81:02:22,dl_dst=0a:58:0a:81:02:23,nw_src=10.129.2.34,
nw_dst=10.129.2.35,nw_tos=0,nw_ecn=0,nw_ttl=64,nw_frag=no,icmp_type=8,icmp_code=0
2023-11-02T16:49:58.932Z|00031|acl_log(ovn_pinctrl0)|INFO|name="NP:verify-audit-logging:allow-from-same-namespace:Ingress:0", verdict=allow, severity=alert, direction=to-
lport:
icmp,vlan_tci=0x0000,dl_src=0a:58:0a:81:02:22,dl_dst=0a:58:0a:81:02:23,nw_src=10.129.2.34,
nw_dst=10.129.2.35,nw_tos=0,nw_ecn=0,nw_ttl=64,nw_frag=no,icmp_type=8,icmp_code=0
```

28.9.5. Disabling egress firewall and network policy audit logging for a namespace

As a cluster administrator, you can disable audit logging for a namespace.

Prerequisites

- Install the OpenShift CLI (**oc**).
- Log in to the cluster with a user with **cluster-admin** privileges.

Procedure

- To disable audit logging for a namespace, enter the following command:

```
$ oc annotate --overwrite namespace <namespace> k8s.ovn.org/acl-logging-
```

where:

<namespace>

Specifies the name of the namespace.

TIP

You can alternatively apply the following YAML to disable audit logging:

```
kind: Namespace
apiVersion: v1
metadata:
  name: <namespace>
  annotations:
    k8s.ovn.org/acl-logging: null
```

Example output

```
namespace/verify-audit-logging annotated
```

28.9.6. Additional resources

- [About network policy](#)
- [Configuring an egress firewall for a project](#)

28.10. CONFIGURING IPSEC ENCRYPTION

With IPsec enabled, you can encrypt both internal pod-to-pod cluster traffic between nodes and external traffic between pods and IPsec endpoints external to your cluster. All pod-to-pod network traffic between nodes on the OVN-Kubernetes cluster network is encrypted with IPsec in *Transport mode*.

IPsec is disabled by default. It can be enabled either during or after installing the cluster. For information about cluster installation, see [OpenShift Container Platform installation overview](#).

**IMPORTANT**

If your cluster uses [hosted control planes](#) for Red Hat OpenShift Container Platform, IPsec is not supported for IPsec encryption of either pod-to-pod or traffic to external hosts.

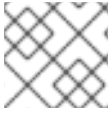
**NOTE**

IPsec on IBM Cloud® supports only NAT-T. Using ESP is not supported.

Use the procedures in the following documentation to:

- Enable and disable IPsec after cluster installation
- Configure IPsec encryption for traffic between the cluster and external hosts
- Verify that IPsec encrypts traffic between pods on different nodes

28.10.1. Modes of operation

When using IPsec on your OpenShift Container Platform cluster, you can choose from the following operating modes:

Table 28.11. IPsec modes of operation

| Mode | Description | Default |
|-----------------|---|---------|
| Disabled | No traffic is encrypted. This is the cluster default. | Yes |
| Full | Pod-to-pod traffic is encrypted as described in "Types of network traffic flows encrypted by pod-to-pod IPsec". Traffic to external nodes may be encrypted after you complete the required configuration steps for IPsec. | No |
| External | Traffic to external nodes may be encrypted after you complete the required configuration steps for IPsec. | No |

28.10.2. Prerequisites

For IPsec support for encrypting traffic to external hosts, ensure that the following prerequisites are met:

- The OVN-Kubernetes network plugin must be configured in local gateway mode, where **ovnKubernetesConfig.gatewayConfig.routingViaHost=true**.
- The NMState Operator is installed. This Operator is required for specifying the IPsec configuration. For more information, see [About the Kubernetes NMState Operator](#).

**NOTE**

The NMState Operator is supported on Google Cloud Platform (GCP) only for configuring IPsec.

- The Butane tool (**butane**) is installed. To install Butane, see [Installing Butane](#).

These prerequisites are required to add certificates into the host NSS database and to configure IPsec to communicate with external hosts.

28.10.3. Network connectivity requirements when IPsec is enabled

You must configure the network connectivity between machines to allow OpenShift Container Platform cluster components to communicate. Each machine must be able to resolve the hostnames of all other machines in the cluster.

Table 28.12. Ports used for all-machine to all-machine communications

| Protocol | Port | Description |
|----------|-------------|--|
| UDP | 500 | IPsec IKE packets |
| | 4500 | IPsec NAT-T packets |
| ESP | N/A | IPsec Encapsulating Security Payload (ESP) |

28.10.4. IPsec encryption for pod-to-pod traffic

For IPsec encryption of pod-to-pod traffic, the following sections describe which specific pod-to-pod traffic is encrypted, what kind of encryption protocol is used, and how X.509 certificates are handled. These sections do not apply to IPsec encryption between the cluster and external hosts, which you must configure manually for your specific external network infrastructure.

28.10.4.1. Types of network traffic flows encrypted by pod-to-pod IPsec

With IPsec enabled, only the following network traffic flows between pods are encrypted:

- Traffic between pods on different nodes on the cluster network
- Traffic from a pod on the host network to a pod on the cluster network

The following traffic flows are not encrypted:

- Traffic between pods on the same node on the cluster network
- Traffic between pods on the host network
- Traffic from a pod on the cluster network to a pod on the host network

The encrypted and unencrypted flows are illustrated in the following diagram:

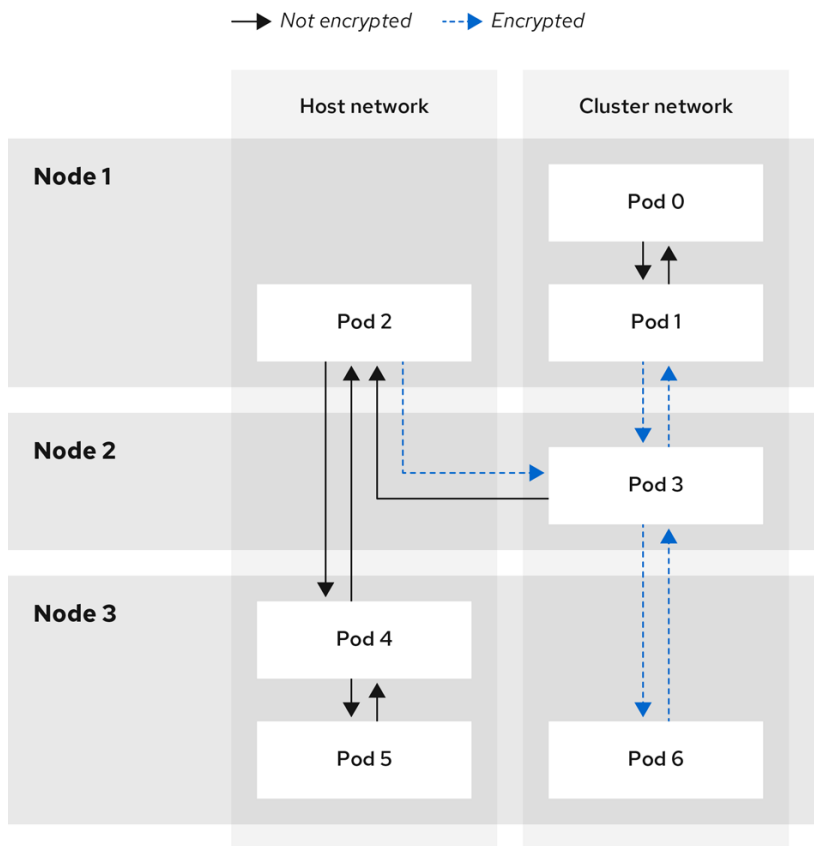

138_OpenShift_0421

28.10.4.2. Encryption protocol and IPsec mode

The encrypt cipher used is **AES-GCM-16-256**. The integrity check value (ICV) is **16** bytes. The key length is **256** bits.

The IPsec mode used is *Transport mode*, a mode that encrypts end-to-end communication by adding an Encapsulated Security Payload (ESP) header to the IP header of the original packet and encrypts the packet data. OpenShift Container Platform does not currently use or support IPsec *Tunnel mode* for pod-to-pod communication.

28.10.4.3. Security certificate generation and rotation

The Cluster Network Operator (CNO) generates a self-signed X.509 certificate authority (CA) that is used by IPsec for encryption. Certificate signing requests (CSRs) from each node are automatically fulfilled by the CNO.

The CA is valid for 10 years. The individual node certificates are valid for 5 years and are automatically rotated after 4 1/2 years elapse.

28.10.5. IPsec encryption for external traffic

OpenShift Container Platform supports IPsec encryption for traffic to external hosts with TLS certificates that you must supply.

28.10.5.1. Supported platforms

This feature is supported on the following platforms:

- Bare metal

- Google Cloud Platform (GCP)
- Red Hat OpenStack Platform (RHOSP)
- VMware vSphere



IMPORTANT

If you have Red Hat Enterprise Linux (RHEL) worker nodes, these do not support IPsec encryption for external traffic.

If your cluster uses hosted control planes for Red Hat OpenShift Container Platform, configuring IPsec for encrypting traffic to external hosts is not supported.

28.10.5.2. Limitations

Ensure that the following prohibitions are observed:

- IPv6 configuration is not currently supported by the NMState Operator when configuring IPsec for external traffic.
- Certificate common names (CN) in the provided certificate bundle must not begin with the **ovs_** prefix, because this naming can conflict with pod-to-pod IPsec CN names in the Network Security Services (NSS) database of each node.

28.10.6. Enabling IPsec encryption

As a cluster administrator, you can enable pod-to-pod IPsec encryption and IPsec encryption between the cluster and external IPsec endpoints.

You can configure IPsec in either of the following modes:

- **Full:** Encryption for pod-to-pod and external traffic
- **External:** Encryption for external traffic

If you need to configure encryption for external traffic in addition to pod-to-pod traffic, you must also complete the "Configuring IPsec encryption for external traffic" procedure.

Prerequisites

- Install the OpenShift CLI (**oc**).
- You are logged in to the cluster as a user with **cluster-admin** privileges.
- You have reduced the size of your cluster MTU by **46** bytes to allow for the overhead of the IPsec ESP header.

Procedure

1. To enable IPsec encryption, enter the following command:

```
$ oc patch networks.operator.openshift.io cluster --type=merge \
-p '{
  "spec":{
```

```
"defaultNetwork":{
  "ovnKubernetesConfig":{
    "ipsecConfig":{
      "mode":<mode>
    }
  }
}
```

where:

mode

Specify **External** to encrypt only traffic to external hosts or specify **Full** to encrypt pod to pod traffic and optionally traffic to external hosts. By default, IPsec is disabled.

- Optional: If you need to encrypt traffic to external hosts, complete the "Configuring IPsec encryption for external traffic" procedure.

Verification

- To find the names of the OVN-Kubernetes data plane pods, enter the following command:

```
$ oc get pods -n openshift-ovn-kubernetes -l=app=ovnkube-node
```

Example output

```
ovnkube-node-5xqbf          8/8   Running 0           28m
ovnkube-node-6mwcx          8/8   Running 0           29m
ovnkube-node-ck5fr          8/8   Running 0           31m
ovnkube-node-fr4ld          8/8   Running 0           26m
ovnkube-node-wgs4l          8/8   Running 0           33m
ovnkube-node-zfvcl          8/8   Running 0           34m
```

- Verify that IPsec is enabled on your cluster by running the following command:



NOTE

As a cluster administrator, you can verify that IPsec is enabled between pods on your cluster when IPsec is configured in **Full** mode. This step does not verify whether IPsec is working between your cluster and external hosts.

```
$ oc -n openshift-ovn-kubernetes rsh ovnkube-node-<XXXXX> ovn-nbctl --no-leader-only get nb_global . ipsec
```

where:

<XXXXX>

Specifies the random sequence of letters for a pod from the previous step.

Example output

```
true
```

28.10.7. Configuring IPsec encryption for external traffic

As a cluster administrator, to encrypt external traffic with IPsec you must configure IPsec for your network infrastructure, including providing PKCS#12 certificates. Because this procedure uses Butane to create machine configs, you must have the **butane** command installed.

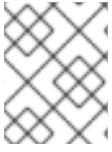

NOTE

After you apply the machine config, the Machine Config Operator reboots affected nodes in your cluster to rollout the new machine config.

Prerequisites

- Install the OpenShift CLI (**oc**).
- You have installed the **butane** utility on your local computer.
- You have installed the NMState Operator on the cluster.
- You are logged in to the cluster as a user with **cluster-admin** privileges.
- You have an existing PKCS#12 certificate for the IPsec endpoint and a CA cert in PEM format.
- You enabled IPsec in either **Full** or **External** mode on your cluster.
- The OVN-Kubernetes network plugin must be configured in local gateway mode, where **ovnKubernetesConfig.gatewayConfig.routingViaHost=true**.

Procedure

1. Create an IPsec configuration with an NMState Operator node network configuration policy. For more information, see [Libreswan as an IPsec VPN implementation](#) .
 - a. To identify the IP address of the cluster node that is the IPsec endpoint, enter the following command:

```
$ oc get nodes
```

- b. Create a file named **ipsec-config.yaml** that contains a node network configuration policy for the NMState Operator, such as in the following examples. For an overview about **NodeNetworkConfigurationPolicy** objects, see [The Kubernetes NMState project](#) .

Example NMState IPsec transport configuration

```
apiVersion: nmstate.io/v1
kind: NodeNetworkConfigurationPolicy
metadata:
  name: ipsec-config
spec:
  nodeSelector:
    kubernetes.io/hostname: "<hostname>" 1
  desiredState:
    interfaces:
      - name: <interface_name> 2
        type: ipsec
        libreswan:
          left: <cluster_node> 3
```

```

leftid: '%fromcert'
lefttrsasigkey: '%cert'
leftcert: left_server
leftmodecfgclient: false
right: <external_host> 4
rightid: '%fromcert'
righttrsasigkey: '%cert'
rightsubnet: <external_address>/32 5
ikev2: insist
type: transport

```

- 1 Specifies the host name to apply the policy to. This host serves as the left side host in the IPsec configuration.
- 2 Specifies the name of the interface to create on the host.
- 3 Specifies the host name of the cluster node that terminates the IPsec tunnel on the cluster side. The name should match SAN [**Subject Alternate Name**] from your supplied PKCS#12 certificates.
- 4 Specifies the external host name, such as **host.example.com**. The name should match the SAN [**Subject Alternate Name**] from your supplied PKCS#12 certificates.
- 5 Specifies the IP address of the external host, such as **10.1.2.3/32**.

Example NMState IPsec tunnel configuration

```

apiVersion: nmstate.io/v1
kind: NodeNetworkConfigurationPolicy
metadata:
  name: ipsec-config
spec:
  nodeSelector:
    kubernetes.io/hostname: "<hostname>" 1
  desiredState:
    interfaces:
      - name: <interface_name> 2
        type: ipsec
        libreswan:
          left: <cluster_node> 3
          leftid: '%fromcert'
          leftmodecfgclient: false
          lefttrsasigkey: '%cert'
          leftcert: left_server
          right: <external_host> 4
          rightid: '%fromcert'
          righttrsasigkey: '%cert'
          rightsubnet: <external_address>/32 5
          ikev2: insist
          type: tunnel

```

- 1 Specifies the host name to apply the policy to. This host serves as the left side host in the IPsec configuration.

- 2 Specifies the name of the interface to create on the host.
- 3 Specifies the host name of the cluster node that terminates the IPsec tunnel on the cluster side. The name should match SAN [**Subject Alternate Name**] from your supplied PKCS#12 certificates.
- 4 Specifies the external host name, such as **host.example.com**. The name should match the SAN [**Subject Alternate Name**] from your supplied PKCS#12 certificates.
- 5 Specifies the IP address of the external host, such as **10.1.2.3/32**.

c. To configure the IPsec interface, enter the following command:

```
$ oc create -f ipsec-config.yaml
```

2. Provide the following certificate files to add to the Network Security Services (NSS) database on each host. These files are imported as part of the Butane configuration in subsequent steps.

- **left_server.p12**: The certificate bundle for the IPsec endpoints
- **ca.pem**: The certificate authority that you signed your certificates with

3. Create a machine config to add your certificates to the cluster:

a. To create Butane config files for the control plane and worker nodes, enter the following command:

```
$ for role in master worker; do
cat >> "99-ipsec-{$role}-endpoint-config.bu" <<-EOF
variant: openshift
version: 4.15.0
metadata:
  name: 99-{$role}-import-certs
  labels:
    machineconfiguration.openshift.io/role: $role
systemd:
  units:
    - name: ipsec-import.service
      enabled: true
      contents: |
        [Unit]
        Description=Import external certs into ipsec NSS
        Before=ipsec.service

        [Service]
        Type=oneshot
        ExecStart=/usr/local/bin/ipsec-addcert.sh
        RemainAfterExit=false
        StandardOutput=journal

        [Install]
        WantedBy=multi-user.target
storage:
  files:
    - path: /etc/pki/certs/ca.pem
```

```

mode: 0400
overwrite: true
contents:
  local: ca.pem
- path: /etc/pki/certs/left_server.p12
mode: 0400
overwrite: true
contents:
  local: left_server.p12
- path: /usr/local/bin/ipsec-addcert.sh
mode: 0740
overwrite: true
contents:
  inline: |
    #!/bin/bash -e
    echo "importing cert to NSS"
    certutil -A -n "CA" -t "CT,C,C" -d /var/lib/ipsec/nss/ -i /etc/pki/certs/ca.pem
    pk12util -W "" -i /etc/pki/certs/left_server.p12 -d /var/lib/ipsec/nss/
    certutil -M -n "left_server" -t "u,u,u" -d /var/lib/ipsec/nss/
EOF
done

```

- b. To transform the Butane files that you created in the previous step into machine configs, enter the following command:

```

$ for role in master worker; do
  butane 99-ipsec-${role}-endpoint-config.bu -o ./99-ipsec-${role}-endpoint-config.yaml
done

```

4. To apply the machine configs to your cluster, enter the following command:

```

$ for role in master worker; do
  oc apply -f 99-ipsec-${role}-endpoint-config.yaml
done

```

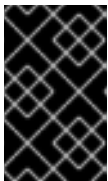

IMPORTANT

As the Machine Config Operator (MCO) updates machines in each machine config pool, it reboots each node one by one. You must wait until all the nodes are updated before external IPsec connectivity is available.

5. Check the machine config pool status by entering the following command:

```

$ oc get mcp

```

A successfully updated node has the following status: **UPDATED=true**, **UPDATING=false**, **DEGRADED=false**.



NOTE

By default, the MCO updates one machine per pool at a time, causing the total time the migration takes to increase with the size of the cluster.

6. To confirm that IPsec machine configs rolled out successfully, enter the following commands:

- a. Confirm that the IPsec machine configs were created:

```
$ oc get mc | grep ipsec
```

Example output

```
80-ipsec-master-extensions    3.2.0    6d15h
80-ipsec-worker-extensions    3.2.0    6d15h
```

- b. Confirm that the that the IPsec extension are applied to control plane nodes:

```
$ oc get mcp master -o yaml | grep 80-ipsec-master-extensions -c
```

Expected output

```
2
```

- c. Confirm that the that the IPsec extension are applied to worker nodes:

```
$ oc get mcp worker -o yaml | grep 80-ipsec-worker-extensions -c
```

Expected output

```
2
```

Additional resources

- For more information about the nmstate IPsec API, see [IPsec Encryption](#)

28.10.8. Disabling IPsec encryption for an external IPsec endpoint

As a cluster administrator, you can remove an existing IPsec tunnel to an external host.

Prerequisites

- Install the OpenShift CLI (**oc**).
- You are logged in to the cluster as a user with **cluster-admin** privileges.
- You enabled IPsec in either **Full** or **External** mode on your cluster.

Procedure

1. Create a file named **remove-ipsec-tunnel.yaml** with the following YAML:

```
kind: NodeNetworkConfigurationPolicy
apiVersion: nmstate.io/v1
metadata:
  name: <name>
spec:
```

```
nodeSelector:
  kubernetes.io/hostname: <node_name>
desiredState:
  interfaces:
  - name: <tunnel_name>
    type: ipsec
    state: absent
```

where:

name

Specifies a name for the node network configuration policy.

node_name

Specifies the name of the node where the IPsec tunnel that you want to remove exists.

tunnel_name

Specifies the interface name for the existing IPsec tunnel.

2. To remove the IPsec tunnel, enter the following command:

```
$ oc apply -f remove-ipsec-tunnel.yaml
```

28.10.9. Disabling IPsec encryption

As a cluster administrator, you can disable IPsec encryption.

Prerequisites

- Install the OpenShift CLI (**oc**).
- Log in to the cluster with a user with **cluster-admin** privileges.

Procedure

1. To disable IPsec encryption, enter the following command:

```
$ oc patch networks.operator.openshift.io cluster --type=merge \
-p '{
  "spec":{
    "defaultNetwork":{
      "ovnKubernetesConfig":{
        "ipsecConfig":{
          "mode":"Disabled"
        }
      }
    }
  }
}'
```

2. Optional: You can increase the size of your cluster MTU by **46** bytes because there is no longer any overhead from the IPsec ESP header in IP packets.

28.10.10. Additional resources

- [Configuring a VPN with IPsec](#) in Red Hat Enterprise Linux (RHEL) 9
- [Installing Butane](#)

- [About the OVN-Kubernetes Container Network Interface \(CNI\) network plugin](#)
- [Changing the MTU for the cluster network](#)
- [Network \[operator.openshift.io/v1\] API](#)

28.11. CONFIGURE AN EXTERNAL GATEWAY ON THE DEFAULT NETWORK

As a cluster administrator, you can configure an external gateway on the default network.

This feature offers the following benefits:

- Granular control over egress traffic on a per-namespace basis
- Flexible configuration of static and dynamic external gateway IP addresses
- Support for both IPv4 and IPv6 address families

28.11.1. Prerequisites

- Your cluster uses the OVN-Kubernetes network plugin.
- Your infrastructure is configured to route traffic from the secondary external gateway.

28.11.2. How OpenShift Container Platform determines the external gateway IP address

You configure a secondary external gateway with the **AdminPolicyBasedExternalRoute** custom resource (CR) from the **k8s.ovn.org** API group. The CR supports static and dynamic approaches to specifying an external gateway's IP address.

Each namespace that a **AdminPolicyBasedExternalRoute** CR targets cannot be selected by any other **AdminPolicyBasedExternalRoute** CR. A namespace cannot have concurrent secondary external gateways.

Changes to policies are isolated in the controller. If a policy fails to apply, changes to other policies do not trigger a retry of other policies. Policies are only re-evaluated, applying any differences that might have occurred by the change, when updates to the policy itself or related objects to the policy such as target namespaces, pod gateways, or namespaces hosting them from dynamic hops are made.

Static assignment

You specify an IP address directly.

Dynamic assignment

You specify an IP address indirectly, with namespace and pod selectors, and an optional network attachment definition.

- If the name of a network attachment definition is provided, the external gateway IP address of the network attachment is used.
- If the name of a network attachment definition is not provided, the external gateway IP address for the pod itself is used. However, this approach works only if the pod is configured with **hostNetwork** set to **true**.

28.11.3. AdminPolicyBasedExternalRoute object configuration

You can define an **AdminPolicyBasedExternalRoute** object, which is cluster scoped, with the following properties. A namespace can be selected by only one **AdminPolicyBasedExternalRoute** CR at a time.

Table 28.13. AdminPolicyBasedExternalRoute object

| Field | Type | Description |
|----------------------|---------------|--|
| metadata.name | string | Specifies the name of the AdminPolicyBasedExternalRoute object. |
| spec.from | string | <p>Specifies a namespace selector that the routing policies apply to. Only namespaceSelector is supported for external traffic. For example:</p> <pre>from: namespaceSelector: matchLabels: kubernetes.io/metadata.name: novxlan-externalgw-ecmp-4059</pre> <p>A namespace can only be targeted by one AdminPolicyBasedExternalRoute CR. If a namespace is selected by more than one AdminPolicyBasedExternalRoute CR, a failed error status occurs on the second and subsequent CRs that target the same namespace. To apply updates, you must change the policy itself or related objects to the policy such as target namespaces, pod gateways, or namespaces hosting them from dynamic hops in order for the policy to be re-evaluated and your changes to be applied.</p> |
| spec.nextHops | object | Specifies the destinations where the packets are forwarded to. Must be either or both of static and dynamic . You must have at least one next hop defined. |

Table 28.14. nextHops object

| Field | Type | Description |
|----------------|--------------|--|
| static | array | Specifies an array of static IP addresses. |
| dynamic | array | Specifies an array of pod selectors corresponding to pods configured with a network attachment definition to use as the external gateway target. |

Table 28.15. nextHops.static object

| Field | Type | Description |
|-------------------|----------------|--|
| ip | string | Specifies either an IPv4 or IPv6 address of the next destination hop. |
| bfdEnabled | boolean | Optional: Specifies whether Bi-Directional Forwarding Detection (BFD) is supported by the network. The default value is false . |

Table 28.16. `nextHops.dynamic` object

| Field | Type | Description |
|------------------------------|----------------|---|
| podSelector | string | Specifies a [set-based] (https://kubernetes.io/docs/concepts/overview/working-with-objects/labels/#set-based-requirement) label selector to filter the pods in the namespace that match this network configuration. |
| namespaceSelector | string | Specifies a set-based selector to filter the namespaces that the podSelector applies to. You must specify a value for this field. |
| bfdEnabled | boolean | Optional: Specifies whether Bi-Directional Forwarding Detection (BFD) is supported by the network. The default value is false . |
| networkAttachmentName | string | Optional: Specifies the name of a network attachment definition. The name must match the list of logical networks associated with the pod. If this field is not specified, the host network of the pod is used. However, the pod must be configured as a host network pod to use the host network. |

28.11.3.1. Example secondary external gateway configurations

In the following example, the **AdminPolicyBasedExternalRoute** object configures two static IP addresses as external gateways for pods in namespaces with the **kubernetes.io/metadata.name: novxlan-externalgw-ecmp-4059** label.

```

apiVersion: k8s.ovn.org/v1
kind: AdminPolicyBasedExternalRoute
metadata:
  name: default-route-policy
spec:
  from:
    namespaceSelector:
      matchLabels:
        kubernetes.io/metadata.name: novxlan-externalgw-ecmp-4059
  nextHops:

```

```

static:
- ip: "172.18.0.8"
- ip: "172.18.0.9"

```

In the following example, the **AdminPolicyBasedExternalRoute** object configures a dynamic external gateway. The IP addresses used for the external gateway are derived from the additional network attachments associated with each of the selected pods.

```

apiVersion: k8s.ovn.org/v1
kind: AdminPolicyBasedExternalRoute
metadata:
  name: shadow-traffic-policy
spec:
  from:
    namespaceSelector:
      matchLabels:
        externalTraffic: ""
  nextHops:
    dynamic:
      - podSelector:
          matchLabels:
            gatewayPod: ""
        namespaceSelector:
          matchLabels:
            shadowTraffic: ""
        networkAttachmentName: shadow-gateway
      - podSelector:
          matchLabels:
            gigabyteGW: ""
        namespaceSelector:
          matchLabels:
            gatewayNamespace: ""
        networkAttachmentName: gateway

```

In the following example, the **AdminPolicyBasedExternalRoute** object configures both static and dynamic external gateways.

```

apiVersion: k8s.ovn.org/v1
kind: AdminPolicyBasedExternalRoute
metadata:
  name: multi-hop-policy
spec:
  from:
    namespaceSelector:
      matchLabels:
        trafficType: "egress"
  nextHops:
    static:
      - ip: "172.18.0.8"
      - ip: "172.18.0.9"
    dynamic:
      - podSelector:
          matchLabels:
            gatewayPod: ""
        namespaceSelector:

```

```
matchLabels:
  egressTraffic: ""
networkAttachmentName: gigabyte
```

28.11.4. Configure a secondary external gateway

You can configure an external gateway on the default network for a namespace in your cluster.

Prerequisites

- You installed the OpenShift CLI (**oc**).
- You are logged in to the cluster with a user with **cluster-admin** privileges.

Procedure

1. Create a YAML file that contains an **AdminPolicyBasedExternalRoute** object.
2. To create an admin policy based external route, enter the following command:

```
$ oc create -f <file>.yaml
```

where:

<file>

Specifies the name of the YAML file that you created in the previous step.

Example output

```
adminpolicybasedexternalroute.k8s.ovn.org/default-route-policy created
```

3. To confirm that the admin policy based external route was created, enter the following command:

```
$ oc describe apbexternalroute <name> | tail -n 6
```

where:

<name>

Specifies the name of the **AdminPolicyBasedExternalRoute** object.

Example output

```
Status:
  Last Transition Time: 2023-04-24T15:09:01Z
Messages:
  Configured external gateway IPs: 172.18.0.8
  Status: Success
Events: <none>
```

28.11.5. Additional resources

- For more information about additional network attachments, see [Understanding multiple networks](#)

28.12. CONFIGURING AN EGRESS FIREWALL FOR A PROJECT

As a cluster administrator, you can create an egress firewall for a project that restricts egress traffic leaving your OpenShift Container Platform cluster.

28.12.1. How an egress firewall works in a project

As a cluster administrator, you can use an *egress firewall* to limit the external hosts that some or all pods can access from within the cluster. An egress firewall supports the following scenarios:

- A pod can only connect to internal hosts and cannot initiate connections to the public internet.
- A pod can only connect to the public internet and cannot initiate connections to internal hosts that are outside the OpenShift Container Platform cluster.
- A pod cannot reach specified internal subnets or hosts outside the OpenShift Container Platform cluster.
- A pod can connect to only specific external hosts.

For example, you can allow one project access to a specified IP range but deny the same access to a different project. Or you can restrict application developers from updating from Python pip mirrors, and force updates to come only from approved sources.

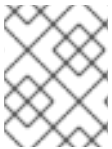

NOTE

Egress firewall does not apply to the host network namespace. Pods with host networking enabled are unaffected by egress firewall rules.

You configure an egress firewall policy by creating an EgressFirewall custom resource (CR) object. The egress firewall matches network traffic that meets any of the following criteria:

- An IP address range in CIDR format
- A DNS name that resolves to an IP address
- A port number
- A protocol that is one of the following protocols: TCP, UDP, and SCTP

IMPORTANT

If your egress firewall includes a deny rule for **0.0.0.0/0**, access to your OpenShift Container Platform API servers is blocked. You must either add allow rules for each IP address or use the **nodeSelector** type allow rule in your egress policy rules to connect to API servers.

The following example illustrates the order of the egress firewall rules necessary to ensure API server access:

```
apiVersion: k8s.ovn.org/v1
kind: EgressFirewall
metadata:
  name: default
  namespace: <namespace> ❶
spec:
  egress:
  - to:
    cidrSelector: <api_server_address_range> ❷
    type: Allow
  # ...
  - to:
    cidrSelector: 0.0.0.0/0 ❸
    type: Deny
```

- ❶ The namespace for the egress firewall.
- ❷ The IP address range that includes your OpenShift Container Platform API servers.
- ❸ A global deny rule prevents access to the OpenShift Container Platform API servers.

To find the IP address for your API servers, run **oc get ep kubernetes -n default**.

For more information, see [BZ#1988324](#).



WARNING

Egress firewall rules do not apply to traffic that goes through routers. Any user with permission to create a Route CR object can bypass egress firewall policy rules by creating a route that points to a forbidden destination.

28.12.1.1. Limitations of an egress firewall

An egress firewall has the following limitations:

- No project can have more than one EgressFirewall object.
- A maximum of one EgressFirewall object with a maximum of 8,000 rules can be defined per project.

- If you are using the OVN-Kubernetes network plugin with shared gateway mode in Red Hat OpenShift Networking, return ingress replies are affected by egress firewall rules. If the egress firewall rules drop the ingress reply destination IP, the traffic is dropped.

Violating any of these restrictions results in a broken egress firewall for the project. Consequently, all external network traffic is dropped, which can cause security risks for your organization.

An Egress Firewall resource can be created in the **kube-node-lease**, **kube-public**, **kube-system**, **openshift** and **openshift-** projects.

28.12.1.2. Matching order for egress firewall policy rules

The egress firewall policy rules are evaluated in the order that they are defined, from first to last. The first rule that matches an egress connection from a pod applies. Any subsequent rules are ignored for that connection.

28.12.1.3. How Domain Name Server (DNS) resolution works

If you use DNS names in any of your egress firewall policy rules, proper resolution of the domain names is subject to the following restrictions:

- Domain name updates are polled based on a time-to-live (TTL) duration. By default, the duration is 30 minutes. When the egress firewall controller queries the local name servers for a domain name, if the response includes a TTL and the TTL is less than 30 minutes, the controller sets the duration for that DNS name to the returned value. Each DNS name is queried after the TTL for the DNS record expires.
- The pod must resolve the domain from the same local name servers when necessary. Otherwise the IP addresses for the domain known by the egress firewall controller and the pod can be different. If the IP addresses for a hostname differ, the egress firewall might not be enforced consistently.
- Because the egress firewall controller and pods asynchronously poll the same local name server, the pod might obtain the updated IP address before the egress controller does, which causes a race condition. Due to this current limitation, domain name usage in EgressFirewall objects is only recommended for domains with infrequent IP address changes.



NOTE

Using DNS names in your egress firewall policy does not affect local DNS resolution through CoreDNS.

However, if your egress firewall policy uses domain names, and an external DNS server handles DNS resolution for an affected pod, you must include egress firewall rules that permit access to the IP addresses of your DNS server.

28.12.2. EgressFirewall custom resource (CR) object

You can define one or more rules for an egress firewall. A rule is either an **Allow** rule or a **Deny** rule, with a specification for the traffic that the rule applies to.

The following YAML describes an EgressFirewall CR object:

EgressFirewall object

```

apiVersion: k8s.ovn.org/v1
kind: EgressFirewall
metadata:
  name: <name> ❶
spec:
  egress: ❷
  ...

```

- ❶ The name for the object must be **default**.
- ❷ A collection of one or more egress network policy rules as described in the following section.

28.12.2.1. EgressFirewall rules

The following YAML describes an egress firewall rule object. The user can select either an IP address range in CIDR format, a domain name, or use the **nodeSelector** to allow or deny egress traffic. The **egress** stanza expects an array of one or more objects.

Egress policy rule stanza

```

egress:
- type: <type> ❶
  to: ❷
    cidrSelector: <cidr> ❸
    dnsName: <dns_name> ❹
    nodeSelector: <label_name>: <label_value> ❺
  ports: ❻
  ...

```

- ❶ The type of rule. The value must be either **Allow** or **Deny**.
- ❷ A stanza describing an egress traffic match rule that specifies the **cidrSelector** field or the **dnsName** field. You cannot use both fields in the same rule.
- ❸ An IP address range in CIDR format.
- ❹ A DNS domain name.
- ❺ Labels are key/value pairs that the user defines. Labels are attached to objects, such as pods. The **nodeSelector** allows for one or more node labels to be selected and attached to pods.
- ❻ Optional: A stanza describing a collection of network ports and protocols for the rule.

Ports stanza

```

ports:
- port: <port> ❶
  protocol: <protocol> ❷

```

- ❶ A network port, such as **80** or **443**. If you specify a value for this field, you must also specify a value for **protocol**.

- 2 A network protocol. The value must be either **TCP**, **UDP**, or **SCTP**.

28.12.2.2. Example EgressFirewall CR objects

The following example defines several egress firewall policy rules:

```
apiVersion: k8s.ovn.org/v1
kind: EgressFirewall
metadata:
  name: default
spec:
  egress: 1
  - type: Allow
    to:
      cidrSelector: 1.2.3.0/24
  - type: Deny
    to:
      cidrSelector: 0.0.0.0/0
```

- 1 A collection of egress firewall policy rule objects.

The following example defines a policy rule that denies traffic to the host at the **172.16.1.1** IP address, if the traffic is using either the TCP protocol and destination port **80** or any protocol and destination port **443**.

```
apiVersion: k8s.ovn.org/v1
kind: EgressFirewall
metadata:
  name: default
spec:
  egress:
  - type: Deny
    to:
      cidrSelector: 172.16.1.1
    ports:
      - port: 80
        protocol: TCP
      - port: 443
```

28.12.2.3. Example nodeSelector for EgressFirewall

As a cluster administrator, you can allow or deny egress traffic to nodes in your cluster by specifying a label using **nodeSelector**. Labels can be applied to one or more nodes. The following is an example with the **region=east** label:

```
apiVersion: k8s.ovn.org/v1
kind: EgressFirewall
metadata:
  name: default
spec:
  egress:
  - to:
```



```
nodeSelector:
  matchLabels:
    region: east
type: Allow
```

TIP

Instead of adding manual rules per node IP address, use node selectors to create a label that allows pods behind an egress firewall to access host network pods.

28.12.3. Creating an egress firewall policy object

As a cluster administrator, you can create an egress firewall policy object for a project.

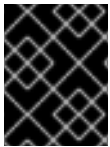
**IMPORTANT**

If the project already has an EgressFirewall object defined, you must edit the existing policy to make changes to the egress firewall rules.

Prerequisites

- A cluster that uses the OVN-Kubernetes network plugin.
- Install the OpenShift CLI (**oc**).
- You must log in to the cluster as a cluster administrator.

Procedure

1. Create a policy rule:
 - a. Create a **<policy_name>.yaml** file where **<policy_name>** describes the egress policy rules.
 - b. In the file you created, define an egress policy object.
2. Enter the following command to create the policy object. Replace **<policy_name>** with the name of the policy and **<project>** with the project that the rule applies to.

```
$ oc create -f <policy_name>.yaml -n <project>
```

In the following example, a new EgressFirewall object is created in a project named **project1**:

```
$ oc create -f default.yaml -n project1
```

Example output

```
egressfirewall.k8s.ovn.org/v1 created
```

3. Optional: Save the **<policy_name>.yaml** file so that you can make changes later.

28.13. VIEWING AN EGRESS FIREWALL FOR A PROJECT

As a cluster administrator, you can list the names of any existing egress firewalls and view the traffic rules for a specific egress firewall.



NOTE

OpenShift SDN CNI is deprecated as of OpenShift Container Platform 4.14. As of OpenShift Container Platform 4.15, the network plugin is not an option for new installations. In a subsequent future release, the OpenShift SDN network plugin is planned to be removed and no longer supported. Red Hat will provide bug fixes and support for this feature until it is removed, but this feature will no longer receive enhancements. As an alternative to OpenShift SDN CNI, you can use OVN Kubernetes CNI instead.

28.13.1. Viewing an EgressFirewall object

You can view an EgressFirewall object in your cluster.

Prerequisites

- A cluster using the OVN-Kubernetes network plugin.
- Install the OpenShift Command-line Interface (CLI), commonly known as **oc**.
- You must log in to the cluster.

Procedure

1. Optional: To view the names of the EgressFirewall objects defined in your cluster, enter the following command:

```
$ oc get egressfirewall --all-namespaces
```

2. To inspect a policy, enter the following command. Replace **<policy_name>** with the name of the policy to inspect.

```
$ oc describe egressfirewall <policy_name>
```

Example output

```
Name: default
Namespace: project1
Created: 20 minutes ago
Labels: <none>
Annotations: <none>
Rule: Allow to 1.2.3.0/24
Rule: Allow to www.example.com
Rule: Deny to 0.0.0.0/0
```

28.14. EDITING AN EGRESS FIREWALL FOR A PROJECT

As a cluster administrator, you can modify network traffic rules for an existing egress firewall.

28.14.1. Editing an EgressFirewall object

As a cluster administrator, you can update the egress firewall for a project.

Prerequisites

- A cluster using the OVN-Kubernetes network plugin.
- Install the OpenShift CLI (**oc**).
- You must log in to the cluster as a cluster administrator.

Procedure

1. Find the name of the EgressFirewall object for the project. Replace **<project>** with the name of the project.

```
$ oc get -n <project> egressfirewall
```

2. Optional: If you did not save a copy of the EgressFirewall object when you created the egress network firewall, enter the following command to create a copy.

```
$ oc get -n <project> egressfirewall <name> -o yaml > <filename>.yaml
```

Replace **<project>** with the name of the project. Replace **<name>** with the name of the object. Replace **<filename>** with the name of the file to save the YAML to.

3. After making changes to the policy rules, enter the following command to replace the EgressFirewall object. Replace **<filename>** with the name of the file containing the updated EgressFirewall object.

```
$ oc replace -f <filename>.yaml
```

28.15. REMOVING AN EGRESS FIREWALL FROM A PROJECT

As a cluster administrator, you can remove an egress firewall from a project to remove all restrictions on network traffic from the project that leaves the OpenShift Container Platform cluster.

28.15.1. Removing an EgressFirewall object

As a cluster administrator, you can remove an egress firewall from a project.

Prerequisites

- A cluster using the OVN-Kubernetes network plugin.
- Install the OpenShift CLI (**oc**).
- You must log in to the cluster as a cluster administrator.

Procedure

1. Find the name of the EgressFirewall object for the project. Replace **<project>** with the name of the project.

```
$ oc get -n <project> egressfirewall
```

2. Enter the following command to delete the EgressFirewall object. Replace **<project>** with the name of the project and **<name>** with the name of the object.

```
$ oc delete -n <project> egressfirewall <name>
```

28.16. CONFIGURING AN EGRESS IP ADDRESS

As a cluster administrator, you can configure the OVN-Kubernetes Container Network Interface (CNI) network plugin to assign one or more egress IP addresses to a namespace, or to specific pods in a namespace.

28.16.1. Egress IP address architectural design and implementation

The OpenShift Container Platform egress IP address functionality allows you to ensure that the traffic from one or more pods in one or more namespaces has a consistent source IP address for services outside the cluster network.

For example, you might have a pod that periodically queries a database that is hosted on a server outside of your cluster. To enforce access requirements for the server, a packet filtering device is configured to allow traffic only from specific IP addresses. To ensure that you can reliably allow access to the server from only that specific pod, you can configure a specific egress IP address for the pod that makes the requests to the server.

An egress IP address assigned to a namespace is different from an egress router, which is used to send traffic to specific destinations.

In some cluster configurations, application pods and ingress router pods run on the same node. If you configure an egress IP address for an application project in this scenario, the IP address is not used when you send a request to a route from the application project.



IMPORTANT

Egress IP addresses must not be configured in any Linux network configuration files, such as **ifcfg-eth0**.

28.16.1.1. Platform support

Support for the egress IP address functionality on various platforms is summarized in the following table:

| Platform | Supported |
|------------------------------------|-----------|
| Bare metal | Yes |
| VMware vSphere | Yes |
| Red Hat OpenStack Platform (RHOSP) | Yes |
| Amazon Web Services (AWS) | Yes |

| Platform | Supported |
|--|-----------|
| Google Cloud Platform (GCP) | Yes |
| Microsoft Azure | Yes |
| IBM Z® and IBM® LinuxONE | Yes |
| IBM Z® and IBM® LinuxONE for Red Hat Enterprise Linux (RHEL) KVM | Yes |
| IBM Power® | Yes |
| Nutanix | Yes |



IMPORTANT

The assignment of egress IP addresses to control plane nodes with the EgressIP feature is not supported on a cluster provisioned on Amazon Web Services (AWS). ([BZ#2039656](#)).

28.16.1.2. Public cloud platform considerations

For clusters provisioned on public cloud infrastructure, there is a constraint on the absolute number of assignable IP addresses per node. The maximum number of assignable IP addresses per node, or the *IP capacity*, can be described in the following formula:

$$\text{IP capacity} = \text{public cloud default capacity} - \text{sum}(\text{current IP assignments})$$

While the Egress IPs capability manages the IP address capacity per node, it is important to plan for this constraint in your deployments. For example, for a cluster installed on bare-metal infrastructure with 8 nodes you can configure 150 egress IP addresses. However, if a public cloud provider limits IP address capacity to 10 IP addresses per node, the total number of assignable IP addresses is only 80. To achieve the same IP address capacity in this example cloud provider, you would need to allocate 7 additional nodes.

To confirm the IP capacity and subnets for any node in your public cloud environment, you can enter the **oc get node <node_name> -o yaml** command. The **cloud.network.openshift.io/egress-ipconfig** annotation includes capacity and subnet information for the node.

The annotation value is an array with a single object with fields that provide the following information for the primary network interface:

- **interface**: Specifies the interface ID on AWS and Azure and the interface name on GCP.
- **ifaddr**: Specifies the subnet mask for one or both IP address families.
- **capacity**: Specifies the IP address capacity for the node. On AWS, the IP address capacity is provided per IP address family. On Azure and GCP, the IP address capacity includes both IPv4 and IPv6 addresses.

Automatic attachment and detachment of egress IP addresses for traffic between nodes are available. This allows for traffic from many pods in namespaces to have a consistent source IP address to locations outside of the cluster. This also supports OpenShift SDN and OVN-Kubernetes, which is the default networking plugin in Red Hat OpenShift Networking in OpenShift Container Platform 4.15.



NOTE

The RHOSP egress IP address feature creates a Neutron reservation port called **egressip-<IP address>**. Using the same RHOSP user as the one used for the OpenShift Container Platform cluster installation, you can assign a floating IP address to this reservation port to have a predictable SNAT address for egress traffic. When an egress IP address on an RHOSP network is moved from one node to another, because of a node failover, for example, the Neutron reservation port is removed and recreated. This means that the floating IP association is lost and you need to manually reassign the floating IP address to the new reservation port.



NOTE

When an RHOSP cluster administrator assigns a floating IP to the reservation port, OpenShift Container Platform cannot delete the reservation port. The **CloudPrivateIPConfig** object cannot perform delete and move operations until an RHOSP cluster administrator unassigns the floating IP from the reservation port.

The following examples illustrate the annotation from nodes on several public cloud providers. The annotations are indented for readability.

Example `cloud.network.openshift.io/egress-ipconfig` annotation on AWS

```
cloud.network.openshift.io/egress-ipconfig: [
  {
    "interface":"eni-078d267045138e436",
    "ifaddr":{"ipv4":"10.0.128.0/18"},
    "capacity":{"ipv4":14,"ipv6":15}
  }
]
```

Example `cloud.network.openshift.io/egress-ipconfig` annotation on GCP

```
cloud.network.openshift.io/egress-ipconfig: [
  {
    "interface":"nic0",
    "ifaddr":{"ipv4":"10.0.128.0/18"},
    "capacity":{"ip":14}
  }
]
```

The following sections describe the IP address capacity for supported public cloud environments for use in your capacity calculation.

28.16.1.2.1. Amazon Web Services (AWS) IP address capacity limits

On AWS, constraints on IP address assignments depend on the instance type configured. For more information, see [IP addresses per network interface per instance type](#)

28.16.1.2.2. Google Cloud Platform (GCP) IP address capacity limits

On GCP, the networking model implements additional node IP addresses through IP address aliasing, rather than IP address assignments. However, IP address capacity maps directly to IP aliasing capacity.

The following capacity limits exist for IP aliasing assignment:

- Per node, the maximum number of IP aliases, both IPv4 and IPv6, is 100.
- Per VPC, the maximum number of IP aliases is unspecified, but OpenShift Container Platform scalability testing reveals the maximum to be approximately 15,000.

For more information, see [Per instance quotas](#) and [Alias IP ranges overview](#).

28.16.1.2.3. Microsoft Azure IP address capacity limits

On Azure, the following capacity limits exist for IP address assignment:

- Per NIC, the maximum number of assignable IP addresses, for both IPv4 and IPv6, is 256.
- Per virtual network, the maximum number of assigned IP addresses cannot exceed 65,536.

For more information, see [Networking limits](#).

28.16.1.3. Considerations for using an egress IP on additional network interfaces

In OpenShift Container Platform, egress IPs provide administrators a way to control network traffic. Egress IPs can be used with the **br-ex**, or primary, network interface, which is a Linux bridge interface associated with Open vSwitch, or they can be used with additional network interfaces.

You can inspect your network interface type by running the following command:

```
$ ip -details link show
```

The primary network interface is assigned a node IP address which also contains a subnet mask. Information for this node IP address can be retrieved from the Kubernetes node object for each node within your cluster by inspecting the **k8s.ovn.org/node-primary-ifaddr** annotation. In an IPv4 cluster, this annotation is similar to the following example: **"k8s.ovn.org/node-primary-ifaddr: {"ipv4": "192.168.111.23/24"}"**.

If the egress IP is not within the subnet of the primary network interface subnet, you can use an egress IP on another Linux network interface that is not of the primary network interface type. By doing so, OpenShift Container Platform administrators are provided with a greater level of control over networking aspects such as routing, addressing, segmentation, and security policies. This feature provides users with the option to route workload traffic over specific network interfaces for purposes such as traffic segmentation or meeting specialized requirements.

If the egress IP is not within the subnet of the primary network interface, then the selection of another network interface for egress traffic might occur if they are present on a node.

You can determine which other network interfaces might support egress IPs by inspecting the **k8s.ovn.org/host-cidrs** Kubernetes node annotation. This annotation contains the addresses and subnet mask found for the primary network interface. It also contains additional network interface addresses and subnet mask information. These addresses and subnet masks are assigned to network interfaces that use the [longest prefix match routing](#) mechanism to determine which network interface supports the egress IP.

**NOTE**

OVN-Kubernetes provides a mechanism to control and direct outbound network traffic from specific namespaces and pods. This ensures that it exits the cluster through a particular network interface and with a specific egress IP address.

Requirements for assigning an egress IP to a network interface that is not the primary network interface

For users who want an egress IP and traffic to be routed over a particular interface that is not the primary network interface, the following conditions must be met:

- OpenShift Container Platform is installed on a bare metal cluster. This feature is disabled within cloud or hypervisor environments.
- Your OpenShift Container Platform pods are not configured as host-networked.
- If a network interface is removed or if the IP address and subnet mask which allows the egress IP to be hosted on the interface is removed, then the egress IP is reconfigured. Consequently, it could be assigned to another node and interface.
- The Egress IP must be IPv4. IPv6 is currently unsupported.
- IP forwarding must be enabled for the network interface. To enable IP forwarding, you can use the **oc edit network.operator** command and edit the object like the following example:

```
# ...
spec:
  clusterNetwork:
    - cidr: 10.128.0.0/14
      hostPrefix: 23
  defaultNetwork:
    ovnKubernetesConfig:
      gatewayConfig:
        ipForwarding: Global
# ...
```

28.16.1.4. Assignment of egress IPs to pods

To assign one or more egress IPs to a namespace or specific pods in a namespace, the following conditions must be satisfied:

- At least one node in your cluster must have the **k8s.ovn.org/egress-assignable: ""** label.
- An **EgressIP** object exists that defines one or more egress IP addresses to use as the source IP address for traffic leaving the cluster from pods in a namespace.

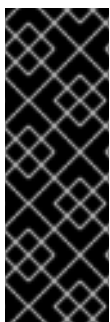
**IMPORTANT**

If you create **EgressIP** objects prior to labeling any nodes in your cluster for egress IP assignment, OpenShift Container Platform might assign every egress IP address to the first node with the **k8s.ovn.org/egress-assignable: ""** label.

To ensure that egress IP addresses are widely distributed across nodes in the cluster, always apply the label to the nodes you intent to host the egress IP addresses before creating any **EgressIP** objects.

28.16.1.5. Assignment of egress IPs to nodes

When creating an **EgressIP** object, the following conditions apply to nodes that are labeled with the **k8s.ovn.org/egress-assignable: ""** label:

- An egress IP address is never assigned to more than one node at a time.
- An egress IP address is equally balanced between available nodes that can host the egress IP address.
- If the **spec.EgressIPs** array in an **EgressIP** object specifies more than one IP address, the following conditions apply:
 - No node will ever host more than one of the specified IP addresses.
 - Traffic is balanced roughly equally between the specified IP addresses for a given namespace.
- If a node becomes unavailable, any egress IP addresses assigned to it are automatically reassigned, subject to the previously described conditions.

When a pod matches the selector for multiple **EgressIP** objects, there is no guarantee which of the egress IP addresses that are specified in the **EgressIP** objects is assigned as the egress IP address for the pod.

Additionally, if an **EgressIP** object specifies multiple egress IP addresses, there is no guarantee which of the egress IP addresses might be used. For example, if a pod matches a selector for an **EgressIP** object with two egress IP addresses, **10.10.20.1** and **10.10.20.2**, either might be used for each TCP connection or UDP conversation.

28.16.1.6. Architectural diagram of an egress IP address configuration

The following diagram depicts an egress IP address configuration. The diagram describes four pods in two different namespaces running on three nodes in a cluster. The nodes are assigned IP addresses from the **192.168.126.0/18** CIDR block on the host network.

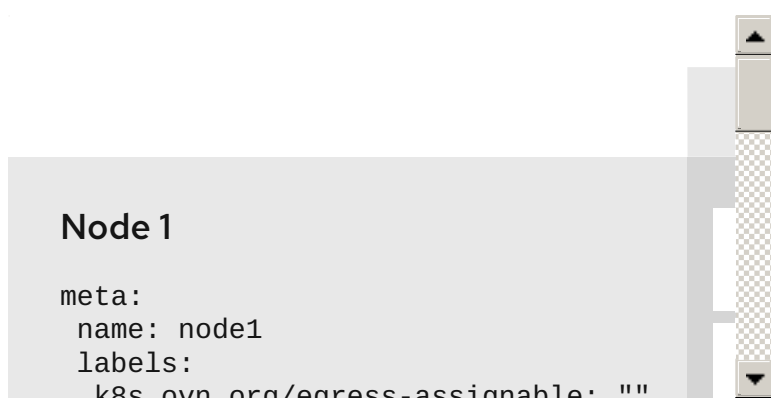

Both Node 1 and Node 3 are labeled with **k8s.ovn.org/egress-assignable: ""** and thus available for the assignment of egress IP addresses.

The dashed lines in the diagram depict the traffic flow from pod1, pod2, and pod3 traveling through the pod network to egress the cluster from Node 1 and Node 3. When an external service receives traffic from any of the pods selected by the example **EgressIP** object, the source IP address is either **192.168.126.10** or **192.168.126.102**. The traffic is balanced roughly equally between these two nodes.

The following resources from the diagram are illustrated in detail:

Namespace objects

The namespaces are defined in the following manifest:

Namespace objects

```

apiVersion: v1
kind: Namespace
metadata:
  name: namespace1
  labels:
    env: prod
---
apiVersion: v1
kind: Namespace
metadata:
  name: namespace2
  labels:
    env: prod

```

EgressIP object

The following **EgressIP** object describes a configuration that selects all pods in any namespace with the **env** label set to **prod**. The egress IP addresses for the selected pods are **192.168.126.10** and **192.168.126.102**.

EgressIP object

```

apiVersion: k8s.ovn.org/v1
kind: EgressIP
metadata:
  name: egressips-prod
spec:
  egressIPs:
  - 192.168.126.10
  - 192.168.126.102
  namespaceSelector:
    matchLabels:
      env: prod
status:
  items:
  - node: node1
    egressIP: 192.168.126.10
  - node: node3
    egressIP: 192.168.126.102

```

For the configuration in the previous example, OpenShift Container Platform assigns both egress IP addresses to the available nodes. The **status** field reflects whether and where the egress IP addresses are assigned.

28.16.2. EgressIP object

The following YAML describes the API for the **EgressIP** object. The scope of the object is cluster-wide; it is not created in a namespace.

-

```

apiVersion: k8s.ovn.org/v1
kind: EgressIP
metadata:
  name: <name> ❶
spec:
  egressIPs: ❷
  - <ip_address>
  namespaceSelector: ❸
  ...
  podSelector: ❹
  ...

```

- ❶ The name for the **EgressIPs** object.
- ❷ An array of one or more IP addresses.
- ❸ One or more selectors for the namespaces to associate the egress IP addresses with.
- ❹ Optional: One or more selectors for pods in the specified namespaces to associate egress IP addresses with. Applying these selectors allows for the selection of a subset of pods within a namespace.

The following YAML describes the stanza for the namespace selector:

Namespace selector stanza

```

namespaceSelector: ❶
matchLabels:
  <label_name>: <label_value>

```

- ❶ One or more matching rules for namespaces. If more than one match rule is provided, all matching namespaces are selected.

The following YAML describes the optional stanza for the pod selector:

Pod selector stanza

```

podSelector: ❶
matchLabels:
  <label_name>: <label_value>

```

- ❶ Optional: One or more matching rules for pods in the namespaces that match the specified **namespaceSelector** rules. If specified, only pods that match are selected. Others pods in the namespace are not selected.

In the following example, the **EgressIP** object associates the **192.168.126.11** and **192.168.126.102** egress IP addresses with pods that have the **app** label set to **web** and are in the namespaces that have the **env** label set to **prod**:

Example EgressIP object

```

apiVersion: k8s.ovn.org/v1

```

```

kind: EgressIP
metadata:
  name: egress-group1
spec:
  egressIPs:
    - 192.168.126.11
    - 192.168.126.102
  podSelector:
    matchLabels:
      app: web
  namespaceSelector:
    matchLabels:
      env: prod

```

In the following example, the **EgressIP** object associates the **192.168.127.30** and **192.168.127.40** egress IP addresses with any pods that do not have the **environment** label set to **development**:

Example EgressIP object

```

apiVersion: k8s.ovn.org/v1
kind: EgressIP
metadata:
  name: egress-group2
spec:
  egressIPs:
    - 192.168.127.30
    - 192.168.127.40
  namespaceSelector:
    matchExpressions:
      - key: environment
        operator: NotIn
        values:
          - development

```

28.16.3. EgressIPconfig object

As a feature of egress IP, the **reachabilityTotalTimeoutSeconds** parameter configures the total timeout for checks that are sent by probes to egress IP nodes. The **egressIPConfig** object allows users to set the **reachabilityTotalTimeoutSeconds spec**. If the EgressIP node cannot be reached within this timeout, the node is declared down.

You can increase this value if your network is not stable enough to handle the current default value of 1 second.

The following YAML describes changing the **reachabilityTotalTimeoutSeconds** from the default 1 second probes to 5 second probes:

```

apiVersion: operator.openshift.io/v1
kind: Network
metadata:
  name: cluster
spec:
  clusterNetwork:
    - cidr: 10.128.0.0/14
      hostPrefix: 23

```

```

defaultNetwork:
  ovnKubernetesConfig:
    egressIPConfig: 1
      reachabilityTotalTimeoutSeconds: 5 2
    gatewayConfig:
      routingViaHost: false
    genevePort: 6081

```

- 1 The **egressIPConfig** holds the configurations for the options of the **EgressIP** object. Changing these configurations allows you to extend the **EgressIP** object.
- 2 The value for **reachabilityTotalTimeoutSeconds** accepts integer values from **0** to **60**. A value of **0** disables the reachability check of the egressIP node. Values of **1** to **60** correspond to the duration in seconds between probes sending the reachability check for the node.

28.16.4. Labeling a node to host egress IP addresses

You can apply the `k8s.ovn.org/egress-assignable=""` label to a node in your cluster so that OpenShift Container Platform can assign one or more egress IP addresses to the node.

Prerequisites

- Install the OpenShift CLI (**oc**).
- Log in to the cluster as a cluster administrator.

Procedure

- To label a node so that it can host one or more egress IP addresses, enter the following command:

```
$ oc label nodes <node_name> k8s.ovn.org/egress-assignable="" 1
```

- 1 The name of the node to label.

TIP

You can alternatively apply the following YAML to add the label to a node:

```

apiVersion: v1
kind: Node
metadata:
  labels:
    k8s.ovn.org/egress-assignable: ""
  name: <node_name>

```

28.16.5. Next steps

- [Assigning egress IPs](#)

28.16.6. Additional resources

- [LabelSelector meta/v1](#)
- [LabelSelectorRequirement meta/v1](#)

28.17. ASSIGNING AN EGRESS IP ADDRESS

As a cluster administrator, you can assign an egress IP address for traffic leaving the cluster from a namespace or from specific pods in a namespace.

28.17.1. Assigning an egress IP address to a namespace

You can assign one or more egress IP addresses to a namespace or to specific pods in a namespace.

Prerequisites

- Install the OpenShift CLI (**oc**).
- Log in to the cluster as a cluster administrator.
- Configure at least one node to host an egress IP address.

Procedure

1. Create an **EgressIP** object:
 - a. Create a **<egressips_name>.yaml** file where **<egressips_name>** is the name of the object.
 - b. In the file that you created, define an **EgressIP** object, as in the following example:

```
apiVersion: k8s.ovn.org/v1
kind: EgressIP
metadata:
  name: egress-project1
spec:
  egressIPs:
  - 192.168.127.10
  - 192.168.127.11
  namespaceSelector:
    matchLabels:
      env: qa
```

2. To create the object, enter the following command.

```
$ oc apply -f <egressips_name>.yaml 1
```

- 1** Replace **<egressips_name>** with the name of the object.

Example output

```
egressips.k8s.ovn.org/<egressips_name> created
```

3. Optional: Save the **<egressips_name>.yaml** file so that you can make changes later.

4. Add labels to the namespace that requires egress IP addresses. To add a label to the namespace of an **EgressIP** object defined in step 1, run the following command:

```
$ oc label ns <namespace> env=qa 1
```

- 1** Replace **<namespace>** with the namespace that requires egress IP addresses.

28.17.2. Additional resources

- [Configuring egress IP addresses](#)

28.18. CONFIGURING AN EGRESS SERVICE

As a cluster administrator, you can configure egress traffic for pods behind a load balancer service by using an egress service.



IMPORTANT

Egress service is a Technology Preview feature only. Technology Preview features are not supported with Red Hat production service level agreements (SLAs) and might not be functionally complete. Red Hat does not recommend using them in production. These features provide early access to upcoming product features, enabling customers to test functionality and provide feedback during the development process.

For more information about the support scope of Red Hat Technology Preview features, see [Technology Preview Features Support Scope](#).

You can use the **EgressService** custom resource (CR) to manage egress traffic in the following ways:

- Assign a load balancer service IP address as the source IP address for egress traffic for pods behind the load balancer service.

Assigning the load balancer IP address as the source IP address in this context is useful to present a single point of egress and ingress. For example, in some scenarios, an external system communicating with an application behind a load balancer service can expect the source and destination IP address for the application to be the same.



NOTE

When you assign the load balancer service IP address to egress traffic for pods behind the service, OVN-Kubernetes restricts the ingress and egress point to a single node. This limits the load balancing of traffic that MetalLB typically provides.

- Assign the egress traffic for pods behind a load balancer to a different network than the default node network.

This is useful to assign the egress traffic for applications behind a load balancer to a different network than the default network. Typically, the different network is implemented by using a VRF instance associated with a network interface.

28.18.1. Egress service custom resource

Define the configuration for an egress service in an **EgressService** custom resource. The following YAML describes the fields for the configuration of an egress service:

```
apiVersion: k8s.ovn.org/v1
kind: EgressService
metadata:
  name: <egress_service_name> 1
  namespace: <namespace> 2
spec:
  sourceIPBy: <egress_traffic_ip> 3
  nodeSelector: 4
    matchLabels:
      node-role.kubernetes.io/<role>: ""
  network: <egress_traffic_network> 5
```

- 1 Specify the name for the egress service. The name of the **EgressService** resource must match the name of the load-balancer service that you want to modify.
- 2 Specify the namespace for the egress service. The namespace for the **EgressService** must match the namespace of the load-balancer service that you want to modify. The egress service is namespace-scoped.
- 3 Specify the source IP address of egress traffic for pods behind a service. Valid values are **LoadBalancerIP** or **Network**. Use the **LoadBalancerIP** value to assign the **LoadBalancer** service ingress IP address as the source IP address for egress traffic. Specify **Network** to assign the network interface IP address as the source IP address for egress traffic.
- 4 Optional: If you use the **LoadBalancerIP** value for the **sourceIPBy** specification, a single node handles the **LoadBalancer** service traffic. Use the **nodeSelector** field to limit which node can be assigned this task. When a node is selected to handle the service traffic, OVN-Kubernetes labels the node in the following format: **egress-service.k8s.ovn.org/<svc-namespace>-<svc-name>: ""**. When the **nodeSelector** field is not specified, any node can manage the **LoadBalancer** service traffic.
- 5 Optional: Specify the routing table for egress traffic. If you do not include the **network** specification, the egress service uses the default host network.

Example egress service specification

```
apiVersion: k8s.ovn.org/v1
kind: EgressService
metadata:
  name: test-egress-service
  namespace: test-namespace
spec:
  sourceIPBy: "LoadBalancerIP"
  nodeSelector:
    matchLabels:
      vrf: "true"
  network: "2"
```

28.18.2. Deploying an egress service

You can deploy an egress service to manage egress traffic for pods behind a **LoadBalancer** service.

The following example configures the egress traffic to have the same source IP address as the ingress IP address of the **LoadBalancer** service.

Prerequisites

- Install the OpenShift CLI (**oc**).
- Log in as a user with **cluster-admin** privileges.
- You configured MetalLB **BGPPeer** resources.

Procedure

1. Create an **IPAddressPool** CR with the desired IP for the service:
 - a. Create a file, such as **ip-addr-pool.yaml**, with content like the following example:

```
apiVersion: metallb.io/v1beta1
kind: IPAddressPool
metadata:
  name: example-pool
  namespace: metallb-system
spec:
  addresses:
  - 172.19.0.100/32
```

- b. Apply the configuration for the IP address pool by running the following command:

```
$ oc apply -f ip-addr-pool.yaml
```

2. Create **Service** and **EgressService** CRs:
 - a. Create a file, such as **service-egress-service.yaml**, with content like the following example:

```
apiVersion: v1
kind: Service
metadata:
  name: example-service
  namespace: example-namespace
  annotations:
    metallb.universe.tf/address-pool: example-pool 1
spec:
  selector:
    app: example
  ports:
  - name: http
    protocol: TCP
    port: 8080
    targetPort: 8080
  type: LoadBalancer
---
apiVersion: k8s.ovn.org/v1
kind: EgressService
metadata:
  name: example-service
```

```

namespace: example-namespace
spec:
  sourceIPBy: "LoadBalancerIP" 2
  nodeSelector: 3
  matchLabels:
    node-role.kubernetes.io/worker: ""

```

- 1 The **LoadBalancer** service uses the IP address assigned by MetalLB from the **example-pool** IP address pool.
- 2 This example uses the **LoadBalancerIP** value to assign the ingress IP address of the **LoadBalancer** service as the source IP address of egress traffic.
- 3 When you specify the **LoadBalancerIP** value, a single node handles the **LoadBalancer** service's traffic. In this example, only nodes with the **worker** label can be selected to handle the traffic. When a node is selected, OVN-Kubernetes labels the node in the following format **egress-service.k8s.ovn.org/<svc-namespace>-<svc-name>: ""**.



NOTE

If you use the **sourceIPBy: "LoadBalancerIP"** setting, you must specify the load-balancer node in the **BGPAdvertisement** custom resource (CR).

- b. Apply the configuration for the service and egress service by running the following command:

```
$ oc apply -f service-egress-service.yaml
```

3. Create a **BGPAdvertisement** CR to advertise the service:
 - a. Create a file, such as **service-bgp-advertisement.yaml**, with content like the following example:

```

apiVersion: metallb.io/v1beta1
kind: BGPAdvertisement
metadata:
  name: example-bgp-adv
  namespace: metallb-system
spec:
  ipAddressPools:
  - example-pool
  nodeSelector:
  - matchLabels:
    egress-service.k8s.ovn.org/example-namespace-example-service: "" 1

```

- 1 In this example, the **EgressService** CR configures the source IP address for egress traffic to use the load-balancer service IP address. Therefore, you must specify the load-balancer node for return traffic to use the same return path for the traffic originating from the pod.

Verification

1. Verify that you can access the application endpoint of the pods running behind the MetalLB service by running the following command:

```
$ curl <external_ip_address>:<port_number> 1
```

- 1 Update the external IP address and port number to suit your application endpoint.

2. If you assigned the **LoadBalancer** service's ingress IP address as the source IP address for egress traffic, verify this configuration by using tools such as **tcpdump** to analyze packets received at the external client.

Additional resources

- [Exposing a service through a network VRF](#)
- [Example: Network interface with a VRF instance node network configuration policy](#)
- [Managing symmetric routing with MetalLB](#)
- [About virtual routing and forwarding](#)

28.19. CONSIDERATIONS FOR THE USE OF AN EGRESS ROUTER POD

28.19.1. About an egress router pod

The OpenShift Container Platform egress router pod redirects traffic to a specified remote server from a private source IP address that is not used for any other purpose. An egress router pod can send network traffic to servers that are set up to allow access only from specific IP addresses.



NOTE

The egress router pod is not intended for every outgoing connection. Creating large numbers of egress router pods can exceed the limits of your network hardware. For example, creating an egress router pod for every project or application could exceed the number of local MAC addresses that the network interface can handle before reverting to filtering MAC addresses in software.



IMPORTANT

The egress router image is not compatible with Amazon AWS, Azure Cloud, or any other cloud platform that does not support layer 2 manipulations due to their incompatibility with macvlan traffic.

28.19.1.1. Egress router modes

In *redirect mode*, an egress router pod configures **iptables** rules to redirect traffic from its own IP address to one or more destination IP addresses. Client pods that need to use the reserved source IP address must be configured to access the service for the egress router rather than connecting directly to the destination IP. You can access the destination service and port from the application pod by using the **curl** command. For example:

```
$ curl <router_service_IP> <port>
```

**NOTE**

The egress router CNI plugin supports redirect mode only. This is a difference with the egress router implementation that you can deploy with OpenShift SDN. Unlike the egress router for OpenShift SDN, the egress router CNI plugin does not support HTTP proxy mode or DNS proxy mode.

28.19.1.2. Egress router pod implementation

The egress router implementation uses the egress router Container Network Interface (CNI) plugin. The plugin adds a secondary network interface to a pod.

An egress router is a pod that has two network interfaces. For example, the pod can have **eth0** and **net1** network interfaces. The **eth0** interface is on the cluster network and the pod continues to use the interface for ordinary cluster-related network traffic. The **net1** interface is on a secondary network and has an IP address and gateway for that network. Other pods in the OpenShift Container Platform cluster can access the egress router service and the service enables the pods to access external services. The egress router acts as a bridge between pods and an external system.

Traffic that leaves the egress router exits through a node, but the packets have the MAC address of the **net1** interface from the egress router pod.

When you add an egress router custom resource, the Cluster Network Operator creates the following objects:

- The network attachment definition for the **net1** secondary network interface of the pod.
- A deployment for the egress router.

If you delete an egress router custom resource, the Operator deletes the two objects in the preceding list that are associated with the egress router.

28.19.1.3. Deployment considerations

An egress router pod adds an additional IP address and MAC address to the primary network interface of the node. As a result, you might need to configure your hypervisor or cloud provider to allow the additional address.

Red Hat OpenStack Platform (RHOSP)

If you deploy OpenShift Container Platform on RHOSP, you must allow traffic from the IP and MAC addresses of the egress router pod on your OpenStack environment. If you do not allow the traffic, then [communication will fail](#):

```
$ openstack port set --allowed-address \
  ip_address=<ip_address>,mac_address=<mac_address> <neutron_port_uuid>
```

VMware vSphere

If you are using VMware vSphere, see the [VMware documentation for securing vSphere standard switches](#). View and change VMware vSphere default settings by selecting the host virtual switch from the vSphere Web Client.

Specifically, ensure that the following are enabled:

- [MAC Address Changes](#)

- [Forged Transits](#)
- [Promiscuous Mode Operation](#)

28.19.1.4. Failover configuration

To avoid downtime, the Cluster Network Operator deploys the egress router pod as a deployment resource. The deployment name is **egress-router-cni-deployment**. The pod that corresponds to the deployment has a label of **app=egress-router-cni**.

To create a new service for the deployment, use the **oc expose deployment/egress-router-cni-deployment --port <port_number>** command or create a file like the following example:

```
apiVersion: v1
kind: Service
metadata:
  name: app-egress
spec:
  ports:
    - name: tcp-8080
      protocol: TCP
      port: 8080
    - name: tcp-8443
      protocol: TCP
      port: 8443
    - name: udp-80
      protocol: UDP
      port: 80
  type: ClusterIP
  selector:
    app: egress-router-cni
```

28.19.2. Additional resources

- [Deploying an egress router in redirection mode](#)

28.20. DEPLOYING AN EGRESS ROUTER POD IN REDIRECT MODE

As a cluster administrator, you can deploy an egress router pod to redirect traffic to specified destination IP addresses from a reserved source IP address.

The egress router implementation uses the egress router Container Network Interface (CNI) plugin.

28.20.1. Egress router custom resource

Define the configuration for an egress router pod in an egress router custom resource. The following YAML describes the fields for the configuration of an egress router in redirect mode:

```
apiVersion: network.operator.openshift.io/v1
kind: EgressRouter
metadata:
  name: <egress_router_name>
  namespace: <namespace> 1
spec:
```

```

addresses: [ 2
  {
    ip: "<egress_router>", 3
    gateway: "<egress_gateway>" 4
  }
]
mode: Redirect
redirect: {
  redirectRules: [ 5
    {
      destinationIP: "<egress_destination>",
      port: <egress_router_port>,
      targetPort: <target_port>, 6
      protocol: <network_protocol> 7
    },
    ...
  ],
  fallbackIP: "<egress_destination>" 8
}

```

- 1 Optional: The **namespace** field specifies the namespace to create the egress router in. If you do not specify a value in the file or on the command line, the **default** namespace is used.
- 2 The **addresses** field specifies the IP addresses to configure on the secondary network interface.
- 3 The **ip** field specifies the reserved source IP address and netmask from the physical network that the node is on to use with egress router pod. Use CIDR notation to specify the IP address and netmask.
- 4 The **gateway** field specifies the IP address of the network gateway.
- 5 Optional: The **redirectRules** field specifies a combination of egress destination IP address, egress router port, and protocol. Incoming connections to the egress router on the specified port and protocol are routed to the destination IP address.
- 6 Optional: The **targetPort** field specifies the network port on the destination IP address. If this field is not specified, traffic is routed to the same network port that it arrived on.
- 7 The **protocol** field supports TCP, UDP, or SCTP.
- 8 Optional: The **fallbackIP** field specifies a destination IP address. If you do not specify any redirect rules, the egress router sends all traffic to this fallback IP address. If you specify redirect rules, any connections to network ports that are not defined in the rules are sent by the egress router to this fallback IP address. If you do not specify this field, the egress router rejects connections to network ports that are not defined in the rules.

Example egress router specification

```

apiVersion: network.operator.openshift.io/v1
kind: EgressRouter
metadata:
  name: egress-router-redirect
spec:
  networkInterface: {

```

```

    macvlan: {
      mode: "Bridge"
    }
  }
  addresses: [
    {
      ip: "192.168.12.99/24",
      gateway: "192.168.12.1"
    }
  ]
  mode: Redirect
  redirect: {
    redirectRules: [
      {
        destinationIP: "10.0.0.99",
        port: 80,
        protocol: UDP
      },
      {
        destinationIP: "203.0.113.26",
        port: 8080,
        targetPort: 80,
        protocol: TCP
      },
      {
        destinationIP: "203.0.113.27",
        port: 8443,
        targetPort: 443,
        protocol: TCP
      }
    ]
  }
}

```

28.20.2. Deploying an egress router in redirect mode

You can deploy an egress router to redirect traffic from its own reserved source IP address to one or more destination IP addresses.

After you add an egress router, the client pods that need to use the reserved source IP address must be modified to connect to the egress router rather than connecting directly to the destination IP.

Prerequisites

- Install the OpenShift CLI (**oc**).
- Log in as a user with **cluster-admin** privileges.

Procedure

1. Create an egress router definition.
2. To ensure that other pods can find the IP address of the egress router pod, create a service that uses the egress router, as in the following example:

```

apiVersion: v1

```

```

kind: Service
metadata:
  name: egress-1
spec:
  ports:
  - name: web-app
    protocol: TCP
    port: 8080
  type: ClusterIP
  selector:
    app: egress-router-cni 1

```

- 1** Specify the label for the egress router. The value shown is added by the Cluster Network Operator and is not configurable.

After you create the service, your pods can connect to the service. The egress router pod redirects traffic to the corresponding port on the destination IP address. The connections originate from the reserved source IP address.

Verification

To verify that the Cluster Network Operator started the egress router, complete the following procedure:

1. View the network attachment definition that the Operator created for the egress router:

```
$ oc get network-attachment-definition egress-router-cni-nad
```

The name of the network attachment definition is not configurable.

Example output

```

NAME                AGE
egress-router-cni-nad 18m

```

2. View the deployment for the egress router pod:

```
$ oc get deployment egress-router-cni-deployment
```

The name of the deployment is not configurable.

Example output

```

NAME                READY  UP-TO-DATE  AVAILABLE  AGE
egress-router-cni-deployment  1/1    1            1          18m

```

3. View the status of the egress router pod:

```
$ oc get pods -l app=egress-router-cni
```

Example output

```

NAME                                READY STATUS RESTARTS AGE
egress-router-cni-deployment-575465c75c-qkq6m 1/1   Running 0      18m

```

4. View the logs and the routing table for the egress router pod.

a. Get the node name for the egress router pod:

```

$ POD_NODENAME=$(oc get pod -l app=egress-router-cni -o jsonpath="{.items[0].spec.nodeName}")

```

b. Enter into a debug session on the target node. This step instantiates a debug pod called **<node_name>-debug**:

```

$ oc debug node/$POD_NODENAME

```

c. Set **/host** as the root directory within the debug shell. The debug pod mounts the root file system of the host in **/host** within the pod. By changing the root directory to **/host**, you can run binaries from the executable paths of the host:

```

# chroot /host

```

d. From within the **chroot** environment console, display the egress router logs:

```

# cat /tmp/egress-router-log

```

Example output

```

2021-04-26T12:27:20Z [debug] Called CNI ADD
2021-04-26T12:27:20Z [debug] Gateway: 192.168.12.1
2021-04-26T12:27:20Z [debug] IP Source Addresses: [192.168.12.99/24]
2021-04-26T12:27:20Z [debug] IP Destinations: [80 UDP 10.0.0.99/30 8080 TCP
203.0.113.26/30 80 8443 TCP 203.0.113.27/30 443]
2021-04-26T12:27:20Z [debug] Created macvlan interface
2021-04-26T12:27:20Z [debug] Renamed macvlan to "net1"
2021-04-26T12:27:20Z [debug] Adding route to gateway 192.168.12.1 on macvlan interface
2021-04-26T12:27:20Z [debug] deleted default route {lindex: 3 Dst: <nil> Src: <nil> Gw:
10.128.10.1 Flags: [] Table: 254}
2021-04-26T12:27:20Z [debug] Added new default route with gateway 192.168.12.1
2021-04-26T12:27:20Z [debug] Added iptables rule: iptables -t nat PREROUTING -i eth0 -p
UDP --dport 80 -j DNAT --to-destination 10.0.0.99
2021-04-26T12:27:20Z [debug] Added iptables rule: iptables -t nat PREROUTING -i eth0 -p
TCP --dport 8080 -j DNAT --to-destination 203.0.113.26:80
2021-04-26T12:27:20Z [debug] Added iptables rule: iptables -t nat PREROUTING -i eth0 -p
TCP --dport 8443 -j DNAT --to-destination 203.0.113.27:443
2021-04-26T12:27:20Z [debug] Added iptables rule: iptables -t nat -o net1 -j SNAT --to-
source 192.168.12.99

```

The logging file location and logging level are not configurable when you start the egress router by creating an **EgressRouter** object as described in this procedure.

e. From within the **chroot** environment console, get the container ID:

```

# crictl ps --name egress-router-cni-pod | awk '{print $1}'

```

Example output

```
CONTAINER
bac9fae69ddb6
```

- f. Determine the process ID of the container. In this example, the container ID is **bac9fae69ddb6**:

```
# crictl inspect -o yaml bac9fae69ddb6 | grep 'pid:' | awk '{print $2}'
```

Example output

```
68857
```

- g. Enter the network namespace of the container:

```
# nsenter -n -t 68857
```

- h. Display the routing table:

```
# ip route
```

In the following example output, the **net1** network interface is the default route. Traffic for the cluster network uses the **eth0** network interface. Traffic for the **192.168.12.0/24** network uses the **net1** network interface and originates from the reserved source IP address **192.168.12.99**. The pod routes all other traffic to the gateway at IP address **192.168.12.1**. Routing for the service network is not shown.

Example output

```
default via 192.168.12.1 dev net1
10.128.10.0/23 dev eth0 proto kernel scope link src 10.128.10.18
192.168.12.0/24 dev net1 proto kernel scope link src 192.168.12.99
192.168.12.1 dev net1
```

28.21. ENABLING MULTICAST FOR A PROJECT

28.21.1. About multicast

With IP multicast, data is broadcast to many IP addresses simultaneously.



IMPORTANT

- At this time, multicast is best used for low-bandwidth coordination or service discovery and not a high-bandwidth solution.
- By default, network policies affect all connections in a namespace. However, multicast is unaffected by network policies. If multicast is enabled in the same namespace as your network policies, it is always allowed, even if there is a **deny-all** network policy. Cluster administrators should consider the implications to the exemption of multicast from network policies before enabling it.

Multicast traffic between OpenShift Container Platform pods is disabled by default. If you are using the OVN-Kubernetes network plugin, you can enable multicast on a per-project basis.

28.21.2. Enabling multicast between pods

You can enable multicast between pods for your project.

Prerequisites

- Install the OpenShift CLI (**oc**).
- You must log in to the cluster with a user that has the **cluster-admin** role.

Procedure

- Run the following command to enable multicast for a project. Replace **<namespace>** with the namespace for the project you want to enable multicast for.

```
$ oc annotate namespace <namespace> \
  k8s.ovn.org/multicast-enabled=true
```

TIP

You can alternatively apply the following YAML to add the annotation:

```
apiVersion: v1
kind: Namespace
metadata:
  name: <namespace>
  annotations:
    k8s.ovn.org/multicast-enabled: "true"
```

Verification

To verify that multicast is enabled for a project, complete the following procedure:

1. Change your current project to the project that you enabled multicast for. Replace **<project>** with the project name.

```
$ oc project <project>
```

2. Create a pod to act as a multicast receiver:

```
$ cat <<EOF | oc create -f -
apiVersion: v1
kind: Pod
metadata:
  name: mlistener
  labels:
    app: multicast-verify
spec:
  containers:
  - name: mlistener
```

```

image: registry.access.redhat.com/ubi9
command: ["/bin/sh", "-c"]
args:
  ["dnf -y install socat hostname && sleep inf"]
ports:
  - containerPort: 30102
    name: mlistener
    protocol: UDP
EOF

```

3. Create a pod to act as a multicast sender:

```

$ cat <<EOF | oc create -f -
apiVersion: v1
kind: Pod
metadata:
  name: msender
  labels:
    app: multicast-verify
spec:
  containers:
  - name: msender
    image: registry.access.redhat.com/ubi9
    command: ["/bin/sh", "-c"]
    args:
      ["dnf -y install socat && sleep inf"]
EOF

```

4. In a new terminal window or tab, start the multicast listener.

- a. Get the IP address for the Pod:

```
$ POD_IP=$(oc get pods mlistener -o jsonpath='{.status.podIP}')
```

- b. Start the multicast listener by entering the following command:

```
$ oc exec mlistener -i -t -- \
  socat UDP4-RECVFROM:30102,ip-add-membership=224.1.0.1:$POD_IP,fork
  EXEC:hostname

```

5. Start the multicast transmitter.

- a. Get the pod network IP address range:

```
$ CIDR=$(oc get Network.config.openshift.io cluster \
  -o jsonpath='{.status.clusterNetwork[0].cidr}')
```

- b. To send a multicast message, enter the following command:

```
$ oc exec msender -i -t -- \
  /bin/bash -c "echo | socat STDIO UDP4-
  DATAGRAM:224.1.0.1:30102,range=$CIDR,ip-multicast-ttl=64"

```

If multicast is working, the previous command returns the following output:

mlistener

28.22. DISABLING MULTICAST FOR A PROJECT

28.22.1. Disabling multicast between pods

You can disable multicast between pods for your project.

Prerequisites

- Install the OpenShift CLI (**oc**).
- You must log in to the cluster with a user that has the **cluster-admin** role.

Procedure

- Disable multicast by running the following command:

```
$ oc annotate namespace <namespace> \ 1
k8s.ovn.org/multicast-enabled-
```

- 1 The **namespace** for the project you want to disable multicast for.

TIP

You can alternatively apply the following YAML to delete the annotation:

```
apiVersion: v1
kind: Namespace
metadata:
  name: <namespace>
  annotations:
    k8s.ovn.org/multicast-enabled: null
```

28.23. TRACKING NETWORK FLOWS

As a cluster administrator, you can collect information about pod network flows from your cluster to assist with the following areas:

- Monitor ingress and egress traffic on the pod network.
- Troubleshoot performance issues.
- Gather data for capacity planning and security audits.

When you enable the collection of the network flows, only the metadata about the traffic is collected. For example, packet data is not collected, but the protocol, source address, destination address, port numbers, number of bytes, and other packet-level information is collected.

The data is collected in one or more of the following record formats:

- NetFlow
- sFlow
- IPFIX

When you configure the Cluster Network Operator (CNO) with one or more collector IP addresses and port numbers, the Operator configures Open vSwitch (OVS) on each node to send the network flows records to each collector.

You can configure the Operator to send records to more than one type of network flow collector. For example, you can send records to NetFlow collectors and also send records to sFlow collectors.

When OVS sends data to the collectors, each type of collector receives identical records. For example, if you configure two NetFlow collectors, OVS on a node sends identical records to the two collectors. If you also configure two sFlow collectors, the two sFlow collectors receive identical records. However, each collector type has a unique record format.

Collecting the network flows data and sending the records to collectors affects performance. Nodes process packets at a slower rate. If the performance impact is too great, you can delete the destinations for collectors to disable collecting network flows data and restore performance.



NOTE

Enabling network flow collectors might have an impact on the overall performance of the cluster network.

28.23.1. Network object configuration for tracking network flows

The fields for configuring network flows collectors in the Cluster Network Operator (CNO) are shown in the following table:

Table 28.17. Network flows configuration

| Field | Type | Description |
|---|---------------|--|
| metadata.name | string | The name of the CNO object. This name is always cluster . |
| spec.exportNetworkFlows | object | One or more of netFlow , sFlow , or ipfix . |
| spec.exportNetworkFlows.netFlow.collectors | array | A list of IP address and network port pairs for up to 10 collectors. |
| spec.exportNetworkFlows.sFlow.collectors | array | A list of IP address and network port pairs for up to 10 collectors. |
| spec.exportNetworkFlows.ipfix.collectors | array | A list of IP address and network port pairs for up to 10 collectors. |

After applying the following manifest to the CNO, the Operator configures Open vSwitch (OVS) on each node in the cluster to send network flows records to the NetFlow collector that is listening at **192.168.1.99:2056**.

Example configuration for tracking network flows

```
apiVersion: operator.openshift.io/v1
kind: Network
metadata:
  name: cluster
spec:
  exportNetworkFlows:
    netFlow:
      collectors:
        - 192.168.1.99:2056
```

28.23.2. Adding destinations for network flows collectors

As a cluster administrator, you can configure the Cluster Network Operator (CNO) to send network flows metadata about the pod network to a network flows collector.

Prerequisites

- You installed the OpenShift CLI (**oc**).
- You are logged in to the cluster with a user with **cluster-admin** privileges.
- You have a network flows collector and know the IP address and port that it listens on.

Procedure

1. Create a patch file that specifies the network flows collector type and the IP address and port information of the collectors:

```
spec:
  exportNetworkFlows:
    netFlow:
      collectors:
        - 192.168.1.99:2056
```

2. Configure the CNO with the network flows collectors:

```
$ oc patch network.operator cluster --type merge -p "$(cat <file_name>.yaml)"
```

Example output

```
network.operator.openshift.io/cluster patched
```

Verification

Verification is not typically necessary. You can run the following command to confirm that Open vSwitch (OVS) on each node is configured to send network flows records to one or more collectors.

1. View the Operator configuration to confirm that the **exportNetworkFlows** field is configured:

```
$ oc get network.operator cluster -o jsonpath="{.spec.exportNetworkFlows}"
```

Example output

```
{"netFlow":{"collectors":["192.168.1.99:2056"]}}
```

- View the network flows configuration in OVS from each node:

```
$ for pod in $(oc get pods -n openshift-ovn-kubernetes -l app=ovnkube-node -o
jsonpath='{range@.items[*]}{.metadata.name}{ "\n"}{end}');
do ;
echo;
echo $pod;
oc -n openshift-ovn-kubernetes exec -c ovnkube-controller $pod \
-- bash -c 'for type in ipfix sflow netflow ; do ovs-vsctl find $type ; done';
done
```

Example output

```
ovnkube-node-xrn4p
__uuid          : a4d2aaca-5023-4f3d-9400-7275f92611f9
active_timeout  : 60
add_id_to_interface : false
engine_id       : []
engine_type     : []
external_ids    : {}
targets        : ["192.168.1.99:2056"]

ovnkube-node-z4vq9
__uuid          : 61d02fdb-9228-4993-8ff5-b27f01a29bd6
active_timeout  : 60
add_id_to_interface : false
engine_id       : []
engine_type     : []
external_ids    : {}
targets        : ["192.168.1.99:2056"]-
...

```

28.23.3. Deleting all destinations for network flows collectors

As a cluster administrator, you can configure the Cluster Network Operator (CNO) to stop sending network flows metadata to a network flows collector.

Prerequisites

- You installed the OpenShift CLI (**oc**).
- You are logged in to the cluster with a user with **cluster-admin** privileges.

Procedure

- Remove all network flows collectors:

```
$ oc patch network.operator cluster --type='json' \
  -p='[{"op":"remove", "path":"/spec/exportNetworkFlows"}]'
```

Example output

```
network.operator.openshift.io/cluster patched
```

28.23.4. Additional resources

- [Network \[operator.openshift.io/v1\]](https://operator.openshift.io/v1)

28.24. CONFIGURING HYBRID NETWORKING

As a cluster administrator, you can configure the Red Hat OpenShift Networking OVN-Kubernetes network plugin to allow Linux and Windows nodes to host Linux and Windows workloads, respectively.

28.24.1. Configuring hybrid networking with OVN-Kubernetes

You can configure your cluster to use hybrid networking with the OVN-Kubernetes network plugin. This allows a hybrid cluster that supports different node networking configurations.



NOTE

This configuration is necessary to run both Linux and Windows nodes in the same cluster.

Prerequisites

- Install the OpenShift CLI (**oc**).
- Log in to the cluster with a user with **cluster-admin** privileges.
- Ensure that the cluster uses the OVN-Kubernetes network plugin.

Procedure

1. To configure the OVN-Kubernetes hybrid network overlay, enter the following command:

```
$ oc patch networks.operator.openshift.io cluster --type=merge \
  -p '{
  "spec":{
    "defaultNetwork":{
      "ovnKubernetesConfig":{
        "hybridOverlayConfig":{
          "hybridClusterNetwork":[
            {
              "cidr": "<cidr>",
              "hostPrefix": <prefix>
            }
          ],
          "hybridOverlayVXLANPort": <overlay_port>
        }
      }
    }
  }
}
```

```

    }
  }
}'

```

where:

cidr

Specify the CIDR configuration used for nodes on the additional overlay network. This CIDR cannot overlap with the cluster network CIDR.

hostPrefix

Specifies the subnet prefix length to assign to each individual node. For example, if **hostPrefix** is set to **23**, then each node is assigned a **/23** subnet out of the given **cidr**, which allows for 510 ($2^{(32 - 23)} - 2$) pod IP addresses. If you are required to provide access to nodes from an external network, configure load balancers and routers to manage the traffic.

hybridOverlayVXLANPort

Specify a custom VXLAN port for the additional overlay network. This is required for running Windows nodes in a cluster installed on vSphere, and must not be configured for any other cloud provider. The custom port can be any open port excluding the default **4789** port. For more information on this requirement, see the Microsoft documentation on [Pod-to-pod connectivity between hosts is broken](#).



NOTE

Windows Server Long-Term Servicing Channel (LTSC): Windows Server 2019 is not supported on clusters with a custom **hybridOverlayVXLANPort** value because this Windows server version does not support selecting a custom VXLAN port.

Example output

```
network.operator.openshift.io/cluster patched
```

2. To confirm that the configuration is active, enter the following command. It can take several minutes for the update to apply.

```
$ oc get network.operator.openshift.io -o jsonpath="{.items[0].spec.defaultNetwork.ovnKubernetesConfig}"
```

28.24.2. Additional resources

- [Understanding Windows container workloads](#)
- [Enabling Windows container workloads](#)
- [Installing a cluster on AWS with network customizations](#)
- [Installing a cluster on Azure with network customizations](#)

CHAPTER 29. OPENSIFT SDN NETWORK PLUGIN

29.1. ABOUT THE OPENSIFT SDN NETWORK PLUGIN

Part of Red Hat OpenShift Networking, OpenShift SDN is a network plugin that uses a software-defined networking (SDN) approach to provide a unified cluster network that enables communication between pods across the OpenShift Container Platform cluster. This pod network is established and maintained by OpenShift SDN, which configures an overlay network using Open vSwitch (OVS).



NOTE

OpenShift SDN CNI is deprecated as of OpenShift Container Platform 4.14. As of OpenShift Container Platform 4.15, the network plugin is not an option for new installations. In a subsequent future release, the OpenShift SDN network plugin is planned to be removed and no longer supported. Red Hat will provide bug fixes and support for this feature until it is removed, but this feature will no longer receive enhancements. As an alternative to OpenShift SDN CNI, you can use OVN Kubernetes CNI instead.

29.1.1. OpenShift SDN network isolation modes

OpenShift SDN provides three SDN modes for configuring the pod network:

- *Network policy* mode allows project administrators to configure their own isolation policies using **NetworkPolicy** objects. Network policy is the default mode in OpenShift Container Platform 4.15.
- *Multitenant* mode provides project-level isolation for pods and services. Pods from different projects cannot send packets to or receive packets from pods and services of a different project. You can disable isolation for a project, allowing it to send network traffic to all pods and services in the entire cluster and receive network traffic from those pods and services.
- *Subnet* mode provides a flat pod network where every pod can communicate with every other pod and service. The network policy mode provides the same functionality as subnet mode.

29.1.2. Supported network plugin feature matrix

Red Hat OpenShift Networking offers two options for the network plugin, OpenShift SDN and OVN-Kubernetes, for the network plugin. The following table summarizes the current feature support for both network plugins:

Table 29.1. Default CNI network plugin feature comparison

| Feature | OpenShift SDN | OVN-Kubernetes |
|--------------------------------|---------------|--------------------------|
| Egress IPs | Supported | Supported |
| Egress firewall ^[1] | Supported | Supported |
| Egress router | Supported | Supported ^[2] |
| Hybrid networking | Not supported | Supported |

| Feature | OpenShift SDN | OVN-Kubernetes |
|--------------------------------|---------------|---|
| IPsec encryption | Not supported | Supported |
| IPv6 | Not supported | Supported ^[3] ^[4] |
| Kubernetes network policy | Supported | Supported |
| Kubernetes network policy logs | Not supported | Supported |
| Multicast | Supported | Supported |
| Hardware offloading | Not supported | Supported |

1. Egress firewall is also known as egress network policy in OpenShift SDN. This is not the same as network policy egress.
2. Egress router for OVN-Kubernetes supports only redirect mode.
3. IPv6 is supported only on bare metal, vSphere, IBM Power®, IBM Z®, and Red Hat OpenStack clusters.
4. IPv6 single stack is not supported on IBM Power®, IBM Z®, and Red Hat OpenStack clusters.

29.2. CONFIGURING EGRESS IPS FOR A PROJECT

As a cluster administrator, you can configure the OpenShift SDN Container Network Interface (CNI) network plugin to assign one or more egress IP addresses to a project.



NOTE

OpenShift SDN CNI is deprecated as of OpenShift Container Platform 4.14. As of OpenShift Container Platform 4.15, the network plugin is not an option for new installations. In a subsequent future release, the OpenShift SDN network plugin is planned to be removed and no longer supported. Red Hat will provide bug fixes and support for this feature until it is removed, but this feature will no longer receive enhancements. As an alternative to OpenShift SDN CNI, you can use OVN Kubernetes CNI instead.

29.2.1. Egress IP address architectural design and implementation

The OpenShift Container Platform egress IP address functionality allows you to ensure that the traffic from one or more pods in one or more namespaces has a consistent source IP address for services outside the cluster network.

For example, you might have a pod that periodically queries a database that is hosted on a server outside of your cluster. To enforce access requirements for the server, a packet filtering device is configured to allow traffic only from specific IP addresses. To ensure that you can reliably allow access to the server from only that specific pod, you can configure a specific egress IP address for the pod that makes the requests to the server.

An egress IP address assigned to a namespace is different from an egress router, which is used to send traffic to specific destinations.

In some cluster configurations, application pods and ingress router pods run on the same node. If you configure an egress IP address for an application project in this scenario, the IP address is not used when you send a request to a route from the application project.

An egress IP address is implemented as an additional IP address on the primary network interface of a node and must be in the same subnet as the primary IP address of the node. The additional IP address must not be assigned to any other node in the cluster.



IMPORTANT

Egress IP addresses must not be configured in any Linux network configuration files, such as **ifcfg-eth0**.

29.2.1.1. Platform support

Support for the egress IP address functionality on various platforms is summarized in the following table:

| Platform | Supported |
|--|-----------|
| Bare metal | Yes |
| VMware vSphere | Yes |
| Red Hat OpenStack Platform (RHOSP) | Yes |
| Amazon Web Services (AWS) | Yes |
| Google Cloud Platform (GCP) | Yes |
| Microsoft Azure | Yes |
| IBM Z [®] and IBM [®] LinuxONE | Yes |
| IBM Z [®] and IBM [®] LinuxONE for Red Hat Enterprise Linux (RHEL) KVM | Yes |
| IBM Power [®] | Yes |
| Nutanix | Yes |



IMPORTANT

The assignment of egress IP addresses to control plane nodes with the EgressIP feature is not supported on a cluster provisioned on Amazon Web Services (AWS). ([BZ#2039656](#)).

29.2.1.2. Public cloud platform considerations

For clusters provisioned on public cloud infrastructure, there is a constraint on the absolute number of assignable IP addresses per node. The maximum number of assignable IP addresses per node, or the *IP capacity*, can be described in the following formula:

$$\text{IP capacity} = \text{public cloud default capacity} - \text{sum}(\text{current IP assignments})$$

While the Egress IPs capability manages the IP address capacity per node, it is important to plan for this constraint in your deployments. For example, for a cluster installed on bare-metal infrastructure with 8 nodes you can configure 150 egress IP addresses. However, if a public cloud provider limits IP address capacity to 10 IP addresses per node, the total number of assignable IP addresses is only 80. To achieve the same IP address capacity in this example cloud provider, you would need to allocate 7 additional nodes.

To confirm the IP capacity and subnets for any node in your public cloud environment, you can enter the **oc get node <node_name> -o yaml** command. The **cloud.network.openshift.io/egress-ipconfig** annotation includes capacity and subnet information for the node.

The annotation value is an array with a single object with fields that provide the following information for the primary network interface:

- **interface:** Specifies the interface ID on AWS and Azure and the interface name on GCP.
- **ifaddr:** Specifies the subnet mask for one or both IP address families.
- **capacity:** Specifies the IP address capacity for the node. On AWS, the IP address capacity is provided per IP address family. On Azure and GCP, the IP address capacity includes both IPv4 and IPv6 addresses.

Automatic attachment and detachment of egress IP addresses for traffic between nodes are available. This allows for traffic from many pods in namespaces to have a consistent source IP address to locations outside of the cluster. This also supports OpenShift SDN and OVN-Kubernetes, which is the default networking plugin in Red Hat OpenShift Networking in OpenShift Container Platform 4.15.



NOTE

The RHOSP egress IP address feature creates a Neutron reservation port called **egressip-<IP address>**. Using the same RHOSP user as the one used for the OpenShift Container Platform cluster installation, you can assign a floating IP address to this reservation port to have a predictable SNAT address for egress traffic. When an egress IP address on an RHOSP network is moved from one node to another, because of a node failover, for example, the Neutron reservation port is removed and recreated. This means that the floating IP association is lost and you need to manually reassign the floating IP address to the new reservation port.



NOTE

When an RHOSP cluster administrator assigns a floating IP to the reservation port, OpenShift Container Platform cannot delete the reservation port. The **CloudPrivateIPConfig** object cannot perform delete and move operations until an RHOSP cluster administrator unassigns the floating IP from the reservation port.

The following examples illustrate the annotation from nodes on several public cloud providers. The annotations are indented for readability.

Example cloud.network.openshift.io/egress-ipconfig annotation on AWS

```
cloud.network.openshift.io/egress-ipconfig: [
  {
    "interface":"eni-078d267045138e436",
    "ifaddr":{"ipv4":"10.0.128.0/18"},
    "capacity":{"ipv4":14,"ipv6":15}
  }
]
```

Example cloud.network.openshift.io/egress-ipconfig annotation on GCP

```
cloud.network.openshift.io/egress-ipconfig: [
  {
    "interface":"nic0",
    "ifaddr":{"ipv4":"10.0.128.0/18"},
    "capacity":{"ip":14}
  }
]
```

The following sections describe the IP address capacity for supported public cloud environments for use in your capacity calculation.

29.2.1.2.1. Amazon Web Services (AWS) IP address capacity limits

On AWS, constraints on IP address assignments depend on the instance type configured. For more information, see [IP addresses per network interface per instance type](#)

29.2.1.2.2. Google Cloud Platform (GCP) IP address capacity limits

On GCP, the networking model implements additional node IP addresses through IP address aliasing, rather than IP address assignments. However, IP address capacity maps directly to IP aliasing capacity.

The following capacity limits exist for IP aliasing assignment:

- Per node, the maximum number of IP aliases, both IPv4 and IPv6, is 100.
- Per VPC, the maximum number of IP aliases is unspecified, but OpenShift Container Platform scalability testing reveals the maximum to be approximately 15,000.

For more information, see [Per instance quotas](#) and [Alias IP ranges overview](#).

29.2.1.2.3. Microsoft Azure IP address capacity limits

On Azure, the following capacity limits exist for IP address assignment:

- Per NIC, the maximum number of assignable IP addresses, for both IPv4 and IPv6, is 256.
- Per virtual network, the maximum number of assigned IP addresses cannot exceed 65,536.

For more information, see [Networking limits](#).

29.2.1.3. Considerations for using an egress IP on additional network interfaces

In OpenShift Container Platform, egress IPs provide administrators a way to control network traffic. Egress IPs can be used with the **br-ex**, or primary, network interface, which is a Linux bridge interface associated with Open vSwitch, or they can be used with additional network interfaces.

You can inspect your network interface type by running the following command:

```
$ ip -details link show
```

The primary network interface is assigned a node IP address which also contains a subnet mask. Information for this node IP address can be retrieved from the Kubernetes node object for each node within your cluster by inspecting the **k8s.ovn.org/node-primary-ifaddr** annotation. In an IPv4 cluster, this annotation is similar to the following example: "**k8s.ovn.org/node-primary-ifaddr: {"ipv4": "192.168.111.23/24"}**".

If the egress IP is not within the subnet of the primary network interface subnet, you can use an egress IP on another Linux network interface that is not of the primary network interface type. By doing so, OpenShift Container Platform administrators are provided with a greater level of control over networking aspects such as routing, addressing, segmentation, and security policies. This feature provides users with the option to route workload traffic over specific network interfaces for purposes such as traffic segmentation or meeting specialized requirements.

If the egress IP is not within the subnet of the primary network interface, then the selection of another network interface for egress traffic might occur if they are present on a node.

You can determine which other network interfaces might support egress IPs by inspecting the **k8s.ovn.org/host-cidrs** Kubernetes node annotation. This annotation contains the addresses and subnet mask found for the primary network interface. It also contains additional network interface addresses and subnet mask information. These addresses and subnet masks are assigned to network interfaces that use the [longest prefix match routing](#) mechanism to determine which network interface supports the egress IP.

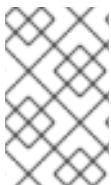

NOTE

OVN-Kubernetes provides a mechanism to control and direct outbound network traffic from specific namespaces and pods. This ensures that it exits the cluster through a particular network interface and with a specific egress IP address.

Requirements for assigning an egress IP to a network interface that is not the primary network interface

For users who want an egress IP and traffic to be routed over a particular interface that is not the primary network interface, the following conditions must be met:

- OpenShift Container Platform is installed on a bare metal cluster. This feature is disabled within cloud or hypervisor environments.
- Your OpenShift Container Platform pods are not configured as host-networked.
- If a network interface is removed or if the IP address and subnet mask which allows the egress IP to be hosted on the interface is removed, then the egress IP is reconfigured. Consequently, it could be assigned to another node and interface.
- The Egress IP must be IPv4. IPv6 is currently unsupported.
- IP forwarding must be enabled for the network interface. To enable IP forwarding, you can use the **oc edit network.operator** command and edit the object like the following example:

■

```
# ...
spec:
  clusterNetwork:
    - cidr: 10.128.0.0/14
      hostPrefix: 23
  defaultNetwork:
    ovnKubernetesConfig:
      gatewayConfig:
        ipForwarding: Global
# ...
```

== Limitations

The following limitations apply when using egress IP addresses with the OpenShift SDN network plugin:

- You cannot use manually assigned and automatically assigned egress IP addresses on the same nodes.
- If you manually assign egress IP addresses from an IP address range, you must not make that range available for automatic IP assignment.
- You cannot share egress IP addresses across multiple namespaces using the OpenShift SDN egress IP address implementation.

If you need to share IP addresses across namespaces, the OVN-Kubernetes network plugin egress IP address implementation allows you to span IP addresses across multiple namespaces.



NOTE

If you use OpenShift SDN in multitenant mode, you cannot use egress IP addresses with any namespace that is joined to another namespace by the projects that are associated with them. For example, if **project1** and **project2** are joined by running the **oc adm pod-network join-projects --to=project1 project2** command, neither project can use an egress IP address. For more information, see [BZ#1645577](#).

29.2.1.4. IP address assignment approaches

You can assign egress IP addresses to namespaces by setting the **egressIPs** parameter of the **NetNamespace** object. After an egress IP address is associated with a project, OpenShift SDN allows you to assign egress IP addresses to hosts in two ways:

- In the *automatically assigned* approach, an egress IP address range is assigned to a node.
- In the *manually assigned* approach, a list of one or more egress IP address is assigned to a node.

Namespaces that request an egress IP address are matched with nodes that can host those egress IP addresses, and then the egress IP addresses are assigned to those nodes. If the **egressIPs** parameter is set on a **NetNamespace** object, but no node hosts that egress IP address, then egress traffic from the namespace will be dropped.

High availability of nodes is automatic. If a node that hosts an egress IP address is unreachable and there are nodes that are able to host that egress IP address, then the egress IP address will move to a new node. When the unreachable node comes back online, the egress IP address automatically moves to balance egress IP addresses across nodes.

29.2.1.4.1. Considerations when using automatically assigned egress IP addresses

When using the automatic assignment approach for egress IP addresses the following considerations apply:

- You set the **egressCIDRs** parameter of each node's **HostSubnet** resource to indicate the range of egress IP addresses that can be hosted by a node. OpenShift Container Platform sets the **egressIPs** parameter of the **HostSubnet** resource based on the IP address range you specify.

If the node hosting the namespace's egress IP address is unreachable, OpenShift Container Platform will reassign the egress IP address to another node with a compatible egress IP address range. The automatic assignment approach works best for clusters installed in environments with flexibility in associating additional IP addresses with nodes.

29.2.1.4.2. Considerations when using manually assigned egress IP addresses

This approach allows you to control which nodes can host an egress IP address.



NOTE

If your cluster is installed on public cloud infrastructure, you must ensure that each node that you assign egress IP addresses to has sufficient spare capacity to host the IP addresses. For more information, see "Platform considerations" in a previous section.

When using the manual assignment approach for egress IP addresses the following considerations apply:

- You set the **egressIPs** parameter of each node's **HostSubnet** resource to indicate the IP addresses that can be hosted by a node.
- Multiple egress IP addresses per namespace are supported.

If a namespace has multiple egress IP addresses and those addresses are hosted on multiple nodes, the following additional considerations apply:

- If a pod is on a node that is hosting an egress IP address, that pod always uses the egress IP address on the node.
- If a pod is not on a node that is hosting an egress IP address, that pod uses an egress IP address at random.

29.2.2. Configuring automatically assigned egress IP addresses for a namespace

In OpenShift Container Platform you can enable automatic assignment of an egress IP address for a specific namespace across one or more nodes.

Prerequisites

- You have access to the cluster as a user with the **cluster-admin** role.
- You have installed the OpenShift CLI (**oc**).

Procedure

1. Update the **NetNamespace** object with the egress IP address using the following JSON:

```
$ oc patch netnamespace <project_name> --type=merge -p \
```

```
{
  "egressIPs": [
    "<ip_address>"
  ]
}
```

where:

<project_name>

Specifies the name of the project.

<ip_address>

Specifies one or more egress IP addresses for the **egressIPs** array.

For example, to assign **project1** to an IP address of 192.168.1.100 and **project2** to an IP address of 192.168.1.101:

```
$ oc patch netnamespace project1 --type=merge -p \
  '{"egressIPs": ["192.168.1.100"]}'
$ oc patch netnamespace project2 --type=merge -p \
  '{"egressIPs": ["192.168.1.101"]}'
```



NOTE

Because OpenShift SDN manages the **NetNamespace** object, you can make changes only by modifying the existing **NetNamespace** object. Do not create a new **NetNamespace** object.

2. Indicate which nodes can host egress IP addresses by setting the **egressCIDRs** parameter for each host using the following JSON:

```
$ oc patch hostsubnet <node_name> --type=merge -p \
  {
    "egressCIDRs": [
      "<ip_address_range>", "<ip_address_range>"
    ]
  }
```

where:

<node_name>

Specifies a node name.

<ip_address_range>

Specifies an IP address range in CIDR format. You can specify more than one address range for the **egressCIDRs** array.

For example, to set **node1** and **node2** to host egress IP addresses in the range 192.168.1.0 to 192.168.1.255:

```
$ oc patch hostsubnet node1 --type=merge -p \
  '{"egressCIDRs": ["192.168.1.0/24"]}'
$ oc patch hostsubnet node2 --type=merge -p \
  '{"egressCIDRs": ["192.168.1.0/24"]}'
```

OpenShift Container Platform automatically assigns specific egress IP addresses to available nodes in a balanced way. In this case, it assigns the egress IP address 192.168.1.100 to **node1** and the egress IP address 192.168.1.101 to **node2** or vice versa.

29.2.3. Configuring manually assigned egress IP addresses for a namespace

In OpenShift Container Platform you can associate one or more egress IP addresses with a namespace.

Prerequisites

- You have access to the cluster as a user with the **cluster-admin** role.
- You have installed the OpenShift CLI (**oc**).

Procedure

1. Update the **NetNamespace** object by specifying the following JSON object with the desired IP addresses:

```
$ oc patch netnamespace <project_name> --type=merge -p \
  '{
    "egressIPs": [
      "<ip_address>"
    ]
  }'
```

where:

<project_name>

Specifies the name of the project.

<ip_address>

Specifies one or more egress IP addresses for the **egressIPs** array.

For example, to assign the **project1** project to the IP addresses **192.168.1.100** and **192.168.1.101**:

```
$ oc patch netnamespace project1 --type=merge \
  -p '{"egressIPs": ["192.168.1.100","192.168.1.101"]}'
```

To provide high availability, set the **egressIPs** value to two or more IP addresses on different nodes. If multiple egress IP addresses are set, then pods use all egress IP addresses roughly equally.



NOTE

Because OpenShift SDN manages the **NetNamespace** object, you can make changes only by modifying the existing **NetNamespace** object. Do not create a new **NetNamespace** object.

2. Manually assign the egress IP address to the node hosts.
If your cluster is installed on public cloud infrastructure, you must confirm that the node has available IP address capacity.

Set the **egressIPs** parameter on the **HostSubnet** object on the node host. Using the following JSON, include as many IP addresses as you want to assign to that node host:

```
$ oc patch hostsubnet <node_name> --type=merge -p \
  {
    "egressIPs": [
      "<ip_address>",
      "<ip_address>"
    ]
  }
```

where:

<node_name>

Specifies a node name.

<ip_address>

Specifies an IP address. You can specify more than one IP address for the **egressIPs** array.

For example, to specify that **node1** should have the egress IPs **192.168.1.100**, **192.168.1.101**, and **192.168.1.102**:

```
$ oc patch hostsubnet node1 --type=merge -p \
  '{"egressIPs": ["192.168.1.100", "192.168.1.101", "192.168.1.102"]}'
```

In the previous example, all egress traffic for **project1** will be routed to the node hosting the specified egress IP, and then connected through Network Address Translation (NAT) to that IP address.

29.2.4. Additional resources

- If you are configuring manual egress IP address assignment, see [Platform considerations](#) for information about IP capacity planning.

29.3. CONFIGURING AN EGRESS FIREWALL FOR A PROJECT

As a cluster administrator, you can create an egress firewall for a project that restricts egress traffic leaving your OpenShift Container Platform cluster.



NOTE

OpenShift SDN CNI is deprecated as of OpenShift Container Platform 4.14. As of OpenShift Container Platform 4.15, the network plugin is not an option for new installations. In a subsequent future release, the OpenShift SDN network plugin is planned to be removed and no longer supported. Red Hat will provide bug fixes and support for this feature until it is removed, but this feature will no longer receive enhancements. As an alternative to OpenShift SDN CNI, you can use OVN Kubernetes CNI instead.

29.3.1. How an egress firewall works in a project

As a cluster administrator, you can use an *egress firewall* to limit the external hosts that some or all pods can access from within the cluster. An egress firewall supports the following scenarios:

- A pod can only connect to internal hosts and cannot initiate connections to the public internet.

- A pod can only connect to the public internet and cannot initiate connections to internal hosts that are outside the OpenShift Container Platform cluster.
- A pod cannot reach specified internal subnets or hosts outside the OpenShift Container Platform cluster.
- A pod can connect to only specific external hosts.

For example, you can allow one project access to a specified IP range but deny the same access to a different project. Or you can restrict application developers from updating from Python pip mirrors, and force updates to come only from approved sources.

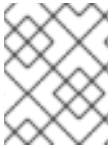
**NOTE**

Egress firewall does not apply to the host network namespace. Pods with host networking enabled are unaffected by egress firewall rules.

You configure an egress firewall policy by creating an `EgressNetworkPolicy` custom resource (CR) object. The egress firewall matches network traffic that meets any of the following criteria:

- An IP address range in CIDR format
- A DNS name that resolves to an IP address

IMPORTANT

If your egress firewall includes a deny rule for **0.0.0.0/0**, access to your OpenShift Container Platform API servers is blocked. You must either add allow rules for each IP address or use the **nodeSelector** type allow rule in your egress policy rules to connect to API servers.

The following example illustrates the order of the egress firewall rules necessary to ensure API server access:

```
apiVersion: network.openshift.io/v1
kind: EgressNetworkPolicy
metadata:
  name: default
  namespace: <namespace> 1
spec:
  egress:
  - to:
    cidrSelector: <api_server_address_range> 2
    type: Allow
  # ...
  - to:
    cidrSelector: 0.0.0.0/0 3
    type: Deny
```

- 1** The namespace for the egress firewall.
- 2** The IP address range that includes your OpenShift Container Platform API servers.
- 3** A global deny rule prevents access to the OpenShift Container Platform API servers.

To find the IP address for your API servers, run **oc get ep kubernetes -n default**.

For more information, see [BZ#1988324](#).

IMPORTANT

You must have OpenShift SDN configured to use either the network policy or multitenant mode to configure an egress firewall.

If you use network policy mode, an egress firewall is compatible with only one policy per namespace and will not work with projects that share a network, such as global projects.

**WARNING**

Egress firewall rules do not apply to traffic that goes through routers. Any user with permission to create a Route CR object can bypass egress firewall policy rules by creating a route that points to a forbidden destination.

29.3.1.1. Limitations of an egress firewall

An egress firewall has the following limitations:

- No project can have more than one EgressNetworkPolicy object.

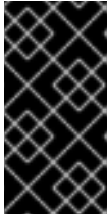

IMPORTANT

The creation of more than one EgressNetworkPolicy object is allowed, however it should not be done. When you create more than one EgressNetworkPolicy object, the following message is returned: **dropping all rules**. In actuality, all external traffic is dropped, which can cause security risks for your organization.

- A maximum of one EgressNetworkPolicy object with a maximum of 1,000 rules can be defined per project.
- The **default** project cannot use an egress firewall.
- When using the OpenShift SDN network plugin in multitenant mode, the following limitations apply:
 - Global projects cannot use an egress firewall. You can make a project global by using the **oc adm pod-network make-projects-global** command.
 - Projects merged by using the **oc adm pod-network join-projects** command cannot use an egress firewall in any of the joined projects.

Violating any of these restrictions results in a broken egress firewall for the project. Consequently, all external network traffic is dropped, which can cause security risks for your organization.

An Egress Firewall resource can be created in the **kube-node-lease**, **kube-public**, **kube-system**, **openshift** and **openshift-** projects.

29.3.1.2. Matching order for egress firewall policy rules

The egress firewall policy rules are evaluated in the order that they are defined, from first to last. The first rule that matches an egress connection from a pod applies. Any subsequent rules are ignored for that connection.

29.3.1.3. How Domain Name Server (DNS) resolution works

If you use DNS names in any of your egress firewall policy rules, proper resolution of the domain names is subject to the following restrictions:

- Domain name updates are polled based on a time-to-live (TTL) duration. By default, the duration is 30 seconds. When the egress firewall controller queries the local name servers for a domain name, if the response includes a TTL that is less than 30 seconds, the controller sets the duration to the returned value. If the TTL in the response is greater than 30 minutes, the controller sets the duration to 30 minutes. If the TTL is between 30 seconds and 30 minutes, the controller ignores the value and sets the duration to 30 seconds.
- The pod must resolve the domain from the same local name servers when necessary. Otherwise the IP addresses for the domain known by the egress firewall controller and the pod can be different. If the IP addresses for a hostname differ, the egress firewall might not be enforced consistently.
- Because the egress firewall controller and pods asynchronously poll the same local name server, the pod might obtain the updated IP address before the egress controller does, which causes a race condition. Due to this current limitation, domain name usage in EgressNetworkPolicy objects is only recommended for domains with infrequent IP address changes.



NOTE

Using DNS names in your egress firewall policy does not affect local DNS resolution through CoreDNS.

However, if your egress firewall policy uses domain names, and an external DNS server handles DNS resolution for an affected pod, you must include egress firewall rules that permit access to the IP addresses of your DNS server.

29.3.2. EgressNetworkPolicy custom resource (CR) object

You can define one or more rules for an egress firewall. A rule is either an **Allow** rule or a **Deny** rule, with a specification for the traffic that the rule applies to.

The following YAML describes an EgressNetworkPolicy CR object:

EgressNetworkPolicy object

```
apiVersion: network.openshift.io/v1
kind: EgressNetworkPolicy
metadata:
  name: <name> 1
spec:
  egress: 2
  ...
```

- 1 A name for your egress firewall policy.
- 2 A collection of one or more egress network policy rules as described in the following section.

29.3.2.1. EgressNetworkPolicy rules

The following YAML describes an egress firewall rule object. The user can select either an IP address range in CIDR format, a domain name, or use the **nodeSelector** to allow or deny egress traffic. The **egress** stanza expects an array of one or more objects.

Egress policy rule stanza

```
egress:
- type: <type> 1
  to: 2
    cidrSelector: <cidr> 3
    dnsName: <dns_name> 4
```

- 1 The type of rule. The value must be either **Allow** or **Deny**.
- 2 A stanza describing an egress traffic match rule. A value for either the **cidrSelector** field or the **dnsName** field for the rule. You cannot use both fields in the same rule.
- 3 An IP address range in CIDR format.
- 4 A domain name.

29.3.2.2. Example EgressNetworkPolicy CR objects

The following example defines several egress firewall policy rules:

```
apiVersion: network.openshift.io/v1
kind: EgressNetworkPolicy
metadata:
  name: default
spec:
  egress: 1
  - type: Allow
    to:
      cidrSelector: 1.2.3.0/24
  - type: Allow
    to:
      dnsName: www.example.com
  - type: Deny
    to:
      cidrSelector: 0.0.0.0/0
```

1 A collection of egress firewall policy rule objects.

29.3.3. Creating an egress firewall policy object

As a cluster administrator, you can create an egress firewall policy object for a project.



IMPORTANT

If the project already has an EgressNetworkPolicy object defined, you must edit the existing policy to make changes to the egress firewall rules.

Prerequisites

- A cluster that uses the OpenShift SDN network plugin.
- Install the OpenShift CLI (**oc**).
- You must log in to the cluster as a cluster administrator.

Procedure

1. Create a policy rule:
 - a. Create a **<policy_name>.yaml** file where **<policy_name>** describes the egress policy rules.
 - b. In the file you created, define an egress policy object.
2. Enter the following command to create the policy object. Replace **<policy_name>** with the name of the policy and **<project>** with the project that the rule applies to.

```
$ oc create -f <policy_name>.yaml -n <project>
```

In the following example, a new EgressNetworkPolicy object is created in a project named **project1**:

```
$ oc create -f default.yaml -n project1
```

Example output

```
egressnetworkpolicy.network.openshift.io/v1 created
```

- Optional: Save the **<policy_name>.yaml** file so that you can make changes later.

29.4. EDITING AN EGRESS FIREWALL FOR A PROJECT

As a cluster administrator, you can modify network traffic rules for an existing egress firewall.

29.4.1. Viewing an EgressNetworkPolicy object

You can view an EgressNetworkPolicy object in your cluster.

Prerequisites

- A cluster using the OpenShift SDN network plugin.
- Install the OpenShift Command-line Interface (CLI), commonly known as **oc**.
- You must log in to the cluster.

Procedure

- Optional: To view the names of the EgressNetworkPolicy objects defined in your cluster, enter the following command:

```
$ oc get egressnetworkpolicy --all-namespaces
```

- To inspect a policy, enter the following command. Replace **<policy_name>** with the name of the policy to inspect.

```
$ oc describe egressnetworkpolicy <policy_name>
```

Example output

```
Name: default
Namespace: project1
Created: 20 minutes ago
Labels: <none>
Annotations: <none>
Rule: Allow to 1.2.3.0/24
Rule: Allow to www.example.com
Rule: Deny to 0.0.0.0/0
```

29.5. EDITING AN EGRESS FIREWALL FOR A PROJECT

As a cluster administrator, you can modify network traffic rules for an existing egress firewall.



NOTE

OpenShift SDN CNI is deprecated as of OpenShift Container Platform 4.14. As of OpenShift Container Platform 4.15, the network plugin is not an option for new installations. In a subsequent future release, the OpenShift SDN network plugin is planned to be removed and no longer supported. Red Hat will provide bug fixes and support for this feature until it is removed, but this feature will no longer receive enhancements. As an alternative to OpenShift SDN CNI, you can use OVN Kubernetes CNI instead.

29.5.1. Editing an EgressNetworkPolicy object

As a cluster administrator, you can update the egress firewall for a project.

Prerequisites

- A cluster using the OpenShift SDN network plugin.
- Install the OpenShift CLI (**oc**).
- You must log in to the cluster as a cluster administrator.

Procedure

1. Find the name of the EgressNetworkPolicy object for the project. Replace **<project>** with the name of the project.

```
$ oc get -n <project> egressnetworkpolicy
```

2. Optional: If you did not save a copy of the EgressNetworkPolicy object when you created the egress network firewall, enter the following command to create a copy.

```
$ oc get -n <project> egressnetworkpolicy <name> -o yaml > <filename>.yaml
```

Replace **<project>** with the name of the project. Replace **<name>** with the name of the object. Replace **<filename>** with the name of the file to save the YAML to.

3. After making changes to the policy rules, enter the following command to replace the EgressNetworkPolicy object. Replace **<filename>** with the name of the file containing the updated EgressNetworkPolicy object.

```
$ oc replace -f <filename>.yaml
```

29.6. REMOVING AN EGRESS FIREWALL FROM A PROJECT

As a cluster administrator, you can remove an egress firewall from a project to remove all restrictions on network traffic from the project that leaves the OpenShift Container Platform cluster.

**NOTE**

OpenShift SDN CNI is deprecated as of OpenShift Container Platform 4.14. As of OpenShift Container Platform 4.15, the network plugin is not an option for new installations. In a subsequent future release, the OpenShift SDN network plugin is planned to be removed and no longer supported. Red Hat will provide bug fixes and support for this feature until it is removed, but this feature will no longer receive enhancements. As an alternative to OpenShift SDN CNI, you can use OVN Kubernetes CNI instead.

29.6.1. Removing an EgressNetworkPolicy object

As a cluster administrator, you can remove an egress firewall from a project.

Prerequisites

- A cluster using the OpenShift SDN network plugin.
- Install the OpenShift CLI (**oc**).
- You must log in to the cluster as a cluster administrator.

Procedure

1. Find the name of the EgressNetworkPolicy object for the project. Replace **<project>** with the name of the project.

```
$ oc get -n <project> egressnetworkpolicy
```

2. Enter the following command to delete the EgressNetworkPolicy object. Replace **<project>** with the name of the project and **<name>** with the name of the object.

```
$ oc delete -n <project> egressnetworkpolicy <name>
```

29.7. CONSIDERATIONS FOR THE USE OF AN EGRESS ROUTER POD

29.7.1. About an egress router pod

The OpenShift Container Platform egress router pod redirects traffic to a specified remote server from a private source IP address that is not used for any other purpose. An egress router pod can send network traffic to servers that are set up to allow access only from specific IP addresses.

**NOTE**

The egress router pod is not intended for every outgoing connection. Creating large numbers of egress router pods can exceed the limits of your network hardware. For example, creating an egress router pod for every project or application could exceed the number of local MAC addresses that the network interface can handle before reverting to filtering MAC addresses in software.

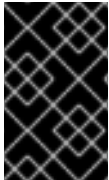

IMPORTANT

The egress router image is not compatible with Amazon AWS, Azure Cloud, or any other cloud platform that does not support layer 2 manipulations due to their incompatibility with macvlan traffic.

29.7.1.1. Egress router modes

In *redirect mode*, an egress router pod configures **iptables** rules to redirect traffic from its own IP address to one or more destination IP addresses. Client pods that need to use the reserved source IP address must be configured to access the service for the egress router rather than connecting directly to the destination IP. You can access the destination service and port from the application pod by using the **curl** command. For example:

```
$ curl <router_service_IP> <port>
```

In *HTTP proxy mode*, an egress router pod runs as an HTTP proxy on port **8080**. This mode only works for clients that are connecting to HTTP-based or HTTPS-based services, but usually requires fewer changes to the client pods to get them to work. Many programs can be told to use an HTTP proxy by setting an environment variable.

In *DNS proxy mode*, an egress router pod runs as a DNS proxy for TCP-based services from its own IP address to one or more destination IP addresses. To make use of the reserved, source IP address, client pods must be modified to connect to the egress router pod rather than connecting directly to the destination IP address. This modification ensures that external destinations treat traffic as though it were coming from a known source.

Redirect mode works for all services except for HTTP and HTTPS. For HTTP and HTTPS services, use HTTP proxy mode. For TCP-based services with IP addresses or domain names, use DNS proxy mode.

29.7.1.2. Egress router pod implementation

The egress router pod setup is performed by an initialization container. That container runs in a privileged context so that it can configure the macvlan interface and set up **iptables** rules. After the initialization container finishes setting up the **iptables** rules, it exits. Next the egress router pod executes the container to handle the egress router traffic. The image used varies depending on the egress router mode.

The environment variables determine which addresses the egress-router image uses. The image configures the macvlan interface to use **EGRESS_SOURCE** as its IP address, with **EGRESS_GATEWAY** as the IP address for the gateway.

Network Address Translation (NAT) rules are set up so that connections to the cluster IP address of the pod on any TCP or UDP port are redirected to the same port on IP address specified by the **EGRESS_DESTINATION** variable.

If only some of the nodes in your cluster are capable of claiming the specified source IP address and using the specified gateway, you can specify a **nodeName** or **nodeSelector** to identify which nodes are acceptable.

29.7.1.3. Deployment considerations

An egress router pod adds an additional IP address and MAC address to the primary network interface of the node. As a result, you might need to configure your hypervisor or cloud provider to allow the additional address.

Red Hat OpenStack Platform (RHOSP)

If you deploy OpenShift Container Platform on RHOSP, you must allow traffic from the IP and MAC addresses of the egress router pod on your OpenStack environment. If you do not allow the traffic, then [communication will fail](#):

```
$ openstack port set --allowed-address \
  ip_address=<ip_address>,mac_address=<mac_address> <neutron_port_uuid>
```

VMware vSphere

If you are using VMware vSphere, see the [VMware documentation for securing vSphere standard switches](#). View and change VMware vSphere default settings by selecting the host virtual switch from the vSphere Web Client.

Specifically, ensure that the following are enabled:

- [MAC Address Changes](#)
- [Forged Transits](#)
- [Promiscuous Mode Operation](#)

29.7.1.4. Failover configuration

To avoid downtime, you can deploy an egress router pod with a **Deployment** resource, as in the following example. To create a new **Service** object for the example deployment, use the **oc expose deployment/egress-demo-controller** command.

```
apiVersion: apps/v1
kind: Deployment
metadata:
  name: egress-demo-controller
spec:
  replicas: 1 1
  selector:
    matchLabels:
      name: egress-router
  template:
    metadata:
      name: egress-router
    labels:
      name: egress-router
    annotations:
      pod.network.openshift.io/assign-macvlan: "true"
  spec: 2
    initContainers:
      ...
    containers:
      ...
```

1 Ensure that replicas is set to **1**, because only one pod can use a given egress source IP address at any time. This means that only a single copy of the router runs on a node.

2 Specify the **Pod** object template for the egress router pod.

29.7.2. Additional resources

- [Deploying an egress router in redirection mode](#)
- [Deploying an egress router in HTTP proxy mode](#)
- [Deploying an egress router in DNS proxy mode](#)

29.8. DEPLOYING AN EGRESS ROUTER POD IN REDIRECT MODE

As a cluster administrator, you can deploy an egress router pod that is configured to redirect traffic to specified destination IP addresses.

29.8.1. Egress router pod specification for redirect mode

Define the configuration for an egress router pod in the **Pod** object. The following YAML describes the fields for the configuration of an egress router pod in redirect mode:

```
apiVersion: v1
kind: Pod
metadata:
  name: egress-1
  labels:
    name: egress-1
  annotations:
    pod.network.openshift.io/assign-macvlan: "true" 1
spec:
  initContainers:
  - name: egress-router
    image: registry.redhat.io/openshift4/ose-egress-router
    securityContext:
      privileged: true
  env:
  - name: EGRESS_SOURCE 2
    value: <egress_router>
  - name: EGRESS_GATEWAY 3
    value: <egress_gateway>
  - name: EGRESS_DESTINATION 4
    value: <egress_destination>
  - name: EGRESS_ROUTER_MODE
    value: init
  containers:
  - name: egress-router-wait
    image: registry.redhat.io/openshift4/ose-pod
```

1 The annotation tells OpenShift Container Platform to create a macvlan network interface on the primary network interface controller (NIC) and move that macvlan interface into the pod's network namespace. You must include the quotation marks around the **"true"** value. To have OpenShift Container Platform create the macvlan interface on a different NIC interface, set the annotation value to the name of that interface. For example, **eth1**.

2 IP address from the physical network that the node is on that is reserved for use by the egress router pod. Optional: You can include the subnet length, the **/24** suffix, so that a proper route to the local subnet is set. If you do not specify a subnet length, then the egress router can access only the

host specified with the **EGRESS_GATEWAY** variable and no other hosts on the subnet.

- 3 Same value as the default gateway used by the node.
- 4 External server to direct traffic to. Using this example, connections to the pod are redirected to **203.0.113.25**, with a source IP address of **192.168.12.99**.

Example egress router pod specification

```

apiVersion: v1
kind: Pod
metadata:
  name: egress-multi
  labels:
    name: egress-multi
  annotations:
    pod.network.openshift.io/assign-macvlan: "true"
spec:
  initContainers:
  - name: egress-router
    image: registry.redhat.io/openshift4/ose-egress-router
    securityContext:
      privileged: true
    env:
      - name: EGRESS_SOURCE
        value: 192.168.12.99/24
      - name: EGRESS_GATEWAY
        value: 192.168.12.1
      - name: EGRESS_DESTINATION
        value: |
          80 tcp 203.0.113.25
          8080 tcp 203.0.113.26 80
          8443 tcp 203.0.113.26 443
          203.0.113.27
      - name: EGRESS_ROUTER_MODE
        value: init
  containers:
  - name: egress-router-wait
    image: registry.redhat.io/openshift4/ose-pod

```

29.8.2. Egress destination configuration format

When an egress router pod is deployed in redirect mode, you can specify redirection rules by using one or more of the following formats:

- **<port> <protocol> <ip_address>** - Incoming connections to the given **<port>** should be redirected to the same port on the given **<ip_address>**. **<protocol>** is either **tcp** or **udp**.
- **<port> <protocol> <ip_address> <remote_port>** - As above, except that the connection is redirected to a different **<remote_port>** on **<ip_address>**.
- **<ip_address>** - If the last line is a single IP address, then any connections on any other port will be redirected to the corresponding port on that IP address. If there is no fallback IP address then connections on other ports are rejected.

In the example that follows several rules are defined:

- The first line redirects traffic from local port **80** to port **80** on **203.0.113.25**.
- The second and third lines redirect local ports **8080** and **8443** to remote ports **80** and **443** on **203.0.113.26**.
- The last line matches traffic for any ports not specified in the previous rules.

Example configuration

```
80 tcp 203.0.113.25
8080 tcp 203.0.113.26 80
8443 tcp 203.0.113.26 443
203.0.113.27
```

29.8.3. Deploying an egress router pod in redirect mode

In *redirect mode*, an egress router pod sets up iptables rules to redirect traffic from its own IP address to one or more destination IP addresses. Client pods that need to use the reserved source IP address must be configured to access the service for the egress router rather than connecting directly to the destination IP. You can access the destination service and port from the application pod by using the **curl** command. For example:

```
$ curl <router_service_IP> <port>
```

Prerequisites

- Install the OpenShift CLI (**oc**).
- Log in as a user with **cluster-admin** privileges.

Procedure

1. Create an egress router pod.
2. To ensure that other pods can find the IP address of the egress router pod, create a service to point to the egress router pod, as in the following example:

```
apiVersion: v1
kind: Service
metadata:
  name: egress-1
spec:
  ports:
    - name: http
      port: 80
    - name: https
      port: 443
  type: ClusterIP
selector:
  name: egress-1
```

Your pods can now connect to this service. Their connections are redirected to the corresponding ports on the external server, using the reserved egress IP address.

29.8.4. Additional resources

- [Configuring an egress router destination mappings with a ConfigMap](#)

29.9. DEPLOYING AN EGRESS ROUTER POD IN HTTP PROXY MODE

As a cluster administrator, you can deploy an egress router pod configured to proxy traffic to specified HTTP and HTTPS-based services.

29.9.1. Egress router pod specification for HTTP mode

Define the configuration for an egress router pod in the **Pod** object. The following YAML describes the fields for the configuration of an egress router pod in HTTP mode:

```
apiVersion: v1
kind: Pod
metadata:
  name: egress-1
  labels:
    name: egress-1
  annotations:
    pod.network.openshift.io/assign-macvlan: "true" ❶
spec:
  initContainers:
  - name: egress-router
    image: registry.redhat.io/openshift4/ose-egress-router
    securityContext:
      privileged: true
    env:
      - name: EGRESS_SOURCE ❷
        value: <egress-router>
      - name: EGRESS_GATEWAY ❸
        value: <egress-gateway>
      - name: EGRESS_ROUTER_MODE
        value: http-proxy
  containers:
  - name: egress-router-pod
    image: registry.redhat.io/openshift4/ose-egress-http-proxy
    env:
      - name: EGRESS_HTTP_PROXY_DESTINATION ❹
        value: |-
          ...
          ...
```

❶ The annotation tells OpenShift Container Platform to create a macvlan network interface on the primary network interface controller (NIC) and move that macvlan interface into the pod's network namespace. You must include the quotation marks around the **"true"** value. To have OpenShift Container Platform create the macvlan interface on a different NIC interface, set the annotation value to the name of that interface. For example, **eth1**.

❷ IP address from the physical network that the node is on that is reserved for use by the egress

- 3 Same value as the default gateway used by the node.
- 4 A string or YAML multi-line string specifying how to configure the proxy. Note that this is specified as an environment variable in the HTTP proxy container, not with the other environment variables in the init container.

29.9.2. Egress destination configuration format

When an egress router pod is deployed in HTTP proxy mode, you can specify redirection rules by using one or more of the following formats. Each line in the configuration specifies one group of connections to allow or deny:

- An IP address allows connections to that IP address, such as **192.168.1.1**.
- A CIDR range allows connections to that CIDR range, such as **192.168.1.0/24**.
- A hostname allows proxying to that host, such as **www.example.com**.
- A domain name preceded by *****, allows proxying to that domain and all of its subdomains, such as ***.example.com**.
- A **!** followed by any of the previous match expressions denies the connection instead.
- If the last line is *****, then anything that is not explicitly denied is allowed. Otherwise, anything that is not allowed is denied.

You can also use ***** to allow connections to all remote destinations.

Example configuration

```
!*example.com
!192.168.1.0/24
192.168.2.1
*
```

29.9.3. Deploying an egress router pod in HTTP proxy mode

In *HTTP proxy mode*, an egress router pod runs as an HTTP proxy on port **8080**. This mode only works for clients that are connecting to HTTP-based or HTTPS-based services, but usually requires fewer changes to the client pods to get them to work. Many programs can be told to use an HTTP proxy by setting an environment variable.

Prerequisites

- Install the OpenShift CLI (**oc**).
- Log in as a user with **cluster-admin** privileges.

Procedure

1. Create an egress router pod.
2. To ensure that other pods can find the IP address of the egress router pod, create a service to point to the egress router pod, as in the following example:

```

apiVersion: v1
kind: Service
metadata:
  name: egress-1
spec:
  ports:
    - name: http-proxy
      port: 8080 1
  type: ClusterIP
  selector:
    name: egress-1

```

- 1 Ensure the **http** port is set to **8080**.

3. To configure the client pod (not the egress proxy pod) to use the HTTP proxy, set the **http_proxy** or **https_proxy** variables:

```

apiVersion: v1
kind: Pod
metadata:
  name: app-1
labels:
  name: app-1
spec:
  containers:
    env:
      - name: http_proxy
        value: http://egress-1:8080/ 1
      - name: https_proxy
        value: http://egress-1:8080/
      ...

```

- 1 The service created in the previous step.



NOTE

Using the **http_proxy** and **https_proxy** environment variables is not necessary for all setups. If the above does not create a working setup, then consult the documentation for the tool or software you are running in the pod.

29.9.4. Additional resources

- [Configuring an egress router destination mappings with a ConfigMap](#)

29.10. DEPLOYING AN EGRESS ROUTER POD IN DNS PROXY MODE

As a cluster administrator, you can deploy an egress router pod configured to proxy traffic to specified DNS names and IP addresses.

29.10.1. Egress router pod specification for DNS mode

Define the configuration for an egress router pod in the **Pod** object. The following YAML describes the fields for the configuration of an egress router pod in DNS mode:

```

apiVersion: v1
kind: Pod
metadata:
  name: egress-1
  labels:
    name: egress-1
  annotations:
    pod.network.openshift.io/assign-macvlan: "true" ❶
spec:
  initContainers:
  - name: egress-router
    image: registry.redhat.io/openshift4/ose-egress-router
    securityContext:
      privileged: true
    env:
      - name: EGRESS_SOURCE ❷
        value: <egress-router>
      - name: EGRESS_GATEWAY ❸
        value: <egress-gateway>
      - name: EGRESS_ROUTER_MODE
        value: dns-proxy
  containers:
  - name: egress-router-pod
    image: registry.redhat.io/openshift4/ose-egress-dns-proxy
    securityContext:
      privileged: true
    env:
      - name: EGRESS_DNS_PROXY_DESTINATION ❹
        value: |-
          ...
      - name: EGRESS_DNS_PROXY_DEBUG ❺
        value: "1"
    ...
  ...

```

- ❶ The annotation tells OpenShift Container Platform to create a macvlan network interface on the primary network interface controller (NIC) and move that macvlan interface into the pod's network namespace. You must include the quotation marks around the **"true"** value. To have OpenShift Container Platform create the macvlan interface on a different NIC interface, set the annotation value to the name of that interface. For example, **eth1**.
- ❷ IP address from the physical network that the node is on that is reserved for use by the egress router pod. Optional: You can include the subnet length, the **/24** suffix, so that a proper route to the local subnet is set. If you do not specify a subnet length, then the egress router can access only the host specified with the **EGRESS_GATEWAY** variable and no other hosts on the subnet.
- ❸ Same value as the default gateway used by the node.
- ❹ Specify a list of one or more proxy destinations.
- ❺ Optional: Specify to output the DNS proxy log output to **stdout**.

29.10.2. Egress destination configuration format

When the router is deployed in DNS proxy mode, you specify a list of port and destination mappings. A destination may be either an IP address or a DNS name.

An egress router pod supports the following formats for specifying port and destination mappings:

Port and remote address

You can specify a source port and a destination host by using the two field format: **<port>** **<remote_address>**.

The host can be an IP address or a DNS name. If a DNS name is provided, DNS resolution occurs at runtime. For a given host, the proxy connects to the specified source port on the destination host when connecting to the destination host IP address.

Port and remote address pair example

```
80 172.16.12.11
100 example.com
```

Port, remote address, and remote port

You can specify a source port, a destination host, and a destination port by using the three field format: **<port>** **<remote_address>** **<remote_port>**.

The three field format behaves identically to the two field version, with the exception that the destination port can be different than the source port.

Port, remote address, and remote port example

```
8080 192.168.60.252 80
8443 web.example.com 443
```

29.10.3. Deploying an egress router pod in DNS proxy mode

In *DNS proxy mode*, an egress router pod acts as a DNS proxy for TCP-based services from its own IP address to one or more destination IP addresses.

Prerequisites

- Install the OpenShift CLI (**oc**).
- Log in as a user with **cluster-admin** privileges.

Procedure

1. Create an egress router pod.
2. Create a service for the egress router pod:
 - a. Create a file named **egress-router-service.yaml** that contains the following YAML. Set **spec.ports** to the list of ports that you defined previously for the **EGRESS_DNS_PROXY_DESTINATION** environment variable.

```
apiVersion: v1
```

```
kind: Service
metadata:
  name: egress-dns-svc
spec:
  ports:
    ...
  type: ClusterIP
  selector:
    name: egress-dns-proxy
```

For example:

```
apiVersion: v1
kind: Service
metadata:
  name: egress-dns-svc
spec:
  ports:
    - name: con1
      protocol: TCP
      port: 80
      targetPort: 80
    - name: con2
      protocol: TCP
      port: 100
      targetPort: 100
  type: ClusterIP
  selector:
    name: egress-dns-proxy
```

- b. To create the service, enter the following command:

```
$ oc create -f egress-router-service.yaml
```

Pods can now connect to this service. The connections are proxied to the corresponding ports on the external server, using the reserved egress IP address.

29.10.4. Additional resources

- [Configuring an egress router destination mappings with a ConfigMap](#)

29.11. CONFIGURING AN EGRESS ROUTER POD DESTINATION LIST FROM A CONFIG MAP

As a cluster administrator, you can define a **ConfigMap** object that specifies destination mappings for an egress router pod. The specific format of the configuration depends on the type of egress router pod. For details on the format, refer to the documentation for the specific egress router pod.

29.11.1. Configuring an egress router destination mappings with a config map

For a large or frequently-changing set of destination mappings, you can use a config map to externally maintain the list. An advantage of this approach is that permission to edit the config map can be delegated to users without **cluster-admin** privileges. Because the egress router pod requires a

privileged container, it is not possible for users without **cluster-admin** privileges to edit the pod definition directly.



NOTE

The egress router pod does not automatically update when the config map changes. You must restart the egress router pod to get updates.

Prerequisites

- Install the OpenShift CLI (**oc**).
- Log in as a user with **cluster-admin** privileges.

Procedure

1. Create a file containing the mapping data for the egress router pod, as in the following example:

```
# Egress routes for Project "Test", version 3

80 tcp 203.0.113.25

8080 tcp 203.0.113.26 80
8443 tcp 203.0.113.26 443

# Fallback
203.0.113.27
```

You can put blank lines and comments into this file.

2. Create a **ConfigMap** object from the file:

```
$ oc delete configmap egress-routes --ignore-not-found

$ oc create configmap egress-routes \
  --from-file=destination=my-egress-destination.txt
```

In the previous command, the **egress-routes** value is the name of the **ConfigMap** object to create and **my-egress-destination.txt** is the name of the file that the data is read from.

TIP

You can alternatively apply the following YAML to create the config map:

```
apiVersion: v1
kind: ConfigMap
metadata:
  name: egress-routes
data:
  destination: |
    # Egress routes for Project "Test", version 3

    80 tcp 203.0.113.25

    8080 tcp 203.0.113.26 80
    8443 tcp 203.0.113.26 443

    # Fallback
    203.0.113.27
```

3. Create an egress router pod definition and specify the **configMapKeyRef** stanza for the **EGRESS_DESTINATION** field in the environment stanza:

```
...
env:
- name: EGRESS_DESTINATION
  valueFrom:
    configMapKeyRef:
      name: egress-routes
      key: destination
...
```

29.11.2. Additional resources

- [Redirect mode](#)
- [HTTP proxy mode](#)
- [DNS proxy mode](#)

29.12. ENABLING MULTICAST FOR A PROJECT

**NOTE**

OpenShift SDN CNI is deprecated as of OpenShift Container Platform 4.14. As of OpenShift Container Platform 4.15, the network plugin is not an option for new installations. In a subsequent future release, the OpenShift SDN network plugin is planned to be removed and no longer supported. Red Hat will provide bug fixes and support for this feature until it is removed, but this feature will no longer receive enhancements. As an alternative to OpenShift SDN CNI, you can use OVN Kubernetes CNI instead.

29.12.1. About multicast

With IP multicast, data is broadcast to many IP addresses simultaneously.



IMPORTANT

- At this time, multicast is best used for low-bandwidth coordination or service discovery and not a high-bandwidth solution.
- By default, network policies affect all connections in a namespace. However, multicast is unaffected by network policies. If multicast is enabled in the same namespace as your network policies, it is always allowed, even if there is a **deny-all** network policy. Cluster administrators should consider the implications to the exemption of multicast from network policies before enabling it.

Multicast traffic between OpenShift Container Platform pods is disabled by default. If you are using the OpenShift SDN network plugin, you can enable multicast on a per-project basis.

When using the OpenShift SDN network plugin in **networkpolicy** isolation mode:

- Multicast packets sent by a pod will be delivered to all other pods in the project, regardless of **NetworkPolicy** objects. Pods might be able to communicate over multicast even when they cannot communicate over unicast.
- Multicast packets sent by a pod in one project will never be delivered to pods in any other project, even if there are **NetworkPolicy** objects that allow communication between the projects.

When using the OpenShift SDN network plugin in **multitenant** isolation mode:

- Multicast packets sent by a pod will be delivered to all other pods in the project.
- Multicast packets sent by a pod in one project will be delivered to pods in other projects only if each project is joined together and multicast is enabled in each joined project.

29.12.2. Enabling multicast between pods

You can enable multicast between pods for your project.

Prerequisites

- Install the OpenShift CLI (**oc**).
- You must log in to the cluster with a user that has the **cluster-admin** role.

Procedure

- Run the following command to enable multicast for a project. Replace **<namespace>** with the namespace for the project you want to enable multicast for.

```
$ oc annotate netnamespace <namespace> \
  netnamespace.network.openshift.io/multicast-enabled=true
```

Verification

To verify that multicast is enabled for a project, complete the following procedure:

1. Change your current project to the project that you enabled multicast for. Replace **<project>** with the project name.

```
$ oc project <project>
```

2. Create a pod to act as a multicast receiver:

```
$ cat <<EOF | oc create -f -
apiVersion: v1
kind: Pod
metadata:
  name: mlistener
  labels:
    app: multicast-verify
spec:
  containers:
  - name: mlistener
    image: registry.access.redhat.com/ubi9
    command: ["/bin/sh", "-c"]
    args:
      ["dnf -y install socat hostname && sleep inf"]
    ports:
    - containerPort: 30102
      name: mlistener
      protocol: UDP
EOF
```

3. Create a pod to act as a multicast sender:

```
$ cat <<EOF | oc create -f -
apiVersion: v1
kind: Pod
metadata:
  name: msender
  labels:
    app: multicast-verify
spec:
  containers:
  - name: msender
    image: registry.access.redhat.com/ubi9
    command: ["/bin/sh", "-c"]
    args:
      ["dnf -y install socat && sleep inf"]
EOF
```

4. In a new terminal window or tab, start the multicast listener.

- a. Get the IP address for the Pod:

```
$ POD_IP=$(oc get pods mlistener -o jsonpath='{.status.podIP}')
```

- b. Start the multicast listener by entering the following command:

```
$ oc exec mlistener -i -t -- \
  socat UDP4-RECVFROM:30102,ip-add-membership=224.1.0.1:$POD_IP,fork
  EXEC:hostname
```

5. Start the multicast transmitter.

a. Get the pod network IP address range:

```
$ CIDR=$(oc get Network.config.openshift.io cluster \
  -o jsonpath='{.status.clusterNetwork[0].cidr}')
```

b. To send a multicast message, enter the following command:

```
$ oc exec msender -i -t -- \
  /bin/bash -c "echo | socat STDIO UDP4-
  DATAGRAM:224.1.0.1:30102,range=$CIDR,ip-multicast-ttl=64"
```

If multicast is working, the previous command returns the following output:

```
mlistener
```

29.13. DISABLING MULTICAST FOR A PROJECT

29.13.1. Disabling multicast between pods

You can disable multicast between pods for your project.

Prerequisites

- Install the OpenShift CLI (**oc**).
- You must log in to the cluster with a user that has the **cluster-admin** role.

Procedure

- Disable multicast by running the following command:

```
$ oc annotate netnamespace <namespace> \ 1
  netnamespace.network.openshift.io/multicast-enabled-
```

- 1** The **namespace** for the project you want to disable multicast for.

29.14. CONFIGURING NETWORK ISOLATION USING OPENSIFT SDN

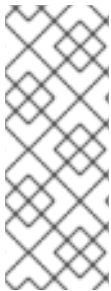
**NOTE**

OpenShift SDN CNI is deprecated as of OpenShift Container Platform 4.14. As of OpenShift Container Platform 4.15, the network plugin is not an option for new installations. In a subsequent future release, the OpenShift SDN network plugin is planned to be removed and no longer supported. Red Hat will provide bug fixes and support for this feature until it is removed, but this feature will no longer receive enhancements. As an alternative to OpenShift SDN CNI, you can use OVN Kubernetes CNI instead.

When your cluster is configured to use the multitenant isolation mode for the OpenShift SDN network plugin, each project is isolated by default. Network traffic is not allowed between pods or services in different projects in multitenant isolation mode.

You can change the behavior of multitenant isolation for a project in two ways:

- You can join one or more projects, allowing network traffic between pods and services in different projects.
- You can disable network isolation for a project. It will be globally accessible, accepting network traffic from pods and services in all other projects. A globally accessible project can access pods and services in all other projects.

29.14.1. Prerequisites

- You must have a cluster configured to use the OpenShift SDN network plugin in multitenant isolation mode.

29.14.2. Joining projects

You can join two or more projects to allow network traffic between pods and services in different projects.

Prerequisites

- Install the OpenShift CLI (**oc**).
- You must log in to the cluster with a user that has the **cluster-admin** role.

Procedure

1. Use the following command to join projects to an existing project network:

```
$ oc adm pod-network join-projects --to=<project1> <project2> <project3>
```

Alternatively, instead of specifying specific project names, you can use the **--selector=<project_selector>** option to specify projects based upon an associated label.

2. Optional: Run the following command to view the pod networks that you have joined together:

```
$ oc get netnamespaces
```

Projects in the same pod-network have the same network ID in the **NETID** column.

29.14.3. Isolating a project

You can isolate a project so that pods and services in other projects cannot access its pods and services.

Prerequisites

- Install the OpenShift CLI (**oc**).
- You must log in to the cluster with a user that has the **cluster-admin** role.

Procedure

- To isolate the projects in the cluster, run the following command:

```
$ oc adm pod-network isolate-projects <project1> <project2>
```

Alternatively, instead of specifying specific project names, you can use the **--selector=<project_selector>** option to specify projects based upon an associated label.

29.14.4. Disabling network isolation for a project

You can disable network isolation for a project.

Prerequisites

- Install the OpenShift CLI (**oc**).
- You must log in to the cluster with a user that has the **cluster-admin** role.

Procedure

- Run the following command for the project:

```
$ oc adm pod-network make-projects-global <project1> <project2>
```

Alternatively, instead of specifying specific project names, you can use the **--selector=<project_selector>** option to specify projects based upon an associated label.

29.15. CONFIGURING KUBE-PROXY

The Kubernetes network proxy (kube-proxy) runs on each node and is managed by the Cluster Network Operator (CNO). kube-proxy maintains network rules for forwarding connections for endpoints associated with services.

29.15.1. About iptables rules synchronization

The synchronization period determines how frequently the Kubernetes network proxy (kube-proxy) syncs the iptables rules on a node.

A sync begins when either of the following events occurs:

- An event occurs, such as service or endpoint is added to or removed from the cluster.
- The time since the last sync exceeds the sync period defined for kube-proxy.

29.15.2. kube-proxy configuration parameters

You can modify the following **kubeProxyConfig** parameters.



NOTE

Because of performance improvements introduced in OpenShift Container Platform 4.3 and greater, adjusting the **iptablesSyncPeriod** parameter is no longer necessary.

Table 29.2. Parameters

| Parameter | Description | Values | Default |
|--|---|--|------------|
| iptablesSyncPeriod | The refresh period for iptables rules. | A time interval, such as 30s or 2m . Valid suffixes include s , m , and h and are described in the Go time package documentation. | 30s |
| proxyArguments.iptables-min-sync-period | The minimum duration before refreshing iptables rules. This parameter ensures that the refresh does not happen too frequently. By default, a refresh starts as soon as a change that affects iptables rules occurs. | A time interval, such as 30s or 2m . Valid suffixes include s , m , and h and are described in the Go time package | 0s |

29.15.3. Modifying the kube-proxy configuration

You can modify the Kubernetes network proxy configuration for your cluster.

Prerequisites

- Install the OpenShift CLI (**oc**).
- Log in to a running cluster with the **cluster-admin** role.

Procedure

1. Edit the **Network.operator.openshift.io** custom resource (CR) by running the following command:

```
$ oc edit network.operator.openshift.io cluster
```

2. Modify the **kubeProxyConfig** parameter in the CR with your changes to the kube-proxy configuration, such as in the following example CR:

```
apiVersion: operator.openshift.io/v1
kind: Network
metadata:
```



```

name: cluster
spec:
  kubeProxyConfig:
    iptablesSyncPeriod: 30s
    proxyArguments:
      iptables-min-sync-period: ["30s"]

```

3. Save the file and exit the text editor.
The syntax is validated by the **oc** command when you save the file and exit the editor. If your modifications contain a syntax error, the editor opens the file and displays an error message.
4. Enter the following command to confirm the configuration update:

```
$ oc get networks.operator.openshift.io -o yaml
```

Example output

```

apiVersion: v1
items:
- apiVersion: operator.openshift.io/v1
  kind: Network
  metadata:
    name: cluster
  spec:
    clusterNetwork:
      - cidr: 10.128.0.0/14
        hostPrefix: 23
    defaultNetwork:
      type: OpenShiftSDN
    kubeProxyConfig:
      iptablesSyncPeriod: 30s
      proxyArguments:
        iptables-min-sync-period:
          - 30s
    serviceNetwork:
      - 172.30.0.0/16
  status: {}
kind: List

```

5. Optional: Enter the following command to confirm that the Cluster Network Operator accepted the configuration change:

```
$ oc get clusteroperator network
```

Example output

```

NAME      VERSION  AVAILABLE  PROGRESSING  DEGRADED  SINCE
network  4.1.0-0.9  True       False        False     1m

```

The **AVAILABLE** field is **True** when the configuration update is applied successfully.

CHAPTER 30. CONFIGURING ROUTES

30.1. ROUTE CONFIGURATION

30.1.1. Creating an HTTP-based route

A route allows you to host your application at a public URL. It can either be secure or unsecured, depending on the network security configuration of your application. An HTTP-based route is an unsecured route that uses the basic HTTP routing protocol and exposes a service on an unsecured application port.

The following procedure describes how to create a simple HTTP-based route to a web application, using the **hello-openshift** application as an example.

Prerequisites

- You installed the OpenShift CLI (**oc**).
- You are logged in as an administrator.
- You have a web application that exposes a port and a TCP endpoint listening for traffic on the port.

Procedure

1. Create a project called **hello-openshift** by running the following command:

```
$ oc new-project hello-openshift
```

2. Create a pod in the project by running the following command:

```
$ oc create -f https://raw.githubusercontent.com/openshift/origin/master/examples/hello-openshift/hello-pod.json
```

3. Create a service called **hello-openshift** by running the following command:

```
$ oc expose pod/hello-openshift
```

4. Create an unsecured route to the **hello-openshift** application by running the following command:

```
$ oc expose svc hello-openshift
```

Verification

- To verify that the **route** resource that you created, run the following command:

```
$ oc get routes -o yaml <name of resource> 1
```

- 1** In this example, the route is named **hello-openshift**.

Sample YAML definition of the created unsecured route:

```

apiVersion: route.openshift.io/v1
kind: Route
metadata:
  name: hello-openshift
spec:
  host: hello-openshift-hello-openshift.<Ingress_Domain> 1
  port:
    targetPort: 8080 2
  to:
    kind: Service
    name: hello-openshift

```

1 **<Ingress_Domain>** is the default ingress domain name. The **ingresses.config/cluster** object is created during the installation and cannot be changed. If you want to specify a different domain, you can specify an alternative cluster domain using the **appsDomain** option.

2 **targetPort** is the target port on pods that is selected by the service that this route points to.

**NOTE**

To display your default ingress domain, run the following command:

```
$ oc get ingresses.config/cluster -o jsonpath={.spec.domain}
```

30.1.2. Creating a route for Ingress Controller sharding

A route allows you to host your application at a URL. In this case, the hostname is not set and the route uses a subdomain instead. When you specify a subdomain, you automatically use the domain of the Ingress Controller that exposes the route. For situations where a route is exposed by multiple Ingress Controllers, the route is hosted at multiple URLs.

The following procedure describes how to create a route for Ingress Controller sharding, using the **hello-openshift** application as an example.

Ingress Controller sharding is useful when balancing incoming traffic load among a set of Ingress Controllers and when isolating traffic to a specific Ingress Controller. For example, company A goes to one Ingress Controller and company B to another.

Prerequisites

- You installed the OpenShift CLI (**oc**).
- You are logged in as a project administrator.
- You have a web application that exposes a port and an HTTP or TLS endpoint listening for traffic on the port.
- You have configured the Ingress Controller for sharding.

Procedure

1. Create a project called **hello-openshift** by running the following command:

```
$ oc new-project hello-openshift
```

2. Create a pod in the project by running the following command:

```
$ oc create -f https://raw.githubusercontent.com/openshift/origin/master/examples/hello-openshift/hello-pod.json
```

3. Create a service called **hello-openshift** by running the following command:

```
$ oc expose pod/hello-openshift
```

4. Create a route definition called **hello-openshift-route.yaml**:

YAML definition of the created route for sharding:

```
apiVersion: route.openshift.io/v1
kind: Route
metadata:
  labels:
    type: sharded 1
  name: hello-openshift-edge
  namespace: hello-openshift
spec:
  subdomain: hello-openshift 2
  tls:
    termination: edge
  to:
    kind: Service
    name: hello-openshift
```

1 Both the label key and its corresponding label value must match the ones specified in the Ingress Controller. In this example, the Ingress Controller has the label key and value **type: sharded**.

2 The route will be exposed using the value of the **subdomain** field. When you specify the **subdomain** field, you must leave the hostname unset. If you specify both the **host** and **subdomain** fields, then the route will use the value of the **host** field, and ignore the **subdomain** field.

5. Use **hello-openshift-route.yaml** to create a route to the **hello-openshift** application by running the following command:

```
$ oc -n hello-openshift create -f hello-openshift-route.yaml
```

Verification

- Get the status of the route with the following command:

```
$ oc -n hello-openshift get routes/hello-openshift-edge -o yaml
```

The resulting **Route** resource should look similar to the following:

Example output

```
apiVersion: route.openshift.io/v1
kind: Route
metadata:
  labels:
    type: sharded
  name: hello-openshift-edge
  namespace: hello-openshift
spec:
  subdomain: hello-openshift
  tls:
    termination: edge
  to:
    kind: Service
    name: hello-openshift
status:
  ingress:
    - host: hello-openshift.<apps-sharded.basedomain.example.net> 1
      routerCanonicalHostname: router-sharded.<apps-sharded.basedomain.example.net> 2
      routerName: sharded 3
```

- 1** The hostname the Ingress Controller, or router, uses to expose the route. The value of the **host** field is automatically determined by the Ingress Controller, and uses its domain. In this example, the domain of the Ingress Controller is **<apps-sharded.basedomain.example.net>**.
- 2** The hostname of the Ingress Controller.
- 3** The name of the Ingress Controller. In this example, the Ingress Controller has the name **sharded**.

30.1.3. Configuring route timeouts

You can configure the default timeouts for an existing route when you have services in need of a low timeout, which is required for Service Level Availability (SLA) purposes, or a high timeout, for cases with a slow back end.

Prerequisites

- You need a deployed Ingress Controller on a running cluster.

Procedure

1. Using the **oc annotate** command, add the timeout to the route:

```
$ oc annotate route <route_name> \
  --overwrite haproxy.router.openshift.io/timeout=<timeout><time_unit> 1
```

- 1** Supported time units are microseconds (us), milliseconds (ms), seconds (s), minutes (m), hours (h), or days (d).

The following example sets a timeout of two seconds on a route named **myroute**:

```
$ oc annotate route myroute --overwrite haproxy.router.openshift.io/timeout=2s
```

30.1.4. HTTP Strict Transport Security

HTTP Strict Transport Security (HSTS) policy is a security enhancement, which signals to the browser client that only HTTPS traffic is allowed on the route host. HSTS also optimizes web traffic by signaling HTTPS transport is required, without using HTTP redirects. HSTS is useful for speeding up interactions with websites.

When HSTS policy is enforced, HSTS adds a Strict Transport Security header to HTTP and HTTPS responses from the site. You can use the **insecureEdgeTerminationPolicy** value in a route to redirect HTTP to HTTPS. When HSTS is enforced, the client changes all requests from the HTTP URL to HTTPS before the request is sent, eliminating the need for a redirect.

Cluster administrators can configure HSTS to do the following:

- Enable HSTS per-route
- Disable HSTS per-route
- Enforce HSTS per-domain, for a set of domains, or use namespace labels in combination with domains



IMPORTANT

HSTS works only with secure routes, either edge-terminated or re-encrypt. The configuration is ineffective on HTTP or passthrough routes.

30.1.4.1. Enabling HTTP Strict Transport Security per-route

HTTP strict transport security (HSTS) is implemented in the HAProxy template and applied to edge and re-encrypt routes that have the **haproxy.router.openshift.io/hsts_header** annotation.

Prerequisites

- You are logged in to the cluster with a user with administrator privileges for the project.
- You installed the **oc** CLI.

Procedure

- To enable HSTS on a route, add the **haproxy.router.openshift.io/hsts_header** value to the edge-terminated or re-encrypt route. You can use the **oc annotate** tool to do this by running the following command:

```
$ oc annotate route <route_name> -n <namespace> --overwrite=true
"haproxy.router.openshift.io/hsts_header"="max-age=31536000;\
includeSubDomains;preload" 1
```

- 1** In this example, the maximum age is set to **31536000** ms, which is approximately eight and a half hours.

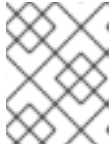

NOTE

In this example, the equal sign (=) is in quotes. This is required to properly execute the annotate command.

Example route configured with an annotation

```
apiVersion: route.openshift.io/v1
kind: Route
metadata:
  annotations:
    haproxy.router.openshift.io/hsts_header: max-age=31536000;includeSubDomains;preload
1 2 3
  ...
spec:
  host: def.abc.com
  tls:
    termination: "reencrypt"
  ...
wildcardPolicy: "Subdomain"
```

- 1** Required. **max-age** measures the length of time, in seconds, that the HSTS policy is in effect. If set to **0**, it negates the policy.
- 2** Optional. When included, **includeSubDomains** tells the client that all subdomains of the host must have the same HSTS policy as the host.
- 3** Optional. When **max-age** is greater than 0, you can add **preload** in **haproxy.router.openshift.io/hsts_header** to allow external services to include this site in their HSTS preload lists. For example, sites such as Google can construct a list of sites that have **preload** set. Browsers can then use these lists to determine which sites they can communicate with over HTTPS, even before they have interacted with the site. Without **preload** set, browsers must have interacted with the site over HTTPS, at least once, to get the header.

30.1.4.2. Disabling HTTP Strict Transport Security per-route

To disable HTTP strict transport security (HSTS) per-route, you can set the **max-age** value in the route annotation to **0**.

Prerequisites

- You are logged in to the cluster with a user with administrator privileges for the project.
- You installed the **oc** CLI.

Procedure

- To disable HSTS, set the **max-age** value in the route annotation to **0**, by entering the following command:

```
$ oc annotate route <route_name> -n <namespace> --overwrite=true
"haproxy.router.openshift.io/hsts_header"="max-age=0"
```

TIP

You can alternatively apply the following YAML to create the config map:

Example of disabling HSTS per-route

```
metadata:
  annotations:
    haproxy.router.openshift.io/hsts_header: max-age=0
```

- To disable HSTS for every route in a namespace, enter the following command:

```
$ oc annotate route --all -n <namespace> --overwrite=true
"haproxy.router.openshift.io/hsts_header"="max-age=0"
```

Verification

1. To query the annotation for all routes, enter the following command:

```
$ oc get route --all-namespaces -o go-template='{{range .items}}{{if .metadata.annotations}}
{{$a := index .metadata.annotations "haproxy.router.openshift.io/hsts_header"}}{{$n :=
.metadata.name}}{{with $a}}Name: {{$n}} HSTS: {{$a}}{\n"}{{else}}{\n"}{{end}}{\n}}
{{end}}'
```

Example output

```
Name: routename HSTS: max-age=0
```

30.1.4.3. Enforcing HTTP Strict Transport Security per-domain

To enforce HTTP Strict Transport Security (HSTS) per-domain for secure routes, add a **requiredHSTSPolicies** record to the Ingress spec to capture the configuration of the HSTS policy.

If you configure a **requiredHSTSPolicy** to enforce HSTS, then any newly created route must be configured with a compliant HSTS policy annotation.

**NOTE**

To handle upgraded clusters with non-compliant HSTS routes, you can update the manifests at the source and apply the updates.

**NOTE**

You cannot use **oc expose route** or **oc create route** commands to add a route in a domain that enforces HSTS, because the API for these commands does not accept annotations.

**IMPORTANT**

HSTS cannot be applied to insecure, or non-TLS routes, even if HSTS is requested for all routes globally.

Prerequisites

- You are logged in to the cluster with a user with administrator privileges for the project.
- You installed the **oc** CLI.

Procedure

1. Edit the Ingress config file:

```
$ oc edit ingresses.config.openshift.io/cluster
```

Example HSTS policy

```
apiVersion: config.openshift.io/v1
kind: Ingress
metadata:
  name: cluster
spec:
  domain: 'hello-openshift-default.apps.username.devcluster.openshift.com'
  requiredHSTSPolicies: 1
  - domainPatterns: 2
    - '*hello-openshift-default.apps.username.devcluster.openshift.com'
    - '*hello-openshift-default2.apps.username.devcluster.openshift.com'
  namespaceSelector: 3
    matchLabels:
      myPolicy: strict
  maxAge: 4
    smallestMaxAge: 1
    largestMaxAge: 31536000
  preloadPolicy: RequirePreload 5
  includeSubDomainsPolicy: RequireIncludeSubDomains 6
  - domainPatterns: 7
    - 'abc.example.com'
    - '*xyz.example.com'
  namespaceSelector:
    matchLabels: {}
  maxAge: {}
  preloadPolicy: NoOpinion
  includeSubDomainsPolicy: RequireNoIncludeSubDomains
```

- 1** Required. **requiredHSTSPolicies** are validated in order, and the first matching **domainPatterns** applies.
- 2** **7** Required. You must specify at least one **domainPatterns** hostname. Any number of domains can be listed. You can include multiple sections of enforcing options for different **domainPatterns**.
- 3** Optional. If you include **namespaceSelector**, it must match the labels of the project where the routes reside, to enforce the set HSTS policy on the routes. Routes that only match the **namespaceSelector** and not the **domainPatterns** are not validated.
- 4** Required. **max-age** measures the length of time, in seconds, that the HSTS policy is in effect. This policy setting allows for a smallest and largest **max-age** to be enforced.

- The **largestMaxAge** value must be between **0** and **2147483647**. It can be left unspecified, which means no upper limit is enforced.
 - The **smallestMaxAge** value must be between **0** and **2147483647**. Enter **0** to disable HSTS for troubleshooting, otherwise enter **1** if you never want HSTS to be disabled. It can be left unspecified, which means no lower limit is enforced.
- 5** Optional. Including **preload** in **haproxy.router.openshift.io/hsts_header** allows external services to include this site in their HSTS preload lists. Browsers can then use these lists to determine which sites they can communicate with over HTTPS, before they have interacted with the site. Without **preload** set, browsers need to interact at least once with the site to get the header. **preload** can be set with one of the following:
- **RequirePreload:** **preload** is required by the **RequiredHSTSPolicy**.
 - **RequireNoPreload:** **preload** is forbidden by the **RequiredHSTSPolicy**.
 - **NoOpinion:** **preload** does not matter to the **RequiredHSTSPolicy**.
- 6** Optional. **includeSubDomainsPolicy** can be set with one of the following:
- **RequireIncludeSubDomains:** **includeSubDomains** is required by the **RequiredHSTSPolicy**.
 - **RequireNoIncludeSubDomains:** **includeSubDomains** is forbidden by the **RequiredHSTSPolicy**.
 - **NoOpinion:** **includeSubDomains** does not matter to the **RequiredHSTSPolicy**.
2. You can apply HSTS to all routes in the cluster or in a particular namespace by entering the **oc annotate command**.

- To apply HSTS to all routes in the cluster, enter the **oc annotate command**. For example:

```
$ oc annotate route --all --all-namespaces --overwrite=true
"haproxy.router.openshift.io/hsts_header"="max-age=31536000"
```

- To apply HSTS to all routes in a particular namespace, enter the **oc annotate command**. For example:

```
$ oc annotate route --all -n my-namespace --overwrite=true
"haproxy.router.openshift.io/hsts_header"="max-age=31536000"
```

Verification

You can review the HSTS policy you configured. For example:

- To review the **maxAge** set for required HSTS policies, enter the following command:

```
$ oc get clusteroperator/ingress -n openshift-ingress-operator -o jsonpath='{range
.spec.requiredHSTSPolicies[*]}{.spec.requiredHSTSPolicies.maxAgePolicy.largestMaxAge}
{"\n"}{end}'
```

- To review the HSTS annotations on all routes, enter the following command:

```
$ oc get route --all-namespaces -o go-template='{{range .items}}{{if .metadata.annotations}}
{{$a := index .metadata.annotations "haproxy.router.openshift.io/hsts_header"}}{{$n :=
.metadata.name}}{{with $a}}Name: {{$n}} HSTS: {{$a}}{"\n"}}{{else}}{""}{{end}}{{end}}
{{end}}'
```

Example output

```
Name: <_routename_> HSTS: max-age=31536000;preload;includeSubDomains
```

30.1.5. Throughput issue troubleshooting methods

Sometimes applications deployed by using OpenShift Container Platform can cause network throughput issues, such as unusually high latency between specific services.

If pod logs do not reveal any cause of the problem, use the following methods to analyze performance issues:

- Use a packet analyzer, such as **ping** or **tcpdump** to analyze traffic between a pod and its node. For example, [run the tcpdump tool on each pod](#) while reproducing the behavior that led to the issue. Review the captures on both sides to compare send and receive timestamps to analyze the latency of traffic to and from a pod. Latency can occur in OpenShift Container Platform if a node interface is overloaded with traffic from other pods, storage devices, or the data plane.

```
$ tcpdump -s 0 -i any -w /tmp/dump.pcap host <podip 1> && host <podip 2> 1
```

- 1** **podip** is the IP address for the pod. Run the **oc get pod <pod_name> -o wide** command to get the IP address of a pod.

The **tcpdump** command generates a file at **/tmp/dump.pcap** containing all traffic between these two pods. You can run the analyzer shortly before the issue is reproduced and stop the analyzer shortly after the issue is finished reproducing to minimize the size of the file. You can also [run a packet analyzer between the nodes](#) (eliminating the SDN from the equation) with:

```
$ tcpdump -s 0 -i any -w /tmp/dump.pcap port 4789
```

- Use a bandwidth measuring tool, such as **iperf**, to measure streaming throughput and UDP throughput. Locate any bottlenecks by running the tool from the pods first, and then running it from the nodes.
 - For information on installing and using **iperf**, see this [Red Hat Solution](#).
- In some cases, the cluster may mark the node with the router pod as unhealthy due to latency issues. Use worker latency profiles to adjust the frequency that the cluster waits for a status update from the node before taking action.
- If your cluster has designated lower-latency and higher-latency nodes, configure the **spec.nodePlacement** field in the Ingress Controller to control the placement of the router pod.

Additional resources

- [Latency spikes or temporary reduction in throughput to remote workers](#)
- [Ingress Controller configuration parameters](#)

30.1.6. Using cookies to keep route statefulness

OpenShift Container Platform provides sticky sessions, which enables stateful application traffic by ensuring all traffic hits the same endpoint. However, if the endpoint pod terminates, whether through restart, scaling, or a change in configuration, this statefulness can disappear.

OpenShift Container Platform can use cookies to configure session persistence. The Ingress controller selects an endpoint to handle any user requests, and creates a cookie for the session. The cookie is passed back in the response to the request and the user sends the cookie back with the next request in the session. The cookie tells the Ingress Controller which endpoint is handling the session, ensuring that client requests use the cookie so that they are routed to the same pod.



NOTE

Cookies cannot be set on passthrough routes, because the HTTP traffic cannot be seen. Instead, a number is calculated based on the source IP address, which determines the backend.

If backends change, the traffic can be directed to the wrong server, making it less sticky. If you are using a load balancer, which hides source IP, the same number is set for all connections and traffic is sent to the same pod.

30.1.6.1. Annotating a route with a cookie

You can set a cookie name to overwrite the default, auto-generated one for the route. This allows the application receiving route traffic to know the cookie name. By deleting the cookie it can force the next request to re-choose an endpoint. So, if a server was overloaded it tries to remove the requests from the client and redistribute them.

Procedure

1. Annotate the route with the specified cookie name:

```
$ oc annotate route <route_name> router.openshift.io/cookie_name="<cookie_name>"
```

where:

<route_name>

Specifies the name of the route.

<cookie_name>

Specifies the name for the cookie.

For example, to annotate the route **my_route** with the cookie name **my_cookie**:

```
$ oc annotate route my_route router.openshift.io/cookie_name="my_cookie"
```

2. Capture the route hostname in a variable:

```
$ ROUTE_NAME=$(oc get route <route_name> -o jsonpath='{.spec.host}')
```

where:

<route_name>

Specifies the name of the route.

3. Save the cookie, and then access the route:

```
$ curl $ROUTE_NAME -k -c /tmp/cookie_jar
```

Use the cookie saved by the previous command when connecting to the route:

```
$ curl $ROUTE_NAME -k -b /tmp/cookie_jar
```

30.1.7. Path-based routes

Path-based routes specify a path component that can be compared against a URL, which requires that the traffic for the route be HTTP based. Thus, multiple routes can be served using the same hostname, each with a different path. Routers should match routes based on the most specific path to the least.

The following table shows example routes and their accessibility:

Table 30.1. Route availability

| Route | When Compared to | Accessible |
|---|-----------------------------|--|
| <i>www.example.com/test</i> | <i>www.example.com/test</i> | Yes |
| | <i>www.example.com</i> | No |
| <i>www.example.com/test</i> and
<i>www.example.com</i> | <i>www.example.com/test</i> | Yes |
| | <i>www.example.com</i> | Yes |
| <i>www.example.com</i> | <i>www.example.com/text</i> | Yes (Matched by the host, not the route) |
| | <i>www.example.com</i> | Yes |

An unsecured route with a path

```
apiVersion: route.openshift.io/v1
kind: Route
metadata:
  name: route-unsecured
spec:
  host: www.example.com
  path: "/test" 1
  to:
    kind: Service
    name: service-name
```

- 1** The path is the only added attribute for a path-based route.

**NOTE**

Path-based routing is not available when using passthrough TLS, as the router does not terminate TLS in that case and cannot read the contents of the request.

30.1.8. HTTP header configuration

OpenShift Container Platform provides different methods for working with HTTP headers. When setting or deleting headers, you can use specific fields in the Ingress Controller or an individual route to modify request and response headers. You can also set certain headers by using route annotations. The various ways of configuring headers can present challenges when working together.

**NOTE**

You can only set or delete headers within an **IngressController** or **Route** CR, you cannot append them. If an HTTP header is set with a value, that value must be complete and not require appending in the future. In situations where it makes sense to append a header, such as the X-Forwarded-For header, use the **spec.httpHeaders.forwardedHeaderPolicy** field, instead of **spec.httpHeaders.actions**.

30.1.8.1. Order of precedence

When the same HTTP header is modified both in the Ingress Controller and in a route, HAProxy prioritizes the actions in certain ways depending on whether it is a request or response header.

- For HTTP response headers, actions specified in the Ingress Controller are executed after the actions specified in a route. This means that the actions specified in the Ingress Controller take precedence.
- For HTTP request headers, actions specified in a route are executed after the actions specified in the Ingress Controller. This means that the actions specified in the route take precedence.

For example, a cluster administrator sets the X-Frame-Options response header with the value **DENY** in the Ingress Controller using the following configuration:

Example IngressController spec

```
apiVersion: operator.openshift.io/v1
kind: IngressController
# ...
spec:
  httpHeaders:
    actions:
      response:
        - name: X-Frame-Options
          action:
            type: Set
            set:
              value: DENY
```

A route owner sets the same response header that the cluster administrator set in the Ingress Controller, but with the value **SAMEORIGIN** using the following configuration:

Example Route spec

■

```

apiVersion: route.openshift.io/v1
kind: Route
# ...
spec:
  httpHeaders:
    actions:
      response:
        - name: X-Frame-Options
          action:
            type: Set
            set:
              value: SAMEORIGIN

```

When both the **IngressController** spec and **Route** spec are configuring the X-Frame-Options header, then the value set for this header at the global level in the Ingress Controller will take precedence, even if a specific route allows frames.

This prioritization occurs because the **haproxy.config** file uses the following logic, where the Ingress Controller is considered the front end and individual routes are considered the back end. The header value **DENY** applied to the front end configurations overrides the same header with the value **SAMEORIGIN** that is set in the back end:

```

frontend public
  http-response set-header X-Frame-Options 'DENY'

frontend fe_sni
  http-response set-header X-Frame-Options 'DENY'

frontend fe_no_sni
  http-response set-header X-Frame-Options 'DENY'

backend be_secure:openshift-monitoring:alertmanager-main
  http-response set-header X-Frame-Options 'SAMEORIGIN'

```

Additionally, any actions defined in either the Ingress Controller or a route override values set using route annotations.

30.1.8.2. Special case headers

The following headers are either prevented entirely from being set or deleted, or allowed under specific circumstances:

Table 30.2. Special case header configuration options

| Header name | Configurable using IngressController spec | Configurable using Route spec | Reason for disallowment | Configurable using another method |
|-------------|--|--------------------------------------|-------------------------|-----------------------------------|
|-------------|--|--------------------------------------|-------------------------|-----------------------------------|

| Header name | Configurable using IngressController spec | Configurable using Route spec | Reason for disallowment | Configurable using another method |
|----------------------------------|--|--------------------------------------|---|---|
| proxy | No | No | The proxy HTTP request header can be used to exploit vulnerable CGI applications by injecting the header value into the HTTP_PROXY environment variable. The proxy HTTP request header is also non-standard and prone to error during configuration. | No |
| host | No | Yes | When the host HTTP request header is set using the IngressController CR, HAProxy can fail when looking up the correct route. | No |
| strict-transport-security | No | No | The strict-transport-security HTTP response header is already handled using route annotations and does not need a separate implementation. | Yes: the haproxy.router.openshift.io/hosts_header route annotation |

| Header name | Configurable using IngressController spec | Configurable using Route spec | Reason for disallowment | Configurable using another method |
|-------------------------------------|---|-------------------------------|--|--|
| cookie and set-cookie | No | No | The cookies that HAProxy sets are used for session tracking to map client connections to particular back-end servers. Allowing these headers to be set could interfere with HAProxy's session affinity and restrict HAProxy's ownership of a cookie. | Yes: <ul style="list-style-type: none"> the haproxy.router.openshift.io/disable_cookie route annotation the haproxy.router.openshift.io/cookie_name route annotation |

30.1.9. Setting or deleting HTTP request and response headers in a route

You can set or delete certain HTTP request and response headers for compliance purposes or other reasons. You can set or delete these headers either for all routes served by an Ingress Controller or for specific routes.

For example, you might want to enable a web application to serve content in alternate locations for specific routes if that content is written in multiple languages, even if there is a default global location specified by the Ingress Controller serving the routes.

The following procedure creates a route that sets the Content-Location HTTP request header so that the URL associated with the application, **https://app.example.com**, directs to the location **https://app.example.com/lang/en-us**. Directing application traffic to this location means that anyone using that specific route is accessing web content written in American English.

Prerequisites

- You have installed the OpenShift CLI (**oc**).
- You are logged into an OpenShift Container Platform cluster as a project administrator.
- You have a web application that exposes a port and an HTTP or TLS endpoint listening for traffic on the port.

Procedure

1. Create a route definition and save it in a file called **app-example-route.yaml**:

YAML definition of the created route with HTTP header directives

```

apiVersion: route.openshift.io/v1
kind: Route
# ...
spec:
  host: app.example.com
  tls:
    termination: edge
  to:
    kind: Service
    name: app-example
  httpHeaders:
    actions: ❶
    response: ❷
    - name: Content-Location ❸
      action:
        type: Set ❹
        set:
          value: /lang/en-us ❺

```

- ❶ The list of actions you want to perform on the HTTP headers.
- ❷ The type of header you want to change. In this case, a response header.
- ❸ The name of the header you want to change. For a list of available headers you can set or delete, see *HTTP header configuration*.
- ❹ The type of action being taken on the header. This field can have the value **Set** or **Delete**.
- ❺ When setting HTTP headers, you must provide a **value**. The value can be a string from a list of available directives for that header, for example **DENY**, or it can be a dynamic value that will be interpreted using HAProxy's dynamic value syntax. In this case, the value is set to the relative location of the content.

2. Create a route to your existing web application using the newly created route definition:

```
$ oc -n app-example create -f app-example-route.yaml
```

For HTTP request headers, the actions specified in the route definitions are executed after any actions performed on HTTP request headers in the Ingress Controller. This means that any values set for those request headers in a route will take precedence over the ones set in the Ingress Controller. For more information on the processing order of HTTP headers, see *HTTP header configuration*.

30.1.10. Route-specific annotations

The Ingress Controller can set the default options for all the routes it exposes. An individual route can override some of these defaults by providing specific configurations in its annotations. Red Hat does not support adding a route annotation to an operator-managed route.



IMPORTANT

To create a whitelist with multiple source IPs or subnets, use a space-delimited list. Any other delimiter type causes the list to be ignored without a warning or error message.

Table 30.3. Route annotations

| Variable | Description | Environment variable used as default |
|---|---|--|
| haproxy.router.openshift.io/balance | Sets the load-balancing algorithm. Available options are random , source , roundrobin , and leastconn . The default value is source for TLS passthrough routes. For all other routes, the default is random . | ROUTER_TCP_BALANCE_SCHEME for passthrough routes. Otherwise, use ROUTER_LOAD_BALANCE_ALGORITHM . |
| haproxy.router.openshift.io/disable_cookies | Disables the use of cookies to track related connections. If set to 'true' or 'TRUE' , the balance algorithm is used to choose which back-end serves connections for each incoming HTTP request. | |
| router.openshift.io/cookie_name | Specifies an optional cookie to use for this route. The name must consist of any combination of upper and lower case letters, digits, "_", and "-". The default is the hashed internal key name for the route. | |
| haproxy.router.openshift.io/pod-concurrent-connections | Sets the maximum number of connections that are allowed to a backing pod from a router. Note: If there are multiple pods, each can have this many connections. If you have multiple routers, there is no coordination among them, each may connect this many times. If not set, or set to 0, there is no limit. | |
| haproxy.router.openshift.io/rate-limit-connections | Setting 'true' or 'TRUE' enables rate limiting functionality which is implemented through stick-tables on the specific backend per route. Note: Using this annotation provides basic protection against denial-of-service attacks. | |

| Variable | Description | Environment variable used as default |
|---|---|--------------------------------------|
| haproxy.router.openshift.io/ate-limit-connections.concurrent-tcp | Limits the number of concurrent TCP connections made through the same source IP address. It accepts a numeric value.
Note: Using this annotation provides basic protection against denial-of-service attacks. | |
| haproxy.router.openshift.io/ate-limit-connections.rate-http | Limits the rate at which a client with the same source IP address can make HTTP requests. It accepts a numeric value.
Note: Using this annotation provides basic protection against denial-of-service attacks. | |
| haproxy.router.openshift.io/ate-limit-connections.rate-tcp | Limits the rate at which a client with the same source IP address can make TCP connections. It accepts a numeric value.
Note: Using this annotation provides basic protection against denial-of-service attacks. | |
| haproxy.router.openshift.io/timeout | Sets a server-side timeout for the route. (TimeUnits) | ROUTER_DEFAULT_SERVER_TIMEOUT |
| haproxy.router.openshift.io/timeout-tunnel | This timeout applies to a tunnel connection, for example, WebSocket over cleartext, edge, reencrypt, or passthrough routes. With cleartext, edge, or reencrypt route types, this annotation is applied as a timeout tunnel with the existing timeout value. For the passthrough route types, the annotation takes precedence over any existing timeout value set. | ROUTER_DEFAULT_TUNNEL_TIMEOUT |
| ingresses.config/cluster.ingress.operator.openshift.io/hard-stop-after | You can set either an IngressController or the ingress config . This annotation redeploys the router and configures the HA proxy to emit the haproxy hard-stop-after global option, which defines the maximum time allowed to perform a clean soft-stop. | ROUTER_HARD_STOP_AFTER |

| Variable | Description | Environment variable used as default |
|--|--|--------------------------------------|
| router.openshift.io/haproxy.health.check.interval | Sets the interval for the back-end health checks. (TimeUnits) | ROUTER_BACKEND_CHECK_INTERVAL |
| haproxy.router.openshift.io/ipp_whitelist | <p>Sets an allowlist for the route. The allowlist is a space-separated list of IP addresses and CIDR ranges for the approved source addresses. Requests from IP addresses that are not in the allowlist are dropped.</p> <p>The maximum number of IP addresses and CIDR ranges directly visible in the haproxy.config file is 61. [1]</p> | |
| haproxy.router.openshift.io/hsts_header | Sets a Strict-Transport-Security header for the edge terminated or re-encrypt route. | |
| haproxy.router.openshift.io/rewrite-target | Sets the rewrite path of the request on the backend. | |
| router.openshift.io/cookie-same-site | <p>Sets a value to restrict cookies. The values are:</p> <p>Lax: the browser does not send cookies on cross-site requests, but does send cookies when users navigate to the origin site from an external site. This is the default browser behavior when the SameSite value is not specified.</p> <p>Strict: the browser sends cookies only for same-site requests.</p> <p>None: the browser sends cookies for both cross-site and same-site requests.</p> <p>This value is applicable to re-encrypt and edge routes only. For more information, see the SameSite cookies documentation.</p> | |

| Variable | Description | Environment variable used as default |
|--|--|--------------------------------------|
| haproxy.router.openshift.io/set-forwarded-headers | <p>Sets the policy for handling the Forwarded and X-Forwarded-For HTTP headers per route. The values are:</p> <p>append: appends the header, preserving any existing header. This is the default value.</p> <p>replace: sets the header, removing any existing header.</p> <p>never: never sets the header, but preserves any existing header.</p> <p>if-none: sets the header if it is not already set.</p> | ROUTER_SET_FORWARDER_HEADERS |

1. If the number of IP addresses and CIDR ranges in an allowlist exceeds 61, they are written into a separate file that is then referenced from **haproxy.config**. This file is stored in the **var/lib/haproxy/router/whitelists** folder.

**NOTE**

To ensure that the addresses are written to the allowlist, check that the full list of CIDR ranges are listed in the Ingress Controller configuration file. The etcd object size limit restricts how large a route annotation can be. Because of this, it creates a threshold for the maximum number of IP addresses and CIDR ranges that you can include in an allowlist.

**NOTE**

Environment variables cannot be edited.

Router timeout variables

TimeUnits are represented by a number followed by the unit: **us** *(microseconds), **ms** (milliseconds, default), **s** (seconds), **m** (minutes), **h** *(hours), **d** (days).

The regular expression is: `[1-9][0-9]*(us|ms|s|m|h|d)`.

| Variable | Default | Description |
|--------------------------------------|---------------|---|
| ROUTER_BACKEND_CHECK_INTERVAL | 5000ms | Length of time between subsequent liveness checks on back ends. |

| Variable | Default | Description |
|--|-------------|--|
| ROUTER_CLIENT_FIN_TIMEOUT | 1s | Controls the TCP FIN timeout period for the client connecting to the route. If the FIN sent to close the connection does not answer within the given time, HAProxy closes the connection. This is harmless if set to a low value and uses fewer resources on the router. |
| ROUTER_DEFAULT_CLIENT_TIMEOUT | 30s | Length of time that a client has to acknowledge or send data. |
| ROUTER_DEFAULT_CONNECT_TIMEOUT | 5s | The maximum connection time. |
| ROUTER_DEFAULT_SERVER_FIN_TIMEOUT | 1s | Controls the TCP FIN timeout from the router to the pod backing the route. |
| ROUTER_DEFAULT_SERVER_TIMEOUT | 30s | Length of time that a server has to acknowledge or send data. |
| ROUTER_DEFAULT_TUNNEL_TIMEOUT | 1h | Length of time for TCP or WebSocket connections to remain open. This timeout period resets whenever HAProxy reloads. |
| ROUTER_SLOWLORIS_HTTP_KEEPAKALIVE | 300s | <p>Set the maximum time to wait for a new HTTP request to appear. If this is set too low, it can cause problems with browsers and applications not expecting a small keepalive value.</p> <p>Some effective timeout values can be the sum of certain variables, rather than the specific expected timeout. For example, ROUTER_SLOWLORIS_HTTP_KEEPAKALIVE adjusts timeout http-keep-alive. It is set to 300s by default, but HAProxy also waits on tcp-request inspect-delay, which is set to 5s. In this case, the overall timeout would be 300s plus 5s.</p> |
| ROUTER_SLOWLORIS_TIMEOUT | 10s | Length of time the transmission of an HTTP request can take. |
| RELOAD_INTERVAL | 5s | Allows the minimum frequency for the router to reload and accept new changes. |
| ROUTER_METRICS_HAPROXY_TIMEOUT | 5s | Timeout for the gathering of HAProxy metrics. |

A route setting custom timeout

```
apiVersion: route.openshift.io/v1
kind: Route
metadata:
  annotations:
    haproxy.router.openshift.io/timeout: 5500ms 1
...
```

- 1** Specifies the new timeout with HAProxy supported units (**us**, **ms**, **s**, **m**, **h**, **d**). If the unit is not provided, **ms** is the default.

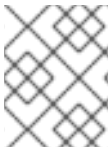

NOTE

Setting a server-side timeout value for passthrough routes too low can cause WebSocket connections to timeout frequently on that route.

A route that allows only one specific IP address

```
metadata:
  annotations:
    haproxy.router.openshift.io/ip_whitelist: 192.168.1.10
```

A route that allows several IP addresses

```
metadata:
  annotations:
    haproxy.router.openshift.io/ip_whitelist: 192.168.1.10 192.168.1.11 192.168.1.12
```

A route that allows an IP address CIDR network

```
metadata:
  annotations:
    haproxy.router.openshift.io/ip_whitelist: 192.168.1.0/24
```

A route that allows both IP an address and IP address CIDR networks

```
metadata:
  annotations:
    haproxy.router.openshift.io/ip_whitelist: 180.5.61.153 192.168.1.0/24 10.0.0.0/8
```

A route specifying a rewrite target

```
apiVersion: route.openshift.io/v1
kind: Route
metadata:
  annotations:
    haproxy.router.openshift.io/rewrite-target: / 1
...
```

- 1 Sets / as rewrite path of the request on the backend.

Setting the **haproxy.router.openshift.io/rewrite-target** annotation on a route specifies that the Ingress Controller should rewrite paths in HTTP requests using this route before forwarding the requests to the backend application. The part of the request path that matches the path specified in **spec.path** is replaced with the rewrite target specified in the annotation.

The following table provides examples of the path rewriting behavior for various combinations of **spec.path**, request path, and rewrite target.

Table 30.4. rewrite-target examples:

| Route.spec.path | Request path | Rewrite target | Forwarded request path |
|-----------------|--------------|----------------|--|
| /foo | /foo | / | / |
| /foo | /foo/ | / | / |
| /foo | /foo/bar | / | /bar |
| /foo | /foo/bar/ | / | /bar/ |
| /foo | /foo | /bar | /bar |
| /foo | /foo/ | /bar | /bar/ |
| /foo | /foo/bar | /baz | /baz/bar |
| /foo | /foo/bar/ | /baz | /baz/bar/ |
| /foo/ | /foo | / | N/A (request path does not match route path) |
| /foo/ | /foo/ | / | / |
| /foo/ | /foo/bar | / | /bar |

30.1.11. Configuring the route admission policy

Administrators and application developers can run applications in multiple namespaces with the same domain name. This is for organizations where multiple teams develop microservices that are exposed on the same hostname.

**WARNING**

Allowing claims across namespaces should only be enabled for clusters with trust between namespaces, otherwise a malicious user could take over a hostname. For this reason, the default admission policy disallows hostname claims across namespaces.

Prerequisites

- Cluster administrator privileges.

Procedure

- Edit the **.spec.routeAdmission** field of the **ingresscontroller** resource variable using the following command:

```
$ oc -n openshift-ingress-operator patch ingresscontroller/default --patch '{"spec": {"routeAdmission":{"namespaceOwnership":"InterNamespaceAllowed"}}}' --type=merge
```

Sample Ingress Controller configuration

```
spec:
  routeAdmission:
    namespaceOwnership: InterNamespaceAllowed
  ...
```

TIP

You can alternatively apply the following YAML to configure the route admission policy:

```
apiVersion: operator.openshift.io/v1
kind: IngressController
metadata:
  name: default
  namespace: openshift-ingress-operator
spec:
  routeAdmission:
    namespaceOwnership: InterNamespaceAllowed
```

30.1.12. Creating a route through an Ingress object

Some ecosystem components have an integration with Ingress resources but not with route resources. To cover this case, OpenShift Container Platform automatically creates managed route objects when an Ingress object is created. These route objects are deleted when the corresponding Ingress objects are deleted.

Procedure

1. Define an Ingress object in the OpenShift Container Platform console or by entering the **oc create** command:

YAML Definition of an Ingress

```

apiVersion: networking.k8s.io/v1
kind: Ingress
metadata:
  name: frontend
  annotations:
    route.openshift.io/termination: "reencrypt" 1
    route.openshift.io/destination-ca-certificate-secret: secret-ca-cert 2
spec:
  rules:
    - host: www.example.com 3
      http:
        paths:
          - backend:
              service:
                name: frontend
                port:
                  number: 443
            path: /
            pathType: Prefix
  tls:
    - hosts:
        - www.example.com
      secretName: example-com-tls-certificate

```

- 1 The **route.openshift.io/termination** annotation can be used to configure the **spec.tls.termination** field of the **Route** as **Ingress** has no field for this. The accepted values are **edge**, **passthrough** and **reencrypt**. All other values are silently ignored. When the annotation value is unset, **edge** is the default route. The TLS certificate details must be defined in the template file to implement the default edge route.
- 3 When working with an **Ingress** object, you must specify an explicit hostname, unlike when working with routes. You can use the **<host_name>.<cluster_ingress_domain>** syntax, for example **apps.openshift demos.com**, to take advantage of the *****. **<cluster_ingress_domain>** wildcard DNS record and serving certificate for the cluster. Otherwise, you must ensure that there is a DNS record for the chosen hostname.
 - a. If you specify the **passthrough** value in the **route.openshift.io/termination** annotation, set **path** to **"** and **pathType** to **ImplementationSpecific** in the spec:

```

spec:
  rules:
    - host: www.example.com
      http:
        paths:
          - path: "
            pathType: ImplementationSpecific
            backend:
              service:

```

```
name: frontend
port:
  number: 443
```

```
$ oc apply -f ingress.yaml
```

2 The **route.openshift.io/destination-ca-certificate-secret** can be used on an Ingress object to define a route with a custom destination certificate (CA). The annotation references a kubernetes secret, **secret-ca-cert** that will be inserted into the generated route.

- a. To specify a route object with a destination CA from an ingress object, you must create a **kubernetes.io/tls** or **Opaque** type secret with a certificate in PEM-encoded format in the **data.tls.crt** specifier of the secret.

2. List your routes:

```
$ oc get routes
```

The result includes an autogenerated route whose name starts with **frontend-**:

| NAME | HOST/PORT | PATH | SERVICES | PORT | TERMINATION |
|----------------|-----------------|------|----------|------|-------------------------|
| WILDCARD | | | | | |
| frontend-gnztq | www.example.com | | frontend | 443 | reencrypt/Redirect None |

If you inspect this route, it looks this:

YAML Definition of an autogenerated route

```
apiVersion: route.openshift.io/v1
kind: Route
metadata:
  name: frontend-gnztq
  ownerReferences:
  - apiVersion: networking.k8s.io/v1
    controller: true
    kind: Ingress
    name: frontend
    uid: 4e6c59cc-704d-4f44-b390-617d879033b6
spec:
  host: www.example.com
  path: /
  port:
    targetPort: https
  tls:
    certificate: |
      -----BEGIN CERTIFICATE-----
      [...]
      -----END CERTIFICATE-----
  insecureEdgeTerminationPolicy: Redirect
  key: |
    -----BEGIN RSA PRIVATE KEY-----
    [...]
    -----END RSA PRIVATE KEY-----
```

```

termination: reencrypt
destinationCACertificate: |
  -----BEGIN CERTIFICATE-----
  [...]
  -----END CERTIFICATE-----
to:
  kind: Service
  name: frontend

```

30.1.13. Creating a route using the default certificate through an Ingress object

If you create an Ingress object without specifying any TLS configuration, OpenShift Container Platform generates an insecure route. To create an Ingress object that generates a secure, edge-terminated route using the default ingress certificate, you can specify an empty TLS configuration as follows.

Prerequisites

- You have a service that you want to expose.
- You have access to the OpenShift CLI (**oc**).

Procedure

1. Create a YAML file for the Ingress object. In this example, the file is called **example-ingress.yaml**:

YAML definition of an Ingress object

```

apiVersion: networking.k8s.io/v1
kind: Ingress
metadata:
  name: frontend
  ...
spec:
  rules:
    ...
  tls:
    - {} 1

```

- 1** Use this exact syntax to specify TLS without specifying a custom certificate.

2. Create the Ingress object by running the following command:

```
$ oc create -f example-ingress.yaml
```

Verification

- Verify that OpenShift Container Platform has created the expected route for the Ingress object by running the following command:

```
$ oc get routes -o yaml
```

Example output

```

apiVersion: v1
items:
- apiVersion: route.openshift.io/v1
  kind: Route
  metadata:
    name: frontend-j9sdd 1
    ...
  spec:
    ...
    tls: 2
      insecureEdgeTerminationPolicy: Redirect
      termination: edge 3
    ...

```

- 1** The name of the route includes the name of the Ingress object followed by a random suffix.
- 2** In order to use the default certificate, the route should not specify **spec.certificate**.
- 3** The route should specify the **edge** termination policy.

30.1.14. Creating a route using the destination CA certificate in the Ingress annotation

The **route.openshift.io/destination-ca-certificate-secret** annotation can be used on an Ingress object to define a route with a custom destination CA certificate.

Prerequisites

- You may have a certificate/key pair in PEM-encoded files, where the certificate is valid for the route host.
- You may have a separate CA certificate in a PEM-encoded file that completes the certificate chain.
- You must have a separate destination CA certificate in a PEM-encoded file.
- You must have a service that you want to expose.

Procedure

1. Add the **route.openshift.io/destination-ca-certificate-secret** to the Ingress annotations:

```

apiVersion: networking.k8s.io/v1
kind: Ingress
metadata:
  name: frontend
  annotations:
    route.openshift.io/termination: "reencrypt"
    route.openshift.io/destination-ca-certificate-secret: secret-ca-cert 1
  ...

```

1. The annotation references a kubernetes secret.
2. The secret referenced in this annotation will be inserted into the generated route.

Example output

```

apiVersion: route.openshift.io/v1
kind: Route
metadata:
  name: frontend
  annotations:
    route.openshift.io/termination: reencrypt
    route.openshift.io/destination-ca-certificate-secret: secret-ca-cert
spec:
  ...
  tls:
    insecureEdgeTerminationPolicy: Redirect
    termination: reencrypt
    destinationCACertificate: |
      -----BEGIN CERTIFICATE-----
      [...]
      -----END CERTIFICATE-----
  ...

```

30.1.15. Configuring the OpenShift Container Platform Ingress Controller for dual-stack networking

If your OpenShift Container Platform cluster is configured for IPv4 and IPv6 dual-stack networking, your cluster is externally reachable by OpenShift Container Platform routes.

The Ingress Controller automatically serves services that have both IPv4 and IPv6 endpoints, but you can configure the Ingress Controller for single-stack or dual-stack services.

Prerequisites

- You deployed an OpenShift Container Platform cluster on bare metal.
- You installed the OpenShift CLI (**oc**).

Procedure

1. To have the Ingress Controller serve traffic over IPv4/IPv6 to a workload, you can create a service YAML file or modify an existing service YAML file by setting the **ipFamilies** and **ipFamilyPolicy** fields. For example:

Sample service YAML file

```

apiVersion: v1
kind: Service
metadata:
  creationTimestamp: yyyy-mm-ddT00:00:00Z
  labels:
    name: <service_name>
    manager: kubectl-create

```

```

    operation: Update
    time: yyyy-mm-ddT00:00:00Z
    name: <service_name>
    namespace: <namespace_name>
    resourceVersion: "<resource_version_number>"
    selfLink: "/api/v1/namespaces/<namespace_name>/services/<service_name>"
    uid: <uid_number>
spec:
  clusterIP: 172.30.0.0/16
  clusterIPs: ①
  - 172.30.0.0/16
  - <second_IP_address>
  ipFamilies: ②
  - IPv4
  - IPv6
  ipFamilyPolicy: RequireDualStack ③
  ports:
  - port: 8080
    protocol: TCP
    targetport: 8080
  selector:
    name: <namespace_name>
  sessionAffinity: None
  type: ClusterIP
status:
  loadbalancer: {}

```

- ① In a dual-stack instance, there are two different **clusterIPs** provided.
- ② For a single-stack instance, enter **IPv4** or **IPv6**. For a dual-stack instance, enter both **IPv4** and **IPv6**.
- ③ For a single-stack instance, enter **SingleStack**. For a dual-stack instance, enter **RequireDualStack**.

These resources generate corresponding **endpoints**. The Ingress Controller now watches **endpointslices**.

2. To view **endpoints**, enter the following command:

```
$ oc get endpoints
```

3. To view **endpointslices**, enter the following command:

```
$ oc get endpointslices
```

Additional resources

- [Specifying an alternative cluster domain using the appsDomain option](#)

30.2. SECURED ROUTES

Secure routes provide the ability to use several types of TLS termination to serve certificates to the client. The following sections describe how to create re-encrypt, edge, and passthrough routes with custom certificates.



IMPORTANT

If you create routes in Microsoft Azure through public endpoints, the resource names are subject to restriction. You cannot create resources that use certain terms. For a list of terms that Azure restricts, see [Resolve reserved resource name errors](#) in the Azure documentation.

30.2.1. Creating a re-encrypt route with a custom certificate

You can configure a secure route using reencrypt TLS termination with a custom certificate by using the **oc create route** command.

Prerequisites

- You must have a certificate/key pair in PEM-encoded files, where the certificate is valid for the route host.
- You may have a separate CA certificate in a PEM-encoded file that completes the certificate chain.
- You must have a separate destination CA certificate in a PEM-encoded file.
- You must have a service that you want to expose.



NOTE

Password protected key files are not supported. To remove a passphrase from a key file, use the following command:

```
$ openssl rsa -in password_protected_tls.key -out tls.key
```

Procedure

This procedure creates a **Route** resource with a custom certificate and reencrypt TLS termination. The following assumes that the certificate/key pair are in the **tls.crt** and **tls.key** files in the current working directory. You must also specify a destination CA certificate to enable the Ingress Controller to trust the service's certificate. You may also specify a CA certificate if needed to complete the certificate chain. Substitute the actual path names for **tls.crt**, **tls.key**, **ca.cert.crt**, and (optionally) **ca.crt**. Substitute the name of the **Service** resource that you want to expose for **frontend**. Substitute the appropriate hostname for **www.example.com**.

- Create a secure **Route** resource using reencrypt TLS termination and a custom certificate:

```
$ oc create route reencrypt --service=frontend --cert=tls.crt --key=tls.key --dest-ca-cert=destca.crt --ca-cert=ca.crt --hostname=www.example.com
```

If you examine the resulting **Route** resource, it should look similar to the following:

YAML Definition of the Secure Route

```

apiVersion: route.openshift.io/v1
kind: Route
metadata:
  name: frontend
spec:
  host: www.example.com
  to:
    kind: Service
    name: frontend
  tls:
    termination: reencrypt
    key: |-
      -----BEGIN PRIVATE KEY-----
      [...]
      -----END PRIVATE KEY-----
    certificate: |-
      -----BEGIN CERTIFICATE-----
      [...]
      -----END CERTIFICATE-----
    caCertificate: |-
      -----BEGIN CERTIFICATE-----
      [...]
      -----END CERTIFICATE-----
    destinationCACertificate: |-
      -----BEGIN CERTIFICATE-----
      [...]
      -----END CERTIFICATE-----

```

See **oc create route reencrypt --help** for more options.

30.2.2. Creating an edge route with a custom certificate

You can configure a secure route using edge TLS termination with a custom certificate by using the **oc create route** command. With an edge route, the Ingress Controller terminates TLS encryption before forwarding traffic to the destination pod. The route specifies the TLS certificate and key that the Ingress Controller uses for the route.

Prerequisites

- You must have a certificate/key pair in PEM-encoded files, where the certificate is valid for the route host.
- You may have a separate CA certificate in a PEM-encoded file that completes the certificate chain.
- You must have a service that you want to expose.

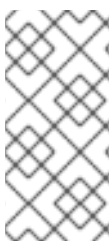

NOTE

Password protected key files are not supported. To remove a passphrase from a key file, use the following command:

```
$ openssl rsa -in password_protected_tls.key -out tls.key
```

Procedure

This procedure creates a **Route** resource with a custom certificate and edge TLS termination. The following assumes that the certificate/key pair are in the **tls.crt** and **tls.key** files in the current working directory. You may also specify a CA certificate if needed to complete the certificate chain. Substitute the actual path names for **tls.crt**, **tls.key**, and (optionally) **ca.crt**. Substitute the name of the service that you want to expose for **frontend**. Substitute the appropriate hostname for **www.example.com**.

- Create a secure **Route** resource using edge TLS termination and a custom certificate.

```
$ oc create route edge --service=frontend --cert=tls.crt --key=tls.key --ca-cert=ca.crt --
hostname=www.example.com
```

If you examine the resulting **Route** resource, it should look similar to the following:

YAML Definition of the Secure Route

```
apiVersion: route.openshift.io/v1
kind: Route
metadata:
  name: frontend
spec:
  host: www.example.com
  to:
    kind: Service
    name: frontend
  tls:
    termination: edge
    key: |-
      -----BEGIN PRIVATE KEY-----
      [...]
      -----END PRIVATE KEY-----
    certificate: |-
      -----BEGIN CERTIFICATE-----
      [...]
      -----END CERTIFICATE-----
    caCertificate: |-
      -----BEGIN CERTIFICATE-----
      [...]
      -----END CERTIFICATE-----
```

See **oc create route edge --help** for more options.

30.2.3. Creating a passthrough route

You can configure a secure route using passthrough termination by using the **oc create route** command. With passthrough termination, encrypted traffic is sent straight to the destination without the router providing TLS termination. Therefore no key or certificate is required on the route.

Prerequisites

- You must have a service that you want to expose.

Procedure

- Create a **Route** resource:

```
$ oc create route passthrough route-passthrough-secured --service=frontend --port=8080
```

If you examine the resulting **Route** resource, it should look similar to the following:

A Secured Route Using Passthrough Termination

```
apiVersion: route.openshift.io/v1
kind: Route
metadata:
  name: route-passthrough-secured 1
spec:
  host: www.example.com
  port:
    targetPort: 8080
  tls:
    termination: passthrough 2
    insecureEdgeTerminationPolicy: None 3
  to:
    kind: Service
    name: frontend
```

- 1 The name of the object, which is limited to 63 characters.
- 2 The **termination** field is set to **passthrough**. This is the only required **tls** field.
- 3 Optional **insecureEdgeTerminationPolicy**. The only valid values are **None**, **Redirect**, or empty for disabled.

The destination pod is responsible for serving certificates for the traffic at the endpoint. This is currently the only method that can support requiring client certificates, also known as two-way authentication.

CHAPTER 31. CONFIGURING INGRESS CLUSTER TRAFFIC

31.1. CONFIGURING INGRESS CLUSTER TRAFFIC OVERVIEW

OpenShift Container Platform provides the following methods for communicating from outside the cluster with services running in the cluster.

The methods are recommended, in order of preference:

- If you have HTTP/HTTPS, use an Ingress Controller.
- If you have a TLS-encrypted protocol other than HTTPS. For example, for TLS with the SNI header, use an Ingress Controller.
- Otherwise, use a Load Balancer, an External IP, or a **NodePort**.

| Method | Purpose |
|---|---|
| Use an Ingress Controller | Allows access to HTTP/HTTPS traffic and TLS-encrypted protocols other than HTTPS (for example, TLS with the SNI header). |
| Automatically assign an external IP using a load balancer service | Allows traffic to non-standard ports through an IP address assigned from a pool. Most cloud platforms offer a method to start a service with a load-balancer IP address. |
| About MetalLB and the MetalLB Operator | Allows traffic to a specific IP address or address from a pool on the machine network. For bare-metal installations or platforms that are like bare metal, MetalLB provides a way to start a service with a load-balancer IP address. |
| Manually assign an external IP to a service | Allows traffic to non-standard ports through a specific IP address. |
| Configure a NodePort | Expose a service on all nodes in the cluster. |

31.1.1. Comparison: Fault tolerant access to external IP addresses

For the communication methods that provide access to an external IP address, fault tolerant access to the IP address is another consideration. The following features provide fault tolerant access to an external IP address.

IP failover

IP failover manages a pool of virtual IP address for a set of nodes. It is implemented with Keepalived and Virtual Router Redundancy Protocol (VRRP). IP failover is a layer 2 mechanism only and relies on multicast. Multicast can have disadvantages for some networks.

MetalLB

MetalLB has a layer 2 mode, but it does not use multicast. Layer 2 mode has a disadvantage that it transfers all traffic for an external IP address through one node.

Manually assigning external IP addresses

You can configure your cluster with an IP address block that is used to assign external IP addresses to services. By default, this feature is disabled. This feature is flexible, but places the largest burden on the cluster or network administrator. The cluster is prepared to receive traffic that is destined for the external IP, but each customer has to decide how they want to route traffic to nodes.

31.2. CONFIGURING EXTERNALIPS FOR SERVICES

As a cluster administrator, you can designate an IP address block that is external to the cluster that can send traffic to services in the cluster.

This functionality is generally most useful for clusters installed on bare-metal hardware.

31.2.1. Prerequisites

- Your network infrastructure must route traffic for the external IP addresses to your cluster.

31.2.2. About ExternalIP

For non-cloud environments, OpenShift Container Platform supports the assignment of external IP addresses to a **Service** object `spec.externalIPs[]` field through the **ExternalIP** facility. By setting this field, OpenShift Container Platform assigns an additional virtual IP address to the service. The IP address can be outside the service network defined for the cluster. A service configured with an ExternalIP functions similarly to a service with `type=NodePort`, allowing you to direct traffic to a local node for load balancing.

You must configure your networking infrastructure to ensure that the external IP address blocks that you define are routed to the cluster. As a result, the IP address is not configured in the network interfaces from nodes. To handle the traffic, you must configure the routing and access to the external IP by using a method such as static Address Resolution Protocol (ARP) entries.

OpenShift Container Platform extends the ExternalIP functionality in Kubernetes by adding the following capabilities:

- Restrictions on the use of external IP addresses by users through a configurable policy
- Allocation of an external IP address automatically to a service upon request



WARNING

Disabled by default, use of ExternalIP functionality can be a security risk, because in-cluster traffic to an external IP address is directed to that service. This could allow cluster users to intercept sensitive traffic destined for external resources.



IMPORTANT

This feature is supported only in non-cloud deployments. For cloud deployments, use the load balancer services for automatic deployment of a cloud load balancer to target the endpoints of a service.

You can assign an external IP address in the following ways:

Automatic assignment of an external IP

OpenShift Container Platform automatically assigns an IP address from the **autoAssignCIDRs** CIDR block to the **spec.externalIPs[]** array when you create a **Service** object with **spec.type=LoadBalancer** set. In this case, OpenShift Container Platform implements a non-cloud version of the load balancer service type and assigns IP addresses to the services. Automatic assignment is disabled by default and must be configured by a cluster administrator as described in the following section.

Manual assignment of an external IP

OpenShift Container Platform uses the IP addresses assigned to the **spec.externalIPs[]** array when you create a **Service** object. You cannot specify an IP address that is already in use by another service.

31.2.2.1. Configuration for ExternalIP

Use of an external IP address in OpenShift Container Platform is governed by the following fields in the **Network.config.openshift.io** CR named **cluster**:

- **spec.externalIP.autoAssignCIDRs** defines an IP address block used by the load balancer when choosing an external IP address for the service. OpenShift Container Platform supports only a single IP address block for automatic assignment. This can be simpler than having to manage the port space of a limited number of shared IP addresses when manually assigning ExternalIPs to services. If automatic assignment is enabled, a **Service** object with **spec.type=LoadBalancer** is allocated an external IP address.
- **spec.externalIP.policy** defines the permissible IP address blocks when manually specifying an IP address. OpenShift Container Platform does not apply policy rules to IP address blocks defined by **spec.externalIP.autoAssignCIDRs**.

If routed correctly, external traffic from the configured external IP address block can reach service endpoints through any TCP or UDP port that the service exposes.



IMPORTANT

As a cluster administrator, you must configure routing to externalIPs on both OpenShiftSDN and OVN-Kubernetes network types. You must also ensure that the IP address block you assign terminates at one or more nodes in your cluster. For more information, see [Kubernetes External IPs](#).

OpenShift Container Platform supports both the automatic and manual assignment of IP addresses, and each address is guaranteed to be assigned to a maximum of one service. This ensures that each service can expose its chosen ports regardless of the ports exposed by other services.



NOTE

To use IP address blocks defined by **autoAssignCIDRs** in OpenShift Container Platform, you must configure the necessary IP address assignment and routing for your host network.

The following YAML describes a service with an external IP address configured:

Example Service object with **spec.externalIPs[]** set

```

apiVersion: v1
kind: Service
metadata:
  name: http-service
spec:
  clusterIP: 172.30.163.110
  externalIPs:
  - 192.168.132.253
  externalTrafficPolicy: Cluster
  ports:
  - name: highport
    nodePort: 31903
    port: 30102
    protocol: TCP
    targetPort: 30102
  selector:
    app: web
  sessionAffinity: None
  type: LoadBalancer
status:
  loadBalancer:
    ingress:
    - ip: 192.168.132.253

```

31.2.2.2. Restrictions on the assignment of an external IP address

As a cluster administrator, you can specify IP address blocks to allow and to reject.

Restrictions apply only to users without **cluster-admin** privileges. A cluster administrator can always set the service **spec.externalIPs[]** field to any IP address.

You configure IP address policy with a **policy** object defined by specifying the **spec.ExternalIP.policy** field. The policy object has the following shape:

```

{
  "policy": {
    "allowedCIDRs": [],
    "rejectedCIDRs": []
  }
}

```

When configuring policy restrictions, the following rules apply:

- If **policy={}** is set, then creating a **Service** object with **spec.ExternalIPs[]** set will fail. This is the default for OpenShift Container Platform. The behavior when **policy=null** is set is identical.
- If **policy** is set and either **policy.allowedCIDRs[]** or **policy.rejectedCIDRs[]** is set, the following rules apply:
 - If **allowedCIDRs[]** and **rejectedCIDRs[]** are both set, then **rejectedCIDRs[]** has precedence over **allowedCIDRs[]**.
 - If **allowedCIDRs[]** is set, creating a **Service** object with **spec.ExternalIPs[]** will succeed only if the specified IP addresses are allowed.

- If **rejectedCIDRs[]** is set, creating a **Service** object with **spec.ExternalIPs[]** will succeed only if the specified IP addresses are not rejected.

31.2.2.3. Example policy objects

The examples that follow demonstrate several different policy configurations.

- In the following example, the policy prevents OpenShift Container Platform from creating any service with an external IP address specified:

Example policy to reject any value specified for Service object **spec.externalIPs[]**

```
apiVersion: config.openshift.io/v1
kind: Network
metadata:
  name: cluster
spec:
  externalIP:
    policy: {}
  ...
```

- In the following example, both the **allowedCIDRs** and **rejectedCIDRs** fields are set.

Example policy that includes both allowed and rejected CIDR blocks

```
apiVersion: config.openshift.io/v1
kind: Network
metadata:
  name: cluster
spec:
  externalIP:
    policy:
      allowedCIDRs:
        - 172.16.66.10/23
      rejectedCIDRs:
        - 172.16.66.10/24
  ...
```

- In the following example, **policy** is set to **null**. If set to **null**, when inspecting the configuration object by entering **oc get networks.config.openshift.io -o yaml**, the **policy** field will not appear in the output.

Example policy to allow any value specified for Service object **spec.externalIPs[]**

```
apiVersion: config.openshift.io/v1
kind: Network
metadata:
  name: cluster
spec:
  externalIP:
    policy: null
  ...
```

31.2.3. ExternalIP address block configuration

The configuration for ExternalIP address blocks is defined by a Network custom resource (CR) named **cluster**. The Network CR is part of the **config.openshift.io** API group.



IMPORTANT

During cluster installation, the Cluster Version Operator (CVO) automatically creates a Network CR named **cluster**. Creating any other CR objects of this type is not supported.

The following YAML describes the ExternalIP configuration:

Network.config.openshift.io CR named **cluster**

```
apiVersion: config.openshift.io/v1
kind: Network
metadata:
  name: cluster
spec:
  externalIP:
    autoAssignCIDRs: [] 1
    policy: 2
    ...
```

- 1** Defines the IP address block in CIDR format that is available for automatic assignment of external IP addresses to a service. Only a single IP address range is allowed.
- 2** Defines restrictions on manual assignment of an IP address to a service. If no restrictions are defined, specifying the **spec.externalIP** field in a **Service** object is not allowed. By default, no restrictions are defined.

The following YAML describes the fields for the **policy** stanza:

Network.config.openshift.io **policy** stanza

```
policy:
  allowedCIDRs: [] 1
  rejectedCIDRs: [] 2
```

- 1** A list of allowed IP address ranges in CIDR format.
- 2** A list of rejected IP address ranges in CIDR format.

Example external IP configurations

Several possible configurations for external IP address pools are displayed in the following examples:

- The following YAML describes a configuration that enables automatically assigned external IP addresses:

Example configuration with **spec.externalIP.autoAssignCIDRs** set

```
apiVersion: config.openshift.io/v1
```

```

kind: Network
metadata:
  name: cluster
spec:
  ...
  externalIP:
    autoAssignCIDRs:
      - 192.168.132.254/29

```

- The following YAML configures policy rules for the allowed and rejected CIDR ranges:

Example configuration with `spec.externalIP.policy` set

```

apiVersion: config.openshift.io/v1
kind: Network
metadata:
  name: cluster
spec:
  ...
  externalIP:
    policy:
      allowedCIDRs:
        - 192.168.132.0/29
        - 192.168.132.8/29
      rejectedCIDRs:
        - 192.168.132.7/32

```

31.2.4. Configure external IP address blocks for your cluster

As a cluster administrator, you can configure the following ExternalIP settings:

- An ExternalIP address block used by OpenShift Container Platform to automatically populate the `spec.clusterIP` field for a **Service** object.
- A policy object to restrict what IP addresses may be manually assigned to the `spec.clusterIP` array of a **Service** object.

Prerequisites

- Install the OpenShift CLI (**oc**).
- Access to the cluster as a user with the **cluster-admin** role.

Procedure

1. Optional: To display the current external IP configuration, enter the following command:

```
$ oc describe networks.config cluster
```

2. To edit the configuration, enter the following command:

```
$ oc edit networks.config cluster
```

3. Modify the ExternalIP configuration, as in the following example:

```

apiVersion: config.openshift.io/v1
kind: Network
metadata:
  name: cluster
spec:
  ...
  externalIP: 1
  ...

```

1 Specify the configuration for the **externalIP** stanza.

4. To confirm the updated ExternalIP configuration, enter the following command:

```
$ oc get networks.config cluster -o go-template='{{.spec.externalIP}}{\n}'
```

31.2.5. Next steps

- [Configuring ingress cluster traffic for a service external IP](#)

31.3. CONFIGURING INGRESS CLUSTER TRAFFIC USING AN INGRESS CONTROLLER

OpenShift Container Platform provides methods for communicating from outside the cluster with services running in the cluster. This method uses an Ingress Controller.

31.3.1. Using Ingress Controllers and routes

The Ingress Operator manages Ingress Controllers and wildcard DNS.

Using an Ingress Controller is the most common way to allow external access to an OpenShift Container Platform cluster.

An Ingress Controller is configured to accept external requests and proxy them based on the configured routes. This is limited to HTTP, HTTPS using SNI, and TLS using SNI, which is sufficient for web applications and services that work over TLS with SNI.

Work with your administrator to configure an Ingress Controller to accept external requests and proxy them based on the configured routes.

The administrator can create a wildcard DNS entry and then set up an Ingress Controller. Then, you can work with the edge Ingress Controller without having to contact the administrators.

By default, every Ingress Controller in the cluster can admit any route created in any project in the cluster.

The Ingress Controller:

- Has two replicas by default, which means it should be running on two worker nodes.
- Can be scaled up to have more replicas on more nodes.

**NOTE**

The procedures in this section require prerequisites performed by the cluster administrator.

31.3.2. Prerequisites

Before starting the following procedures, the administrator must:

- Set up the external port to the cluster networking environment so that requests can reach the cluster.
- Make sure there is at least one user with cluster admin role. To add this role to a user, run the following command:

```
$ oc adm policy add-cluster-role-to-user cluster-admin username
```

- Have an OpenShift Container Platform cluster with at least one master and at least one node and a system outside the cluster that has network access to the cluster. This procedure assumes that the external system is on the same subnet as the cluster. The additional networking required for external systems on a different subnet is out-of-scope for this topic.

31.3.3. Creating a project and service

If the project and service that you want to expose do not exist, first create the project, then the service.

If the project and service already exist, skip to the procedure on exposing the service to create a route.

Prerequisites

- Install the **oc** CLI and log in as a cluster administrator.

Procedure

1. Create a new project for your service by running the **oc new-project** command:

```
$ oc new-project myproject
```

2. Use the **oc new-app** command to create your service:

```
$ oc new-app nodejs:12~https://github.com/sclorg/nodejs-ex.git
```

3. To verify that the service was created, run the following command:

```
$ oc get svc -n myproject
```

Example output

```
NAME      TYPE      CLUSTER-IP    EXTERNAL-IP  PORT(S)    AGE
nodejs-ex ClusterIP  172.30.197.157 <none>       8080/TCP   70s
```

By default, the new service does not have an external IP address.

31.3.4. Exposing the service by creating a route

You can expose the service as a route by using the **oc expose** command.

Procedure

To expose the service:

1. Log in to OpenShift Container Platform.
2. Log in to the project where the service you want to expose is located:

```
$ oc project myproject
```

3. Run the **oc expose service** command to expose the route:

```
$ oc expose service nodejs-ex
```

Example output

```
route.route.openshift.io/nodejs-ex exposed
```

4. To verify that the service is exposed, you can use a tool, such as cURL, to make sure the service is accessible from outside the cluster.
 - a. Use the **oc get route** command to find the route's host name:

```
$ oc get route
```

Example output

| NAME | HOST/PORT | PATH | SERVICES | PORT | TERMINATION |
|-----------|---------------------------------|------|-----------|----------|-------------|
| WILDCARD | | | | | |
| nodejs-ex | nodejs-ex-myproject.example.com | | nodejs-ex | 8080-tcp | None |

- b. Use cURL to check that the host responds to a GET request:

```
$ curl --head nodejs-ex-myproject.example.com
```

Example output

```
HTTP/1.1 200 OK
...
```

31.3.5. Configuring Ingress Controller sharding by using route labels

Ingress Controller sharding by using route labels means that the Ingress Controller serves any route in any namespace that is selected by the route selector.

Figure 31.1. Ingress sharding using route labels

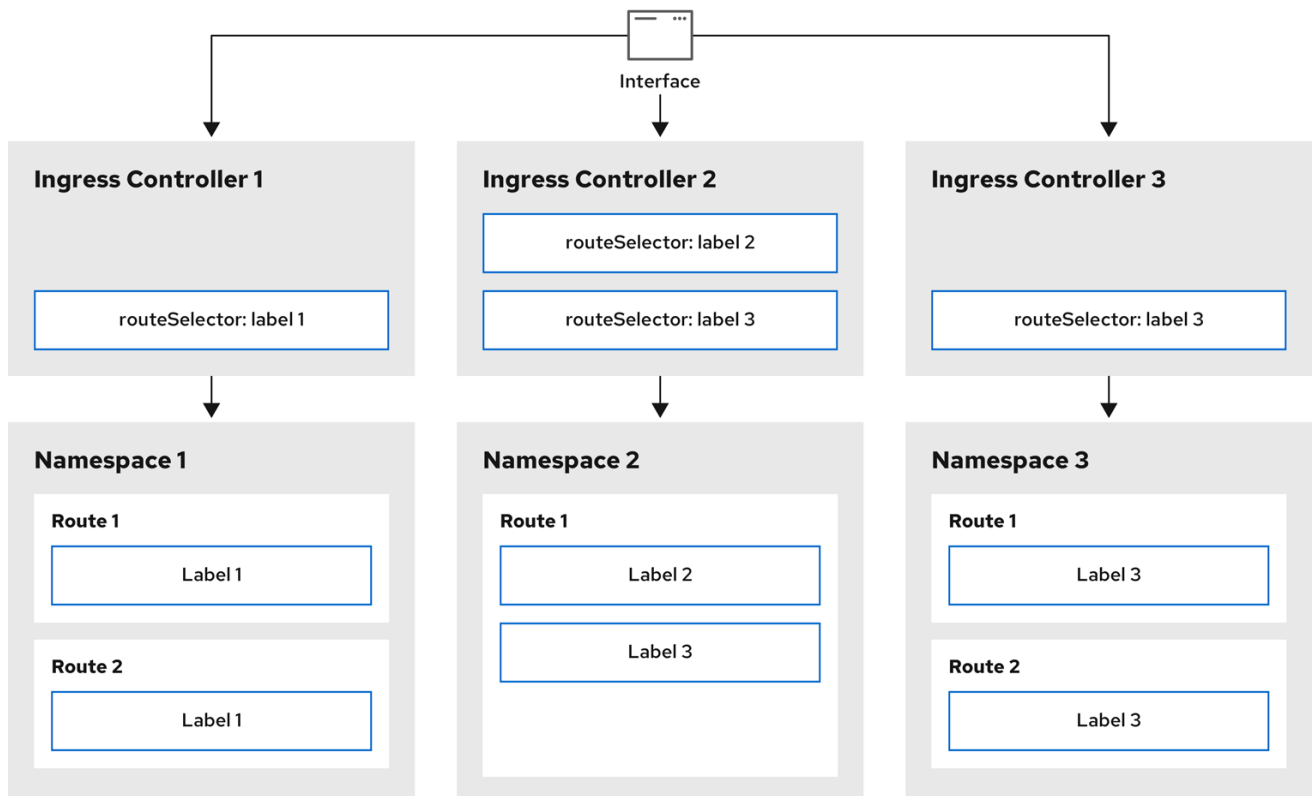

301_OpenShift_0123

Ingress Controller sharding is useful when balancing incoming traffic load among a set of Ingress Controllers and when isolating traffic to a specific Ingress Controller. For example, company A goes to one Ingress Controller and company B to another.

Procedure

1. Edit the **router-internal.yaml** file:

```
# cat router-internal.yaml
apiVersion: operator.openshift.io/v1
kind: IngressController
metadata:
  name: sharded
  namespace: openshift-ingress-operator
spec:
  domain: <apps-sharded.basedomain.example.net> 1
  nodePlacement:
    nodeSelector:
      matchLabels:
        node-role.kubernetes.io/worker: ""
  routeSelector:
    matchLabels:
      type: sharded
```

- 1 Specify a domain to be used by the Ingress Controller. This domain must be different from the default Ingress Controller domain.

2. Apply the Ingress Controller **router-internal.yaml** file:

```
# oc apply -f router-internal.yaml
```

The Ingress Controller selects routes in any namespace that have the label **type: sharded**.

3. Create a new route using the domain configured in the **router-internal.yaml**:

```
$ oc expose svc <service-name> --hostname <route-name>.apps-sharded.basedomain.example.net
```

31.3.6. Configuring Ingress Controller sharding by using namespace labels

Ingress Controller sharding by using namespace labels means that the Ingress Controller serves any route in any namespace that is selected by the namespace selector.

Figure 31.2. Ingress sharding using namespace labels

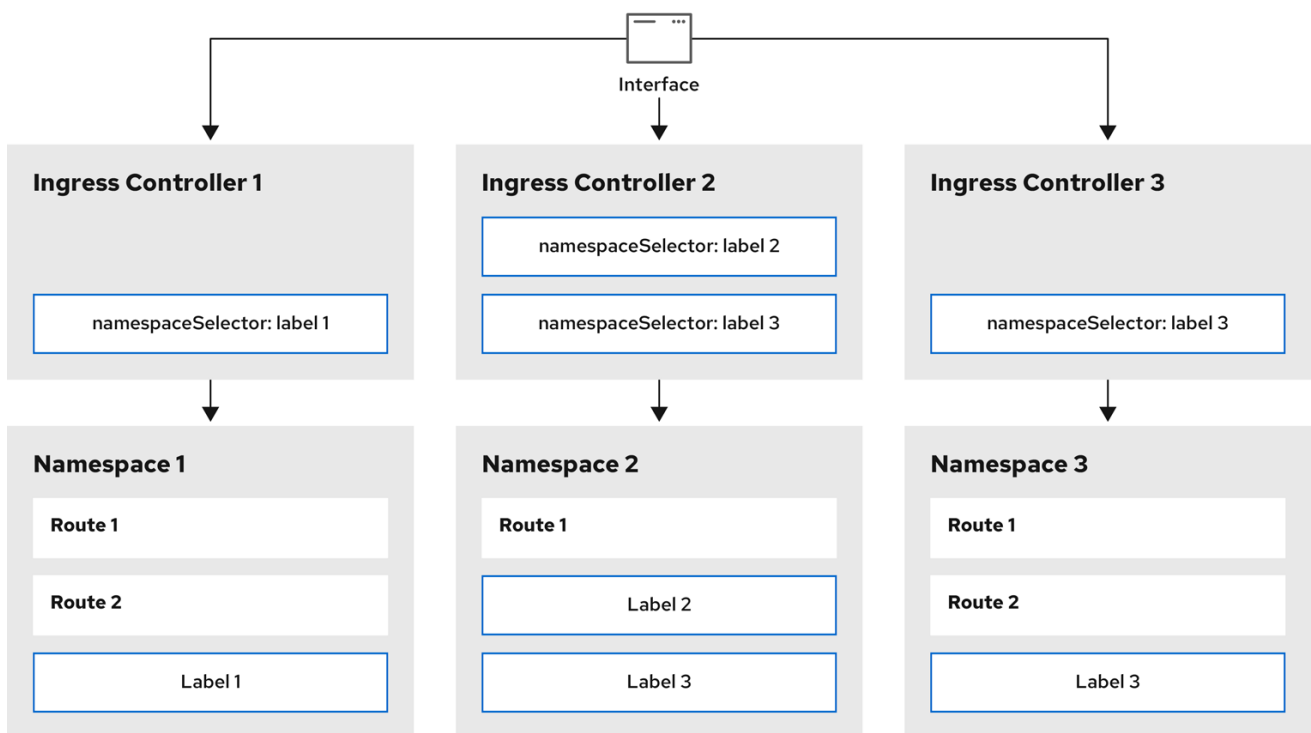

301_OpenShift_0123

Ingress Controller sharding is useful when balancing incoming traffic load among a set of Ingress Controllers and when isolating traffic to a specific Ingress Controller. For example, company A goes to one Ingress Controller and company B to another.

Procedure

1. Edit the **router-internal.yaml** file:

```
# cat router-internal.yaml
```

Example output

```

apiVersion: operator.openshift.io/v1
kind: IngressController
metadata:
  name: sharded
  namespace: openshift-ingress-operator
spec:
  domain: <apps-sharded.basedomain.example.net> 1
  nodePlacement:
    nodeSelector:
      matchLabels:
        node-role.kubernetes.io/worker: ""
  namespaceSelector:
    matchLabels:
      type: sharded

```

- 1 Specify a domain to be used by the Ingress Controller. This domain must be different from the default Ingress Controller domain.

2. Apply the Ingress Controller **router-internal.yaml** file:

```
# oc apply -f router-internal.yaml
```

The Ingress Controller selects routes in any namespace that is selected by the namespace selector that have the label **type: sharded**.

3. Create a new route using the domain configured in the **router-internal.yaml**:

```
$ oc expose svc <service-name> --hostname <route-name>.apps-sharded.basedomain.example.net
```

31.3.7. Creating a route for Ingress Controller sharding

A route allows you to host your application at a URL. In this case, the hostname is not set and the route uses a subdomain instead. When you specify a subdomain, you automatically use the domain of the Ingress Controller that exposes the route. For situations where a route is exposed by multiple Ingress Controllers, the route is hosted at multiple URLs.

The following procedure describes how to create a route for Ingress Controller sharding, using the **hello-openshift** application as an example.

Ingress Controller sharding is useful when balancing incoming traffic load among a set of Ingress Controllers and when isolating traffic to a specific Ingress Controller. For example, company A goes to one Ingress Controller and company B to another.

Prerequisites

- You installed the OpenShift CLI (**oc**).
- You are logged in as a project administrator.
- You have a web application that exposes a port and an HTTP or TLS endpoint listening for traffic on the port.
- You have configured the Ingress Controller for sharding.

Procedure

1. Create a project called **hello-openshift** by running the following command:

```
$ oc new-project hello-openshift
```

2. Create a pod in the project by running the following command:

```
$ oc create -f https://raw.githubusercontent.com/openshift/origin/master/examples/hello-openshift/hello-pod.json
```

3. Create a service called **hello-openshift** by running the following command:

```
$ oc expose pod/hello-openshift
```

4. Create a route definition called **hello-openshift-route.yaml**:

YAML definition of the created route for sharding:

```
apiVersion: route.openshift.io/v1
kind: Route
metadata:
  labels:
    type: sharded 1
  name: hello-openshift-edge
  namespace: hello-openshift
spec:
  subdomain: hello-openshift 2
  tls:
    termination: edge
  to:
    kind: Service
    name: hello-openshift
```

1 Both the label key and its corresponding label value must match the ones specified in the Ingress Controller. In this example, the Ingress Controller has the label key and value **type: sharded**.

2 The route will be exposed using the value of the **subdomain** field. When you specify the **subdomain** field, you must leave the hostname unset. If you specify both the **host** and **subdomain** fields, then the route will use the value of the **host** field, and ignore the **subdomain** field.

5. Use **hello-openshift-route.yaml** to create a route to the **hello-openshift** application by running the following command:

```
$ oc -n hello-openshift create -f hello-openshift-route.yaml
```

Verification

- Get the status of the route with the following command:

```
$ oc -n hello-openshift get routes/hello-openshift-edge -o yaml
```

The resulting **Route** resource should look similar to the following:

Example output

```

apiVersion: route.openshift.io/v1
kind: Route
metadata:
  labels:
    type: sharded
  name: hello-openshift-edge
  namespace: hello-openshift
spec:
  subdomain: hello-openshift
  tls:
    termination: edge
  to:
    kind: Service
    name: hello-openshift
status:
  ingress:
    - host: hello-openshift.<apps-sharded.basedomain.example.net> 1
      routerCanonicalHostname: router-sharded.<apps-sharded.basedomain.example.net> 2
      routerName: sharded 3

```

- 1** The hostname the Ingress Controller, or router, uses to expose the route. The value of the **host** field is automatically determined by the Ingress Controller, and uses its domain. In this example, the domain of the Ingress Controller is **<apps-sharded.basedomain.example.net>**.
- 2** The hostname of the Ingress Controller.
- 3** The name of the Ingress Controller. In this example, the Ingress Controller has the name **sharded**.

31.3.8. Additional resources

The Ingress Operator manages wildcard DNS. For more information, see the following:

- [Ingress Operator in OpenShift Container Platform](#).
- [Installing a cluster on bare metal](#).
- [Installing a cluster on vSphere](#).
- [About network policy](#).

31.4. CONFIGURING INGRESS CLUSTER TRAFFIC USING A LOAD BALANCER

OpenShift Container Platform provides methods for communicating from outside the cluster with services running in the cluster. This method uses a load balancer.

31.4.1. Using a load balancer to get traffic into the cluster

If you do not need a specific external IP address, you can configure a load balancer service to allow external access to an OpenShift Container Platform cluster.

A load balancer service allocates a unique IP. The load balancer has a single edge router IP, which can be a virtual IP (VIP), but is still a single machine for initial load balancing.

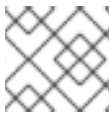

NOTE

If a pool is configured, it is done at the infrastructure level, not by a cluster administrator.



NOTE

The procedures in this section require prerequisites performed by the cluster administrator.

31.4.2. Prerequisites

Before starting the following procedures, the administrator must:

- Set up the external port to the cluster networking environment so that requests can reach the cluster.
- Make sure there is at least one user with cluster admin role. To add this role to a user, run the following command:

```
$ oc adm policy add-cluster-role-to-user cluster-admin username
```

- Have an OpenShift Container Platform cluster with at least one master and at least one node and a system outside the cluster that has network access to the cluster. This procedure assumes that the external system is on the same subnet as the cluster. The additional networking required for external systems on a different subnet is out-of-scope for this topic.

31.4.3. Creating a project and service

If the project and service that you want to expose do not exist, first create the project, then the service.

If the project and service already exist, skip to the procedure on exposing the service to create a route.

Prerequisites

- Install the **oc** CLI and log in as a cluster administrator.

Procedure

1. Create a new project for your service by running the **oc new-project** command:

```
$ oc new-project myproject
```

2. Use the **oc new-app** command to create your service:

```
$ oc new-app nodejs:12~https://github.com/sclorg/nodejs-ex.git
```

- To verify that the service was created, run the following command:

```
$ oc get svc -n myproject
```

Example output

```
NAME      TYPE      CLUSTER-IP    EXTERNAL-IP  PORT(S)    AGE
nodejs-ex ClusterIP  172.30.197.157 <none>      8080/TCP   70s
```

By default, the new service does not have an external IP address.

31.4.4. Exposing the service by creating a route

You can expose the service as a route by using the **oc expose** command.

Procedure

To expose the service:

- Log in to OpenShift Container Platform.
- Log in to the project where the service you want to expose is located:

```
$ oc project myproject
```

- Run the **oc expose service** command to expose the route:

```
$ oc expose service nodejs-ex
```

Example output

```
route.route.openshift.io/nodejs-ex exposed
```

- To verify that the service is exposed, you can use a tool, such as cURL, to make sure the service is accessible from outside the cluster.
 - Use the **oc get route** command to find the route's host name:

```
$ oc get route
```

Example output

```
NAME      HOST/PORT                                PATH  SERVICES  PORT      TERMINATION
WILDCARD
nodejs-ex nodejs-ex-myproject.example.com         nodejs-ex 8080-tcp  None
```

- Use cURL to check that the host responds to a GET request:

```
$ curl --head nodejs-ex-myproject.example.com
```

Example output

```
HTTP/1.1 200 OK
```

```
...
```

31.4.5. Creating a load balancer service

Use the following procedure to create a load balancer service.

Prerequisites

- Make sure that the project and service you want to expose exist.
- Your cloud provider supports load balancers.

Procedure

To create a load balancer service:

1. Log in to OpenShift Container Platform.
2. Load the project where the service you want to expose is located.

```
$ oc project project1
```

3. Open a text file on the control plane node and paste the following text, editing the file as needed:

Sample load balancer configuration file

```
apiVersion: v1
kind: Service
metadata:
  name: egress-2 1
spec:
  ports:
  - name: db
    port: 3306 2
  loadBalancerIP:
  loadBalancerSourceRanges: 3
  - 10.0.0.0/8
  - 192.168.0.0/16
  type: LoadBalancer 4
  selector:
    name: mysql 5
```

- 1** Enter a descriptive name for the load balancer service.
- 2** Enter the same port that the service you want to expose is listening on.
- 3** Enter a list of specific IP addresses to restrict traffic through the load balancer. This field is ignored if the cloud-provider does not support the feature.
- 4** Enter **Loadbalancer** as the type.
- 5** Enter the name of the service.

**NOTE**

To restrict the traffic through the load balancer to specific IP addresses, it is recommended to use the Ingress Controller field **spec.endpointPublishingStrategy.loadBalancer.allowedSourceRanges**. Do not set the **loadBalancerSourceRanges** field.

4. Save and exit the file.
5. Run the following command to create the service:

```
$ oc create -f <file-name>
```

For example:

```
$ oc create -f mysql-lb.yaml
```

6. Execute the following command to view the new service:

```
$ oc get svc
```

Example output

```

NAME      TYPE          CLUSTER-IP    EXTERNAL-IP          PORT(S)
AGE
egress-2  LoadBalancer 172.30.22.226  ad42f5d8b303045-487804948.example.com
3306:30357/TCP 15m
```

The service has an external IP address automatically assigned if there is a cloud provider enabled.

7. On the master, use a tool, such as cURL, to make sure you can reach the service using the public IP address:

```
$ curl <public-ip>:<port>
```

For example:

```
$ curl 172.29.121.74:3306
```

The examples in this section use a MySQL service, which requires a client application. If you get a string of characters with the **Got packets out of order** message, you are connecting with the service:

If you have a MySQL client, log in with the standard CLI command:

```
$ mysql -h 172.30.131.89 -u admin -p
```

Example output

```

Enter password:
Welcome to the MariaDB monitor.  Commands end with ; or \g.
```

```
MySQL [(none)]>
```

31.5. CONFIGURING INGRESS CLUSTER TRAFFIC ON AWS

OpenShift Container Platform provides methods for communicating from outside the cluster with services running in the cluster. This method uses load balancers on AWS, specifically a Network Load Balancer (NLB) or a Classic Load Balancer (CLB). Both types of load balancers can forward the client's IP address to the node, but a CLB requires proxy protocol support, which OpenShift Container Platform automatically enables.

There are two ways to configure an Ingress Controller to use an NLB:

1. By force replacing the Ingress Controller that is currently using a CLB. This deletes the **IngressController** object and an outage will occur while the new DNS records propagate and the NLB is being provisioned.
2. By editing an existing Ingress Controller that uses a CLB to use an NLB. This changes the load balancer without having to delete and recreate the **IngressController** object.

Both methods can be used to switch from an NLB to a CLB.

You can configure these load balancers on a new or existing AWS cluster.

31.5.1. Configuring Classic Load Balancer timeouts on AWS

OpenShift Container Platform provides a method for setting a custom timeout period for a specific route or Ingress Controller. Additionally, an AWS Classic Load Balancer (CLB) has its own timeout period with a default time of 60 seconds.

If the timeout period of the CLB is shorter than the route timeout or Ingress Controller timeout, the load balancer can prematurely terminate the connection. You can prevent this problem by increasing both the timeout period of the route and CLB.

31.5.1.1. Configuring route timeouts

You can configure the default timeouts for an existing route when you have services in need of a low timeout, which is required for Service Level Availability (SLA) purposes, or a high timeout, for cases with a slow back end.

Prerequisites

- You need a deployed Ingress Controller on a running cluster.

Procedure

1. Using the **oc annotate** command, add the timeout to the route:

```
$ oc annotate route <route_name> \
  --overwrite haproxy.router.openshift.io/timeout=<timeout><time_unit> 1
```

- 1 Supported time units are microseconds (us), milliseconds (ms), seconds (s), minutes (m), hours (h), or days (d).

The following example sets a timeout of two seconds on a route named **myroute**:

```
$ oc annotate route myroute --overwrite haproxy.router.openshift.io/timeout=2s
```

31.5.1.2. Configuring Classic Load Balancer timeouts

You can configure the default timeouts for a Classic Load Balancer (CLB) to extend idle connections.

Prerequisites

- You must have a deployed Ingress Controller on a running cluster.

Procedure

- Set an AWS connection idle timeout of five minutes for the default **ingresscontroller** by running the following command:

```
$ oc -n openshift-ingress-operator patch ingresscontroller/default \
  --type=merge --patch='{"spec":{"endpointPublishingStrategy": \
  {"type":"LoadBalancerService", "loadBalancer": \
  {"scope":"External", "providerParameters":{"type":"AWS", "aws": \
  {"type":"Classic", "classicLoadBalancer": \
  {"connectionIdleTimeout":"5m"}}}}}}}'
```

- Optional: Restore the default value of the timeout by running the following command:

```
$ oc -n openshift-ingress-operator patch ingresscontroller/default \
  --type=merge --patch='{"spec":{"endpointPublishingStrategy": \
  {"loadBalancer":{"providerParameters":{"aws":{"classicLoadBalancer": \
  {"connectionIdleTimeout":null}}}}}}}'
```



NOTE

You must specify the **scope** field when you change the connection timeout value unless the current scope is already set. When you set the **scope** field, you do not need to do so again if you restore the default timeout value.

31.5.2. Configuring ingress cluster traffic on AWS using a Network Load Balancer

OpenShift Container Platform provides methods for communicating from outside the cluster with services that run in the cluster. One such method uses a Network Load Balancer (NLB). You can configure an NLB on a new or existing AWS cluster.

31.5.2.1. Switching the Ingress Controller from using a Classic Load Balancer to a Network Load Balancer

You can switch the Ingress Controller that is using a Classic Load Balancer (CLB) to one that uses a Network Load Balancer (NLB) on AWS.

Switching between these load balancers will not delete the **IngressController** object.

**WARNING**

This procedure might cause the following issues:

- An outage that can last several minutes due to new DNS records propagation, new load balancers provisioning, and other factors. IP addresses and canonical names of the Ingress Controller load balancer might change after applying this procedure.
- Leaked load balancer resources due to a change in the annotation of the service.

Procedure

1. Modify the existing Ingress Controller that you want to switch to using an NLB. This example assumes that your default Ingress Controller has an **External** scope and no other customizations:

Example ingresscontroller.yaml file

```

apiVersion: operator.openshift.io/v1
kind: IngressController
metadata:
  creationTimestamp: null
  name: default
  namespace: openshift-ingress-operator
spec:
  endpointPublishingStrategy:
    loadBalancer:
      scope: External
      providerParameters:
        type: AWS
      aws:
        type: NLB
    type: LoadBalancerService

```

**NOTE**

If you do not specify a value for the **spec.endpointPublishingStrategy.loadBalancer.providerParameters.aws.type** field, the Ingress Controller uses the **spec.loadBalancer.platform.aws.type** value from the cluster **Ingress** configuration that was set during installation.

TIP

If your Ingress Controller has other customizations that you want to update, such as changing the domain, consider force replacing the Ingress Controller definition file instead.

2. Apply the changes to the Ingress Controller YAML file by running the command:

```
$ oc apply -f ingresscontroller.yaml
```

Expect several minutes of outages while the Ingress Controller updates.

31.5.2.2. Switching the Ingress Controller from using a Network Load Balancer to a Classic Load Balancer

You can switch the Ingress Controller that is using a Network Load Balancer (NLB) to one that uses a Classic Load Balancer (CLB) on AWS.

Switching between these load balancers will not delete the **IngressController** object.



WARNING

This procedure might cause an outage that can last several minutes due to new DNS records propagation, new load balancers provisioning, and other factors. IP addresses and canonical names of the Ingress Controller load balancer might change after applying this procedure.

Procedure

1. Modify the existing Ingress Controller that you want to switch to using a CLB. This example assumes that your default Ingress Controller has an **External** scope and no other customizations:

Example ingresscontroller.yaml file

```
apiVersion: operator.openshift.io/v1
kind: IngressController
metadata:
  creationTimestamp: null
  name: default
  namespace: openshift-ingress-operator
spec:
  endpointPublishingStrategy:
    loadBalancer:
      scope: External
      providerParameters:
        type: AWS
      aws:
        type: Classic
    type: LoadBalancerService
```



NOTE

If you do not specify a value for the **spec.endpointPublishingStrategy.loadBalancer.providerParameters.aws.type** field, the Ingress Controller uses the **spec.loadBalancer.platform.aws.type** value from the cluster **Ingress** configuration that was set during installation.

TIP

If your Ingress Controller has other customizations that you want to update, such as changing the domain, consider force replacing the Ingress Controller definition file instead.

2. Apply the changes to the Ingress Controller YAML file by running the command:

```
$ oc apply -f ingresscontroller.yaml
```

Expect several minutes of outages while the Ingress Controller updates.

31.5.2.3. Replacing Ingress Controller Classic Load Balancer with Network Load Balancer

You can replace an Ingress Controller that is using a Classic Load Balancer (CLB) with one that uses a Network Load Balancer (NLB) on AWS.

**WARNING**

This procedure might cause the following issues:

- An outage that can last several minutes due to new DNS records propagation, new load balancers provisioning, and other factors. IP addresses and canonical names of the Ingress Controller load balancer might change after applying this procedure.
- Leaked load balancer resources due to a change in the annotation of the service.

Procedure

1. Create a file with a new default Ingress Controller. The following example assumes that your default Ingress Controller has an **External** scope and no other customizations:

Example ingresscontroller.yml file

```
apiVersion: operator.openshift.io/v1
kind: IngressController
metadata:
  creationTimestamp: null
  name: default
  namespace: openshift-ingress-operator
spec:
  endpointPublishingStrategy:
    loadBalancer:
      scope: External
      providerParameters:
        type: AWS
      aws:
        type: NLB
    type: LoadBalancerService
```

If your default Ingress Controller has other customizations, ensure that you modify the file accordingly.

TIP

If your Ingress Controller has no other customizations and you are only updating the load balancer type, consider following the procedure detailed in "Switching the Ingress Controller from using a Classic Load Balancer to a Network Load Balancer".

- Force replace the Ingress Controller YAML file:

```
$ oc replace --force --wait -f ingresscontroller.yml
```

Wait until the Ingress Controller is replaced. Expect several of minutes of outages.

31.5.2.4. Configuring an Ingress Controller Network Load Balancer on an existing AWS cluster

You can create an Ingress Controller backed by an AWS Network Load Balancer (NLB) on an existing cluster.

Prerequisites

- You must have an installed AWS cluster.
- PlatformStatus** of the infrastructure resource must be AWS.
 - To verify that the **PlatformStatus** is AWS, run:

```
$ oc get infrastructure/cluster -o jsonpath='{.status.platformStatus.type}'
AWS
```

Procedure

Create an Ingress Controller backed by an AWS NLB on an existing cluster.

- Create the Ingress Controller manifest:

```
$ cat ingresscontroller-aws-nlb.yaml
```

Example output

```
apiVersion: operator.openshift.io/v1
kind: IngressController
metadata:
  name: $my_ingress_controller 1
  namespace: openshift-ingress-operator
spec:
  domain: $my_unique_ingress_domain 2
  endpointPublishingStrategy:
    type: LoadBalancerService
  loadBalancer:
    scope: External 3
  providerParameters:
```

```
type: AWS
aws:
  type: NLB
```

- 1 Replace **\$my_ingress_controller** with a unique name for the Ingress Controller.
- 2 Replace **\$my_unique_ingress_domain** with a domain name that is unique among all Ingress Controllers in the cluster. This variable must be a subdomain of the DNS name **<clustername>.<domain>**.
- 3 You can replace **External** with **Internal** to use an internal NLB.

2. Create the resource in the cluster:

```
$ oc create -f ingresscontroller-aws-nlb.yaml
```



IMPORTANT

Before you can configure an Ingress Controller NLB on a new AWS cluster, you must complete the [Creating the installation configuration file](#) procedure.

31.5.2.5. Configuring an Ingress Controller Network Load Balancer on a new AWS cluster

You can create an Ingress Controller backed by an AWS Network Load Balancer (NLB) on a new cluster.

Prerequisites

- Create the **install-config.yaml** file and complete any modifications to it.

Procedure

Create an Ingress Controller backed by an AWS NLB on a new cluster.

1. Change to the directory that contains the installation program and create the manifests:

```
$ ./openshift-install create manifests --dir <installation_directory> 1
```

- 1 For **<installation_directory>**, specify the name of the directory that contains the **install-config.yaml** file for your cluster.

2. Create a file that is named **cluster-ingress-default-ingresscontroller.yaml** in the **<installation_directory>/manifests/** directory:

```
$ touch <installation_directory>/manifests/cluster-ingress-default-ingresscontroller.yaml 1
```

- 1 For **<installation_directory>**, specify the directory name that contains the **manifests/** directory for your cluster.

After creating the file, several network configuration files are in the **manifests/** directory, as shown:

```
$ ls <installation_directory>/manifests/cluster-ingress-default-ingresscontroller.yaml
```

■

Example output

```
cluster-ingress-default-ingresscontroller.yaml
```

- Open the **cluster-ingress-default-ingresscontroller.yaml** file in an editor and enter a custom resource (CR) that describes the Operator configuration you want:

```
apiVersion: operator.openshift.io/v1
kind: IngressController
metadata:
  creationTimestamp: null
  name: default
  namespace: openshift-ingress-operator
spec:
  endpointPublishingStrategy:
    loadBalancer:
      scope: External
      providerParameters:
        type: AWS
      aws:
        type: NLB
    type: LoadBalancerService
```

- Save the **cluster-ingress-default-ingresscontroller.yaml** file and quit the text editor.
- Optional: Back up the **manifests/cluster-ingress-default-ingresscontroller.yaml** file. The installation program deletes the **manifests/** directory when creating the cluster.

31.5.3. Additional resources

- [Installing a cluster on AWS with network customizations](#) .
- For more information on support for NLBs, see [Network Load Balancer support on AWS](#) .
- For more information on proxy protocol support for CLBs, see [Configure proxy protocol support for your Classic Load Balancer](#) .

31.6. CONFIGURING INGRESS CLUSTER TRAFFIC FOR A SERVICE EXTERNAL IP

You can attach an external IP address to a service so that it is available to traffic outside the cluster. This is generally useful only for a cluster installed on bare metal hardware. The external network infrastructure must be configured correctly to route traffic to the service.

31.6.1. Prerequisites

- Your cluster is configured with ExternalIPs enabled. For more information, read [Configuring ExternalIPs for services](#) .



NOTE

Do not use the same ExternalIP for the egress IP.

31.6.2. Attaching an ExternalIP to a service

You can attach an ExternalIP to a service. If your cluster is configured to allocate an ExternalIP automatically, you might not need to manually attach an ExternalIP to the service.

Procedure

- Optional: To confirm what IP address ranges are configured for use with ExternalIP, enter the following command:

```
$ oc get networks.config cluster -o jsonpath='{.spec.externalIP}'
```

If **autoAssignCIDRs** is set, OpenShift Container Platform automatically assigns an ExternalIP to a new **Service** object if the **spec.externalIPs** field is not specified.

- Attach an ExternalIP to the service.
 - If you are creating a new service, specify the **spec.externalIPs** field and provide an array of one or more valid IP addresses. For example:

```
apiVersion: v1
kind: Service
metadata:
  name: svc-with-externalip
spec:
  ...
  externalIPs:
  - 192.174.120.10
```

- If you are attaching an ExternalIP to an existing service, enter the following command. Replace **<name>** with the service name. Replace **<ip_address>** with a valid ExternalIP address. You can provide multiple IP addresses separated by commas.

```
$ oc patch svc <name> -p \
{
  "spec": {
    "externalIPs": [ "<ip_address>" ]
  }
}
```

For example:

```
$ oc patch svc mysql-55-rhel7 -p '{"spec":{"externalIPs":["192.174.120.10"]}]'
```

Example output

```
"mysql-55-rhel7" patched
```

- To confirm that an ExternalIP address is attached to the service, enter the following command. If you specified an ExternalIP for a new service, you must create the service first.

```
$ oc get svc
```

Example output

| NAME | CLUSTER-IP | EXTERNAL-IP | PORT(S) | AGE |
|----------------|---------------|----------------|----------|-----|
| mysql-55-rhel7 | 172.30.131.89 | 192.174.120.10 | 3306/TCP | 13m |

31.6.3. Additional resources

- [Configuring ExternalIPs for services](#)

31.7. CONFIGURING INGRESS CLUSTER TRAFFIC USING A NODEPORT

OpenShift Container Platform provides methods for communicating from outside the cluster with services running in the cluster. This method uses a **NodePort**.

31.7.1. Using a NodePort to get traffic into the cluster

Use a **NodePort**-type **Service** resource to expose a service on a specific port on all nodes in the cluster. The port is specified in the **Service** resource's `.spec.ports[*].nodePort` field.



IMPORTANT

Using a node port requires additional port resources.

A **NodePort** exposes the service on a static port on the node's IP address. **NodePorts** are in the **30000** to **32767** range by default, which means a **NodePort** is unlikely to match a service's intended port. For example, port **8080** may be exposed as port **31020** on the node.

The administrator must ensure the external IP addresses are routed to the nodes.

NodePorts and external IPs are independent and both can be used concurrently.



NOTE

The procedures in this section require prerequisites performed by the cluster administrator.

31.7.2. Prerequisites

Before starting the following procedures, the administrator must:

- Set up the external port to the cluster networking environment so that requests can reach the cluster.
- Make sure there is at least one user with cluster admin role. To add this role to a user, run the following command:

```
$ oc adm policy add-cluster-role-to-user cluster-admin <user_name>
```

- Have an OpenShift Container Platform cluster with at least one master and at least one node and a system outside the cluster that has network access to the cluster. This procedure assumes that the external system is on the same subnet as the cluster. The additional networking required for external systems on a different subnet is out-of-scope for this topic.

31.7.3. Creating a project and service

If the project and service that you want to expose do not exist, first create the project, then the service.

If the project and service already exist, skip to the procedure on exposing the service to create a route.

Prerequisites

- Install the **oc** CLI and log in as a cluster administrator.

Procedure

1. Create a new project for your service by running the **oc new-project** command:

```
$ oc new-project myproject
```

2. Use the **oc new-app** command to create your service:

```
$ oc new-app nodejs:12~https://github.com/sclorg/nodejs-ex.git
```

3. To verify that the service was created, run the following command:

```
$ oc get svc -n myproject
```

Example output

```
NAME      TYPE      CLUSTER-IP    EXTERNAL-IP  PORT(S)    AGE
nodejs-ex ClusterIP  172.30.197.157 <none>      8080/TCP   70s
```

By default, the new service does not have an external IP address.

31.7.4. Exposing the service by creating a route

You can expose the service as a route by using the **oc expose** command.

Procedure

To expose the service:

1. Log in to OpenShift Container Platform.
2. Log in to the project where the service you want to expose is located:

```
$ oc project myproject
```

3. To expose a node port for the application, modify the custom resource definition (CRD) of a service by entering the following command:

```
$ oc edit svc <service_name>
```

Example output

```
spec:
  ports:
  - name: 8443-tcp
```

```
nodePort: 30327 1
port: 8443
protocol: TCP
targetPort: 8443
sessionAffinity: None
type: NodePort 2
```

- 1** Optional: Specify the node port range for the application. By default, OpenShift Container Platform selects an available port in the **30000-32767** range.
- 2** Define the service type.

4. Optional: To confirm the service is available with a node port exposed, enter the following command:

```
$ oc get svc -n myproject
```

Example output

```
NAME           TYPE        CLUSTER-IP    EXTERNAL-IP  PORT(S)          AGE
nodejs-ex      ClusterIP   172.30.217.127 <none>       3306/TCP         9m44s
nodejs-ex-ingress NodePort    172.30.107.72  <none>       3306:31345/TCP  39s
```

5. Optional: To remove the service created automatically by the **oc new-app** command, enter the following command:

```
$ oc delete svc nodejs-ex
```

Verification

- To check that the service node port is updated with a port in the **30000-32767** range, enter the following command:

```
$ oc get svc
```

In the following example output, the updated port is **30327**:

Example output

```
NAME  TYPE        CLUSTER-IP    EXTERNAL-IP  PORT(S)          AGE
httpd NodePort    172.xx.xx.xx  <none>       8443:30327/TCP  109s
```

31.7.5. Additional resources

- [Configuring the node port service range](#)

31.8. CONFIGURING INGRESS CLUSTER TRAFFIC USING LOAD BALANCER ALLOWED SOURCE RANGES

You can specify a list of IP address ranges for the **IngressController**. This restricts access to the load balancer service when the **endpointPublishingStrategy** is **LoadBalancerService**.

31.8.1. Configuring load balancer allowed source ranges

You can enable and configure the **spec.endpointPublishingStrategy.loadBalancer.allowedSourceRanges** field. By configuring load balancer allowed source ranges, you can limit the access to the load balancer for the Ingress Controller to a specified list of IP address ranges. The Ingress Operator reconciles the load balancer Service and sets the **spec.loadBalancerSourceRanges** field based on **AllowedSourceRanges**.



NOTE

If you have already set the **spec.loadBalancerSourceRanges** field or the load balancer service annotation **service.beta.kubernetes.io/load-balancer-source-ranges** in a previous version of OpenShift Container Platform, Ingress Controller starts reporting **Progressing=True** after an upgrade. To fix this, set **AllowedSourceRanges** that overwrites the **spec.loadBalancerSourceRanges** field and clears the **service.beta.kubernetes.io/load-balancer-source-ranges** annotation. Ingress Controller starts reporting **Progressing=False** again.

Prerequisites

- You have a deployed Ingress Controller on a running cluster.

Procedure

- Set the allowed source ranges API for the Ingress Controller by running the following command:

```
$ oc -n openshift-ingress-operator patch ingresscontroller/default \
  --type=merge --patch='{"spec":{"endpointPublishingStrategy":{"loadBalancer":{"allowedSourceRanges":["0.0.0.0/0"]}}}}' 1
```

- 1** The example value **0.0.0.0/0** specifies the allowed source range.

31.8.2. Migrating to load balancer allowed source ranges

If you have already set the annotation **service.beta.kubernetes.io/load-balancer-source-ranges**, you can migrate to load balancer allowed source ranges. When you set the **AllowedSourceRanges**, the Ingress Controller sets the **spec.loadBalancerSourceRanges** field based on the **AllowedSourceRanges** value and unsets the **service.beta.kubernetes.io/load-balancer-source-ranges** annotation.



NOTE

If you have already set the **spec.loadBalancerSourceRanges** field or the load balancer service annotation **service.beta.kubernetes.io/load-balancer-source-ranges** in a previous version of OpenShift Container Platform, the Ingress Controller starts reporting **Progressing=True** after an upgrade. To fix this, set **AllowedSourceRanges** that overwrites the **spec.loadBalancerSourceRanges** field and clears the **service.beta.kubernetes.io/load-balancer-source-ranges** annotation. The Ingress Controller starts reporting **Progressing=False** again.

Prerequisites

- You have set the **service.beta.kubernetes.io/load-balancer-source-ranges** annotation.

Procedure

1. Ensure that the **service.beta.kubernetes.io/load-balancer-source-ranges** is set:

```
$ oc get svc router-default -n openshift-ingress -o yaml
```

Example output

```
apiVersion: v1
kind: Service
metadata:
  annotations:
    service.beta.kubernetes.io/load-balancer-source-ranges: 192.168.0.1/32
```

2. Ensure that the **spec.loadBalancerSourceRanges** field is unset:

```
$ oc get svc router-default -n openshift-ingress -o yaml
```

Example output

```
...
spec:
  loadBalancerSourceRanges:
  - 0.0.0.0/0
...
```

3. Update your cluster to OpenShift Container Platform 4.15.
4. Set the allowed source ranges API for the **ingresscontroller** by running the following command:

```
$ oc -n openshift-ingress-operator patch ingresscontroller/default \
  --type=merge --patch='{"spec":{"endpointPublishingStrategy": \
  {"loadBalancer":{"allowedSourceRanges":["0.0.0.0/0"]}}}' 1
```

- 1** The example value **0.0.0.0/0** specifies the allowed source range.

31.8.3. Additional resources

- [Introduction to OpenShift updates](#)

CHAPTER 32. KUBERNETES NMSTATE

32.1. ABOUT THE KUBERNETES NMSTATE OPERATOR

The Kubernetes NMState Operator provides a Kubernetes API for performing state-driven network configuration across the OpenShift Container Platform cluster's nodes with NMState. The Kubernetes NMState Operator provides users with functionality to configure various network interface types, DNS, and routing on cluster nodes. Additionally, the daemons on the cluster nodes periodically report on the state of each node's network interfaces to the API server.



IMPORTANT

Red Hat supports the Kubernetes NMState Operator in production environments on bare-metal, IBM Power®, IBM Z®, IBM® LinuxONE, VMware vSphere, and OpenStack installations.

Before you can use NMState with OpenShift Container Platform, you must install the Kubernetes NMState Operator.



NOTE

The Kubernetes NMState Operator updates the network configuration of a secondary NIC. It cannot update the network configuration of the primary NIC or the **br-ex** bridge.

OpenShift Container Platform uses **nmstate** to report on and configure the state of the node network. This makes it possible to modify the network policy configuration, such as by creating a Linux bridge on all nodes, by applying a single configuration manifest to the cluster.

Node networking is monitored and updated by the following objects:

NodeNetworkState

Reports the state of the network on that node.

NodeNetworkConfigurationPolicy

Describes the requested network configuration on nodes. You update the node network configuration, including adding and removing interfaces, by applying a **NodeNetworkConfigurationPolicy** manifest to the cluster.

NodeNetworkConfigurationEnactment

Reports the network policies enacted upon each node.

32.1.1. Installing the Kubernetes NMState Operator

You can install the Kubernetes NMState Operator by using the web console or the CLI.

32.1.1.1. Installing the Kubernetes NMState Operator by using the web console

You can install the Kubernetes NMState Operator by using the web console. After it is installed, the Operator can deploy the NMState State Controller as a daemon set across all of the cluster nodes.

Prerequisites

- You are logged in as a user with **cluster-admin** privileges.

Procedure

1. Select **Operators** → **OperatorHub**.
2. In the search field below **All Items**, enter **nmstate** and click **Enter** to search for the Kubernetes NMState Operator.
3. Click on the Kubernetes NMState Operator search result.
4. Click on **Install** to open the **Install Operator** window.
5. Click **Install** to install the Operator.
6. After the Operator finishes installing, click **View Operator**.
7. Under **Provided APIs**, click **Create Instance** to open the dialog box for creating an instance of **kubernetes-nmstate**.
8. In the **Name** field of the dialog box, ensure the name of the instance is **nmstate**.



NOTE

The name restriction is a known issue. The instance is a singleton for the entire cluster.

9. Accept the default settings and click **Create** to create the instance.

Summary

Once complete, the Operator has deployed the NMState State Controller as a daemon set across all of the cluster nodes.

32.1.1.2. Installing the Kubernetes NMState Operator using the CLI

You can install the Kubernetes NMState Operator by using the OpenShift CLI (**oc**). After it is installed, the Operator can deploy the NMState State Controller as a daemon set across all of the cluster nodes.

Prerequisites

- You have installed the OpenShift CLI (**oc**).
- You are logged in as a user with **cluster-admin** privileges.

Procedure

1. Create the **nmstate** Operator namespace:

```
$ cat << EOF | oc apply -f -
apiVersion: v1
kind: Namespace
metadata:
  labels:
    kubernetes.io/metadata.name: openshift-nmstate
  name: openshift-nmstate
  name: openshift-nmstate
spec:
```

```
finalizers:
- kubernetes
EOF
```

2. Create the **OperatorGroup**:

```
$ cat << EOF | oc apply -f -
apiVersion: operators.coreos.com/v1
kind: OperatorGroup
metadata:
  annotations:
    olm.providedAPIs: NMState.v1.nmstate.io
  name: openshift-nmstate
  namespace: openshift-nmstate
spec:
  targetNamespaces:
  - openshift-nmstate
EOF
```

3. Subscribe to the **nmstate** Operator:

```
$ cat << EOF | oc apply -f -
apiVersion: operators.coreos.com/v1alpha1
kind: Subscription
metadata:
  labels:
    operators.coreos.com/kubernetes-nmstate-operator.openshift-nmstate: ""
  name: kubernetes-nmstate-operator
  namespace: openshift-nmstate
spec:
  channel: stable
  installPlanApproval: Automatic
  name: kubernetes-nmstate-operator
  source: redhat-operators
  sourceNamespace: openshift-marketplace
EOF
```

4. Confirm the **ClusterServiceVersion** (CSV) status for the **nmstate** Operator deployment equals **Succeeded**:

```
$ oc get clusterserviceversion -n openshift-nmstate \
-o custom-columns=Name:.metadata.name,Phase:.status.phase
```

Example output

```
Name                               Phase
kubernetes-nmstate-operator.4.15.0-202210210157  Succeeded
```

5. Create an instance of the **nmstate** Operator:

```
$ cat << EOF | oc apply -f -
apiVersion: nmstate.io/v1
kind: NMState
```



```

metadata:
  name: nmstate
EOF

```

- Verify the pods for NMState Operator are running:

```
$ oc get pod -n openshift-nmstate
```

Example output

```

Name                                Ready Status Restarts Age
pod/nmstate-cert-manager-5b47d8ddf-5wnb5 1/1 Running 0 77s
pod/nmstate-console-plugin-d6b76c6b9-4dcwm 1/1 Running 0 77s
pod/nmstate-handler-6v7rm                1/1 Running 0 77s
pod/nmstate-handler-bjcxw                1/1 Running 0 77s
pod/nmstate-handler-fv6m2                1/1 Running 0 77s
pod/nmstate-handler-kb8j6                1/1 Running 0 77s
pod/nmstate-handler-wn55p                1/1 Running 0 77s
pod/nmstate-operator-f6bb869b6-v5m92     1/1 Running 0 4m51s
pod/nmstate-webhook-66d6bbd84b-6n674    1/1 Running 0 77s
pod/nmstate-webhook-66d6bbd84b-vlzrd    1/1 Running 0 77s

```

32.2. OBSERVING AND UPDATING THE NODE NETWORK STATE AND CONFIGURATION

32.2.1. Viewing the network state of a node by using the CLI

Node network state is the network configuration for all nodes in the cluster. A **NodeNetworkState** object exists on every node in the cluster. This object is periodically updated and captures the state of the network for that node.

Procedure

- List all the **NodeNetworkState** objects in the cluster:

```
$ oc get nns
```

- Inspect a **NodeNetworkState** object to view the network on that node. The output in this example has been redacted for clarity:

```
$ oc get nns node01 -o yaml
```

Example output

```

apiVersion: nmstate.io/v1
kind: NodeNetworkState
metadata:
  name: node01 1
status:
  currentState: 2
  dns-resolver:
# ...

```

```

    interfaces:
# ...
    route-rules:
# ...
    routes:
# ...
    lastSuccessfulUpdateTime: "2020-01-31T12:14:00Z" 3

```

- 1 The name of the **NodeNetworkState** object is taken from the node.
- 2 The **currentState** contains the complete network configuration for the node, including DNS, interfaces, and routes.
- 3 Timestamp of the last successful update. This is updated periodically as long as the node is reachable and can be used to evaluate the freshness of the report.

32.2.2. Viewing the network state of a node from the web console

As an administrator, you can use the OpenShift Container Platform web console to observe **NodeNetworkState** resources and network interfaces, and access network details.

Procedure

1. Navigate to **Networking** → **NodeNetworkState**.
In the **NodeNetworkState** page, you can view the list of **NodeNetworkState** resources and the corresponding interfaces that are created on the nodes. You can use **Filter** based on **Interface state**, **Interface type**, and **IP**, or the search bar based on criteria **Name** or **Label**, to narrow down the displayed **NodeNetworkState** resources.
2. To access the detailed information about **NodeNetworkState** resource, click the **NodeNetworkState** resource name listed in the **Name** column.
3. to expand and view the **Network Details** section for the **NodeNetworkState** resource, click the > icon. Alternatively, you can click on each interface type under the **Network interface** column to view the network details.

32.2.3. Managing policy from the web console

You can update the node network configuration, such as adding or removing interfaces from nodes, by applying **NodeNetworkConfigurationPolicy** manifests to the cluster. Manage the policy from the web console by accessing the list of created policies in the **NodeNetworkConfigurationPolicy** page under the **Networking** menu. This page enables you to create, update, monitor, and delete the policies.

32.2.3.1. Monitoring the policy status

You can monitor the policy status from the **NodeNetworkConfigurationPolicy** page. This page displays all the policies created in the cluster in a tabular format, with the following columns:

Name

The name of the policy created.

Matched nodes

The count of nodes where the policies are applied. This could be either a subset of nodes based on the node selector or all the nodes on the cluster.

Node network state

The enactment state of the matched nodes. You can click on the enactment state and view detailed information on the status.

To find the desired policy, you can filter the list either based on enactment state by using the **Filter** option, or by using the search option.

32.2.3.2. Creating a policy

You can create a policy by using either a form or YAML in the web console.

Procedure

1. Navigate to **Networking** → **NodeNetworkConfigurationPolicy**.
2. In the **NodeNetworkConfigurationPolicy** page, click **Create**, and select **From Form** option. In case there are no existing policies, you can alternatively click **Create NodeNetworkConfigurationPolicy** to create a policy using form.

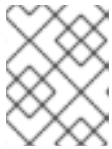

NOTE

To create policy using YAML, click **Create**, and select **With YAML** option. The following steps are applicable to create a policy only by using form.

3. Optional: Check the **Apply this NodeNetworkConfigurationPolicy only to specific subsets of nodes using the node selector** checkbox to specify the nodes where the policy must be applied.
4. Enter the policy name in the **Policy name** field.
5. Optional: Enter the description of the policy in the **Description** field.
6. Optional: In the **Policy Interface(s)** section, a bridge interface is added by default with preset values in editable fields. Edit the values by executing the following steps:
 - a. Enter the name of the interface in **Interface name** field.
 - b. Select the network state from **Network state** dropdown. The default selected value is **Up**.
 - c. Select the type of interface from **Type** dropdown. The available values are **Bridge**, **Bonding**, and **Ethernet**. The default selected value is **Bridge**.



NOTE

Addition of a VLAN interface by using the form is not supported. To add a VLAN interface, you must use YAML to create the policy. Once added, you cannot edit the policy by using form.

- d. Optional: In the IP configuration section, check **IPv4** checkbox to assign an IPv4 address to the interface, and configure the IP address assignment details:
 - i. Click **IP address** to configure the interface with a static IP address, or **DHCP** to auto-assign an IP address.

- ii. If you have selected **IP address** option, enter the IPv4 address in **IPV4 address** field, and enter the prefix length in **Prefix length** field.
If you have selected **DHCP** option, uncheck the options that you want to disable. The available options are **Auto-DNS**, **Auto-routes**, and **Auto-gateway**. All the options are selected by default.
- e. Optional: Enter the port number in **Port** field.
- f. Optional: Check the checkbox **Enable STP** to enable STP.
- g. Optional: To add an interface to the policy, click **Add another interface to the policy**
- h. Optional: To remove an interface from the policy, click 

icon next to the interface.



NOTE

Alternatively, you can click **Edit YAML** on the top of the page to continue editing the form using YAML.

7. Click **Create** to complete policy creation.

32.2.3.3. Updating the policy

32.2.3.3.1. Updating the policy by using form

Procedure

1. Navigate to **Networking** → **NodeNetworkConfigurationPolicy**.
2. In the **NodeNetworkConfigurationPolicy** page, click the  icon placed next to the policy you want to edit, and click **Edit**.
3. Edit the fields that you want to update.
4. Click **Save**.



NOTE

Addition of a VLAN interface using the form is not supported. To add a VLAN interface, you must use YAML to create the policy. Once added, you cannot edit the policy using form.

32.2.3.3.2. Updating the policy by using YAML

Procedure

1. Navigate to **Networking** → **NodeNetworkConfigurationPolicy**.
2. In the **NodeNetworkConfigurationPolicy** page, click the policy name under the **Name** column for the policy you want to edit.
3. Click the **YAML** tab, and edit the YAML.
4. Click **Save**.

32.2.3.4. Deleting the policy

Procedure

1. Navigate to **Networking** → **NodeNetworkConfigurationPolicy**.
2. In the **NodeNetworkConfigurationPolicy** page, click the  icon placed next to the policy you want to delete, and click **Delete**.
3. In the pop-up window, enter the policy name to confirm deletion, and click **Delete**.

32.2.4. Managing policy by using the CLI

32.2.4.1. Creating an interface on nodes

Create an interface on nodes in the cluster by applying a **NodeNetworkConfigurationPolicy** manifest to the cluster. The manifest details the requested configuration for the interface.

By default, the manifest applies to all nodes in the cluster. To add the interface to specific nodes, add the **spec: nodeSelector** parameter and the appropriate **<key>:<value>** for your node selector.

You can configure multiple nmstate-enabled nodes concurrently. The configuration applies to 50% of the nodes in parallel. This strategy prevents the entire cluster from being unavailable if the network connection fails. To apply the policy configuration in parallel to a specific portion of the cluster, use the **maxUnavailable** field.

Procedure

1. Create the **NodeNetworkConfigurationPolicy** manifest. The following example configures a Linux bridge on all worker nodes and configures the DNS resolver:

```
apiVersion: nmstate.io/v1
kind: NodeNetworkConfigurationPolicy
metadata:
  name: br1-eth1-policy ①
spec:
  nodeSelector: ②
    node-role.kubernetes.io/worker: "" ③
  maxUnavailable: 3 ④
```

```

desiredState:
  interfaces:
    - name: br1
      description: Linux bridge with eth1 as a port 5
      type: linux-bridge
      state: up
      ipv4:
        dhcp: true
        enabled: true
        auto-dns: false
      bridge:
        options:
          stp:
            enabled: false
        port:
          - name: eth1
  dns-resolver: 6
  config:
    search:
      - example.com
      - example.org
    server:
      - 8.8.8.8

```

- 1** Name of the policy.
- 2** Optional: If you do not include the **nodeSelector** parameter, the policy applies to all nodes in the cluster.
- 3** This example uses the **node-role.kubernetes.io/worker: ""** node selector to select all worker nodes in the cluster.
- 4** Optional: Specifies the maximum number of nmstate-enabled nodes that the policy configuration can be applied to concurrently. This parameter can be set to either a percentage value (string), for example, **"10%"**, or an absolute value (number), such as **3**.
- 5** Optional: Human-readable description for the interface.
- 6** Optional: Specifies the search and server settings for the DNS server.

2. Create the node network policy:

```
$ oc apply -f br1-eth1-policy.yaml 1
```

- 1** File name of the node network configuration policy manifest.

Additional resources

- [Example for creating multiple interfaces in the same policy](#)
- [Examples of different IP management methods in policies](#)

32.2.4.2. Confirming node network policy updates on nodes

A **NodeNetworkConfigurationPolicy** manifest describes your requested network configuration for nodes in the cluster. The node network policy includes your requested network configuration and the status of execution of the policy on the cluster as a whole.

When you apply a node network policy, a **NodeNetworkConfigurationEnactment** object is created for every node in the cluster. The node network configuration enactment is a read-only object that represents the status of execution of the policy on that node. If the policy fails to be applied on the node, the enactment for that node includes a traceback for troubleshooting.

Procedure

1. To confirm that a policy has been applied to the cluster, list the policies and their status:

```
$ oc get nncp
```

2. Optional: If a policy is taking longer than expected to successfully configure, you can inspect the requested state and status conditions of a particular policy:

```
$ oc get nncp <policy> -o yaml
```

3. Optional: If a policy is taking longer than expected to successfully configure on all nodes, you can list the status of the enactments on the cluster:

```
$ oc get nnce
```

4. Optional: To view the configuration of a particular enactment, including any error reporting for a failed configuration:

```
$ oc get nnce <node>.<policy> -o yaml
```

32.2.4.3. Removing an interface from nodes

You can remove an interface from one or more nodes in the cluster by editing the **NodeNetworkConfigurationPolicy** object and setting the **state** of the interface to **absent**.

Removing an interface from a node does not automatically restore the node network configuration to a previous state. If you want to restore the previous state, you will need to define that node network configuration in the policy.

If you remove a bridge or bonding interface, any node NICs in the cluster that were previously attached or subordinate to that bridge or bonding interface are placed in a **down** state and become unreachable. To avoid losing connectivity, configure the node NIC in the same policy so that it has a status of **up** and either DHCP or a static IP address.



NOTE

Deleting the node network policy that added an interface does not change the configuration of the policy on the node. Although a **NodeNetworkConfigurationPolicy** is an object in the cluster, it only represents the requested configuration. Similarly, removing an interface does not delete the policy.

Procedure

1. Update the **NodeNetworkConfigurationPolicy** manifest used to create the interface. The following example removes a Linux bridge and configures the **eth1** NIC with DHCP to avoid losing connectivity:

```

apiVersion: nmstate.io/v1
kind: NodeNetworkConfigurationPolicy
metadata:
  name: <br1-eth1-policy> ❶
spec:
  nodeSelector: ❷
    node-role.kubernetes.io/worker: "" ❸
desiredState:
  interfaces:
    - name: br1
      type: linux-bridge
      state: absent ❹
    - name: eth1 ❺
      type: ethernet ❻
      state: up ❼
      ipv4:
        dhcp: true ❽
        enabled: true ❾

```

- ❶ Name of the policy.
- ❷ Optional: If you do not include the **nodeSelector** parameter, the policy applies to all nodes in the cluster.
- ❸ This example uses the **node-role.kubernetes.io/worker: ""** node selector to select all worker nodes in the cluster.
- ❹ Changing the state to **absent** removes the interface.
- ❺ The name of the interface that is to be unattached from the bridge interface.
- ❻ The type of interface. This example creates an Ethernet networking interface.
- ❼ The requested state for the interface.
- ❽ Optional: If you do not use **dhcp**, you can either set a static IP or leave the interface without an IP address.
- ❾ Enables **ipv4** in this example.

2. Update the policy on the node and remove the interface:

```
$ oc apply -f <br1-eth1-policy.yaml> ❶
```

- ❶ File name of the policy manifest.

32.2.5. Example policy configurations for different interfaces

The following examples show different **NodeNetworkConfigurationPolicy** manifest configurations.

For best performance, consider the following factors when applying a policy:

- When you need to apply a policy to more than one node, create a **NodeNetworkConfigurationPolicy** manifest for each target node. Scoping a policy to a single node reduces the overall length of time for the Kubernetes NMState Operator to apply the policies.
In contrast, if a single policy includes configurations for several nodes, the Kubernetes NMState Operator applies the policy to each node in sequence, which increases the overall length of time for policy application.
- All related network configurations should be specified in a single policy.
When a node restarts, the Kubernetes NMState Operator cannot control the order in which policies are applied. Therefore, the Kubernetes NMState Operator might apply interdependent policies in a sequence that results in a degraded network object.

32.2.5.1. Example: Linux bridge interface node network configuration policy

Create a Linux bridge interface on nodes in the cluster by applying a **NodeNetworkConfigurationPolicy** manifest to the cluster.

The following YAML file is an example of a manifest for a Linux bridge interface. It includes sample values that you must replace with your own information.

```
apiVersion: nmstate.io/v1
kind: NodeNetworkConfigurationPolicy
metadata:
  name: br1-eth1-policy 1
spec:
  nodeSelector: 2
    kubernetes.io/hostname: <node01> 3
  desiredState:
    interfaces:
      - name: br1 4
        description: Linux bridge with eth1 as a port 5
        type: linux-bridge 6
        state: up 7
        ipv4:
          dhcp: true 8
          enabled: true 9
        bridge:
          options:
            stp:
              enabled: false 10
        port:
          - name: eth1 11
```

- 1 Name of the policy.
- 2 Optional: If you do not include the **nodeSelector** parameter, the policy applies to all nodes in the cluster.
- 3 This example uses a **hostname** node selector.
- 4 Name of the interface.

- 5 Optional: Human-readable description of the interface.
- 6 The type of interface. This example creates a bridge.
- 7 The requested state for the interface after creation.
- 8 Optional: If you do not use **dhcp**, you can either set a static IP or leave the interface without an IP address.
- 9 Enables **ipv4** in this example.
- 10 Disables **stp** in this example.
- 11 The node NIC to which the bridge attaches.

32.2.5.2. Example: VLAN interface node network configuration policy

Create a VLAN interface on nodes in the cluster by applying a **NodeNetworkConfigurationPolicy** manifest to the cluster.



NOTE

Define all related configurations for the VLAN interface of a node in a single **NodeNetworkConfigurationPolicy** manifest. For example, define the VLAN interface for a node and the related routes for the VLAN interface in the same **NodeNetworkConfigurationPolicy** manifest.

When a node restarts, the Kubernetes NMState Operator cannot control the order in which policies are applied. Therefore, if you use separate policies for related network configurations, the Kubernetes NMState Operator might apply these policies in a sequence that results in a degraded network object.

The following YAML file is an example of a manifest for a VLAN interface. It includes samples values that you must replace with your own information.

```
apiVersion: nmstate.io/v1
kind: NodeNetworkConfigurationPolicy
metadata:
  name: vlan-eth1-policy 1
spec:
  nodeSelector: 2
    kubernetes.io/hostname: <node01> 3
  desiredState:
    interfaces:
      - name: eth1.102 4
        description: VLAN using eth1 5
        type: vlan 6
        state: up 7
        vlan:
          base-iface: eth1 8
          id: 102 9
```

- 1 Name of the policy.

- 2 Optional: If you do not include the **nodeSelector** parameter, the policy applies to all nodes in the cluster.
- 3 This example uses a **hostname** node selector.
- 4 Name of the interface. When deploying on bare metal, only the **<interface_name>**. **<vlan_number>** VLAN format is supported.
- 5 Optional: Human-readable description of the interface.
- 6 The type of interface. This example creates a VLAN.
- 7 The requested state for the interface after creation.
- 8 The node NIC to which the VLAN is attached.
- 9 The VLAN tag.

32.2.5.3. Example: Node network configuration policy for virtual functions (Technology Preview)

Update host network settings for Single Root I/O Virtualization (SR-IOV) network virtual functions (VF) in an existing cluster by applying a **NodeNetworkConfigurationPolicy** manifest.



IMPORTANT

Updating host network settings for SR-IOV network VFs is a Technology Preview feature only. Technology Preview features are not supported with Red Hat production service level agreements (SLAs) and might not be functionally complete. Red Hat does not recommend using them in production. These features provide early access to upcoming product features, enabling customers to test functionality and provide feedback during the development process.

For more information about the support scope of Red Hat Technology Preview features, see [Technology Preview Features Support Scope](#).

You can apply a **NodeNetworkConfigurationPolicy** manifest to an existing cluster to complete the following tasks:

- Configure QoS or MTU host network settings for VFs to optimize performance.
- Add, remove, or update VFs for a network interface.
- Manage VF bonding configurations.



NOTE

To update host network settings for SR-IOV VFs by using NMState on physical functions that are also managed through the SR-IOV Network Operator, you must set the **externallyManaged** parameter in the relevant **SriovNetworkNodePolicy** resource to **true**. For more information, see the *Additional resources* section.

The following YAML file is an example of a manifest that defines QoS policies for a VF. This file includes samples values that you must replace with your own information.

```

apiVersion: nmstate.io/v1
kind: NodeNetworkConfigurationPolicy
metadata:
  name: qos 1
spec:
  nodeSelector: 2
    node-role.kubernetes.io/worker: "" 3
  desiredState:
    interfaces:
      - name: ens1f0 4
        description: Change QOS on VF0 5
        type: ethernet 6
        state: up 7
        ethernet:
          sr-iov:
            total-vfs: 3 8
            vfs:
              - id: 0 9
                max-tx-rate: 200 10

```

- 1 Name of the policy.
- 2 Optional: If you do not include the **nodeSelector** parameter, the policy applies to all nodes in the cluster.
- 3 This example applies to all nodes with the **worker** role.
- 4 Name of the physical function (PF) network interface.
- 5 Optional: Human-readable description of the interface.
- 6 The type of interface.
- 7 The requested state for the interface after configuration.
- 8 The total number of VFs.
- 9 Identifies the VF with an ID of **0**.
- 10 Sets a maximum transmission rate, in Mbps, for the VF. This sample value sets a rate of 200 Mbps.

The following YAML file is an example of a manifest that creates a VLAN interface on top of a VF and adds it to a bonded network interface. It includes sample values that you must replace with your own information.

```

apiVersion: nmstate.io/v1
kind: NodeNetworkConfigurationPolicy
metadata:
  name: addvf 1
spec:
  nodeSelector: 2
    node-role.kubernetes.io/worker: "" 3
  maxUnavailable: 3

```

```

desiredState:
  interfaces:
    - name: ens1f0v1 4
      type: ethernet
      state: up
    - name: ens1f0v1.477 5
      type: vlan
      state: up
      vlan:
        base-iface: ens1f0v1 6
        id: 477
    - name: bond0 7
      description: Add vf 8
      type: bond 9
      state: up 10
      link-aggregation:
        mode: active-backup 11
        options:
          primary: ens1f1v0.477 12
        port: 13
          - ens1f1v0.477
          - ens1f0v0.477
          - ens1f0v1.477 14

```

- 1 Name of the policy.
- 2 Optional: If you do not include the **nodeSelector** parameter, the policy applies to all nodes in the cluster.
- 3 This example applies to all nodes with the **worker** role.
- 4 Name of the VF network interface.
- 5 Name of the VLAN network interface.
- 6 The VF network interface to which the VLAN interface is attached.
- 7 Name of the bonding network interface.
- 8 Optional: Human-readable description of the interface.
- 9 The type of interface.
- 10 The requested state for the interface after configuration.
- 11 The bonding policy for the bond.
- 12 The primary attached bonding port.
- 13 The ports for the bonded network interface.
- 14 In this example, this VLAN network interface is added as an additional interface to the bonded network interface.

Additional resources

- [Configuring an SR-IOV network device](#)

32.2.5.4. Example: Bond interface node network configuration policy

Create a bond interface on nodes in the cluster by applying a **NodeNetworkConfigurationPolicy** manifest to the cluster.



NOTE

OpenShift Container Platform only supports the following bond modes:

- mode=1 active-backup
- mode=2 balance-xor
- mode=4 802.3ad
- mode=5 balance-tlb
- mode=6 balance-alb

The following YAML file is an example of a manifest for a bond interface. It includes sample values that you must replace with your own information.

```
apiVersion: nmstate.io/v1
kind: NodeNetworkConfigurationPolicy
metadata:
  name: bond0-eth1-eth2-policy 1
spec:
  nodeSelector: 2
    kubernetes.io/hostname: <node01> 3
  desiredState:
    interfaces:
      - name: bond0 4
        description: Bond with ports eth1 and eth2 5
        type: bond 6
        state: up 7
        ipv4:
          dhcp: true 8
          enabled: true 9
        link-aggregation:
          mode: active-backup 10
          options:
            miimon: '140' 11
        port: 12
          - eth1
          - eth2
        mtu: 1450 13
```

- 1 Name of the policy.

- 2 Optional: If you do not include the **nodeSelector** parameter, the policy applies to all nodes in the cluster.
- 3 This example uses a **hostname** node selector.
- 4 Name of the interface.
- 5 Optional: Human-readable description of the interface.
- 6 The type of interface. This example creates a bond.
- 7 The requested state for the interface after creation.
- 8 Optional: If you do not use **dhcp**, you can either set a static IP or leave the interface without an IP address.
- 9 Enables **ipv4** in this example.
- 10 The driver mode for the bond. This example uses an active backup mode.
- 11 Optional: This example uses **miimon** to inspect the bond link every 140ms.
- 12 The subordinate node NICs in the bond.
- 13 Optional: The maximum transmission unit (MTU) for the bond. If not specified, this value is set to **1500** by default.

32.2.5.5. Example: Ethernet interface node network configuration policy

Configure an Ethernet interface on nodes in the cluster by applying a **NodeNetworkConfigurationPolicy** manifest to the cluster.

The following YAML file is an example of a manifest for an Ethernet interface. It includes sample values that you must replace with your own information.

```

apiVersion: nmstate.io/v1
kind: NodeNetworkConfigurationPolicy
metadata:
  name: eth1-policy 1
spec:
  nodeSelector: 2
    kubernetes.io/hostname: <node01> 3
  desiredState:
    interfaces:
      - name: eth1 4
        description: Configuring eth1 on node01 5
        type: ethernet 6
        state: up 7
        ipv4:
          dhcp: true 8
          enabled: true 9

```

- 1 Name of the policy.

- 2 Optional: If you do not include the **nodeSelector** parameter, the policy applies to all nodes in the cluster.
- 3 This example uses a **hostname** node selector.
- 4 Name of the interface.
- 5 Optional: Human-readable description of the interface.
- 6 The type of interface. This example creates an Ethernet networking interface.
- 7 The requested state for the interface after creation.
- 8 Optional: If you do not use **dhcp**, you can either set a static IP or leave the interface without an IP address.
- 9 Enables **ipv4** in this example.

32.2.5.6. Example: Multiple interfaces in the same node network configuration policy

You can create multiple interfaces in the same node network configuration policy. These interfaces can reference each other, allowing you to build and deploy a network configuration by using a single policy manifest.

The following example YAML file creates a bond that is named **bond10** across two NICs and VLAN that is named **bond10.103** that connects to the bond.

```

apiVersion: nmstate.io/v1
kind: NodeNetworkConfigurationPolicy
metadata:
  name: bond-vlan 1
spec:
  nodeSelector: 2
    kubernetes.io/hostname: <node01> 3
  desiredState:
    interfaces:
      - name: bond10 4
        description: Bonding eth2 and eth3 5
        type: bond 6
        state: up 7
        link-aggregation:
          mode: balance-rr 8
        options:
          miimon: '140' 9
        port: 10
        - eth2
        - eth3
      - name: bond10.103 11
        description: vlan using bond10 12
        type: vlan 13
        state: up 14
        vlan:
          base-iface: bond10 15

```



```

id: 103 16
ipv4:
  dhcp: true 17
  enabled: true 18

```

- 1** Name of the policy.
- 2** Optional: If you do not include the **nodeSelector** parameter, the policy applies to all nodes in the cluster.
- 3** This example uses **hostname** node selector.
- 4** **11** Name of the interface.
- 5** **12** Optional: Human-readable description of the interface.
- 6** **13** The type of interface.
- 7** **14** The requested state for the interface after creation.
- 8** The driver mode for the bond.
- 9** Optional: This example uses **miimon** to inspect the bond link every 140ms.
- 10** The subordinate node NICs in the bond.
- 15** The node NIC to which the VLAN is attached.
- 16** The VLAN tag.
- 17** Optional: If you do not use **dhcp**, you can either set a static IP or leave the interface without an IP address.
- 18** Enables **ipv4** in this example.

32.2.5.7. Example: Network interface with a VRF instance node network configuration policy

Associate a Virtual Routing and Forwarding (VRF) instance with a network interface by applying a **NodeNetworkConfigurationPolicy** custom resource (CR).

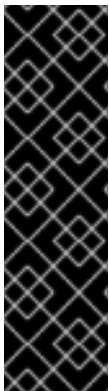

IMPORTANT

Associating a VRF instance with a network interface is a Technology Preview feature only. Technology Preview features are not supported with Red Hat production service level agreements (SLAs) and might not be functionally complete. Red Hat does not recommend using them in production. These features provide early access to upcoming product features, enabling customers to test functionality and provide feedback during the development process.

For more information about the support scope of Red Hat Technology Preview features, see [Technology Preview Features Support Scope](#).

By associating a VRF instance with a network interface, you can support traffic isolation, independent routing decisions, and the logical separation of network resources.

In a bare-metal environment, you can announce load balancer services through interfaces belonging to a VRF instance by using MetalLB. For more information, see the *Additional resources* section.

The following YAML file is an example of associating a VRF instance to a network interface. It includes samples values that you must replace with your own information.

```
apiVersion: nmstate.io/v1
kind: NodeNetworkConfigurationPolicy
metadata:
  name: vrfpolicy 1
spec:
  nodeSelector:
    vrf: "true" 2
  maxUnavailable: 3
  desiredState:
    interfaces:
      - name: ens4vrf 3
        type: vrf 4
        state: up
        vrf:
          port:
            - ens4 5
          route-table-id: 2 6
```

- 1 The name of the policy.
- 2 This example applies the policy to all nodes with the label **vrf:true**.
- 3 The name of the interface.
- 4 The type of interface. This example creates a VRF instance.
- 5 The node interface to which the VRF attaches.
- 6 The name of the route table ID for the VRF.

Additional resources

- [About virtual routing and forwarding](#)
- [Exposing a service through a network VRF](#)

32.2.6. Capturing the static IP of a NIC attached to a bridge



IMPORTANT

Capturing the static IP of a NIC is a Technology Preview feature only. Technology Preview features are not supported with Red Hat production service level agreements (SLAs) and might not be functionally complete. Red Hat does not recommend using them in production. These features provide early access to upcoming product features, enabling customers to test functionality and provide feedback during the development process.

For more information about the support scope of Red Hat Technology Preview features, see [Technology Preview Features Support Scope](#).

32.2.6.1. Example: Linux bridge interface node network configuration policy to inherit static IP address from the NIC attached to the bridge

Create a Linux bridge interface on nodes in the cluster and transfer the static IP configuration of the NIC to the bridge by applying a single **NodeNetworkConfigurationPolicy** manifest to the cluster.

The following YAML file is an example of a manifest for a Linux bridge interface. It includes sample values that you must replace with your own information.

```
apiVersion: nmstate.io/v1
kind: NodeNetworkConfigurationPolicy
metadata:
  name: br1-eth1-copy-ipv4-policy ❶
spec:
  nodeSelector: ❷
    node-role.kubernetes.io/worker: ""
  capture:
    eth1-nic: interfaces.name=="eth1" ❸
    eth1-routes: routes.running.next-hop-interface=="eth1"
    br1-routes: capture.eth1-routes | routes.running.next-hop-interface := "br1"
  desiredState:
    interfaces:
      - name: br1
        description: Linux bridge with eth1 as a port
        type: linux-bridge ❹
        state: up
        ipv4: "{{ capture.eth1-nic.interfaces.0.ipv4 }}" ❺
        bridge:
          options:
            stp:
              enabled: false
          port:
            - name: eth1 ❻
        routes:
          config: "{{ capture.br1-routes.routes.running }}"
```

- ❶ The name of the policy.
- ❷ Optional: If you do not include the **nodeSelector** parameter, the policy applies to all nodes in the cluster. This example uses the **node-role.kubernetes.io/worker: ""** node selector to select all worker nodes in the cluster.
- ❸ The reference to the node NIC to which the bridge attaches.

- 4 The type of interface. This example creates a bridge.
- 5 The IP address of the bridge interface. This value matches the IP address of the NIC which is referenced by the **spec.capture.eth1-nic** entry.
- 6 The node NIC to which the bridge attaches.

Additional resources

- [The NMPolicy project - Policy syntax](#)

32.2.7. Examples: IP management

The following example configuration snippets demonstrate different methods of IP management.

These examples use the **ethernet** interface type to simplify the example while showing the related context in the policy configuration. These IP management examples can be used with the other interface types.

32.2.7.1. Static

The following snippet statically configures an IP address on the Ethernet interface:

```
# ...
interfaces:
  - name: eth1
    description: static IP on eth1
    type: ethernet
    state: up
    ipv4:
      dhcp: false
      address:
        - ip: 192.168.122.250 1
          prefix-length: 24
      enabled: true
# ...
```

- 1 Replace this value with the static IP address for the interface.

32.2.7.2. No IP address

The following snippet ensures that the interface has no IP address:

```
# ...
interfaces:
  - name: eth1
    description: No IP on eth1
    type: ethernet
    state: up
    ipv4:
      enabled: false
# ...
```

32.2.7.3. Dynamic host configuration

The following snippet configures an Ethernet interface that uses a dynamic IP address, gateway address, and DNS:

```
# ...
interfaces:
  - name: eth1
    description: DHCP on eth1
    type: ethernet
    state: up
    ipv4:
      dhcp: true
      enabled: true
# ...
```

The following snippet configures an Ethernet interface that uses a dynamic IP address but does not use a dynamic gateway address or DNS:

```
# ...
interfaces:
  - name: eth1
    description: DHCP without gateway or DNS on eth1
    type: ethernet
    state: up
    ipv4:
      dhcp: true
      auto-gateway: false
      auto-dns: false
      enabled: true
# ...
```

32.2.7.4. DNS

By default, the **nmstate** API stores DNS values globally as against storing them in a network interface. For certain situations, you must configure a network interface to store DNS values. To define a DNS configuration for a network interface, you must initially specify the **dns-resolver** section in the network interface's YAML configuration file.

TIP

Setting a DNS configuration is comparable to modifying the **/etc/resolv.conf** file.

The following examples show situations that require configuring a network interface to store DNS values:

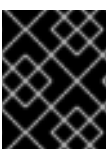

IMPORTANT

You cannot use **br-ex** bridge, an OVNKubernetes-managed Open vSwitch bridge, as the interface when configuring DNS resolvers.

- Configure a static DNS for a network interface with an automatic IP configuration. Note that for this configuration, you must set the **auto-dns** parameter to **false**, so that the Kubernetes NMState Operator can store custom DNS settings for the network interface.

```
dns-resolver:
  config:
    search:
      - example.com
      - example.org
    server:
      - 2001:db8:f::1
      - 192.0.2.251
  interfaces:
    - name: eth1
      type: ethernet
      state: up
      ipv4:
        enabled: true
        dhcp: true
        auto-dns: false
      ipv6:
        enabled: true
        dhcp: true
        autoconf: true
        auto-dns: false
# ...
```

- Configure a static DNS for a network interface with a static IP configuration. Note that for this configuration, you must set the **dhcp** parameter to **false** and the **autoconf** parameter to **false**.

```
dns-resolver:
  config:
# ...
    server:
      - 2001:4860:4860::8844
      - 192.0.2.251
  interfaces:
    - name: eth1
      type: ethernet
      state: up
      ipv4:
        enabled: true
        dhcp: false
        address:
          - ip: 192.0.2.251
            prefix-length: 24
      ipv6:
        enabled: true
        dhcp: false
        autoconf: false
        address:
          - ip: 2001:db8:1::1
            prefix-length: 64
  routes:
    config:
      - destination: 0.0.0.0/0
```

```

next-hop-address: 192.0.2.1
next-hop-interface: eth1
- destination: ::0
next-hop-address: 2001:db8:1::3
next-hop-interface: eth1
# ...

```

- Configure a static DNS name server to append to Dynamic Host Configuration Protocol (DHCP) and IPv6 Stateless Address AutoConfiguration (SLAAC) servers:

```

dns-resolver:
  config:
  # ...
  server:
  - 192.0.2.251
interfaces:
- name: eth1
  type: ethernet
  state: up
  ipv4:
    enabled: true
    dhcp: true
    auto-dns: true
  ipv6:
    enabled: true
    dhcp: true
    autoconf: true
    auto-dns: true
# ...

```

32.2.7.5. Static routing

The following snippet configures a static route and a static IP on interface **eth1**.

```

dns-resolver:
  config:
  # ...
interfaces:
- name: eth1
  description: Static routing on eth1
  type: ethernet
  state: up
  ipv4:
    dhcp: false
    enabled: true
    address:
    - ip: 192.0.2.251 1
      prefix-length: 24
routes:
  config:
  - destination: 198.51.100.0/24
    metric: 150
    next-hop-address: 192.0.2.1 2

```

```

next-hop-interface: eth1
table-id: 254
# ...

```

- 1 The static IP address for the Ethernet interface.
- 2 Next hop address for the node traffic. This must be in the same subnet as the IP address set for the Ethernet interface.

32.3. TROUBLESHOOTING NODE NETWORK CONFIGURATION

If the node network configuration encounters an issue, the policy is automatically rolled back and the enactments report failure. This includes issues such as:

- The configuration fails to be applied on the host.
- The host loses connection to the default gateway.
- The host loses connection to the API server.

32.3.1. Troubleshooting an incorrect node network configuration policy configuration

You can apply changes to the node network configuration across your entire cluster by applying a node network configuration policy. If you apply an incorrect configuration, you can use the following example to troubleshoot and correct the failed node network policy.

In this example, a Linux bridge policy is applied to an example cluster that has three control plane nodes and three compute nodes. The policy fails to be applied because it references an incorrect interface. To find the error, investigate the available NMState resources. You can then update the policy with the correct configuration.

Procedure

1. Create a policy and apply it to your cluster. The following example creates a simple bridge on the **ens01** interface:

```

apiVersion: nmstate.io/v1
kind: NodeNetworkConfigurationPolicy
metadata:
  name: ens01-bridge-testfail
spec:
  desiredState:
    interfaces:
      - name: br1
        description: Linux bridge with the wrong port
        type: linux-bridge
        state: up
        ipv4:
          dhcp: true
          enabled: true
        bridge:
          options:
            stp:

```



```

    enabled: false
  port:
    - name: ens01

```

```
$ oc apply -f ens01-bridge-testfail.yaml
```

Example output

```
nodenetworkconfigurationpolicy.nmstate.io/ens01-bridge-testfail created
```

2. Verify the status of the policy by running the following command:

```
$ oc get nncp
```

The output shows that the policy failed:

Example output

```

NAME                STATUS
ens01-bridge-testfail FailedToConfigure

```

However, the policy status alone does not indicate if it failed on all nodes or a subset of nodes.

3. List the node network configuration enactments to see if the policy was successful on any of the nodes. If the policy failed for only a subset of nodes, it suggests that the problem is with a specific node configuration. If the policy failed on all nodes, it suggests that the problem is with the policy.

```
$ oc get nnce
```

The output shows that the policy failed on all nodes:

Example output

```

NAME                                STATUS
control-plane-1.ens01-bridge-testfail FailedToConfigure
control-plane-2.ens01-bridge-testfail FailedToConfigure
control-plane-3.ens01-bridge-testfail FailedToConfigure
compute-1.ens01-bridge-testfail      FailedToConfigure
compute-2.ens01-bridge-testfail      FailedToConfigure
compute-3.ens01-bridge-testfail      FailedToConfigure

```

4. View one of the failed enactments and look at the traceback. The following command uses the output tool **jsonpath** to filter the output:

```
$ oc get nnce compute-1.ens01-bridge-testfail -o jsonpath='{.status.conditions[?(@.type=="Failing")].message}'
```

This command returns a large traceback that has been edited for brevity:

Example output

```
error reconciling NodeNetworkConfigurationPolicy at desired state apply: , failed to execute
```

```
nmstatectl set --no-commit --timeout 480: 'exit status 1' "
```

```
...
libnmstate.error.NmstateVerificationError:
desired
=====
---
name: br1
type: linux-bridge
state: up
bridge:
  options:
    group-forward-mask: 0
    mac-ageing-time: 300
    multicast-snooping: true
  stp:
    enabled: false
    forward-delay: 15
    hello-time: 2
    max-age: 20
    priority: 32768
  port:
    - name: ens01
description: Linux bridge with the wrong port
ipv4:
  address: []
  auto-dns: true
  auto-gateway: true
  auto-routes: true
  dhcp: true
  enabled: true
ipv6:
  enabled: false
mac-address: 01-23-45-67-89-AB
mtu: 1500

current
=====
---
name: br1
type: linux-bridge
state: up
bridge:
  options:
    group-forward-mask: 0
    mac-ageing-time: 300
    multicast-snooping: true
  stp:
    enabled: false
    forward-delay: 15
    hello-time: 2
    max-age: 20
    priority: 32768
  port: []
description: Linux bridge with the wrong port
ipv4:
  address: []
```

```

auto-dns: true
auto-gateway: true
auto-routes: true
dhcp: true
enabled: true
ipv6:
  enabled: false
mac-address: 01-23-45-67-89-AB
mtu: 1500

difference
=====
--- desired
+++ current
@@ -13,8 +13,7 @@
    hello-time: 2
    max-age: 20
    priority: 32768
- port:
- - name: ens01
+ port: []
description: Linux bridge with the wrong port
ipv4:
  address: []
line 651, in _assert_interfaces_equal\n
current_state.interfaces[ifname],\nlibnmstate.error.NmstateVerificationError:

```

The **NmstateVerificationError** lists the **desired** policy configuration, the **current** configuration of the policy on the node, and the **difference** highlighting the parameters that do not match. In this example, the **port** is included in the **difference**, which suggests that the problem is the port configuration in the policy.

- To ensure that the policy is configured properly, view the network configuration for one or all of the nodes by requesting the **NodeNetworkState** object. The following command returns the network configuration for the **control-plane-1** node:

```
$ oc get nns control-plane-1 -o yaml
```

The output shows that the interface name on the nodes is **ens1** but the failed policy incorrectly uses **ens01**:

Example output

```

- ipv4:
# ...
  name: ens1
  state: up
  type: ethernet

```

- Correct the error by editing the existing policy:

```
$ oc edit nncp ens01-bridge-testfail
```

```
# ...  
  port:  
    - name: ens1
```

Save the policy to apply the correction.

7. Check the status of the policy to ensure it updated successfully:

```
$ oc get nncp
```

Example output

```
NAME                STATUS  
ens01-bridge-testfail SuccessfullyConfigured
```

The updated policy is successfully configured on all nodes in the cluster.

CHAPTER 33. CONFIGURING THE CLUSTER-WIDE PROXY

Production environments can deny direct access to the internet and instead have an HTTP or HTTPS proxy available. You can configure OpenShift Container Platform to use a proxy by [modifying the Proxy object for existing clusters](#) or by configuring the proxy settings in the `install-config.yaml` file for new clusters.

33.1. PREREQUISITES

- Review the [sites that your cluster requires access to](#) and determine whether any of them must bypass the proxy. By default, all cluster system egress traffic is proxied, including calls to the cloud provider API for the cloud that hosts your cluster. System-wide proxy affects system components only, not user workloads. Add sites to the Proxy object's `spec.noProxy` field to bypass the proxy if necessary.



NOTE

The Proxy object `status.noProxy` field is populated with the values of the `networking.machineNetwork[].cidr`, `networking.clusterNetwork[].cidr`, and `networking.serviceNetwork[]` fields from your installation configuration with most installation types.

For installations on Amazon Web Services (AWS), Google Cloud Platform (GCP), Microsoft Azure, and Red Hat OpenStack Platform (RHOSP), the `Proxy` object `status.noProxy` field is also populated with the instance metadata endpoint (`169.254.169.254`).



IMPORTANT

If your installation type does not include setting the `networking.machineNetwork[].cidr` field, you must include the machine IP addresses manually in the `.status.noProxy` field to make sure that the traffic between nodes can bypass the proxy.

33.2. ENABLING THE CLUSTER-WIDE PROXY

The `Proxy` object is used to manage the cluster-wide egress proxy. When a cluster is installed or upgraded without the proxy configured, a `Proxy` object is still generated but it will have a nil `spec`. For example:

```
apiVersion: config.openshift.io/v1
kind: Proxy
metadata:
  name: cluster
spec:
  trustedCA:
    name: ""
status:
```

A cluster administrator can configure the proxy for OpenShift Container Platform by modifying this `cluster Proxy` object.

**NOTE**

Only the **Proxy** object named **cluster** is supported, and no additional proxies can be created.

Prerequisites

- Cluster administrator permissions
- OpenShift Container Platform **oc** CLI tool installed

Procedure

1. Create a config map that contains any additional CA certificates required for proxying HTTPS connections.

**NOTE**

You can skip this step if the proxy's identity certificate is signed by an authority from the RHCOS trust bundle.

- a. Create a file called **user-ca-bundle.yaml** with the following contents, and provide the values of your PEM-encoded certificates:

```
apiVersion: v1
data:
  ca-bundle.crt: | 1
    <MY_PEM_ENCODED_CERTS> 2
kind: ConfigMap
metadata:
  name: user-ca-bundle 3
  namespace: openshift-config 4
```

- 1** This data key must be named **ca-bundle.crt**.
- 2** One or more PEM-encoded X.509 certificates used to sign the proxy's identity certificate.
- 3** The config map name that will be referenced from the **Proxy** object.
- 4** The config map must be in the **openshift-config** namespace.

- b. Create the config map from this file:

```
$ oc create -f user-ca-bundle.yaml
```

2. Use the **oc edit** command to modify the **Proxy** object:

```
$ oc edit proxy/cluster
```

3. Configure the necessary fields for the proxy:

```
apiVersion: config.openshift.io/v1
```

```

kind: Proxy
metadata:
  name: cluster
spec:
  httpProxy: http://<username>:<pswd>@<ip>:<port> 1
  httpsProxy: https://<username>:<pswd>@<ip>:<port> 2
  noProxy: example.com 3
  readinessEndpoints:
  - http://www.google.com 4
  - https://www.google.com
  trustedCA:
    name: user-ca-bundle 5

```

- 1 A proxy URL to use for creating HTTP connections outside the cluster. The URL scheme must be **http**.
- 2 A proxy URL to use for creating HTTPS connections outside the cluster. The URL scheme must be either **http** or **https**. Specify a URL for the proxy that supports the URL scheme. For example, most proxies will report an error if they are configured to use **https** but they only support **http**. This failure message may not propagate to the logs and can appear to be a network connection failure instead. If using a proxy that listens for **https** connections from the cluster, you may need to configure the cluster to accept the CAs and certificates that the proxy uses.

- 3 A comma-separated list of destination domain names, domains, IP addresses or other network CIDRs to exclude proxying.

Preface a domain with **.** to match subdomains only. For example, **.y.com** matches **x.y.com**, but not **y.com**. Use ***** to bypass proxy for all destinations. If you scale up workers that are not included in the network defined by the **networking.machineNetwork[].cidr** field from the installation configuration, you must add them to this list to prevent connection issues.

This field is ignored if neither the **httpProxy** or **httpsProxy** fields are set.

- 4 One or more URLs external to the cluster to use to perform a readiness check before writing the **httpProxy** and **httpsProxy** values to status.
- 5 A reference to the config map in the **openshift-config** namespace that contains additional CA certificates required for proxying HTTPS connections. Note that the config map must already exist before referencing it here. This field is required unless the proxy's identity certificate is signed by an authority from the RHCOS trust bundle.

4. Save the file to apply the changes.

33.3. REMOVING THE CLUSTER-WIDE PROXY

The **cluster** Proxy object cannot be deleted. To remove the proxy from a cluster, remove all **spec** fields from the Proxy object.

Prerequisites

- Cluster administrator permissions
- OpenShift Container Platform **oc** CLI tool installed

Procedure

1. Use the **oc edit** command to modify the proxy:

```
$ oc edit proxy/cluster
```

2. Remove all **spec** fields from the Proxy object. For example:

```
apiVersion: config.openshift.io/v1
kind: Proxy
metadata:
  name: cluster
spec: {}
```

3. Save the file to apply the changes.

Additional resources

- [Replacing the CA Bundle certificate](#)
- [Proxy certificate customization](#)

CHAPTER 34. CONFIGURING A CUSTOM PKI

Some platform components, such as the web console, use Routes for communication and must trust other components' certificates to interact with them. If you are using a custom public key infrastructure (PKI), you must configure it so its privately signed CA certificates are recognized across the cluster.

You can leverage the Proxy API to add cluster-wide trusted CA certificates. You must do this either during installation or at runtime.

- During *installation*, [configure the cluster-wide proxy](#). You must define your privately signed CA certificates in the **install-config.yaml** file's **additionalTrustBundle** setting. The installation program generates a ConfigMap that is named **user-ca-bundle** that contains the additional CA certificates you defined. The Cluster Network Operator then creates a **trusted-ca-bundle** ConfigMap that merges these CA certificates with the Red Hat Enterprise Linux CoreOS (RHCOS) trust bundle; this ConfigMap is referenced in the Proxy object's **trustedCA** field.
- At *runtime*, [modify the default Proxy object to include your privately signed CA certificates](#) (part of cluster's proxy enablement workflow). This involves creating a ConfigMap that contains the privately signed CA certificates that should be trusted by the cluster, and then modifying the proxy resource with the **trustedCA** referencing the privately signed certificates' ConfigMap.



NOTE

The installer configuration's **additionalTrustBundle** field and the proxy resource's **trustedCA** field are used to manage the cluster-wide trust bundle; **additionalTrustBundle** is used at install time and the proxy's **trustedCA** is used at runtime.

The **trustedCA** field is a reference to a **ConfigMap** containing the custom certificate and key pair used by the cluster component.

34.1. CONFIGURING THE CLUSTER-WIDE PROXY DURING INSTALLATION

Production environments can deny direct access to the internet and instead have an HTTP or HTTPS proxy available. You can configure a new OpenShift Container Platform cluster to use a proxy by configuring the proxy settings in the **install-config.yaml** file.

Prerequisites

- You have an existing **install-config.yaml** file.
- You reviewed the sites that your cluster requires access to and determined whether any of them need to bypass the proxy. By default, all cluster egress traffic is proxied, including calls to hosting cloud provider APIs. You added sites to the **Proxy** object's **spec.noProxy** field to bypass the proxy if necessary.



NOTE

The **Proxy** object **status.noProxy** field is populated with the values of the **networking.machineNetwork[].cidr**, **networking.clusterNetwork[].cidr**, and **networking.serviceNetwork[]** fields from your installation configuration.

For installations on Amazon Web Services (AWS), Google Cloud Platform (GCP), Microsoft Azure, and Red Hat OpenStack Platform (RHOSP), the **Proxy** object **status.noProxy** field is also populated with the instance metadata endpoint (**169.254.169.254**).

Procedure

1. Edit your **install-config.yaml** file and add the proxy settings. For example:

```
apiVersion: v1
baseDomain: my.domain.com
proxy:
  httpProxy: http://<username>:<pswd>@<ip>:<port> 1
  httpsProxy: https://<username>:<pswd>@<ip>:<port> 2
  noProxy: ec2.<aws_region>.amazonaws.com,elasticloadbalancing.
  <aws_region>.amazonaws.com,s3.<aws_region>.amazonaws.com 3
  additionalTrustBundle: | 4
    -----BEGIN CERTIFICATE-----
    <MY_TRUSTED_CA_CERT>
    -----END CERTIFICATE-----
  additionalTrustBundlePolicy: <policy_to_add_additionalTrustBundle> 5
```

- 1 A proxy URL to use for creating HTTP connections outside the cluster. The URL scheme must be **http**.
- 2 A proxy URL to use for creating HTTPS connections outside the cluster.
- 3 A comma-separated list of destination domain names, IP addresses, or other network CIDRs to exclude from proxying. Preface a domain with **.** to match subdomains only. For example, **.y.com** matches **x.y.com**, but not **y.com**. Use ***** to bypass the proxy for all destinations. If you have added the Amazon **EC2**, **Elastic Load Balancing**, and **S3** VPC endpoints to your VPC, you must add these endpoints to the **noProxy** field.
- 4 If provided, the installation program generates a config map that is named **user-ca-bundle** in the **openshift-config** namespace that contains one or more additional CA certificates that are required for proxying HTTPS connections. The Cluster Network Operator then creates a **trusted-ca-bundle** config map that merges these contents with the Red Hat Enterprise Linux CoreOS (RHCOS) trust bundle, and this config map is referenced in the **trustedCA** field of the **Proxy** object. The **additionalTrustBundle** field is required unless the proxy's identity certificate is signed by an authority from the RHCOS trust bundle.
- 5 Optional: The policy to determine the configuration of the **Proxy** object to reference the **user-ca-bundle** config map in the **trustedCA** field. The allowed values are **Proxyonly** and **Always**. Use **Proxyonly** to reference the **user-ca-bundle** config map only when **http/https** proxy is configured. Use **Always** to always reference the **user-ca-bundle** config map. The default value is **Proxyonly**.

**NOTE**

The installation program does not support the proxy **readinessEndpoints** field.

**NOTE**

If the installer times out, restart and then complete the deployment by using the **wait-for** command of the installer. For example:

```
$. /openshift-install wait-for install-complete --log-level debug
```

2. Save the file and reference it when installing OpenShift Container Platform.

The installation program creates a cluster-wide proxy that is named **cluster** that uses the proxy settings in the provided **install-config.yaml** file. If no proxy settings are provided, a **cluster Proxy** object is still created, but it will have a nil **spec**.

**NOTE**

Only the **Proxy** object named **cluster** is supported, and no additional proxies can be created.

34.2. ENABLING THE CLUSTER-WIDE PROXY

The **Proxy** object is used to manage the cluster-wide egress proxy. When a cluster is installed or upgraded without the proxy configured, a **Proxy** object is still generated but it will have a nil **spec**. For example:

```
apiVersion: config.openshift.io/v1
kind: Proxy
metadata:
  name: cluster
spec:
  trustedCA:
    name: ""
status:
```

A cluster administrator can configure the proxy for OpenShift Container Platform by modifying this **cluster Proxy** object.

**NOTE**

Only the **Proxy** object named **cluster** is supported, and no additional proxies can be created.

Prerequisites

- Cluster administrator permissions
- OpenShift Container Platform **oc** CLI tool installed

Procedure

1. Create a config map that contains any additional CA certificates required for proxying HTTPS connections.

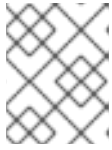

NOTE

You can skip this step if the proxy's identity certificate is signed by an authority from the RHCOS trust bundle.

- a. Create a file called **user-ca-bundle.yaml** with the following contents, and provide the values of your PEM-encoded certificates:

```
apiVersion: v1
data:
  ca-bundle.crt: | 1
    <MY_PEM_ENCODED_CERTS> 2
kind: ConfigMap
metadata:
  name: user-ca-bundle 3
  namespace: openshift-config 4
```

- 1** This data key must be named **ca-bundle.crt**.
- 2** One or more PEM-encoded X.509 certificates used to sign the proxy's identity certificate.
- 3** The config map name that will be referenced from the **Proxy** object.
- 4** The config map must be in the **openshift-config** namespace.

- b. Create the config map from this file:

```
$ oc create -f user-ca-bundle.yaml
```

2. Use the **oc edit** command to modify the **Proxy** object:

```
$ oc edit proxy/cluster
```

3. Configure the necessary fields for the proxy:

```
apiVersion: config.openshift.io/v1
kind: Proxy
metadata:
  name: cluster
spec:
  httpProxy: http://<username>:<pswd>@<ip>:<port> 1
  httpsProxy: https://<username>:<pswd>@<ip>:<port> 2
  noProxy: example.com 3
  readinessEndpoints:
  - http://www.google.com 4
  - https://www.google.com
  trustedCA:
    name: user-ca-bundle 5
```

- 1 A proxy URL to use for creating HTTP connections outside the cluster. The URL scheme must be **http**.
- 2 A proxy URL to use for creating HTTPS connections outside the cluster. The URL scheme must be either **http** or **https**. Specify a URL for the proxy that supports the URL scheme. For example, most proxies will report an error if they are configured to use **https** but they only support **http**. This failure message may not propagate to the logs and can appear to be a network connection failure instead. If using a proxy that listens for **https** connections from the cluster, you may need to configure the cluster to accept the CAs and certificates that the proxy uses.
- 3 A comma-separated list of destination domain names, domains, IP addresses or other network CIDRs to exclude proxying.

Preface a domain with **.** to match subdomains only. For example, **.y.com** matches **x.y.com**, but not **y.com**. Use ***** to bypass proxy for all destinations. If you scale up workers that are not included in the network defined by the **networking.machineNetwork[].cidr** field from the installation configuration, you must add them to this list to prevent connection issues.

This field is ignored if neither the **httpProxy** or **httpsProxy** fields are set.

- 4 One or more URLs external to the cluster to use to perform a readiness check before writing the **httpProxy** and **httpsProxy** values to status.
- 5 A reference to the config map in the **openshift-config** namespace that contains additional CA certificates required for proxying HTTPS connections. Note that the config map must already exist before referencing it here. This field is required unless the proxy's identity certificate is signed by an authority from the RHCOS trust bundle.

4. Save the file to apply the changes.

34.3. CERTIFICATE INJECTION USING OPERATORS

Once your custom CA certificate is added to the cluster via ConfigMap, the Cluster Network Operator merges the user-provided and system CA certificates into a single bundle and injects the merged bundle into the Operator requesting the trust bundle injection.



IMPORTANT

After adding a **config.openshift.io/inject-trusted-cabundle="true"** label to the config map, existing data in it is deleted. The Cluster Network Operator takes ownership of a config map and only accepts **ca-bundle** as data. You must use a separate config map to store **service-ca.crt** by using the **service.beta.openshift.io/inject-cabundle=true** annotation or a similar configuration. Adding a **config.openshift.io/inject-trusted-cabundle="true"** label and **service.beta.openshift.io/inject-cabundle=true** annotation on the same config map can cause issues.

Operators request this injection by creating an empty ConfigMap with the following label:

```
config.openshift.io/inject-trusted-cabundle="true"
```

An example of the empty ConfigMap:

```
apiVersion: v1
```

```

data: {}
kind: ConfigMap
metadata:
  labels:
    config.openshift.io/inject-trusted-cabundle: "true"
  name: ca-inject 1
  namespace: apache

```

- 1** Specifies the empty ConfigMap name.

The Operator mounts this ConfigMap into the container's local trust store.



NOTE

Adding a trusted CA certificate is only needed if the certificate is not included in the Red Hat Enterprise Linux CoreOS (RHCOS) trust bundle.

Certificate injection is not limited to Operators. The Cluster Network Operator injects certificates across any namespace when an empty ConfigMap is created with the **config.openshift.io/inject-trusted-cabundle=true** label.

The ConfigMap can reside in any namespace, but the ConfigMap must be mounted as a volume to each container within a pod that requires a custom CA. For example:

```

apiVersion: apps/v1
kind: Deployment
metadata:
  name: my-example-custom-ca-deployment
  namespace: my-example-custom-ca-ns
spec:
  ...
  spec:
    ...
    containers:
      - name: my-container-that-needs-custom-ca
        volumeMounts:
          - name: trusted-ca
            mountPath: /etc/pki/ca-trust/extracted/pem
            readOnly: true
        volumes:
          - name: trusted-ca
            configMap:
              name: trusted-ca
              items:
                - key: ca-bundle.crt 1
                  path: tls-ca-bundle.pem 2

```

- 1** **ca-bundle.crt** is required as the ConfigMap key.
- 2** **tls-ca-bundle.pem** is required as the ConfigMap path.

CHAPTER 35. LOAD BALANCING ON RHOSP

35.1. LIMITATIONS OF LOAD BALANCER SERVICES

OpenShift Container Platform clusters on Red Hat OpenStack Platform (RHOSP) use Octavia to handle load balancer services. As a result of this choice, such clusters have a number of functional limitations.

RHOSP Octavia has two supported providers: Amphora and OVN. These providers differ in terms of available features as well as implementation details. These distinctions affect load balancer services that are created on your cluster.

35.1.1. Local external traffic policies

You can set the external traffic policy (ETP) parameter, `.spec.externalTrafficPolicy`, on a load balancer service to preserve the source IP address of incoming traffic when it reaches service endpoint pods. However, if your cluster uses the Amphora Octavia provider, the source IP of the traffic is replaced with the IP address of the Amphora VM. This behavior does not occur if your cluster uses the OVN Octavia provider.

Having the **ETP** option set to **Local** requires that health monitors be created for the load balancer. Without health monitors, traffic can be routed to a node that doesn't have a functional endpoint, which causes the connection to drop. To force Cloud Provider OpenStack to create health monitors, you must set the value of the **create-monitor** option in the cloud provider configuration to **true**.

In RHOSP 16.2, the OVN Octavia provider does not support health monitors. Therefore, setting the ETP to local is unsupported.

In RHOSP 16.2, the Amphora Octavia provider does not support HTTP monitors on UDP pools. As a result, UDP load balancer services have **UDP-CONNECT** monitors created instead. Due to implementation details, this configuration only functions properly with the OVN-Kubernetes CNI plugin. When the OpenShift SDN CNI plugin is used, the UDP services alive nodes are detected unreliably. This issue also affects the OVN Octavia provider in any RHOSP version because the driver does not support HTTP health monitors.

35.2. SCALING CLUSTERS FOR APPLICATION TRAFFIC BY USING OCTAVIA

OpenShift Container Platform clusters that run on Red Hat OpenStack Platform (RHOSP) can use the Octavia load balancing service to distribute traffic across multiple virtual machines (VMs) or floating IP addresses. This feature mitigates the bottleneck that single machines or addresses create.

You must create your own Octavia load balancer to use it for application network scaling.

35.2.1. Scaling clusters by using Octavia

If you want to use multiple API load balancers, create an Octavia load balancer and then configure your cluster to use it.

Prerequisites

- Octavia is available on your Red Hat OpenStack Platform (RHOSP) deployment.

Procedure

1. From a command line, create an Octavia load balancer that uses the Amphora driver:

```
$ openstack loadbalancer create --name API_OCP_CLUSTER --vip-subnet-id
<id_of_worker_vms_subnet>
```

You can use a name of your choice instead of **API_OCP_CLUSTER**.

2. After the load balancer becomes active, create listeners:

```
$ openstack loadbalancer listener create --name API_OCP_CLUSTER_6443 --protocol
HTTPS--protocol-port 6443 API_OCP_CLUSTER
```



NOTE

To view the status of the load balancer, enter **openstack loadbalancer list**.

3. Create a pool that uses the round robin algorithm and has session persistence enabled:

```
$ openstack loadbalancer pool create --name API_OCP_CLUSTER_pool_6443 --lb-
algorithm ROUND_ROBIN --session-persistence type=<source_IP_address> --listener
API_OCP_CLUSTER_6443 --protocol HTTPS
```

4. To ensure that control plane machines are available, create a health monitor:

```
$ openstack loadbalancer healthmonitor create --delay 5 --max-retries 4 --timeout 10 --type
TCP API_OCP_CLUSTER_pool_6443
```

5. Add the control plane machines as members of the load balancer pool:

```
$ for SERVER in $(MASTER-0-IP MASTER-1-IP MASTER-2-IP)
do
  openstack loadbalancer member create --address $SERVER --protocol-port 6443
  API_OCP_CLUSTER_pool_6443
done
```

6. Optional: To reuse the cluster API floating IP address, unset it:

```
$ openstack floating ip unset $API_FIP
```

7. Add either the unset **API_FIP** or a new address to the created load balancer VIP:

```
$ openstack floating ip set --port $(openstack loadbalancer show -c <vip_port_id> -f value
API_OCP_CLUSTER) $API_FIP
```

Your cluster now uses Octavia for load balancing.

35.3. SERVICES FOR AN EXTERNAL LOAD BALANCER

You can configure an OpenShift Container Platform cluster on Red Hat OpenStack Platform (RHOSP) to use an external load balancer in place of the default load balancer.



IMPORTANT

Configuring an external load balancer depends on your vendor's load balancer.

The information and examples in this section are for guideline purposes only. Consult the vendor documentation for more specific information about the vendor's load balancer.

Red Hat supports the following services for an external load balancer:

- Ingress Controller
- OpenShift API
- OpenShift MachineConfig API

You can choose whether you want to configure one or all of these services for an external load balancer. Configuring only the Ingress Controller service is a common configuration option. To better understand each service, view the following diagrams:

Figure 35.1. Example network workflow that shows an Ingress Controller operating in an OpenShift Container Platform environment

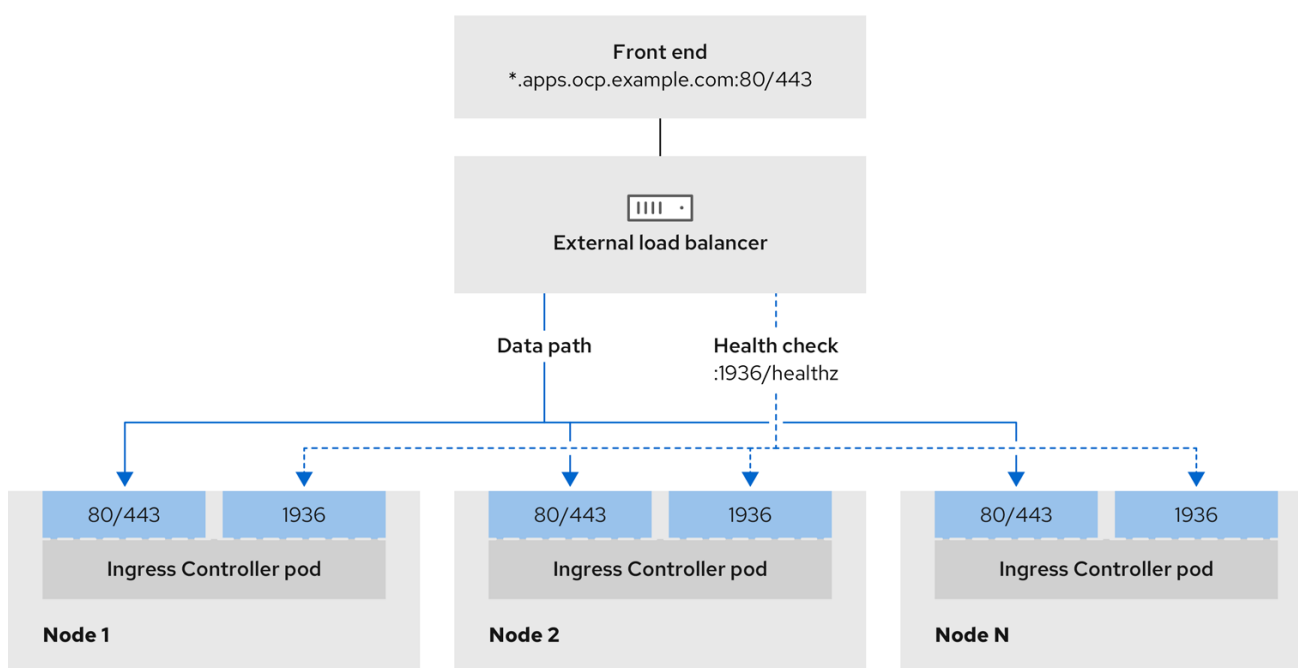

496_OpenShift_1223

Figure 35.2. Example network workflow that shows an OpenShift API operating in an OpenShift Container Platform environment

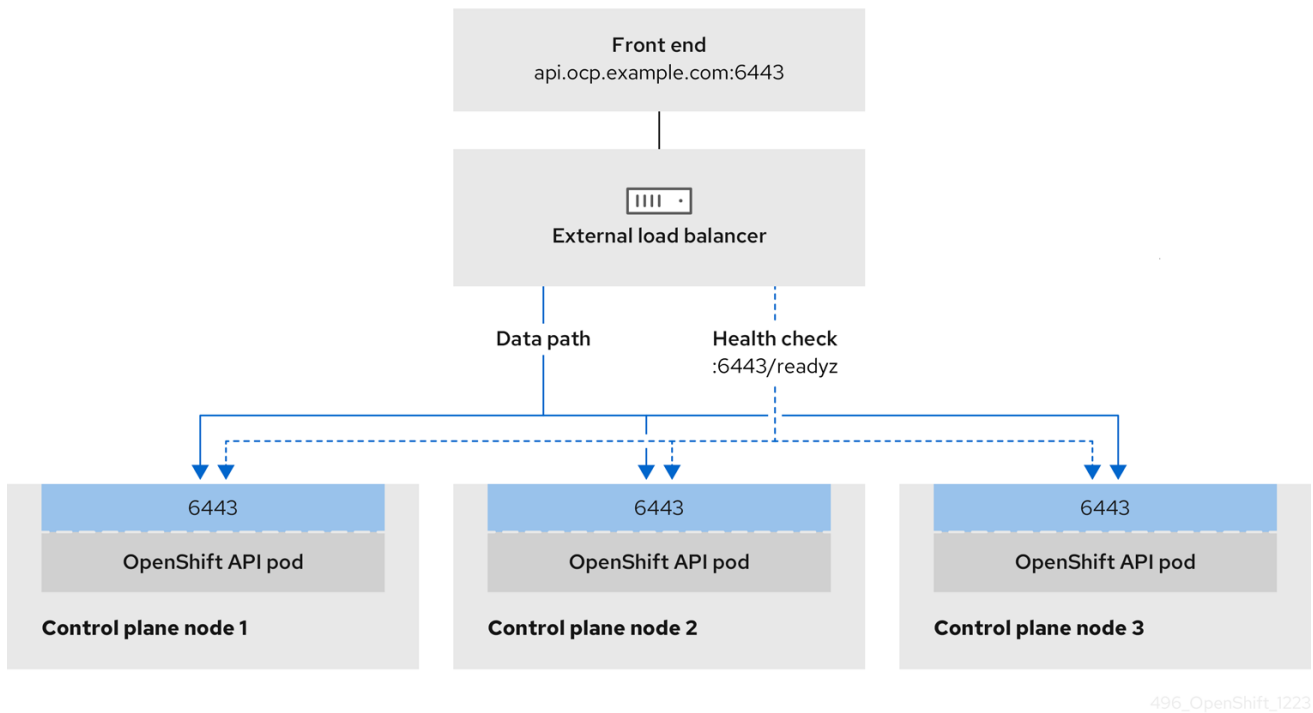
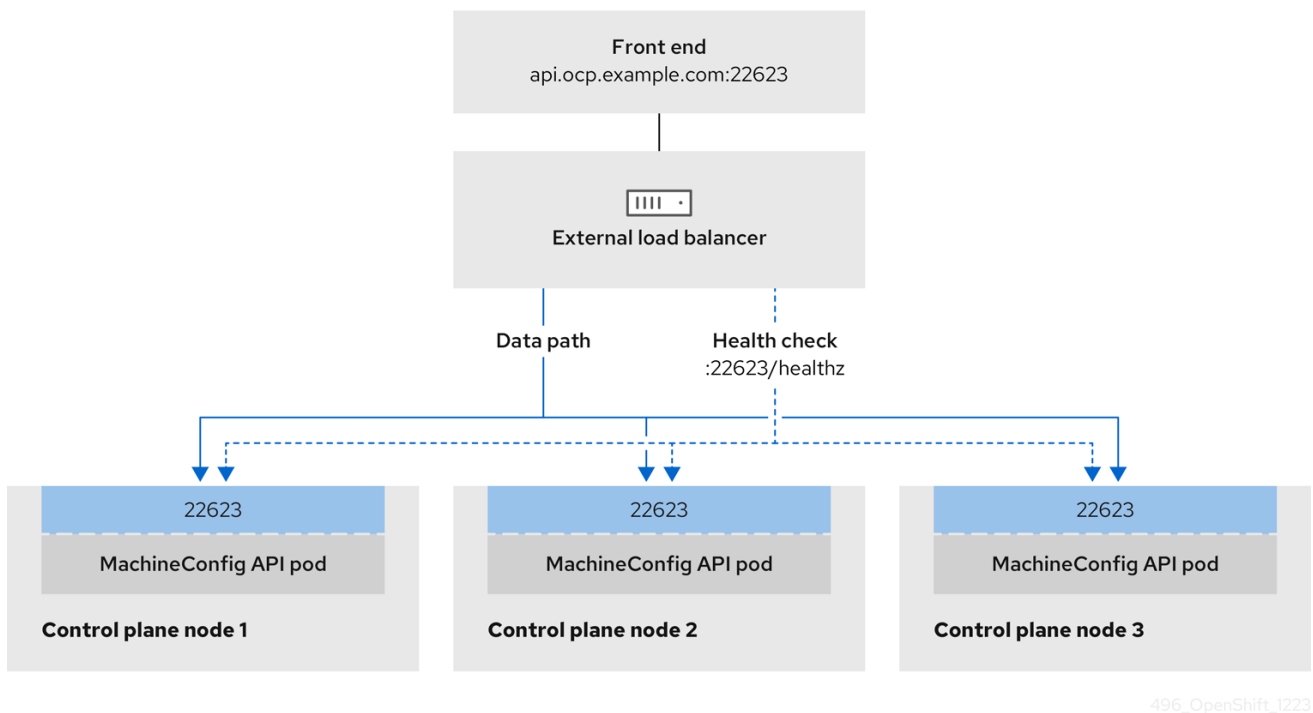

Figure 35.3. Example network workflow that shows an OpenShift MachineConfig API operating in an OpenShift Container Platform environment



The following configuration options are supported for external load balancers:

- Use a node selector to map the Ingress Controller to a specific set of nodes. You must assign a static IP address to each node in this set, or configure each node to receive the same IP address from the Dynamic Host Configuration Protocol (DHCP). Infrastructure nodes commonly receive this type of configuration.

- Target all IP addresses on a subnet. This configuration can reduce maintenance overhead, because you can create and destroy nodes within those networks without reconfiguring the load balancer targets. If you deploy your ingress pods by using a machine set on a smaller network, such as a /27 or /28, you can simplify your load balancer targets.

TIP

You can list all IP addresses that exist in a network by checking the machine config pool's resources.

Before you configure an external load balancer for your OpenShift Container Platform cluster, consider the following information:

- For a front-end IP address, you can use the same IP address for the front-end IP address, the Ingress Controller's load balancer, and API load balancer. Check the vendor's documentation for this capability.
- For a back-end IP address, ensure that an IP address for an OpenShift Container Platform control plane node does not change during the lifetime of the external load balancer. You can achieve this by completing one of the following actions:
 - Assign a static IP address to each control plane node.
 - Configure each node to receive the same IP address from the DHCP every time the node requests a DHCP lease. Depending on the vendor, the DHCP lease might be in the form of an IP reservation or a static DHCP assignment.
- Manually define each node that runs the Ingress Controller in the external load balancer for the Ingress Controller back-end service. For example, if the Ingress Controller moves to an undefined node, a connection outage can occur.

35.3.1. Configuring an external load balancer

You can configure an OpenShift Container Platform cluster on Red Hat OpenStack Platform (RHOSP) to use an external load balancer in place of the default load balancer.



IMPORTANT

Before you configure an external load balancer, ensure that you read the "Services for an external load balancer" section.

Read the following prerequisites that apply to the service that you want to configure for your external load balancer.



NOTE

MetalLB, that runs on a cluster, functions as an external load balancer.

OpenShift API prerequisites

- You defined a front-end IP address.
- TCP ports 6443 and 22623 are exposed on the front-end IP address of your load balancer. Check the following items:

- Port 6443 provides access to the OpenShift API service.
- Port 22623 can provide ignition startup configurations to nodes.
- The front-end IP address and port 6443 are reachable by all users of your system with a location external to your OpenShift Container Platform cluster.
- The front-end IP address and port 22623 are reachable only by OpenShift Container Platform nodes.
- The load balancer backend can communicate with OpenShift Container Platform control plane nodes on port 6443 and 22623.

Ingress Controller prerequisites

- You defined a front-end IP address.
- TCP ports 443 and 80 are exposed on the front-end IP address of your load balancer.
- The front-end IP address, port 80 and port 443 are be reachable by all users of your system with a location external to your OpenShift Container Platform cluster.
- The front-end IP address, port 80 and port 443 are reachable to all nodes that operate in your OpenShift Container Platform cluster.
- The load balancer backend can communicate with OpenShift Container Platform nodes that run the Ingress Controller on ports 80, 443, and 1936.

Prerequisite for health check URL specifications

You can configure most load balancers by setting health check URLs that determine if a service is available or unavailable. OpenShift Container Platform provides these health checks for the OpenShift API, Machine Configuration API, and Ingress Controller backend services.

The following examples demonstrate health check specifications for the previously listed backend services:

Example of a Kubernetes API health check specification

```
Path: HTTPS:6443/readyz
Healthy threshold: 2
Unhealthy threshold: 2
Timeout: 10
Interval: 10
```

Example of a Machine Config API health check specification

```
Path: HTTPS:22623/healthz
Healthy threshold: 2
Unhealthy threshold: 2
Timeout: 10
Interval: 10
```

Example of an Ingress Controller health check specification

```

Path: HTTP:1936/healthz/ready
Healthy threshold: 2
Unhealthy threshold: 2
Timeout: 5
Interval: 10

```

Procedure

1. Configure the HAProxy Ingress Controller, so that you can enable access to the cluster from your load balancer on ports 6443, 443, and 80:

Example HAProxy configuration

```

#...
listen my-cluster-api-6443
    bind 192.168.1.100:6443
    mode tcp
    balance roundrobin
    option httpchk
    http-check connect
    http-check send meth GET uri /readyz
    http-check expect status 200
    server my-cluster-master-2 192.168.1.101:6443 check inter 10s rise 2 fall 2
    server my-cluster-master-0 192.168.1.102:6443 check inter 10s rise 2 fall 2
    server my-cluster-master-1 192.168.1.103:6443 check inter 10s rise 2 fall 2

listen my-cluster-machine-config-api-22623
    bind 192.168.1.100:22623
    mode tcp
    balance roundrobin
    option httpchk
    http-check connect
    http-check send meth GET uri /healthz
    http-check expect status 200
    server my-cluster-master-2 192.168.1.101:22623 check inter 10s rise 2 fall 2
    server my-cluster-master-0 192.168.1.102:22623 check inter 10s rise 2 fall 2
    server my-cluster-master-1 192.168.1.103:22623 check inter 10s rise 2 fall 2

listen my-cluster-apps-443
    bind 192.168.1.100:443
    mode tcp
    balance roundrobin
    option httpchk
    http-check connect
    http-check send meth GET uri /healthz/ready
    http-check expect status 200
    server my-cluster-worker-0 192.168.1.111:443 check port 1936 inter 10s rise 2 fall 2
    server my-cluster-worker-1 192.168.1.112:443 check port 1936 inter 10s rise 2 fall 2
    server my-cluster-worker-2 192.168.1.113:443 check port 1936 inter 10s rise 2 fall 2

listen my-cluster-apps-80
    bind 192.168.1.100:80
    mode tcp
    balance roundrobin
    option httpchk

```

```

http-check connect
http-check send meth GET uri /healthz/ready
http-check expect status 200
  server my-cluster-worker-0 192.168.1.111:80 check port 1936 inter 10s rise 2 fall 2
  server my-cluster-worker-1 192.168.1.112:80 check port 1936 inter 10s rise 2 fall 2
  server my-cluster-worker-2 192.168.1.113:80 check port 1936 inter 10s rise 2 fall 2
# ...

```

2. Use the **curl** CLI command to verify that the external load balancer and its resources are operational:

- a. Verify that the cluster machine configuration API is accessible to the Kubernetes API server resource, by running the following command and observing the response:

```
$ curl https://<loadbalancer_ip_address>:6443/version --insecure
```

If the configuration is correct, you receive a JSON object in response:

```

{
  "major": "1",
  "minor": "11+",
  "gitVersion": "v1.11.0+ad103ed",
  "gitCommit": "ad103ed",
  "gitTreeState": "clean",
  "buildDate": "2019-01-09T06:44:10Z",
  "goVersion": "go1.10.3",
  "compiler": "gc",
  "platform": "linux/amd64"
}

```

- b. Verify that the cluster machine configuration API is accessible to the Machine config server resource, by running the following command and observing the output:

```
$ curl -v https://<loadbalancer_ip_address>:22623/healthz --insecure
```

If the configuration is correct, the output from the command shows the following response:

```

HTTP/1.1 200 OK
Content-Length: 0

```

- c. Verify that the controller is accessible to the Ingress Controller resource on port 80, by running the following command and observing the output:

```
$ curl -I -L -H "Host: console-openshift-console.apps.<cluster_name>.<base_domain>"
http://<load_balancer_front_end_IP_address>
```

If the configuration is correct, the output from the command shows the following response:

```

HTTP/1.1 302 Found
content-length: 0
location: https://console-openshift-console.apps.ocp4.private.opequon.net/
cache-control: no-cache

```

- d. Verify that the controller is accessible to the Ingress Controller resource on port 443, by running the following command and observing the output:

```
$ curl -I -L --insecure --resolve console-openshift-console.apps.<cluster_name>.<base_domain>:443:<Load Balancer Front End IP Address> https://console-openshift-console.apps.<cluster_name>.<base_domain>
```

If the configuration is correct, the output from the command shows the following response:

```
HTTP/1.1 200 OK
referrer-policy: strict-origin-when-cross-origin
set-cookie: csrf-
token=UIYW0yQ62LWjw2h003xtYSKlh1a0Py2hhctw0WmV2YEJhJfYqWwCGBsja261dGLgaY00nxzVERhiXt6QepA7g==; Path=/; Secure; SameSite=Lax
x-content-type-options: nosniff
x-dns-prefetch-control: off
x-frame-options: DENY
x-xss-protection: 1; mode=block
date: Wed, 04 Oct 2023 16:29:38 GMT
content-type: text/html; charset=utf-8
set-cookie:
1e2670d92730b515ce3a1bb65da45062=1bf5e9573c9a2760c964ed1659cc1673; path=/; HttpOnly; Secure; SameSite=None
cache-control: private
```

3. Configure the DNS records for your cluster to target the front-end IP addresses of the external load balancer. You must update records to your DNS server for the cluster API and applications over the load balancer.

Examples of modified DNS records

```
<load_balancer_ip_address> A api.<cluster_name>.<base_domain>
A record pointing to Load Balancer Front End
```

```
<load_balancer_ip_address> A apps.<cluster_name>.<base_domain>
A record pointing to Load Balancer Front End
```



IMPORTANT

DNS propagation might take some time for each DNS record to become available. Ensure that each DNS record propagates before validating each record.

4. Use the **curl** CLI command to verify that the external load balancer and DNS record configuration are operational:
 - a. Verify that you can access the cluster API, by running the following command and observing the output:

```
$ curl https://api.<cluster_name>.<base_domain>:6443/version --insecure
```

If the configuration is correct, you receive a JSON object in response:

```
{
  "major": "1",
  "minor": "11+",
  "gitVersion": "v1.11.0+ad103ed",
  "gitCommit": "ad103ed",
  "gitTreeState": "clean",
  "buildDate": "2019-01-09T06:44:10Z",
  "goVersion": "go1.10.3",
  "compiler": "gc",
  "platform": "linux/amd64"
}
```

- b. Verify that you can access the cluster machine configuration, by running the following command and observing the output:

```
$ curl -v https://api.<cluster_name>.<base_domain>:22623/healthz --insecure
```

If the configuration is correct, the output from the command shows the following response:

```
HTTP/1.1 200 OK
Content-Length: 0
```

- c. Verify that you can access each cluster application on port, by running the following command and observing the output:

```
$ curl http://console-openshift-console.apps.<cluster_name>.<base_domain> -I -L --insecure
```

If the configuration is correct, the output from the command shows the following response:

```
HTTP/1.1 302 Found
content-length: 0
location: https://console-openshift-console.apps.<cluster-name>.<base domain>/
cache-control: no-cacheHTTP/1.1 200 OK
referrer-policy: strict-origin-when-cross-origin
set-cookie: csrf-
token=39HoZgztDnzjJkq/JuLJMeoKNXlfiVv2YgZc09c3TBOBU4NI6kDXaJH1LdicNhN1UsQ
Wzon4Dor9GWGfopaTEQ==; Path=/; Secure
x-content-type-options: nosniff
x-dns-prefetch-control: off
x-frame-options: DENY
x-xss-protection: 1; mode=block
date: Tue, 17 Nov 2020 08:42:10 GMT
content-type: text/html; charset=utf-8
set-cookie:
1e2670d92730b515ce3a1bb65da45062=9b714eb87e93cf34853e87a92d6894be; path=/;
HttpOnly; Secure; SameSite=None
cache-control: private
```

- d. Verify that you can access each cluster application on port 443, by running the following command and observing the output:

```
$ curl https://console-openshift-console.apps.<cluster_name>.<base_domain> -I -L --insecure
```

-
If the configuration is correct, the output from the command shows the following response:

```
HTTP/1.1 200 OK
referrer-policy: strict-origin-when-cross-origin
set-cookie: csrf-
token=UIYWOyQ62LWjw2h003xtYSKIh1a0Py2hhctw0WmV2YEdhJfYqWwCGBsja261dG
LgaYO0nxzVERhiXt6QepA7g==; Path=/; Secure; SameSite=Lax
x-content-type-options: nosniff
x-dns-prefetch-control: off
x-frame-options: DENY
x-xss-protection: 1; mode=block
date: Wed, 04 Oct 2023 16:29:38 GMT
content-type: text/html; charset=utf-8
set-cookie:
1e2670d92730b515ce3a1bb65da45062=1bf5e9573c9a2760c964ed1659cc1673; path=/;
HttpOnly; Secure; SameSite=None
cache-control: private
```

CHAPTER 36. LOAD BALANCING WITH METALLB

36.1. ABOUT METALLB AND THE METALLB OPERATOR

As a cluster administrator, you can add the MetalLB Operator to your cluster so that when a service of type **LoadBalancer** is added to the cluster, MetalLB can add an external IP address for the service. The external IP address is added to the host network for your cluster.

36.1.1. When to use MetalLB

Using MetalLB is valuable when you have a bare-metal cluster, or an infrastructure that is like bare metal, and you want fault-tolerant access to an application through an external IP address.

You must configure your networking infrastructure to ensure that network traffic for the external IP address is routed from clients to the host network for the cluster.

After deploying MetalLB with the MetalLB Operator, when you add a service of type **LoadBalancer**, MetalLB provides a platform-native load balancer.

MetalLB operating in layer2 mode provides support for failover by utilizing a mechanism similar to IP failover. However, instead of relying on the virtual router redundancy protocol (VRRP) and keepalived, MetalLB leverages a gossip-based protocol to identify instances of node failure. When a failover is detected, another node assumes the role of the leader node, and a gratuitous ARP message is dispatched to broadcast this change.

MetalLB operating in layer3 or border gateway protocol (BGP) mode delegates failure detection to the network. The BGP router or routers that the OpenShift Container Platform nodes have established a connection with will identify any node failure and terminate the routes to that node.

Using MetalLB instead of IP failover is preferable for ensuring high availability of pods and services.

36.1.2. MetalLB Operator custom resources

The MetalLB Operator monitors its own namespace for the following custom resources:

MetalLB

When you add a **MetalLB** custom resource to the cluster, the MetalLB Operator deploys MetalLB on the cluster. The Operator only supports a single instance of the custom resource. If the instance is deleted, the Operator removes MetalLB from the cluster.

IPAddressPool

MetalLB requires one or more pools of IP addresses that it can assign to a service when you add a service of type **LoadBalancer**. An **IPAddressPool** includes a list of IP addresses. The list can be a single IP address that is set using a range, such as 1.1.1.1-1.1.1.1, a range specified in CIDR notation, a range specified as a starting and ending address separated by a hyphen, or a combination of the three. An **IPAddressPool** requires a name. The documentation uses names like **doc-example**, **doc-example-reserved**, and **doc-example-ipv6**. The MetalLB **controller** assigns IP addresses from a pool of addresses in an **IPAddressPool**. **L2Advertisement** and **BGPAdvertisement** custom resources enable the advertisement of a given IP from a given pool. You can assign IP addresses from an **IPAddressPool** to services and namespaces by using the **spec.serviceAllocation** specification in the **IPAddressPool** custom resource.

**NOTE**

A single **IPAddressPool** can be referenced by a L2 advertisement and a BGP advertisement.

BGPPeer

The BGP peer custom resource identifies the BGP router for MetalLB to communicate with, the AS number of the router, the AS number for MetalLB, and customizations for route advertisement. MetalLB advertises the routes for service load-balancer IP addresses to one or more BGP peers.

BFDProfile

The BFD profile custom resource configures Bidirectional Forwarding Detection (BFD) for a BGP peer. BFD provides faster path failure detection than BGP alone provides.

L2Advertisement

The L2Advertisement custom resource advertises an IP coming from an **IPAddressPool** using the L2 protocol.

BGPAdvertisement

The BGPAdvertisement custom resource advertises an IP coming from an **IPAddressPool** using the BGP protocol.

After you add the **MetalLB** custom resource to the cluster and the Operator deploys MetalLB, the **controller** and **speaker** MetalLB software components begin running.

MetalLB validates all relevant custom resources.

36.1.3. MetalLB software components

When you install the MetalLB Operator, the **metallb-operator-controller-manager** deployment starts a pod. The pod is the implementation of the Operator. The pod monitors for changes to all the relevant resources.

When the Operator starts an instance of MetalLB, it starts a **controller** deployment and a **speaker** daemon set.

**NOTE**

You can configure deployment specifications in the MetalLB custom resource to manage how **controller** and **speaker** pods deploy and run in your cluster. For more information about these deployment specifications, see the *Additional Resources* section.

controller

The Operator starts the deployment and a single pod. When you add a service of type **LoadBalancer**, Kubernetes uses the **controller** to allocate an IP address from an address pool. In case of a service failure, verify you have the following entry in your **controller** pod logs:

Example output

```
"event": "ipAllocated", "ip": "172.22.0.201", "msg": "IP address assigned by controller"
```

speaker

The Operator starts a daemon set for **speaker** pods. By default, a pod is started on each node in

your cluster. You can limit the pods to specific nodes by specifying a node selector in the **MetalLB** custom resource when you start MetalLB. If the **controller** allocated the IP address to the service and service is still unavailable, read the **speaker** pod logs. If the **speaker** pod is unavailable, run the **oc describe pod -n** command.

For layer 2 mode, after the **controller** allocates an IP address for the service, the **speaker** pods use an algorithm to determine which **speaker** pod on which node will announce the load balancer IP address. The algorithm involves hashing the node name and the load balancer IP address. For more information, see "MetalLB and external traffic policy". The **speaker** uses Address Resolution Protocol (ARP) to announce IPv4 addresses and Neighbor Discovery Protocol (NDP) to announce IPv6 addresses.

For Border Gateway Protocol (BGP) mode, after the **controller** allocates an IP address for the service, each **speaker** pod advertises the load balancer IP address with its BGP peers. You can configure which nodes start BGP sessions with BGP peers.

Requests for the load balancer IP address are routed to the node with the **speaker** that announces the IP address. After the node receives the packets, the service proxy routes the packets to an endpoint for the service. The endpoint can be on the same node in the optimal case, or it can be on another node. The service proxy chooses an endpoint each time a connection is established.

36.1.4. MetalLB and external traffic policy

With layer 2 mode, one node in your cluster receives all the traffic for the service IP address. With BGP mode, a router on the host network opens a connection to one of the nodes in the cluster for a new client connection. How your cluster handles the traffic after it enters the node is affected by the external traffic policy.

cluster

This is the default value for **spec.externalTrafficPolicy**.

With the **cluster** traffic policy, after the node receives the traffic, the service proxy distributes the traffic to all the pods in your service. This policy provides uniform traffic distribution across the pods, but it obscures the client IP address and it can appear to the application in your pods that the traffic originates from the node rather than the client.

local

With the **local** traffic policy, after the node receives the traffic, the service proxy only sends traffic to the pods on the same node. For example, if the **speaker** pod on node A announces the external service IP, then all traffic is sent to node A. After the traffic enters node A, the service proxy only sends traffic to pods for the service that are also on node A. Pods for the service that are on additional nodes do not receive any traffic from node A. Pods for the service on additional nodes act as replicas in case failover is needed.

This policy does not affect the client IP address. Application pods can determine the client IP address from the incoming connections.

**NOTE**

The following information is important when configuring the external traffic policy in BGP mode.

Although MetalLB advertises the load balancer IP address from all the eligible nodes, the number of nodes loadbalancing the service can be limited by the capacity of the router to establish equal-cost multipath (ECMP) routes. If the number of nodes advertising the IP is greater than the ECMP group limit of the router, the router will use less nodes than the ones advertising the IP.

For example, if the external traffic policy is set to **local** and the router has an ECMP group limit set to 16 and the pods implementing a LoadBalancer service are deployed on 30 nodes, this would result in pods deployed on 14 nodes not receiving any traffic. In this situation, it would be preferable to set the external traffic policy for the service to **cluster**.

36.1.5. MetalLB concepts for layer 2 mode

In layer 2 mode, the **speaker** pod on one node announces the external IP address for a service to the host network. From a network perspective, the node appears to have multiple IP addresses assigned to a network interface.

**NOTE**

In layer 2 mode, MetalLB relies on ARP and NDP. These protocols implement local address resolution within a specific subnet. In this context, the client must be able to reach the VIP assigned by MetalLB that exists on the same subnet as the nodes announcing the service in order for MetalLB to work.

The **speaker** pod responds to ARP requests for IPv4 services and NDP requests for IPv6.

In layer 2 mode, all traffic for a service IP address is routed through one node. After traffic enters the node, the service proxy for the CNI network provider distributes the traffic to all the pods for the service.

Because all traffic for a service enters through a single node in layer 2 mode, in a strict sense, MetalLB does not implement a load balancer for layer 2. Rather, MetalLB implements a failover mechanism for layer 2 so that when a **speaker** pod becomes unavailable, a **speaker** pod on a different node can announce the service IP address.

When a node becomes unavailable, failover is automatic. The **speaker** pods on the other nodes detect that a node is unavailable and a new **speaker** pod and node take ownership of the service IP address from the failed node.

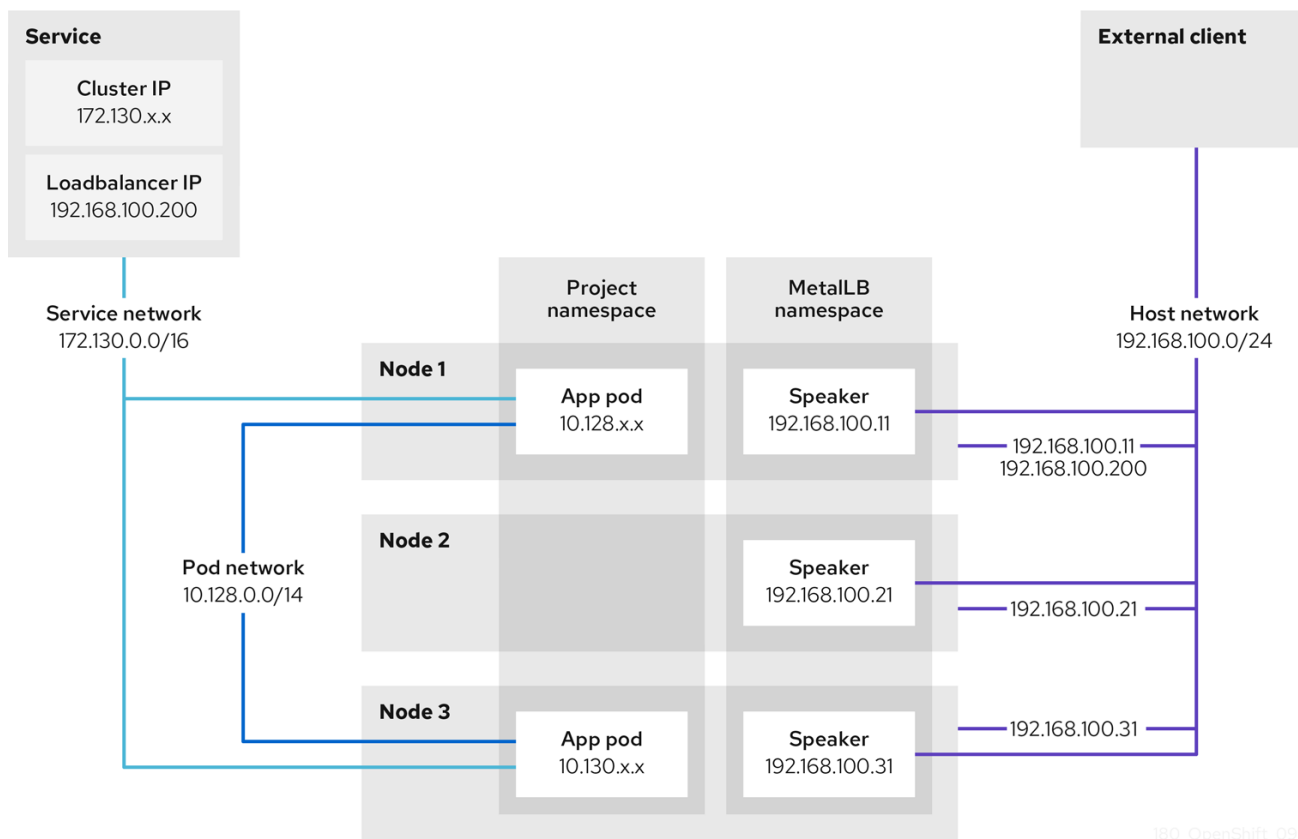

180_OpenShift_0921

The preceding graphic shows the following concepts related to MetalLB:

- An application is available through a service that has a cluster IP on the **172.130.0.0/16** subnet. That IP address is accessible from inside the cluster. The service also has an external IP address that MetalLB assigned to the service, **192.168.100.200**.
- Nodes 1 and 3 have a pod for the application.
- The **speaker** daemon set runs a pod on each node. The MetalLB Operator starts these pods.
- Each **speaker** pod is a host-networked pod. The IP address for the pod is identical to the IP address for the node on the host network.
- The **speaker** pod on node 1 uses ARP to announce the external IP address for the service, **192.168.100.200**. The **speaker** pod that announces the external IP address must be on the same node as an endpoint for the service and the endpoint must be in the **Ready** condition.
- Client traffic is routed to the host network and connects to the **192.168.100.200** IP address. After traffic enters the node, the service proxy sends the traffic to the application pod on the same node or another node according to the external traffic policy that you set for the service.
 - If the external traffic policy for the service is set to **cluster**, the node that advertises the **192.168.100.200** load balancer IP address is selected from the nodes where a **speaker** pod is running. Only that node can receive traffic for the service.
 - If the external traffic policy for the service is set to **local**, the node that advertises the **192.168.100.200** load balancer IP address is selected from the nodes where a **speaker** pod is running and at least an endpoint of the service. Only that node can receive traffic for the service. In the preceding graphic, either node 1 or 3 would advertise **192.168.100.200**.
- If node 1 becomes unavailable, the external IP address fails over to another node. On another

node that has an instance of the application pod and service endpoint, the **speaker** pod begins to announce the external IP address, **192.168.100.200** and the new node receives the client traffic. In the diagram, the only candidate is node 3.

36.1.6. MetalLB concepts for BGP mode

In BGP mode, by default each **speaker** pod advertises the load balancer IP address for a service to each BGP peer. It is also possible to advertise the IPs coming from a given pool to a specific set of peers by adding an optional list of BGP peers. BGP peers are commonly network routers that are configured to use the BGP protocol. When a router receives traffic for the load balancer IP address, the router picks one of the nodes with a **speaker** pod that advertised the IP address. The router sends the traffic to that node. After traffic enters the node, the service proxy for the CNI network plugin distributes the traffic to all the pods for the service.

The directly-connected router on the same layer 2 network segment as the cluster nodes can be configured as a BGP peer. If the directly-connected router is not configured as a BGP peer, you need to configure your network so that packets for load balancer IP addresses are routed between the BGP peers and the cluster nodes that run the **speaker** pods.

Each time a router receives new traffic for the load balancer IP address, it creates a new connection to a node. Each router manufacturer has an implementation-specific algorithm for choosing which node to initiate the connection with. However, the algorithms commonly are designed to distribute traffic across the available nodes for the purpose of balancing the network load.

If a node becomes unavailable, the router initiates a new connection with another node that has a **speaker** pod that advertises the load balancer IP address.

Figure 36.1. MetalLB topology diagram for BGP mode

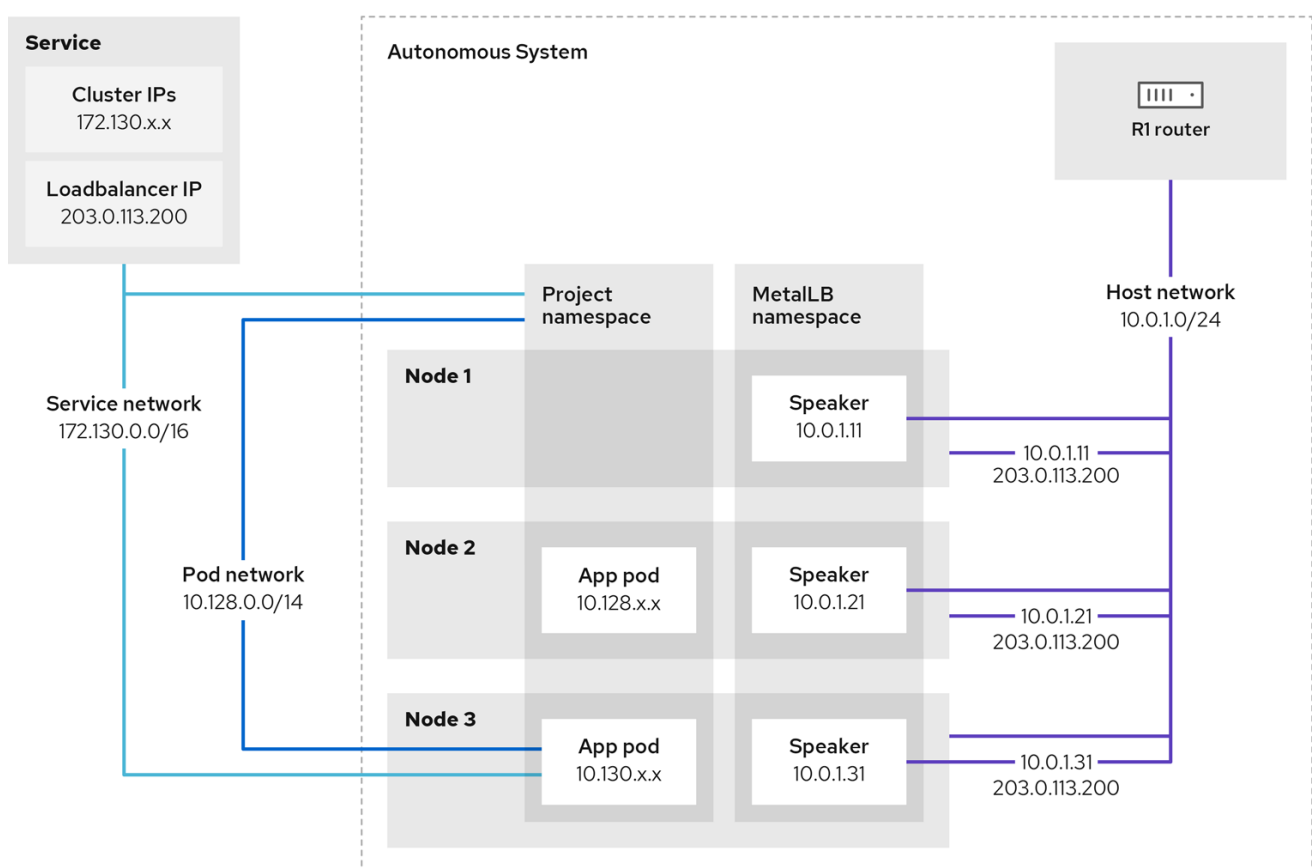

209_OpenShift_0122

The preceding graphic shows the following concepts related to MetalLB:

- An application is available through a service that has an IPv4 cluster IP on the **172.130.0.0/16** subnet. That IP address is accessible from inside the cluster. The service also has an external IP address that MetalLB assigned to the service, **203.0.113.200**.
- Nodes 2 and 3 have a pod for the application.
- The **speaker** daemon set runs a pod on each node. The MetalLB Operator starts these pods. You can configure MetalLB to specify which nodes run the **speaker** pods.
- Each **speaker** pod is a host-networked pod. The IP address for the pod is identical to the IP address for the node on the host network.
- Each **speaker** pod starts a BGP session with all BGP peers and advertises the load balancer IP addresses or aggregated routes to the BGP peers. The **speaker** pods advertise that they are part of Autonomous System 65010. The diagram shows a router, R1, as a BGP peer within the same Autonomous System. However, you can configure MetalLB to start BGP sessions with peers that belong to other Autonomous Systems.
- All the nodes with a **speaker** pod that advertises the load balancer IP address can receive traffic for the service.
 - If the external traffic policy for the service is set to **cluster**, all the nodes where a speaker pod is running advertise the **203.0.113.200** load balancer IP address and all the nodes with a **speaker** pod can receive traffic for the service. The host prefix is advertised to the router peer only if the external traffic policy is set to cluster.
 - If the external traffic policy for the service is set to **local**, then all the nodes where a **speaker** pod is running and at least an endpoint of the service is running can advertise the **203.0.113.200** load balancer IP address. Only those nodes can receive traffic for the service. In the preceding graphic, nodes 2 and 3 would advertise **203.0.113.200**.
- You can configure MetalLB to control which **speaker** pods start BGP sessions with specific BGP peers by specifying a node selector when you add a BGP peer custom resource.
- Any routers, such as R1, that are configured to use BGP can be set as BGP peers.
- Client traffic is routed to one of the nodes on the host network. After traffic enters the node, the service proxy sends the traffic to the application pod on the same node or another node according to the external traffic policy that you set for the service.
- If a node becomes unavailable, the router detects the failure and initiates a new connection with another node. You can configure MetalLB to use a Bidirectional Forwarding Detection (BFD) profile for BGP peers. BFD provides faster link failure detection so that routers can initiate new connections earlier than without BFD.

36.1.7. Limitations and restrictions

36.1.7.1. Infrastructure considerations for MetalLB

MetalLB is primarily useful for on-premise, bare metal installations because these installations do not include a native load-balancer capability. In addition to bare metal installations, installations of OpenShift Container Platform on some infrastructures might not include a native load-balancer capability. For example, the following infrastructures can benefit from adding the MetalLB Operator:

- Bare metal
- VMware vSphere
- IBM Z® and IBM® LinuxONE
- IBM Z® and IBM® LinuxONE for Red Hat Enterprise Linux (RHEL) KVM
- IBM Power®

MetalLB Operator and MetalLB are supported with the OpenShift SDN and OVN-Kubernetes network providers.

36.1.7.2. Limitations for layer 2 mode

36.1.7.2.1. Single-node bottleneck

MetalLB routes all traffic for a service through a single node, the node can become a bottleneck and limit performance.

Layer 2 mode limits the ingress bandwidth for your service to the bandwidth of a single node. This is a fundamental limitation of using ARP and NDP to direct traffic.

36.1.7.2.2. Slow failover performance

Failover between nodes depends on cooperation from the clients. When a failover occurs, MetalLB sends gratuitous ARP packets to notify clients that the MAC address associated with the service IP has changed.

Most client operating systems handle gratuitous ARP packets correctly and update their neighbor caches promptly. When clients update their caches quickly, failover completes within a few seconds. Clients typically fail over to a new node within 10 seconds. However, some client operating systems either do not handle gratuitous ARP packets at all or have outdated implementations that delay the cache update.

Recent versions of common operating systems such as Windows, macOS, and Linux implement layer 2 failover correctly. Issues with slow failover are not expected except for older and less common client operating systems.

To minimize the impact from a planned failover on outdated clients, keep the old node running for a few minutes after flipping leadership. The old node can continue to forward traffic for outdated clients until their caches refresh.

During an unplanned failover, the service IPs are unreachable until the outdated clients refresh their cache entries.

36.1.7.2.3. Additional Network and MetalLB cannot use same network

Using the same VLAN for both MetalLB and an additional network interface set up on a source pod might result in a connection failure. This occurs when both the MetalLB IP and the source pod reside on the same node.

To avoid connection failures, place the MetalLB IP in a different subnet from the one where the source pod resides. This configuration ensures that traffic from the source pod will take the default gateway. Consequently, the traffic can effectively reach its destination by using the OVN overlay network, ensuring that the connection functions as intended.

36.1.7.3. Limitations for BGP mode

36.1.7.3.1. Node failure can break all active connections

MetalLB shares a limitation that is common to BGP-based load balancing. When a BGP session terminates, such as when a node fails or when a **speaker** pod restarts, the session termination might result in resetting all active connections. End users can experience a **Connection reset by peer** message.

The consequence of a terminated BGP session is implementation-specific for each router manufacturer. However, you can anticipate that a change in the number of **speaker** pods affects the number of BGP sessions and that active connections with BGP peers will break.

To avoid or reduce the likelihood of a service interruption, you can specify a node selector when you add a BGP peer. By limiting the number of nodes that start BGP sessions, a fault on a node that does not have a BGP session has no affect on connections to the service.

36.1.7.3.2. Support for a single ASN and a single router ID only

When you add a BGP peer custom resource, you specify the **spec.myASN** field to identify the Autonomous System Number (ASN) that MetalLB belongs to. OpenShift Container Platform uses an implementation of BGP with MetalLB that requires MetalLB to belong to a single ASN. If you attempt to add a BGP peer and specify a different value for **spec.myASN** than an existing BGP peer custom resource, you receive an error.

Similarly, when you add a BGP peer custom resource, the **spec.routerID** field is optional. If you specify a value for this field, you must specify the same value for all other BGP peer custom resources that you add.

The limitation to support a single ASN and single router ID is a difference with the community-supported implementation of MetalLB.

36.1.8. Additional resources

- [Comparison: Fault tolerant access to external IP addresses](#)
- [Removing IP failover](#)
- [Deployment specifications for MetalLB](#)

36.2. INSTALLING THE METALLB OPERATOR

As a cluster administrator, you can add the MetalLB Operator so that the Operator can manage the lifecycle for an instance of MetalLB on your cluster.

MetalLB and IP failover are incompatible. If you configured IP failover for your cluster, perform the steps to [remove IP failover](#) before you install the Operator.

36.2.1. Installing the MetalLB Operator from the OperatorHub using the web console

As a cluster administrator, you can install the MetalLB Operator by using the OpenShift Container Platform web console.

Prerequisites

- Log in as a user with **cluster-admin** privileges.

Procedure

1. In the OpenShift Container Platform web console, navigate to **Operators** → **OperatorHub**.
2. Type a keyword into the **Filter by keyword** box or scroll to find the Operator you want. For example, type **metallb** to find the MetalLB Operator.
You can also filter options by **Infrastructure Features**. For example, select **Disconnected** if you want to see Operators that work in disconnected environments, also known as restricted network environments.
3. On the **Install Operator** page, accept the defaults and click **Install**.

Verification

1. To confirm that the installation is successful:
 - a. Navigate to the **Operators** → **Installed Operators** page.
 - b. Check that the Operator is installed in the **openshift-operators** namespace and that its status is **Succeeded**.
2. If the Operator is not installed successfully, check the status of the Operator and review the logs:
 - a. Navigate to the **Operators** → **Installed Operators** page and inspect the **Status** column for any errors or failures.
 - b. Navigate to the **Workloads** → **Pods** page and check the logs in any pods in the **openshift-operators** project that are reporting issues.

36.2.2. Installing from OperatorHub using the CLI

Instead of using the OpenShift Container Platform web console, you can install an Operator from OperatorHub using the CLI. You can use the OpenShift CLI (**oc**) to install the MetalLB Operator.

It is recommended that when using the CLI you install the Operator in the **metallb-system** namespace.

Prerequisites

- A cluster installed on bare-metal hardware.
- Install the OpenShift CLI (**oc**).
- Log in as a user with **cluster-admin** privileges.

Procedure

1. Create a namespace for the MetalLB Operator by entering the following command:

```
$ cat << EOF | oc apply -f -
apiVersion: v1
kind: Namespace
```

```
metadata:  
  name: metallb-system  
EOF
```

2. Create an Operator group custom resource (CR) in the namespace:

```
$ cat << EOF | oc apply -f -  
apiVersion: operators.coreos.com/v1  
kind: OperatorGroup  
metadata:  
  name: metallb-operator  
  namespace: metallb-system  
EOF
```

3. Confirm the Operator group is installed in the namespace:

```
$ oc get operatorgroup -n metallb-system
```

Example output

```
NAME          AGE  
metallb-operator 14m
```

4. Create a **Subscription** CR:

- a. Define the **Subscription** CR and save the YAML file, for example, **metallb-sub.yaml**:

```
apiVersion: operators.coreos.com/v1alpha1  
kind: Subscription  
metadata:  
  name: metallb-operator-sub  
  namespace: metallb-system  
spec:  
  channel: stable  
  name: metallb-operator  
  source: redhat-operators 1  
  sourceNamespace: openshift-marketplace
```

- 1** You must specify the **redhat-operators** value.

- b. To create the **Subscription** CR, run the following command:

```
$ oc create -f metallb-sub.yaml
```

5. Optional: To ensure BGP and BFD metrics appear in Prometheus, you can label the namespace as in the following command:

```
$ oc label ns metallb-system "openshift.io/cluster-monitoring=true"
```

Verification

The verification steps assume the MetalLB Operator is installed in the **metallb-system** namespace.

1. Confirm the install plan is in the namespace:

```
$ oc get installplan -n metallb-system
```

Example output

```
NAME          CSV                                APPROVAL  APPROVED
install-wzg94 metallb-operator.4.15.0-nnnnnnnnnnn Automatic true
```

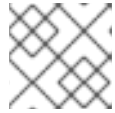

NOTE

Installation of the Operator might take a few seconds.

2. To verify that the Operator is installed, enter the following command:

```
$ oc get clusterserviceversion -n metallb-system \
-o custom-columns=Name:.metadata.name,Phase:.status.phase
```

Example output

```
Name                               Phase
metallb-operator.4.15.0-nnnnnnnnnnn Succeeded
```

36.2.3. Starting MetalLB on your cluster

After you install the Operator, you need to configure a single instance of a MetalLB custom resource. After you configure the custom resource, the Operator starts MetalLB on your cluster.

Prerequisites

- Install the OpenShift CLI (**oc**).
- Log in as a user with **cluster-admin** privileges.
- Install the MetalLB Operator.

Procedure

This procedure assumes the MetalLB Operator is installed in the **metallb-system** namespace. If you installed using the web console substitute **openshift-operators** for the namespace.

1. Create a single instance of a MetalLB custom resource:

```
$ cat << EOF | oc apply -f -
apiVersion: metallb.io/v1beta1
kind: MetalLB
metadata:
  name: metallb
  namespace: metallb-system
EOF
```

Verification

Confirm that the deployment for the MetalLB controller and the daemon set for the MetalLB speaker are running.

1. Verify that the deployment for the controller is running:

```
$ oc get deployment -n metallb-system controller
```

Example output

```
NAME      READY  UP-TO-DATE  AVAILABLE  AGE
controller 1/1    1           1          11m
```

2. Verify that the daemon set for the speaker is running:

```
$ oc get daemonset -n metallb-system speaker
```

Example output

```
NAME      DESIRED  CURRENT  READY  UP-TO-DATE  AVAILABLE  NODE
SELECTOR  AGE
speaker  6        6        6      6           6          kubernetes.io/os=linux 18m
```

The example output indicates 6 speaker pods. The number of speaker pods in your cluster might differ from the example output. Make sure the output indicates one pod for each node in your cluster.

36.2.4. Deployment specifications for MetalLB

When you start an instance of MetalLB using the **MetalLB** custom resource, you can configure deployment specifications in the **MetalLB** custom resource to manage how the **controller** or **speaker** pods deploy and run in your cluster. Use these deployment specifications to manage the following tasks:

- Select nodes for MetalLB pod deployment.
- Manage scheduling by using pod priority and pod affinity.
- Assign CPU limits for MetalLB pods.
- Assign a container RuntimeClass for MetalLB pods.
- Assign metadata for MetalLB pods.

36.2.4.1. Limit speaker pods to specific nodes

By default, when you start MetalLB with the MetalLB Operator, the Operator starts an instance of a **speaker** pod on each node in the cluster. Only the nodes with a **speaker** pod can advertise a load balancer IP address. You can configure the **MetalLB** custom resource with a node selector to specify which nodes run the **speaker** pods.

The most common reason to limit the **speaker** pods to specific nodes is to ensure that only nodes with network interfaces on specific networks advertise load balancer IP addresses. Only the nodes with a running **speaker** pod are advertised as destinations of the load balancer IP address.

If you limit the **speaker** pods to specific nodes and specify **local** for the external traffic policy of a service, then you must ensure that the application pods for the service are deployed to the same nodes.

Example configuration to limit speaker pods to worker nodes

```
apiVersion: metallb.io/v1beta1
kind: MetalLB
metadata:
  name: metallb
  namespace: metallb-system
spec:
  nodeSelector: ❶
    node-role.kubernetes.io/worker: ""
  speakerTolerations: ❷
  - key: "Example"
    operator: "Exists"
    effect: "NoExecute"
```

- ❶ The example configuration specifies to assign the speaker pods to worker nodes, but you can specify labels that you assigned to nodes or any valid node selector.
- ❷ In this example configuration, the pod that this toleration is attached to tolerates any taint that matches the **key** value and **effect** value using the **operator**.

After you apply a manifest with the **spec.nodeSelector** field, you can check the number of pods that the Operator deployed with the **oc get daemonset -n metallb-system speaker** command. Similarly, you can display the nodes that match your labels with a command like **oc get nodes -l node-role.kubernetes.io/worker=**.

You can optionally allow the node to control which speaker pods should, or should not, be scheduled on them by using affinity rules. You can also limit these pods by applying a list of tolerations. For more information about affinity rules, taints, and tolerations, see the additional resources.

36.2.4.2. Configuring a container runtime class in a MetalLB deployment

You can optionally assign a container runtime class to **controller** and **speaker** pods by configuring the MetalLB custom resource. For example, for Windows workloads, you can assign a Windows runtime class to the pod, which uses this runtime class for all containers in the pod.

Prerequisites

- You are logged in as a user with **cluster-admin** privileges.
- You have installed the MetalLB Operator.

Procedure

1. Create a **RuntimeClass** custom resource, such as **myRuntimeClass.yaml**, to define your runtime class:

```
apiVersion: node.k8s.io/v1
kind: RuntimeClass
metadata:
```

```
name: myclass
handler: myconfiguration
```

- Apply the **RuntimeClass** custom resource configuration:

```
$ oc apply -f myRuntimeClass.yaml
```

- Create a **MetalLB** custom resource, such as **MetalLBRuntime.yaml**, to specify the **runtimeClassName** value:

```
apiVersion: metallb.io/v1beta1
kind: MetalLB
metadata:
  name: metallb
  namespace: metallb-system
spec:
  logLevel: debug
  controllerConfig:
    runtimeClassName: myclass
    annotations: 1
    controller: demo
  speakerConfig:
    runtimeClassName: myclass
    annotations:
      speaker: demo
```

- This example uses **annotations** to add metadata such as build release information or GitHub pull request information. You can populate annotations with characters that are not permitted in labels. However, you cannot use annotations to identify or select objects.

- Apply the **MetalLB** custom resource configuration:

```
$ oc apply -f MetalLBRuntime.yaml
```

Verification

- To view the container runtime for a pod, run the following command:

```
$ oc get pod -o custom-
columns=NAME:metadata.name,STATUS:.status.phase,RUNTIME_CLASS:.spec.runtimeClass
Name
```

36.2.4.3. Configuring pod priority and pod affinity in a MetalLB deployment

You can optionally assign pod priority and pod affinity rules to **controller** and **speaker** pods by configuring the **MetalLB** custom resource. The pod priority indicates the relative importance of a pod on a node and schedules the pod based on this priority. Set a high priority on your **controller** or **speaker** pod to ensure scheduling priority over other pods on the node.

Pod affinity manages relationships among pods. Assign pod affinity to the **controller** or **speaker** pods to control on what node the scheduler places the pod in the context of pod relationships. For example, you can use pod affinity rules to ensure that certain pods are located on the same node or nodes, which can help improve network communication and reduce latency between those components.

Prerequisites

- You are logged in as a user with **cluster-admin** privileges.
- You have installed the MetalLB Operator.
- You have started the MetalLB Operator on your cluster.

Procedure

1. Create a **PriorityClass** custom resource, such as **myPriorityClass.yaml**, to configure the priority level. This example defines a **PriorityClass** named **high-priority** with a value of **1000000**. Pods that are assigned this priority class are considered higher priority during scheduling compared to pods with lower priority classes:

```
apiVersion: scheduling.k8s.io/v1
kind: PriorityClass
metadata:
  name: high-priority
value: 1000000
```

2. Apply the **PriorityClass** custom resource configuration:

```
$ oc apply -f myPriorityClass.yaml
```

3. Create a **MetalLB** custom resource, such as **MetalLBPodConfig.yaml**, to specify the **priorityClassName** and **podAffinity** values:

```
apiVersion: metallb.io/v1beta1
kind: MetalLB
metadata:
  name: metallb
  namespace: metallb-system
spec:
  logLevel: debug
  controllerConfig:
    priorityClassName: high-priority ❶
    affinity:
      podAffinity: ❷
        requiredDuringSchedulingIgnoredDuringExecution:
          - labelSelector:
              matchLabels:
                app: metallb
            topologyKey: kubernetes.io/hostname
  speakerConfig:
    priorityClassName: high-priority
    affinity:
      podAffinity:
        requiredDuringSchedulingIgnoredDuringExecution:
          - labelSelector:
              matchLabels:
                app: metallb
            topologyKey: kubernetes.io/hostname
```

- 1 Specifies the priority class for the MetalLB controller pods. In this case, it is set to **high-priority**.
- 2 Specifies that you are configuring pod affinity rules. These rules dictate how pods are scheduled in relation to other pods or nodes. This configuration instructs the scheduler to schedule pods that have the label **app: metallb** onto nodes that share the same hostname. This helps to co-locate MetalLB-related pods on the same nodes, potentially optimizing network communication, latency, and resource usage between these pods.

4. Apply the **MetalLB** custom resource configuration:

```
$ oc apply -f MetalLBPodConfig.yaml
```

Verification

- To view the priority class that you assigned to pods in the **metallb-system** namespace, run the following command:

```
$ oc get pods -n metallb-system -o custom-  
columns=NAME:.metadata.name,PRIORITY:.spec.priorityClassName
```

Example output

```
NAME                                PRIORITY  
controller-584f5c8cd8-5zbvg         high-priority  
metallb-operator-controller-manager-9c8d9985-szkqg <none>  
metallb-operator-webhook-server-c895594d4-shjgx <none>  
speaker-dddf7                        high-priority
```

- To verify that the scheduler placed pods according to pod affinity rules, view the metadata for the pod's node or nodes by running the following command:

```
$ oc get pod -o=custom-columns=NODE:.spec.nodeName,NAME:.metadata.name -n  
metallb-system
```

36.2.4.4. Configuring pod CPU limits in a MetalLB deployment

You can optionally assign pod CPU limits to **controller** and **speaker** pods by configuring the **MetalLB** custom resource. Defining CPU limits for the **controller** or **speaker** pods helps you to manage compute resources on the node. This ensures all pods on the node have the necessary compute resources to manage workloads and cluster housekeeping.

Prerequisites

- You are logged in as a user with **cluster-admin** privileges.
- You have installed the MetalLB Operator.

Procedure

1. Create a **MetalLB** custom resource file, such as **CPULimits.yaml**, to specify the **cpu** value for the **controller** and **speaker** pods:

■

```

apiVersion: metallb.io/v1beta1
kind: MetalLB
metadata:
  name: metallb
  namespace: metallb-system
spec:
  logLevel: debug
  controllerConfig:
    resources:
      limits:
        cpu: "200m"
  speakerConfig:
    resources:
      limits:
        cpu: "300m"

```

2. Apply the **MetalLB** custom resource configuration:

```
$ oc apply -f CPULimits.yaml
```

Verification

- To view compute resources for a pod, run the following command, replacing **<pod_name>** with your target pod:

```
$ oc describe pod <pod_name>
```

36.2.5. Additional resources

- [Placing pods on specific nodes using node selectors](#)
- [Understanding taints and tolerations](#)
- [Understanding pod priority](#)
- [Understanding pod affinity](#)

36.2.6. Next steps

- [Configuring MetalLB address pools](#)

36.3. UPGRADING THE METALLB

If you are currently running version 4.10 or an earlier version of the MetalLB Operator, please note that automatic updates to any version later than 4.10 do not work. Upgrading to a newer version from any version of the MetalLB Operator that is 4.11 or later is successful. For example, upgrading from version 4.12 to version 4.13 will occur smoothly.

A summary of the upgrade procedure for the MetalLB Operator from 4.10 and earlier is as follows:

1. Delete the installed MetalLB Operator version for example 4.10. Ensure that the namespace and the **metallb** custom resource are not removed.

- Using the CLI, install the MetalLB Operator 4.15 in the same namespace where the previous version of the MetalLB Operator was installed.

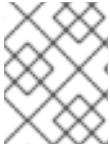

NOTE

This procedure does not apply to automatic z-stream updates of the MetalLB Operator, which follow the standard straightforward method.

For detailed steps to upgrade the MetalLB Operator from 4.10 and earlier, see the guidance that follows. As a cluster administrator, start the upgrade process by deleting the MetalLB Operator by using the OpenShift CLI (**oc**) or the web console.

36.3.1. Deleting the MetalLB Operator from a cluster using the web console

Cluster administrators can delete installed Operators from a selected namespace by using the web console.

Prerequisites

- Access to an OpenShift Container Platform cluster web console using an account with **cluster-admin** permissions.

Procedure

- Navigate to the **Operators → Installed Operators** page.
- Search for the MetalLB Operator. Then, click on it.
- On the right side of the **Operator Details** page, select **Uninstall Operator** from the **Actions** drop-down menu.
An **Uninstall Operator?** dialog box is displayed.
- Select **Uninstall** to remove the Operator, Operator deployments, and pods. Following this action, the Operator stops running and no longer receives updates.



NOTE

This action does not remove resources managed by the Operator, including custom resource definitions (CRDs) and custom resources (CRs). Dashboards and navigation items enabled by the web console and off-cluster resources that continue to run might need manual clean up. To remove these after uninstalling the Operator, you might need to manually delete the Operator CRDs.

36.3.2. Deleting MetalLB Operator from a cluster using the CLI

Cluster administrators can delete installed Operators from a selected namespace by using the CLI.

Prerequisites

- Access to an OpenShift Container Platform cluster using an account with **cluster-admin** permissions.
- oc** command installed on workstation.

Procedure

1. Check the current version of the subscribed MetalLB Operator in the **currentCSV** field:

```
$ oc get subscription metallb-operator -n metallb-system -o yaml | grep currentCSV
```

Example output

```
currentCSV: metallb-operator.4.10.0-202207051316
```

2. Delete the subscription:

```
$ oc delete subscription metallb-operator -n metallb-system
```

Example output

```
subscription.operators.coreos.com "metallb-operator" deleted
```

3. Delete the CSV for the Operator in the target namespace using the **currentCSV** value from the previous step:

```
$ oc delete clusterserviceversion metallb-operator.4.10.0-202207051316 -n metallb-system
```

Example output

```
clusterserviceversion.operators.coreos.com "metallb-operator.4.10.0-202207051316" deleted
```

36.3.3. Editing the MetalLB Operator Operator group

When upgrading from any MetalLB Operator version up to and including 4.10 to 4.11 and later, remove **spec.targetNamespaces** from the Operator group custom resource (CR). You must remove the spec regardless of whether you used the web console or the CLI to delete the MetalLB Operator.

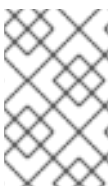

NOTE

The MetalLB Operator version 4.11 or later only supports the **AllNamespaces** install mode, whereas 4.10 or earlier versions support **OwnNamespace** or **SingleNamespace** modes.

Prerequisites

- You have access to an OpenShift Container Platform cluster with **cluster-admin** permissions.
- You have installed the OpenShift CLI (**oc**).

Procedure

1. List the Operator groups in the **metallb-system** namespace by running the following command:

```
$ oc get operatorgroup -n metallb-system
```

Example output

```
NAME          AGE
metallb-system-7jc66 85m
```

2. Verify that the **spec.targetNamespaces** is present in the Operator group CR associated with the **metallb-system** namespace by running the following command:

```
$ oc get operatorgroup metallb-system-7jc66 -n metallb-system -o yaml
```

Example output

```
apiVersion: operators.coreos.com/v1
kind: OperatorGroup
metadata:
  annotations:
    olm.providedAPIs: ""
  creationTimestamp: "2023-10-25T09:42:49Z"
  generateName: metallb-system-
  generation: 1
  name: metallb-system-7jc66
  namespace: metallb-system
  resourceVersion: "25027"
  uid: f5f644a0-eef8-4e31-a306-e2bbcfaffab3
spec:
  targetNamespaces:
  - metallb-system
  upgradeStrategy: Default
status:
  lastUpdated: "2023-10-25T09:42:49Z"
  namespaces:
  - metallb-system
```

3. Edit the Operator group and remove the **targetNamespaces** and **metallb-system** present under the **spec** section by running the following command:

```
$ oc edit n metallb-system
```

Example output

```
operatorgroup.operators.coreos.com/metallb-system-7jc66 edited
```

4. Verify the **spec.targetNamespaces** is removed from the Operator group custom resource associated with the **metallb-system** namespace by running the following command:

```
$ oc get operatorgroup metallb-system-7jc66 -n metallb-system -o yaml
```

Example output

```
apiVersion: operators.coreos.com/v1
kind: OperatorGroup
metadata:
  annotations:
```

```

    olm.providedAPIs: ""
    creationTimestamp: "2023-10-25T09:42:49Z"
    generateName: metallb-system-
    generation: 2
    name: metallb-system-7jc66
    namespace: metallb-system
    resourceVersion: "61658"
    uid: f5f644a0-eef8-4e31-a306-e2bbcfaffab3
  spec:
    upgradeStrategy: Default
  status:
    lastUpdated: "2023-10-25T14:31:30Z"
  namespaces:
  - ""

```

36.3.4. Upgrading the MetalLB Operator

Prerequisites

- Access the cluster as a user with the **cluster-admin** role.

Procedure

1. Verify that the **metallb-system** namespace still exists:

```
$ oc get namespaces | grep metallb-system
```

Example output

```
metallb-system          Active 31m
```

2. Verify the **metallb** custom resource still exists:

```
$ oc get metallb -n metallb-system
```

Example output

```
NAME    AGE
metallb 33m
```

3. Follow the guidance in "Installing from OperatorHub using the CLI" to install the latest 4.15 version of the MetalLB Operator.



NOTE

When installing the latest 4.15 version of the MetalLB Operator, you must install the Operator to the same namespace it was previously installed to.

4. Verify the upgraded version of the Operator is now the 4.15 version.

```
$ oc get csv -n metallb-system
```

Example output

```

NAME                                DISPLAY          VERSION          REPLACES          PHASE
metallb-operator.4.15.0-202207051316  MetallLB Operator  4.15.0-202207051316
Succeeded

```

36.3.5. Additional resources

- [Deleting Operators from a cluster](#)
- [Installing the MetalLB Operator](#)

36.4. CONFIGURING METALLB ADDRESS POOLS

As a cluster administrator, you can add, modify, and delete address pools. The MetalLB Operator uses the address pool custom resources to set the IP addresses that MetalLB can assign to services. The namespace used in the examples assume the namespace is **metallb-system**.

36.4.1. About the IPAddressPool custom resource



NOTE

The address pool custom resource definition (CRD) and API documented in "Load balancing with MetalLB" in OpenShift Container Platform 4.10 can still be used in 4.15. However, the enhanced functionality associated with advertising an IP address from an **IPAddressPool** with layer 2 protocols, or the BGP protocol, is not supported when using the **AddressPool** CRD.

The fields for the **IPAddressPool** custom resource are described in the following tables.

Table 36.1. MetalLB IPAddressPool pool custom resource

| Field | Type | Description |
|---------------------------|---------------|---|
| metadata.name | string | Specifies the name for the address pool. When you add a service, you can specify this pool name in the metallb.universe.tf/address-pool annotation to select an IP address from a specific pool. The names doc-example , silver , and gold are used throughout the documentation. |
| metadata.namespace | string | Specifies the namespace for the address pool. Specify the same namespace that the MetalLB Operator uses. |
| metadata.label | string | Optional: Specifies the key value pair assigned to the IPAddressPool . This can be referenced by the ipAddressPoolSelectors in the BGPAdvertisement and L2Advertisement CRD to associate the IPAddressPool with the advertisement |

| Field | Type | Description |
|---------------------------|----------------|---|
| spec.addresses | string | Specifies a list of IP addresses for MetalLB Operator to assign to services. You can specify multiple ranges in a single pool; they will all share the same settings. Specify each range in CIDR notation or as starting and ending IP addresses separated with a hyphen. |
| spec.autoAssign | boolean | Optional: Specifies whether MetalLB automatically assigns IP addresses from this pool. Specify false if you want explicitly request an IP address from this pool with the metallb.universe.tf/address-pool annotation. The default value is true . |
| spec.avoidBuggyIPs | boolean | Optional: This ensures when enabled that IP addresses ending .0 and .255 are not allocated from the pool. The default value is false . Some older consumer network equipment mistakenly block IP addresses ending in .0 and .255. |

You can assign IP addresses from an **IPAddressPool** to services and namespaces by configuring the **spec.serviceAllocation** specification.

Table 36.2. MetalLB IPAddressPool custom resource **spec.serviceAllocation** subfields

| Field | Type | Description |
|---------------------------|------------------------------|--|
| priority | int | Optional: Defines the priority between IP address pools when more than one IP address pool matches a service or namespace. A lower number indicates a higher priority. |
| namespaces | array (string) | Optional: Specifies a list of namespaces that you can assign to IP addresses in an IP address pool. |
| namespaceSelectors | array (LabelSelector) | Optional: Specifies namespace labels that you can assign to IP addresses from an IP address pool by using label selectors in a list format. |
| serviceSelectors | array (LabelSelector) | Optional: Specifies service labels that you can assign to IP addresses from an address pool by using label selectors in a list format. |

36.4.2. Configuring an address pool

As a cluster administrator, you can add address pools to your cluster to control the IP addresses that MetalLB can assign to load-balancer services.

Prerequisites

- Install the OpenShift CLI (**oc**).

- Log in as a user with **cluster-admin** privileges.

Procedure

1. Create a file, such as **ipaddresspool.yaml**, with content like the following example:

```
apiVersion: metallb.io/v1beta1
kind: IPAddressPool
metadata:
  namespace: metallb-system
  name: doc-example
  labels: 1
    zone: east
spec:
  addresses:
  - 203.0.113.1-203.0.113.10
  - 203.0.113.65-203.0.113.75
```

- 1 This label assigned to the **IPAddressPool** can be referenced by the **ipAddressPoolSelectors** in the **BGPAdvertisement** CRD to associate the **IPAddressPool** with the advertisement.

2. Apply the configuration for the IP address pool:

```
$ oc apply -f ipaddresspool.yaml
```

Verification

- View the address pool:

```
$ oc describe -n metallb-system IPAddressPool doc-example
```

Example output

```
Name:      doc-example
Namespace: metallb-system
Labels:    zone=east
Annotations: <none>
API Version: metallb.io/v1beta1
Kind:      IPAddressPool
Metadata:
  ...
Spec:
  Addresses:
    203.0.113.1-203.0.113.10
    203.0.113.65-203.0.113.75
  Auto Assign: true
Events:     <none>
```

Confirm that the address pool name, such as **doc-example**, and the IP address ranges appear in the output.

36.4.3. Example address pool configurations

36.4.3.1. Example: IPv4 and CIDR ranges

You can specify a range of IP addresses in CIDR notation. You can combine CIDR notation with the notation that uses a hyphen to separate lower and upper bounds.

```
apiVersion: metallb.io/v1beta1
kind: IPAddressPool
metadata:
  name: doc-example-cidr
  namespace: metallb-system
spec:
  addresses:
  - 192.168.100.0/24
  - 192.168.200.0/24
  - 192.168.255.1-192.168.255.5
```

36.4.3.2. Example: Reserve IP addresses

You can set the **autoAssign** field to **false** to prevent MetalLB from automatically assigning the IP addresses from the pool. When you add a service, you can request a specific IP address from the pool or you can specify the pool name in an annotation to request any IP address from the pool.

```
apiVersion: metallb.io/v1beta1
kind: IPAddressPool
metadata:
  name: doc-example-reserved
  namespace: metallb-system
spec:
  addresses:
  - 10.0.100.0/28
  autoAssign: false
```

36.4.3.3. Example: IPv4 and IPv6 addresses

You can add address pools that use IPv4 and IPv6. You can specify multiple ranges in the **addresses** list, just like several IPv4 examples.

Whether the service is assigned a single IPv4 address, a single IPv6 address, or both is determined by how you add the service. The **spec.ipFamilies** and **spec.ipFamilyPolicy** fields control how IP addresses are assigned to the service.

```
apiVersion: metallb.io/v1beta1
kind: IPAddressPool
metadata:
  name: doc-example-combined
  namespace: metallb-system
spec:
  addresses:
  - 10.0.100.0/28
  - 2002:2:2::1-2002:2:2::100
```

36.4.3.4. Example: Assign IP address pools to services or namespaces

You can assign IP addresses from an **IPAddressPool** to services and namespaces that you specify.

If you assign a service or namespace to more than one IP address pool, MetalLB uses an available IP address from the higher-priority IP address pool. If no IP addresses are available from the assigned IP address pools with a high priority, MetalLB uses available IP addresses from an IP address pool with lower priority or no priority.



NOTE

You can use the **matchLabels** label selector, the **matchExpressions** label selector, or both, for the **namespaceSelectors** and **serviceSelectors** specifications. This example demonstrates one label selector for each specification.

```
apiVersion: metallb.io/v1beta1
kind: IPAddressPool
metadata:
  name: doc-example-service-allocation
  namespace: metallb-system
spec:
  addresses:
  - 192.168.20.0/24
  serviceAllocation:
    priority: 50 1
    namespaces: 2
    - namespace-a
    - namespace-b
    namespaceSelectors: 3
    - matchLabels:
        zone: east
    serviceSelectors: 4
    - matchExpressions:
        - key: security
          operator: In
          values:
            - S1
```

- 1** Assign a priority to the address pool. A lower number indicates a higher priority.
- 2** Assign one or more namespaces to the IP address pool in a list format.
- 3** Assign one or more namespace labels to the IP address pool by using label selectors in a list format.
- 4** Assign one or more service labels to the IP address pool by using label selectors in a list format.

36.4.4. Additional resources

- [Configuring MetalLB with an L2 advertisement and label](#).

36.4.5. Next steps

- For BGP mode, see [Configuring MetalLB BGP peers](#).

- [Configuring services to use MetalLB](#).

36.5. ABOUT ADVERTISING FOR THE IP ADDRESS POOLS

You can configure MetalLB so that the IP address is advertised with layer 2 protocols, the BGP protocol, or both. With layer 2, MetalLB provides a fault-tolerant external IP address. With BGP, MetalLB provides fault-tolerance for the external IP address and load balancing.

MetalLB supports advertising using L2 and BGP for the same set of IP addresses.

MetalLB provides the flexibility to assign address pools to specific BGP peers effectively to a subset of nodes on the network. This allows for more complex configurations, for example facilitating the isolation of nodes or the segmentation of the network.

36.5.1. About the BGPAdvertisement custom resource

The fields for the **BGPAdvertisements** object are defined in the following table:

Table 36.3. BGPAdvertisements configuration

| Field | Type | Description |
|---------------------------------|----------------|--|
| metadata.name | string | Specifies the name for the BGP advertisement. |
| metadata.name space | string | Specifies the namespace for the BGP advertisement. Specify the same namespace that the MetalLB Operator uses. |
| spec.aggregationLength | integer | Optional: Specifies the number of bits to include in a 32-bit CIDR mask. To aggregate the routes that the speaker advertises to BGP peers, the mask is applied to the routes for several service IP addresses and the speaker advertises the aggregated route. For example, with an aggregation length of 24 , the speaker can aggregate several 10.0.1.x/32 service IP addresses and advertise a single 10.0.1.0/24 route. |
| spec.aggregationLengthV6 | integer | Optional: Specifies the number of bits to include in a 128-bit CIDR mask. For example, with an aggregation length of 124 , the speaker can aggregate several fc00:f853:0ccd:e799::x/128 service IP addresses and advertise a single fc00:f853:0ccd:e799::0/124 route. |

| Field | Type | Description |
|------------------------------------|----------------|--|
| spec.communities | string | <p>Optional: Specifies one or more BGP communities. Each community is specified as two 16-bit values separated by the colon character. Well-known communities must be specified as 16-bit values:</p> <ul style="list-style-type: none"> • NO_EXPORT: 65535:65281 • NO_ADVERTISE: 65535:65282 • NO_EXPORT_SUBCONFED: 65535:65283 <div style="display: flex; align-items: center;">  <div> <p>NOTE</p> <p>You can also use community objects that are created along with the strings.</p> </div> </div> |
| spec.localPref | integer | Optional: Specifies the local preference for this advertisement. This BGP attribute applies to BGP sessions within the Autonomous System. |
| spec.ipAddressPools | string | Optional: The list of IPAddressPools to advertise with this advertisement, selected by name. |
| spec.ipAddressPoolSelectors | string | Optional: A selector for the IPAddressPools that gets advertised with this advertisement. This is for associating the IPAddressPool to the advertisement based on the label assigned to the IPAddressPool instead of the name itself. If no IPAddressPool is selected by this or by the list, the advertisement is applied to all the IPAddressPools . |
| spec.nodeSelectors | string | Optional: NodeSelectors allows to limit the nodes to announce as next hops for the load balancer IP. When empty, all the nodes are announced as next hops. |
| spec.peers | string | Optional: Peers limits the BGP peer to advertise the IPs of the selected pools to. When empty, the load balancer IP is announced to all the BGP peers configured. |

36.5.2. Configuring MetalLB with a BGP advertisement and a basic use case

Configure MetalLB as follows so that the peer BGP routers receive one **203.0.113.200/32** route and one **fc00:f853:ccd:e799::1/128** route for each load-balancer IP address that MetalLB assigns to a service. Because the **localPref** and **communities** fields are not specified, the routes are advertised with **localPref** set to zero and no BGP communities.

36.5.2.1. Example: Advertise a basic address pool configuration with BGP

Configure MetalLB as follows so that the **IPAddressPool** is advertised with the BGP protocol.

Prerequisites

- Install the OpenShift CLI (**oc**).
- Log in as a user with **cluster-admin** privileges.

Procedure

1. Create an IP address pool.
 - a. Create a file, such as **ipaddresspool.yaml**, with content like the following example:

```
apiVersion: metallb.io/v1beta1
kind: IPAddressPool
metadata:
  namespace: metallb-system
  name: doc-example-bgp-basic
spec:
  addresses:
    - 203.0.113.200/30
    - fc00:f853:ccd:e799::/124
```

- b. Apply the configuration for the IP address pool:

```
$ oc apply -f ipaddresspool.yaml
```

2. Create a BGP advertisement.
 - a. Create a file, such as **bgpadvertisement.yaml**, with content like the following example:

```
apiVersion: metallb.io/v1beta1
kind: BGPAdvertisement
metadata:
  name: bgpadvertisement-basic
  namespace: metallb-system
spec:
  ipAddressPools:
    - doc-example-bgp-basic
```

- b. Apply the configuration:

```
$ oc apply -f bgpadvertisement.yaml
```

36.5.3. Configuring MetalLB with a BGP advertisement and an advanced use case

Configure MetalLB as follows so that MetalLB assigns IP addresses to load-balancer services in the ranges between **203.0.113.200** and **203.0.113.203** and between **fc00:f853:ccd:e799::0** and **fc00:f853:ccd:e799::f**.

To explain the two BGP advertisements, consider an instance when MetalLB assigns the IP address of **203.0.113.200** to a service. With that IP address as an example, the speaker advertises two routes to BGP peers:

- **203.0.113.200/32**, with **localPref** set to **100** and the community set to the numeric value of the **NO_ADVERTISE** community. This specification indicates to the peer routers that they can use this route but they should not propagate information about this route to BGP peers.
- **203.0.113.200/30**, aggregates the load-balancer IP addresses assigned by MetalLB into a single route. MetalLB advertises the aggregated route to BGP peers with the community attribute set to **8000:800**. BGP peers propagate the **203.0.113.200/30** route to other BGP peers. When traffic is routed to a node with a speaker, the **203.0.113.200/32** route is used to forward the traffic into the cluster and to a pod that is associated with the service.

As you add more services and MetalLB assigns more load-balancer IP addresses from the pool, peer routers receive one local route, **203.0.113.20x/32**, for each service, as well as the **203.0.113.200/30** aggregate route. Each service that you add generates the **/30** route, but MetalLB deduplicates the routes to one BGP advertisement before communicating with peer routers.

36.5.3.1. Example: Advertise an advanced address pool configuration with BGP

Configure MetalLB as follows so that the **IPAddressPool** is advertised with the BGP protocol.

Prerequisites

- Install the OpenShift CLI (**oc**).
- Log in as a user with **cluster-admin** privileges.

Procedure

1. Create an IP address pool.
 - a. Create a file, such as **ipaddresspool.yaml**, with content like the following example:

```
apiVersion: metallb.io/v1beta1
kind: IPAddressPool
metadata:
  namespace: metallb-system
  name: doc-example-bgp-adv
  labels:
    zone: east
spec:
  addresses:
  - 203.0.113.200/30
  - fc00:f853:ccd:e799::/124
  autoAssign: false
```

- b. Apply the configuration for the IP address pool:

```
$ oc apply -f ipaddresspool.yaml
```

2. Create a BGP advertisement.
 - a. Create a file, such as **bgpadvertisement1.yaml**, with content like the following example:

```
apiVersion: metallb.io/v1beta1
kind: BGPAdvertisement
metadata:
```



```

name: bgpadvertisement-adv-1
namespace: metallb-system
spec:
  ipAddressPools:
  - doc-example-bgp-adv
  communities:
  - 65535:65282
  aggregationLength: 32
  localPref: 100

```

- b. Apply the configuration:

```
$ oc apply -f bgpadvertisement1.yaml
```

- c. Create a file, such as **bgpadvertisement2.yaml**, with content like the following example:

```

apiVersion: metallb.io/v1beta1
kind: BGPAdvertisement
metadata:
  name: bgpadvertisement-adv-2
  namespace: metallb-system
spec:
  ipAddressPools:
  - doc-example-bgp-adv
  communities:
  - 8000:800
  aggregationLength: 30
  aggregationLengthV6: 124

```

- d. Apply the configuration:

```
$ oc apply -f bgpadvertisement2.yaml
```

36.5.4. Advertising an IP address pool from a subset of nodes

To advertise an IP address from an IP addresses pool, from a specific set of nodes only, use the **.spec.nodeSelector** specification in the BGPAdvertisement custom resource. This specification associates a pool of IP addresses with a set of nodes in the cluster. This is useful when you have nodes on different subnets in a cluster and you want to advertise an IP addresses from an address pool from a specific subnet, for example a public-facing subnet only.

Prerequisites

- Install the OpenShift CLI (**oc**).
- Log in as a user with **cluster-admin** privileges.

Procedure

1. Create an IP address pool by using a custom resource:

```

apiVersion: metallb.io/v1beta1
kind: IPAddressPool
metadata:

```

```

namespace: metallb-system
name: pool1
spec:
  addresses:
    - 4.4.4.100-4.4.4.200
    - 2001:100:4::200-2001:100:4::400

```

- Control which nodes in the cluster the IP address from **pool1** advertises from by defining the **.spec.nodeSelector** value in the BGPAdvertisement custom resource:

```

apiVersion: metallb.io/v1beta1
kind: BGPAdvertisement
metadata:
  name: example
spec:
  ipAddressPools:
    - pool1
  nodeSelector:
    - matchLabels:
        kubernetes.io/hostname: NodeA
    - matchLabels:
        kubernetes.io/hostname: NodeB

```

In this example, the IP address from **pool1** advertises from **NodeA** and **NodeB** only.

36.5.5. About the L2Advertisement custom resource

The fields for the **L2Advertisements** object are defined in the following table:

Table 36.4. L2 advertisements configuration

| Field | Type | Description |
|-------------------------------------|---------------|---|
| metadata.name | string | Specifies the name for the L2 advertisement. |
| metadata.name space | string | Specifies the namespace for the L2 advertisement. Specify the same namespace that the MetalLB Operator uses. |
| spec.ipAddress Pools | string | Optional: The list of IPAddressPools to advertise with this advertisement, selected by name. |
| spec.ipAddress PoolSelectors | string | Optional: A selector for the IPAddressPools that gets advertised with this advertisement. This is for associating the IPAddressPool to the advertisement based on the label assigned to the IPAddressPool instead of the name itself. If no IPAddressPool is selected by this or by the list, the advertisement is applied to all the IPAddressPools . |

| Field | Type | Description |
|---------------------------|---------------|---|
| spec.nodeSelectors | string | <p>Optional: NodeSelectors limits the nodes to announce as next hops for the load balancer IP. When empty, all the nodes are announced as next hops.</p> <div style="display: flex; align-items: flex-start;">  <div> <p>IMPORTANT</p> <p>Limiting the nodes to announce as next hops is a Technology Preview feature only. Technology Preview features are not supported with Red Hat production service level agreements (SLAs) and might not be functionally complete. Red Hat does not recommend using them in production. These features provide early access to upcoming product features, enabling customers to test functionality and provide feedback during the development process.</p> <p>For more information about the support scope of Red Hat Technology Preview features, see Technology Preview Features Support Scope</p> </div> </div> |
| spec.interfaces | string | Optional: The list of interfaces that are used to announce the load balancer IP. |

36.5.6. Configuring MetalLB with an L2 advertisement

Configure MetalLB as follows so that the **IPAddressPool** is advertised with the L2 protocol.

Prerequisites

- Install the OpenShift CLI (**oc**).
- Log in as a user with **cluster-admin** privileges.

Procedure

1. Create an IP address pool.
 - a. Create a file, such as **ipaddresspool.yaml**, with content like the following example:

```
apiVersion: metallb.io/v1beta1
kind: IPAddressPool
metadata:
  namespace: metallb-system
  name: doc-example-l2
spec:
  addresses:
  - 4.4.4.0/24
  autoAssign: false
```

- b. Apply the configuration for the IP address pool:

```
$ oc apply -f ipaddresspool.yaml
```

2. Create a L2 advertisement.

- a. Create a file, such as **l2advertisement.yaml**, with content like the following example:

```
apiVersion: metallb.io/v1beta1
kind: L2Advertisement
metadata:
  name: l2advertisement
  namespace: metallb-system
spec:
  ipAddressPools:
  - doc-example-l2
```

- b. Apply the configuration:

```
$ oc apply -f l2advertisement.yaml
```

36.5.7. Configuring MetalLB with a L2 advertisement and label

The **ipAddressPoolSelectors** field in the **BGPAdvertisement** and **L2Advertisement** custom resource definitions is used to associate the **IPAddressPool** to the advertisement based on the label assigned to the **IPAddressPool** instead of the name itself.

This example shows how to configure MetalLB so that the **IPAddressPool** is advertised with the L2 protocol by configuring the **ipAddressPoolSelectors** field.

Prerequisites

- Install the OpenShift CLI (**oc**).
- Log in as a user with **cluster-admin** privileges.

Procedure

1. Create an IP address pool.

- a. Create a file, such as **ipaddresspool.yaml**, with content like the following example:

```
apiVersion: metallb.io/v1beta1
kind: IPAddressPool
metadata:
  namespace: metallb-system
  name: doc-example-l2-label
  labels:
    zone: east
spec:
  addresses:
  - 172.31.249.87/32
```

- b. Apply the configuration for the IP address pool:

```
$ oc apply -f ipaddresspool.yaml
```

2. Create a L2 advertisement advertising the IP using **ipAddressPoolSelectors**.
 - a. Create a file, such as **l2advertisement.yaml**, with content like the following example:

```
apiVersion: metallb.io/v1beta1
kind: L2Advertisement
metadata:
  name: l2advertisement-label
  namespace: metallb-system
spec:
  ipAddressPoolSelectors:
  - matchExpressions:
    - key: zone
      operator: In
      values:
      - east
```

- b. Apply the configuration:

```
$ oc apply -f l2advertisement.yaml
```

36.5.8. Configuring MetalLB with an L2 advertisement for selected interfaces

By default, the IP addresses from IP address pool that has been assigned to the service, is advertised from all the network interfaces. The **interfaces** field in the **L2Advertisement** custom resource definition is used to restrict those network interfaces that advertise the IP address pool.

This example shows how to configure MetalLB so that the IP address pool is advertised only from the network interfaces listed in the **interfaces** field of all nodes.

Prerequisites

- You have installed the OpenShift CLI (**oc**).
- You are logged in as a user with **cluster-admin** privileges.

Procedure

1. Create an IP address pool.
 - a. Create a file, such as **ipaddresspool.yaml**, and enter the configuration details like the following example:

```
apiVersion: metallb.io/v1beta1
kind: IPAddressPool
metadata:
  namespace: metallb-system
  name: doc-example-l2
spec:
  addresses:
  - 4.4.4.0/24
  autoAssign: false
```

- b. Apply the configuration for the IP address pool like the following example:

```
$ oc apply -f ipaddresspool.yaml
```

2. Create a L2 advertisement advertising the IP with **interfaces** selector.

- a. Create a YAML file, such as **l2advertisement.yaml**, and enter the configuration details like the following example:

```
apiVersion: metallb.io/v1beta1
kind: L2Advertisement
metadata:
  name: l2advertisement
  namespace: metallb-system
spec:
  ipAddressPools:
    - doc-example-l2
  interfaces:
    - interfaceA
    - interfaceB
```

- b. Apply the configuration for the advertisement like the following example:

```
$ oc apply -f l2advertisement.yaml
```



IMPORTANT

The interface selector does not affect how MetalLB chooses the node to announce a given IP by using L2. The chosen node does not announce the service if the node does not have the selected interface.

36.5.9. Additional resources

- [Configuring a community alias.](#)

36.6. CONFIGURING METALLB BGP PEERS

As a cluster administrator, you can add, modify, and delete Border Gateway Protocol (BGP) peers. The MetalLB Operator uses the BGP peer custom resources to identify which peers that MetalLB **speaker** pods contact to start BGP sessions. The peers receive the route advertisements for the load-balancer IP addresses that MetalLB assigns to services.

36.6.1. About the BGP peer custom resource

The fields for the BGP peer custom resource are described in the following table.

Table 36.5. MetalLB BGP peer custom resource

| Field | Type | Description |
|----------------------|---------------|--|
| metadata.name | string | Specifies the name for the BGP peer custom resource. |

| Field | Type | Description |
|----------------------------|----------------|---|
| metadata.name space | string | Specifies the namespace for the BGP peer custom resource. |
| spec.myASN | integer | Specifies the Autonomous System number for the local end of the BGP session. Specify the same value in all BGP peer custom resources that you add. The range is 0 to 4294967295 . |
| spec.peerASN | integer | Specifies the Autonomous System number for the remote end of the BGP session. The range is 0 to 4294967295 . |
| spec.peerAddress | string | Specifies the IP address of the peer to contact for establishing the BGP session. |
| spec.sourceAddress | string | Optional: Specifies the IP address to use when establishing the BGP session. The value must be an IPv4 address. |
| spec.peerPort | integer | Optional: Specifies the network port of the peer to contact for establishing the BGP session. The range is 0 to 16384 . |
| spec.holdTime | string | Optional: Specifies the duration for the hold time to propose to the BGP peer. The minimum value is 3 seconds (3s). The common units are seconds and minutes, such as 3s , 1m , and 5m30s . To detect path failures more quickly, also configure BFD. |
| spec.keepaliveTime | string | Optional: Specifies the maximum interval between sending keep-alive messages to the BGP peer. If you specify this field, you must also specify a value for the holdTime field. The specified value must be less than the value for the holdTime field. |
| spec.routerID | string | Optional: Specifies the router ID to advertise to the BGP peer. If you specify this field, you must specify the same value in every BGP peer custom resource that you add. |
| spec.password | string | Optional: Specifies the MD5 password to send to the peer for routers that enforce TCP MD5 authenticated BGP sessions. |
| spec.passwordSecret | string | Optional: Specifies name of the authentication secret for the BGP Peer. The secret must live in the metallb namespace and be of type basic-auth. |
| spec.bfdProfile | string | Optional: Specifies the name of a BFD profile. |

| Field | Type | Description |
|---------------------------|-----------------|--|
| spec.nodeSelectors | object[] | Optional: Specifies a selector, using match expressions and match labels, to control which nodes can connect to the BGP peer. |
| spec.ebgpMultiHop | boolean | Optional: Specifies that the BGP peer is multiple network hops away. If the BGP peer is not directly connected to the same network, the speaker cannot establish a BGP session unless this field is set to true . This field applies to <i>external BGP</i> . External BGP is the term that is used to describe when a BGP peer belongs to a different Autonomous System. |



NOTE

The **passwordSecret** field is mutually exclusive with the **password** field, and contains a reference to a secret containing the password to use. Setting both fields results in a failure of the parsing.

36.6.2. Configuring a BGP peer

As a cluster administrator, you can add a BGP peer custom resource to exchange routing information with network routers and advertise the IP addresses for services.

Prerequisites

- Install the OpenShift CLI (**oc**).
- Log in as a user with **cluster-admin** privileges.
- Configure MetalLB with a BGP advertisement.

Procedure

1. Create a file, such as **bgppeer.yaml**, with content like the following example:

```
apiVersion: metallb.io/v1beta2
kind: BGPPeer
metadata:
  namespace: metallb-system
  name: doc-example-peer
spec:
  peerAddress: 10.0.0.1
  peerASN: 64501
  myASN: 64500
  routerID: 10.10.10.10
```

2. Apply the configuration for the BGP peer:

```
$ oc apply -f bgppeer.yaml
```

36.6.3. Configure a specific set of BGP peers for a given address pool

This procedure illustrates how to:

- Configure a set of address pools (**pool1** and **pool2**).
- Configure a set of BGP peers (**peer1** and **peer2**).
- Configure BGP advertisement to assign **pool1** to **peer1** and **pool2** to **peer2**.

Prerequisites

- Install the OpenShift CLI (**oc**).
- Log in as a user with **cluster-admin** privileges.

Procedure

1. Create address pool **pool1**.

- a. Create a file, such as **ipaddresspool1.yaml**, with content like the following example:

```
apiVersion: metallb.io/v1beta1
kind: IPAddressPool
metadata:
  namespace: metallb-system
  name: pool1
spec:
  addresses:
    - 4.4.4.100-4.4.4.200
    - 2001:100:4::200-2001:100:4::400
```

- b. Apply the configuration for the IP address pool **pool1**:

```
$ oc apply -f ipaddresspool1.yaml
```

2. Create address pool **pool2**.

- a. Create a file, such as **ipaddresspool2.yaml**, with content like the following example:

```
apiVersion: metallb.io/v1beta1
kind: IPAddressPool
metadata:
  namespace: metallb-system
  name: pool2
spec:
  addresses:
    - 5.5.5.100-5.5.5.200
    - 2001:100:5::200-2001:100:5::400
```

- b. Apply the configuration for the IP address pool **pool2**:

```
$ oc apply -f ipaddresspool2.yaml
```

3. Create BGP **peer1**.

- a. Create a file, such as **bgppeer1.yaml**, with content like the following example:

```
apiVersion: metallb.io/v1beta2
kind: BGPPeer
metadata:
  namespace: metallb-system
  name: peer1
spec:
  peerAddress: 10.0.0.1
  peerASN: 64501
  myASN: 64500
  routerID: 10.10.10.10
```

- b. Apply the configuration for the BGP peer:

```
$ oc apply -f bgppeer1.yaml
```

4. Create BGP **peer2**.

- a. Create a file, such as **bgppeer2.yaml**, with content like the following example:

```
apiVersion: metallb.io/v1beta2
kind: BGPPeer
metadata:
  namespace: metallb-system
  name: peer2
spec:
  peerAddress: 10.0.0.2
  peerASN: 64501
  myASN: 64500
  routerID: 10.10.10.10
```

- b. Apply the configuration for the BGP peer2:

```
$ oc apply -f bgppeer2.yaml
```

5. Create BGP advertisement 1.

- a. Create a file, such as **bgpadvertisement1.yaml**, with content like the following example:

```
apiVersion: metallb.io/v1beta1
kind: BGPAdvertisement
metadata:
  name: bgpadvertisement-1
  namespace: metallb-system
spec:
  ipAddressPools:
    - pool1
  peers:
    - peer1
  communities:
    - 65535:65282
  aggregationLength: 32
  aggregationLengthV6: 128
  localPref: 100
```

- b. Apply the configuration:

```
$ oc apply -f bgpadvertisement1.yaml
```

6. Create BGP advertisement 2.

- a. Create a file, such as **bgpadvertisement2.yaml**, with content like the following example:

```
apiVersion: metallb.io/v1beta1
kind: BGPAdvertisement
metadata:
  name: bgpadvertisement-2
  namespace: metallb-system
spec:
  ipAddressPools:
    - pool2
  peers:
    - peer2
  communities:
    - 65535:65282
  aggregationLength: 32
  aggregationLengthV6: 128
  localPref: 100
```

- b. Apply the configuration:

```
$ oc apply -f bgpadvertisement2.yaml
```

36.6.4. Exposing a service through a network VRF

You can expose a service through a virtual routing and forwarding (VRF) instance by associating a VRF on a network interface with a BGP peer.

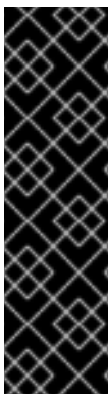

IMPORTANT

Exposing a service through a VRF on a BGP peer is a Technology Preview feature only. Technology Preview features are not supported with Red Hat production service level agreements (SLAs) and might not be functionally complete. Red Hat does not recommend using them in production. These features provide early access to upcoming product features, enabling customers to test functionality and provide feedback during the development process.

For more information about the support scope of Red Hat Technology Preview features, see [Technology Preview Features Support Scope](#).

By using a VRF on a network interface to expose a service through a BGP peer, you can segregate traffic to the service, configure independent routing decisions, and enable multi-tenancy support on a network interface.

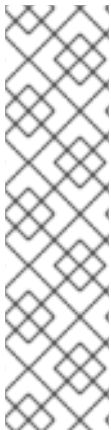

NOTE

By establishing a BGP session through an interface belonging to a network VRF, MetalLB can advertise services through that interface and enable external traffic to reach the service through this interface. However, the network VRF routing table is different from the default VRF routing table used by OVN-Kubernetes. Therefore, the traffic cannot reach the OVN-Kubernetes network infrastructure.

To enable the traffic directed to the service to reach the OVN-Kubernetes network infrastructure, you must configure routing rules to define the next hops for network traffic. See the **NodeNetworkConfigurationPolicy** resource in "Managing symmetric routing with MetalLB" in the *Additional resources* section for more information.

These are the high-level steps to expose a service through a network VRF with a BGP peer:

1. Define a BGP peer and add a network VRF instance.
2. Specify an IP address pool for MetalLB.
3. Configure a BGP route advertisement for MetalLB to advertise a route using the specified IP address pool and the BGP peer associated with the VRF instance.
4. Deploy a service to test the configuration.

Prerequisites

- You installed the OpenShift CLI (**oc**).
- You logged in as a user with **cluster-admin** privileges.
- You defined a **NodeNetworkConfigurationPolicy** to associate a Virtual Routing and Forwarding (VRF) instance with a network interface. For more information about completing this prerequisite, see the *Additional resources* section.
- You installed MetalLB on your cluster.

Procedure

1. Create a **BGPPeer** custom resources (CR):
 - a. Create a file, such as **frrviavrf.yaml**, with content like the following example:

```
apiVersion: metallb.io/v1beta2
kind: BGPPeer
metadata:
  name: frrviavrf
  namespace: metallb-system
spec:
  myASN: 100
  peerASN: 200
  peerAddress: 192.168.130.1
  vrf: ens4vrf 1
```

- 1** Specifies the network VRF instance to associate with the BGP peer. MetalLB can advertise services and make routing decisions based on the routing information in the VRF.

**NOTE**

You must configure this network VRF instance in a **NodeNetworkConfigurationPolicy** CR. See the *Additional resources* for more information.

- b. Apply the configuration for the BGP peer by running the following command:

```
$ oc apply -f frriavrf.yaml
```

2. Create an **IPAddressPool** CR:

- a. Create a file, such as **first-pool.yaml**, with content like the following example:

```
apiVersion: metallb.io/v1beta1
kind: IPAddressPool
metadata:
  name: first-pool
  namespace: metallb-system
spec:
  addresses:
  - 192.169.10.0/32
```

- b. Apply the configuration for the IP address pool by running the following command:

```
$ oc apply -f first-pool.yaml
```

3. Create a **BGPAdvertisement** CR:

- a. Create a file, such as **first-adv.yaml**, with content like the following example:

```
apiVersion: metallb.io/v1beta1
kind: BGPAdvertisement
metadata:
  name: first-adv
  namespace: metallb-system
spec:
  ipAddressPools:
  - first-pool
  peers:
  - frriavrf 1
```

- 1** In this example, MetalLB advertises a range of IP addresses from the **first-pool** IP address pool to the **frriavrf** BGP peer.

- b. Apply the configuration for the BGP advertisement by running the following command:

```
$ oc apply -f first-adv.yaml
```

4. Create a **Namespace**, **Deployment**, and **Service** CR:

- a. Create a file, such as **deploy-service.yaml**, with content like the following example:

```

apiVersion: v1
kind: Namespace
metadata:
  name: test
---
apiVersion: apps/v1
kind: Deployment
metadata:
  name: server
  namespace: test
spec:
  selector:
    matchLabels:
      app: server
  template:
    metadata:
      labels:
        app: server
    spec:
      containers:
        - name: server
          image: registry.redhat.io/ubi9/ubi
          ports:
            - name: http
              containerPort: 30100
          command: ["/bin/sh", "-c"]
          args: ["sleep INF"]
---
apiVersion: v1
kind: Service
metadata:
  name: server1
  namespace: test
spec:
  ports:
    - name: http
      port: 30100
      protocol: TCP
      targetPort: 30100
  selector:
    app: server
  type: LoadBalancer

```

- b. Apply the configuration for the namespace, deployment, and service by running the following command:

```
$ oc apply -f deploy-service.yaml
```

Verification

1. Identify a MetalLB speaker pod by running the following command:

```
$ oc get -n metallb-system pods -l component=speaker
```

Example output

```
NAME          READY STATUS  RESTARTS  AGE
speaker-c6c5f 6/6   Running  0         69m
```

2. Verify that the state of the BGP session is **Established** in the speaker pod by running the following command, replacing the variables to match your configuration:

```
$ oc exec -n metallb-system <speaker_pod> -c frf -- vtysh -c "show bgp vrf <vrf_name> neigh"
```

Example output

```
BGP neighbor is 192.168.30.1, remote AS 200, local AS 100, external link
BGP version 4, remote router ID 192.168.30.1, local router ID 192.168.30.71
BGP state = Established, up for 04:20:09
...

```

3. Verify that the service is advertised correctly by running the following command:

```
$ oc exec -n metallb-system <speaker_pod> -c frf -- vtysh -c "show bgp vrf <vrf_name> ipv4"
```

Additional resources

- [About virtual routing and forwarding](#)
- [Example: Network interface with a VRF instance node network configuration policy](#)
- [Configuring an egress service](#)
- [Managing symmetric routing with MetalLB](#)

36.6.5. Example BGP peer configurations

36.6.5.1. Example: Limit which nodes connect to a BGP peer

You can specify the node selectors field to control which nodes can connect to a BGP peer.

```
apiVersion: metallb.io/v1beta2
kind: BGPPeer
metadata:
  name: doc-example-nodesel
  namespace: metallb-system
spec:
  peerAddress: 10.0.20.1
  peerASN: 64501
  myASN: 64500
  nodeSelectors:
  - matchExpressions:
    - key: kubernetes.io/hostname
      operator: In
      values: [compute-1.example.com, compute-2.example.com]
```

36.6.5.2. Example: Specify a BFD profile for a BGP peer

You can specify a BFD profile to associate with BGP peers. BFD compliments BGP by providing more rapid detection of communication failures between peers than BGP alone.

```
apiVersion: metallb.io/v1beta2
kind: BGPPeer
metadata:
  name: doc-example-peer-bfd
  namespace: metallb-system
spec:
  peerAddress: 10.0.20.1
  peerASN: 64501
  myASN: 64500
  holdTime: "10s"
  bfdProfile: doc-example-bfd-profile-full
```



NOTE

Deleting the bidirectional forwarding detection (BFD) profile and removing the **bfdProfile** added to the border gateway protocol (BGP) peer resource does not disable the BFD. Instead, the BGP peer starts using the default BFD profile. To disable BFD from a BGP peer resource, delete the BGP peer configuration and recreate it without a BFD profile. For more information, see [BZ#2050824](#).

36.6.5.3. Example: Specify BGP peers for dual-stack networking

To support dual-stack networking, add one BGP peer custom resource for IPv4 and one BGP peer custom resource for IPv6.

```
apiVersion: metallb.io/v1beta2
kind: BGPPeer
metadata:
  name: doc-example-dual-stack-ipv4
  namespace: metallb-system
spec:
  peerAddress: 10.0.20.1
  peerASN: 64500
  myASN: 64500
---
apiVersion: metallb.io/v1beta2
kind: BGPPeer
metadata:
  name: doc-example-dual-stack-ipv6
  namespace: metallb-system
spec:
  peerAddress: 2620:52:0:88::104
  peerASN: 64500
  myASN: 64500
```

36.6.6. Next steps

- [Configuring services to use MetalLB](#)

36.7. CONFIGURING COMMUNITY ALIAS

As a cluster administrator, you can configure a community alias and use it across different advertisements.

36.7.1. About the community custom resource

The **community** custom resource is a collection of aliases for communities. Users can define named aliases to be used when advertising **ipAddressPools** using the **BGPAdvertisement**. The fields for the **community** custom resource are described in the following table.



NOTE

The **community** CRD applies only to BGPAdvertisement.

Table 36.6. MetalLB community custom resource

| Field | Type | Description |
|----------------------------|---------------|--|
| metadata.name | string | Specifies the name for the community . |
| metadata.name space | string | Specifies the namespace for the community . Specify the same namespace that the MetalLB Operator uses. |
| spec.communities | string | Specifies a list of BGP community aliases that can be used in BGPAdvertisements. A community alias consists of a pair of name (alias) and value (number:number). Link the BGPAdvertisement to a community alias by referring to the alias name in its spec.communities field. |

Table 36.7. CommunityAlias

| Field | Type | Description |
|--------------|---------------|---|
| name | string | The name of the alias for the community . |
| value | string | The BGP community value corresponding to the given name. |

36.7.2. Configuring MetalLB with a BGP advertisement and community alias

Configure MetalLB as follows so that the **IPAddressPool** is advertised with the BGP protocol and the community alias set to the numeric value of the **NO_ADVERTISE** community.

In the following example, the peer BGP router **doc-example-peer-community** receives one **203.0.113.200/32** route and one **fc00:f853:ccd:e799::1/128** route for each load-balancer IP address that MetalLB assigns to a service. A community alias is configured with the **NO_ADVERTISE** community.

Prerequisites

- Install the OpenShift CLI (**oc**).
- Log in as a user with **cluster-admin** privileges.

Procedure

1. Create an IP address pool.

- a. Create a file, such as **ipaddresspool.yaml**, with content like the following example:

```
apiVersion: metallb.io/v1beta1
kind: IPAddressPool
metadata:
  namespace: metallb-system
  name: doc-example-bgp-community
spec:
  addresses:
    - 203.0.113.200/30
    - fc00:f853:ccd:e799::/124
```

- b. Apply the configuration for the IP address pool:

```
$ oc apply -f ipaddresspool.yaml
```

2. Create a community alias named **community1**.

```
apiVersion: metallb.io/v1beta1
kind: Community
metadata:
  name: community1
  namespace: metallb-system
spec:
  communities:
    - name: NO_ADVERTISE
      value: '65535:65282'
```

3. Create a BGP peer named **doc-example-bgp-peer**.

- a. Create a file, such as **bgppeer.yaml**, with content like the following example:

```
apiVersion: metallb.io/v1beta2
kind: BGPPeer
metadata:
  namespace: metallb-system
  name: doc-example-bgp-peer
spec:
  peerAddress: 10.0.0.1
  peerASN: 64501
  myASN: 64500
  routerID: 10.10.10.10
```

- b. Apply the configuration for the BGP peer:

```
$ oc apply -f bgppeer.yaml
```

4. Create a BGP advertisement with the community alias.

a. Create a file, such as **bgpadvertisement.yaml**, with content like the following example:

```
apiVersion: metallb.io/v1beta1
kind: BGPAdvertisement
metadata:
  name: bgp-community-sample
  namespace: metallb-system
spec:
  aggregationLength: 32
  aggregationLengthV6: 128
  communities:
    - NO_ADVERTISE 1
  ipAddressPools:
    - doc-example-bgp-community
  peers:
    - doc-example-peer
```

1 Specify the **CommunityAlias.name** here and not the community custom resource (CR) name.

b. Apply the configuration:

```
$ oc apply -f bgpadvertisement.yaml
```

36.8. CONFIGURING METALLB BFD PROFILES

As a cluster administrator, you can add, modify, and delete Bidirectional Forwarding Detection (BFD) profiles. The MetalLB Operator uses the BFD profile custom resources to identify which BGP sessions use BFD to provide faster path failure detection than BGP alone provides.

36.8.1. About the BFD profile custom resource

The fields for the BFD profile custom resource are described in the following table.

Table 36.8. BFD profile custom resource

| Field | Type | Description |
|----------------------------|---------------|--|
| metadata.name | string | Specifies the name for the BFD profile custom resource. |
| metadata.name space | string | Specifies the namespace for the BFD profile custom resource. |

| Field | Type | Description |
|------------------------------|----------------|--|
| spec.detectMultiplier | integer | <p>Specifies the detection multiplier to determine packet loss. The remote transmission interval is multiplied by this value to determine the connection loss detection timer.</p> <p>For example, when the local system has the detect multiplier set to 3 and the remote system has the transmission interval set to 300, the local system detects failures only after 900 ms without receiving packets.</p> <p>The range is 2 to 255. The default value is 3.</p> |
| spec.echoMode | boolean | <p>Specifies the echo transmission mode. If you are not using distributed BFD, echo transmission mode works only when the peer is also FRR. The default value is false and echo transmission mode is disabled.</p> <p>When echo transmission mode is enabled, consider increasing the transmission interval of control packets to reduce bandwidth usage. For example, consider increasing the transmit interval to 2000 ms.</p> |
| spec.echoInterval | integer | <p>Specifies the minimum transmission interval, less jitter, that this system uses to send and receive echo packets. The range is 10 to 60000. The default value is 50 ms.</p> |
| spec.minimumTtl | integer | <p>Specifies the minimum expected TTL for an incoming control packet. This field applies to multi-hop sessions only.</p> <p>The purpose of setting a minimum TTL is to make the packet validation requirements more stringent and avoid receiving control packets from other sessions.</p> <p>The default value is 254 and indicates that the system expects only one hop between this system and the peer.</p> |
| spec.passiveMode | boolean | <p>Specifies whether a session is marked as active or passive. A passive session does not attempt to start the connection. Instead, a passive session waits for control packets from a peer before it begins to reply.</p> <p>Marking a session as passive is useful when you have a router that acts as the central node of a star network and you want to avoid sending control packets that you do not need the system to send.</p> <p>The default value is false and marks the session as active.</p> |
| spec.receiveInterval | integer | <p>Specifies the minimum interval that this system is capable of receiving control packets. The range is 10 to 60000. The default value is 300 ms.</p> |

| Field | Type | Description |
|------------------------------|----------------|---|
| spec.transmitInterval | integer | Specifies the minimum transmission interval, less jitter, that this system uses to send control packets. The range is 10 to 60000 . The default value is 300 ms. |

36.8.2. Configuring a BFD profile

As a cluster administrator, you can add a BFD profile and configure a BGP peer to use the profile. BFD provides faster path failure detection than BGP alone.

Prerequisites

- Install the OpenShift CLI (**oc**).
- Log in as a user with **cluster-admin** privileges.

Procedure

1. Create a file, such as **bfdprofile.yaml**, with content like the following example:

```
apiVersion: metallb.io/v1beta1
kind: BFDProfile
metadata:
  name: doc-example-bfd-profile-full
  namespace: metallb-system
spec:
  receiveInterval: 300
  transmitInterval: 300
  detectMultiplier: 3
  echoMode: false
  passiveMode: true
  minimumTtl: 254
```

2. Apply the configuration for the BFD profile:

```
$ oc apply -f bfdprofile.yaml
```

36.8.3. Next steps

- [Configure a BGP peer](#) to use the BFD profile.

36.9. CONFIGURING SERVICES TO USE METALLB

As a cluster administrator, when you add a service of type **LoadBalancer**, you can control how MetalLB assigns an IP address.

36.9.1. Request a specific IP address

Like some other load-balancer implementations, MetalLB accepts the **spec.loadBalancerIP** field in the service specification.

If the requested IP address is within a range from any address pool, MetalLB assigns the requested IP address. If the requested IP address is not within any range, MetalLB reports a warning.

Example service YAML for a specific IP address

```
apiVersion: v1
kind: Service
metadata:
  name: <service_name>
  annotations:
    metallb.universe.tf/address-pool: <address_pool_name>
spec:
  selector:
    <label_key>: <label_value>
  ports:
    - port: 8080
      targetPort: 8080
      protocol: TCP
  type: LoadBalancer
  loadBalancerIP: <ip_address>
```

If MetalLB cannot assign the requested IP address, the **EXTERNAL-IP** for the service reports **<pending>** and running **oc describe service <service_name>** includes an event like the following example.

Example event when MetalLB cannot assign a requested IP address

```
...
Events:
  Type    Reason          Age   From          Message
  ----    -
Warning AllocationFailed 3m16s metallb-controller Failed to allocate IP for "default/invalid-request": "4.3.2.1" is not allowed in config
```

36.9.2. Request an IP address from a specific pool

To assign an IP address from a specific range, but you are not concerned with the specific IP address, then you can use the **metallb.universe.tf/address-pool** annotation to request an IP address from the specified address pool.

Example service YAML for an IP address from a specific pool

```
apiVersion: v1
kind: Service
metadata:
  name: <service_name>
  annotations:
    metallb.universe.tf/address-pool: <address_pool_name>
spec:
  selector:
    <label_key>: <label_value>
  ports:
    - port: 8080
```

```
targetPort: 8080
protocol: TCP
type: LoadBalancer
```

If the address pool that you specify for **<address_pool_name>** does not exist, MetalLB attempts to assign an IP address from any pool that permits automatic assignment.

36.9.3. Accept any IP address

By default, address pools are configured to permit automatic assignment. MetalLB assigns an IP address from these address pools.

To accept any IP address from any pool that is configured for automatic assignment, no special annotation or configuration is required.

Example service YAML for accepting any IP address

```
apiVersion: v1
kind: Service
metadata:
  name: <service_name>
spec:
  selector:
    <label_key>: <label_value>
  ports:
    - port: 8080
      targetPort: 8080
      protocol: TCP
    type: LoadBalancer
```

36.9.4. Share a specific IP address

By default, services do not share IP addresses. However, if you need to colocate services on a single IP address, you can enable selective IP sharing by adding the **metallb.universe.tf/allow-shared-ip** annotation to the services.

```
apiVersion: v1
kind: Service
metadata:
  name: service-http
  annotations:
    metallb.universe.tf/address-pool: doc-example
    metallb.universe.tf/allow-shared-ip: "web-server-svc" 1
spec:
  ports:
    - name: http
      port: 80 2
      protocol: TCP
      targetPort: 8080
  selector:
    <label_key>: <label_value> 3
  type: LoadBalancer
  loadBalancerIP: 172.31.249.7 4
---
```

```

apiVersion: v1
kind: Service
metadata:
  name: service-https
  annotations:
    metallb.universe.tf/address-pool: doc-example
    metallb.universe.tf/allow-shared-ip: "web-server-svc"
spec:
  ports:
    - name: https
      port: 443
      protocol: TCP
      targetPort: 8080
  selector:
    <label_key>: <label_value>
  type: LoadBalancer
  loadBalancerIP: 172.31.249.7

```

- 1 Specify the same value for the **metallb.universe.tf/allow-shared-ip** annotation. This value is referred to as the *sharing key*.
- 2 Specify different port numbers for the services.
- 3 Specify identical pod selectors if you must specify **externalTrafficPolicy: local** so the services send traffic to the same set of pods. If you use the **cluster** external traffic policy, then the pod selectors do not need to be identical.
- 4 Optional: If you specify the three preceding items, MetalLB might colocate the services on the same IP address. To ensure that services share an IP address, specify the IP address to share.

By default, Kubernetes does not allow multiprotocol load balancer services. This limitation would normally make it impossible to run a service like DNS that needs to listen on both TCP and UDP. To work around this limitation of Kubernetes with MetalLB, create two services:

- For one service, specify TCP and for the second service, specify UDP.
- In both services, specify the same pod selector.
- Specify the same sharing key and **spec.loadBalancerIP** value to colocate the TCP and UDP services on the same IP address.

36.9.5. Configuring a service with MetalLB

You can configure a load-balancing service to use an external IP address from an address pool.

Prerequisites

- Install the OpenShift CLI (**oc**).
- Install the MetalLB Operator and start MetalLB.
- Configure at least one address pool.
- Configure your network to route traffic from the clients to the host network for the cluster.

Procedure

Procedure

1. Create a `<service_name>.yaml` file. In the file, ensure that the `spec.type` field is set to **LoadBalancer**.
Refer to the examples for information about how to request the external IP address that MetalLB assigns to the service.
2. Create the service:

```
$ oc apply -f <service_name>.yaml
```

Example output

```
service/<service_name> created
```

Verification

- Describe the service:

```
$ oc describe service <service_name>
```

Example output

```
Name:                <service_name>
Namespace:           default
Labels:              <none>
Annotations:         metallb.universe.tf/address-pool: doc-example 1
Selector:            app=service_name
Type:                LoadBalancer 2
IP Family Policy:    SingleStack
IP Families:         IPv4
IP:                  10.105.237.254
IPs:                 10.105.237.254
LoadBalancer Ingress: 192.168.100.5 3
Port:                <unset> 80/TCP
TargetPort:          8080/TCP
NodePort:            <unset> 30550/TCP
Endpoints:           10.244.0.50:8080
Session Affinity:    None
External Traffic Policy: Cluster
Events: 4
  Type    Reason      Age           From          Message
  ----    -
  Normal  nodeAssigned 32m (x2 over 32m) metallb-speaker announcing from node "
  <node_name>"
```

- 1** The annotation is present if you request an IP address from a specific pool.
- 2** The service type must indicate **LoadBalancer**.
- 3** The load-balancer ingress field indicates the external IP address if the service is assigned correctly.
- 4** The events field indicates the node name that is assigned to announce the external IP address. If you experience an error, the events field indicates the reason for the error.

address. If you experience an error, the events field indicates the reason for the error.

36.10. MANAGING SYMMETRIC ROUTING WITH METALLB

As a cluster administrator, you can effectively manage traffic for pods behind a MetalLB load-balancer service with multiple host interfaces by implementing features from MetalLB, NMState, and OVN-Kubernetes. By combining these features in this context, you can provide symmetric routing, traffic segregation, and support clients on different networks with overlapping CIDR addresses.

To achieve this functionality, learn how to implement virtual routing and forwarding (VRF) instances with MetalLB, and configure egress services.



IMPORTANT

Configuring symmetric traffic by using a VRF instance with MetalLB and an egress service is a Technology Preview feature only. Technology Preview features are not supported with Red Hat production service level agreements (SLAs) and might not be functionally complete. Red Hat does not recommend using them in production. These features provide early access to upcoming product features, enabling customers to test functionality and provide feedback during the development process.

For more information about the support scope of Red Hat Technology Preview features, see [Technology Preview Features Support Scope](#).

36.10.1. Challenges of managing symmetric routing with MetalLB

When you use MetalLB with multiple host interfaces, MetalLB exposes and announces a service through all available interfaces on the host. This can present challenges relating to network isolation, asymmetric return traffic and overlapping CIDR addresses.

One option to ensure that return traffic reaches the correct client is to use static routes. However, with this solution, MetalLB cannot isolate the services and then announce each service through a different interface. Additionally, static routing requires manual configuration and requires maintenance if remote sites are added.

A further challenge of symmetric routing when implementing a MetalLB service is scenarios where external systems expect the source and destination IP address for an application to be the same. The default behavior for OpenShift Container Platform is to assign the IP address of the host network interface as the source IP address for traffic originating from pods. This is problematic with multiple host interfaces.

You can overcome these challenges by implementing a configuration that combines features from MetalLB, NMState, and OVN-Kubernetes.

36.10.2. Overview of managing symmetric routing by using VRFs with MetalLB

You can overcome the challenges of implementing symmetric routing by using NMState to configure a VRF instance on a host, associating the VRF instance with a MetalLB **BGPPeer** resource, and configuring an egress service for egress traffic with OVN-Kubernetes.

Figure 36.2. Network overview of managing symmetric routing by using VRFs with MetalLB

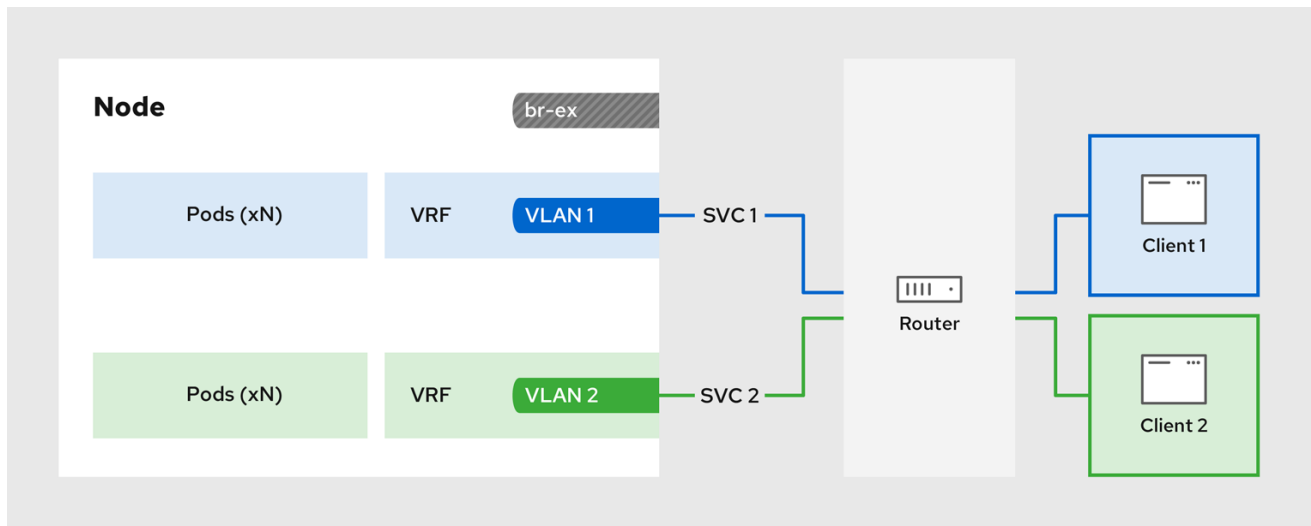

357_OpenShift_0823

The configuration process involves three stages:

1. Define a VRF and routing rules

- Configure a **NodeNetworkConfigurationPolicy** custom resource (CR) to associate a VRF instance with a network interface.
- Use the VRF routing table to direct ingress and egress traffic.

2. Link the VRF to a MetalLBGPPeer

- Configure a MetalLB **BGPPeer** resource to use the VRF instance on a network interface.
- By associating the **BGPPeer** resource with the VRF instance, the designated network interface becomes the primary interface for the BGP session, and MetalLB advertises the services through this interface.

3. Configure an egress service

- Configure an egress service to choose the network associated with the VRF instance for egress traffic.
- Optional: Configure an egress service to use the IP address of the MetalLB load-balancer service as the source IP for egress traffic.

36.10.3. Configuring symmetric routing by using VRFs with MetalLB

You can configure symmetric network routing for applications behind a MetalLB service that require the same ingress and egress network paths.

This example associates a VRF routing table with MetalLB and an egress service to enable symmetric routing for ingress and egress traffic for pods behind a **LoadBalancer** service.



NOTE

- If you use the **sourceIPBy: "LoadBalancerIP"** setting in the **EgressService** CR, you must specify the load-balancer node in the **BGPAdvertisement** custom resource (CR).
- You can use the **sourceIPBy: "Network"** setting on clusters that use OVN-Kubernetes configured with the **gatewayConfig.routingViaHost** specification set to **true** only. Additionally, if you use the **sourceIPBy: "Network"** setting, you must schedule the application workload on nodes configured with the network VRF instance.

Prerequisites

- Install the OpenShift CLI (**oc**).
- Log in as a user with **cluster-admin** privileges.

Procedure

1. Create a **NodeNetworkConfigurationPolicy** CR to define the VRF instance:
 - a. Create a file, such as **node-network-vrf.yaml**, with content like the following example:

```

apiVersion: nmstate.io/v1
kind: NodeNetworkConfigurationPolicy
metadata:
  name: vrfpolicy 1
spec:
  nodeSelector:
    vrf: "true" 2
  maxUnavailable: 3
  desiredState:
    interfaces:
      - name: ens4vrf 3
        type: vrf 4
        state: up
        vrf:
          port:
            - ens4 5
          route-table-id: 2 6
    routes: 7
      config:
        - destination: 0.0.0.0/0
          metric: 150
          next-hop-address: 192.168.130.1
          next-hop-interface: ens4
          table-id: 2
    route-rules: 8
      config:
        - ip-to: 172.30.0.0/16
          priority: 998
          route-table: 254

```

```
- ip-to: 10.132.0.0/14
  priority: 998
  route-table: 254
```

- 1 The name of the policy.
- 2 This example applies the policy to all nodes with the label **vrf:true**.
- 3 The name of the interface.
- 4 The type of interface. This example creates a VRF instance.
- 5 The node interface that the VRF attaches to.
- 6 The name of the route table ID for the VRF.
- 7 Defines the configuration for network routes. The **next-hop-address** field defines the IP address of the next hop for the route. The **next-hop-interface** field defines the outgoing interface for the route. In this example, the VRF routing table is **2**, which references the ID that you define in the **EgressService** CR.
- 8 Defines additional route rules. The **ip-to** fields must match the **Cluster Network** CIDR and **Service Network** CIDR. You can view the values for these CIDR address specifications by running the following command: **oc describe network.config/cluster**.

- b. Apply the policy by running the following command:

```
$ oc apply -f node-network-vrf.yaml
```

2. Create a **BGPPeer** custom resource (CR):

- a. Create a file, such as **frr-via-vrf.yaml**, with content like the following example:

```
apiVersion: metallb.io/v1beta2
kind: BGPPeer
metadata:
  name: frrviavrf
  namespace: metallb-system
spec:
  myASN: 100
  peerASN: 200
  peerAddress: 192.168.130.1
  vrf: ens4vrf 1
```

- 1 Specifies the VRF instance to associate with the BGP peer. MetalLB can advertise services and make routing decisions based on the routing information in the VRF.

- b. Apply the configuration for the BGP peer by running the following command:

```
$ oc apply -f frr-via-vrf.yaml
```

3. Create an **IPAddressPool** CR:

- a. Create a file, such as **first-pool.yaml**, with content like the following example:

- a. Create a file, such as **first-pool.yaml**, with content like the following example.

```
apiVersion: metallb.io/v1beta1
kind: IPAddressPool
metadata:
  name: first-pool
  namespace: metallb-system
spec:
  addresses:
  - 192.169.10.0/32
```

- b. Apply the configuration for the IP address pool by running the following command:

```
$ oc apply -f first-pool.yaml
```

4. Create a **BGPAdvertisement** CR:

- a. Create a file, such as **first-adv.yaml**, with content like the following example:

```
apiVersion: metallb.io/v1beta1
kind: BGPAdvertisement
metadata:
  name: first-adv
  namespace: metallb-system
spec:
  ipAddressPools:
  - first-pool
  peers:
  - frriavrf 1
  nodeSelectors:
  - matchLabels:
    egress-service.k8s.ovn.org/test-server1: "" 2
```

1 In this example, MetalLB advertises a range of IP addresses from the **first-pool** IP address pool to the **frriavrf** BGP peer.

2 In this example, the **EgressService** CR configures the source IP address for egress traffic to use the load-balancer service IP address. Therefore, you must specify the load-balancer node for return traffic to use the same return path for the traffic originating from the pod.

- b. Apply the configuration for the BGP advertisement by running the following command:

```
$ oc apply -f first-adv.yaml
```

5. Create an **EgressService** CR:

- a. Create a file, such as **egress-service.yaml**, with content like the following example:

```
apiVersion: k8s.ovn.org/v1
kind: EgressService
metadata:
  name: server1 1
  namespace: test 2
```

```
spec:
  sourceIPBy: "LoadBalancerIP" 3
  nodeSelector:
    matchLabels:
      vrf: "true" 4
  network: "2" 5
```

- 1 Specify the name for the egress service. The name of the **EgressService** resource must match the name of the load-balancer service that you want to modify.
- 2 Specify the namespace for the egress service. The namespace for the **EgressService** must match the namespace of the load-balancer service that you want to modify. The egress service is namespace-scoped.
- 3 This example assigns the **LoadBalancer** service ingress IP address as the source IP address for egress traffic.
- 4 If you specify **LoadBalancer** for the **sourceIPBy** specification, a single node handles the **LoadBalancer** service traffic. In this example, only a node with the label **vrf: "true"** can handle the service traffic. If you do not specify a node, OVN-Kubernetes selects a worker node to handle the service traffic. When a node is selected, OVN-Kubernetes labels the node in the following format: **egress-service.k8s.ovn.org/<svc_namespace>-<svc_name>: ""**.
- 5 Specify the routing table for egress traffic.

b. Apply the configuration for the egress service by running the following command:

```
$ oc apply -f egress-service.yaml
```

Verification

1. Verify that you can access the application endpoint of the pods running behind the MetalLB service by running the following command:

```
$ curl <external_ip_address>:<port_number> 1
```

- 1 Update the external IP address and port number to suit your application endpoint.
2. Optional: If you assigned the **LoadBalancer** service ingress IP address as the source IP address for egress traffic, verify this configuration by using tools such as **tcpdump** to analyze packets received at the external client.

Additional resources

- [About virtual routing and forwarding](#)
- [Exposing a service through a network VRF](#)
- [Example: Network interface with a VRF instance node network configuration policy](#)
- [Configuring an egress service](#)

36.11. METALLB LOGGING, TROUBLESHOOTING, AND SUPPORT

If you need to troubleshoot MetalLB configuration, see the following sections for commonly used commands.

36.11.1. Setting the MetalLB logging levels

MetalLB uses FRRouting (FRR) in a container with the default setting of **info** generates a lot of logging. You can control the verbosity of the logs generated by setting the **logLevel** as illustrated in this example.

Gain a deeper insight into MetalLB by setting the **logLevel** to **debug** as follows:

Prerequisites

- You have access to the cluster as a user with the **cluster-admin** role.
- You have installed the OpenShift CLI (**oc**).

Procedure

1. Create a file, such as **setdebugloglevel.yaml**, with content like the following example:

```
apiVersion: metallb.io/v1beta1
kind: MetalLB
metadata:
  name: metallb
  namespace: metallb-system
spec:
  logLevel: debug
  nodeSelector:
    node-role.kubernetes.io/worker: ""
```

2. Apply the configuration:

```
$ oc replace -f setdebugloglevel.yaml
```

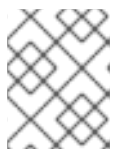

NOTE

Use **oc replace** as the understanding is the **metallb** CR is already created and here you are changing the log level.

3. Display the names of the **speaker** pods:

```
$ oc get -n metallb-system pods -l component=speaker
```

Example output

```
NAME                READY  STATUS   RESTARTS  AGE
speaker-2m9pm       4/4    Running  0          9m19s
speaker-7m4qw       3/4    Running  0          19s
speaker-szlmx       4/4    Running  0          9m19s
```

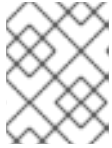
**NOTE**

Speaker and controller pods are recreated to ensure the updated logging level is applied. The logging level is modified for all the components of MetalLB.

4. View the **speaker** logs:

```
$ oc logs -n metallb-system speaker-7m4qw -c speaker
```

Example output

```
{ "branch": "main", "caller": "main.go:92", "commit": "3d052535", "goversion": "gc / go1.17.1 / amd64", "level": "info", "msg": "MetalLB speaker starting (commit 3d052535, branch main)", "ts": "2022-05-17T09:55:05Z", "version": "" }
{"caller": "announcer.go:110", "event": "createARPResponder", "interface": "ens4", "level": "info", "msg": "created ARP responder for interface", "ts": "2022-05-17T09:55:05Z"}
{"caller": "announcer.go:119", "event": "createNDPResponder", "interface": "ens4", "level": "info", "msg": "created NDP responder for interface", "ts": "2022-05-17T09:55:05Z"}
{"caller": "announcer.go:110", "event": "createARPResponder", "interface": "tun0", "level": "info", "msg": "created ARP responder for interface", "ts": "2022-05-17T09:55:05Z"}
{"caller": "announcer.go:119", "event": "createNDPResponder", "interface": "tun0", "level": "info", "msg": "created NDP responder for interface", "ts": "2022-05-17T09:55:05Z"}
I0517 09:55:06.515686 95 request.go:665] Waited for 1.026500832s due to client-side throttling, not priority and fairness, request:
GET:https://172.30.0.1:443/apis/operators.coreos.com/v1alpha1?timeout=32s
{"Starting Manager": "(MISSING)", "caller": "k8s.go:389", "level": "info", "ts": "2022-05-17T09:55:08Z"}
{"caller": "speakerlist.go:310", "level": "info", "msg": "node event - forcing sync", "node addr": "10.0.128.4", "node event": "NodeJoin", "node name": "ci-ln-qb8t3mb-72292-7s7rh-worker-a-vvznj", "ts": "2022-05-17T09:55:08Z"}
{"caller": "service_controller.go:113", "controller": "ServiceReconciler", "enqueueing": "openshift-kube-controller-manager-operator/metrics", "epslice": "{\"metadata\":{\"name\":\"metrics-xtsxr\",\"generateName\":\"metrics-\",\"namespace\":\"openshift-kube-controller-manager-operator\",\"uid\":\"ac6766d7-8504-492c-9d1e-4ae8897990ad\",\"resourceVersion\":\"9041\",\"generation\":4,\"creationTimestamp\":\"2022-05-17T07:16:53Z\",\"labels\":{\"app\":\"kube-controller-manager-operator\"},\"endpointslice.kubernetes.io/managed-by\":\"endpointslice-controller.k8s.io\",\"kubernetes.io/service-name\":\"metrics\"},\"annotations\":{\"endpoints.kubernetes.io/last-change-trigger-time\":\"2022-05-17T07:21:34Z\"},\"ownerReferences\": [{\"apiVersion\":\"v1\",\"kind\":\"Service\",\"name\":\"metrics\",\"uid\":\"0518eed3-6152-42be-b566-0bd00a60faf8\",\"controller\":true,\"blockOwnerDeletion\":true}],\"managedFields\": [{\"manager\":\"kube-controller-manager\",\"operation\":\"Update\",\"apiVersion\":\"discovery.k8s.io/v1\",\"time\":\"2022-05-17T07:20:02Z\",\"fieldsType\":\"FieldsV1\",\"fieldsV1\":{\"f:addressType\":{\"\":{}},\"f:endpoints\":{\"\":{}},\"f:metadata\":{\"f:annotations\":{\"\":{}},\"f:endpoints.kubernetes.io/last-change-trigger-time\":{\"\":{}},\"f:generateName\":{\"\":{}},\"f:labels\":{\"\":{}},\"f:app\":{\"\":{}},\"f:endpointslice.kubernetes.io/managed-by\":{\"\":{}},\"f:kubernetes.io/service-name\":{\"\":{}},\"f:ownerReferences\":{\"\":{}},\"k:{\\\"uid\\\":\\\"0518eed3-6152-42be-b566-0bd00a60faf8\\\"}\":{\"\":{}},\"f:ports\":{\"\":{}},\"addressType\":\"IPv4\",\"endpoints\":{\"addresses\":[\"10.129.0.7\"],\"conditions\":{\"ready\":true,\"serving\":true,\"terminating\":false},\"targetRef\":{\"kind\":\"Pod\",\"namespace\":\"openshift-kube-controller-manager-operator\",\"name\":\"kube-controller-manager-operator-6b98b89ddd-8d4nf\",\"uid\":\"dd5139b8-e41c-4946-a31b-1a629314e844\",\"resourceVersion\":\"9038\"},\"nodeName\":\"ci-ln-qb8t3mb-72292-7s7rh-
```

```
master-0\", \"zone\": \"us-central1-a\"}], \"ports\":  
[ { \"name\": \"https\", \"protocol\": \"TCP\", \"port\": 8443 } ], \"level\": \"debug\", \"ts\": \"2022-05-  
17T09:55:08Z\" }
```

- View the FRR logs:

```
$ oc logs -n metallb-system speaker-7m4qw -c frr
```

Example output

```
Started watchfrr  
2022/05/17 09:55:05 ZEBRA: client 16 says hello and bids fair to announce only bgp routes  
vrf=0  
2022/05/17 09:55:05 ZEBRA: client 31 says hello and bids fair to announce only vnc routes  
vrf=0  
2022/05/17 09:55:05 ZEBRA: client 38 says hello and bids fair to announce only static routes  
vrf=0  
2022/05/17 09:55:05 ZEBRA: client 43 says hello and bids fair to announce only bfd routes  
vrf=0  
2022/05/17 09:57:25.089 BGP: Creating Default VRF, AS 64500  
2022/05/17 09:57:25.090 BGP: dup addr detect enable max_moves 5 time 180 freeze  
disable freeze_time 0  
2022/05/17 09:57:25.090 BGP: bgp_get: Registering BGP instance (null) to zebra  
2022/05/17 09:57:25.090 BGP: Registering VRF 0  
2022/05/17 09:57:25.091 BGP: Rx Router Id update VRF 0 Id 10.131.0.1/32  
2022/05/17 09:57:25.091 BGP: RID change : vrf VRF default(0), RTR ID 10.131.0.1  
2022/05/17 09:57:25.091 BGP: Rx Intf add VRF 0 IF br0  
2022/05/17 09:57:25.091 BGP: Rx Intf add VRF 0 IF ens4  
2022/05/17 09:57:25.091 BGP: Rx Intf address add VRF 0 IF ens4 addr 10.0.128.4/32  
2022/05/17 09:57:25.091 BGP: Rx Intf address add VRF 0 IF ens4 addr  
fe80::c9d:84da:4d86:5618/64  
2022/05/17 09:57:25.091 BGP: Rx Intf add VRF 0 IF lo  
2022/05/17 09:57:25.091 BGP: Rx Intf add VRF 0 IF ovs-system  
2022/05/17 09:57:25.091 BGP: Rx Intf add VRF 0 IF tun0  
2022/05/17 09:57:25.091 BGP: Rx Intf address add VRF 0 IF tun0 addr 10.131.0.1/23  
2022/05/17 09:57:25.091 BGP: Rx Intf address add VRF 0 IF tun0 addr  
fe80::40f1:d1ff:feb6:5322/64  
2022/05/17 09:57:25.091 BGP: Rx Intf add VRF 0 IF veth2da49fed  
2022/05/17 09:57:25.091 BGP: Rx Intf address add VRF 0 IF veth2da49fed addr  
fe80::24bd:d1ff:fec1:d88/64  
2022/05/17 09:57:25.091 BGP: Rx Intf add VRF 0 IF veth2fa08c8c  
2022/05/17 09:57:25.091 BGP: Rx Intf address add VRF 0 IF veth2fa08c8c addr  
fe80::6870:ff:fe96:efc8/64  
2022/05/17 09:57:25.091 BGP: Rx Intf add VRF 0 IF veth41e356b7  
2022/05/17 09:57:25.091 BGP: Rx Intf address add VRF 0 IF veth41e356b7 addr  
fe80::48ff:37ff:fede:eb4b/64  
2022/05/17 09:57:25.092 BGP: Rx Intf add VRF 0 IF veth1295c6e2  
2022/05/17 09:57:25.092 BGP: Rx Intf address add VRF 0 IF veth1295c6e2 addr  
fe80::b827:a2ff:feed:637/64  
2022/05/17 09:57:25.092 BGP: Rx Intf add VRF 0 IF veth9733c6dc  
2022/05/17 09:57:25.092 BGP: Rx Intf address add VRF 0 IF veth9733c6dc addr  
fe80::3cf4:15ff:fe11:e541/64  
2022/05/17 09:57:25.092 BGP: Rx Intf add VRF 0 IF veth336680ea  
2022/05/17 09:57:25.092 BGP: Rx Intf address add VRF 0 IF veth336680ea addr  
fe80::94b1:8bff:fe7e:488c/64
```

```

2022/05/17 09:57:25.092 BGP: Rx Intf add VRF 0 IF vetha0a907b7
2022/05/17 09:57:25.092 BGP: Rx Intf address add VRF 0 IF vetha0a907b7 addr
fe80::3855:a6ff:fe73:46c3/64
2022/05/17 09:57:25.092 BGP: Rx Intf add VRF 0 IF vethf35a4398
2022/05/17 09:57:25.092 BGP: Rx Intf address add VRF 0 IF vethf35a4398 addr
fe80::40ef:2fff:fe57:4c4d/64
2022/05/17 09:57:25.092 BGP: Rx Intf add VRF 0 IF vethf831b7f4
2022/05/17 09:57:25.092 BGP: Rx Intf address add VRF 0 IF vethf831b7f4 addr
fe80::f0d9:89ff:fe7c:1d32/64
2022/05/17 09:57:25.092 BGP: Rx Intf add VRF 0 IF vxlan_sys_4789
2022/05/17 09:57:25.092 BGP: Rx Intf address add VRF 0 IF vxlan_sys_4789 addr
fe80::80c1:82ff:fe4b:f078/64
2022/05/17 09:57:26.094 BGP: 10.0.0.1 [FSM] Timer (start timer expire).
2022/05/17 09:57:26.094 BGP: 10.0.0.1 [FSM] BGP_Start (Idle->Connect), fd -1
2022/05/17 09:57:26.094 BGP: Allocated bnc 10.0.0.1/32(0)(VRF default) peer
0x7f807f7631a0
2022/05/17 09:57:26.094 BGP: sendmsg_zebra_rnh: sending cmd
ZEBRA_NEXTHOP_REGISTER for 10.0.0.1/32 (vrf VRF default)
2022/05/17 09:57:26.094 BGP: 10.0.0.1 [FSM] Waiting for NHT
2022/05/17 09:57:26.094 BGP: bgp_fsm_change_status : vrf default(0), Status: Connect
established_peers 0
2022/05/17 09:57:26.094 BGP: 10.0.0.1 went from Idle to Connect
2022/05/17 09:57:26.094 BGP: 10.0.0.1 [FSM] TCP_connection_open_failed (Connect-
>Active), fd -1
2022/05/17 09:57:26.094 BGP: bgp_fsm_change_status : vrf default(0), Status: Active
established_peers 0
2022/05/17 09:57:26.094 BGP: 10.0.0.1 went from Connect to Active
2022/05/17 09:57:26.094 ZEBRA: rnh_register msg from client bgp: hdr->length=8,
type=nexthop vrf=0
2022/05/17 09:57:26.094 ZEBRA: 0: Add RNH 10.0.0.1/32 type Nexthop
2022/05/17 09:57:26.094 ZEBRA: 0:10.0.0.1/32: Evaluate RNH, type Nexthop (force)
2022/05/17 09:57:26.094 ZEBRA: 0:10.0.0.1/32: NH has become unresolved
2022/05/17 09:57:26.094 ZEBRA: 0: Client bgp registers for RNH 10.0.0.1/32 type Nexthop
2022/05/17 09:57:26.094 BGP: VRF default(0): Rcvd NH update 10.0.0.1/32(0) - metric 0/0
#nhops 0/0 flags 0x6
2022/05/17 09:57:26.094 BGP: NH update for 10.0.0.1/32(0)(VRF default) - flags 0x6
chgflags 0x0 - evaluate paths
2022/05/17 09:57:26.094 BGP: evaluate_paths: Updating peer (10.0.0.1(VRF default)) status
with NHT
2022/05/17 09:57:30.081 ZEBRA: Event driven route-map update triggered
2022/05/17 09:57:30.081 ZEBRA: Event handler for route-map: 10.0.0.1-out
2022/05/17 09:57:30.081 ZEBRA: Event handler for route-map: 10.0.0.1-in
2022/05/17 09:57:31.104 ZEBRA: netlink_parse_info: netlink-listen (NS 0) type
RTM_NEWNEIGH(28), len=76, seq=0, pid=0
2022/05/17 09:57:31.104 ZEBRA: Neighbor Entry received is not on a VLAN or a BRIDGE,
ignoring
2022/05/17 09:57:31.105 ZEBRA: netlink_parse_info: netlink-listen (NS 0) type
RTM_NEWNEIGH(28), len=76, seq=0, pid=0
2022/05/17 09:57:31.105 ZEBRA: Neighbor Entry received is not on a VLAN or a BRIDGE,
ignoring

```

36.11.1.1. FRRouting (FRR) log levels

The following table describes the FRR logging levels.

Table 36.9. Log levels

| Log level | Description |
|--------------|---|
| all | Supplies all logging information for all logging levels. |
| debug | Information that is diagnostically helpful to people. Set to debug to give detailed troubleshooting information. |
| info | Provides information that always should be logged but under normal circumstances does not require user intervention. This is the default logging level. |
| warn | Anything that can potentially cause inconsistent MetalLB behaviour. Usually MetalLB automatically recovers from this type of error. |
| error | Any error that is fatal to the functioning of MetalLB . These errors usually require administrator intervention to fix. |
| none | Turn off all logging. |

36.11.2. Troubleshooting BGP issues

The BGP implementation that Red Hat supports uses FRRouting (FRR) in a container in the **speaker** pods. As a cluster administrator, if you need to troubleshoot BGP configuration issues, you need to run commands in the FRR container.

Prerequisites

- You have access to the cluster as a user with the **cluster-admin** role.
- You have installed the OpenShift CLI (**oc**).

Procedure

1. Display the names of the **speaker** pods:

```
$ oc get -n metallb-system pods -l component=speaker
```

Example output

```
NAME          READY STATUS  RESTARTS  AGE
speaker-66bth 4/4   Running  0          56m
speaker-gvfnf 4/4   Running  0          56m
...
```

2. Display the running configuration for FRR:

```
$ oc exec -n metallb-system speaker-66bth -c frf -- vtysh -c "show running-config"
```

Example output

Building configuration...

Current configuration:

```
!  
frf version 7.5.1_git  
frf defaults traditional  
hostname some-hostname  
log file /etc/frf/frf.log informational  
log timestamp precision 3  
service integrated-vtysh-config  
!  
router bgp 64500 ①  
  bgp router-id 10.0.1.2  
  no bgp ebgp-requires-policy  
  no bgp default ipv4-unicast  
  no bgp network import-check  
  neighbor 10.0.2.3 remote-as 64500 ②  
  neighbor 10.0.2.3 bfd profile doc-example-bfd-profile-full ③  
  neighbor 10.0.2.3 timers 5 15  
  neighbor 10.0.2.4 remote-as 64500  
  neighbor 10.0.2.4 bfd profile doc-example-bfd-profile-full  
  neighbor 10.0.2.4 timers 5 15  
  !  
  address-family ipv4 unicast  
    network 203.0.113.200/30 ④  
    neighbor 10.0.2.3 activate  
    neighbor 10.0.2.3 route-map 10.0.2.3-in in  
    neighbor 10.0.2.4 activate  
    neighbor 10.0.2.4 route-map 10.0.2.4-in in  
  exit-address-family  
  !  
  address-family ipv6 unicast  
    network fc00:f853:ccd:e799::/124  
    neighbor 10.0.2.3 activate  
    neighbor 10.0.2.3 route-map 10.0.2.3-in in  
    neighbor 10.0.2.4 activate  
    neighbor 10.0.2.4 route-map 10.0.2.4-in in  
  exit-address-family  
  !  
  route-map 10.0.2.3-in deny 20  
  !  
  route-map 10.0.2.4-in deny 20  
  !  
  ip nht resolve-via-default  
  !  
  ipv6 nht resolve-via-default  
  !  
  line vty  
  !  
  bfd  
    profile doc-example-bfd-profile-full  
    transmit-interval 35  
    receive-interval 35  
    passive-mode  
    echo-mode
```

```

echo-interval 35
minimum-ttl 10
!
!
end

```

- 1 The **router bgp** section indicates the ASN for MetalLB.
- 2 Confirm that a **neighbor <ip-address> remote-as <peer-ASN>** line exists for each BGP peer custom resource that you added.
- 3 If you configured BFD, confirm that the BFD profile is associated with the correct BGP peer and that the BFD profile appears in the command output.
- 4 Confirm that the **network <ip-address-range>** lines match the IP address ranges that you specified in address pool custom resources that you added.

3. Display the BGP summary:

```
$ oc exec -n metallb-system speaker-66bth -c frf -- vtysh -c "show bgp summary"
```

Example output

```

IPv4 Unicast Summary:
BGP router identifier 10.0.1.2, local AS number 64500 vrf-id 0
BGP table version 1
RIB entries 1, using 192 bytes of memory
Peers 2, using 29 KiB of memory

Neighbor      V      AS  MsgRcvd  MsgSent  TblVer  InQ  OutQ  Up/Down  State/PfxRcd
PfxSnt
10.0.2.3      4     64500    387     389     0  0  0 00:32:02      0    1 1
10.0.2.4      4     64500     0       0     0  0  0  never    Active      0 2

Total number of neighbors 2

IPv6 Unicast Summary:
BGP router identifier 10.0.1.2, local AS number 64500 vrf-id 0
BGP table version 1
RIB entries 1, using 192 bytes of memory
Peers 2, using 29 KiB of memory

Neighbor      V      AS  MsgRcvd  MsgSent  TblVer  InQ  OutQ  Up/Down  State/PfxRcd
PfxSnt
10.0.2.3      4     64500    387     389     0  0  0 00:32:02 NoNeg
10.0.2.4      4     64500     0       0     0  0  0  never    Active      0

Total number of neighbors 2

```

- 1 Confirm that the output includes a line for each BGP peer custom resource that you added.
- 2 Output that shows **0** messages received and messages sent indicates a BGP peer that does not have a BGP session. Check network connectivity and the BGP configuration of the BGP peer.

the BGP peer.

4. Display the BGP peers that received an address pool:

```
$ oc exec -n metallb-system speaker-66bth -c frr -- vtysh -c "show bgp ipv4 unicast
203.0.113.200/30"
```

Replace **ipv4** with **ipv6** to display the BGP peers that received an IPv6 address pool. Replace **203.0.113.200/30** with an IPv4 or IPv6 IP address range from an address pool.

Example output

```
BGP routing table entry for 203.0.113.200/30
Paths: (1 available, best #1, table default)
Advertised to non peer-group peers:
10.0.2.3 1
Local
0.0.0.0 from 0.0.0.0 (10.0.1.2)
Origin IGP, metric 0, weight 32768, valid, sourced, local, best (First path received)
Last update: Mon Jan 10 19:49:07 2022
```

- 1** Confirm that the output includes an IP address for a BGP peer.

36.11.3. Troubleshooting BFD issues

The Bidirectional Forwarding Detection (BFD) implementation that Red Hat supports uses FRRouting (FRR) in a container in the **speaker** pods. The BFD implementation relies on BFD peers also being configured as BGP peers with an established BGP session. As a cluster administrator, if you need to troubleshoot BFD configuration issues, you need to run commands in the FRR container.

Prerequisites

- You have access to the cluster as a user with the **cluster-admin** role.
- You have installed the OpenShift CLI (**oc**).

Procedure

1. Display the names of the **speaker** pods:

```
$ oc get -n metallb-system pods -l component=speaker
```

Example output

```
NAME          READY STATUS  RESTARTS  AGE
speaker-66bth 4/4   Running  0         26m
speaker-gvfnf 4/4   Running  0         26m
...
```

2. Display the BFD peers:

```
$ oc exec -n metallb-system speaker-66bth -c frr -- vtysh -c "show bfd peers brief"
```

Example output

```

Session count: 2
SessionId LocalAddress      PeerAddress      Status
=====
3909139637 10.0.1.2         10.0.2.3        up <.>

```

<.> Confirm that the **PeerAddress** column includes each BFD peer. If the output does not list a BFD peer IP address that you expected the output to include, troubleshoot BGP connectivity with the peer. If the status field indicates **down**, check for connectivity on the links and equipment between the node and the peer. You can determine the node name for the speaker pod with a command like **oc get pods -n metallb-system speaker-66bth -o jsonpath='{.spec.nodeName}'**.

36.11.4. MetalLB metrics for BGP and BFD

OpenShift Container Platform captures the following metrics for MetalLB that relate to BGP peers and BFD profiles.

Table 36.10. MetalLB BFD metrics

| Name | Description |
|--|---|
| metallb_bfd_control_packet_input | Counts the number of BFD control packets received from each BFD peer. |
| metallb_bfd_control_packet_output | Counts the number of BFD control packets sent to each BFD peer. |
| metallb_bfd_echo_packet_input | Counts the number of BFD echo packets received from each BFD peer. |
| metallb_bfd_echo_packet_output | Counts the number of BFD echo packets sent to each BFD. |
| metallb_bfd_session_down_events | Counts the number of times the BFD session with a peer entered the down state. |
| metallb_bfd_session_up | Indicates the connection state with a BFD peer. 1 indicates the session is up and 0 indicates the session is down . |
| metallb_bfd_session_up_events | Counts the number of times the BFD session with a peer entered the up state. |
| metallb_bfd_zebra_notifications | Counts the number of BFD Zebra notifications for each BFD peer. |

Table 36.11. MetalLB BGP metrics

| Name | Description |
|---|---|
| metallb_bgp_announced_prefixes_total | Counts the number of load balancer IP address prefixes that are advertised to BGP peers. The terms <i>prefix</i> and <i>aggregated route</i> have the same meaning. |
| metallb_bgp_session_up | Indicates the connection state with a BGP peer. 1 indicates the session is up and 0 indicates the session is down . |
| metallb_bgp_updates_total | Counts the number of BGP update messages sent to each BGP peer. |
| metallb_bgp_opens_sent | Counts the number of BGP open messages sent to each BGP peer. |
| metallb_bgp_opens_received | Counts the number of BGP open messages received from each BGP peer. |
| metallb_bgp_notifications_sent | Counts the number of BGP notification messages sent to each BGP peer. |
| metallb_bgp_updates_total_received | Counts the number of BGP update messages received from each BGP peer. |
| metallb_bgp_keepalives_sent | Counts the number of BGP keepalive messages sent to each BGP peer. |
| metallb_bgp_keepalives_received | Counts the number of BGP keepalive messages received from each BGP peer. |
| metallb_bgp_route_refresh_sent | Counts the number of BGP route refresh messages sent to each BGP peer. |
| metallb_bgp_total_sent | Counts the number of total BGP messages sent to each BGP peer. |
| metallb_bgp_total_received | Counts the number of total BGP messages received from each BGP peer. |

Additional resources

- See [Querying metrics](#) for information about using the monitoring dashboard.

36.11.5. About collecting MetalLB data

You can use the **oc adm must-gather** CLI command to collect information about your cluster, your MetalLB configuration, and the MetalLB Operator. The following features and objects are associated with MetalLB and the MetalLB Operator:

- The namespace and child objects that the MetalLB Operator is deployed in
- All MetalLB Operator custom resource definitions (CRDs)

The **oc adm must-gather** CLI command collects the following information from FRRouting (FRR) that Red Hat uses to implement BGP and BFD:

- **/etc/frr/frr.conf**
- **/etc/frr/frr.log**
- **/etc/frr/daemons** configuration file
- **/etc/frr/vtysh.conf**

The log and configuration files in the preceding list are collected from the **frr** container in each **speaker** pod.

In addition to the log and configuration files, the **oc adm must-gather** CLI command collects the output from the following **vtysh** commands:

- **show running-config**
- **show bgp ipv4**
- **show bgp ipv6**
- **show bgp neighbor**
- **show bfd peer**

No additional configuration is required when you run the **oc adm must-gather** CLI command.

Additional resources

- [Gathering data about your cluster](#)

CHAPTER 37. ASSOCIATING SECONDARY INTERFACES METRICS TO NETWORK ATTACHMENTS

37.1. EXTENDING SECONDARY NETWORK METRICS FOR MONITORING

Secondary devices, or interfaces, are used for different purposes. It is important to have a way to classify them to be able to aggregate the metrics for secondary devices with the same classification.

Exposed metrics contain the interface but do not specify where the interface originates. This is workable when there are no additional interfaces. However, if secondary interfaces are added, it can be difficult to use the metrics since it is hard to identify interfaces using only interface names.

When adding secondary interfaces, their names depend on the order in which they are added, and different secondary interfaces might belong to different networks and can be used for different purposes.

With **pod_network_name_info** it is possible to extend the current metrics with additional information that identifies the interface type. In this way, it is possible to aggregate the metrics and to add specific alarms to specific interface types.

The network type is generated using the name of the related **NetworkAttachmentDefinition**, that in turn is used to differentiate different classes of secondary networks. For example, different interfaces belonging to different networks or using different CNIs use different network attachment definition names.

37.1.1. Network Metrics Daemon

The Network Metrics Daemon is a daemon component that collects and publishes network related metrics.

The kubelet is already publishing network related metrics you can observe. These metrics are:

- **container_network_receive_bytes_total**
- **container_network_receive_errors_total**
- **container_network_receive_packets_total**
- **container_network_receive_packets_dropped_total**
- **container_network_transmit_bytes_total**
- **container_network_transmit_errors_total**
- **container_network_transmit_packets_total**
- **container_network_transmit_packets_dropped_total**

The labels in these metrics contain, among others:

- Pod name
- Pod namespace

- Interface name (such as **eth0**)

These metrics work well until new interfaces are added to the pod, for example via [Multus](#), as it is not clear what the interface names refer to.

The interface label refers to the interface name, but it is not clear what that interface is meant for. In case of many different interfaces, it would be impossible to understand what network the metrics you are monitoring refer to.

This is addressed by introducing the new **pod_network_name_info** described in the following section.

37.1.2. Metrics with network name

This daemonset publishes a **pod_network_name_info** gauge metric, with a fixed value of **0**:

```
pod_network_name_info{interface="net0",namespace="namespacename",network_name="nadname
space/firstNAD",pod="podname"} 0
```

The network name label is produced using the annotation added by Multus. It is the concatenation of the namespace the network attachment definition belongs to, plus the name of the network attachment definition.

The new metric alone does not provide much value, but combined with the network related **container_network_*** metrics, it offers better support for monitoring secondary networks.

Using a **promql** query like the following ones, it is possible to get a new metric containing the value and the network name retrieved from the **k8s.v1.cni.cncf.io/network-status** annotation:

```
(container_network_receive_bytes_total) + on(namespace,pod,interface) group_left(network_name) (
pod_network_name_info )
(container_network_receive_errors_total) + on(namespace,pod,interface) group_left(network_name) (
pod_network_name_info )
(container_network_receive_packets_total) + on(namespace,pod,interface)
group_left(network_name) ( pod_network_name_info )
(container_network_receive_packets_dropped_total) + on(namespace,pod,interface)
group_left(network_name) ( pod_network_name_info )
(container_network_transmit_bytes_total) + on(namespace,pod,interface) group_left(network_name)
( pod_network_name_info )
(container_network_transmit_errors_total) + on(namespace,pod,interface) group_left(network_name)
( pod_network_name_info )
(container_network_transmit_packets_total) + on(namespace,pod,interface)
group_left(network_name) ( pod_network_name_info )
(container_network_transmit_packets_dropped_total) + on(namespace,pod,interface)
group_left(network_name)
```